

DESCRIPTION The 2SC1845 is the best for use as the middle range amplifier in Hi-Fi stereo control amplifiers, power amplifiers, and etc.

- FEATURES**
- High Voltage. $V_{CEO} : 120 \text{ V}$
 - Low Output Capacitance. $C_{ob} : 1.6 \text{ pF TYP. } (V_{CB} = 30 \text{ V})$
 - High h_{FE} . $h_{FE} : 600 \text{ TYP. } (V_{CE} = 6.0 \text{ V, } I_C = 1.0 \text{ mA})$
 - Super Low Noise. $NV : 25 \text{ mV TYP. (See test Circuit.)}$

ABSOLUTE MAXIMUM RATINGS

- Maximum Temperatures
- Storage Temperature -55 to +125 °C
 - Junction Temperature +125 °C Maximum
- Maximum Power Dissipation ($T_a = 25 \text{ °C}$)
- Total Power Dissipation 500 mW
- Maximum Voltages and Currents ($T_a = 25 \text{ °C}$)
- V_{CBO} Collector to Base Voltage 120 V
 - V_{CEO} Collector to Emitter Voltage 120 V
 - V_{EBO} Emitter to Base Voltage 5.0 V
 - I_C Collector Current 50 mA
 - I_B Base Current 10 mA

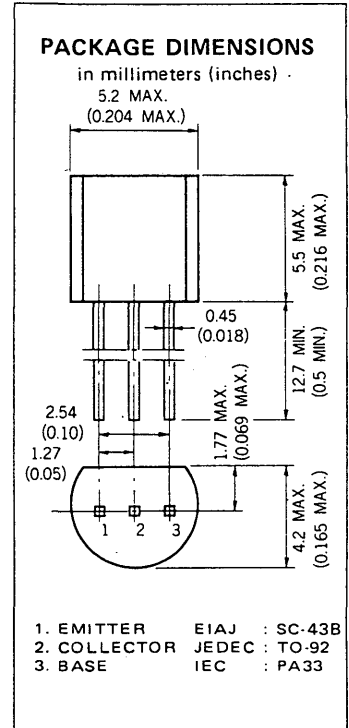

ELECTRICAL CHARACTERISTICS ($T_a = 25 \text{ °C}$)

SYMBOL	CHARACTERISTIC	MIN.	TYP.	MAX.	UNIT	TEST CONDITIONS
h_{FE1}	DC Current Gain	150	580		—	$V_{CE} = 6.0 \text{ V, } I_C = 0.1 \text{ mA}$
h_{FE2}	DC Current Gain	200	600	1200	—	$V_{CE} = 6.0 \text{ V, } I_C = 1.0 \text{ mA}$
f_T	Gain Bandwidth Product	50	110		MHz	$V_{CE} = 6.0 \text{ V, } I_E = -1.0 \text{ mA}$
C_{ob}	Output Capacitance		1.6	2.5	pF	$V_{CB} = 30 \text{ V, } I_E = 0, f = 1.0 \text{ MHz}$
NV	Noise Voltage		25	40	mV	$V_{CE} = 5.0 \text{ V, } I_C = 1.0 \text{ mA, } R_G = 100 \text{ k}\Omega$ $G_v = 80 \text{ dB, } f = 10 \text{ Hz to } 1.0 \text{ kHz}$
I_{CBO}	Collector Cutoff Current			50	nA	$V_{CB} = 120 \text{ V, } I_E = 0$
I_{EBO}	Emitter Cutoff Current			50	nA	$V_{EB} = 5.0 \text{ V, } I_C = 0$
V_{BE}	Base to Emitter Voltage	0.55	0.59	0.65	V	$V_{CE} = 6.0 \text{ V, } I_C = 1.0 \text{ mA}$
$V_{CE(sat)}$	Collector Saturation Voltage		0.07	0.30	V	$I_C = 10 \text{ mA, } I_B = 1.0 \text{ mA}$

Classification of h_{FE2}

Rank	P	F	E	U
Range	200 - 400	300 - 600	400 - 800	600 - 1200

h_{FE} Test Conditions : $V_{CE} = 6.0 \text{ V, } I_C = 1.0 \text{ mA}$

TYPICAL CHARACTERISTICS (Ta = 25 °C unless otherwise noted)

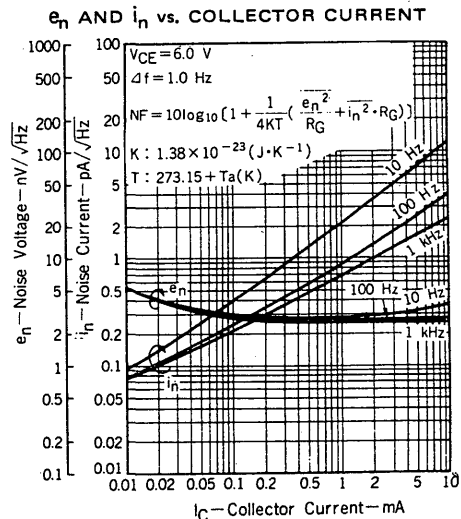
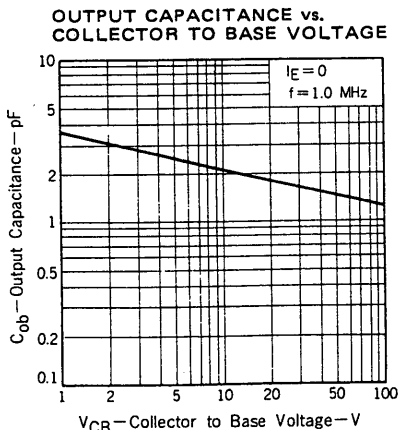
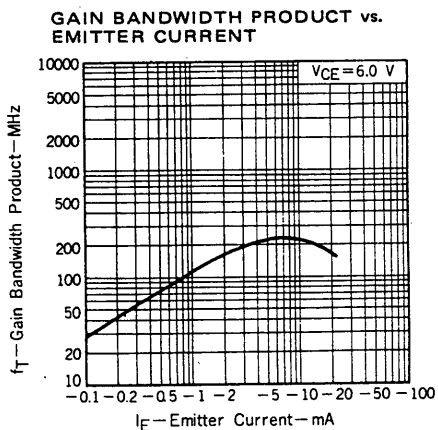
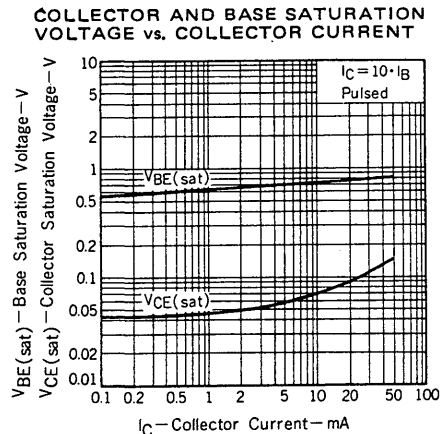
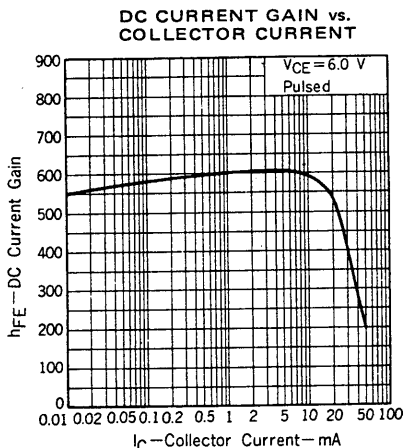
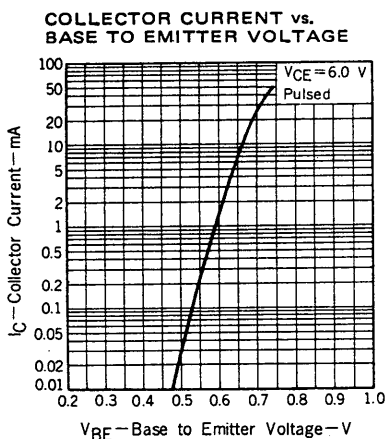
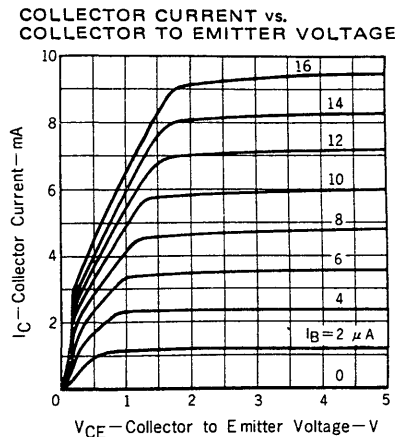
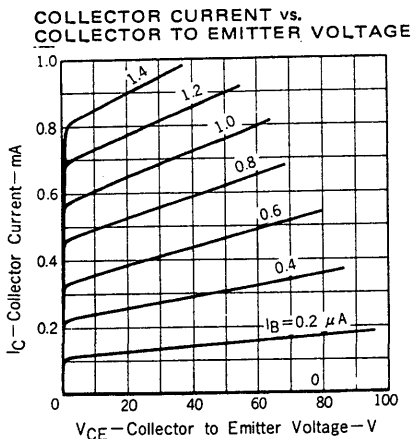
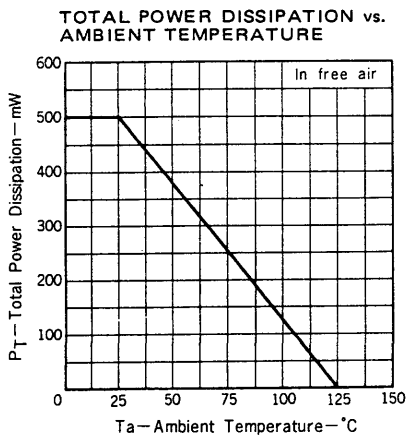

NOISE FIGURE MAP.

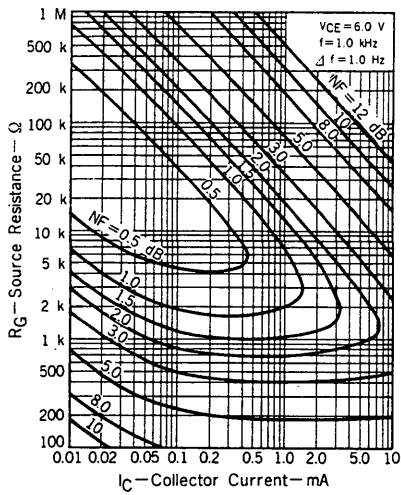

NOISE VOLTAGE TEST CIRCUIT

