

Cisco RNG150 and RNG150N Digital-Only High-Definition Interactive Set-Tops with Multi-Stream CableCARD Interface



Notice to Installers

The servicing instructions in this notice are for use by qualified service personnel only. To reduce the risk of electric shock, do not perform any servicing other than that contained in the operating instructions, unless you are qualified to do so.

Note to System Installer

For this apparatus, the coaxial cable shield/screen shall be grounded as close as practical to the point of entry of the cable into the building. For products sold in the US and Canada, this reminder is provided to call the system installer's attention to Article 820-93 and Article 820-100 of the NEC (or Canadian Electrical Code Part 1), which provides guidelines for proper grounding of the coaxial cable shield.



This symbol is intended to alert you that uninsulated voltage within this product may have sufficient magnitude to cause electric shock. Therefore, it is dangerous to make any kind of contact with any inside part of this product.

Ce symbole a pour but d'alerter toute personne qu'un contact avec une pièce interne de ce produit, sous tension et non isolée, pourrait être suffisant pour provoquer un choc électrique. Il est donc dangereux d'être en contact avec toute pièce interne de ce produit.



CAUTION: To reduce the risk of electric shock, do not remove cover (or back). No user-serviceable parts inside. Refer servicing to qualified service personnel.

WARNING
TO PREVENT FIRE OR ELECTRIC SHOCK, DO NOT EXPOSE THIS UNIT TO RAIN OR MOISTURE.



This symbol is intended to alert you of the presence of important operating and maintenance (servicing) instructions in the literature accompanying this product.

Ce symbole a pour but de vous avertir qu'une documentation importante sur le fonctionnement et l'entretien accompagne ce produit.

20080814_Installer820

Contents

IMPORTANT SAFETY INSTRUCTIONS.....	iv
Welcome.....	1
Safety First	1
Record Product Serial Numbers.....	1
What's in the Carton?	2
Additional Equipment You Might Need	2
Front Panel Features.....	3
Back Panel Connectors	4
Connecting the Set-Top	5
Connections for an HDTV and VCR.....	6
Connections for a Standard-Definition TV and VCR	7
View Television Programming	8
Troubleshooting.....	9
Frequently Asked Questions.....	10
Picture Formats	11
Connecting to an HDTV with an HDMI Connector	12
Connecting to an HDTV with a DVI Connector.....	13
Connecting to an HDTV with Component Input (YPbPr).....	14
Connecting to a Home Theater System with Component Input (YPbPr).....	15
Connecting to a Stereo VCR and HDTV (optional)	16
Connecting to an HDTV with a 1394 Connector.....	17
Connecting the Set-Top in HD Mode to an SDTV with Component Input (YPbPr)	17
Index.....	18
Compliance Information.....	20

IMPORTANT SAFETY INSTRUCTIONS

- 1) Read these instructions.
- 2) Keep these instructions.
- 3) Heed all warnings.
- 4) Follow all instructions.
- 5) Do not use this apparatus near water.
- 6) Clean only with dry cloth.
- 7) Do not block any ventilation openings. Install in accordance with the manufacturer's instructions.
- 8) Do not install near any heat sources such as radiators, heat registers, stoves, or other apparatus (including amplifiers) that produce heat.
- 9) Do not defeat the safety purpose of the polarized or grounding-type plug. A polarized plug has two blades with one wider than the other. A grounding-type plug has two blades and a third grounding prong. The wide blade or the third prong are provided for your safety. If the provided plug does not fit into your outlet, consult an electrician for replacement of the obsolete outlet.
- 10) Protect the power cord from being walked on or pinched particularly at plugs, convenience receptacles, and the point where they exit from the apparatus.
- 11) Only use attachments/accessories specified by the manufacturer.
- 12)  Use only with the cart, stand, tripod, bracket, or table specified by the manufacturer, or sold with the apparatus. When a cart is used, use caution when moving the cart/apparatus combination to avoid injury from tip-over.
- 13) Unplug this apparatus during lightning storms or when unused for long periods of time.
- 14) Refer all servicing to qualified service personnel. Servicing is required when the apparatus has been damaged in any way, such as a power-supply cord or plug is damaged, liquid has been spilled or objects have fallen into the apparatus, the apparatus has been exposed to rain or moisture, does not operate normally, or has been dropped.

Power Source Warning

A label on this product indicates the correct power source for this product. Operate this product only from an electrical outlet with the voltage and frequency indicated on the product label. If you are uncertain of the type of power supply to your home or business, consult your service provider or your local power company.

The AC inlet on the unit must remain accessible and operable at all times.

Ground the Product



WARNING: Avoid electric shock and fire hazard! If this product connects to coaxial cable wiring, be sure the cable system is grounded (earthed). Grounding provides some protection against voltage surges and built-up static charges.

Outdoor Grounding System

If this product connects to an outdoor antenna or cable system, be sure the antenna or cable system is grounded (earthed). This provides some protection against voltage surges and built-up static charges.

Article 810 of the National Electric Code (NEC) ANSI/NFPA No. 70-1990, provides the following information:

- Grounding of the mast and supporting structure
- Grounding the lead-in wire to an antenna discharge unit
- Size of the grounding conductors
- Location of the antenna-discharge unit
- Connection to grounding electrodes
- Requirements for the grounding electrodes (see the following antenna grounding diagram as recommended by NEC ANSI/NFPA 70)



WARNING: Avoid electric shock and fire hazard! Do not locate an outside antenna system in the vicinity of overhead power lines or power circuits. Touching power lines or circuits might be fatal.

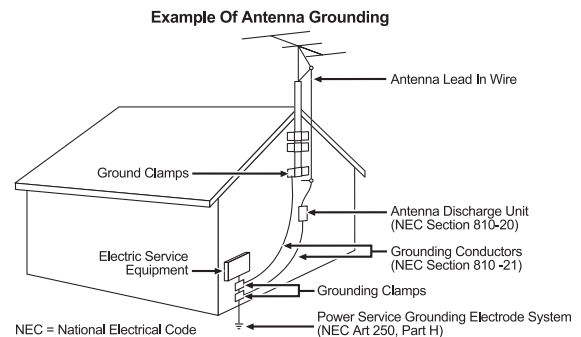

T11518

Protect the Product from Lightning

In addition to disconnecting the AC power from the wall outlet, disconnect the signal inputs.

IMPORTANT SAFETY INSTRUCTIONS, continued

Verify the Power Source from the On/Off Power Light

When the on/off power light is not illuminated, the apparatus may still be connected to the power source. The light may go out when the apparatus is turned off, regardless of whether it is still plugged into an AC power source.

Eliminate AC Mains Overloads



WARNING: Avoid electric shock and fire hazard! Do not overload AC mains, outlets, extension cords, or integral convenience receptacles. For products that require battery power or other power sources to operate them, refer to the operating instructions for those products.

Handling Disposable Batteries

This product may contain disposable batteries. Heed the following warning and follow the Battery Safety and Battery Disposal instructions below.



WARNING: There is danger of explosion if the battery is mishandled or incorrectly replaced. Replace only with the same type of battery. Do not disassemble it or attempt to recharge it outside the system. Do not crush, puncture, dispose of in fire, short the external contacts, or expose to water or other liquids. Dispose of the battery in accordance with local regulations and instructions from your service provider.

Battery Safety

- Insert batteries correctly. There may be a risk of explosion if the batteries are incorrectly inserted.
- Do not attempt to recharge 'disposable' or 'non-reusable' batteries.
- Please follow instructions provided for charging 'rechargeable' batteries.
- Replace batteries with the same or equivalent type that we recommend.
- Do not expose batteries to temperatures above 100°C (212°F).

Battery Disposal

- The batteries may contain substances that could be harmful to the environment.
- Recycle or dispose of batteries in accordance with the battery manufacturer's instructions and local/national disposal and recycling regulations.



廢電池請回收

- The batteries may contain perchlorate, a known hazardous substance, so special handling and disposal of this product might be necessary. For more information about perchlorate and best management practices for perchlorate-containing substance, see www.dtsc.ca.gov/hazardouswaste/perchlorate

Provide Ventilation and Select a Location

- Remove all packaging material before applying power to the product.
- Do not place this apparatus on a bed, sofa, rug, or similar surface.
- Do not place this apparatus on an unstable surface.
- Do not install this apparatus in an enclosure, such as a bookcase or rack, unless the installation provides proper ventilation.
- Do not place entertainment devices (such as VCRs or DVDs), lamps, books, vases with liquids, or other objects on top of this product.
- Do not block ventilation openings.

Protect from Exposure to Moisture and Foreign Objects



WARNING: Avoid electric shock and fire hazard! Do not expose this product to dripping or splashing liquids, rain, or moisture. Objects filled with liquids, such as vases, should not be placed on this apparatus.



WARNING: Avoid electric shock and fire hazard! Unplug this product before cleaning. Do not use a liquid cleaner or an aerosol cleaner. Do not use a magnetic/static cleaning device (dust remover) to clean this product.



WARNING: Avoid electric shock and fire hazard! Never push objects through the openings in this product. Foreign objects can cause electrical shorts that can result in electric shock or fire.

Service Warnings



WARNING: Avoid electric shock! Do not open the cover of this product. Opening or removing the cover may expose you to dangerous voltages. If you open the cover, your warranty will be void. This product contains no user-serviceable parts.

Check Product Safety

Upon completion of any service or repairs to this product, the service technician must perform safety checks to determine that this product is in proper operating condition.

Protect the Product When Moving It

Always disconnect the power source when moving the apparatus or connecting or disconnecting cables.

20090915_Cable_Safety

Welcome

The Cisco® RNG150 and RNG150N Digital-Only High-Definition Interactive Set-Tops with Multi-Stream CableCARD™ (M-Card™) provide high-definition (HD) capability and broadband digital video services.

Follow the instructions in this guide to install the set-top, to become familiar with the buttons on the front panel, and to access your cable services. Then, enjoy the features of the set-top and change the way you watch TV.

Important: If the M-Card is removed, the set-top will not operate correctly.

The consumer support website provides news and information about this product. For more information, please refer to <http://www.cisco.com/web/consumer/support/index.html>.

Safety First

Before using the set-top, read the **Important Safety Instructions** section of this guide.

Record Product Serial Numbers

If the set-top requires troubleshooting in the future, your service provider may ask for the serial numbers of the set-top and M-Card module.

The set-top serial number label is on the back panel above the video and audio connectors; the serial number begins with “STB SN” and is located in the upper left corner of the bar code.

The M-Card serial number label is on the M-Card module slot cover; the serial number begins with “M-CARD SN” and is located in the upper left corner of the bar code.

Use this space to record the set-top serial number: _____

Use this space to record the M-Card module serial number: _____

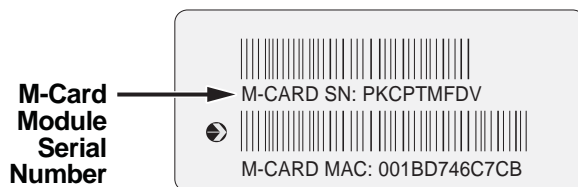

T13768

What's In The Carton?

The set-top carton contains the following items:



- RNG150 or RNG150N with M-Card



- Quick Reference Guide



- Power Cord

Additional Equipment You Might Need

You might need some of the cables and adapters shown below for connecting the set-top to your home entertainment devices. See the connection information in the **Connection Diagrams** section for more information.

Check with your service provider for information about acquiring cables or adapters, or you can purchase cables or adapters at your local electronics supplier.



Audio Left/
Right Cable



Component Video
Cables (YPbPr)



HDMI
Adapter



S-Video
Cable



Composite
A/V Cables



RGB
Adapter



HDMI
Cable



RGB Adapter
Cable
(RCA to RCA)



Optical
Digital
Audio
Cable



HDMI-to-DVI
Cable



RGB Adapter
Cable
(RCA to BNC)



IEEE
1394
4-Pin
to 4-Pin
Cable



RF Coaxial
Cable



RGB Adapter
Cable
(RCA to VGA)



Coaxial Digital
Audio Cable



IR Extender
Cable

Front Panel Features

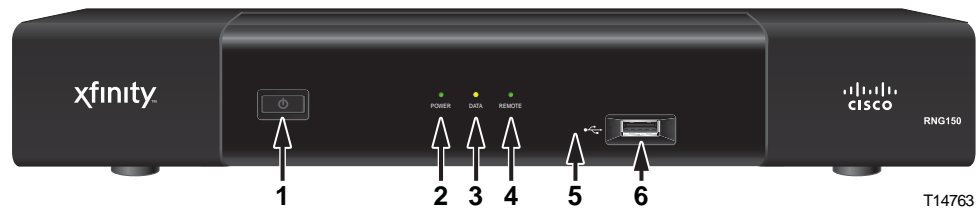

- | | |
|-----------------------|--|
| 1 Power Button | Applies power to the set-top |
| 2 Power LED | Illuminates when the set-top is powered on. The LED is green |
| 3 Data LED | Illuminates when the set-top is receiving data. The LED is yellow |
| 4 Remote LED | Illuminates when the remote control is in use. The LED is green |
| 5 IR Sensor | Receives the infrared signal from the remote control |
| 6 USB 2.0 Port | Connects to external equipment, such as a keyboard or a mouse, software controlled |

Note: This illustration may vary from the actual product.

Back Panel Connectors

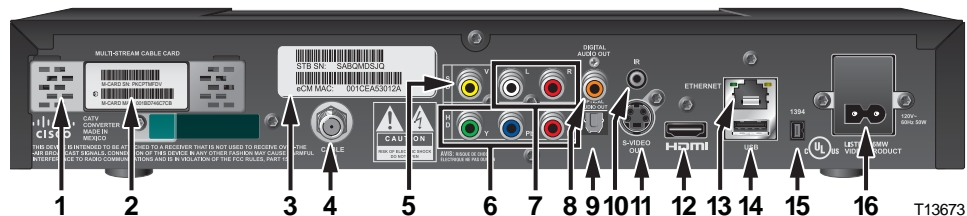

- | | |
|--|---|
| 1 Multi-Stream CableCARD | Installed by your service provider |
| 2 M-Card Label | Contains M-Card serial number and MAC address |
| 3 Bar Code Label | Contains set-top serial number and MAC address |
| 4 Cable In | Connects to a coaxial cable that delivers the signal from your service provider |
| 5 Video Out | Connects to the composite input on your TV |
| 6 HDTV Component Output (YPbPr) | Connects to the YPbPr inputs on an HDTV. Do not use these connectors if you are using the HDMI connection |
| 7 Primary Stereo RCA Output | Connects to the RCA left/right audio input on an SDTV |
| 8 Digital Audio Out | Connects to the digital audio input of a surround sound receiver or other digital audio device |
| 9 Optical Audio Out | Connects to an optical cable that sends a digital audio signal to a surround-sound receiver or other digital audio device |
| 10 IR | Available to be connected to an approved remote IR receiver (or to IR Blaster purchased separately). Please contact your service provider for details |
| 11 S-Video Out | Connects to S-Video input of a standard TV or VCR |
| 12 HDMI | Connects an HDMI™ cable to the HDMI input of an HDTV. HDMI supports both digital audio and video. May be used to connect to a DVI interface using an HDMI-to-DVI adapter for video and separate audio connections. Any of the following audio connections may be used: Primary Stereo RCA Output (7); Digital Audio Out (8); or Optical Audio Out (9) |
| 13 Ethernet | Connects to an Ethernet network |
| 14 USB | Connects to external USB devices such as a keyboard or mouse |
| 15 1394 | Connects to display devices equipped with a 1394 input |
| 16 AC Power Input | Connects to the power cord to deliver power to the set-top (50W max) |

Note: This illustration may vary from the actual product.

Connecting the Set-top

To connect your set-top to your entertainment devices, complete these steps.



Determine if your TV is HD or SD and whether it is wide screen (16:9) or standard screen (4:3). See page 11 for more information.



or

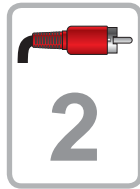

Make the connections for your TV and VCR as follows:

- If you are using an HDTV, **see page 6** and the connection diagrams at the end of this guide.
- If you are using an SDTV, **see page 7** and the connection diagrams at the end of this guide.
- If you want to archive some programs to VCR tape, **see pages 6 and 7** and the connection diagrams at the end of this guide.



Identify the additional devices you will connect to the set-top and TV. **See the Connection Diagrams section** of this guide.

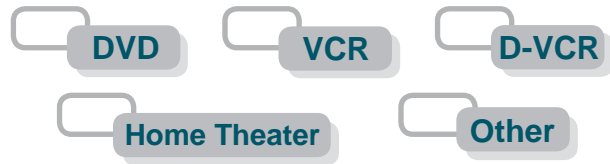

Plug the set-top and the TV into an AC power source that is not controlled by a switch.



Do not turn on the set-top or TV yet.



Wait until the POWER LED on the front panel of the set-top stops blinking to indicate that the update is complete.

Note: If the POWER LED blinks eight times, pauses then repeats, your set-top is not authorized. Call your service provider.





















To begin watching TV, turn the TV on, and press POWER on the front panel of the set-top or on the remote control.

Connections for an HDTV and VCR

To use the set-top with an HDTV, you must make *one* of the following connections to view the HD content. In addition, you can make connections to a digital or analog VCR to record to a VCR tape. Refer to your TV and VCR user guides and the cabling diagrams in this guide for more detailed connection information.





Note: The labeling on your set-top, HDTV, and VCR may vary slightly.

Required Connections to an HDTV (use one)		Set-Top Connections	HDTV Connections
HDMI	Some HDTVs have a High-Definition Multimedia Interface (HDMI) connector. The HDMI connector provides both a digital video and audio connection. See the connection diagram on page 12 for an example.		
DVI	The HDMI connector can provide the connection to an HDTV with a DVI input. If your HDTV has a Digital Visual Interface (DVI) connector, you will need an HDMI-to-DVI adapter, and you will need to connect a separate audio connection. See the connection diagram on page 13 for an example.	Adapter Needed  OUT 1  L  R	 L  R
YPbPr	The YPbPr connectors can provide high-definition component video signals to an HDTV. Note: Use the HD Setup Wizard on the set-top to set the HD mode and select the output video format that will matches the full capabilities of your HDTV. See the connection diagram on page 14 for an example.	Pr Pb Y OUT 1  L  R	Y Pb Pr  L  R
RGB	Some HDTVs have only RGB connectors. If you have one of these HDTVs, you need an RGB adapter. Check with your service provider for information about acquiring an RGB adapter, or you can purchase the adapter at your local electronics supplier.	Adapter Needed Pr Pb Y OUT 1  L  R	R G B H V  L  R
1394	Some HDTVs have 1394 connectors. If you connect to your HDTV using 1394, you also need to connect separate video and audio connections to your HDTV. See the connection diagram on page 17 for an example.	Pr Pb Y 1394 OUT 1  L  R	Pr Pb Y 1394  L  R
Optional Connections to a VCR (use one)		Set-Top Connections	VCR Connections
VCR	For VCRs with Video and Left and Right audio connectors, you can use the Out 2 connectors (Video, Left, and Right) on the set-top. See the connection diagram on page 16 for an example.	OUT 2 AUDIO L R VIDEO	VIDEO IN L R AUDIO IN
	For VCRs with S-Video and Left and Right audio connectors, you can use the S-Video Out and the Out 2 Left and Right connectors on the set-top.	S-VIDEO OUT OUT 2 L R	S-VIDEO IN L R
	For <i>Digital VCRs</i> , you can use the 1394 out connector on the set-top.	1394	1394

Connections for a Standard-Definition TV and VCR

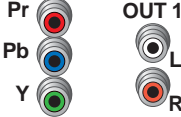
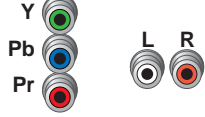
When using the set-top with an SDTV, you must make *one* of the following connections to view content. Some SDTVs may not have all these connections. In addition, you can make connections to a VCR to record to a VCR tape. Refer to your TV and VCR user guides and the cabling diagrams in this guide for more detailed information.

Note: The labeling on your set-top, SDTV, and VCR may vary slightly.

Required Connections to an SDTV (use one)		Set-Top Connections	SDTV Connections
YPbPr	The YPbPr connectors can provide standard-definition component video signals to an SDTV. Note: To connect YPbPr to an SDTV, you must set the HD Setup Wizard on the set-top to HD Mode , and select the output video format (typically 480i) that will match the capabilities of your SDTV.		
S-Video	The S-Video Out connection provides an optimal video connection to SDTVs.		
Optional Connection to a VCR		Set-Top Connections	VCR Connections
VCR	For VCRs with Video and Left and Right audio connectors, you can use the Out 2 connectors (Video, Left, and Right) on the set-top.		

View Television Programming

Access Services and Programs

Access cable services and programs by pressing the following keys on the remote control:

- **Guide**—Access the on-screen guide. The on-screen guide displays schedules of TV programs and other services available from your cable service provider, such as video-on-demand and pay-per-view programs.
- **Arrows**—Select a program in the schedule.
- **Info**—Display a specific program description (either from the on-screen guide or while viewing a program).
- **Select**—View a specific program in the guide.

Stretch and Zoom Program

You can stretch and zoom SD or HD programs by pressing the **HD Zoom** key on the remote control.

Avoid Screen Burn-In

Images such as letterbox bars or side bars, bright closed-captioning backgrounds, station logos, or any other stationary images may cause the picture tube in your HDTV to age unevenly; this is known as screen burn-in. Refer to the user's guide that came with your HDTV for more information.



WARNING: Avoid screen burn-in. Do not display the same fixed images on your HDTV screen for extended periods of time.

Troubleshooting

If the set-top does not perform as expected, the following tips may help. If you need further assistance, contact your service provider.

No Picture

- Verify that the M-Card module is installed.
- Verify that the power to your TV is turned on.
- Verify that your HDTV is in HD mode. If necessary, run the HD Setup Wizard to select HD mode.
- If the set-top is plugged into a wall switch, verify that the switch is in the ON position.
Note: You should avoid plugging the set-top into an outlet controlled by a wall switch.
- Verify that all cables are properly connected.
- If your system includes a VCR or stereo, verify that you have properly connected them to the set-top.
- Verify that the set-top is set to the proper screen type and resolution.

No Color

- Verify that the current TV program is broadcast in color.
- Adjust the TV color controls.
- If you are using a component video connection (YPbPr), check that all connectors are completely plugged into the set-top and TV.

No Sound

- If your setup includes a VCR or stereo, verify that you have properly connected them to the set-top.
- Verify that the volume is turned up.
- Verify that the mute function is not on.

Automatic Software Updates

A message appears on the TV screen when the set-top and the M-Card module are receiving software updates.

Frequently Asked Questions

What is Digital Television?

Digital television (DTV) is a huge leap forward in television technology compared to analog television that has been widely available since the 1940s. DTV is delivered and displayed using digital encoding, similar to the way a PC operates. By using digital technology, there is no variation in picture and sound quality from the origination point until it is displayed on your television. You always receive a high-quality picture without the wavy lines or static you might sometimes get from a weak analog signal.

Because DTV receives and displays digital images that contain many times more picture elements (pixels - the small dots that make up the color image on your screen) than standard analog television, you can get a sharper on-screen image than with analog. Additionally, DTV supports CD-quality sound. DTV includes SDTV (Standard-Definition Television), EDTV (Enhanced-Definition Television), and HDTV (High-Definition Television). That means that all HDTV is digital, but not all digital TV is high-definition. A high-definition program must originate in HD format and be broadcast in HD format. Having an HDTV system does not mean that everything you watch will be in high-definition. Getting the signal from digital cable also does not mean it is high-definition.

What is Standard-Definition Television?

Standard-definition television (SDTV) is basic digital television programming delivered by cable. Typically, the SDTV screen is the same, nearly square shape as an analog television screen. Digital images on an SDTV set are crisp and clear—noticeably better than on a standard analog television set using an antenna to receive over-the-air signals.

What is High-Definition Television?

High-definition television (HDTV) is a completely new way to send and receive television broadcast signals. HDTV images are made up of pixels that are much smaller and closer together than those used in standard analog television, and there are millions of them. Thus, HDTV can display five to six times the detail of analog television to deliver picture quality that is much more realistic, dimensional, and precise. SDTV programs can be viewed on an HDTV. Another feature of HDTV is digital surround sound using Dolby™ Digital technology, which is the same technology used to produce the sound you hear in movie theaters.

Are Local TV Stations Broadcasting in HDTV?

Many local TV stations are transmitting digital signals. However, transmitting a digital signal does not mean transmitting an HDTV signal. Some stations are using the new bandwidth to broadcast several standard-definition channels. Most stations, once they begin broadcasting in digital, are offering HD content from their parent network (for example, CBS, ABC, NBC, Fox, and PBS).

Where Are the Connection Diagrams?

The diagrams at the end of this guide show examples of common ways to connect the set-top to your HDTV, DVD, and home theater receiver. However, these diagrams do not show every possible combination of devices. Refer to the user's guides that came with your other electronic devices for further information.

What Cables Do I Need?

Some of the cables and adaptors shown in the diagrams may not be included with the set-top. Some of the required cables are shown in the connection diagrams and on page 2 of this guide.

Picture Formats

What is the Difference Between a Standard-Screen and a Wide-Screen HDTV

The type of screen your HDTV has (wide screen or standard screen) determines how the set-top displays programs on the screen. The picture format for an HDTV is a combination of *aspect ratio* and *screen resolution* and is different for standard-screen and wide-screen HDTVs.

What is Aspect Ratio?

An aspect ratio is the ratio of the width to the height of the TV screen. The aspect ratios differ because the television industry manufactures both standard-screen and wide-screen HDTVs to appeal to consumer viewing preferences.

What is the Screen Resolution and Scan Rate?

The screen resolution indicates the amount of detail that the picture displays. Resolution is identified by the number of display lines on the screen. The techniques that an HDTV uses to “paint” the picture on the screen are referred to as progressive and interlaced.



With the **progressive method**, the lines are drawn on the screen one at a time in sequential order. The **interlaced method** involves refreshing pixels in alternation — first the odd lines and then the even lines.

For advance setup, select the scan modes that your TV can support. Refer to your set-top and HDTV user’s guides to choose the proper scan rates (480i, 480p, 720p, 1080i) for your setup.

For example, a resolution of 1080i indicates that the screen shows 1080 lines in an interlaced display, and 480p indicates that the screens shows 480 lines in a progressive display.

Notes:

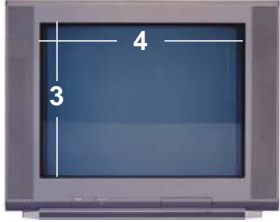
- The screen resolution (1080i, 480p, and so forth) is sometimes referred to as the scan rate. The terms are interchangeable.
- You can stretch and zoom the displayed picture using the built-in capability of the set-top by pressing the # key on the remote control.

<p>A standard-screen HDTV has a 4x3 aspect ratio. The screen is 4 units wide for every 3 units tall.</p>  <p>A screen resolution of 480p or 480i fills the screen.</p>	<p>A wide-screen HDTV is one-third wider than a standard-screen HDTV. The screen is 16 units wide for every 9 units tall.</p>  <p>A screen resolution of 720p or 1080i fills the screen.</p>
--	---

Connecting to an HDTV with an HDMI Connector



WARNING: Electric shock hazard! Unplug all electronic devices before connecting or disconnecting any device cables to the set-top.

Required cables:

- 1 HDMI cable

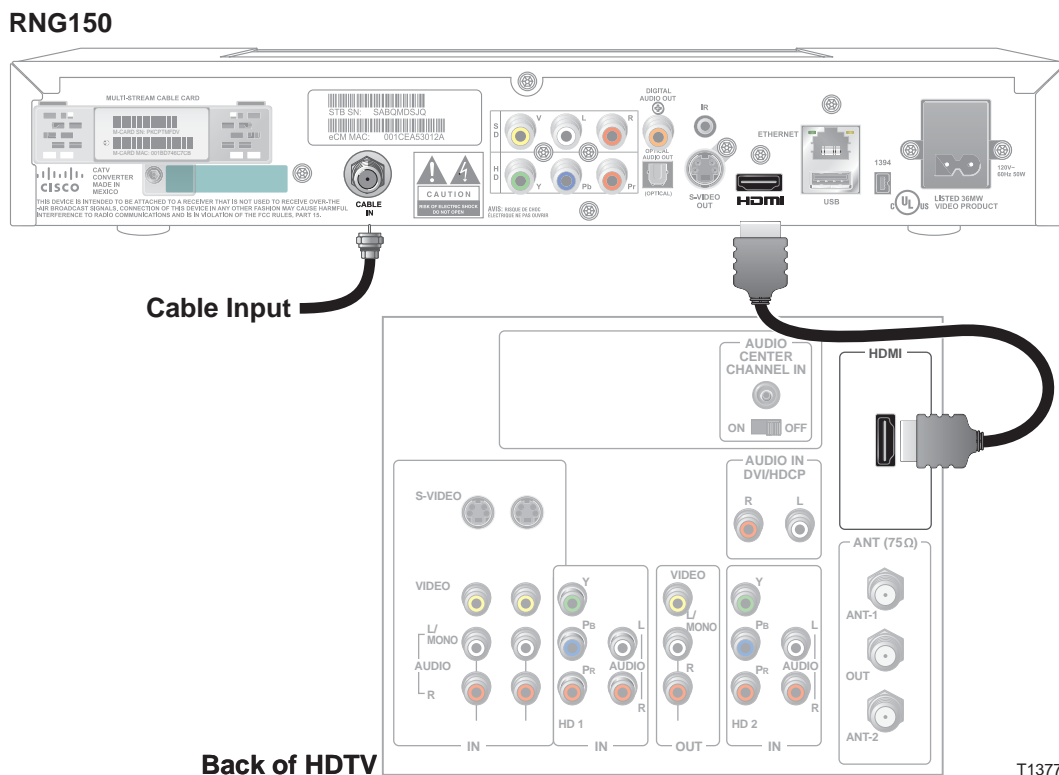

Important Notes Regarding the HDMI Interface on the Set-Top

The HDMI interface automatically configures the audio output for a format supported by the television. Because not all TVs support the Dolby Digital input, the HDMI interface may automatically select a 2-channel stereo audio configuration instead of Dolby Digital, which it carries over to the other digital audio outputs of the set-top. This prevents your home theater system or Dolby Digital decoder from providing the full Dolby Digital surround-sound effect.

You can override this configuration by completing the following steps.

1. Press **SETTINGS** twice on the remote control to open the General Settings menu.
2. Press **MOVE UP** or **MOVE DOWN** to select the option Audio: Digital Out.
3. Press **MOVE RIGHT** to select Dolby Digital. This setting will send Dolby Digital audio to the HDMI, DIGITAL AUDIO OUT, and OPTICAL AUDIO OUT connectors on the set-top.

Notes:

- If the TV is not Dolby Digital capable, it may not produce audio through its speakers when the Audio: Digital Out setting on the set-top is set to Dolby Digital. You can either switch the Audio: Digital Out setting back to HDMI when you are not using the home theater or Dolby Digital decoder, or you can connect the baseband audio outputs (OUT 1 Audio Left and Right) to the TV.
- Digital content is encrypted with High-Bandwidth Content Protection (HDCP) on the DVI/HDMI port. This set-top is not compatible with devices that do not support HDCP. You must use either the YPbPr or 1394 connection to connect the set-top to these devices.

Connecting to an HDTV with a DVI Connector



WARNING: Electric shock hazard! Unplug all electronic devices before connecting or disconnecting any device cables to the set-top.

Required cables:

- 1 HDMI-to-DVI or 1 HDMI cable and 1 DVI adapter
- 1 audio Left/Right cable

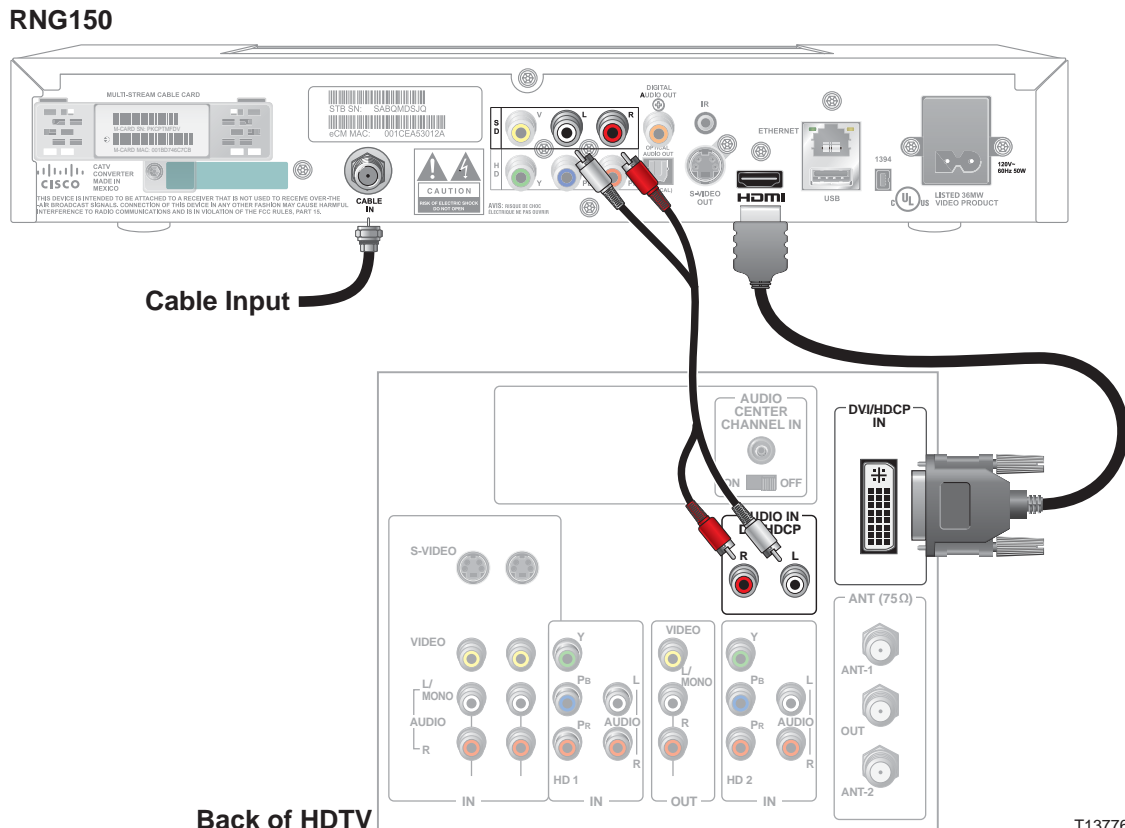

T13776

Notes:

- When you connect the HDMI connector to the DVI connector on your HDTV, you need an HDMI-to-DVI adaptor and a separate audio connection.
- Digital content is encrypted with High-Bandwidth Content Protection (HDCP) on the DVI/HDMI port. This set-top is not compatible with devices that do not support HDCP. You must use either the YPbPr or 1394 connection (which uses Digital Transmission Content Protection, or DTCP) to connect the set-top to these devices.
- Also refer to the **Important Notes Regarding the HDMI Interface on the Set-top** on page 12.

Connecting to an HDTV with Component Input (YPbPr)



WARNING: Electric shock hazard! Unplug all electronic devices before connecting or disconnecting any device cables to the set-top.

Required cables:

- 1 component video cable (YPbPr)
- 1 audio Left/Right cable

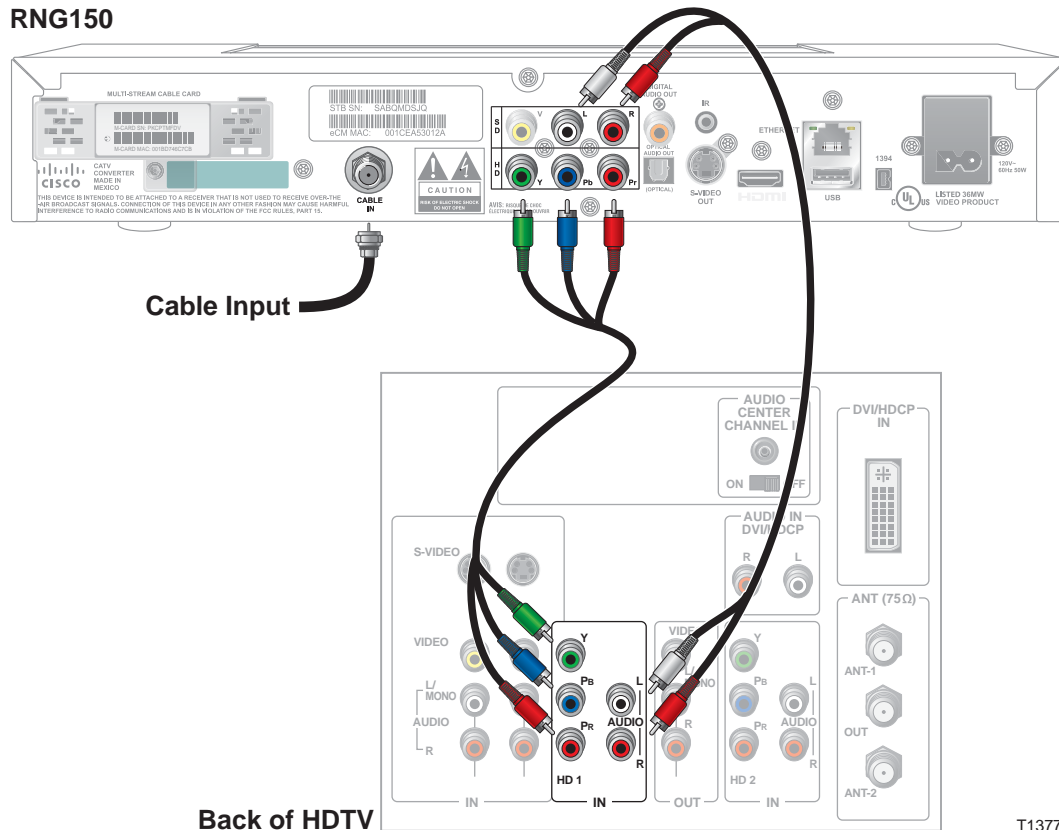

T13777

Connecting to a Home Theater System with Component Input (YPbPr)



WARNING: Electric shock hazard! Unplug all electronic devices before connecting or disconnecting any device cables to the set-top.

Required cables:

- 3 component video cables (YPbPr)
- 1 audio Left/Right cable
- 2 coaxial digital audio cables

RNG150

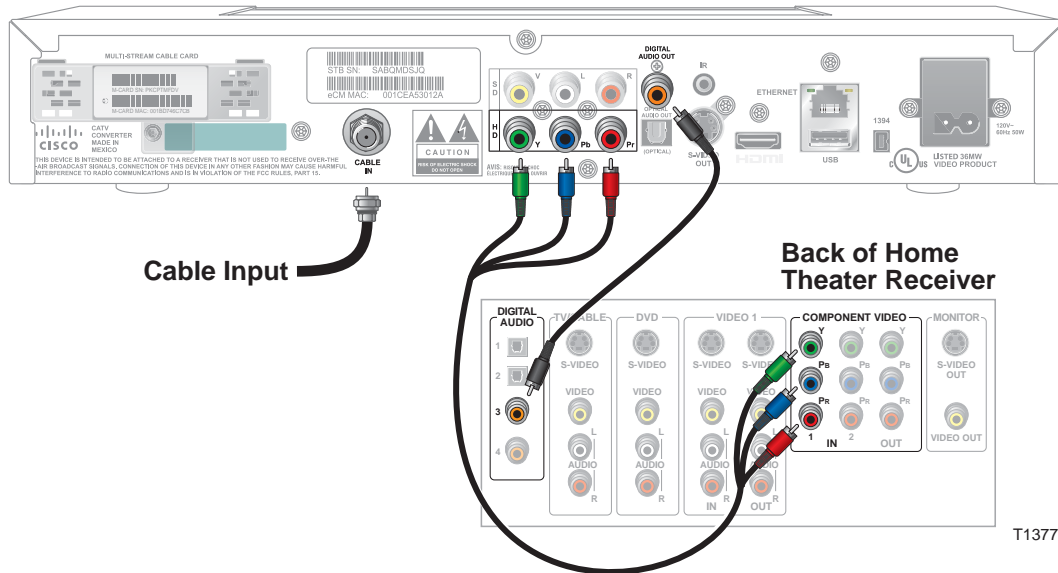

T13778

Back of Home Theater Receiver

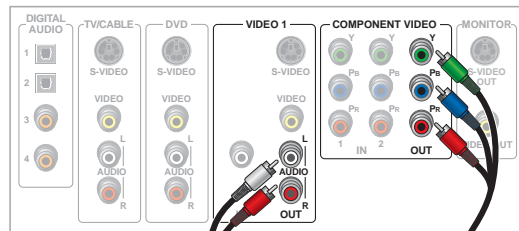

Back of Home Theater Receiver

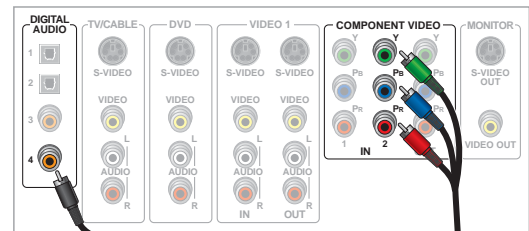

Back of HDTV

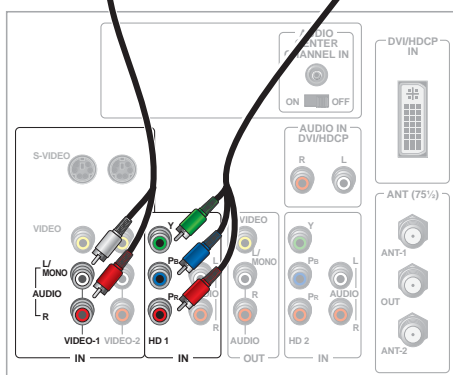

T11136

Back of DVD Player

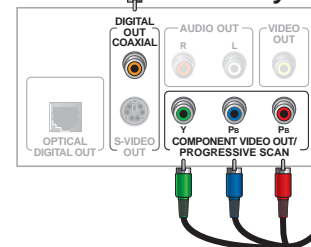

T11135

Note: This connection assumes that audio is provided by the home theater speakers.

Connecting to a Stereo VCR and HDTV (optional)



WARNING: Electric shock hazard! Unplug all electronic devices before connecting or disconnecting any device cables to the set-top.

Required cables:

- 1 RF coaxial cable
- 2 composite A/V cables

RNG150

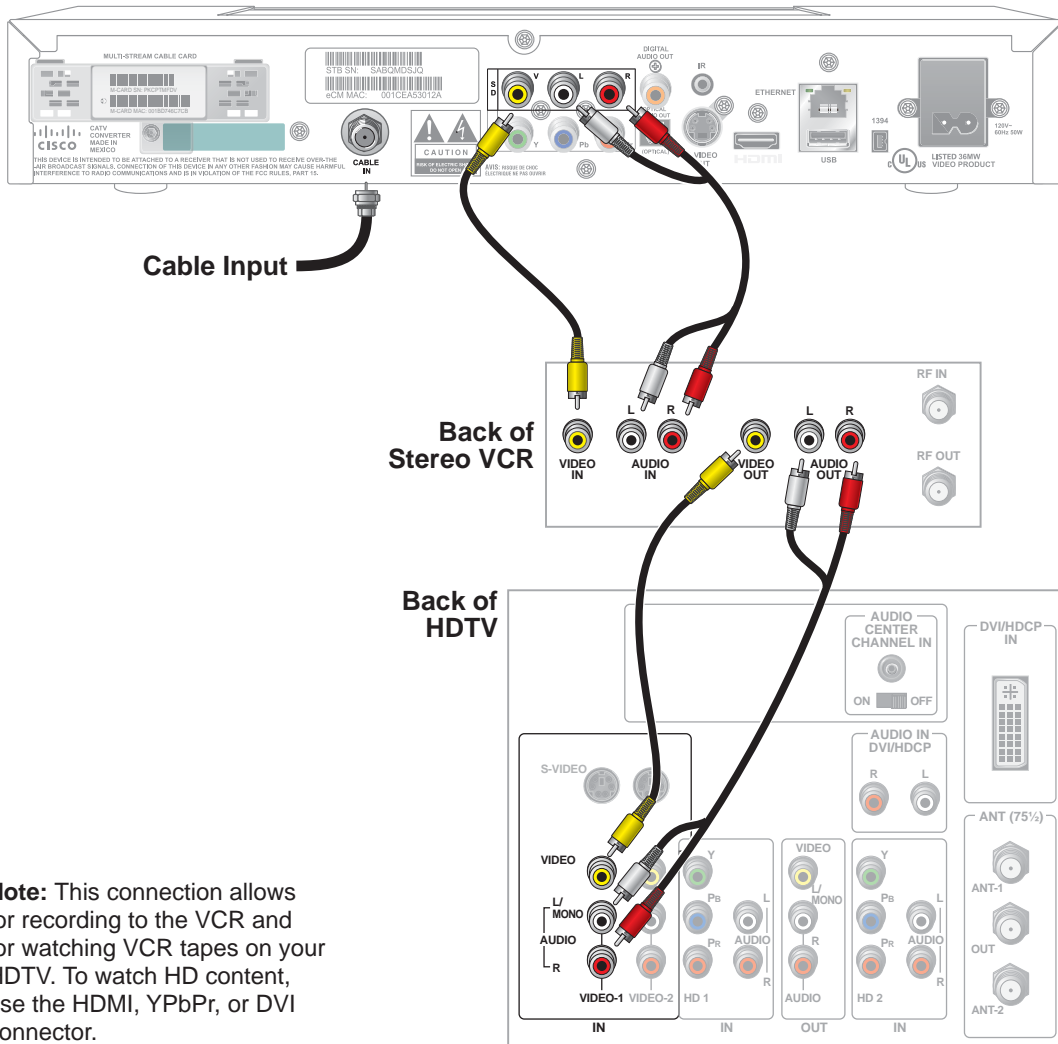

T13779

Connecting to an HDTV with a 1394 Connector

⚡ WARNING: Electric shock hazard! Unplug all electronic devices before connecting or disconnecting any device cables to the set-top.

Required cables:

- 1 4-pin to 4-pin 1394 cable (Consult your TV user guide)
- 1 audio Left/Right cable
- 1 composite A/V cable

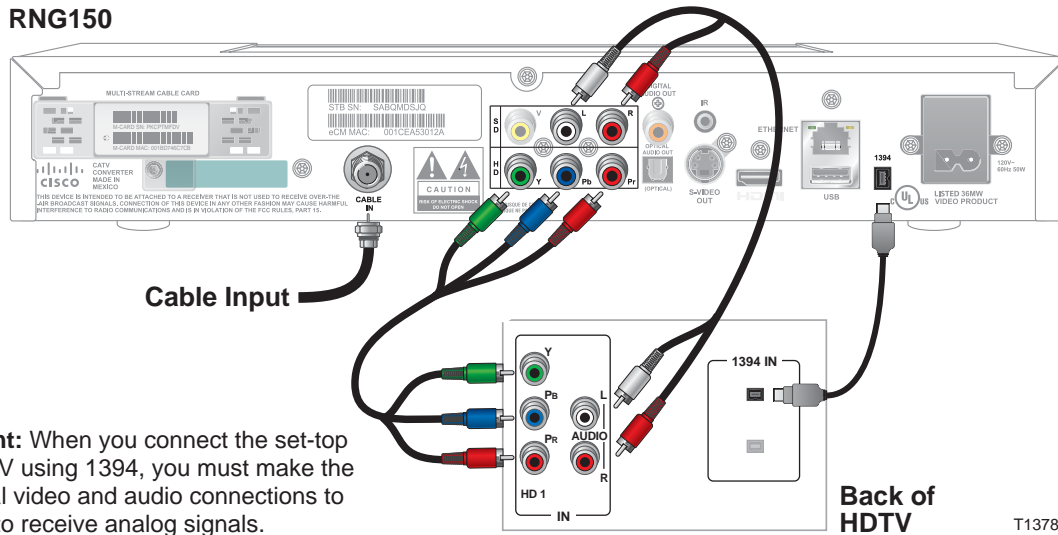

Important: When you connect the set-top to your TV using 1394, you must make the additional video and audio connections to your TV to receive analog signals.

Connecting the Set-Top in HD Mode to an SDTV with Component Input (YPbPr)

⚡ WARNING: Electric shock hazard! Unplug all electronic devices before connecting or disconnecting any device cables to the set-top.

Required cables:

- 1 component video cable with 3 connectors (YPbPr)
- 1 audio Left/Right cable

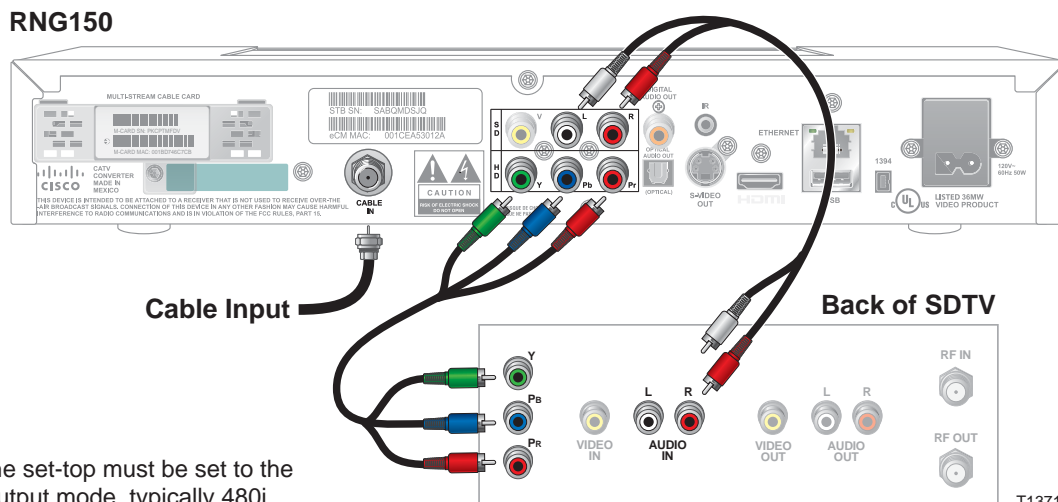

Note: The set-top must be set to the proper output mode, typically 480i.

Index

1394 4, 6, 17

A

AC Power input 4

Aspect ratio 11

B

Back panel 4

Burn-in of screen 8

C

CableCARD 2, 4, 9

Cables 2

Cable Out, connector 4

Compliance, FCC and Canadian EMI 21

Component video connection. *See* YPbPr

Composite 7

Connectors

See also Front panel; Back panel

required for HDTV 6

required for SDTV 7

VCR 6, 7

Connecting the set-top to other devices

HDTV with 1394 connector 17

HDTV with component input (YPbPr) 14

HDTV with DVI connector 13

HDTV with HDMI connector 12

HDTV with VCR 16

Home Theater System with component input (YPbPr) 15

SDTV 17

Controls. *See* Front panel

D

Diagrams. *See* Connecting the set-top to other devices

Digital TV, What is it 10

Display, LED 3

DVI connector 2, 4, 6, 13

F

FAQs 10

FCC compliance 21

Formats, picture 11

Frequently Asked Questions. *See* FAQs

Front panel 3

H

HD

broadcasting 10

mode 4, 5, 6, 7, 17

format 1, 10

HDTV

Connections 6

formats 11

What is it 10

HDMI 4, 6, 12

High-definition. *See* HD

Home theater system connection 15

I

Interlaced scan rate 11

IR Sensor 3

K

Keys. *See* Front panel; Back panel

Index, continued

L

LED Display 3

M

M-Card. See Multi-Stream CableCARD

Multi-Stream CableCARD 1, 2, 4, 9

P

Picture

Doesn't display 9

Formats 11

No color 9

Ports. See Connectors

Product information 1

Programming, viewing 8

Progressive scan rate 11

R

Remote control 8

RGB connector. See YPbPr

S

S-Video 7

Safety ii, iv-v

Scan rates 11

Screen

burn-in 8

resolution 11

size 11

SD mode 4, 5, 7, 17

SDTV

Connections 7, 17

What is it 10

Serial number, locating 1

Set-top. See Welcome

Software updates 9

Sound, troubleshooting 9

Standard-definition, What is it 10

Standard-screen TV 11

Stretching and zooming picture 8, 11

T

Troubleshooting 9

TV

digital, what is it 10

formats 11

HDTV, what is it 10

programming 8

resolution 11

standard-screen 11

standard-definition, What is it 10

wide-screen 11

U

Updating, software 9

USB port 3

V

VCR connection 6, 7, 16

View programs 8

W

Watch TV 1, 8

Web access to product information 1

Welcome 1

Wide-screen TV 11

Y

YPbPr

connector 4, 6, 7

HDTV connection 14

home theater connection 15

SDTV connection 17

Z

Zoom picture 8, 11

FCC Compliance

United States FCC Compliance

This device has been tested and found to comply with the limits for a Class B digital device, pursuant to part 15 of the FCC Rules. These limits are designed to provide reasonable protection against such interference in a residential installation. This equipment generates, uses, and can radiate radio frequency energy. If not installed and used in accordance with the instructions, it may cause harmful interference to radio communications. However, there is no guarantee that interference will not occur in a particular installation. If this equipment does cause harmful interference to radio or television reception, which can be determined by turning the equipment OFF and ON, the user is encouraged to try to correct the interference by one or more of the following measures:

- Reorient or relocate the receiving antenna.
- Increase the separation between the equipment and receiver.
- Connect the equipment into an outlet on a circuit different from that to which the receiver is connected.
- Consult the service provider or an experienced radio/television technician for help.

Any changes or modifications not expressly approved by Cisco Systems, Inc., could void the user's authority to operate the equipment.

The information shown in the FCC Declaration of Conformity paragraph below is a requirement of the FCC and is intended to supply you with information regarding the FCC approval of this device. *The phone numbers listed are for FCC-related questions only and not intended for questions regarding the connection or operation for this device. Please contact your service provider for any questions you may have regarding the operation or installation of this device.*

FCC Declaration of Conformity

This device complies with Part 15 of FCC Rules. Operation is subject to the following two conditions: 1) the device may not cause harmful interference, and 2) the device must accept any interference received, including interference that may cause undesired operation.

RNG150 and RNG150N Digital-Only
High-Definition Interactive Set-Tops
Models: RNG150 and RNG150N
Manufactured by: Cisco Systems, Inc.
5030 Sugarloaf Parkway
Lawrenceville, Georgia 30044 USA
Telephone: 770-236-1077

Canada EMI Regulation

This Class B digital apparatus complies with Canadian ICES-003.

Cet appareil numérique de la class B est conforme à la norme NMB-003 du Canada.

20081121 FCC Standard

Software and Firmware Use

The software described in this document is protected by copyright law and furnished to you under a license agreement. You may only use or copy this software in accordance with the terms of your license agreement.

The firmware in this equipment is protected by copyright law. You may only use the firmware in the equipment in which it is provided. Any reproduction or distribution of this firmware, or any portion of it, without our express written consent is prohibited.

Disclaimer

Cisco Systems, Inc. assumes no responsibility for errors or omissions that may appear in this guide. We reserve the right to change this guide at any time without notice.

AVC VIDEO LICENSE

With respect to each AVC/H.264 product, we are obligated to provide the following notice:

THIS PRODUCT IS LICENSED UNDER THE AVC PATENT PORTFOLIO LICENSE FOR THE PERSONAL AND NON-COMMERCIAL USE OF A CONSUMER TO (i) ENCODE VIDEO IN COMPLIANCE WITH THE AVC STANDARD ("AVC VIDEO") AND/OR (ii) DECODE AVC VIDEO THAT WAS ENCODED BY A CONSUMER ENGAGED IN A PERSONAL AND NON-COMMERCIAL ACTIVITY AND/OR WAS OBTAINED FROM A VIDEO PROVIDER LICENSED TO PROVIDE AVC VIDEO. NO LICENSE IS GRANTED OR SHALL BE IMPLIED FOR ANY OTHER USE. ADDITIONAL INFORMATION MAY BE OBTAINED FROM MPEG LA, L.L.C. SEE [HTTP://WWW.MPEGLA.COM](http://www.mpegla.com).

Accordingly, please be advised that service providers, content providers, and broadcasters are required to obtain a separate use license from MPEG LA prior to any use of AVC/H.264 encoders and/or decoders.



Cisco Systems, Inc.
5030 Sugarloaf Parkway, Box 465447
Lawrenceville, GA 30042

678.277.1000

www.cisco.com

Cisco and the Cisco Logo are trademarks or registered trademarks of Cisco and/or its affiliates in the U.S. and other countries. A listing of Cisco's trademarks can be found at www.cisco.com/go/trademarks.

CableCARD and M-Card are trademarks of Cable Television Laboratories, Inc.

Manufactured under license from Dolby Laboratories. Dolby is a trademark of Dolby Laboratories.

HDMI, the HDMI logo, and High-Definition Multimedia Interface are trademarks or registered trademarks of HDMI Licensing LLC.

Other third party trademarks mentioned are the property of their respective owners.

The use of the word partner does not imply a partnership relationship between Cisco and any other company. (1009R)

© 2008, 2010 Cisco and/or its affiliates. All rights reserved.

October 2010

Printed in United States of America

Part Number 4026883 Rev B