

Smart choice for power™

**xantrex™**

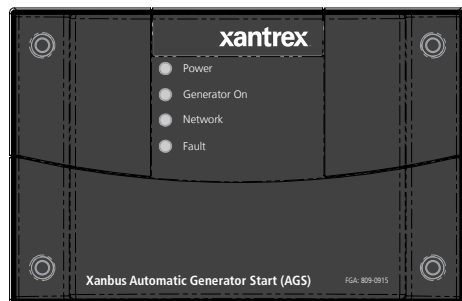

**Owner's Guide**

# Xanbus™ Automatic Generator Start (AGS)

PN: 809-0915

**xanbus™**  
E N A B L E D



## Trademarks

**Xantrex**, **Xanbus**, and **Smart choice for power** are trademarks of Schneider Electric Services International sprl, registered in the U.S. and other countries. Other trademarks, registered trademarks, and product names are the property of their respective owners and are used herein for identification purposes only.

## Notice of Copyright

Xanbus Automatic Generator Start Owner's Guide © March 2011 Xantrex Technology USA Inc. All rights reserved. No part of this document may be reproduced in any form or disclosed to third parties without the express written consent of: Xantrex Technology USA Inc., 541 Roske Drive, Suite A, Elkhart, Indiana USA 46516. Xantrex Technology USA Inc. reserves the right to revise this document and to periodically make changes to the content hereof without obligation or organization of such revisions or changes unless required to do so by prior arrangement.

## Exclusion for Documentation

UNLESS SPECIFICALLY AGREED TO IN WRITING, XANTREX TECHNOLOGY USA INC. ("XANTREX")

- (A) MAKES NO WARRANTY AS TO THE ACCURACY, SUFFICIENCY OR SUITABILITY OF ANY TECHNICAL OR OTHER INFORMATION PROVIDED IN ITS MANUALS OR OTHER DOCUMENTATION;
- (B) ASSUMES NO RESPONSIBILITY OR LIABILITY FOR LOSSES, DAMAGES, COSTS OR EXPENSES, WHETHER SPECIAL, DIRECT, INDIRECT, CONSEQUENTIAL OR INCIDENTAL, WHICH MIGHT ARISE OUT OF THE USE OF SUCH INFORMATION. THE USE OF ANY SUCH INFORMATION WILL BE ENTIRELY AT THE USER'S RISK; AND
- (C) REMINDS YOU THAT IF THIS MANUAL IS IN ANY LANGUAGE OTHER THAN ENGLISH, ALTHOUGH STEPS HAVE BEEN TAKEN TO MAINTAIN THE ACCURACY OF THE TRANSLATION, THE ACCURACY CANNOT BE GUARANTEED. APPROVED XANTREX CONTENT IS CONTAINED WITH THE ENGLISH LANGUAGE VERSION WHICH IS POSTED AT WWW.XANTREX.COM.

## Date and Revision

March 2011 Rev D

## Document Part Number

975-0082-01-01

## Product Number

809-0915

## Contact Information

Telephone: 1 800 670 0707

Fax: 1 800 994 7828

Web: [www.xantrex.com](http://www.xantrex.com)

# About This Guide

## Purpose

The purpose of this Owner's Guide is to provide explanations and procedures for installing, troubleshooting, operating and maintaining the Xanbus Automatic Generator Start (AGS).

## Scope

The Guide provides safety and operating guidelines, procedures for installing the AGS, as well as information on configuring the AGS. It also provides information about troubleshooting the unit. It does not provide details about configuring every Xanbus-enabled device to which the SCP connects to within the Xanbus network. You need to consult these other Xanbus-enabled devices' owner's and installation guides.

## Audience

The Guide is intended for users and operators of the Xanbus Automatic Generator Start (AGS). The Installation section is primarily intended for qualified installers who need to install and configure an AGS. The installer should have knowledge and experience in installing electrical equipment, knowledge of the applicable installation codes, and awareness of the hazards involved in performing electrical work and how to reduce those hazards. A qualified technician or electrician has this knowledge and experience.

## Conventions Used

The following conventions are used in this guide.

### DANGER

#### STATEMENT OF HAZARD

Contains statements of avoidance or strict compliance.

**Failure to follow these instructions will result in death or serious injury.**

### WARNING

#### STATEMENT OF HAZARD

Contains statements of avoidance or strict compliance.

**Failure to follow these instructions can result in death or serious injury.**

### CAUTION

#### STATEMENT OF HAZARD

Contains statements of avoidance or strict compliance.

**Failure to follow these instructions can result in minor or moderate injury.**

## CAUTION

### STATEMENT OF HAZARD

Contains statements of avoidance or strict compliance.

**Failure to follow these instructions can damage the unit and/or damage other equipment.**

**IMPORTANT:** These notes describe things which are important for you to know, however, they are not as serious as a danger, warning, or caution.

### Related Information

You can find more information about Xantrex Technology USA Inc. as well as its products and services at **[www.xantrex.com](http://www.xantrex.com)**.



The product marking on the left when found imprinted on electrical and electronic units and appliances means that you are to refer to this guide for cautions and warnings.

# Important Safety Instructions

---

**IMPORTANT:** READ AND SAVE THIS OWNER'S GUIDE FOR FUTURE REFERENCE.

---

This chapter contains important safety, operation, and installation instructions for the Xanbus Automatic Generator Start (AGS). Each time, before using the AGS, READ ALL instructions and cautionary markings on or provided with the AGS and all appropriate sections of this guide.

**IMPORTANT:**

1. If the Xanbus Automatic Generator Start (AGS) is inoperative, see “Warranty and Return Information” on page 38 for guidance.
2. The Xanbus Automatic Generator Start (AGS) contains no user-serviceable parts. For obtaining service, see “Warranty and Return Information” on page 38 for guidance.
3. Protect the Freedom SW Automatic Generator Start from rain, snow, spray, and water.
4. Disable the generator's starting circuit by disconnecting the starter battery, spark plug, et cetera, before wiring this device.
5. To reduce the risk of electrical shock, put the Xantrex Xanbus system into Standby before working on any circuits connected to it. See “Putting the AGS in Standby Mode” on page 67.
6. Disable the automatic starting circuit and/or disconnect the generator from its starting battery to prevent accidental starting while performing maintenance.

 **WARNING**

**EXPLOSION HAZARD**

This equipment is not ignition protected. To prevent fire or explosion, do not install the unit in compartments containing flammable materials or in locations that require ignition-protected equipment. This includes any space containing gasoline-powered machinery, fuel tanks, as well as joints, fittings, or other connections between components of the fuel system.

**Failure to follow these instructions can result in death or serious injury.**

 **WARNING**

**SAFETY HAZARD**

Disable the Xanbus Automatic Generator Start (AGS) if the generator or vehicle equipped with the generator is in an enclosed building or area where the generator exhaust is not vented to the outside.

**Failure to follow these instructions can result in death or serious injury.**

 **WARNING**

**RESTRICTIONS ON USE**

The Xanbus Automatic Generator Start (AGS) shall not be used in connection with life support systems or other medical equipment or devices.

**Failure to follow these instructions can result in death or serious injury.**

## FCC Information to the User

This equipment has been tested and found to comply with the limits for a Class B digital device, pursuant to part 15 of the FCC Rules. These limits are designed to provide reasonable protection against harmful interference in a residential installation. This equipment generates, uses, and can radiate radio frequency energy and, if not installed and used in accordance with the instructions, may cause harmful interference to radio communications.

However, there is no guarantee that interference will not occur in a particular installation. If this equipment does cause harmful interference to radio or television reception, which can be determined by turning the equipment off and on, the user is encouraged to try to correct the interference by one or more of the following measures:

- Reorient or relocate the receiving antenna.
- Increase the separation between the equipment and receiver.
- Connect the equipment into an outlet on a circuit different from that to which the receiver is connected.
- Consult the dealer or an experienced radio/TV technician for help.

## CAUTION

Unauthorized changes or modifications to the equipment could void the user's authority to operate the equipment.





# Contents

Important Safety Instructions . . . . .	.iv
Introduction . . . . .	1
Features . . . . .	6
Xanbus Automatic Generator Start Installation . . . . .	8
Configuration of the Xanbus AGS . . . . .	36
Operation of the Xanbus AGS . . . . .	64
Troubleshooting . . . . .	69
Specifications . . . . .	73
Warranty and Return Information . . . . .	75
Appendix A: Generator Auto Start Requirements and Types . . . . .	79
Appendix B: Relay Timing . . . . .	82

---



# Introduction

**IMPORTANT:** The Xanbus Automatic Generator Start (AGS) is designed for use in a Xanbus-enabled Freedom SW Power System only. The Xanbus AGS requires the additional use of a Xanbus System Control Panel (SCP) for configuration and monitoring. For details see "System Requirements".

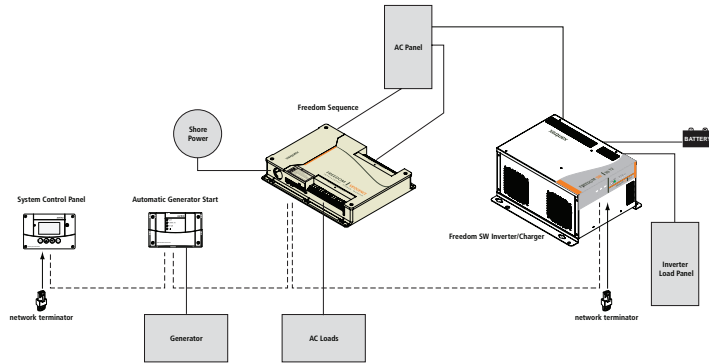

**Figure 1** Xanbus Automatic Generator Start (AGS) Basic Function

**Function** The Xanbus AGS continuously monitors battery voltage and starts, or stops, the generator when battery voltage drops below or exceeds the preset limits. It also starts the generator to assist the system's inverter/charger when output power demands are high.

**Start and Stop Triggers** The Xanbus AGS requires a source of start and stop triggers for automatic operation. The Xanbus AGS monitors the Xanbus network and starts or stops the generator based on the preset limits programmed into it.

## System Requirements

Minimum basic system components include the following:

- Freedom SW Series Inverter/Charger
- AC Generator or DC Generator
- Xanbus System Control Panel (SCP)
- Xanbus Automatic Generator Start (AGS)

**Network Communication Protocol** The AGS uses Xanbus, a network communications protocol developed by Xantrex, to communicate its settings and activity to other Xanbus-enabled devices. All network components used in the system must be Xanbus-enabled.

**Network Power Supply** The Xanbus AGS requires three watts of power (maximum) to operate. This power supply is provided by the Freedom SW Series Inverter/Charger through the Xanbus network.

**Generator** The generator should be a 2-wire or 3-wire generator with Auto Start capability.

The generator should also supply a Generator Run signal. The Generator Run signal is connected to the Xanbus AGS and used by the Xanbus AGS to detect whether the generator is running. Some generator manufacturers refer to this signal as the Hour Meter Signal or Switched B+.

Connecting the Generator Run signal is optional and only used for redundancy. The Xanbus AGS requests generator voltage from the Xanbus in addition to checking the Generator Run signal to detect if the generator is running.

**Generator Compatibility** The Xanbus AGS supports most two and three-wire generator starters. Some manufacturers include, but are not limited to, Onan (Quiet Diesel, gasoline, and LP), Power Tech, Generac, Northern Lights, Fisher Panda, Westerbeke, Kohler, Honda, and Yamaha. Check with the generator manufacturer to ensure the generator in question includes automatic starting capabilities.

**Xanbus System Control Panel (SCP)** A Xanbus System Control Panel (SCP) is required to configure the AGS and monitor generator starting and stopping activity.

The Xanbus System Control Panel (SCP) also provides real-time clock information for the AGS Quiet Time and Exercise Time features.

---

## Functions

### Generator Starting Triggers

The AGS can automatically start a generator in response to:

- a low battery voltage,
- large AC loads when inverter is operating,
- a thermostat signal, or
- a pre-programmed exercise period at a specified time of day.

### Generator Stopping Triggers

The AGS can automatically stop a generator in response to:

- the introduction of qualified grid power (grid power within acceptable parameters),
- high battery voltage,
- battery charge stage (float or absorb stage),
- reduction in AC loads when inverter is operating,
- a thermostat signal, or
- a pre-programmed quiet time period.

The AGS can also be used to manually start and stop the generator at any time.

### Programmable Features

**Quiet Time** The AGS features a quiet time setting, which prevents the generator starting at night or during other inconvenient periods.

**Exercise Period** During times of prolonged generator inactivity, the AGS can be programmed to run (or “exercise”) the generator for a pre-defined period. This ensures the generator remains operational and that the starting battery stays charged.

### Status Reporting

The AGS reports its operating mode, its settings, generator activity, and the reason for generator starts to the Xanbus system. This information can be viewed on the Xanbus System Control Panel (SCP).

### Installation Options

The AGS can be installed with an external shutdown input, a manual generator ON/OFF switch, and an external ON/OFF indicator light.

## Material List

The AGS ships with the following items:

- one Xanbus Automatic Generator Start (AGS) unit,
- owner's guide,
- wiring harness (20-pin connector),
- mounting template, and
- mounting screws (4).

**NOTE:** Keep the carton and packing material in case you need to return the AGS for servicing.

AGS  
unit

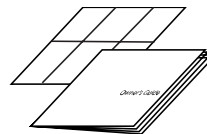
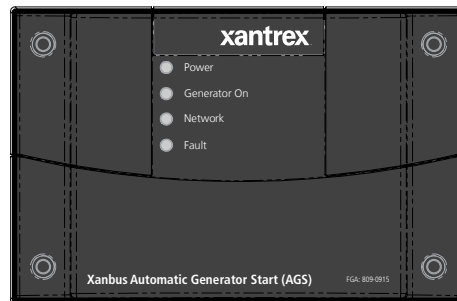

owner's guide and  
mounting template

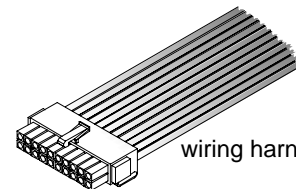

wiring harness



mounting screws

## Xanbus-Enabled Products and Accessories

Product/Accessory	Product Number
Freedom SW Series Inverter/Charger	815-2012 (2kW power rating), 815-3012 (3kW power rating)
Freedom Sequence Intelligent Power Manager	809-0913 (four-circuit model), 809-0912 (six-circuit model)
Xanbus System Control Panel (SCP)	809-0921
25-ft network cable for SCP	809-0940
75-ft network cable for SCP	809-0942

The Freedom SW Inverter/Charger is a true sine wave inverter/charger that can be used for mobile, marine and commercial applications. The Freedom SW Inverter/Chargers are designed to operate with a wide variety of generators and are capable of operating in parallel with a generator for short durations to assist with starting large loads. The Freedom SW is a convenient combination of an inverter, multistage battery charger, and transfer switch in one electronic device.

The Xanbus SCP provides configuration and monitoring capability for a Xanbus system. It monitors activity throughout your power system, displays the settings and status, as well as, adjusting the settings for each Xanbus-enabled device.

The Freedom Sequence Intelligent Power Manager is a fully integrated power management system that provides automatic power and load management for use in recreational vehicles (RV) while receiving power from a generator or shore power.

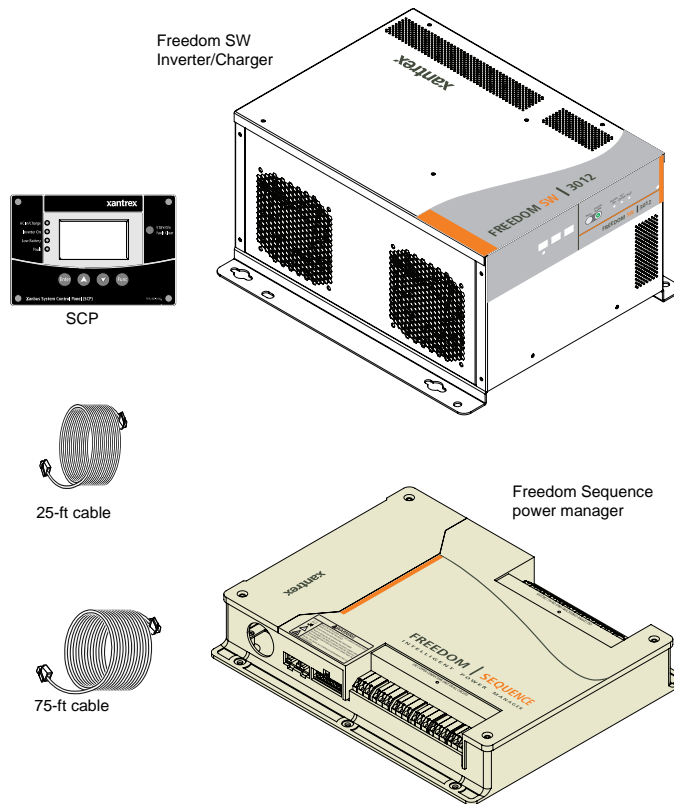

# Features

The AGS has important features on the front and back of the unit. Features on the front of the AGS are the indicator lights for reporting statuses on power, generator, network, and faults (see Figure 2). The back of the unit features the inputs where the AGS connects to the Xanbus system and the 20-contact wiring harness connector port (see Figure 3).

## Front panel features

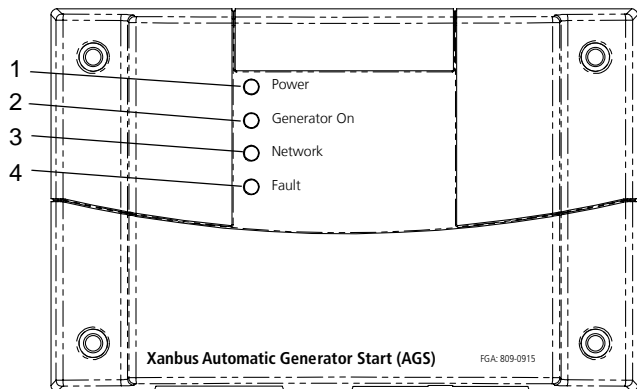
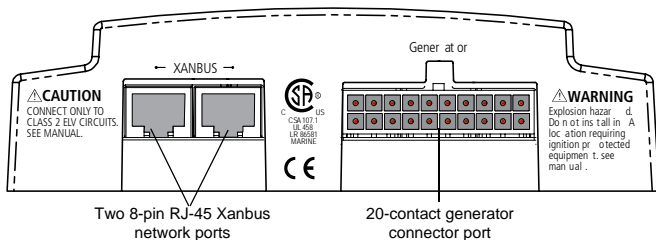

Figure 2 AGS Front Panel

Item	Description
1	<b>Power</b> light (green) indicates that the AGS is receiving power from the Xanbus network.
2	<b>Generator On</b> light (green) indicates that the generator is up and running.
3	<b>Network</b> light (green) indicates that the Xanbus network is maintaining a good connection with all Xanbus-enabled components.
4	<b>Fault</b> light (red) indicates the generator is experiencing a fault and requires user attention and intervention.



## Bottom panel features



**Figure 3** AGS Bottom Panel

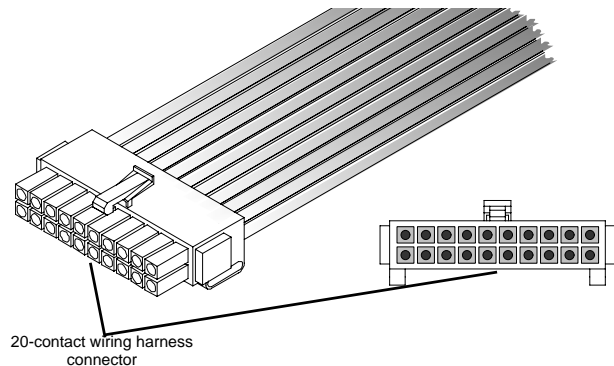

**Figure 4** Wiring Harness Connector

**Wiring Harness Connector** The 20-contact connector supports a wiring harness (supplied) that connects the AGS to a generator and thermostats. The wiring harness also provides lines for connecting external generator shutdown sensors or switches and external generator ON/OFF controls.

### ⚠ CAUTION

#### EQUIPMENT DAMAGE

Only connect the Xanbus Automatic Generator Start (AGS) to other Xanbus-enabled devices.

Although the cabling and connectors used in this network system are the same as those used for Ethernet, this network is not an Ethernet system. Equipment damage may result from attempting to connect these two different systems.

**Failure to follow these instructions can result in minor or moderate injury.**

**Network Ports** Each network port can accept an eight-pin RJ45 plug attached to a Category 5 (CAT 5) Xanbus network cable. Depending on the installation, both ports may be required.

# Xanbus Automatic Generator Start Installation

Before installing the AGS, consider how and where the unit will be mounted. Pre-plan the connection routes between the AGS, the generator, thermostats, and the Xanbus System Control Panel (SCP).

## Materials and Tools Required

The following materials and tools are required to complete the installation:

- Mounting template (supplied)
- Wiring harness (manufacturer part number 809-0917, supplied)
- Four mounting screws (supplied)
- #16 or #18 AWG wire (see “Wire Size and Length” on page 12)
- Xanbus network cables or equivalent (CAT 5 or CAT 5e cable with RJ-45 connectors wired to T568A standard.
- Two network terminators  
(supplied with the Freedom SW Inverter/Charger)
- Phillips head screwdriver
- Wire cutters and wire strippers

## Choosing a Location

The AGS should be installed in a location that meets the following requirements:

<b>Dry</b>	The unit is intended for use in a dry location. The AGS complies with UL458 Marine Supplement drip-test requirements, but the location should be as dry as possible.
<b>Cool</b>	The AGS operation is guaranteed between -4 and 122 °F (-20 and 50 °C).
<b>Safe</b>	The AGS is not ignition protected. Do not install it in areas requiring ignition-protected equipment, such as compartments housing gasoline engines.
<b>Close to generator</b>	Avoid excessive wire lengths and use the recommended wire lengths and sizes (see “Wire Size and Length” on page 12). It is more important for the AGS to be close to the generator than close to the inverter, although for safety reasons, the AGS should not be installed in the same compartment as a gasoline-powered generator.

## Routing Connections

### DANGER

#### EXPLOSION HAZARD

This equipment is not ignition protected. To prevent fire or explosion, do not install the AGS in locations that require ignition-protected equipment. This includes any space containing gasoline-powered machinery, fuel tanks, as well as joints, fittings, or other connections between components of a fuel system.

Follow all relevant instructions exactly before installing or using your AGS.

#### SHOCK AND ENERGY HAZARDS

Before making any connections to the generator, ensure that the generator's starter is disabled and the generator's start battery is disconnected.

**Failure to follow these instructions will result in death or serious injury.**

**Connection Types** Because the AGS will be part of a Xanbus system, it is necessary to consider how to route two types of connections:

- connections to the generator, thermostats, and other external devices and switches, using the included 20-contact connector and wiring harness.
- connections to other Xanbus-enabled devices, using network cables.

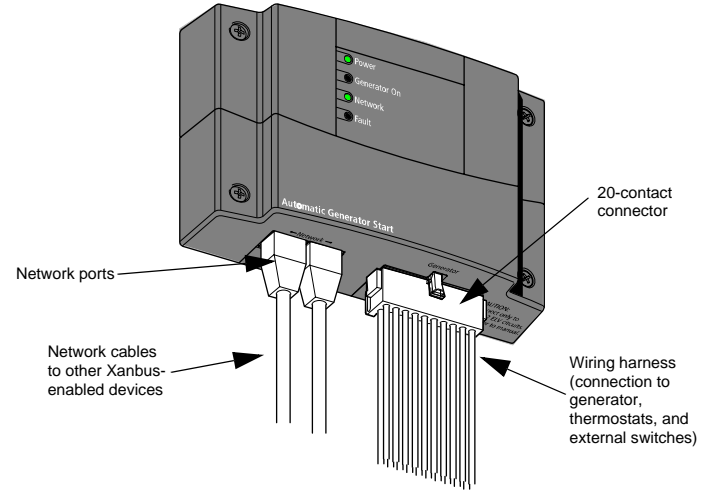

**Figure 5** AGS External Connections

### Installation Overview

Installing the AGS involves the following steps:

1. Mounting the unit.
2. Connecting the wiring harness to:
  - the generator (page 14)
  - thermostats (optional) (page 29)
  - external shutdown switch (optional) (page 30)
  - external ON/OFF switch and LED (optional) (page 30)

 <b>WARNING</b>
--

<b>ELECTRICAL SHOCK HAZARD</b>
--------------------------------

Before installing the AGS as part of a pre-existing Xanbus system, put the system in Standby in order to disable the electrical operation of networked devices. See “Putting the AGS in Standby Mode” on page 67.
---

<b>Failure to follow these instructions can result in death or serious injury.</b>
--

3. Connecting the wiring harness to the 20-contact connector on the AGS.
4. Connecting the AGS to the Xanbus System Control Panel (SCP) and other network-enabled devices (page 33).

---

**IMPORTANT:** Because each installation varies according to the location, the type of generator, and the overall complexity of the Xanbus system, these instructions can offer only general guidelines for the many installation options available.

---

### Mounting the Unit

The AGS is to be mounted vertically on a wall with the connectors facing downwards.

**To mount the AGS:**

1. Hold the unit flush and square against the wall, panel, or horizontal surface.
  - If the mounting surface requires pre-drill holes for the screws, use the supplied mounting template to mark, then drill, four holes.
2. With a Phillips screwdriver and the supplied mounting screws, secure each corner of the AGS to the mounting surface.

## Wiring to the 20-contact Connector

### ⚠ WARNING

#### ELECTRICAL SHOCK HAZARD

All installation wiring should be performed by a qualified installer or electrician.

The 20-contact connector is intended for connection to Class 2 ELV (Extra Low Voltage) circuits only. Do not exceed the circuit limitations specified in the following section.

**Failure to follow these instructions can result in death or serious injury.**

**ELV Circuits** ELV (Extra-Low Voltage) circuits have an open-circuit voltage of not more than  $30 V_{\text{rms}}$  or 42.2 VDC or peak, and are therefore not a shock hazard.

**Class 2 Circuits** As per the US National Electrical Code (NEC) and the Canadian Electrical Code (CEC), available power in Class 2 circuits is limited to 100 VA, usually by current limiting by means of overcurrent protection or series resistance. The current is limited to 5 A for circuits with open-circuit voltage of 20 V, and to  $I=100/V_{\text{oc}}$  for circuits with open circuit voltage between 20 V and 30 V.

**Circuit Limitations** The relay contacts in the AGS are rated at 5 A maximum and all circuits on the 20-contact connector are rated at 30 V maximum.

Ensure that all circuits connected to the 20-contact connector comply with the following limits:

Circuit Parameter	Circuit Maximum
Open circuit voltage ( $V_{\text{oc}}$ )	30 V maximum
Overcurrent protection (fuse size for open circuit voltage up to 20 V)	5 A maximum
Overcurrent protection (fuse size for open circuit voltage from 20 V to 30 V)	5 A to 3.33 A ( $100/V_{\text{oc}}$ amps maximum)

**Wiring Harness** Connections to the generator, thermostats, and external ON/OFF switches are made using a wiring harness that plugs into the 20-contact connector (see Figure 5).

The wires on the wiring harness can be extended to meet installation requirements. When extending the wire harness, ensure that the extension wires are the same color as the wires on the harness.

## Xanbus Automatic Generator Start Installation

### To install the AGS using the wiring harness:

1. Connect each wire on the harness to its intended wire or contact on the generator, thermostats, or external switches. Tape, or otherwise secure, the unused wires to ensure they do not make unintended connections.
2. Plug the harness into the connector on the bottom panel of the AGS.

**Wire Identification** Each wire on the harness is identified by a number and a color. The wire numbers are shown in Figure 6 and their colors and functions are described in the next table.

**Wire Size and Length** Required wire sizes for the external connections to the wiring harness are:

0–30 ft. (9 m)	Over 30 ft. (9 m)
18 AWG	16 AWG

When planning the routing for external connections, ensure that wire lengths are sufficient to plug the wiring harness into the AGS once all the external connections are complete.

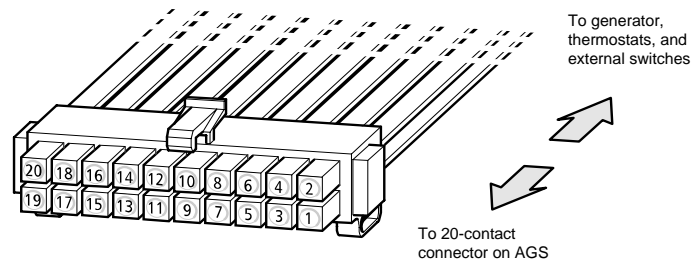

Figure 6 AGS Wiring Harness

Wire Number	Function	Wiring Harness Wire Color
1	Thermostat 1 input	Yellow
2	Thermostat 1 return	Gray
3	Thermostat 2 input	Orange
4	Thermostat 2 return	Gray
5	External shutdown input	White/Black
6	External shutdown return	Gray
7	External manual on input	White/Green
8	External manual off input	White/Red
9	External ON/OFF LED Indicator output	White/Blue
10	Constant 12/24 V B+ (battery positive) for External ON/OFF/LED Indicator	Red

Wire Number	Function	Wiring Harness Wire Color
11	External ON/OFF/LED Indicator return (connected internally to wire number 13)	Black
12	Generator run signal (switched B+) sense input	Violet
13	Generator run signal (switched B+) sense return	Black
14	Relay 1 (Generator run/stop) Normally open contact	Blue
15	Relay 1 (Generator run/stop) Normally closed contact	White/Violet
16	Relay 1 (Generator run/stop) Common contact	Gray
17	Relay 2 (Generator start) Normally open contact	White
18	Relay 2 (Generator start) Common contact	Gray
19	Relay 3 (Preheat/cool-down) Normally open contact	Brown
20	Relay 3 (Preheat/cool-down) Common contact	Gray

## Connecting the Generator

### CAUTION

#### EQUIPMENT DAMAGE

Before connecting the AGS to your generator, read the Generator Type descriptions in this section and consult your generator manufacturer to ensure that Gen Type settings and connections are compatible with your generator. Damage to the generator can result from selecting an incorrect Gen Type and following the connection diagram for an incorrect Gen Type when connecting the AGS to the generator. Xantrex assumes no responsibility or liability for loss or damage that might arise out of the use of this information.

**Failure to follow these instructions can damage the unit and/or damage other equipment.**

To connect the AGS to a generator, identify the start wiring configuration of the generator to be used. Generators must be auto-start capable, and generators equipped with remote operation connections are ideal.

If the generator is equipped for remote operation, examine the wiring of the remote cable and connector (or read the generator's documentation, if available) and identify the following wires:

- Ground
- Start
- Stop
- Generator run signal, also known as the Hour Meter or Switched B+ (battery positive)

**Wiring Requirements** Either #16 or #18 AWG wire is required to connect to the wiring harness. How many of these wires you connect and in which combination depends on your generator type.

**Generator Types** The AGS has 14 preset generator configurations, or "Gen Types" (see "Gen Type" on page 42). After installing the hardware, it will be necessary to select one of these Gen Types from the AGS Configuration Menu on the Xanbus System Control Panel (SCP).

**IMPORTANT:** Put the system in Standby BEFORE changing the "Gen Type". See "Putting the AGS in Standby Mode" on page 67.

The following section describes the preset generator configurations and provides diagrams for connecting the wiring harness to the generator's start wiring.

**IMPORTANT:** For an explanation of the terminology used in the following section, refer to Appendix 1, "Appendix A: Generator Auto Start Requirements and Types". For more information about AGS internal relay activity and timing, see Appendix 1, "Appendix B: Relay Timing".

**IMPORTANT:** Connecting the B+ Gen Run signal is optional. If the B+ Gen Run signal is not connected, it may be necessary to adjust the Gen Run Signal hold time parameter on the AGS. See "Gen Run Hold Time" on page 57.



## Type 1

Type 1 is a three-wire GlowStop configuration recommended for “three-wire” generators with glow plugs that need to be operated before a start is attempted.

Relay Function	Preset Configuration Setting
Crank retry time	30 s
Gen Cool Down	30 s
Gen Spin Down	3 s
Shutdown bypass time	0 s
Start tries	3

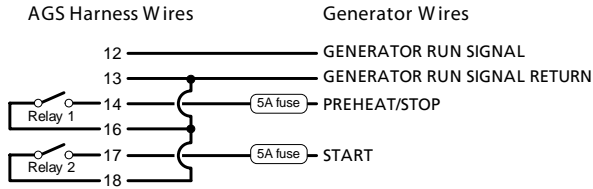

For additional information, see “Circuit Limitations” on page 11.

Figure 7 Type 1 Connection Diagram

Relay Function	Preset Configuration Setting
Relay 1 mode	GlowStop
Relay 3 mode	No function
Gen Run signal hold time	0.5 s
Preheat time	20 s
Preheat to crank delay	1 s
Crank time	15 s

## Type 2

Type 2 is a three-wire GlowStop configuration recommended for “three-wire” generators that don’t require a dedicated preheat signal. In this configuration, the start signal is applied for longer because the generator does its own preheat and cranking while the start signal is applied.

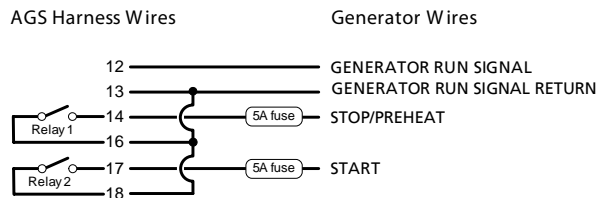

For additional information, see “Circuit Limitations” on page 11.

**Figure 8** Type 2 Connection Diagram

Relay Function	Preset Configuration Setting
Relay 1 mode	GlowStop
Relay 3 mode	No function
Gen Run signal hold time	0.5 s
Preheat time	0 s
Preheat to crank delay	0 s

Relay Function	Preset Configuration Setting
Crank time	30 s
Crank retry time	40 s
Gen Cool Down	30 s
Gen Spin Down	3 s
Shutdown bypass time	0 s
Start tries	3

### Type 3

Type 3 is a three-wire GlowStop with shutdown bypass configuration. The configuration shown in Figure 9 uses a shutdown bypass output to temporarily disable the generator’s low oil pressure shutdown functionality during cranking. Generators with this functionality often have a manual means of disabling it during cranking.

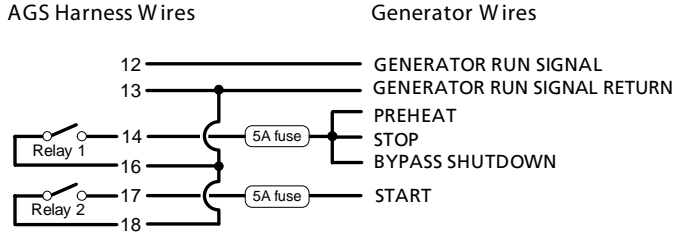

For additional information, see "Circuit Limitations" on page 11.

Figure 9 Type 3 Connection Diagram

Relay Function	Preset Configuration Setting
Relay 1 mode	GlowStop/Shutdown bypass
Relay 3 mode	Preheat/Shutdown bypass
Gen Run signal hold time	0.5 s
Preheat time	20 s

Relay Function	Preset Configuration Setting
Preheat to crank delay	0 s
Crank time	15 s
Crank retry time	30 s
Gen Cool Down	30 s
Gen Spin Down	3 s
Shutdown bypass time	10 s
Start tries	3

## Type 4

Type 4 is a three-wire StartStop configuration that uses relay 3 to provide a 60-second preheat signal.

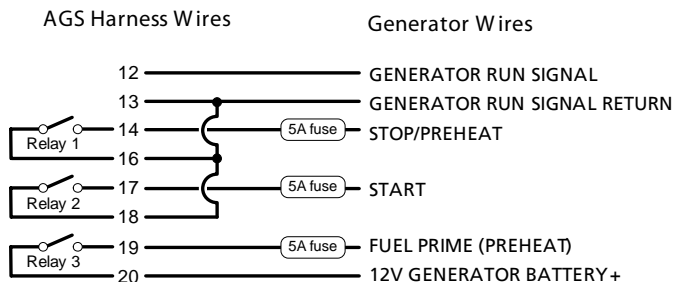

For additional information, see "Circuit Limitations" on page 11.

**Figure 10** Type 4 Connection Diagram

Relay Function	Preset Configuration Setting
Relay 1 mode	StartStop
Relay 3 mode	Preheat
Gen Run signal hold time	10 s
Preheat time	60 s

Relay Function	Preset Configuration Setting
Preheat to crank delay	5 s
Crank time	15 s
Crank retry time	15 s
Gen Cool Down	30 s
Gen Spin Down	3 s
Shutdown bypass time	0 s
Start tries	3

## Type 5

Type 5 is a three-wire StartStop configuration that uses relay 3 to provide a 15-second preheat signal.

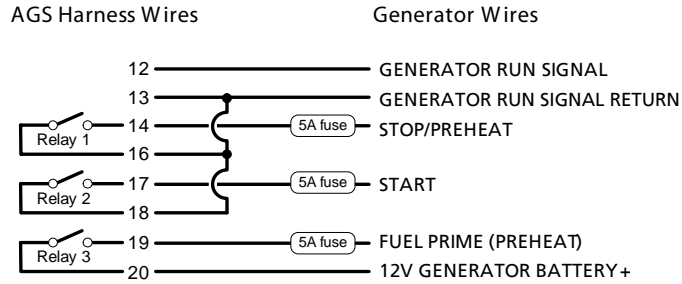

Relay Function	Preset Configuration Setting
Crank time	15 s
Crank retry time	15 s
Gen Cool Down	30 s
Gen Spin Down	3 s
Shutdown bypass time	0 s
Start tries	3

For additional information, see "Circuit Limitations" on page 11.

**Figure 11** Type 5 Connection Diagram

Relay Function	Preset Configuration Setting
Relay 1 mode	StartStop
Relay 3 mode	Preheat
Gen Run signal hold time	2 s
Preheat time	15 s
Preheat to crank delay	2 s

## Type 6

Type 6 is a three-wire GlowStop configuration that has a normally closed Run/Stop contact.

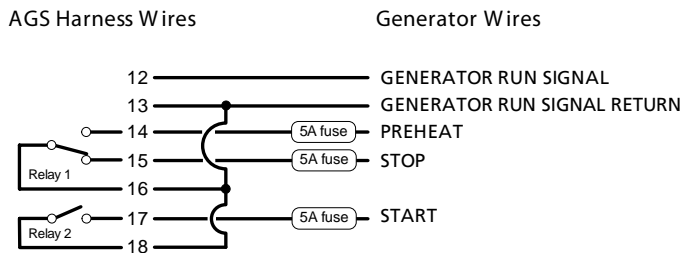

For additional information, see "Circuit Limitations" on page 11.

**Figure 12** Type 6 Connection Diagram

Relay Function	Preset Configuration Setting
Relay 1 mode	GlowStop
Relay 3 mode	No function
Gen Run signal hold time	0.5 s
Preheat time	10 s
Preheat to crank delay	1 s
Crank time	15 s

Relay Function	Preset Configuration Setting
Crank retry time	30 s
Gen Cool Down	30 s
Gen Spin Down	3 s
Shutdown bypass time	0 s
Start tries	3

## Type 7

Type 7 will work with both two-wire and three-wire run mode configurations that require a preheat signal before cranking. This Gen Type setting is suitable for generators with an automatic engine cranking control system (two-wire) and generators that require that the AGS control their starter separately (three-wire).

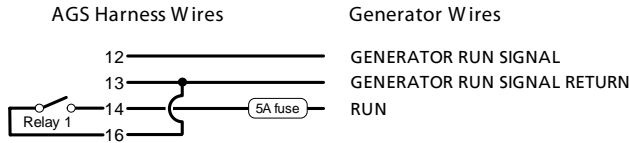

For additional information, see "Circuit Limitations" on page 11.

**Figure 13** Type 7 Connection Diagram (two-wire)

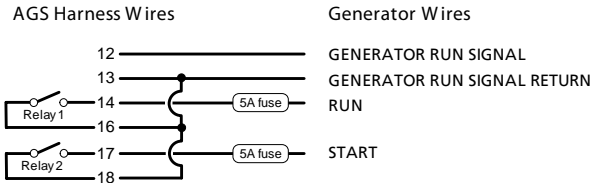

For additional information, see "Circuit Limitations" on page 11.

**Figure 14** Type 7 Connection Diagram (three-wire)

Relay Function	Preset Configuration Setting
Relay 1 mode	Run
Relay 3 mode	No function
Gen Run signal hold time	0.5 s
Preheat time	20 s
Preheat to crank delay	1 s
Crank time	15 s
Crank retry time	30 s
Gen Cool Down	30 s
Gen Spin Down	3 s
Shutdown bypass time	0 s
Start tries	3

## Type 8

Type 8 will work with both two-wire and three-wire run mode configurations. Type 8 is identical to Type 7 except that it provides no preheat signal before cranking.

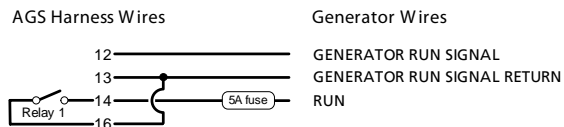

For additional information, see "Circuit Limitations" on page 11.

**Figure 15** Type 8 Connection Diagram (two-wire)

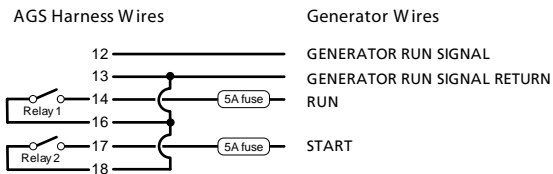

For additional information, see "Circuit Limitations" on page 11.

**Figure 16** Type 8 Connection Diagram (three-wire)

Relay Function	Preset Configuration Setting
Relay 1 mode	Run
Relay 3 mode	No function
Gen Run signal hold time	0.5 s
Preheat time	0 s
Preheat to crank delay	0 s
Crank time	15 s
Crank retry time	30 s
Gen Cool Down	30 s
Gen Spin Down	3 s
Shutdown bypass time	0 s
Start tries	3



## Type 9

Type 9 is a StartStop mode configuration with shutdown bypass functionality on relay 3.

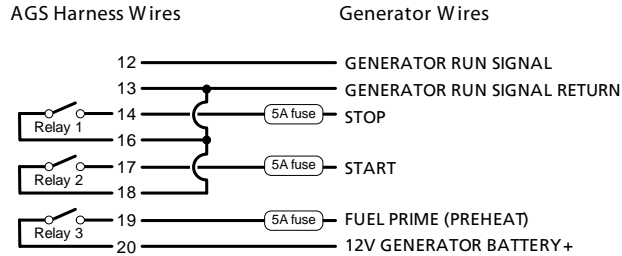

For additional information, see "Circuit Limitations" on page 11.

Figure 17 Type 9 Connection Diagram

Relay Function	Preset Configuration Setting
Relay 1 mode	StartStop
Relay 3 mode	Shutdown Bypass
Gen Run signal hold time	0.5 s
Preheat time	0 s
Preheat to crank delay	0 s

Relay Function	Preset Configuration Setting
Crank time	15 s
Crank retry time	30 s
Gen Cool Down	30 s
Gen Spin Down	3 s
Shutdown bypass time	5 s
Start tries	3

## Type 10

Type 10 is a StartStop mode configuration with no preheat signal or shutdown bypass functionality.

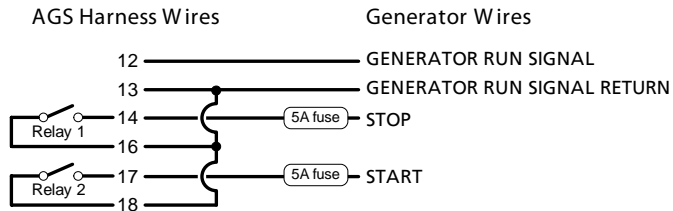

For additional information, see "Circuit Limitations" on page 11.

**Figure 18** Type 10 Connection Diagram

Relay Function	Preset Configuration Setting
Relay 1 mode	StartStop
Relay 3 mode	No function
Gen Run signal hold time	0.5 s
Preheat time	0 s
Preheat to crank delay	0 s
Crank time	15 s
Crank retry time	30 s

Relay Function	Preset Configuration Setting
Gen Cool Down	30 s
Gen Spin Down	3 s
Shutdown bypass time	0 s
Start tries	3

## Type 11

Type 11 is a two-wire run mode configuration. It requires only two wires and one relay to control the generator. Relay 1 closes momentarily once to start the generator, and closes momentarily again to stop the generator.

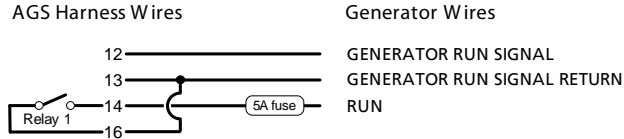

For additional information, see "Circuit Limitations" on page 11.

Relay Function	Preset Configuration Setting
Gen Spin Down	3 s
Shutdown bypass time	0 s
Start tries	3

Figure 19 Type 11 Connection Diagram

Relay Function	Preset Configuration Setting
Relay 1 mode	MomentaryRun
Relay 3 mode	No function
Gen Run signal hold time	0.5 s
Preheat time	0 s
Preheat to crank delay	0 s
Crank time	10 s
Crank retry time	15 s
Gen Cool Down	30 s

## Type 12

Type 12 is a three-wire GlowStop configuration recommended for “three-wire” generators that don’t require a dedicated preheat signal. In this configuration, the start signal is applied for longer because the generator does its own preheat and cranking while the start signal is applied.

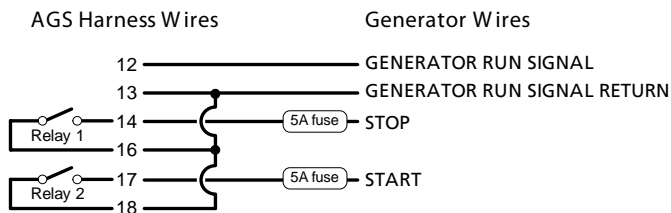

For additional information, see “Circuit Limitations” on page 11.

**Figure 20** Type 12 Connection Diagram

Relay Function	Preset Configuration Setting
Relay 1 mode	GlowStop
Relay 3 mode	No function
Gen Run signal hold time	4 s
Preheat time	0 s
Preheat to crank delay	0 s
Crank time	30 s

Relay Function	Preset Configuration Setting
Crank retry time	40 s
Gen Cool Down	30 s
Gen Spin Down	3 s
Shutdown bypass time	0 s
Start tries	3

## Type 13

Type 13 is a three-wire PulseStop configuration that uses relay 3 to provide the preheat signal. With this generator type, there will be a delay between the generator turning off and the AGS recognizing that the generator is off.

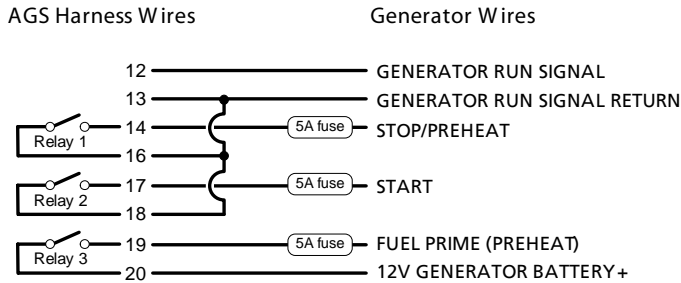

For additional information, see "Circuit Limitations" on page 11.

Figure 21 Type 13 Connection Diagram

Relay Function	Preset Configuration Setting
Relay 1 mode	PulseStop
Relay 3 mode	Preheat
Gen Run signal hold time	5 s

Relay Function	Preset Configuration Setting
Preheat time	15 s
Preheat to crank delay	2 s
Crank time	15 s
Crank retry time	15 s
Gen Cool Down	30 s
Gen Spin Down	3 s
Shutdown bypass time	0 s
Start tries	3

## Type 14

Type 14 works with two-wire generators that use an integrated engine control module to perform the necessary relay cycles to start and stop the generator. This is similar to Type 8 but without the B+ signal requirement. The AGS closes relay 1 to start the generator and illuminates the Generator On light to indicate the relay is closed. To stop the generator, relay 1 is opened and the Generator On light turned off.

**IMPORTANT:** Since Type 14 does not monitor the generator run status, illumination of the Generator On light on the AGS does not necessarily indicate the generator is actually running. If this generator type is used, ensure the generator’s integrated controller has the ability to monitor, control and report generator status and faults. With Type 14, no faults are raised if the generator fails to start or stop or is externally started or stopped.

Once the generator is stopped, there is a 10-minute delay before the generator can be re-started using the AGS. This is to allow the generator’s integrated engine controller to completely and safely shut down the generator. This delay can be adjusted by changing the Gen Spin down setting.



For additional information, see “Circuit Limitations” on page 11.

**Figure 22** Type 14 Connection Diagram (two-wire)

Relay Function	Preset Configuration Setting
Relay 1 mode	RunStop
Relay 3 mode	Not used
Gen Run signal hold time	0 s
Preheat time	0 s
Preheat to crank delay	0 s
Crank time	0 s
Crank retry time	0 s
Gen Cool Down	30 s
Gen Spin Down	600 s
Shutdown bypass time	0 s
Start tries	1

## Connecting the Thermostats (optional)

Wires 1, 2, 3, and 4 on the wiring harness can be connected to two thermostats. Wires 1 (yellow) and 2 (gray) are intended for thermostat 1 and wires 3 (orange) and 4 (gray) are intended for thermostat 2.

**Table 1** Wiring for Connecting Thermostats

Wire Number	Function	Wiring Harness Wire Color
1	Thermostat 1 input (12/24 V)	Yellow
2	Thermostat 1 return (ground)	Gray
3	Thermostat 2 input (12/24 V)	Orange
4	Thermostat 2 return (ground)	Gray

These wires connect to 12-volt/24-volt output signals from the thermostats. The AGS will start the generator in response to these signals. Thermostats can not be programmed using the AGS.

For specific information about thermostat wiring and where AGS connections should be made, please consult your thermostat documentation or contact the thermostat manufacturer.

## Connecting an External Shutdown (optional)

The external shutdown input is a 12-volt/24-volt input used to assure that the AGS keeps the generator off under conditions that may be potentially hazardous. Wire 5 (white/black) and 6 (gray) on the wiring harness are intended for an external switch or sensor (such as a moisture detector, or carbon monoxide detector) that produces an active high 12-volt or 24-volt output.

**Table 2** Wiring for Connecting an External Shutdown

Wire Number	Function	Wiring Harness Wire Color
5	External shutdown input (12/24 V)	White/Black
6	External shutdown return (ground)	Gray

## Connecting an External Manual ON/OFF Switch (optional)

The external manual ON/OFF inputs (wires 7 and 8 on the wiring harness) are intended for wiring to one or more remote ON/OFF switches for starting and stopping the generator manually. Wire 7 (Start) and wire 8 (Stop) should each run to their own momentary-contact switch or push-button. The other contact on both switches (common) should be connected to wire 11 on the harness.

**NOTE:** Internally, wire 11 is connected to wire 13 so it may already be connected to the negative terminal on the generator battery.

In order for the Xanbus Automatic Generator Start (AGS) to be able to detect these switches, connect the fused positive of the generator battery to wire 10 on the harness (the constant 12-volt/24-volt wire). See Figure 23 on page 32. Ensure all circuits added to the system comply with “Circuit Limitations” on page 11.

If the generator battery does not have the required voltage, any 12-volt or 24-volt power source meeting the limits on page 11, will suit this purpose. If an alternate power source is used, its positive terminal must be connected to wire 10. Its negative must be connected to wire 11.

**NOTE:** Internally, wire 11 is connected to wire 13, so in this configuration, the alternative power source negative may already be connected to the negative terminal on the generator battery.

### WARNING

#### FIRE AND ELECTRICAL SHOCK HAZARD

When making connections to a 12-volt or 24-volt power source that exceeds the class 2 power limitation of 100 VA (e.g., a battery) always use over-current protection as defined in Table 2. This also applies to thermostat and external manual ON/OFF connections. Locate the protection device at the power source in the positive wire.

Do not connect the AGS to a 48-volt battery bank. The AGS is limited to a 30V open-circuit maximum by its regulatory approval and cannot be connected to a 48-volt power source.

**Failure to follow these instructions can result in death or serious injury.**



The External Manual On and External Manual Off states are not affected by maximum generator run time (see “Max Run Time” on page 55).

<b>CAUTION</b>
<b>EQUIPMENT DAMAGE</b>
Tapping 12-volts or 24-volts from a 48-volt battery bank will unevenly wear out the batteries and shortens the battery bank life.
<b>Failure to follow these instructions can damage the unit and/or damage other equipment.</b>

### Connecting an External ON/OFF LED

Wires 9 (White/Blue) and 11 (Black) on the wiring harness can be connected to an LED or other light to accompany a remote external ON/OFF switch. This light turns on when the generator run signal is active to visually indicate that the generator is running.

**Table 3** Wiring for Connecting an External Manual ON/OFF Switch

Wire Number	Function	Wiring Harness Wire Color
7	External manual on input	White/Green
8	External manual off input	White/Red
9	External On/Off LED Indicator output	White/Blue
10	Constant 12/24 V B+ for External On/Off/LED Indicator	Red
11	External On/Off/LED Indicator return	Black

---

**IMPORTANT:** With some generators, the generator run signal becomes active during the preheat stage, before the generator is actually running. In this case, the external ON/OFF LED (and the Generator On light on the AGS) will turn on during the preheat stage and remain on when the generator is running. For some generators, these lights will also remain on for a period of time after the generator has stopped.

---

Multiple generator control panels or simple contact closures can be wired to the external manual ON/OFF inputs. The AGS detects if any of the contacts close and will change its operating mode to External Manual On or External Manual Off (for more information, see “GenMode” on page 60). The AGS turns the generator on or off according to these inputs and the resulting operating mode change.

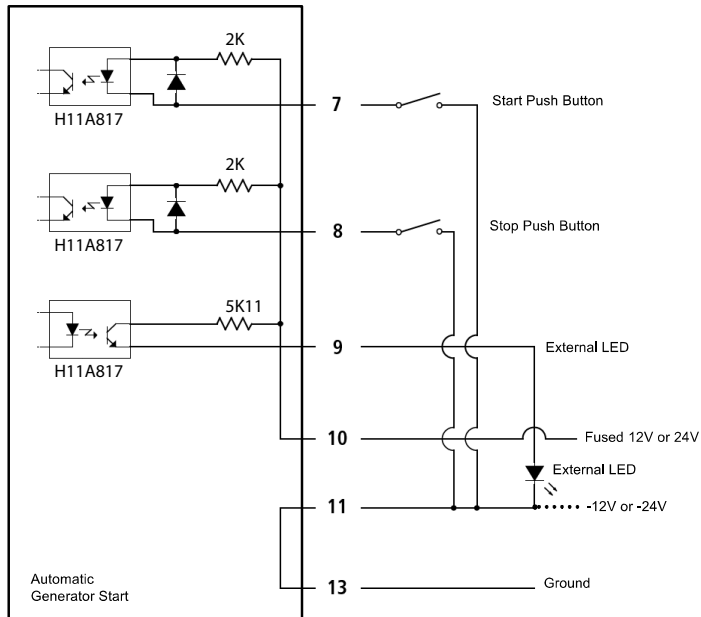

**Figure 23** External ON/OFF Switch and LED Wiring Diagram

## Connecting the Wiring Harness to the AGS

After all the external connections have been wired to the wiring harness, the connector on the wiring harness must be plugged into the 20-contact connector on the AGS.

### To connect the wiring harness to the AGS:

- ◆ With the click-tab on the wiring harness connector on top (away from the mounting surface), insert the wiring harness connector into the 20-contact connector on the AGS until the tab clicks into place.

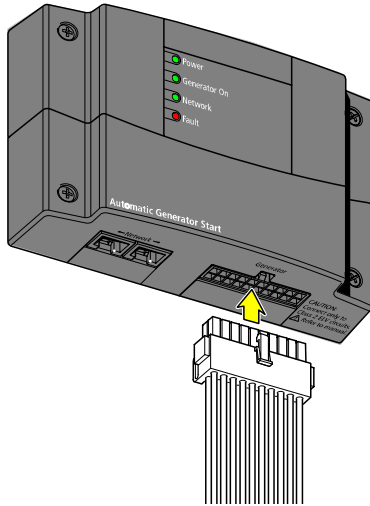

**Figure 24** AGS External Connections

## Connecting the AGS to the Xanbus Network

### CAUTION

#### EQUIPMENT DAMAGE

Connect only to other Xanbus-enabled devices.

Although the cabling and connectors used in this network system are the same as those used for Ethernet, this network is not an Ethernet system. Equipment damage may result from attempting to connect a Xanbus-enabled device to an Ethernet system.

**Failure to follow these instructions can damage the unit and/or damage other equipment.**

To connect the AGS to the Xanbus network, plug a Xanbus network cable (standard straight-through Ethernet cable—CAT 5e) into one of the network ports on the bottom panel of the AGS. Connect the other end of that same cable to the next Xanbus-enabled component in the chain. See Figure 25. For the location of the ports on the AGS, see Figure 5 on page 9

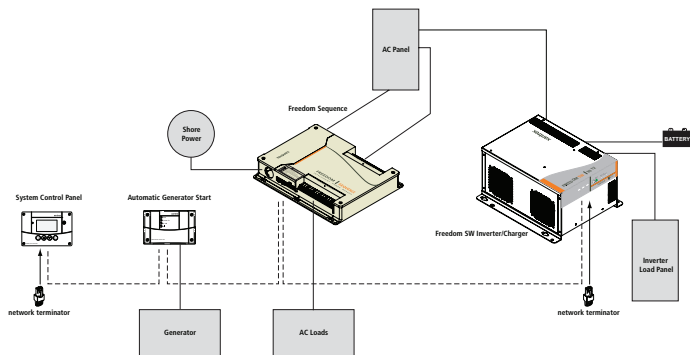

**Figure 25** Xanbus Network Example

If the AGS is being installed on an existing Xanbus system, the system must first be put into Standby. See “Putting the AGS in Standby Mode” on page 67.

Depending on the layout of the Xanbus system, the following options are available for the other network connector on the AGS:

- A second network cable
- A network terminator (when the AGS is the last device at one end of the network)

## Verifying Power Is Available

When the AGS has been installed properly, the Power and Network indicator lights illuminate.

If one or both lights are out, check the network connections. Check the Xanbus to ensure it has battery power. Check to make sure the other devices in the network, such as the Xanbus System Control Panel (SCP), are responding to confirm the network is still active.

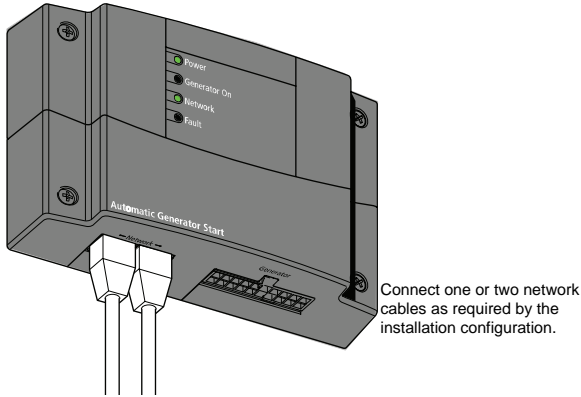

Figure 26 Connecting the Xanbus System Control Panel (SCP)

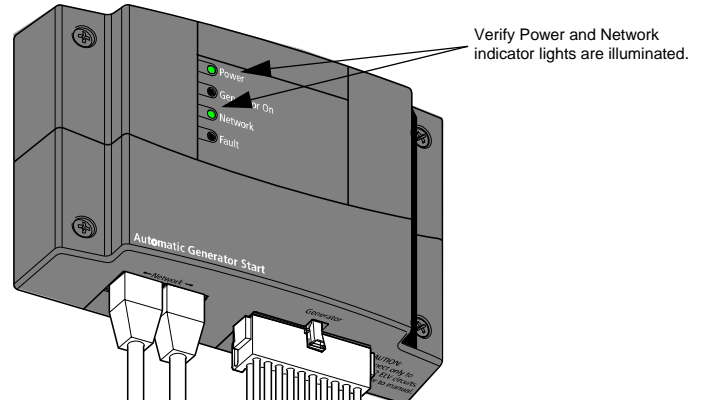

Figure 27 Verifying Power is Available

# Configuration of the Xanbus AGS

## Overview

The AGS has a number of settings that must be configured to ensure that the generator starts and stops under the appropriate conditions and at the appropriate time. The AGS is configured using the Xanbus System Control Panel (SCP).

The Freedom SW System Home Screen on the Xanbus System Control Panel (SCP) displays basic system operational status. On the lower left corner of the Freedom SW System Home Screen, there is an arrow that points to the **Enter** Button below the display. Pressing the **Enter** Button when the Freedom SW System Home Screen is displayed will take the system to the Select Device Menu.

The AGS Menu is accessed from the Select Device menu screen. All configurable settings, generator mode, fault clearing, and device information is provided in the AGS Menu.

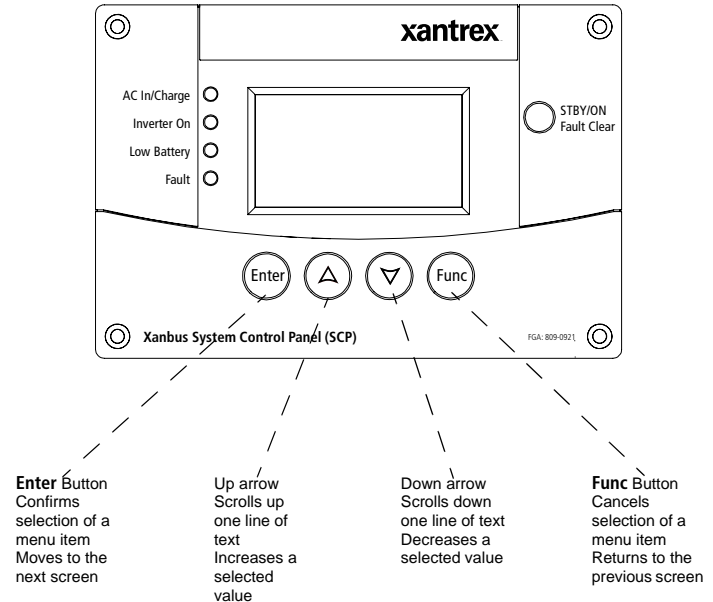

**Figure 28** Xanbus System Control Panel (SCP) Navigation Buttons and Freedom SW System Home Screen

# Accessing the AGS Menu

Use the Xanbus AGS Menu to change configuration settings, set operating mode, clear fault warnings, and view device information.

To access the Xanbus AGS Menu, start from the Xanbus System Home Screen.

To view the Select Device Menu, press Enter.

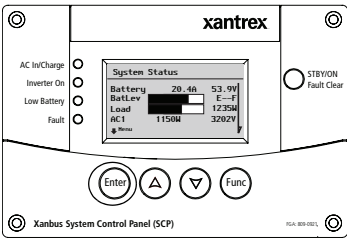

To select the AGS Menu, use the arrow buttons to highlight AGS "XAGS". Press Enter to select the AGS Menu.

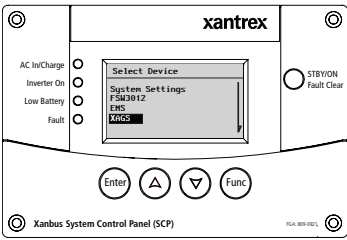
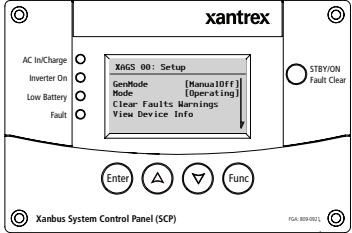

Figure 29 Accessing the AGS Menu

To change operational settings on the AGS Menu:

1. Use the arrow buttons to select the desired operation.
2. Press Enter to highlight the current value for that setting. Asterisks (\*) indicate the last value set.
3. Use the arrow buttons to change the value. Holding an arrow button down without releasing it will scroll through the values quickly.
4. Press Enter to select the value.
5. Press Func twice to return to the Freedom SW System Home Screen.

See Figure 31.



Auto Gen Start Menu

To access the advanced settings to configure specific operational parameters:

Press the Enter button and the Up and Down Arrow Buttons at the same time.

See Figure 32.

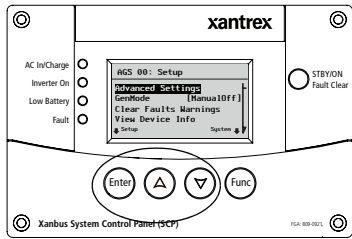

Figure 30 Changing Settings

# The Xanbus Automatic Generator Start (AGS) Menu

The Xanbus Automatic Generator Start (AGS) menu provides the ability to configure the changeable parameters, select the generator's operating mode, clear fault warnings and view device information.

The Xanbus Automatic Generator Start (AGS) Menu Home Screen is divided into five sections.

- Advanced Settings (Configuration Settings)
- GenMode (Manual on/Manual off/Automatic)
- Mode of Operation (Operating/Standby)
- Clear Fault Warnings
- View Device Info

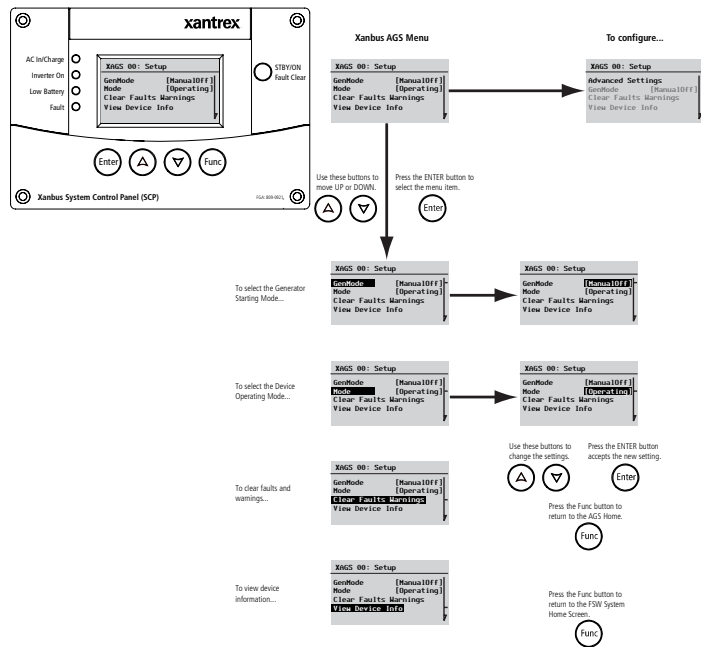

Figure 31 AGS Basic Menu Contents



When the AGS Home Screen is first displayed, the menu defaults to the GenMode Menu. If configuration changes need to be made, the Configuration Menu can be accessed by pressing the **Enter**, Up arrow, and Down arrow buttons all at same time to access the Advanced Settings.

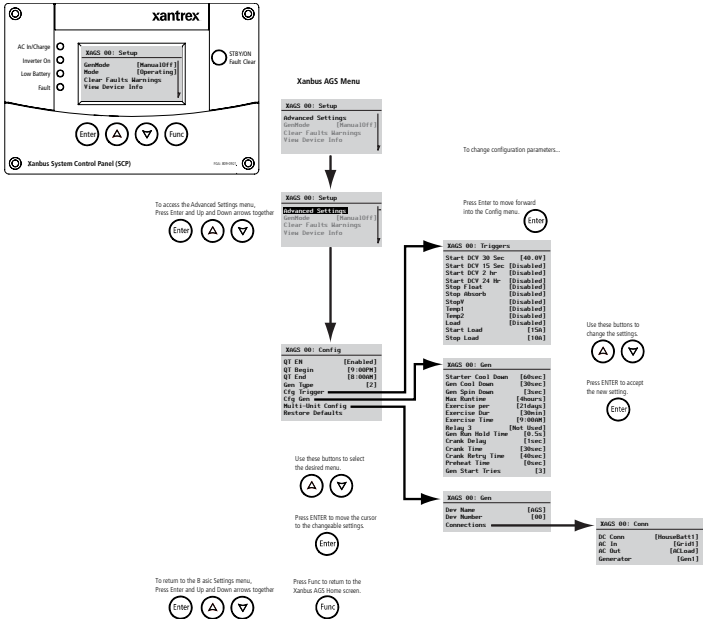

Figure 32 AGS Configuration Menu Contents

## The Configuration Menu

The Configuration Menu is where specific start-stop parameters are set. This menu contains the following settings:

- "QT En"
- "QT Begin"
- "QT End"
- "Gen Type"
- "Cfg Trigger"
- "Cfg Gen"
- "Restore Defaults"

## QT En

**Full name** Quiet Time Enable

**Purpose** "QT En" enables or disables the Quiet Time functionality of the AGS. Quiet time refers to a period of time when the generator should not run.

**Dependencies** "QT En" requires the AGS to be in Automatic mode. Setting "QT En" to [Enable] requires that parameters be set for the "QT Begin" and "QT End".

Value	Description
Enabled/Disabled	Enables or disables the Quiet Time functionality.

**When to use** Set "QT En" to [Enabled] when there is a period of time when it is not desired for the generator to run. The AGS will ignore all automatic start triggers during the time set in "QT Begin" and "QT Begin".

When there are no preferences or restrictions for when the generator should run, set "QT En" to [Disabled]. When [Disabled] is selected, the AGS will ignore the times set for "QT Begin" and "QT End".

**Considerations** Quiet Time prevents the automatic starting of the generator regardless of battery condition.

**IMPORTANT:** If quiet time is set for overnight, be aware that overnight battery drain can be significant as it may be necessary to use the inverter and batteries to supply AC Power without the help of a generator. Therefore, it is important to conserve battery power during this time. Minimize the use of interior lights and set thermostat temperature lower to prevent the furnace from coming on at night during cool weather. Set thermostats higher to prevent air conditioning coming on at night during warm weather.

Sometimes automatic start or automatic stop triggers may overlap with the beginning and end of quiet time. Three different quiet time scenarios affect when the generator stops and starts.

1. If quiet time begins after the AGS has started the generator, the generator will stop. If the condition that started the generator is still present when quiet time ends, the generator will restart.
2. If a condition that requires starting the generator occurs during quiet time, the AGS will ignore it until quiet time ends. If the condition still exists at the end of quiet time, the AGS will start the generator.
3. If the running generator stops when quiet time begins and a condition that requires stopping the generator occurs during quiet time, the generator will not restart when quiet time ends.

## QT Begin

**Full name** Quiet Time Begin

**Purpose** "QT Begin" defines the start of quiet time.

**Dependencies** "QT Begin" functions only if the AGS is in Automatic mode. This setting requires "QT En" be set to [Enabled].

Ensure the clock on the Xanbus System Control Panel (SCP) is set to the correct local time.

Value	Description
12:00AM to 11:59PM (12-hour clock)	At the time set for "QT Begin", the generator will stop (if it is running) and not be able to start again until the time set for "QT End". It ignores all automatic start triggers during the time period between "QT Begin" and "QT End".
00:00 to 23:59 (24-hour clock)	

## QT End

**Full name** Quiet Time End

**Purpose** "QT End" is a changeable setting that defines the end of quiet time.

This setting also requires a setting for "QT Begin".

**Dependencies** "QT End" functions only if the AGS is in Automatic mode. This setting requires "QT En" be set to [Enabled] and also requires a setting for "QT Begin".

Ensure the clock on the Xanbus System Control Panel (SCP) is set to the correct local time.

Value	Description
12:00AM to 11:59PM (12-hour clock) 00:00 to 23:59 (24-hour clock)	At the time set for "QT End" the AGS will be able to automatically start the generator again. If a start trigger has occurred during quiet time and is still active, the generator will start immediately after quiet time ends.

## Gen Type

**Full name** Generator Type

**Purpose** "Gen Type" selects the starting requirements of the generator. The starting requirements determine how the AGS must be wired to the generator's starting system. For more information, see "Connecting the Generator" on page 14 or Appendix B.

---

**IMPORTANT:** "Gen Type" can only be changed after the system is put into Standby. See "Putting the AGS in Standby Mode" on page 67.

---

**Table 4** Generator Type Descriptions

Option	Description	
	Mode	For Technical Details, see. <sup>a</sup>
Type 1	GlowStop	page 15
Type 2	GlowStop with no preheat	page 16
Type 3	GlowStop with shutdown bypass	page 17
Type 4	StartStop with Relay 3 prime	page 18
Type 5	StartStop with Relay 3 preheat	page 19
Type 6	GlowStop with normally closed RunStop contact	page 20
Type 7	Run with preheat	page 21
Type 8	Run with no preheat	page 22
Type 9	StartStop with Relay 3 preheat and shutdown bypass	page 23
Type 10	StartStop	page 24
Type 11	MomentaryRun	page 25

**Table 4** Generator Type Descriptions

Description		
Option	Mode	For Technical Details, see. <sup>a</sup>
Type 12	GlowStop with no preheat	page 26
Type 13	PulseStop with Relay 3 preheat	page 27
Type 14	Run with no preheat and no switched B+ requirement	page 28

a. See "Appendix B: Relay Timing" on page 82 for additional information.

**When to use** Use this setting after installing the AGS hardware. Selecting a suitable "Gen Type" automatically configures the AGS to work with the ignition system and starting requirements of the generator. Consult the generator manual or contact the generator's manufacturer for specific generator starting requirements.

**Outcomes** Selecting a "Gen Type" from the list automatically configures the following settings:

- Preheat time
- Preheat end to crank delay time
- Crank time
- Crank retry time
- Starter cool down time
- Generator cool down
- Generator spin down time
- Generator run signal hold time
- Start tries.

If the presets will not work with the desired generator, it may be necessary to manually configure some of the settings listed above using information from the generator manufacturer. These settings can be changed in the CfgGen Menu on page 53.

### Cfg Trigger

The "Cfg Trigger" menu contains the settings for automatically starting and stopping the generator. This menu allows the adjustment of the default settings for battery voltage, thermostat ON/OFF signals, inverter load, and battery charging stage.

There are three classes of triggers: charger-based, thermostat-based, and inverter load-based. If the generator is started by a trigger in one class, a stop condition must also be set in order for the generator to stop. For example for charger triggers, if the generator is started by the "Start DCV 30 sec" condition, any of the accompanying stop triggers "Stop Float", "Stop Float" and "Stop V" can be used to stop it.

If at least one start trigger is enabled in two or all three trigger classes, the first trigger to be true will start the generator. Conversely, the last stop trigger to be met will stop the generator.

Changing the default settings is advised for experienced users or users who have consulted service personnel.

---

**IMPORTANT:** The Auto Gen Start mode must be set to Manual Off before any start trigger parameters are set.

---

The "Cfg Trigger" menu contains the following items:

#### Charger Triggers:

- "Start DCV 30 sec"
- "Start DCV 15 min"
- "Start DCV 2 hr"
- "Start DCV 24 hr"
- "Stop Float"
- "Stop Absorb"
- "Stop V"

#### Thermostat Triggers:

- "Temp1"
- "Temp2"

#### Inverter Load Triggers:

- "Load"
- "Start Load"
- "Stop Load"

## Start DCV 30 sec

**Full Name** Starting Battery Voltage—30 seconds

**Purpose** The "Start DCV 30 sec" trigger enables the AGS to start the generator whenever the battery voltage reaches or drops below a pre-set voltage for longer than 30 seconds.

The AGS will stop the generator when the stop trigger is provided ("Stop V", "Stop Absorb", or "Stop Float").

**Dependencies** The "Start DCV 30 sec" trigger requires the AGS to be in Automatic mode and needs the "Stop Absorb" or "Stop Float" trigger be enabled or a parameter to be set for the "Stop V" trigger.

Values	Default
Disabled, 4.0 V to 60.0 V (increments of 0.1 V)	11.3 V

**Considerations** If the voltage trigger is set too high, the generator will start more frequently than is convenient.

If the voltage trigger is set too low, the batteries may be damaged by repeated cycles of excessive discharge. The generator running time necessary to charge the batteries may exceed "Max Run Time" and use too much fuel in the process.

If using the Xanbus Low Batt Cut Out voltage setting to trigger a start-on-voltage setting on the AGS, be sure to set the AGS voltage trigger higher than the Xanbus Low Batt Cut out voltage. Otherwise the inverter output turns off and then back on when the generator auto-starts.

If using an automatic generator starting system with the start trigger set to the same voltage as the LBCO voltage, do not set the LBCO Delay for less than the amount of time it takes the generator to start and connect. Otherwise, inverter output turns off and then back on when the generator auto-starts.

**Battery Voltage Information** Battery voltage can be monitored from the System screen or the inverter/charger menu.

If "Stop Float" or "Stop Absorb" has been enabled, the generator will stop when the Float or Absorption stages of the battery charging have begun.

If the "Stop V" is used, the generator will stop when the battery voltage reaches the parameter set in this trigger, regardless of whether the batteries are charged.

### Start DCV 15 min

**Full Name** Starting Battery Voltage—15 minutes

**Purpose** The **"Start DCV 15 min"** trigger enables the AGS to start the generator whenever the battery voltage reaches or drops below a pre-set voltage for longer than 15 minutes.

The AGS will stop the generator when the battery voltage has risen to the **"Stop V"**, or when the batteries have been recharged to the Absorption or Float stage.

**Dependencies** The **"Start DCV 15 min"** trigger requires the AGS to be in Automatic mode and needs the **"Stop Absorb"** or **"Stop Float"** trigger be enabled or a parameter to be set for the **"Stop V"** trigger.

If the **"Stop V"** is used, the generator will stop when the battery voltage reaches the parameter set in this trigger, regardless of whether the batteries are charged.

Values	Default
Disabled, 4.0V to 60.0V	Disabled

**Considerations** If the voltage trigger is set too high, the generator will start more frequently than is convenient.

If the voltage trigger is set too low, the batteries may be damaged by repeated cycles of excessive discharge. The generator running time necessary to charge the batteries may exceed **"Max Run Time"** and use too much fuel in the process.

**Battery Voltage Information** Battery voltage can be monitored from the System screen or the inverter/charger menu.

If **"Stop Float"** or **"Stop Absorb"** has been enabled, the generator will stop when the Float or Absorption stages of the battery charging have begun.



## Start DCV 2 hr

**Full name** Starting Battery Voltage—2 hours

**Purpose** The "Start DCV 2 hr" trigger enables the AGS to start the generator whenever the battery voltage reaches or drops below a pre-set voltage for longer than 2 hours.

**Dependencies** The "Start DCV 2 hr" trigger requires the AGS to be in Automatic mode and needs the "Stop Float" or "Stop Absorb" trigger be enabled or a parameter to be set for the "Stop V" trigger.

Values	Default
Disabled, 4.0 V to 60.0 V	Disabled

**Considerations** If the voltage trigger is set too high, the generator will start more frequently than is convenient.

If the voltage trigger is set too low, the batteries may be damaged by repeated cycles of excessive discharge. The generator running time necessary to charge the batteries may exceed "Max Run Time" and use too much fuel in the process.

**Battery Voltage Information** Battery voltage can be monitored from the System screen or the inverter/charger menu.

If "Stop Float" or "Stop Absorb" has been enabled, the generator will stop when the Float or Absorption stages of the battery charging have begun.

If the "Stop V" is used, the generator will stop when the battery voltage reaches the parameter set in this trigger, regardless of whether the batteries are charged.

## Start DCV 24 hr

**Full name** Starting Battery Voltage—24 hours

**Purpose** The "Start DCV 24 hr" trigger enables the AGS to start the generator whenever the battery voltage reaches or drops below a pre-set voltage for longer than 24 hours.

**Dependencies** The "Start DCV 24 hr" trigger requires the AGS to be in Automatic mode and needs the "Stop Absorb" or "Stop Float" trigger be enabled or a parameter to be set for the "Stop V" trigger.

Values	Default
Disabled, 4.0 V to 60.0 V	Disabled

**Considerations** If the voltage trigger is set too high, the generator will start more frequently than is convenient.

If the voltage trigger is set too low, the batteries may be damaged by repeated cycles of excessive discharge. The generator running time necessary to charge the batteries may exceed "Max Run Time" and use too much fuel in the process.

**Battery Voltage Information** Battery voltage can be monitored from the System screen or the inverter/charger menu.

If "Stop Float" or "Stop Absorb" has been enabled, the generator will stop when the Float or Absorption stages of the battery charging have begun.

If the "Stop V" is used, the generator will stop when the battery voltage reaches the parameter set in this trigger, regardless of whether the batteries are charged.

### Stop Float

**Full name** Stop at Float Charge Stage

**Purpose** The "**Stop Float**" trigger allows the AGS to stop the generator when the inverter/charger has recharged the batteries to the Float stage.

Values	Default
Disabled, Enabled	Enabled

**Considerations** "**Stop Float**" or "**Stop Absorb**" would typically be used if the generator was started due to a low-battery voltage setting.

"**Stop Float**" is the recommended setting if it is desired that the generator charge the batteries completely. This will result in somewhat longer run times. However, if the generator is the primary charging source, charging them to the Float stage every time will provide longer battery life.

For more information on battery charging, see the Freedom SW Inverter/Charger Owner's Guide.

### Stop Absorb

**Full name** Stop at Absorption Charge Stage

**Purpose** The "**Stop Absorb**" triggers enables the AGS to stop the generator when the inverter/charger has recharged the batteries to the Absorption stage.

Values	Default
Disabled, Enabled	Disabled

**Considerations** Set "**Stop Absorb**" if it's desired to only deliver a partial charge to the batteries. The AGS will start and run the generator until the inverter/charger charges the batteries through the Bulk charge stage (restoring the batteries between roughly 75% and 90% of their full charge). The AGS stops the generator when the inverter/charger determines the batteries have reached the Absorption charge stage.

Because Stop Absorption will shut down the generator before the batteries are fully charged, it is recommended to use it only if there is an alternate charging source, such as wind or PV, which can complete the charge. If the generator is the only charging source, Stop Absorption will leave the batteries consistently undercharged and may shorten the battery life. Alternately, Stop Absorption can be useful during utility outages, when it is desired to keep the generator run time to a minimum, but are expecting a full recharge once the power is restored.

For more information on battery charging, see Freedom SW Inverter/Charger Owner's Guide.

## Stop V

**Full name** Stopping Battery Voltage

**Purpose** The **"Stop V"** trigger enables the AGS to stop the generator whenever the battery voltage reaches a pre-set DC voltage. Whenever the generator starts automatically based on the Starting Battery Voltage, it will shut off once the Stopping Battery Voltage has been reached.

**Dependencies** The **"Stop V"** trigger requires the AGS to be in Automatic mode and needs a parameter to be set for one of the Start DCV triggers.

Actual battery voltage can be monitored from the Freedom SW System Home screen on the Xanbus System Control Panel (SCP).

For more information on battery charging, see the Freedom SW Inverter/Charger Owner’s Guide.

Values	Default
Disabled, 14.0 V to 60.0 V (increments of 0.1 V)	Disabled

**Considerations** The **"Stop V"** setting is most useful when you want the inverter/charger to give the batteries a quick, basic charge. If using this mode, it is recommended to run a complete charge or equalize cycle once in a while to restore the battery. To give the batteries a more complete, consistent charge, use the **"Stop Float"** setting. This will result in longer generator run times.

If **"Stop V"** is set too high, the generator may run for too long.

If **"Stop V"** is set too low, the AGS will stop the generator before the inverter/charger has charged the batteries.

If **"Stop Float"** or **"Stop Absorb"** have been enabled, the AGS will stop the generator if the Float or Absorption stages of the battery charging have begun.

### Temp1

**Full name** Thermostat 1

**Purpose** The "Temp1" trigger enables the generator to start in response to a signal from a thermostat. With "Temp1" set to [Enabled], the AGS will start the generator to help power the item controlled by that thermostat.

Values	Default
Disabled, Enabled	Disabled

**When to use** Enable "Temp1" if a thermostat is available that controls a component that has a high-power requirement such as a furnace or an air conditioning system.

**Considerations** If "Temp1" is enabled, the generator will start in response to a signal from the thermostat. Everything related to setting the thermostat must be done on the thermostat. For example: setting the temperature at which the furnace or air conditioning system comes on must be done on the thermostat. There are no thermostat temperature settings on the AGS or the Xanbus System Control Panel (SCP).

If "Temp1" is disabled, the component connected to that thermostat will require that the generator be started manually in order for that component to have power. Otherwise, the component will need to be connected to another AC input source.

### Temp2

**Full name** Thermostat 2

**Purpose** "Temp2" is intended to be used when the AGS is connected to a second thermostat. All information and procedures for "Temp1" also apply for "Temp2".

Values	Default
Disabled, Enabled	Disabled

## Load

**Full name** Enable Inverter Load Start and Stop Triggers

**Purpose** The "Load" trigger enables or disables the Start on Inverter Load Current and Stop on Inverter Load Current functionality of the AGS. This function enables the generator to start and stop based on the current being drawn on the inverter by the loads. See "Start Load" and "Stop Load".

**Dependencies** The "Load" trigger requires the AGS to be in Automatic mode and needs parameters to be set for both the "Start Load" and "Stop Load" triggers.

Value	Default
Disabled, Enabled	Disabled

**IMPORTANT:** This function is intended to protect the batteries from rapid drain. It is not intended to protect the inverter against overload.

## Start Load

**Full name** Start on Inverter Load Current

**Purpose** The "Start Load" trigger enables the generator to start at a specified AC load (current draw) on the inverter. This current draw must be present for 5 minutes before the generator will start. The generator will assist the inverter with powering the AC load.

**Dependencies** The "Start Load" trigger requires the AGS to be in Automatic mode and the "Load" trigger to be set to ON. It also needs to have a stopping value set in the "Stop Load" trigger.

Values	Default
10.0 A to 33.0 A (increments of 1A)	10.0 A

**Considerations** Change this setting if there are certain "peak" times of power usage or if power demands consistently exceed the output of the inverter.

If "Load" is set to [Enabled], the generator will start in response to the "Start Load" setting unless the AGS is in a Quiet Time period.

The inverter load current can be monitored on the System screen.

If "Start Load" is set too high, the AGS may not start the generator in time to recharge the batteries before the batteries are drained by the AC load. In addition, if "Start Load" is set too high, the inverter may shut down due to an overload condition.

If "Start Load" is set too low, the AGS may start the generator too frequently, wasting fuel in the process.

### Stop Load

**Full name** Stop on Inverter Load Current

**Purpose** The "**Stop Load**" trigger enables the AGS to stop the generator when the AC load falls below a specific level for 1 minute. The "**Stop Load**" setting applies to situations when the AGS has started the generator to assist the inverter with powering the AC load.

**Dependencies** The "**Stop Load**" trigger requires the AGS to be in Automatic mode and the "**Load**" trigger to be set to [Enabled]. It also needs to have a value starting value set in the "**Start Load**" trigger.

Values	Default
7.0 A to 28.0 A (increments of 1 A)	7.0 A

# Cfg Gen

The "Cfg Gen" menu provides the means to customize the following settings if the generator being used doesn't conform to one of the preset generator types or if an exercise period needs to be scheduled.

The Generator Configuration menu contains the following items:

- "Starter Cool Down"
- "Gen Cool Down"
- "Gen Spin Down"
- "Max Run Time"
- "Exercise Per"
- "Exercise Dur"
- "Exercise Time"
- "Relay3"
- "Gen Run Hold Time"
- "Crank Delay"
- "Crank Time"
- "Crank Retry Time"
- "Preheat Time"
- "Gen Start Tries"

## Starter Cool Down

**Purpose** The Starter Cool Down setting allows an interval to be set between start attempts if the generator fails to start on the first attempt. This time period allows the start motor to cool sufficiently before the AGS signals it to begin cranking again.

Values	Default
1s to 250s (increments of 1s)	60s

**When to use** This setting is automatically configured when a "Gen Type" is selected for the generator. Customize the "Starter Cool Down" trigger on the advice of the generator manufacturer or authorized service personnel.

### Gen Cool Down

**Purpose** The Gen Cool Down setting allows an interval to be set between a generator stop trigger occurring and the AGS actually stopping the generator. This setting is used in Freedom SW system to unload the generator before the AGS shuts it down. When a stop trigger occurs, the AGS enters a Generator cool down state where it continues to run the generator for the specified time period. At the same time the Freedom SW Series Inverter/Charger will disconnect the generator when it detects the AGS in Generator Cool Down, allowing the generator operate unloaded and cool down before it is shut down.

This helps improve reliability of the generator by reducing temperature peaking due to abrupt shut down of a loaded generator. It also reduces the probability of the generator backfiring that typically happens when the generator is abruptly shutdown while under heavy load. Gen Cool Down applies to all stop triggers namely Stop V, Stop Load, Stop Float, Stop Absorb, Stop Load, and Manual Off.

Values	Default
1s to 90s (increments of 1s)	30s

**When to use** This setting is automatically configured when a “Gen Type” is selected for the generator. Customize the “Gen Cool Down” trigger on the advice of the generator manufacturer or authorized service personnel.

### Gen Spin Down

**Purpose** The Gen Spin Down setting allows an interval to be set between a generator stop signal being sent at the end of a Gen Cool Down cycle and the AGS changing the Generator State to “stopped.” This setting is used in the Freedom SW System to allow the generator to completely stop, thereby reducing its output voltage to zero and pulling the B+ signal low before the Freedom SW Series Inverter/Charger can qualify and transfer AC power.

This helps the system operate properly in cases where the generator does not immediately stop when the stop signal is sent to the AGS. Gen Spin Down applies to all stop triggers—Stop V, Stop Load, Stop Float, Stop Absorb, Stop Load, and Manual Off.

Values	Default
1s to 900s (increments of 1s)	3s

**When to use** This setting is automatically configured when a “Gen Type” is selected for the generator. Customize the “Gen Spin Down” trigger on the advice of the generator manufacturer or authorized service personnel.



## Max Run Time

**Full name** Maximum Generator Run Time

**Purpose** "Max Run Time" allows a limit to be set on how long the generator will run. This setting overrides any automatic start triggers. For example, if the generator starts in response to low battery voltage, and the batteries are not fully charged before "Max Run Time" is reached, the generator will stop. In addition, when the generator is started manually from the Xanbus System Control Panel (SCP), the generator will stop when "Max Run Time" is reached.

When started with an external manual ON/OFF switch, the generator will not stop when it reaches "Max Run Time". The generator must be stopped with the external manual ON/OFF switch, or by using the System Control Panel to change the "GenMode" to ManualOff.

If the AGS reaches "Max Run Time", a warning message will appear on the Xanbus System Control Panel (SCP). The AGS will stop operating until the warning is acknowledged by pressing ENTER on the Xanbus System Control Panel (SCP).

Values	Default
0 hours to 24 hours (increments of 1hour)	8 hours

**Considerations** Adjust the "Max Run Time" if the maximum generator run time:

- exceeds the fuel capacity of the generator, or
- is not long enough to fully recharge the batteries under optimum conditions.

## Exercise Per

**Full name** Set Exercise Period (in days).

**Purpose** "Exercise Per" sets the minimum time interval between each running of the generator. If the generator has not been run within this time frame, the AGS will start the generator to "exercise" it.

The time interval defined by the Exercise Period setting begins with the last time the generator was run for any reason, not with the last time the AGS exercised the generator.

For example, setting an exercise period of 30 days would start the generator if it had not been run at all for 30 days.

**Dependencies** The "Exercise Per" trigger requires parameters to be set in the "Exercise Dur" and "Exercise Time" menu items.

Values	Default
0 (Off), 1day to 250days (increments of 1day)	21days

**Considerations** Generators need to run regularly in order to maintain mechanical health and performance. If the generator isn't needed and doesn't run, it is recommended that an Exercise period be set to keep the generator in good working condition.

If the generator runs frequently throughout the year, it may not need to be exercised. In that case, set the "Exercise Per" trigger to 0.

**IMPORTANT:** Consult the generator manual or a service representative from the generator's manufacturer for the recommended exercise period.

### Exercise Dur

**Full name** Exercise Duration (in minutes)

**Purpose** "Exercise Dur" sets how long the generator will run when it is exercised.

**Dependencies** The "Exercise Dur" trigger requires that any parameter other than "0" be set in "Exercise Per" and a time of day be set in the "Exercise Time" trigger.

Values	Default
1min to 250min	30min

---

**IMPORTANT:** Ensure that the Exercise Duration is not set for longer than the "Max Run Time" setting. Attempting to do so will generate a warning on the System Control Panel.

---

**IMPORTANT:** Consult the generator manual or a service representative from the generator's manufacturer for the recommended exercise duration.

---

### Exercise Time

**Purpose** "Exercise Time" sets the time of day that the AGS exercises the generator.

The "Exercise Time" trigger requires that any parameter other than "0" be set in "Exercise Per" and a value be set in the "Exercise Dur" trigger.

Values	Default
12:00AM to 11:50PM (12-hour clock) 00:00 to 23:50 (24-hour clock) (increments of 10 minutes)	9:00AM

**Considerations** If the Exercise Time is set, the generator will start at that time after being inactive for the Exercise Period.

If the Exercise Time occurs during Quiet Time, the generator will start when Quiet Time is over and run for the full amount of time set for "Exercise Dur".

### Relay3

**Purpose** "Relay3" sets the function of Relay 3 of the AGS. The function of Relay 3 affects contacts 19 and 20 of the 20-contact connector and external wiring harness.

Values	Default
NotUsed, Preheat, PreheatSDByp	NotUsed

**Considerations** Selecting a value for "Gen Type" automatically configures "Relay3".

It might be necessary to manually set "Relay3" according to the make and type of generator being used.

Some diesel generators require preheating of their glow plugs before start cranking. Setting "Relay3" to Preheat enables Relay 3 to perform this function in addition to Relay 1.

Some generators require Relay 3 to switch 12 volts to the glow plugs, while some generators require ground to be switched to the glow plugs.

"PreheatSDByp" stands for Preheat with Shutdown Bypass. Some generators require preheat on relay 3 to remain high for crank time and shutdown bypass period. See "GlowStop Mode" on page 84 for more details.

### Gen Run Hold Time

**Full name** Generator Run Signal Hold Time

**Purpose** "Gen Run Hold Time" specifies the length of time the generator run signal (or B+ or hour meter signal) must be active before the AGS considers the generator to be running and cranking can be stopped.

Some generators assert their run signal when they are being cranked, but before they have started. They also have varying delays from when cranking begins or ends to when the run signal is asserted or unasserted. The Run Hold Time is designed to accommodate these generators.

Values	Default
0.0s to 20.0s (increments of 0.5s)	0.5s

**Considerations** This setting is automatically configured when a "Gen Type" is selected for the generator. Manually change this setting only on the advice of the generator manufacturer or authorized service personnel.

If the installation is made without a B+ connection, it might be necessary to adjust the Gen Run Hold Time for the AGS to successfully start the generator. When the B+ signal is not connected, the AGS requests generator status from the Inverter/Charger, which might take longer that if the B+ signal was connected.

### Crank Delay

**Purpose** "Crank Delay" specifies the delay time from when the preheat relay is de-energized to when the Start Relay is energized (and cranking the starter motor). This is also referred to as the preheat-to-crank delay.

Values	Default
0s to 250s	1s

**Considerations** This setting is automatically configured when a "Gen Type" is selected for the generator. Manually change this setting only on the advice of the generator manufacturer or authorized service personnel.

### Crank Time

**Purpose** "Crank Time" specifies the maximum length of time the Start relay is engaged (and cranking the starter motor) for the first attempt to start the generator.

Values	Default
0s to 250s (increments of 1s)	30s

**Considerations** This setting is automatically configured when a "Gen Type" is selected for the generator. Manually change this setting only on the advice of the generator manufacturer or authorized service personnel.

### Crank Retry Time

**Purpose** "Crank Retry Time" specifies the length of time the Start relay is engaged (and cranking the starter motor) for the second and subsequent attempts to start the generator, in cases when the generator fails to start on the first attempt.

Values	Default
0s to 250s (increments of 1s)	40s

**Considerations** This setting is automatically configured when a "Gen Type" is selected for the generator. Manually change this setting only on the advice of the generator manufacturer or authorized service personnel.

### Preheat Time

**Purpose** "Preheat Time" specifies how long the Preheat relay is engaged during the start sequence. The preheat signal may be required for diesel generators with glow plugs or fuel priming for gas generators. The Preheat relay may be Relay 1 or Relay 3, depending on the "Relay3" setting or the Gen Type selected.

Values	Default
0s to 250s (increments of 1s)	0s

**Considerations** This setting is automatically configured when a "Gen Type" is selected for the generator. Manually change this setting only on the advice of the generator manufacturer or authorized service personnel.

## Gen Start Tries

"Gen Start Tries" specifies how many times the AGS will attempt to start the generator. On the first start try, the AGS cranks the starter motor for the Crank Time. If the generator does not start, on subsequent start tries, the AGS cranks the start motor for the Crank Retry Time.

Values	Default
1 to 10	3

**Considerations** This setting is automatically configured when a "Gen Type" is selected for the generator. Manually change this setting only on the advice of the generator manufacturer or authorized service personnel.

## Restore Defaults

The **"Restore Defaults"** returns the AGS to the factory default settings.

## GenMode

**Purpose** The **"GenMode"** menu item controls the current operating mode of the AGS.

Value	Description
Automatic	Automatic mode
ManualOn	Manual on mode
ManualOff	Manual off mode (default mode)

**Considerations** Use GenMode when it is necessary to switch between automatic generator control and manual generator control.

When the Xanbus system powers up all network-enabled devices, the AGS is in ManualOff mode. To enable automatic generator starts, the AGS must be put in "Automatic" mode.

## Automatic Mode

To have the AGS start and stop the generator automatically, select Automatic. The generator can start and stop automatically in response to low battery voltage, AC loads on the inverter, thermostat triggers, or exercise time. Automatic mode also has a Quiet Time feature, which prevents the generator from starting during evening hours or other inconvenient times (see "QT Begin" on page 41, "QT End" on page 42, and "Using Quiet Time" on page 66).

**Automatic Mode Overrides** When the AGS is in Automatic mode, several settings and conditions override automatic start and stop triggers. These overrides include, in order of priority:

- **Faults**—The AGS stops the generator when a fault occurs.
- **External Shutdown**—When the AGS is connected to a sensor or meter (a moisture detector, for example) wired to contacts 5 and 6 of the 20-contact connector, it stops the generator when the device is activated. See “Connecting an External Shutdown (optional)” on page 30.
- **External On/Off**—The generator is manually started or stopped with a switch wired to contacts 7 and 8 of the 20-contact connector. See “Connecting an External Manual ON/OFF Switch (optional)” on page 30. When started with an external manual ON/OFF switch, the generator will not stop when it reaches Max Run Time. The generator must be stopped using the external manual ON/OFF switch.
- **Max Run Time**—When the generator has exceeded its maximum run time, a warning message will appear on the Xanbus System Control Panel (SCP). The AGS will stop operating until the warning is acknowledged by pressing **Enter** on the Xanbus System Control Panel (SCP). See “Max Run Time” on page 55.
- **Manual On**—The generator is started by selecting Manual On mode.
- **Manual Off**—The generator is stopped by selecting Manual Off mode.

**Manual On Mode**

Selecting Manual On Mode overrides the automatic start settings and manually starts the generator. The generator will run until it is manually stopped or until it reaches its AGS-defined Maximum Run Time (see “Max Run Time” on page 55).

**Manual Off Mode**

Selecting Manual Off Mode overrides the automatic stop settings and manually stops the generator. Manual Off must be selected to stop the generator when the generator has been started manually. The AGS will not automatically start the generator again until “Automatic” is selected in the GenMode Menu.

---

**IMPORTANT:** The GenMode mode must be set to Manual Off before any start trigger settings can be changed.

---

### Mode

The **"Mode"** menu item is a device operating mode and provides the means to put the AGS in Standby Mode or return it from to Operating Mode.

The AGS Mode must be set to [Standby] before selecting a generator type. Selecting Standby stops the generator (if it is running).

While in Standby, the AGS “listens” to and reports its status to the network. It will not start the generator manual or automatically while in Standby.

### View Device Info

The **"View Device Info"** menu provides a means to view the Fault, Warning and Event logs. It is also where the settings can be restored to factory default settings.

### View Fault Log

**Purpose** The Fault Log displays the last 20 AGS faults for reference to assist the user in troubleshooting problems.

**When to use** Consult the Fault Log when troubleshooting or before seeking technical assistance.

### View Warning Log

**Purpose** The Warning Log displays the last 20 AGS warnings for reference.

**When to use** Consult the Warning Log when troubleshooting or before seeking technical assistance.

### View Event Log

**Purpose** The Event Log displays the last 20 AGS events for reference. Events can include:

- Starting and stopping the generator.
- Trigger events. See table below for a detailed list of trigger events.
- Changing the system mode.
- Changing the system clock.
- Commands to restore the default settings.

Event Displayed	Description of Event Trigger
NotOn	Generator is not running
LowBattV	Preset minimum battery voltage with associated time delay
CntctClosed	Activated thermostat 1 or 2
ACIHigh	Preset maximum inverter load current
Exercise	Preset exercise period, exercise time, and exercise duration
ManualOn	Started manually using System Control Panel
ExtOnviaAGS	Started by external switch connected to AGS
ExtOnviaGen	Started by switch connected to generator
UnableToStop	AGS has lost control of the running generator



# User Settings

Use this table to record any customized AGS settings for future reference.

**Table 5** Generator Configuration Settings, Values, Defaults, and User Settings

Setting	Values	Default	User Setting
<b>Main Menu Items:</b>			
GenMode	ManualOn, ManualOff, Automatic	ManualOff	
Mode	Operating/Standby	Operating	
<b>Configuration Menu Items:</b>			
"QT En"	Enabled, Off	Enabled	
"QT Begin"	12:00AM–11:59PM (12-hour clock) 00:00–23:59 (24-hour clock)	9:00PM (12-hour clock) 21:00 (24-hour clock)	
"QT End"	12:00AM–11:59PM (12-hour clock) 00:00–23:59 (24-hour clock)	8:00AM (12-hour clock) 8:00 (24-hour clock)	
"Gen Type"	Type 1 to Type 14	Type 2	
<b>Triggers Menu Items:</b>			
"Start DCV 30 sec"	Disabled, 4.0 V–60.0 V	11.3 V	
"Start DCV 15 min"	Disabled, 4.0 V–60.0 V	Disabled	
"Start DCV 2 hr"	Disabled, 4.0 V–60.0 V	Disabled	
"Start DCV 24 hr"	Disabled, 4.0 V–60.0 V	Disabled	
"Stop Float"	Enabled, Disabled	Disabled	
"Stop Absorb"	Enabled, Disabled	Enabled	
"Stop V"	Disabled, 4.0 V–65.0 V	Disabled	
"Temp1"	Enabled, Disabled	Disabled	

**Table 5** Generator Configuration Settings, Values, Defaults, and User Settings

Setting	Values	Default	User Setting
"Temp2"	Enabled, Disabled	Disabled	
"Load"	Enabled, Disabled	Disabled	
"Start Load"	10.0 A–33.0 A	10.0 A	
"Stop Load"	7.0 A–28.0 A	7.0 A	
<b>Generator Menu Items:</b>			
"Starter Cool Down"	1s to 250s (increments of 1s)	60s	
"Gen Cool Down"	0s to 90 s (increments of 1s)	30s	
"Gen Spin Down"	0s to 900s (increments of 1s)	3s	
"Max Run Time"	0hours–24 hours	8hours	
"Exercise Per"	0days (Off)–250days	21days	
"Exercise Dur"	1min–250min	30min	
"Exercise Time"	12:00AM–11:59PM (12-hour clock) 00:00–23:59 (24-hour clock)	9:00AM (12-hour clock) 9:00 (24-hour clock)	
"Relay3"	Preheat, WrmupCoolDn, Preheat SDByp, NotUsed	NotUsed	
"Gen Run Hold Time"	0.5s to 20s (increments of 1s)	0.5s	
"Crank Delay"	0s to 60s (increments of 1s)	0s	
"Crank Time"	0s to 250s (increments of 1s)	30s	
"Crank Retry Time"	0s to 250s (increments of 1s)	40s	
"Preheat Time"	0s to 250s (increments of 1s)	0s	
"Gen Start Tries"	1 to 10	3	

# Operation of the Xanbus AGS

## Accessing the AGS Home Screen

Use the AGS Home Screen to view basic operational status information for the generator. The AGS Home Screen displays the generator start settings (i.e., ManualOff), the generator state (running or stopped), the stop trigger, and the Generator signal.

Freedom SW System Home Screen

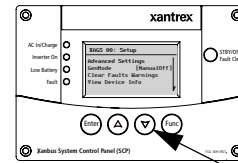

Press the Down Arrow button until the AGS Home Screen is displayed.

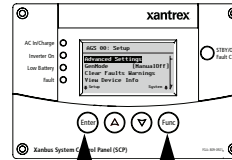

When the AGS Home screen is displayed, press the Enter button to view the AGS Setup Menu.

Press the Func button to return to the Freedom SW System Home Screen.

Figure 33 AGS Home Screen

## Starting and Stopping the Generator

Use the AGS to start or stop the generator manually using the Xanbus System Control Panel (SCP) or automatically in response to an electrical system condition.

### To set the AGS to start and stop the generator automatically:

1. On the AGS menu, highlight GenMode and press **Enter**.
2. Use the arrow button to select [Automatic].
3. Press **Enter**.

### To start the generator manually:

1. On the AGS menu, highlight GenMode and press **Enter**.
2. Use the arrow button to select [ManualOn].
3. Press **Enter**.

### To stop the generator manually:

1. On the AGS menu, highlight GenMode and press **Enter**.
2. Use the arrow button to select [ManualOff].
3. Press **Enter**.

**IMPORTANT:** To avoid AGS faults, try not to combine automatic and external manual starts and stops.

When the generator has been started automatically, allow it to stop automatically unless a situation occurs that requires the generator to be stopped urgently.

Likewise, if the generator has been started manually, ensure that it is stopped manually. Only the "Max Run Time" setting can automatically stop the generator after it has been started manually.

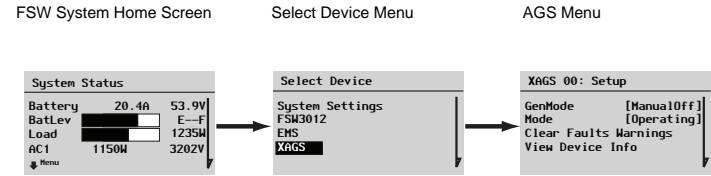

**Figure 34** Starting and Stopping the Generator

## Using Quiet Time

Use the Quiet Time feature to ensure that the AGS will not start the generator during the night or during times that conflict with local noise restrictions.

Using Quiet Time involves three steps.

1. **"QT En"** must be set to [Enabled]. The default setting is [Enabled].
2. **"QT Begin"** must have an appropriate time set for Quiet Time to start on schedule. The default setting for **"QT Begin"** is [9:00 PM] or 21:00 if using a 24-hour clock.
3. **"QT End"** must have an appropriate time set for Quiet Time to stop on schedule. The default setting for **"QT End"** is [8:00 AM] or 8:00 on the 24-hour clock.

For more information about Quiet Time settings, see "QT En" on page 40, "QT Begin" on page 41, and "QT End" on page 42.

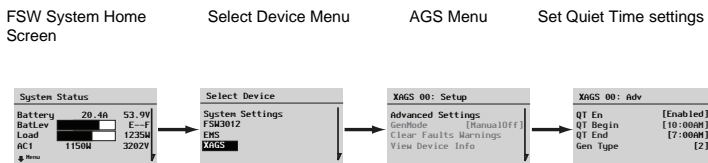

**Figure 35** Using the Quiet Time Feature

### To enable Quiet Time:

1. On the Auto Gen Start menu, use the arrow buttons to highlight **"QT En"**.
2. Press **Enter**.
3. Use the arrow buttons to select [Enabled].
4. Press **Enter**.

### To set the beginning of Quiet Time:

1. On the Auto Gen Start menu, use the arrow buttons to highlight **"QT Begin"**, then press **Enter**.
2. Use the arrow buttons to select the hour, then press **Enter**.
3. Use the arrow buttons to select the minutes, then press **Enter**. If the 24-hour clock is being used, go to step 5.
4. Use the arrow buttons to select AM or PM, then press **Enter**.
5. Press Exit twice to return to the System Home screen.

### To set the end of Quiet Time:

1. On the Auto Gen Start menu, use the arrow buttons to highlight **"QT End"**, then press **Enter**.
2. Use the arrow buttons to select the hour, then press **Enter**.
3. Use the arrow buttons to select the minute, then press **Enter**. If the 24-hour clock is being used, go to step 5.
4. Use the arrow buttons to select AM or PM, then press **Enter**.
5. Press Exit twice to return to the System screen.

# Modes of Operation

The AGS, like all other Xanbus-enabled devices, supports two modes, Operating and Standby. The AGS mode of operation must be set to Standby before selecting a Generator Type. Selecting Standby stops the generator (if it is running).

While in Standby, the AGS “listens” to and reports its status to the network. However, it will not start the generator manually or automatically while in Standby.

If the AGS is powered off while in Standby, it will be in Standby when it is powered on again.

The AGS can also be put in Standby using the system mode option under system settings. However, note that selecting Standby from system settings affects the behavior of the entire Freedom SW system. System mode Standby puts every Xanbus-enabled device in Freedom SW Power System into Standby.

**IMPORTANT:** If AGS Fault 201 “Unable to stop gen.” is active, the AGS cannot be put into Standby. Before Standby can be established, the generator must be stopped by its external switch and the fault must be cleared.

# Putting the AGS in Standby Mode

Use the Xanbus System Control Panel (SCP) to put the AGS into Standby mode.

To put the AGS in Standby Mode:

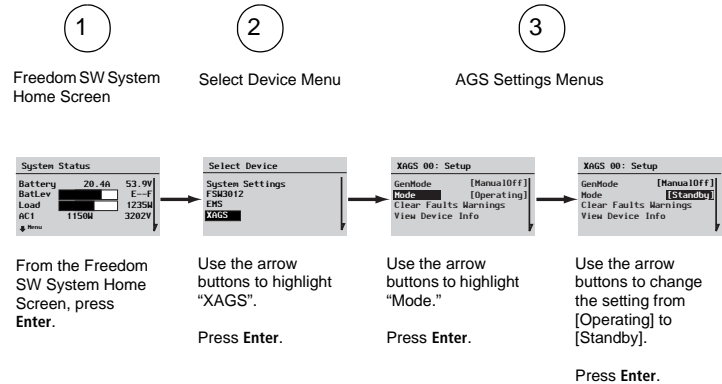

## Returning the AGS to Operating Mode

Use the Xanbus System Control Panel (SCP) to return the AGS to Operating mode.

To return the AGS to Operating Mode:

1

Freedom SW System Home Screen

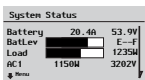

From the Freedom SW System Home Screen, press Enter.

2

Select Device Menu



Use the arrow buttons to highlight "XAGS".

Press Enter.

3

AGS Settings Menu



Use the arrow buttons to highlight "Mode".

Press Enter.

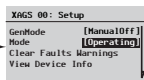

Use the arrow buttons to change the setting from [Standby] to [Operating].

Press Enter.

# Troubleshooting

Under certain conditions, the AGS generates a fault or warning message. These messages appear on the Xanbus System Control Panel (SCP).

**Acknowledging messages** When a fault or warning message appears, it will remain on the screen until it is acknowledged by pressing **Enter** on the Xanbus System Control Panel (SCP). This action removes the message from the screen, but does not clear the condition that caused the fault or warning.

Consult Table 6 and Table 7 for recommendations for resolving the fault after it has been acknowledged.

Warnings that are in the form of a Yes/No question can be acknowledged by pressing **Enter** for Yes and Exit for No.

**Self-clearing warnings** If unacknowledged, some warnings may clear themselves if the condition that generated the message goes away. For example, if the AGS fails to start the generator, warning message W202 appears. However, if the generator starts on the next start try, the message goes away.

**Clearing faults** To clear active AGS faults, highlight Clear Faults on the AGS menu and press **Enter**.

**Multiple faults and warnings** If several fault or warning messages occur before they can be acknowledged or cleared, they are displayed together on a fault list or a warning list. These lists contain messages from every Xanbus-enabled device, not just the AGS. Message details can be selected and viewed from the fault list or warning list.

## To view a message from a fault list or warning list:

1. On the list, use the arrow buttons to highlight the message to be viewed.
2. Press **Enter**.

The complete message appears.

To return to the fault list or warning list, press Exit.

To continue to the menu for the device that caused the fault or warning condition by pressing Exit.

Each time you return to the list after viewing a complete message, the viewed message is removed from the list.

If you have left the fault list or warning list, you can view them at any time from the System Settings menu.

## To view a fault list or warning list:

1. On the Select Device menu, highlight System and press **Enter**.
2. On the System Settings menu, highlight View Fault List or View Warning List.
3. Press **Enter**.

## Warning Reference Table

**Table 6** AGS Warning Messages

Warning Number	Message	Self-clearing?	Cause	Action
W200	Generator was stopped manually.	No	Generator was stopped by an external Manual Off switch.	Acknowledge the warning. To resume automatic starts and stops, change the AGS mode to [Automatic].
W201	Generator was started manually.	No	Generator was started by an external Manual On switch	Acknowledge the warning. To resume automatic starts and stops, change the AGS mode to [Automatic].
W202	Unable to start generator. AGS will try again.	Yes	The AGS tried, but could not start the generator.	No action required. The AGS will try to start the generator again until it reaches the maximum number of start tries.
W203	Manual Off: Max generator run time reached. Reset GenMode.	No	The generator has run for its maximum allowable time. The AGS has stopped the generator and changed the GenMode to [ManualOff].	Acknowledge the warning. Return the AGS to the desired GenMode [Automatic or ManualOn]. Ensure generator has fuel and is supplying the required power for battery charging and loads.

**Table 6** AGS Warning Messages (Continued)

Warning Number	Message	Self-clearing?	Cause	Action
W205	Generator started by its switch. Use its switch to stop.	Yes	The generator was started, but not by the AGS.	Check your generator. Stop it using the switch or control panel on the generator.
W206	Mismatched triggers. Enable stop trigger or disable start trigger.	No	You have set a start trigger, but not a corresponding stop trigger.	Acknowledge warning and set a stop trigger.
W207	Mismatched triggers. Enable start trigger or disable stop trigger.	No	You have set a stop trigger, but not a corresponding start trigger.	Acknowledge warning and set a start trigger.
W208	Automatic start and stop triggers not enabled. Configure triggers.	No	You are attempting to enter Automatic Mode without setting triggers.	Acknowledge warning and set start and stop triggers.



**Table 6** AGS Warning Messages (Continued)

Warning Number	Message	Self-clearing?	Cause	Action
<b>W209</b>	Gen external stop. Start gen via its control panel.	Yes	The generator has stopped, but not by the AGS. The generator may have run out of gas, or may have been shut off by a switch on the generator.	Check the generator's fuel level and mechanical condition, then start the generator manually (using the switch or control panel on the generator) to clear the warning.
<b>W250</b>	The selected value failed to change. Try again.	No	You have tried to change the Gen Type without putting the system into Standby first.	Put the system into Standby, change the Gen Type, then return the system to Operating mode.
			You have tried to set the "Exercise Dur" for longer than "Max Run Time," or "Max Run Time" for less than "Exercise Dur."	Ensure that "Max Run Time" is set for longer than "Exercise Dur."
<b>W500</b>	Network connection lost. Check connections.	Yes	The AGS has lost communications with the network because of a faulty connection or electronic signal disruption.	Check connection between the AGS and the network.

**Table 6** AGS Warning Messages (Continued)

Warning Number	Message	Self-clearing?	Cause	Action
<b>W501</b>	AGS has fixed memory problem and restored default settings.	No	The AGS encountered an internal memory problem upon startup. To remain operational, the AGS restored its default settings.	Acknowledge the warning and reset configurable settings if necessary.

## Fault Reference Table

When the AGS detects a fault condition, it stops the generator. The red Fault light also comes on, and the Xanbus System Control Panel (SCP) displays a fault message.

The AGS remembers the GenMode that it was in at the time it detected the fault. After you have cleared the fault, the AGS returns to its last known GenMode.

**Table 7** AGS Fault Messages

Fault Number	Message	Self-clearing?	Cause	Action
F200	Exceeded max number of start tries. Check gen, clear fault.	No	The AGS has tried and failed to start the generator. To prevent draining the start battery, the AGS will suspend further start attempts.	Check the generator's fuel level and start battery condition. Consult generator manual. Clear fault on System Control Panel screen to allow retry.
F201	Unable to stop gen. Stop gen via its control panel.	No	The AGS has lost contact with the generator or the generator did not stop after the AGS sent it a stop signal.	Change the AGS mode to Manual Off. If this fails to work, stop the generator with the external stop switch. Check generator. Return AGS to automatic mode to resume automatic starts and stops.

**Table 7** AGS Fault Messages

Fault Number	Message	Self-clearing?	Cause	Action
F203	Manual Off: Gen stopped by ext sensor. Reset GenMode.	No	An external sensor connected to the AGS has stopped the generator and put the AGS into Manual Off mode.	After the sensor connected to the external shutdown has deactivated, clear the fault and reset the AGS to the desired mode.
F500	Serial Number Failure, Service Required.	No	The silicon serial ID number has failed and the AGS has gone into Standby.	Call your dealer or Xantrex Technology USA Inc.
F501	Memory Failure, Service Required.	No	The AGS has suffered a non-volatile memory failure.	Call your dealer or Xantrex Technology USA Inc.
F505	Internal Failure, Service Required.	No	A controller fault has occurred and the AGS has gone into Standby.	Clear the fault. If the fault persists, call your dealer or Xantrex Technology USA Inc.

# Specifications

**NOTE:** Specifications are subject to change without prior notice.

## Electrical Specifications

Nominal input network voltage	12 Vdc
Maximum operating current	200 mA @ nominal input network voltage
Relay contact voltage rating	12 Vdc, 30 Vdc max.*
Maximum relay contact current	5 A DC*
Nominal 12/24 V thermostat input voltage	12 Vdc/24 Vdc* = On
Minimum 12/24 V thermostat input voltage	9.5 Vdc*
Maximum 12/24 V thermostat input voltage	30 Vdc*
Typical 12/24 V thermostat input current	14.6 mA @ 12 V
Nominal 12/24 V generator running B+ voltage	12 Vdc/24 Vdc*= On
Minimum 12/24 V generator running B+ voltage	9.5 Vdc*
Maximum 12/24 V generator running B+ voltage	30 Vdc*
Typical 12/24 V generator running B+ current	14.6 mA @ 12 V
Communication physical layer	2, CAN

## Electrical Specifications

Communication protocol	Xanbus
Maximum cable length	130 ft. (40 m)

## Environmental Specifications

Operating temperature	-4 to 122 °F (-20 to 50 °C)
Storage temperature	-40 to 185 °F (-40 to 85 °C)
Maximum case temperature	140 °F (60 °C)
Operating humidity	5 to 95%
Storage humidity	5 to 95%
Ignition protection	None

## Regulatory Approvals

Safety	CSA certified to CSA 107.1-01 and UL 458 4th Ed. including the marine supplement
EMC	FCC Part 15, Class B Industry Canada ICES-0003 Class B

## Physical Specifications

<b>Dimensions</b>	3 ¾ × 5 ¾ × 1 ½" (95.5 × 146 × 37 mm)
<b>Weight</b>	0.5 lb. (225 g)
<b>Mounting</b>	4 mounting screws
<b>Connectors</b>	2 × Xanbus: RJ45—8 pins 1 × 20-contact plug-type connector (Tyco Mate'n' Lok 2 connector)

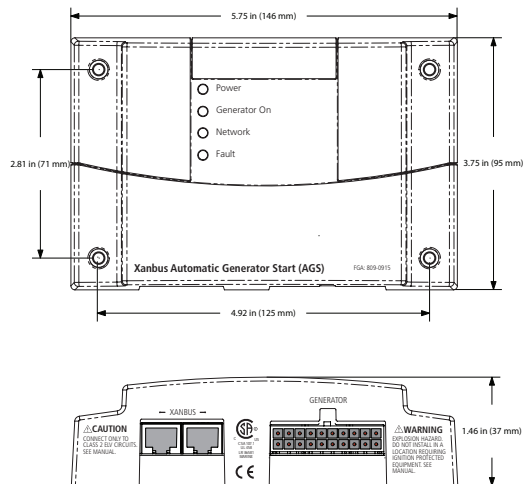

**Figure 36** Xanbus AGS Dimensions

# Warranty and Return Information

## Warranty

**What does this warranty cover and how long does it last?** This Limited Warranty is provided by Xantrex Technology USA Inc. (“Xantrex”) and covers defects in workmanship and materials in your Xanbus Automatic Generator Start (AGS). This warranty period lasts for 24 months from the date of purchase at the point of sale to you, the original end user customer, unless otherwise agreed in writing (the “Warranty Period”). You will be required to demonstrate proof of purchase to make warranty claims.

This Limited Warranty is transferable to subsequent owners but only for the unexpired portion of the Warranty Period. Subsequent owners also require original proof of purchase as described in “What proof of purchase is required?”

**What will Xantrex do?** During the Warranty Period Xantrex will, at its option, repair the product (if economically feasible) or replace the defective product free of charge, provided that you notify Xantrex of the product defect within the Warranty Period, and provided that Xantrex through inspection establishes the existence of such a defect and that it is covered by this Limited Warranty.

Xantrex will, at its option, use new and/or reconditioned parts in performing warranty repair and building replacement products. Xantrex reserves the right to use parts or products of original or improved design in the repair or replacement. If Xantrex repairs or replaces a product, its warranty continues for the remaining portion of the original Warranty Period or 90 days from the date of the return shipment to the customer, whichever is greater. All replaced products and all parts removed from repaired products become the property of Xantrex.

Xantrex covers both parts and labor necessary to repair the product, and return shipment to the customer via a Xantrex-selected non-expedited surface freight within the contiguous United States and Canada. Alaska,

Hawaii and outside of the United States and Canada are excluded. Contact Xantrex Customer Service for details on freight policy for return shipments from excluded areas.

**How do you get service?** If your product requires troubleshooting or warranty service, contact your merchant. If you are unable to contact your merchant, or the merchant is unable to provide service, contact Xantrex directly at:

Telephone: 1 800 670 0707

Fax: 1 800 994 7828

Website: [www.xantrex.com](http://www.xantrex.com)

Direct returns may be performed according to the Xantrex Return Material Authorization Policy described in your product manual. For some products, Xantrex maintains a network of regional Authorized Service Centers. Call Xantrex or check our website to see if your product can be repaired at one of these facilities.

**What proof of purchase is required?** In any warranty claim, dated proof of purchase must accompany the product and the product must not have been disassembled or modified without prior written authorization by Xantrex.

## Warranty and Return Information

---

Proof of purchase may be in any one of the following forms:

- The dated purchase receipt from the original purchase of the product at point of sale to the end user; or
- The dated dealer invoice or purchase receipt showing original equipment manufacturer (OEM) status; or
- The dated invoice or purchase receipt showing the product exchanged under warranty.

**What does this warranty not cover?** Claims are limited to repair and replacement, or if in Xantrex's discretion that is not possible, reimbursement up to the purchase price paid for the product. Xantrex will be liable to you only for direct damages suffered by you and only up to a maximum amount equal to the purchase price of the product.

This Limited Warranty does not warrant uninterrupted or error-free operation of the product or cover normal wear and tear of the product or costs related to the removal, installation, or troubleshooting of the customer's electrical systems. This warranty does not apply to and Xantrex will not be responsible for any defect in or damage to:

- a) the product if it has been misused, neglected, improperly installed, physically damaged or altered, either internally or externally, or damaged from improper use or use in an unsuitable environment;
- b) the product if it has been subjected to fire, water, generalized corrosion, biological infestations, or input voltage that creates operating conditions beyond the maximum or minimum limits listed in the Xantrex product specifications including but not limited to high input voltage from generators and lightning strikes;
- c) the product if repairs have been done to it other than by Xantrex or its authorized service centers (hereafter "ASCs");
- d) the product if it is used as a component part of a product expressly warranted by another manufacturer;
- e) component parts or monitoring systems supplied by you or purchased by Xantrex at your direction for incorporation into the product;
- f) the product if its original identification (trade-mark, serial number) markings have been defaced, altered, or removed;
- g) the product if it is located outside of the country where it was

purchased; and

- h) any consequential losses that are attributable to the product losing power whether by product malfunction, installation error or misuse.

## Disclaimer

### Product

THIS LIMITED WARRANTY IS THE SOLE AND EXCLUSIVE WARRANTY PROVIDED BY XANTREX IN CONNECTION WITH YOUR XANTREX PRODUCT AND IS, WHERE PERMITTED BY LAW, IN LIEU OF ALL OTHER WARRANTIES, CONDITIONS, GUARANTEES, REPRESENTATIONS, OBLIGATIONS AND LIABILITIES, EXPRESS OR IMPLIED, STATUTORY OR OTHERWISE IN CONNECTION WITH THE PRODUCT, HOWEVER ARISING (WHETHER BY CONTRACT, TORT, NEGLIGENCE, PRINCIPLES OF MANUFACTURER'S LIABILITY, OPERATION OF LAW, CONDUCT, STATEMENT OR OTHERWISE), INCLUDING WITHOUT RESTRICTION ANY IMPLIED WARRANTY OR CONDITION OF QUALITY, MERCHANTABILITY OR FITNESS FOR A PARTICULAR PURPOSE. ANY IMPLIED WARRANTY OF MERCHANTABILITY OR FITNESS FOR A PARTICULAR PURPOSE TO THE EXTENT REQUIRED UNDER APPLICABLE LAW TO APPLY TO THE PRODUCT SHALL BE LIMITED IN DURATION TO THE PERIOD STIPULATED UNDER THIS LIMITED WARRANTY.

IN NO EVENT WILL XANTREX BE LIABLE FOR: (A) ANY SPECIAL, INDIRECT, INCIDENTAL OR CONSEQUENTIAL DAMAGES, INCLUDING LOST PROFITS, LOST REVENUES, FAILURE TO REALIZE EXPECTED SAVINGS, OR OTHER COMMERCIAL OR ECONOMIC LOSSES OF ANY KIND, EVEN IF XANTREX HAS BEEN ADVISED, OR HAD REASON TO KNOW, OF THE POSSIBILITY OF SUCH DAMAGE; (B) ANY LIABILITY ARISING IN TORT, WHETHER OR NOT ARISING OUT OF XANTREX'S NEGLIGENCE, AND ALL LOSSES OR DAMAGES TO ANY PROPERTY OR FOR ANY PERSONAL INJURY OR ECONOMIC LOSS OR DAMAGE CAUSED BY THE CONNECTION OF A PRODUCT TO ANY OTHER DEVICE OR SYSTEM; AND (C) ANY DAMAGE OR INJURY ARISING FROM OR AS A RESULT OF MISUSE OR ABUSE, OR THE INCORRECT INSTALLATION, INTEGRATION OR OPERATION OF THE PRODUCT BY PERSONS NOT AUTHORIZED BY XANTREX.

## Exclusions

IF THIS PRODUCT IS A CONSUMER PRODUCT, FEDERAL LAW DOES NOT ALLOW AN EXCLUSION OF IMPLIED WARRANTIES. TO THE EXTENT YOU ARE ENTITLED TO IMPLIED WARRANTIES UNDER FEDERAL LAW, TO THE EXTENT PERMITTED BY APPLICABLE LAW THEY ARE LIMITED TO THE DURATION OF THIS LIMITED WARRANTY. SOME STATES, PROVINCES AND JURISDICTIONS DO NOT ALLOW LIMITATIONS OR EXCLUSIONS ON IMPLIED WARRANTIES OR ON THE DURATION OF AN IMPLIED WARRANTY OR ON THE LIMITATION OR EXCLUSION OF INCIDENTAL OR CONSEQUENTIAL DAMAGES, SO THE ABOVE LIMITATION(S) OR EXCLUSION(S) MAY NOT APPLY TO YOU. THIS LIMITED WARRANTY GIVES YOU SPECIFIC LEGAL RIGHTS. YOU MAY HAVE OTHER RIGHTS WHICH MAY VARY FROM STATE TO STATE, PROVINCE TO PROVINCE OR JURISDICTION TO JURISDICTION.

## Return Material Authorization Policy

For those products that are not being repaired in the field and are being returned to Xantrex, before returning a product directly to Xantrex you must obtain a Return Material Authorization (RMA) number and the correct factory “Ship To” address. Products must also be shipped prepaid. Product shipments will be refused and returned at your expense if they are unauthorized, returned without an RMA number clearly marked on the outside of the shipping box, if they are shipped collect, or if they are shipped to the wrong location.

When you contact Xantrex to obtain service, please have your instruction manual ready for reference and be prepared to supply:

- The serial number of your product
- Information about the installation and use of the unit
- Information about the failure and/or reason for the return
- A copy of your dated proof of purchase

Record these details on page 78.

## Return Procedure

Package the unit safely, preferably using the original box and packing materials. Please ensure that your product is shipped fully insured in the original packaging or equivalent. This warranty will not apply where the product is damaged due to improper packaging.

Include the following:

- The RMA number supplied by Xantrex Technology USA Inc. clearly marked on the outside of the box.
- A return address where the unit can be shipped. Post office boxes are not acceptable.
- A contact telephone number where you can be reached during work hours.
- A brief description of the problem.

Ship the unit prepaid to the address provided by your Xantrex customer service representative.

**If you are returning a product from outside of the USA or Canada** In addition to the above, you MUST include return freight funds and are fully responsible for all documents, duties, tariffs, and deposits.

**If you are returning a product to a Xantrex Authorized Service Center (ASC)** A Xantrex return material authorization (RMA) number is not required. However, you must contact the ASC prior to returning the product or presenting the unit to verify any return procedures that may apply to that particular facility and that the ASC repairs this particular Xantrex product.

## Information About Your System

As soon as you open your Xanbus Automatic Generator Start (AGS) package, record the following information and be sure to keep your proof of purchase.

- Serial Number \_\_\_\_\_
- Product Number/s 809-0915
- Purchased From \_\_\_\_\_
- Purchase Date \_\_\_\_\_

If you need to contact Customer Service, please record the following details before calling. This information will help our representatives give you better service.

- Type of installation (e.g. \_\_\_\_\_  
RV, truck)
- Length of time device \_\_\_\_\_  
has been installed
- Battery/battery bank size \_\_\_\_\_
- Battery type (e.g. flooded, \_\_\_\_\_  
sealed gel cell, AGM)
- DC wiring size and length \_\_\_\_\_
- Alarm sounding? \_\_\_\_\_
- Description of indicators \_\_\_\_\_  
on front panel
- Appliances operating \_\_\_\_\_  
when problem occurred
- Description of problem \_\_\_\_\_

\_\_\_\_\_  
\_\_\_\_\_



# Appendix A: Generator Auto Start Requirements and Types

## Recommended Features

In order for the generator to be automatically started by the AGS, it must include electric start and an automatic choke. An automatic primer system may also be required on natural gas and propane powered generators. The generator should also include remote start ability with accessible remote start terminals or a connector. Protective systems for low oil pressure, over temperature, starter lockout and over crank control are valuable features that will prevent generator damage and increase system reliability. “Two-wire” start generators are highly recommended because of the greater simplicity for automatic starting and because they are intended for remote/automatic/unattended operation.

## Generator Starting Types

The AGS supports three major generator starting types:

- Two wire
- Three-wire “Onan”
- Three-wire automotive

---

**NOTE:** The terms “two-wire” and “three-wire” refer only to the minimum number of wires necessary to start the generator. Actual installations will require additional wires to connect to the generator, including the generator run signal (switched B+) wiring, and wiring to an optional external ON/OFF switch. For installation wiring diagrams, see page 15 to page 28.

---

---

**NOTE:** For overcurrent protection guidelines that apply to the wiring types discussed in this appendix, see page 11.

---

### Two Wire

The two-wire type is suitable for generators that are fully automatic. This merely requires two wires to be connected together for the generator to start and run. Separating the wires stops the generator.

Some generators use a momentary two-wire connection for starting and stopping.

#### Identification

Generators of this type are usually operated with a simple toggle switch or key that turns to on, then off to shut the generator off.

#### Connection

For this type of generator, the two wires are connected to the normally open and common contacts of Relay 1 (wires 14 and 16). When the AGS receives a command to start the generator, it closes the contacts inside Relay 1, allowing the generator to start. The contacts remain closed for the duration of the generator run and open when the AGS needs the generator to stop.

### Three-Wire Onan

The three-wire “Onan” starting type is suitable for generators that are not as automated as the two-wire type. It requires a minimum of three wires: a common wire, a start wire and a stop wire. You may also need to connect the glow plug wires to Relay 1 (wire 14) or Relay 3 (wire 19). If the generator requires independent control of the glow plugs, power may also need to be run to Relay 3 (wire 20).

#### Identification

Generators of this type are controlled with a three-position switch that is normally in a center (or neutral) position. To start the generator, the switch is pressed and held to the start position until the generator starts. The switch is then released, and it returns to the center position. To stop the generator, the switch is pressed and held to the stop position until the generator stops. Again, releasing the switch returns it to the center position.

#### Connection

The common wire from the generator should connect to the common connections of both Relay 1 and Relay 2 (wires 16 and 18 respectively). The start wire from the generator connects to the normally open contact of Relay 2 and the generator stop wire connects to the normally open contact of Relay 1.

---

## Three-Wire Automotive

The third generator starting type that is supported by the AGS is similar to an automotive-style ignition. In this style, the generator uses a run circuit that is normally closed, which then receives a momentary start signal. The run circuit remains active throughout the run and then is opened in order for the generator to stop.

### Identification

Generators of this type are controlled by a key or rotary switch that acts exactly as an automotive ignition. The switch is first turned to an “on” (or run) position, then further to a start position. After starting, the switch returns to the “on” (or run) position. Other variations are a toggle switch that gets turned on with a separate switch or push button for start. If glow plugs are used, you would turn the key or rotary switch to the left prior to starting. A separate momentary switch or button may be used for this purpose.

### Connection

This generator starting type uses the most wires. The common wire from the generator should connect to the common connections of both Relay 1 and Relay 2 (wires 16 and 18 respectively). You may need an additional two wires if glow plugs are used. The start wire from the generator connects to the normally open contact of Relay 2 and the generator stop wire connects to the normally open contact of Relay 1.

# Appendix B: Relay Timing

## RunMode

For generators with RunMode starting types (Types 7, 8, and 14):

- Relay 1 (Run/Stop relay) can be used for two-wire configured generators.
- Relay 1 (Run/Stop) and Relay 2 (Start) can be used with a common ground for three-wire configured generators.
- The Preheat will never overlap the Crank Time.
- The “Delay” refers to the “Preheat to Crank Delay” and may be zero.
- Cranking will cease when the generator run signal goes high for the specified hold time or when the crank time has elapsed.

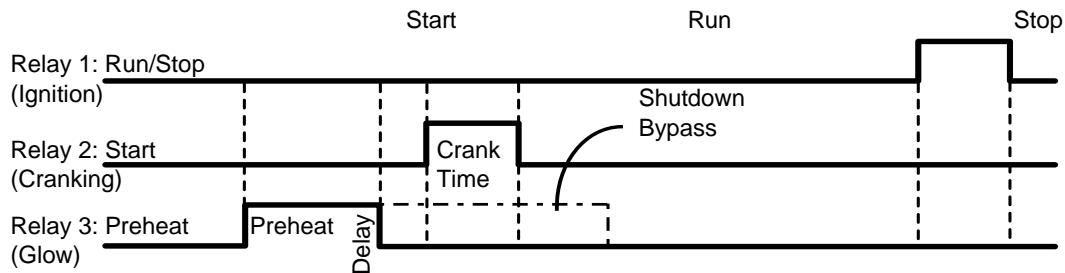
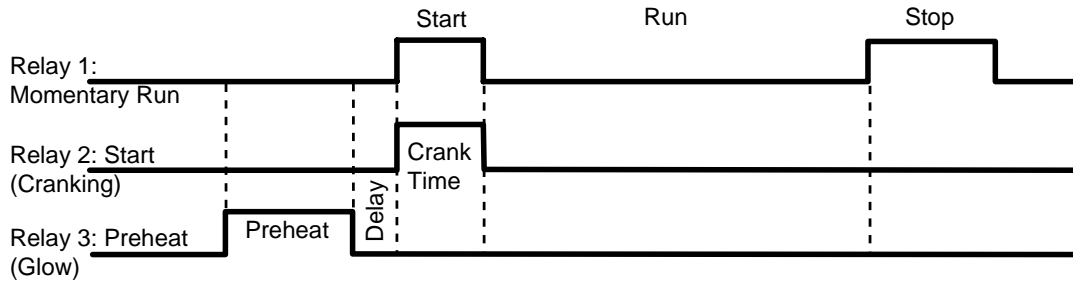

Figure 37 RunMode Timing Diagram

## MomentaryRun Mode

For generators with MomentaryRun mode starting types (Type 11):

- Relay 1 (Run/Stop relay) can be used for two-wire configured generators.
- Relay 2 has no unique function in this configuration, but it is easiest to leave it doing the cranking so that another configuration is not required for it.
- Preheat will generally not be used in this configuration.
- The Preheat will never overlap the Crank Time.
- The “Delay” refers to the “Preheat to Crank Delay” and may be zero.
- Cranking will cease when the generator run signal goes high for the specified hold time or when the crank time has elapsed.

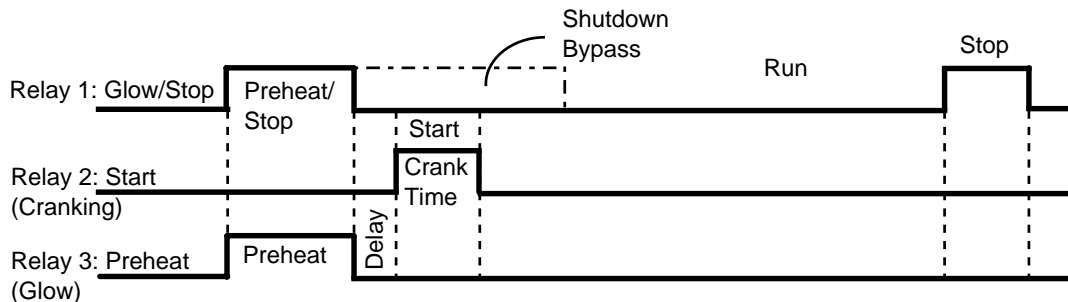

**Figure 38** MomentaryRun Mode Timing Diagram

## GlowStop Mode

For generators with GlowStop mode starting types (Types 1, 2, 3, 6, 12):

- Relay 1 (Stop) and Relay 2 (Start) can be used with a common ground for three-wire configured generators.
- The Preheat signal shows up on Relay 1 and also Relay 3 (if enabled) so that Relay 1 can be used for both Preheat and Stop.
- If the ShutDown Bypass is enabled, the Preheat on Relay 1 will remain high for the Crank Time and for the ShutDown Bypass period after cranking.
- The Preheat on Relay 3 will only overlap the Crank Time and perform ShutDown Bypass if Relay 3 is configured for Preheat with ShutDown Bypass.
- The “Delay” refers to the “Preheat to Crank Delay” and may be zero.
- Cranking will cease when the generator run signal goes high for the specified hold time or when the crank time has elapsed.

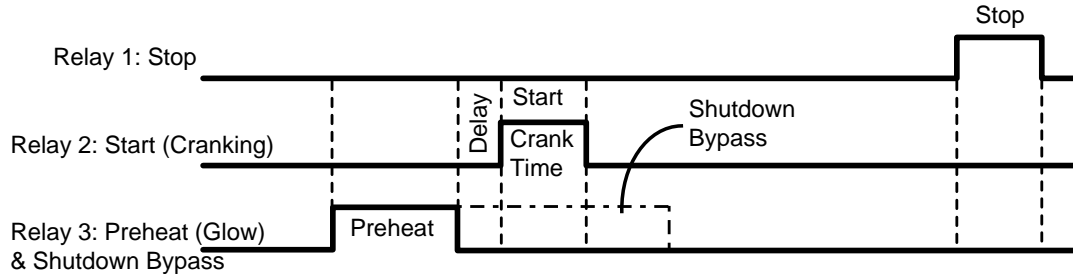

**Figure 39** GlowStop Mode Timing Diagram

## StartStop Mode

For generators with StartStop mode starting types (Types 4, 5, 9, 10):

- Relay 1 (Stop) and Relay 2 (Start) can be used with a common ground for three-wire configured generators.
- If Relay 3 is configured for preheat, the signal only shows up on Relay 3.
- The Preheat on Relay 3 will not overlap the Crank Time if ShutDown Bypass is not enabled.
- If the ShutDown Bypass is enabled, the Preheat on Relay 3 will remain high for the Crank Time and for the ShutDown Bypass period after cranking.
- The “Delay” refers to the “Preheat to Crank Delay” and may be zero.
- Cranking will cease when the generator run signal goes high for the specified hold time or when the crank time has elapsed.
- To get the ShutDown Bypass on Relay 3 with no preheat, Relay 3 must be configured for Preheat with ShutDown Bypass and have the Preheat time set to zero.
- StartStop mode is essentially the same as GlowStop mode with no preheat on Relay 1.



**Figure 40** StartStop Mode Timing Diagram

## PulseStop Mode

For generators with PulseStop mode starting types (Type 13):

- Relay 1 (Stop) and Relay 2 (Start) can be used with a common ground for three-wire configured generators.
  - If Relay 3 is configured for Preheat, the signal only shows up on Relay 3.
  - The Preheat on Relay 3 will not overlap the Crank Time if ShutDown Bypass is not enabled.
  - If the ShutDown Bypass is enabled, the Preheat on Relay 3 will remain high for the Crank Time and for the ShutDown Bypass period after cranking.
  - The “Delay” refers to the “Preheat to Crank Delay” and may be zero.
  - Cranking will cease when the generator run signal goes high for the specified hold time or when the crank time has elapsed.
- To get the ShutDown Bypass on Relay 3 with no preheat, Relay 3 must be configured for Preheat with ShutDown Bypass and have the Preheat time set to zero.
  - The AGS will make three attempts to stop the generator. If the generator has still not stopped at the end of the third attempt, the appropriate Fault will be generated.
  - Each stop attempt will consist of engaging the stop relay for 5 seconds and then waiting 20 seconds before checking the state of the Gen Run Signal to see if the stop attempt was successful.

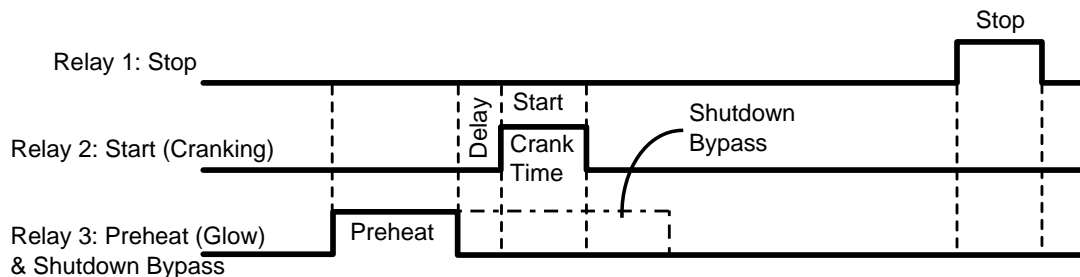
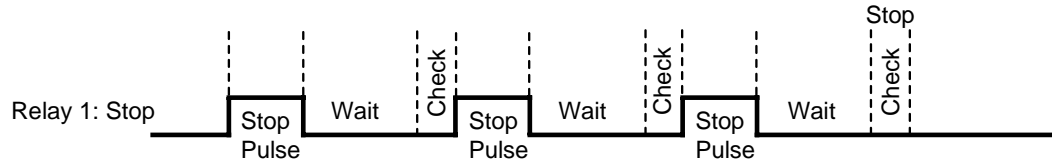

Figure 41 PulseStop Mode Timing Diagram





**Figure 42** PulseStop Mode Relay 1 Behavior





**Xantrex Technology USA Inc.**

1 800 670 0707 Tel

1 800 994 7828 Fax

[www.xantrex.com](http://www.xantrex.com)