

Technics

Turntable System

SL-Q3

Operating instructions



Before operating this set, please read these instructions completely.

We want to thank you for selecting the SL-Q3.
For optimum performance, we recommend that you read these instructions carefully.

Caution for safe use of this apparatus

Caution

- This apparatus is double insulated, safety earth not required.

Important

- The wires in this mains lead are coloured in accordance with the following code:

Blue:	Neutral
Brown:	Live

As the colours of the wires in the mains lead of this apparatus may not correspond with the coloured markings identifying the terminals in your plug proceed as follows. The wire which is coloured **BLUE** must be connected to the terminal which is marked with the letter **N** or coloured **BLACK**.

The wire which is coloured **BROWN** must be connected to the terminal which is marked with the letter **L** or coloured **RED**.

- This equipment should be disconnected from the mains when not in use.

Before use

Caution:

Never connect the AC power plug before assembly has been completed.

Attach the dust cover last, so that assembly and adjustments can be made most conveniently.

■ Checklist of parts

Turntable unit	1
Turntable platter	1
Turntable mat	1
Dust cover	1
45-rpm adaptor	1
Balance weight	1
Headshell/cartridge	1
Shell weight	1

Assembly and set-up

■ Installation of turntable platter

1. Place the turntable platter on the center spindle.

Note:

The rotor is connected to the underside of the turntable platter. (The magnet of the motor is attached to the turntable platter.) To maintain optimum performance, extra care should be taken to prevent adhesion of dust or iron filings to the magnet and not to damage the magnet by dropping it.

Do not remove or loosen the screws. Should the position of the fixed magnet be altered by loosening the securing screws, the rated performance of the unit cannot be guaranteed. (See Fig. 2.)

2. Place the turntable mat on the platter.

Note:

After having placed the turntable mat on the turntable platter, manually rotate the turntable platter clockwise about 10 times.

This will disengage the automatic mechanism from the tonearm gear, which, in rare cases, may have moved out of its normal position during transportation.

■ Installation of headshell (See Fig. 3.)

Insert the headshell into the front end of the tubular arm, and turn the locking nut clockwise (in the direction shown by the arrow "A"), with the headshell firmly held horizontally.

■ Installation of balance weight (See Fig. 4.)

Place the balance weight on the rear shaft of the tonearm.

■ Adjustments of horizontal zero (0) balance and stylus pressure

1. Remove the stylus protector, if your cartridge has a detachable one. Be careful not to touch your fingers to the stylus tip.
2. Release the arm clamp and lift the tonearm from the arm rest to free it.
3. Turn the entire balance weight clockwise (indicated by the arrow "A") or counterclockwise (indicated by the arrow "B") until the tonearm is approximately balanced horizontally (floats freely). (See Figs. 5 and 6.)

Note:

Fig. 6-1

Excessive forward advancement of the balance weight causes the cartridge side to be lowered.

Fig. 6-2

Excessive backward retreatment of the balance weight causes the cartridge side to be raised.

Fig. 6-3

Upon balancing between the balance weight and cartridge, the tonearm is held horizontal.

During the adjustment of the horizontal zero (0) balance, be careful that the stylus tip of the cartridge does not contact the turntable mat or turntable base.

4. After the tonearm is horizontally zero (0) balanced, temporarily refasten the tonearm with the arm clamp.
5. Hold the balance weight stationary with one hand as shown in the picture, and rotate only the stylus-pressure ring to bring the numeral "0" of the ring into alignment with the center line on the tonearm rear shaft.
The adjustment of the horizontal zero (0) balance is now completed. (See Fig. 7.)
6. After adjusting the horizontal zero (0) balance, turn the balance weight clockwise in the direction of the arrow and align to the correct stylus pressure. (See Fig. 8.)
(The stylus pressure of this unit is 1.75 g.)

Note:

Set the stylus pressure to the maximum recommended value for your cartridge in cases where the record has an extremely high recording level, or where the unit is operated in a room at low temperature, or in places in which the unit is subjected to vibrations.

Assembly and set-up

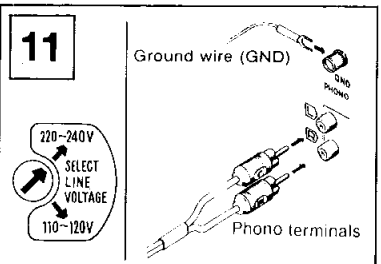
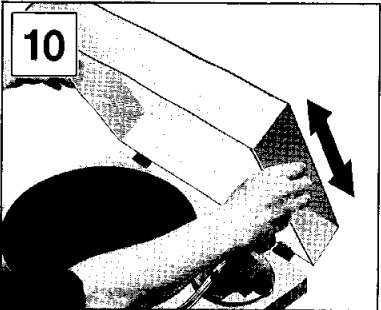
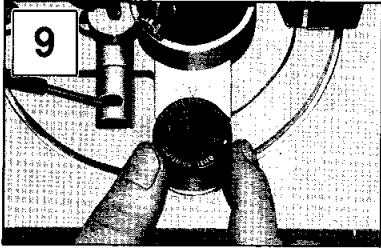
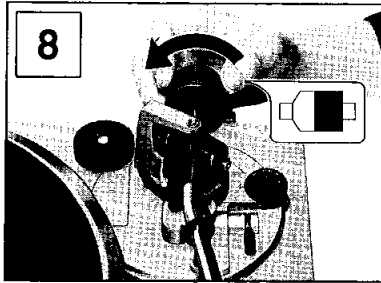

How to operate

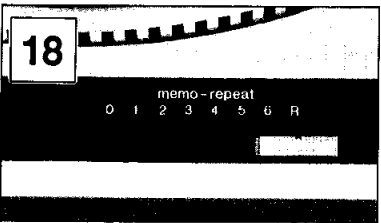
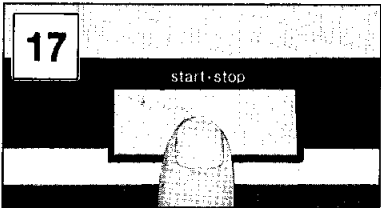
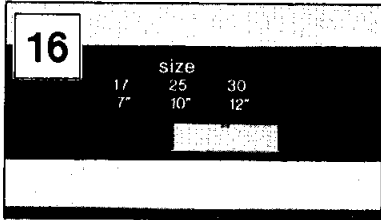
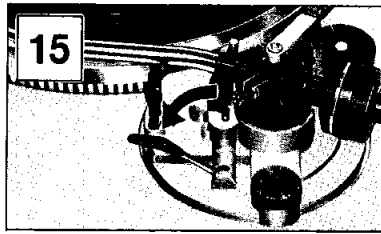
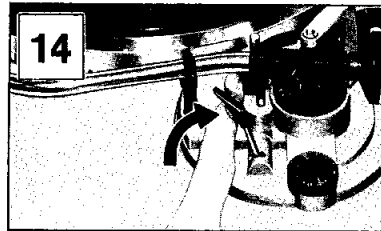
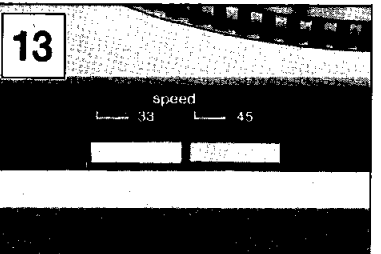
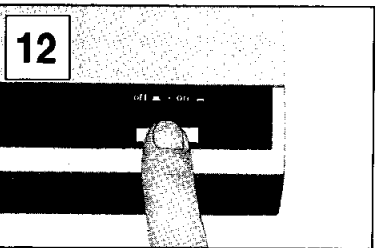

Replacement of parts

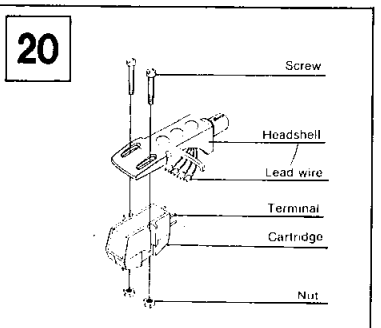
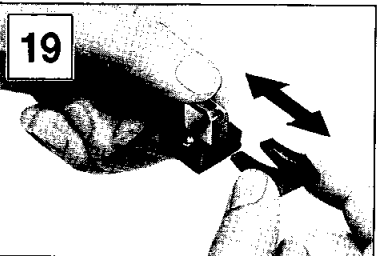

21

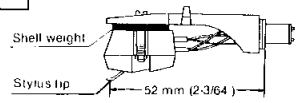

Notes and maintenance

22

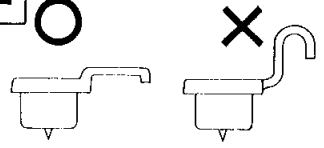

23

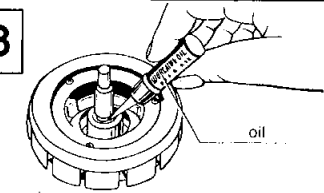

Adjustments

24

5 — 10 mm (3/16" — 25/64")

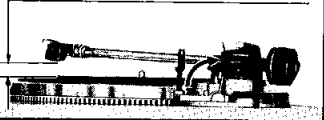

25

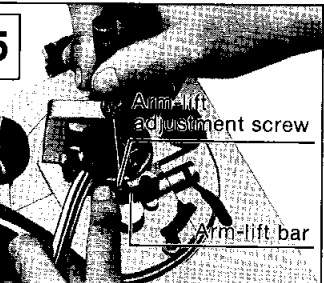

26

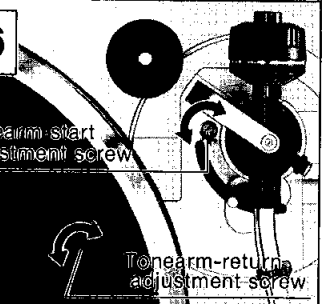

Parts identification

1

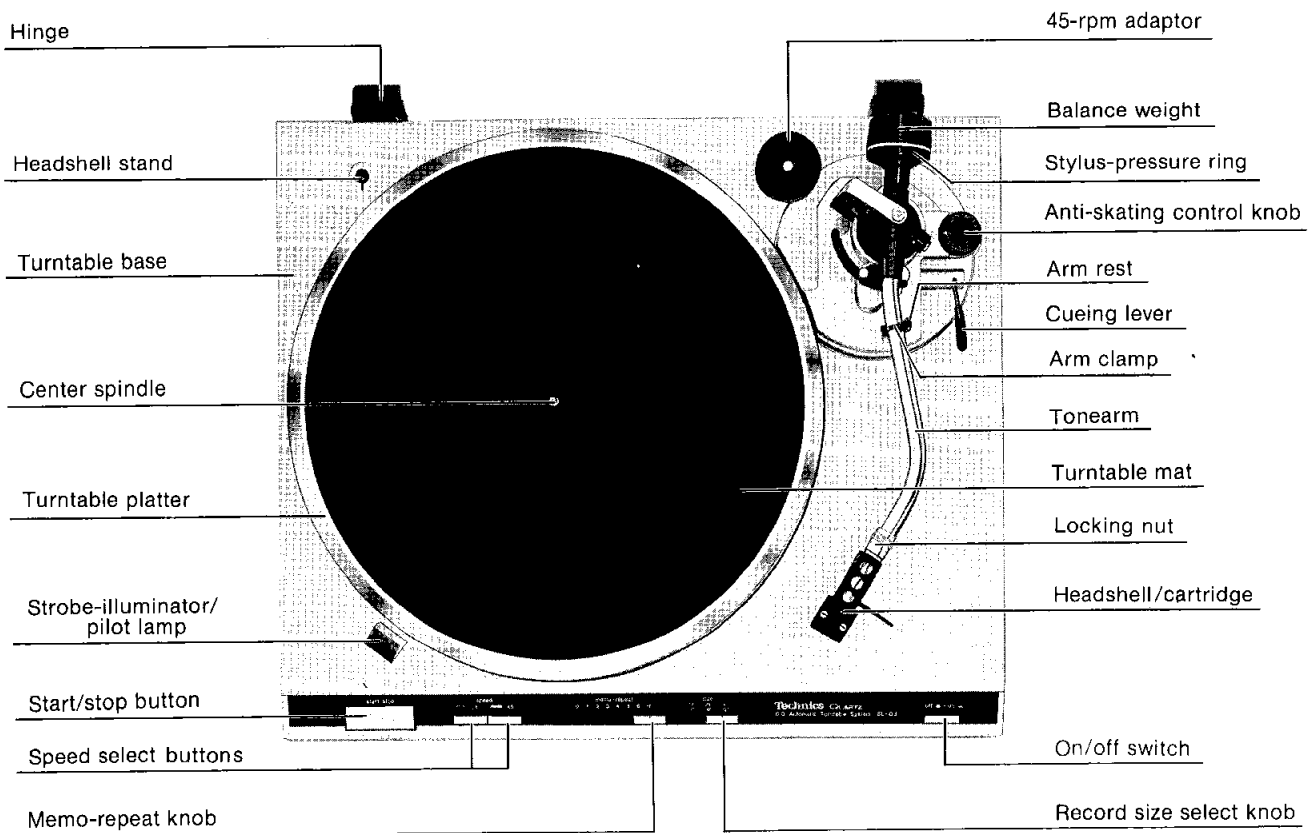

Assembly and set-up

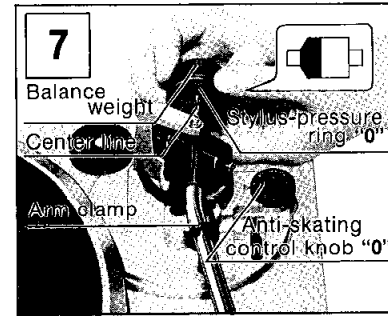
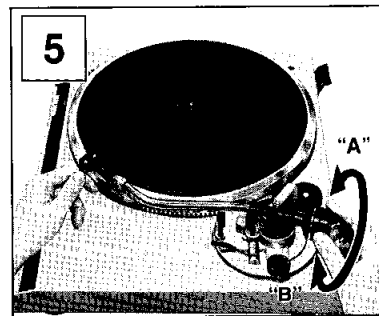
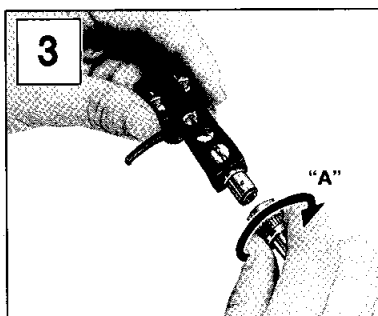
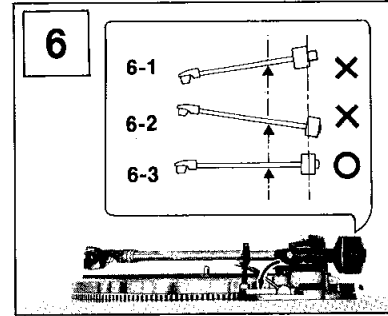
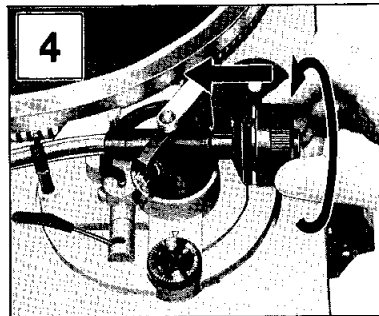
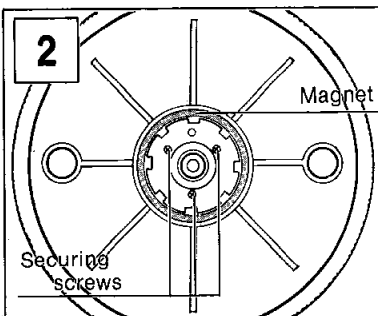

■ Adjustment of anti-skating control

Set the anti-skating control knob to the same value as the stylus pressure. (See Fig. 9.)

Note:

When a cartridge with integral dust brush is used, follow the cartridge manufacturer's recommendation for adjusting both stylus pressure and anti-skating force.

■ Installation of dust cover

Place the dust cover into position from directly above, holding it at both sides. For detaching the dust cover, be certain first to raise it as illustrated before removal. (See Fig. 10.)

Note:

Opening or closing of the dust cover during play should be avoided. This may not only cause undesired vibrations, but also result in skipping of the stylus.

If you must open the dust cover during play, do so as gently as possible.

Placement

- Place the unit in a stable and horizontal position, where there is little or no vibration.
- Locate the unit as far away from the speakers as possible and isolate the unit from sound radiation from them.
- Do not place the unit where it is exposed to direct sun, dust, moisture or heat.
- Keep it in a well ventilated place.

Connections

■ Connect the AC power plug (See Fig. 11.)

Connect the AC power plug to an AC wall socket.

Caution:

Make sure that the turntable's AC line-voltage selector is matched to your local voltage before connecting the AC power plug.

Never connect to a DC socket.

If the pre-selected voltage is different from your local voltage, turn the AC line-voltage selector with a screwdriver so that it corresponds to your local voltage.

The AC line-voltage selector is located under the turntable platter.

■ Connect the output terminals (See Fig. 11.)

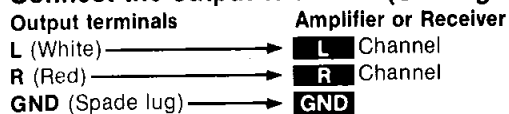

Note:

Be sure to connect the ground terminal firmly to the amplifier or receiver. If this connection is not made or is loose, a power source "HUM" will result.

How to operate

■ Manual play

1. Place a record on the turntable mat.
2. Set the on/off switch to the "on" position (⬆). (See Fig. 12.) Both the LED at the speed select button 33 (33-1/3 rpm) and the strobe-illuminator should be illuminated.
Note:
Since the unit has been designed to select 33-1/3 rpm automatically each time you push the on/off switch to "on", push the 45 rpm speed select button if you play a 45-rpm record. (See Fig. 13.)
3. Remove the stylus protector, if your cartridge has a detachable one.
4. Release the arm clamp.
5. Set the cueing lever to the up position. (See Fig. 14.)
6. Move the tonearm over the desired groove.
The turntable platter will start to rotate.
7. Set the cueing lever to the down position. (See Fig. 15.)
The tonearm will descend slowly onto the record and play will begin.
8. When play is finished, the tonearm will automatically return to the arm rest (auto-return), and the turntable platter will stop rotation.
If the unit is not to be used for some time set the on/off switch to the "off" position (⬆).
Attach the stylus protector, if you have one, to guard the stylus tip from damage.

■ Automatic play

1. Set the speed select button in the same manner as in manual play and release the arm clamp.
2. Set the record size select knob to the diameter of the record (7" [17 cm], 10" [25 cm], or 12" [30 cm]) you wish to play. (See Fig. 16.)
3. Push the start/stop button. (See Fig. 17.)
The tonearm will move automatically over the lead-in groove and descend slowly onto the record (auto-start). Play will begin.
4. When play has finished, the tonearm will automatically return to the arm rest (auto-return).

■ Repeat play

1. Set the "memo-repeat" knob to the desired number of times you wish to play.
"R" position enables you to repeat play continuously. (See Fig. 18.)
Note:
The "memo-repeat" knob may be set to a desired number, except during automatic start or automatic return cycle. If you start play manually while the "memo-repeat" knob is set to a number, there will be an additional repeat play.
2. Start play in the same way as for automatic play.

■ How to stop play

Push the start/stop button.

The tonearm automatically returns to the arm rest, and the turntable stops rotating.

Note:

Before you operate the start/stop button, make sure that the "memo-repeat" knob is set at the "0" position. If this knob is set at any position other than "0", the repeat play is continued by the number of times indicated, even if you push the start/stop button.

■ How to suspend play

Set the cueing lever to the up position.
The stylus tip of the cartridge will be lifted from the record.

■ When you play a 45-rpm record with a large center hole

Place the 45-rpm adaptor on the center spindle. Set the speed select button to the "45" position.

Replacement of parts

■ Replacement of stylus (See Fig. 19.)

The unit is furnished with a diamond stylus. The life of the stylus differs depending on the conditions of use, but it is recommended that you replace the stylus at the first sign of wear. About 500 hours of use is an approximate standard.

The replacement stylus for the unit is the **EPS-207ED**.

1. Remove the headshell/cartridge from the tubular arm.
Hold the stylus assembly with your fingers and withdraw it slantwise, as shown in the picture.
2. Align the new stylus assembly with the square opening of the cartridge main body, and push it into the opening positively as far as it will go.

■ Installation of cartridge (See Fig. 20.)

When you install a cartridge, refer to the operation instructions of that cartridge.

During installation, attach the stylus protector to guard the stylus tip from damage.

1. Connect the lead wires to the cartridge terminals.
The terminals of most cartridges are colour coded. Connect each lead wire to the terminal of the colour.
White (L+)..... Left channel+
Blue (L-)..... Left channel-
Red (R+)..... Right channel+
Green (R-)..... Right channel-
2. Install a cartridge to the headshell, and tighten it with screws provided with the cartridge.

Note:

Use the shell weight only for a light weight cartridge.
(Less than 6.0 g.). (See Fig. 21.)

■ Adjustment of overhang (See Fig. 21.)

The overhang of this unit is 15 mm.

Loosen the mounting screws and move the cartridge forward or backward until the distance between the stylus tip and the plug becomes 52 mm (2-3/64") as shown in the picture.

Tighten the mounting screws without moving the cartridge. Adjust horizontal zero balance, stylus pressure and arm-lift height whenever you change the cartridge.

Notes and maintenance

- Do not grasp or hold the tonearm during operation of the automatic mechanism.

- Use utmost care when handling the platter and when placing it on the motor shaft to prevent possible damage to the magnet.

- Records having sizes other than 17 cm, 25 cm and 30 cm (7", 10" and 12") should be played manually.

Your turntable is designed for automatic handling of records that adhere to accepted industry dimensions. Therefore, use the unit manually for records other than standard sizes.

- When using other headshells, make sure that the headshell configuration is compatible. (See Fig. 22.)

When other types of headshells are employed, the handle portion of the headshell may strike against the inner upper surface of the dust cover during automatic motion of the tonearm. In such a case, we recommend that the dust cover be left open during play.

- Before detaching or attaching the headshell, be sure to turn the power of the amplifier or receiver off.

Detaching or attaching of the headshell with the volume control turned up may cause damage to the speakers.

- Dust and dirt should be carefully removed from stylus tip or records.

Dust and dirt on the stylus tip or record may not only result in deterioration of tone quality, but also cause undue wear of the record and the stylus tip itself.

Special stylus tip brushes and record cleaners can be purchased in most electronic supply houses.

- Wipe the headshell terminals from time to time.

Dust and dirt at the headshell terminals may result in increased "HUM" noise or intermittent sound. Use soft dry cloth to clean the headshell terminals.

- Care should be exercised in handling the turntable platter.

The turntable platter has the rotor (the magnet of the motor) directly connected to it. Therefore, the turntable platter should not be removed from the motor shaft unnecessarily.

Should it become necessary to remove the turntable platter, be sure first to pull the AC power plug out of the socket.

- Wipe the dust cover and turntable base with a soft, dry cloth.

Never use any cleaners containing alcohol, benzine or thinner. Use of a chemical dust cloth should also be avoided. Be sure that the dust cover is not exposed to insecticide spray.

To remove stubborn finger prints or grease spots, detach the dust cover and disconnect the AC power plug.

Use a soft cloth slightly moistened with a mild soap and water solution.

Do not wipe the dust cover during play, or the tonearm may be attracted toward the dust cover due to the generation of static electricity.

- Lubrication (See Fig. 23.)

Apply 2 or 3 drops of oil once after every 2000 hours of operation.

The time interval is much longer than that for conventional type motors (200—500 hours).

Please purchase original oil. (Part number is **SFWO 010**.)

■ About strobe dot pattern

The strobe-illumination of this unit employs a strobe-illuminator (LED/red illumination lamp) synchronized with the precise frequency of the quartz.

Note:

The LED illuminator is not synchronized with fluorescent lamps.

Adjustments

■ Adjustment of arm-lift height

(See Figs. 24 and 25.)

The arm-lift height (distance between the stylus tip and record surface when cueing lever is at the up position) has been adjusted at the factory before shipment to approximately 5 to 10 mm.

For using different cartridges available on the market or when further adjustments are particularly necessary, make adjustment as follows:

1. Move the tonearm toward the center spindle.
Attach the stylus protector, if available, to guard the stylus tip from damage.
2. Turn the adjustment screw clockwise or counterclockwise, while pushing the arm lift down.

Clockwise rotation

—distance between the record and stylus tip is reduced.

Counterclockwise rotation

—distance between the record and stylus tip is increased.

Note:

As the adjusting screw has a hexagonal head, be sure to make the adjustment while depressing the arm lift, or the screw will not move freely.

Also be sure that the hexagonal head retracts correctly into the arm lift when the latter is released.

■ Adjustment for automatic start position

(See Fig. 26.)

(Remove the rubber cap.)

In cases where the stylus tip sets down outside of the record

—rotate clockwise.

In cases where the stylus tip sets down too far in the recorded groove

—rotate counterclockwise.

■ Adjustment for automatic return position

(See Fig. 26.)

(Remove the turntable mat.)

In cases where the tonearm tends to return before the playing has finished

—rotate clockwise.

In cases where the tonearm fails to return after the last groove of the record has been played

—rotate counterclockwise.

Features

- Front panel controls provide exceptional convenience
- Quartz-phase-locked direct drive plus full cycle F·G (Frequency Generator) and integral rotor-platter motor
- Precision aluminum diecast turntable base unique to Technics is used.
- "TNRC"* base material provides an acoustic shield
*"TNRC" Technics Non-Resonance Compound
- Smooth braking is achieved with the fully electronic system, which also makes possible almost instantaneous speed change.
- Low-mass, low-friction gimbal suspension tonearm
- Viscous-damped cueing
- Anti-skating control
- Hinged, detachable dust cover
- Auto-start, auto-stop, auto-return and programmable repeat play make the SL-Q3 a pleasure to use.

Since everything is automatic, you don't need to touch the tonearm unless you want to move to a particular cut on the record.

The "memo-repeat" feature allows you to repeat a record up to six times, or indefinitely if you prefer.

Specifications

■ General

Power supply:	~110-120/220-240V, 50 or 60 Hz
Power consumption:	7.5 W
Dimensions: (W×H×D)	43.0 × 13.0 × 37.5 cm (16-59/64" × 5-7/64" × 14-49/64")
Weight:	7.1 kg (15.7 lb.)

■ Turntable section

Type:	Automatic turntable Auto start Auto return Auto stop Repeat play
Drive method:	Direct drive
Motor:	Brushless DC motor
Turntable platter:	Aluminum die-cast
Turntable platter:	Diameter 31.2 cm (12-9/32 inches)
Turntable speeds:	33-1/3 rpm and 45 rpm
Starting torque:	1 kg·cm (0.87 lb·in)
Build-up characteristics:	0.9 s. from standstill to 33-1/3 rpm
Speed change due to load torque:	0% within 0.7 kg·cm (0.61 lb·in)
Speed drift:	Within ±0.002%
Wow and flutter:	0.012% WRMS* 0.025% WRMS (JIS C5521) ±0.032% (IEC98A Weighted)

*This rating refers to turntable assembly alone, excluding effects of record, cartridge or tonearm, but including platter. Measured by obtaining signal from built-in frequency generator of motor assembly.

Rumble:	-56 dB (IEC 98A Unweighted) -78 dB (IEC 98A Weighted)
----------------	--

■ Tonearm section

Type:	Universal tonearm
Effective length:	230 mm (9-1/16")
Overhang:	15 mm (19/32")
Friction:	Less than 7 mg (lateral, vertical)
Effective mass:	12 g (without cartridge)
Tracking error angle:	Within 2°32' at the outer groove of 30 cm (12") record Within 0°32' at the inner groove of 30 cm (12") record
Offset angle:	22°
Stylus pressure adjustment range:	0—2.5 g
Applicable cartridge weight range:	6—9.5 g 13.5—17 g (including headshell)
Applicable cartridge weight range (with shellweight):	3—6.5 g 10.5—14 g (including headshell)
Headshell weight:	7.5 g

■ Cartridge section

Model No.:	EPC-207C
Type:	Moving magnet
Frequency response:	20 Hz to 25 kHz 20 Hz to 15 kHz ±2 dB
Output voltage:	3 mV at 1 kHz 5 cm/s. zero to peak lateral velocity (8.5 mV at 1 kHz, 10 cm/s. zero to peak lateral velocity [DIN 45500])
Channel separation:	25 dB at 1 kHz
Channel balance:	Within 2 dB at 1 kHz
Compliance (dynamic):	10×10^{-6} cm /dyne at 100 Hz
Stylus pressure:	1.75 ±0.25 g (17.5 ±2.5 mN)
Load impedance:	47 kΩ to 100 kΩ
Weight:	5.6 g (cartridge only)
Replacement stylus:	EPS-207ED

Specifications subject to change without notice. Weight and dimensions shown are approximate.

For longer and safer use of this unit

In order to receive the best service from this unit, and for the safest operation, carefully read the following information.

■ Power source

It is very dangerous to use this unit at a voltage which is different from the rated voltage.

There is danger of combustion if the unit is connected to a power source which is different from the rated voltage.

Be very careful concerning this point.

Direct current cannot be used.

There are some places, such as ships, where direct current is used as the power source. Before connecting the unit, confirm the power source.

■ Connection of power cord

Be sure to never touch the power cord with wet hands because there is danger of electric shock. This is true, of course, of all electric equipment.

Do not pull the power cord.

Never pull the power cord to disconnect it. Always pull the plug only.

■ Location of unit

Choose a place which is not in direct sunlight.

Select a place which will assure good ventilation.

■ Never place heating equipment nearby.

Be sure to keep stoves and other sources of heat away from this unit, because heat radiated by such equipment may cause deformation of plastic parts or damage the cabinet, or, at worst, cause a fire.

■ Especially for families with children

Take care that no small items, such as metal objects, are put inside this unit.

In addition, children should be especially warned not to put anything into the ventilation holes, such as toys or a screwdriver, because these things may cause an electric shock or result in a malfunction of the unit.

■ If water spills on the unit

If water should happen to spill on the unit, from an overturned vase for example, there is danger of fire or electric shock. Disconnect the power plug from the electric outlet immediately, and contact the store from which the unit was purchased.

■ Reconstruction can cause accidents

Absolutely never try to remodel, reconstruct or repair this unit yourself. Do not attempt to touch any internal parts because to do so may result in an electric shock or other accident.

■ Be sure the power is off.

After you have finished using this unit, check once more to be sure that the power is off. If the unit is left with the power on for a long period of time, it may not only be damaged, thus shortening its useful life, but may also lead to a dangerous accident.

Matsushita Electric Trading Co., Ltd.
P.O. Box 288, Central Osaka Japan

Printed in Japan

SFNUQ30G01
S0579A0