



Changing the Shape of Light™

2015-2016



A PREMIER MANUFACTURER OF QUALITY LED LIGHTING SOLUTIONS



TecNiq^{inc}

TecNiq Inc is an engineer owned & operated company with a strong commitment to customer care. This commitment starts with the belief that we make a better lamp, and provide a better value, but that's just the beginning. The commitment is shown in every aspect of our business. We use the highest quality LEDs and materials, sophisticated material delivery planning system, and offer market leading customer service where someone friendly always answers the phone during business hours.

Our goal is to not only exceed your product quality expectations, but also to ensure your customers are completely satisfied when their lighting performs flawlessly. We feel so strongly about our total commitment to quality, that we back every one of our products up with a no-nonsense Lifetime Warranty.

From your fleet vehicles, construction trailers, emergency response vehicles, boats, heavy or light duty equipment, you expect your lights to work every time, you can count on TecNiq Inc to deliver.



TecNiq's Proprietary Urethane Formulations

AccuColor

Natural Illumination



Wireless Flasher Synchronization

Key Markets Served...

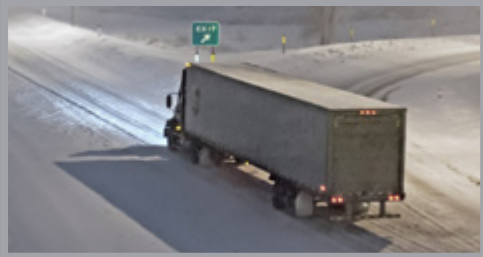

Commercial/Fleets



Trailers



Emergency Vehicles

Marine



Recreational Vehicles

Table of contents

Stop/Turn/Tails	pg 2 - 8
Reverse Lamps	pg 8 - 9
License Plate Lights	pg 10 - 11
Sidemarkers	pg 12 - 17
Area & Accent Lighting	pg 18 - 29
Emergency Vehicle Exterior Lighting	pg 30 - 32
Accessories	pg 32 - 34
Lighting Specifications	pg 35 - 41
Part Number Index	pg 42 - 57

Model T600 6" Oval LED Stop/Tail/Turn

Grommet Mount



Features



- Guaranteed waterproof, sealed body that is immune to shock and vibration
- Meets all FMVSS 108 requirements for wide and narrow vehicles
- Reliable performance over 100,000 hours
- Energy efficient: draws only 0.12A (red) & 0.30A (amber) at 12V
- Also available in T610 surface mount version
- Lifetime warranty
- Stop/Turn/Tail lamp for use on heavy duty trucks, semi-trailers, cargo trailers, boat trailers, work vehicles, and any wide or narrow motor vehicle requiring quality DOT rated lighting



Model T610

6" Oval LED Stop/Tail/Turn



* Optional
chrome trim
ring



Features



- Guaranteed waterproof, sealed body that is immune to shock and vibration
- Meets all FMVSS 108 requirements for wide and narrow vehicles
- Reliable performance over 100,000 hours
- Energy efficient: draws only 0.12A (red) & 0.30A (amber) at 12V
- Also available in T600 grommet mount version
- Lifetime warranty
- Stop/Turn/Tail lamp for use on heavy duty trucks, semi-trailers, cargo trailers, boat trailers, work vehicles and any wide or narrow motor vehicle requiring quality DOT rated lighting

Model T620

6" Oval LED Stop/Tail/Turn

Flange Mount



*Vertical and horizontal styles

Features



- Guaranteed waterproof, sealed body that is immune to shock and vibration
- Meets all FMVSS 108 requirements for wide and narrow vehicles
- Reliable performance over 100,000 hours
- Energy efficient: draws only 0.12A (red) & 0.30A (amber) at 12V
- Flange mounting style reduces chances of damage
- Lifetime warranty
- Stop/Turn/Tail lamp for use on heavy duty trucks, semi-trailers, cargo trailers, boat trailers, work vehicles and any wide or narrow motor vehicle requiring quality DOT rated lighting



Model T400

4" Round LED Stop/Tail/Turn

Grommet Mount

Flange Mount



* Flange Mount



* Flange Mount with SS trim

Features



- Guaranteed waterproof, sealed body that is immune to shock and vibration
- Meets all FMVSS 108 requirements for wide and narrow vehicles
- Reliable performance over 100,000 hours
- Energy efficient: draws only 0.12A (red) & 0.30A (amber) at 12V
- Lifetime warranty
- Stop/Turn/Tail lamp for heavy duty trucks, semi-trailers, cargo trailers, boat trailers, work vehicles and any motor vehicle requiring quality DOT rated lighting



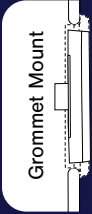

Model T660 6" Oval LED Stop/Tail/Turn

Features



- Guaranteed waterproof, sealed body that is immune to shock and vibration
- Meets FMVSS 108 Requirements for wide and narrow vehicles
- Reliable performance over 100,000 hours
- Energy efficient: draws only 0.12A (red) & 0.14A (amber) at 12V
- Can be mounted horizontal, vertical, or at any angle
- Lifetime warranty
- Stop/Turn/Tail lamp for use on heavy duty trucks, semi-trailers, cargo and utility trailers, work vehicles, and any wide or narrow motor vehicle that requires quality DOT rated lighting



* Surface Mount with chrome trim



Model T850 4" LED Trailer Light



Features



- Guaranteed waterproof construction including a secondary potting seal
- Meets all FMVSS 108 requirements for narrow and wide vehicles
- Reliable performance over 100,000 hours
- Energy efficient: draws only 0.20A at 12V
- Fits standard mounting as a direct replacement
- Lifetime warranty
- Functions include : Stop • Turn • Tail • Clearance • Sidemarker • Side Reflector • Rear Reflector • License Plate Light (Left)

Model T800 8" LED Trailer Light



Features



- Guaranteed waterproof construction including a secondary potting seal
- Meets all FMVSS 108 requirements for narrow and wide vehicles
- Reliable performance over 100,000 hours
- Energy efficient: draws only 0.20A at 12V
- Fits standard mounting as a direct replacement
- Lifetime warranty
- Functions include : Stop • Turn • Tail • Clearance • Sidemarker • Side Reflector • Rear Reflector • License Plate Light (Left)

Model T100 Series STT & Over 80" ID Bar



Features



- Guaranteed waterproof, sealed body that is immune to shock and vibration
- Meets all FMVSS 108 requirements for wide and narrow vehicles
- Reliable performance over 100,000 hours
- Energy efficient: draws only 0.19A (red or amber) at 12V
- Can be mounted horizontal, vertical, or at any angle
- Lifetime warranty
- Stop/Turn/Tail lamp for use on heavy duty trucks, semi-trailers, cargo and utility trailers, boat trailers, work vehicles, and any wide or narrow motor vehicle requiring quality DOT rated lighting

Model S500 Over 80" Identification Bar



Features



- Guaranteed waterproof, sealed body that is immune to shock and vibration
- Exceeds FMVSS 108 standards when mounted properly
- Reliable performance over 100,000 hours
- Energy efficient: draws only 0.18A at 12V
- Lifetime warranty
- P2 rated sidemarker clearance lamp for heavy duty trucks, semi-trailers, cargo trailers, boat trailers, work vehicles, and any motor vehicle requiring quality DOT rated lighting

Model S340 ID Bar Assembly

NEW



Features



- Guaranteed waterproof, sealed body that is immune to shock and vibration
- Exceeds FMVSS 108 standards when mounted properly
- Reliable performance over 100,000 hours
- Energy efficient: draws only 0.25A at 12V
- Three S340 sidemarkers linked together, available with 12" and 48" pigtail connectors
- Lifetime warranty
- PC/P2 rated sidemarker clearance lamp for heavy duty trucks, semi-trailers, cargo trailers, boat trailers, work vehicles, and any motor vehicle requiring quality DOT rated lighting

Model T410 LED Reverse Lamp

Grommet Mount

Flange Mount

Features



- Guaranteed waterproof, sealed body that is immune to shock and vibration
- Lamp is certified for either one or two backup lamp systems
- Reliable performance over 50,000 hours
- Energy efficient: draws only 0.35A at 12V
- Mounts with standard grommets or our anti-theft trim ring
- Lifetime warranty
- Harsh environment reverse lamp for use on heavy duty trucks, work vehicles, trailers, RVs and any motor vehicle requiring DOT compliant reverse lamps



* Can also be used anywhere else you need a durable, long-lasting light source

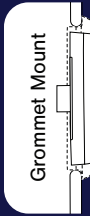

Model T660 LED Reverse Lamp



* Surface Mount with chrome trim

Features



- Guaranteed waterproof, sealed body that is immune to shock and vibration
- Reliable performance over 50,000 hours
- Energy efficient: draws only 0.25A at 12V
- Mounts with either standard grommets or surface mounted
- Several connector options available on request
- Lifetime warranty
- Harsh environment reverse lamp for use on heavy duty trucks, work vehicles, trailers, RVs and any motor vehicle requiring DOT compliant reverse lamps

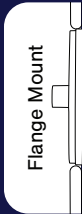

Model T620 LED Reverse Lamp



Features



- Guaranteed waterproof, sealed body that is immune to shock and vibration
- Reliable performance over 50,000 hours
- Energy efficient: draws only 0.35A at 12V
- Flange mounted with standard hole spacing
- Lifetime warranty
- Harsh environment reverse lamp for use on heavy duty trucks, work vehicles, trailers, RVs and any motor vehicle requiring DOT compliant reverse lamps

Model L100

2" Vertical Plane License Plate Light



*Also available in black



Features



- Guaranteed waterproof, sealed body that is immune to shock and vibration
- SAE DOT rated single LED design
- Reliable performance over 50,000 hours
- Energy efficient: draws only 0.10A at 12V
- Easily mounts to a vertical surface using just two screws
- Tough black or chrome plated polymer housing
- Lifetime warranty

Model L110

1" Vertical Plane License Plate Light



*Also available in black



Features



- Guaranteed waterproof, sealed body that is immune to shock and vibration
- SAE DOT rated single LED design
- Reliable performance over 50,000 hours
- Energy efficient: draws only 0.10A at 12V
- Easily mounts to a vertical surface using just two screws
- Tough black or chrome plated polymer housing
- Lifetime warranty

Model L120 3/4" Horizontal Plane License Plate Light



* Also available in black

Features



- Guaranteed waterproof, sealed body that is immune to shock and vibration
- SAE DOT rated single LED design
- Reliable performance over 50,000 hours
- Energy efficient: draws only 0.10A at 12V
- Easily mounts to a vertical surface using just two screws
- Tough black or chrome plated polymer housing
- Lifetime warranty

Model L340 3/4" Grommet License Plate Light

NEW



* Steel Bracket not included

Features



- Guaranteed waterproof, sealed body that is immune to shock and vibration
- SAE DOT rated single LED design
- Reliable performance over 50,000 hours
- Energy efficient: draws only 0.08A at 12V
- Easily mounts into standard 3/4" hole also available with large grommet style (1.19" mounting hole)
- Lifetime warranty

PC/P2
RATED

Model S180

3.7" Surface Mounted Sidemarker

NEW

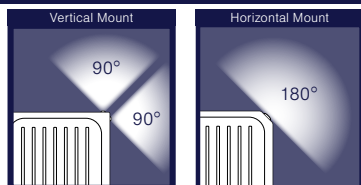

Features



- Guaranteed waterproof, sealed body that is immune to shock and vibration
- Exceeds FMVSS 108 standards when mounted properly
- Reliable performance over 100,000 hours
- Energy efficient: draws only 0.08A at 12V
- Lifetime warranty
- Vertical mount position meets P2 specifications, while horizontal mount meets PC specifications.
- Sidemarker/clearance lamp for heavy duty trucks, semi-trailers, cargo trailers, boat trailers, work vehicles, and any motor vehicle requiring quality DOT rated lighting

PC/P2
RATED

Model S170

2.5" Surface Mounted Sidemarker

NEW

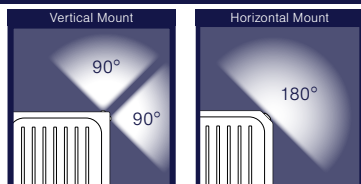

* Optional stainless steel trim ring

Features



- Guaranteed waterproof, sealed body that is immune to shock and vibration
- Exceeds FMVSS 108 standards when mounted properly
- Reliable performance over 100,000 hours
- Energy efficient: draws only 0.08A at 12V
- Lifetime warranty
- Vertical mount position meets P2 specifications, while horizontal mount meets PC specifications.
- Sidemarker/clearance lamp for heavy duty trucks, semi-trailers, cargo trailers, boat trailers, work vehicles, and any motor vehicle requiring quality DOT rated lighting



**P2
RATED**

Model S330

3/4" Mini Grommet Mounted Sidemarker



* Optional stainless steel trim ring

Features



- Guaranteed waterproof, sealed body that is immune to shock and vibration
- P2 output exceeds FMVSS 108 specifications
- Reliable performance over 100,000 hours
- Energy efficient: draws only 0.06A at 12V
- Easily mounts into standard 3/4" hole
- Lifetime warranty
- P2 rated sidemarker/clearance lamp for heavy duty trucks, semi-trailers, cargo trailers, boat trailers, work vehicles, and any motor vehicles requiring quality DOT rated lighting

**PC/P2
RATED**

Model S340

3/4" Mini Grommet Mounted Sidemarker



* Optional stainless steel trim ring

Features



- Guaranteed waterproof, sealed body that is immune to shock and vibration
- PC/P2 output exceeds FMVSS 108 specifications
- Reliable performance over 100,000 hours
- Energy efficient: draws only 0.07A at 12V
- Easily mounts into standard 3/4" hole
- Lifetime warranty
- PC/P2 rated sidemarker/clearance lamp for heavy duty trucks, semi-trailers, cargo trailers, boat trailers, work vehicles, and any motor vehicle requiring quality DOT rated lighting

**PC/P2
RATED**

Model S150 1"x 2" Surface Mounted Sidemarker

Features



- Guaranteed waterproof, sealed body that is immune to shock and vibration
- Exceeds FMVSS 108 standards
- Reliable performance over 100,000 hours
- Energy efficient: draws only 0.06A at 12V
- Standard non-polarized connector
- Lifetime warranty
- PC/P2 rated sidemarker/clearance lamp for heavy duty trucks, semi-trailers, cargo trailers, boat trailers, work vehicles, and any motor vehicle requiring quality DOT rated lighting



* Mounting bases available in chrome or black

**PC/P2
RATED**

Model S190 1"x 4" Surface Mounted Sidemarker

Features



- Guaranteed waterproof, sealed body that is immune to shock and vibration
- Exceeds FMVSS 108 standards
- Reliable performance over 100,000 hours
- Energy efficient: draws only 0.06A at 12V
- Standard non-polarized male connector
- Lifetime warranty
- P2/PC rated sidemarker/clearance lamp for heavy duty trucks, semi-trailers, cargo trailers, boat trailers, work vehicles, and any motor vehicle requiring quality DOT lighting



* Mounting bases available in chrome or black

**P2
RATED**

Model S300 2" Round Sidemarker



Features



- Guaranteed waterproof, sealed body that is immune to shock and vibration
- Exceeds FMVSS 108 standards
- Reliable performance over 100,000 hours
- Energy efficient: draws only 0.06A at 12V
- Standard non-polarized connector
- Lifetime warranty
- P2 rated sidemarker/clearance lamp for heavy duty trucks, semi-trailers, cargo trailers, boat trailers, work vehicles, and any motor vehicle requiring quality DOT rated lighting

**P2
RATED**

Model S100 2.5" Round Sidemarker w/ Reflector



Features



- Guaranteed waterproof, sealed body that is immune to shock and vibration
- Exceeds FMVSS 108 standards
- Reliable performance over 100,000 hours
- Energy efficient: draws only 0.06A at 12V
- Standard non-polarized connector
- Lifetime warranty
- P2 rated sidemarker/clearance lamp for heavy duty trucks, semi-trailers, cargo trailers, boat trailers, work vehicles, and any motor vehicle requiring quality DOT rated lighting

PC/P2
RATED

Model S220

2"x 6" Sidemarker w/ Reflector



Features



- Guaranteed waterproof, sealed body that is immune to shock and vibration
- Exceeds FMVSS 108 requirements when mounted properly
- Reliable performance over 100,000 hours
- Energy efficient: draws only 0.06A at 12V
- Lifetime warranty
- PC/P2 rated sidemarker/clearance lamp for heavy duty trucks, semi-trailers, cargo trailers, boat trailers, work vehicles, and any motor vehicle requiring quality DOT rated lighting

PC/P2
RATED

Model S360

4"x 0.75" Surface Mount Sidemarker

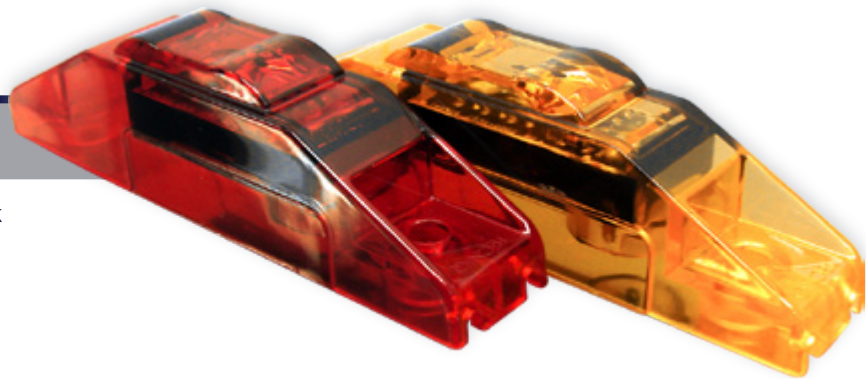

Features



- Guaranteed waterproof, sealed body that is immune to shock and vibration
- Exceeds FMVSS 108 standards when mounted horizontally
- Reliable performance over 100,000 hours
- Energy efficient: draws only 0.06A at 12V
- 180° output angle meets multiple sidemarker requirements when mounted properly
- Lifetime warranty
- PC/P2 rated sidemarker/clearance lamp for heavy duty trucks, semi-trailers, cargo trailers, boat trailers, work vehicles, and any motor vehicle requiring quality DOT rated lighting

**P2
RATED**

Model S210 2" Surface Mounted Sidemarker



* Optional
stainless steel
trim ring

Features



- Guaranteed waterproof, sealed body that is immune to shock and vibration
- Exceeds FMVSS 108 standards when mounted properly
- Reliable performance over 100,000 hours
- Energy efficient: draws only 0.06A at 12V
- Circular lens output increases mounting options
- Lifetime warranty
- P2 rated sidemarker/clearance lamp for heavy duty trucks, semi-trailers, cargo trailers, boat trailers, work vehicles, and any motor vehicle requiring quality DOT rated lighting

Model S900 Rugged Dual LED Fender Light



* S90-OB00-1



* Optional
stainless steel
trim ring

* Available with
two or four
mounting holes

Features



- Guaranteed waterproof, sealed body that is immune to shock and vibration
- Exceeds FMVSS 108 standards
- Reliable performance over 100,000 hours
- Energy efficient: draws only 0.06A at 12V
- Bi-color red/amber LED fender light
- Lifetime warranty
- P2 rated sidemarker/clearance lamp for heavy duty trucks, semi-trailers, cargo trailers, boat trailers, work vehicles, and any motor vehicle requiring quality DOT rated lighting

Model D04 & D14 Dragon Lights



* Vertical Mount



* Horizontal Mount
(Across Surface)



Features



- Guaranteed waterproof, sealed body that is immune to shock and vibration
- Reliable performance over 100,000 hours (color)
50,000 hours (white)
- Produces 32 lumens (white) while drawing only 0.06A at 12V
- Your choice of black, white or high polish stainless steel finish
- Mounts easily with just two #4 screws
- Lifetime warranty
- Perfect for: decks, cabinets, work areas, work vehicles, boat bulkheads and coolers, RV walkways, in-vehicle utility lighting, vehicle accent lighting (wheels, engines, undercarriage lighting), or anywhere you need a durable, waterproof light





Model E03 Eon Lights



* Vertical Mount



* Horizontal Mount
(Across Surface)

Features



- Guaranteed waterproof, sealed body that is immune to shock and vibration
- Reliable performance over 100,000 hours (color)
50,000 hours (white)
- Produces 150 lumens (white) while drawing only 0.12A at 12V
- Your choice of high polish stainless steel cases and multiple LED colors available
- Mounts easily with just two #6 screws
- Lifetime warranty
- Perfect for: decks, cabinets, work areas, work vehicles, boat bulkheads and coolers, RV walkways, in-vehicle utility lighting, vehicle accent lighting (wheels, engines, undercarriage lighting), or anywhere you need a durable, waterproof light



Model S330 Mini Accent Light



* Stainless steel
trim ring optional

Features



- Guaranteed waterproof, sealed body that is immune to shock and vibration
- Reliable performance over 100,000 hours (color)
50,000 hours (white)
- Energy efficient: draws only 0.06A at 12V
- Easily mounts into standard 3/4" hole
- Lifetime warranty
- Perfect for: decks, cabinets, work areas, work vehicles, in-vehicle utility lighting, or anywhere you need a durable, waterproof light

Model E410 LED Strip Lighting

180°



Features

- Shock and vibration proof, as well as moisture-resistant design
- Reliable performance over 50,000 hours
- Produces ≈ 150 lumens per section (white)
- Draws $\approx 0.10A$ at 12V per 4.5" section depending on color
- Available in custom lengths up to 16.5'
- Ultra thin 3/16" strips surface mounts easily in tight spaces
- Easy to install with 3M adhesive mount that stays in place
- High flexibility conforms to irregular surfaces
- Lifetime Warranty

* Interior and covered applications only



180°

Model D020 LED Pod Lighting

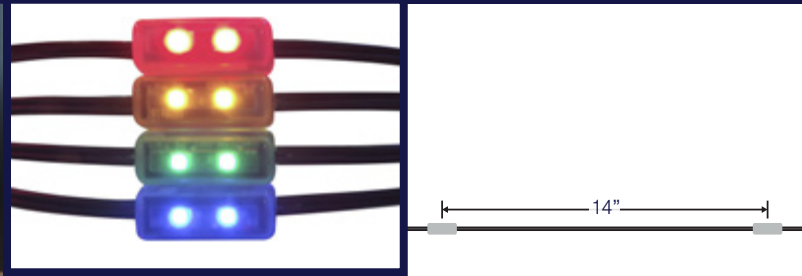

Features

- Guaranteed waterproof, sealed body that is immune to shock and vibration
- Reliable performance over 100,000 hours (color)
50,000 hours (white)
- Draws $\approx 0.03-0.08A$ at 12V depending on color
- Produces 50 lumens per LED pod (white)
- Solid body, high output, sealed LED construction
- Up to 100 lamps per string, spaced 14 inches
- Quickly repairable when single lamp is broken
- Easy to install with 3M adhesive mount that stays in place
- Lifetime warranty
- These versatile lights have more uses than just aerial ladders: decks, docks, countertops, cabinets, work areas, work vehicles, boat bulkheads and coolers, RV walkways



Model E100 6.5" LED Floodlight

Features



- Guaranteed waterproof, sealed body that is immune to shock and vibration
- Reliable performance over 50,000 hours
- Powerful multi-chip LEDs create 675 lumens of output while drawing only 0.50A at 12V
- Durable construction that can withstand the harshest conditions
- Available with or without the stainless steel bracket
- Lifetime warranty
- Extra wide area of illumination ($120^\circ \times 50^\circ$) covers many applications: task lighting, load lamp, ground lighting, panel lighting, and more

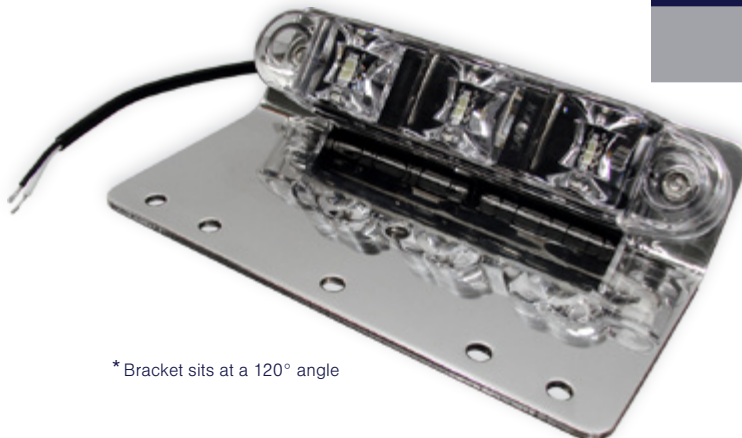

* Bracket sits at a 120° angle

Silho-X LED Area Lighting

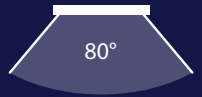

* 4" and 2.75" models also available in white/red combination option



* Ultra-thin (0.24") design fits anywhere you need it

Features

- Shock and vibration proof, as well as moisture-resistant design
- Reliable performance over 50,000 hours
- Extremely bright: produces

300 lumens (4.00" model)
150 lumens (2.75" model)
100 lumens (1.50" model)
- Energy efficient: at 12V, draws only

0.24A (4.00" model)
0.12A (2.75" model)
0.08A (1.50" model)
- Quickly mounts using

two #4 screws (1.50" & 2.75" models)
two #6 screws (4.00" models)
- Highly-polished stainless steel trim with other finishes and frosted lens available
- Lifetime warranty
- Perfect for: Countertops, cabinets, work areas, RV walkways, in-vehicle utility lighting, toolboxes or anywhere you need durable, low profile light.

Silho-X 2.75" LED Accent Lighting

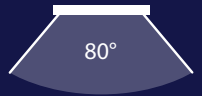

Features

- Shock and vibration proof, as well as moisture-resistant design
- Reliable performance over 100,000 hours (color)
50,000 hours (white)
- Extremely bright: produces 150 lumens
- Energy efficient: at 12V, draws only 0.12A
- Quickly mounts using just two #4 screws, neatly hidden behind lens
- Lifetime warranty
- Perfect for: Countertops, cabinets, work areas, RV walkways, in-vehicle utility lighting, toolboxes or anywhere you need durable, low profile light.





180°

Model E340 3/4" Grommet Mount Step Accent Light



Features



- Guaranteed waterproof, sealed body that is immune to shock and vibration
- Miniature size and low profile reduces damage
- Reliable performance over 100,000 hours (color)
50,000 hours (white)
- Only draws 0.07A at 12V
- Easily mounts into standard 3/4" hole
- Lifetime warranty
- Perfect for: Countertops, cabinets, work areas, RV walkways, in-vehicle utility lighting, toolboxes or anywhere you need small, durable lighting



180°

Model E160 Surface-Mounted Dome Light

Features



- Shock and vibration proof, as well as moisture resistant design
- Reliable performance over 50,000 hours
- Six high-efficiency LEDs provide over 300 lumens of light while drawing only 0.24A at 12V
- Sleek and stylish surface mount design
- Available with or without mounted switch
- Easy to install with just 4 screws hidden behind lens
- Lifetime warranty



Model E180 4.5" LED Utility Light

180°

Features

- Surface mounted for ease of installation – requires one 3/8" wire hole
- Shock and vibration proof, as well as moisture-resistant design
- Reliable performance over 50,000 hours
- Output of 800 lumens
- Made with high grade polycarbonate, for high optic quality and impact resistance
- Energy efficient: at 12V, draws only 0.6A
- Lifetime warranty



* Available with or without integrated power switch

Orion 6" LED Dome Light

180°



* Also available in white/red combination option



Features

- Shock and vibration proof, as well as moisture-resistant design
- Reliable performance over 50,000 hours
- Output of 720 lumens at less than 8 watts of power
- Energy efficient: at 12V, draws only 0.65A
- Stylish, ultra-thin surface-mount construction
- Quickly mount using two screws neatly hidden by lens
- Lifetime warranty



Models E27 & E28 Surface Mounted Dome Light

NEW



* 3" Model (E27) Pictured at actual size



* Available in 3" Model (E27) and 4.5" Model (E28)

Features

- Surface mounted for easy installation – requires 3/8" wire hole
- 4.5" Premium model available
- Bright: 150 Lumens (3.0" model)
300 Lumens (4.5" model)
460 Lumens (4.5" premium model)
- Low amp draw: 1.2 A @ 12.8vdc (3.0" model)
2.5 A @ 12.8vdc (4.5" model)
3.8 A @ 12.8vdc (4.5" premium model)
- Features diffused lens with chrome finish trim ring
- Available with or without on/off push button switch
- Three mounting screws concealed by chrome trim ring.
- Reliable performance over 50,000 hours
- Lifetime warranty



Models E25 & E26 Spring Mounted Dome Light

NEW



* 3" Model (E25) Pictured at actual size



* Available in 3" Model (E25) and 4.5" Model (E26)

Features

- New spring mounted design comes in 3" and 4.5" sizes
- Shock and vibration proof
- Bright: 150 Lumens (3.0" model)
300 Lumens (4.5" model)
460 Lumens (4.5" premium model)
- Low amp draw: 1.2 A @ 12.8vdc (3.0" model)
2.5 A @ 12.8vdc (4.5" model)
3.8 A @ 12.8vdc (4.5" premium model)
- Features diffused lens, clean low profile appearance
- Available with or without on/off push button switch
- Reliable performance over 50,000 hours
- Lifetime warranty

Model E960 LED Spot/Flood Light

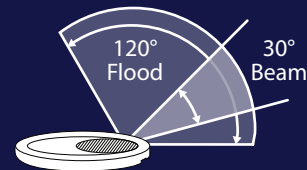

Features

- Guaranteed waterproof, sealed body that is immune to shock and vibration
- Reliable performance over 50,000 hours
- Produces 900 lumens while drawing only 0.65A at 12V
- Surface mount design increases your mounting options and eliminates large oval holes
- Anodized, die-cast, marine-grade, aluminum body with a stainless steel cover
- Primary spot output is 30° from mounting surface
- Secondary rectangular flood output used for area illumination
- Lifetime warranty
- Typical applications include: marine docking lights (boat headlamps), truck and trailer supplemental reverse lighting, or vehicle exterior lighting



* Pictured as supplemental reverse light



Model E390 Fluorescent Light LED Conversion Kit

NEW

Features

- LED replacement lighting for fluorescent lighting fixture
- Long lasting: 50,000 hour service life
- Extremely bright: produces 700 lumens (12" model)
1400 lumens (18" model)
- Energy efficient: only draws 1.7A @ 12V
- Lifetime warranty



* Easy-to-install adhesive backing



* White/red combination available



180°

NEW

Model T440 4" Round Flush Mount Dome Light



Features



- Guaranteed waterproof, sealed body that is immune to shock and vibration
- Reliable performance over 50,000 hours
- Produces 480 lumens (white) while drawing only 0.25A at 12V
- Mounts with standard grommets or our anti-theft trim ring
- Lifetime warranty

180°

Model E350/E360/E380 Surface Mount Linear LED Light



Features

- Shock and vibration proof, as well as moisture-resistant construction
- Reliable performance over 50,000 hours
- At 12V produces

750 lumens while drawing 0.65A (13")
1500 lumens while drawing 1.30A (20")
3000 lumens while drawing 2.60A (35")
- Choose from three lengths
- Easy replacement for fluorescent light fixtures
- 180° wide light-beam illuminates large area
- AccuColor LEDs available for natural color rendering
- Quick and easy mounting with two screws
- Lifetime warranty

* Pictured with pushbutton switch



Model E300 Recessed High Output Dome Light

180°



Features



- Shock and vibration proof, as well as moisture-resistant design
- NFPA and Triple K compliant for existing and proposed regulations
- Reliable performance over 50,000 hours
- Powerful 1050-2100 lumen output
- Energy efficient: draws $\approx 0.80\text{A}$ - 1.65A at 12V depending on color options
- AccuColor LEDs render light in the warm 4000K range for more natural skin tones
- Available with 21 or 42 LEDs that minimize bright spots and reduce shadows
- Excellent replacement for fluorescent light fixtures
- Available options of mounted switch or motion detection sensor
- Red/white combination lamps are available for tactical vision applications
- Lifetime warranty



* Pictured with rocker switch



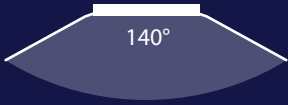

Model E070 8" Recessed Interior Light



Features

- Shock and vibration proof, as well as moisture resistant design
- Exceeds Triple K requirements
- Reliable performance over 50,000 hours
- Produces 840 lumens while drawing only 1.30A at 12V
- High quality LEDs that won't change color over time
- Lifetime warranty

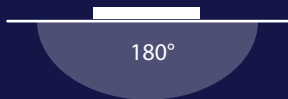

Model E080 8" Recessed Dome Light



Features



- Shock and vibration proof, as well as moisture resistant design
- NFPA and Triple K compliant for existing and proposed regulations
- Reliable performance over 50,000 hours
- Powerful output of 1000 (18 LED) or 1500 (31 LED) lumens illuminates a wide area
- Can be powered by any DC source between 12V and 24V
- Energy efficient: draws \approx 1.30A at 12V, half that at 24V
- AccuColor LEDs provide superior color rendering for more natural skin tones to facilitate a more accurate diagnosis in medical lighting situations
- Smooth lens is easy to wipe clean
- Lifetime warranty

Model K400

5"x 3.3" Emergency Flasher

NEW

Features



- Guaranteed waterproof, sealed body that is immune to shock and vibration
- Meets all NFPA 1901 and Triple K specifications, including upcoming regulations
- Powerful 5"x 3.3" warning lamp fits standard mounting holes
- Patent-pending AutoSync technology means all TecNiq flashers are synchronized without requiring a separate control box
- Steady burn model also available for all colors
- Sequential arrow pattern available
- Lifetime warranty



* Chrome bezel and gasket kit sold separately

Model K500

5"x 2" Emergency Flasher

NEW

Features



- Guaranteed waterproof, sealed body that is immune to shock and vibration
- Meets all NFPA 1901 and Triple K specifications, including upcoming regulations
- Powerful 5"x 2" warning lamp fits standard mounting holes
- Patent-pending AutoSync technology means all TecNiq flashers are synchronized without requiring a separate control box
- Steady burn model also available for all colors
- Lifetime warranty



* Chrome bezel and gasket kit sold separately

Model K600

6"x 4" Emergency Flasher



* Chrome bezel and gasket kit sold separately

Features



- Guaranteed waterproof, sealed body that is immune to shock and vibration
- Meets all NFPA 1901 and Triple K specifications, including upcoming regulations
- Powerful 6"x 4" warning lamp fits standard mounting holes
- Patent-pending AutoSync technology means all TecNiq flashers are synchronized without requiring a separate control box
- Steady burn model also available for all colors
- Sequential arrow pattern available
- DOT stop/turn/tail reverse lamp compliance mode available on all lamps
- Lifetime warranty

Model K700

7"x 3" Emergency Flasher



* Chrome bezel and gasket kit sold separately

Features



- Guaranteed waterproof, sealed body that is immune to shock and vibration
- Meets all NFPA 1901 and Triple K specifications, including upcoming regulations
- Powerful 7"x 3" warning lamp fits standard mounting holes
- Patent-pending AutoSync technology means all TecNiq flashers are synchronized without requiring a separate control box
- Steady burn model also available for all colors
- DOT stop/turn/tail/reverse lamp compliance mode available on all lamps
- Lifetime warranty

Model K900

9"x 7" Emergency Flasher

Features



- Guaranteed waterproof, sealed body that is immune to shock and vibration
- Meets all NFPA 1901 and Triple K specifications, including upcoming regulations
- Powerful 9"x 7" warning lamp fits standard mounting holes
- Patent-pending AutoSync technology means all TecNiq flashers are synchronized without requiring a separate control box
- DOT stop/turn/tail/reverse lamp compliance mode available on all lamps
- Chrome trim and gasket included with all K900 lights
- Lifetime warranty



TecNiq Inc. Emergency Scene Lighting

Features



- Guaranteed waterproof, sealed body that is immune to shock and vibration
- Meets all NFPA 1901 and Triple K specifications, including upcoming regulations
- Powerful TecNiq scene lighting fits standard mounting holes for easy upgrade
- Light beam from horizontal to the base of the vehicle ensures continual ground coverage
- 5000K LEDs provide natural color balance
- Over 2,500 source lumens projected through high-efficiency optics
- Lifetime warranty



* K900 style output beam exceeds all ground specifications on small vehicles with a single lamp

Wires, Connectors, and Accessories

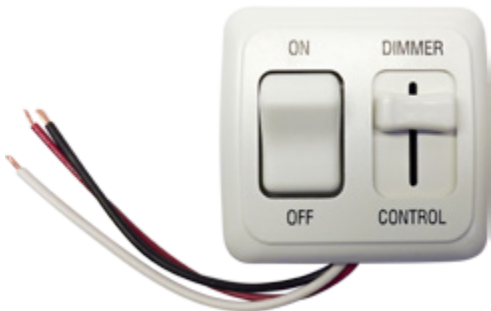

**Slide Dimmer
(E99-D002-1)**



**Rotary Dimmer
(E99-D001-1)**



**S35 Right Angle - 2 Pole
(S99-0035-1)**



**.156" Bullet Right Angle - 2 Pole
(S99-0010-1)**

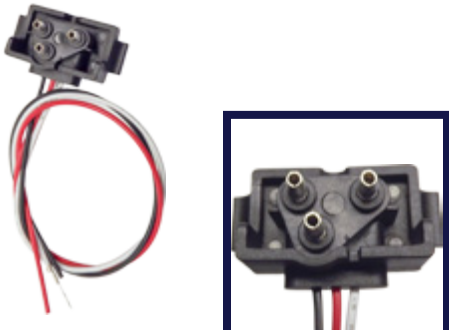

**Right Angle - Tri-pole
(T99-0020-1)**

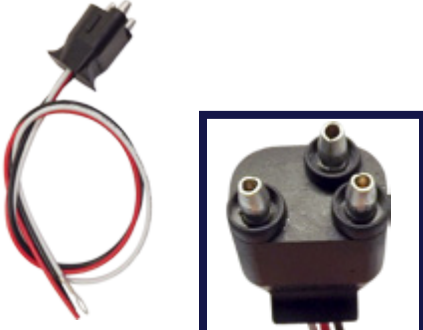

**Straight - Tri-pole
(T99-0010-1)**

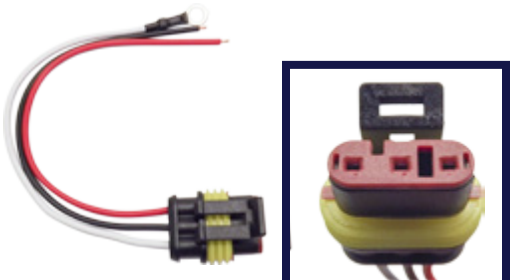

**Straight - Amp Connection
(T99-0040-1)**

* Other connector options available upon request

TecNiq Inc Lighting Displays



**Interior Lighting Display Kit
(P01-INT0-1)**



**Ambulance Lighting Display Kit
(P01-AMB0-1)**



**Emergency Vehicle Display Kit
(P01-EVM0-1)**



**DOT Lighting Display Kit
(P01-D0T0-1)**

NFPA 1901/1917 Exterior Warning Lighting Minimum Requirements

The warning lights have two separate operating modes with two corresponding specifications.

1. Calling for the right of way (Responding)
2. Blocking the right of way (At the Scene)
3. Flasher Color Specifications

Function	Red	Blue	Amber	White
RESPONDING	Any Zone		Any Zone except A	Any Zone except C
AT THE SCENE	Any Zone			Not Permitted

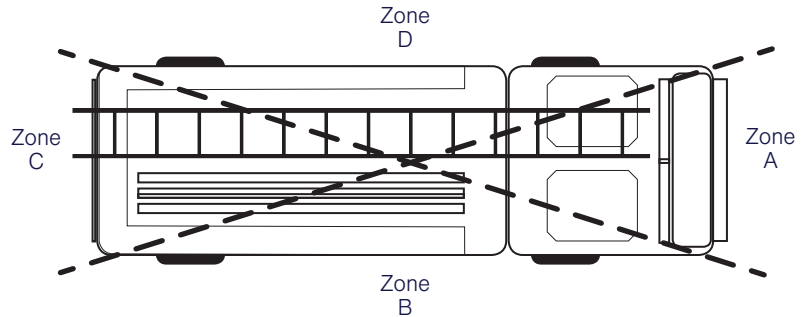

Large Apparatus - Greater than 25'

Responding	Zone A		Zone B		Zone C		Zone D	
	Upper	Lower	Upper	Lower	Upper	Lower	Upper	Lower
H	1,000,000	150,000	400,000	150,000	400,000	150,000	400,000	150,000
ANY H POINT	10,000	3,750	10,000	3,750	10,000	3,750	10,000	3,750
+/- 5° ANY H	3,500	1,300	3,500	1,300	3,500	1,300	3,500	1,300

At The Scene	Zone A		Zone B		Zone C		Zone D	
	Upper	Lower	Upper	Lower	Upper	Lower	Upper	Lower
H	400,000	150,000	400,000	150,000	800,000	150,000	400,000	150,000
ANY H POINT	10,000	3,750	10,000	3,750	10,000	3,750	10,000	3,750
+/- 5° ANY H	3,500	1,300	3,500	1,300	3,500	1,300	3,500	1,300

A large apparatus is categorized as a vehicle with a length of greater than twenty-five (25) feet. They are divided into four (4) separate zones, each divided into upper and lower.

For lower levels of Zones B & D, distances between optical warning devices may not exceed twenty five (25) feet. Additional mid-ship devices are required.

NOTE: All values are in candela-seconds/minute. H= Horizontal plane passing through the optical center

Small Apparatus - Less than 25'

Responding	Zone A	Zone B	Zone C	Zone D
	Upper & Lower Combined			
H	1,000,000	200,000	400,000	200,000
ANY H POINT	10,000	8,000	10,000	8,000
+/- 5° ANY H	3,500	3,500	3,500	3,500

At The Scene	Zone A	Zone B	Zone C	Zone D
	Upper & Lower Combined			
H	1,000,000	200,000	400,000	200,000
ANY H POINT	10,000	8,000	10,000	8,000
+/- 5° ANY H	3,500	3,500	3,500	3,500

A small apparatus is categorized as a vehicle with a bumper to bumper length of less than twenty-five (25) feet. They have four (4) separate zones. The specifications for each zone include both upper and lower lights. Refer to the NFPA 1901 Standard for Automotive Fire Apparatus, Chapter 13 Low Voltage Electrical Systems and Warning Devices.

NOTE: All values are in candela-seconds/minute. H= Horizontal plane passing through the optical center

Basic Equipment Required on All Trucks, Buses, & MPVs

	DESCRIPTION				MANDATORY REQUIREMENTS		
	Equipment	(SAE Lens Coding)	Functional Purpose	QTY	Color	Location	Height (in.) From Ground
1	Headlamps - Lower Beam -US requires "DOT" lettering on lens -US & Canada require light source code on lens	(H, HR)	Forward road illumination	Min 2	White	On front - symmetrical - as far apart as practicable - 4 lamp system - outboard or above upper beams	22"- 54"
	Headlamps - Upper Beam -US requires "DOT" lettering on lens -US & Canada require light source code on lens	(H, HR)	Forward road illumination	Min 2	White	On front - symmetrical - 4 lamp system - inboard or below lower beams	22"- 54"
	Parking Lamps -Vehicles less than 80" wide	(P)	Indicate parked vehicle	Min 2	White/ Amber	On the front - symmetrical - as far apart as practicable	15"- 72"
	Daytime Running Lamps -US - Optional - requires "DRL" lettering if not headlamp -Canada - Required	(Y2)	Indicate in use vehicle	Min 2	White/ Amber		15" minimum *Max depends on type
	Front Turn Signal/ Hazard Warning Lamps	(I)	Indicates direction of turn/identify disabled vehicle	Min 2	Amber	On the front - symmetrical - as far apart as practicable	15"- 83"
2 Front Clearance Lamps -Vehicles 80" wide or wider	(P2, PC* or P3, PC2*)	Show vehicle's width	Min 2	Amber	At widest point - symmetrical - as far forward as practicable - facing forward	As high as practicable	
3 Front Identification Lamps (ID) -Vehicles 80" wide or wider	(P2 or P3)	Indicate presence of a wide vehicle	Exactly 3	Amber	On the front - center - horizontally spaced 6"- 12" apart	As high as practicable or on top of the cab	
4a Front Side Marker Lamps	(P2, PC* or P3, PC2*)	Indicate vehicle presence & length	Min 2	Amber	Each side at front - as far forward as practicable	15" minimum	
4b Front Side Reflex Reflectors	(A)		Min 2	Amber	Each side at front - as far forward as practicable facing sideward	15"- 60"	
5a Rear Side Marker Lamps	(P2, PC* or P3, PC2*)	Indicate vehicle presence & length	Min 2	Red	Each side at rear - as far back as practicable	15" minimum	
5b Rear Side Reflex Reflectors	(A)		Min 2	Red	Each side at rear - as far back as practicable facing sideward	15"- 60"	
6 Rear Clearance Lamps -Vehicles 80" wide or wider -Not required on truck tractors	(P2, PC* or P3, PC2*)	Show's veh. width- MAY NOT be combined with tail lamps	Min 2	Red	At widest point - symmetrical - on the rear or near the rear - facing Rearward	15" minimum	
7 Rear Identification Lamps -Vehicles 80" wide or wider -Not required on truck tractors	(P2 or P3)	Indicate Presence of Long Vehicle	Exactly 3	Red	On the rear - center, facing rearward - horizontally spaced 6"- 12" apart	15"- 60"	
8	Tail Lamps	(T)	Indicate vehicle's presence and width	Min 2	Red	On the rear - symmetrical as far apart as practicable	15"- 72"
	Stop Lamps	(S)	Indicate Braking	Min 2	Red		15"- 83"
	Rear Turn Signal/ Hazard Warning Lamps	(I)	Indicate direction of turn/ identify disabled vehicle	Min 2	Red/ Amber		15"- 60"
	Rear Reflex Reflectors	(A)	Show vehicle's presence and width	Min 2	Red		15"- 60"
9 Backup Lamp	(R)	Illuminates ground behind the vehicle and alert road users	Min 1	White	Rear	No requirement	
10 License Plate Lamp(s)	(L)	Illuminates license plate	Min 1	White	On the rear - above or at the sides of license plate	No requirement	
11 Center High Mounted Stop Lamp	(U3)	Indicates Braking	Min 1	Red	On the rear - centerline of the vehicle	34" minimum	

*Photometrically certified at installation angle

Lenth - 30' or longer

	DESCRIPTION				MANDATORY REQUIREMENTS		
	Equipment	(SAE Lens Coding)	Functional Purpose	QTY	Color	Location	Height (in.) From Ground
12a	Intermediate Side Marker Lamps	(P2 or P3)	Indicate presence of long vehicle	Min 2	Amber	Each side near center	15" minimum
12b	Intermediate Side Reflex Reflectors	(A)	Indicate presence of long vehicle	Min 2	Amber	Each side near center - Facing Sideward	15"- 60"

Truck Tractors

	DESCRIPTION				MANDATORY REQUIREMENTS		
	Conspicuity Treatment	DOT Coding	QTY	Color	Location	Height (in.) From Ground	Options
9	Rear Upper Body Marking	DOT-C, DOT-C2, DOT-C3, DOT-C4	Exactly 2 pairs of 300mm (11.8") long strips	White	On the rear upper corners of cab - facing rearward	At the top	Rear lower body and side conspicuity treatment may also be solid white, solid amber, or white and amber.
11	Rear Marking		Exactly 2 sections of min 600mm (24") long strips	Red/White	Rear - facing rearward - on fenders, on mud flap brackets, or within 300mm below top of mudflaps	As horizontal and as close to the range of 15"- 60" from ground as practicable	

Basic Equipment Required on All Trailers

DESCRIPTION		MANDATORY REQUIREMENTS					
Equipment	(SAE Lens Coding)	Functional Purpose	QTY	Color	Location	Height (in.) From Ground	
1	Tail Lamps	(T)	Indicate vehicle presence & width	Min 2	Red	On the rear - symmetrical - as far apart as practicable	15"- 72"
	Stop Lamps	(S)	Indicate braking	Min 2	Red		15"- 72"
	Rear Turn Signal Lamps	(I)	Indicate direction of turn	Min 2	Red/ Amber		15"- 83"
	Rear Reflex Reflectors	(A)	Indicate vehicle presence & width	Min 2	Red		15"- 60"
2	License Plate Lamps	(L)	Illuminate license plate	Min 1	White	On the rear - above or at the sides of license plate	No requirement
3	Rear Side Marker Lamps	(P2, PC* or P3, PC2*)	Indicate vehicle presence & length	Min 2	Red	Each side at rear - as far back as practicable	15"- 60" (no max. for vehicles under 80" wide)
	Rear Side Reflex Reflectors	(A)		Min 2	Red	Each side at rear - as far back as practicable facing sideward	15"- 60"
4a	Front Side Marker Lamps	(P2, PC* or P3, PC2*)	Indicate vehicle presence & length	Min 2	Amber	Each side at front - as far forward as practicable	15" minimum
4b	Front Side Reflex Reflectors	(A)		Min 2	Amber	Each side at front - as far forward as practicable facing sideward	15"- 60"

*Photometrically certified at installation angle

Length - 30' or longer

DESCRIPTION		MANDATORY REQUIREMENTS					
Equipment	(SAE Lens Coding)	Functional Purpose	QTY	Color	Location	Height (in.) From Ground	
5a	Intermediate Side Marker Lamps	(P2 or P3)	Indicate presence of long vehicle	Min 2	Amber	Each side near center - Facing Sideward	15" minimum
5b	Intermediate Side Reflex Reflectors	(A)	Indicate presence of long vehicle	Min 2	Amber		15"- 60"

Width - 80" or wider

DESCRIPTION		MANDATORY REQUIREMENTS					
Equipment	(SAE Lens Coding)	Functional Purpose	QTY	Color	Location	Height (in.) From Ground	
6	Rear Clearance Lamps	(P2, PC* or P3, PC2*)	Shows veh. width- MAY NOT be combined with tail lamps	Min 2	Red	At widest point - symmetrical - on or near the rear - facing Rearward	15" minimum
7	Rear Identification Lamps	(P2 or P3)	Indicate Presence of Long Vehicle	Exactly 3	Red	On the rear - center, facing rearward - horizontally spaced 6"- 12" apart	15"- 60"
8	Front Clearance Lamps	(P2, PC* or P3, PC2*)	Show Vehicle's Width	Min 2	Amber	At widest point - symmetrical - as far forward as practicable - facing forward	As high as practicable

*Photometrically certified at installation angle

Width - 80" or wider AND GVWR of 10,000 lbs or MORE

DESCRIPTION		MANDATORY REQUIREMENTS					
Conspicuity Treatment	DOT Coding	QTY	Color	Location	Height (in.) From Ground	Options	
9	Rear Upper Body Marking	DOT-C, DOT-C2, DOT-C3, DOT-C4	Exactly 2 pairs of 300mm (11.8") long strips	White	On the rear upper corners - facing rearward	At the top	Rear lower body and side conspicuity treatment may also be solid white, solid amber, or white and amber.
10	Bumper Bar Marking		Continuous	Red/White	On the rear bumper bar's horizontal element - full width - facing rearward	No requirement	
11	Rear Lower Body Marking		Continuous	Red/White (see options)	On the rear - full width of the vehicle - facing rearward	As horizontal and as close to the range of 15"- 60" from ground as practicable	
12	Side Marking		see location	Red/White (see options)	Each side - facing sideward - continuous, or evenly spaced over minimum of 50% of length, starts and ends as close to the front and rear of vehicle as practicable		
- Reflex reflectors may not be required if they are replaced, in their required location, with conspicuity treatment (Optional in Canada).							

Truck, Bus, & MPV Requirements

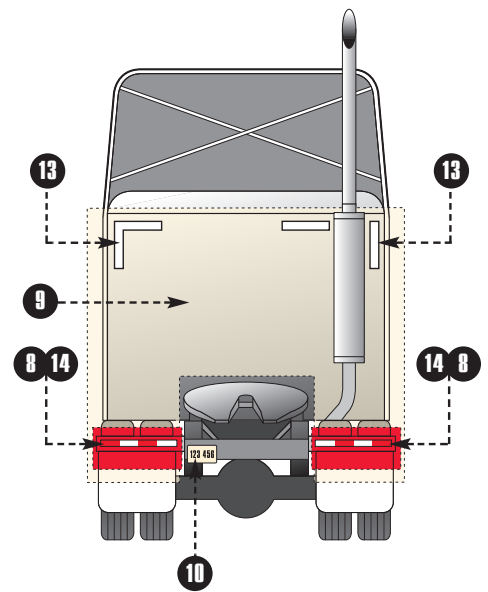
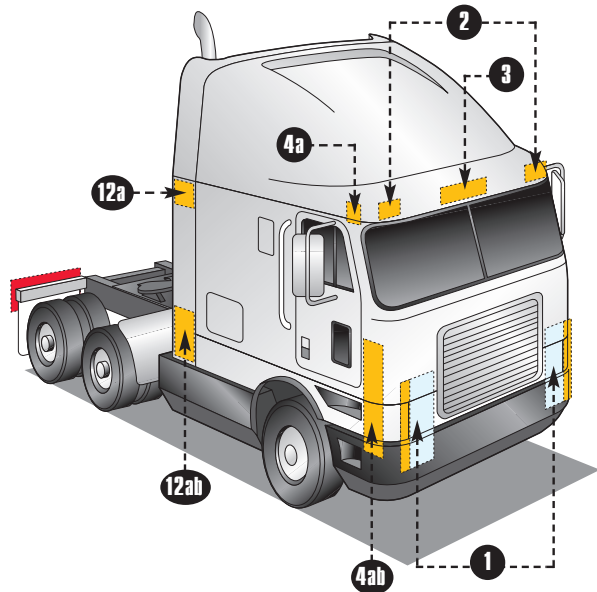
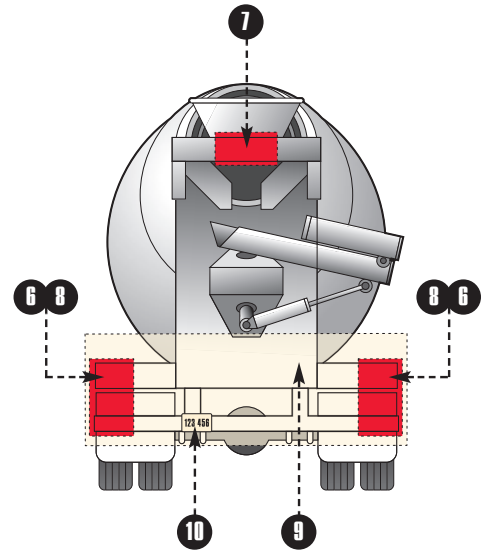
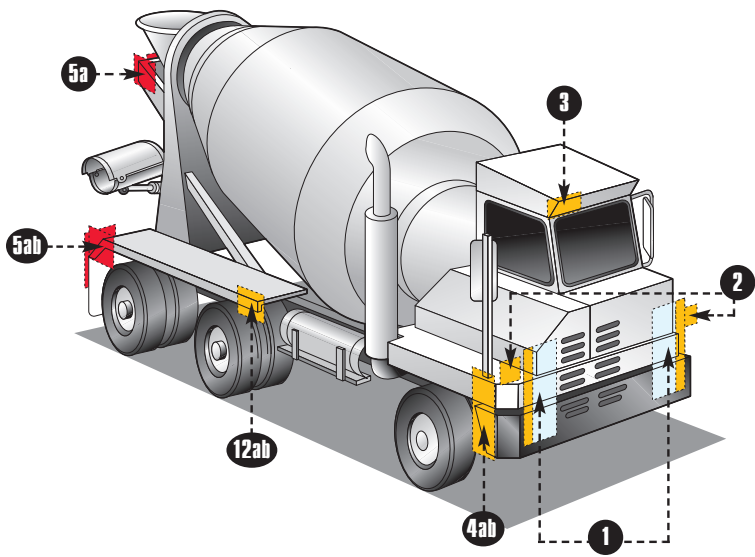
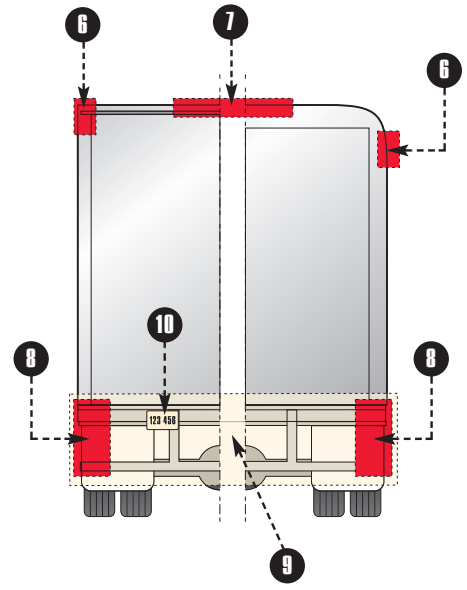
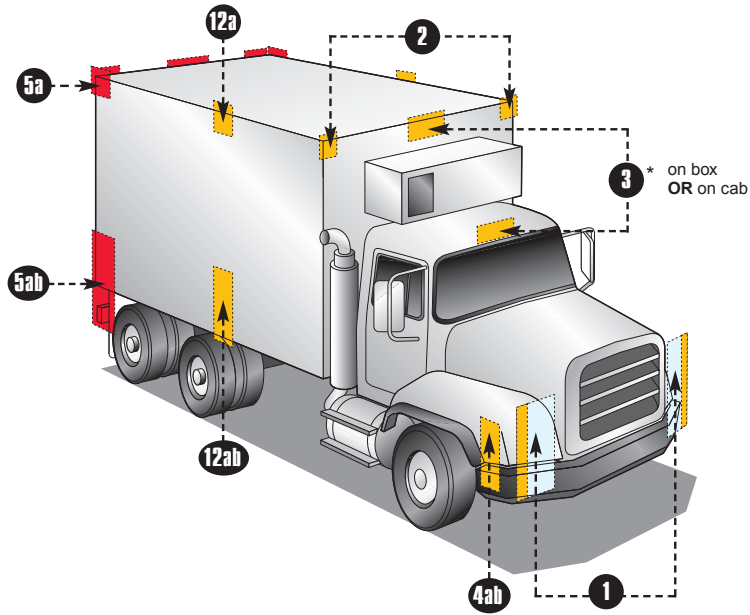

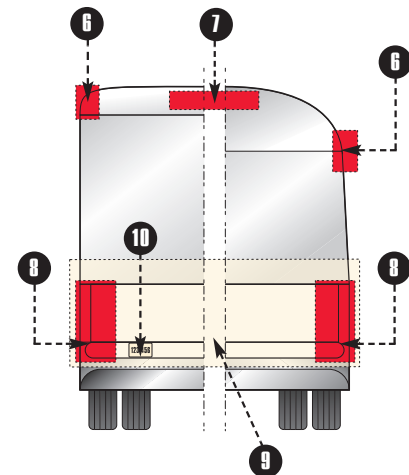
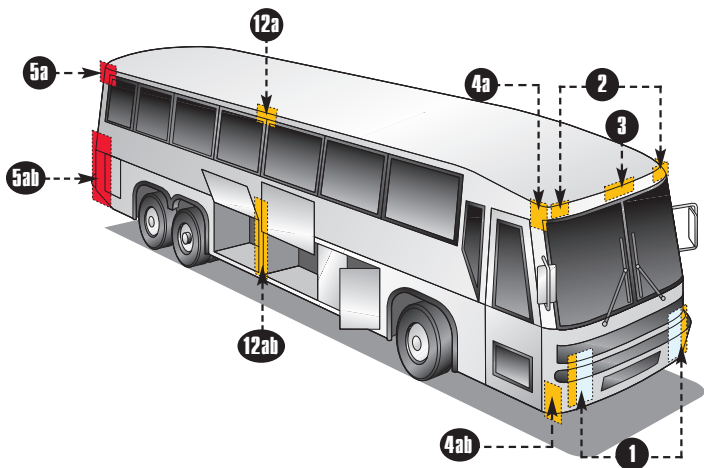
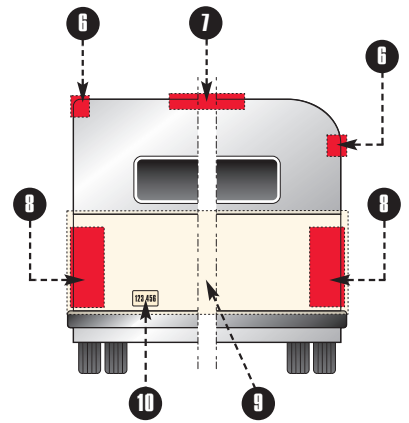
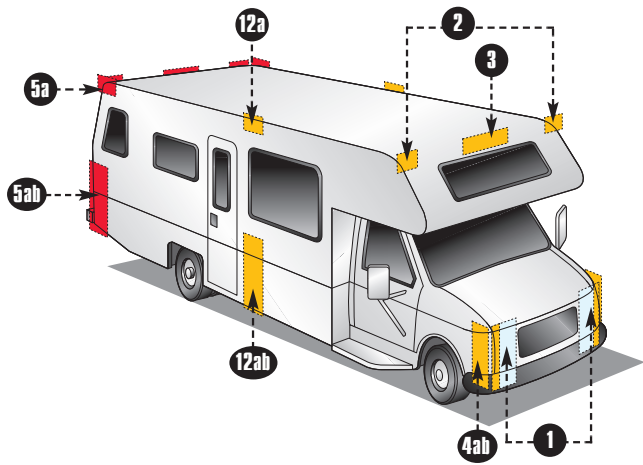
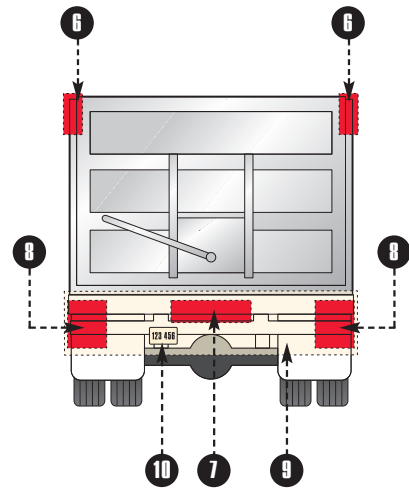
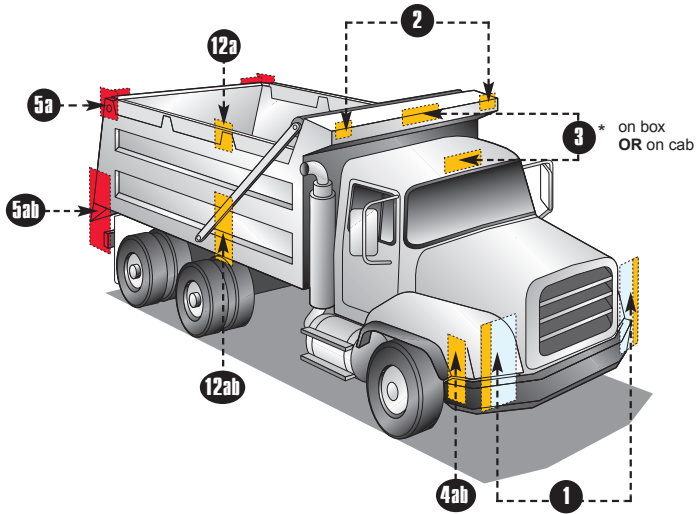
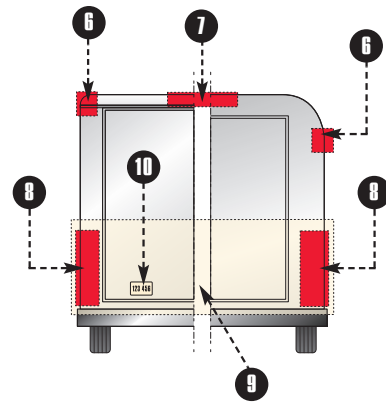
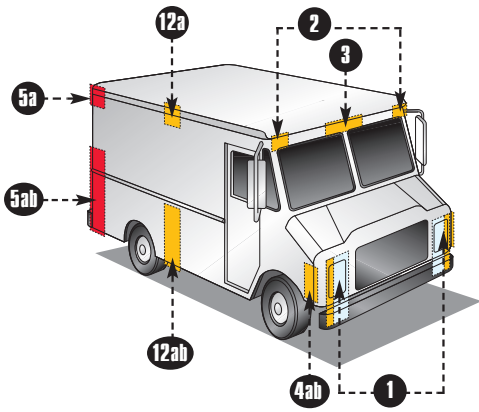



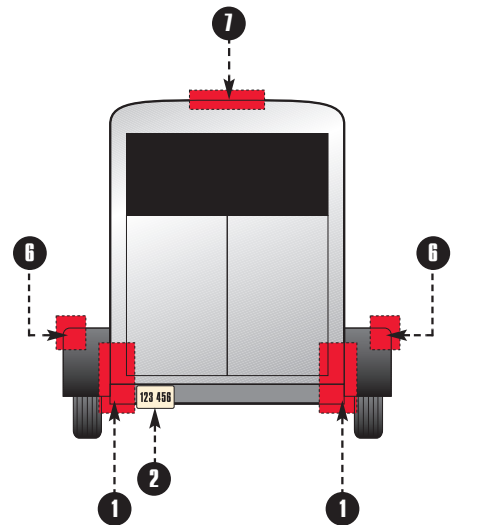
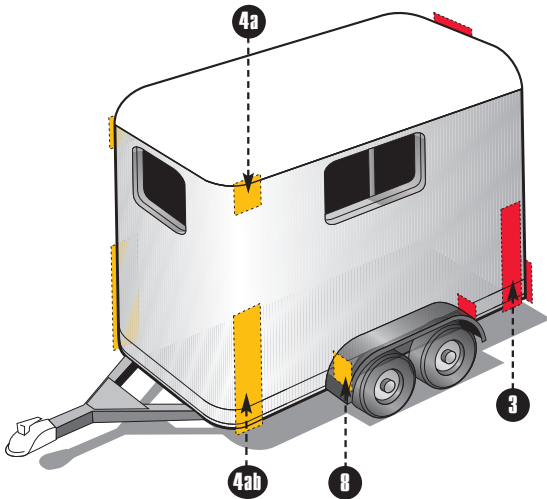
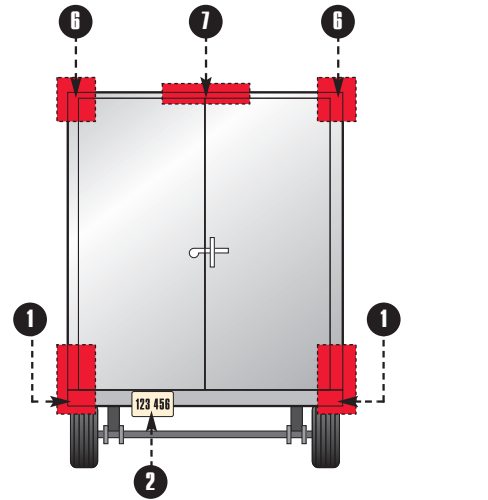
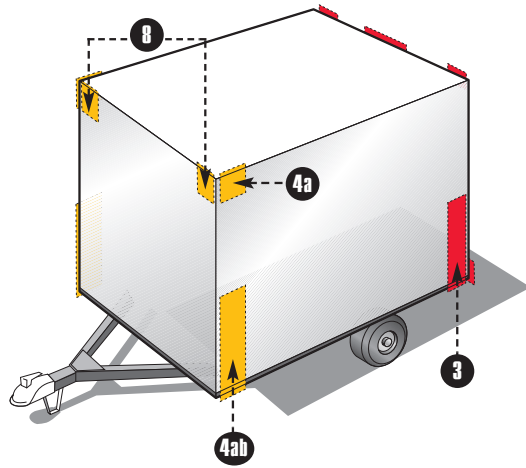
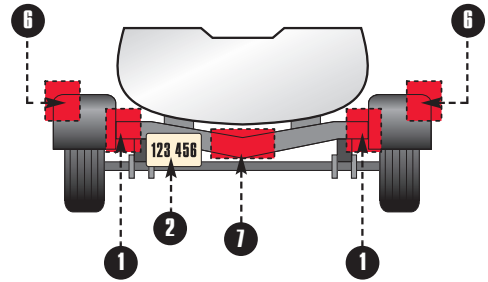
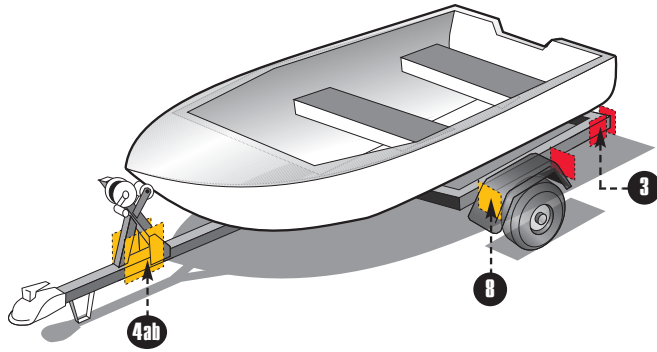
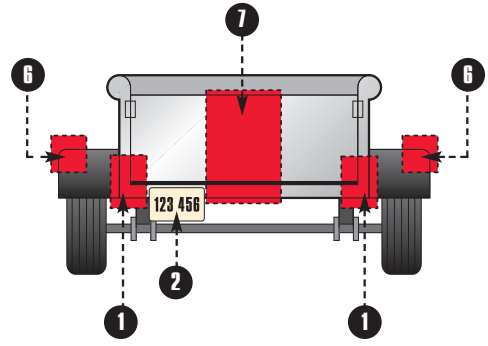
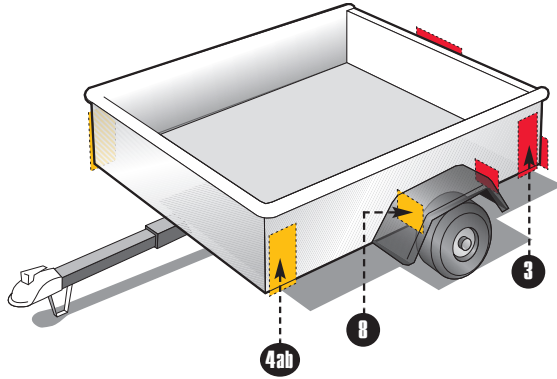

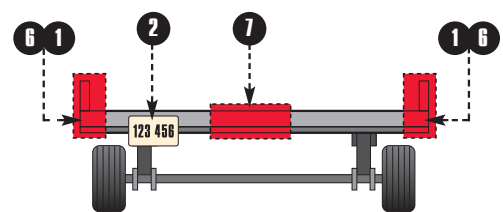
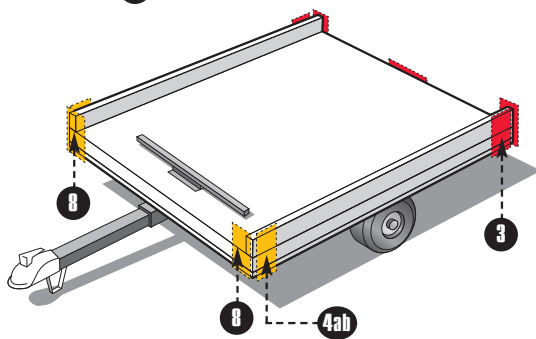
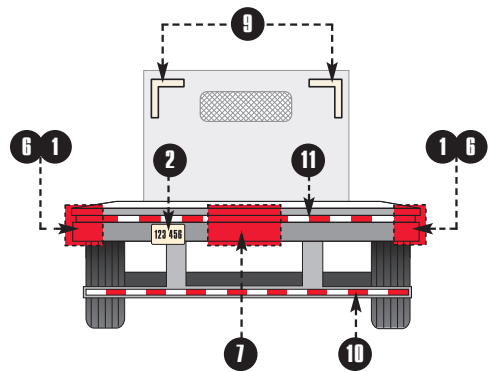
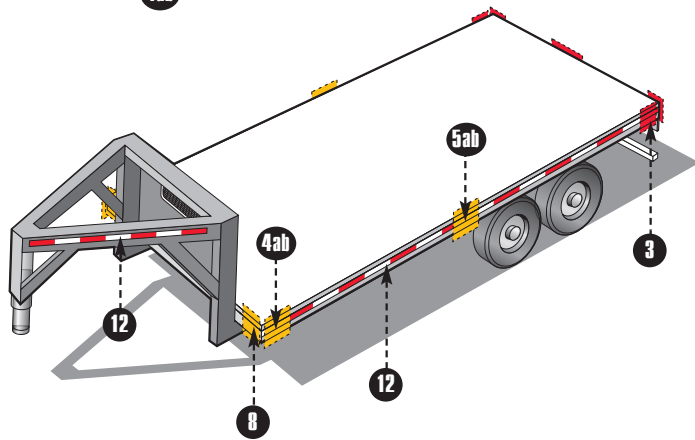
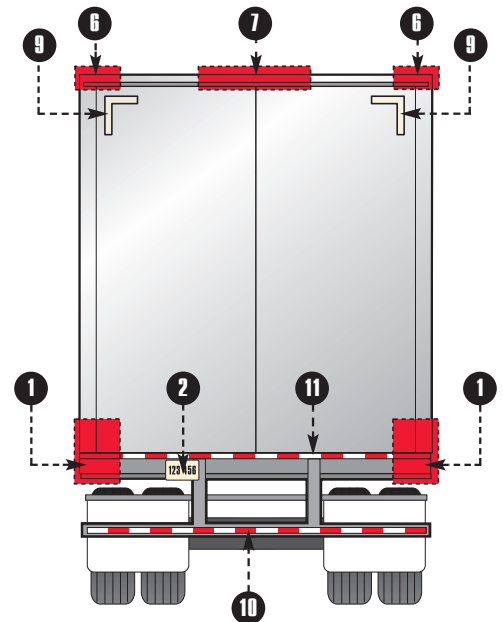
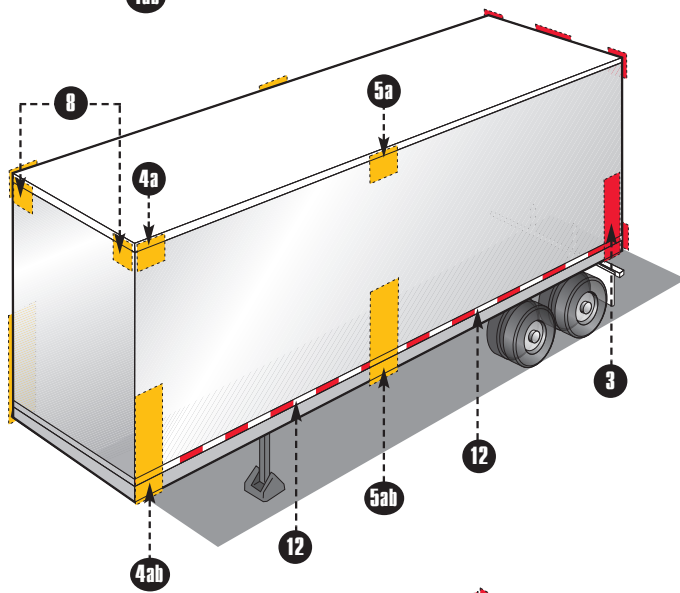
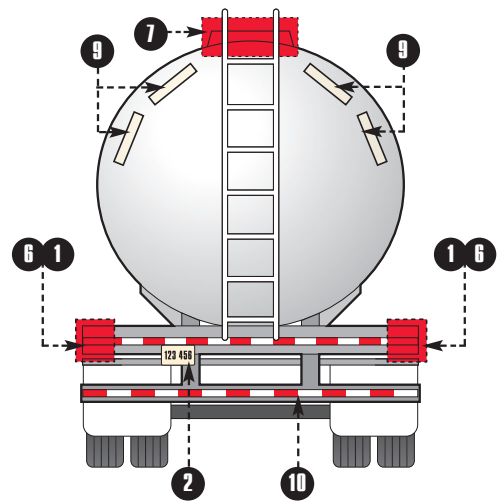
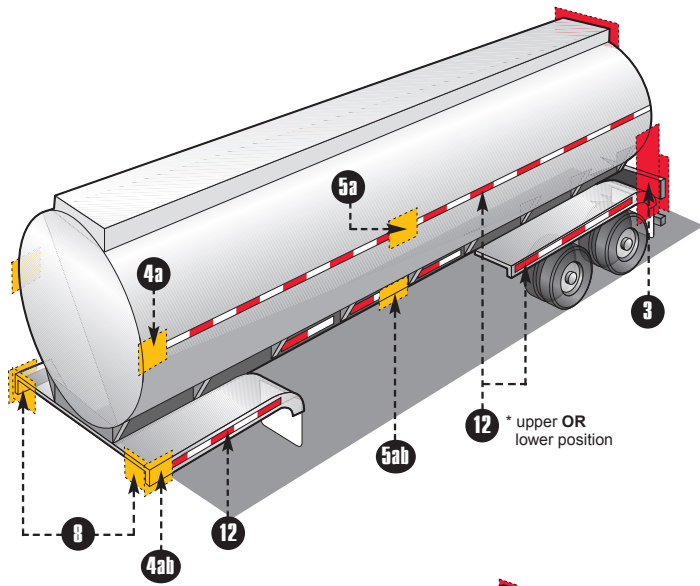



















































































































































Trailer Requirements















































































































































































































Part No.	Part Description	Color	STD Pack	Wire/Conn
D02 - Ladder Lights				Pg 21
D02-A001-1	Amber Ladder Light – 14" Length Section	 		Made to Order
D02-B001-1	Blue Ladder Light – 14" Length Section	 		Made to Order
D02-G001-1	Green Ladder Light – 14" Length Section	 		Made to Order
D02-R001-1	Red Ladder Light – 14" Length Section	 		Made to Order
D02-W001-1	White Ladder Light – 14" Length Section	 		Made to Order
D04 - Dragon Light - Linear Series				Pg 18
D04-0BH0-1	Dragon Light Linear Horizontal Case – Black	- -	50	9" Pigtail
D04-0BV0-1	Dragon Light Linear Vertical Case – Black	- -	50	9" Pigtail
D04-0SH0-1	Dragon Light Linear Horizontal Case – SS	- -	50	9" Pigtail
D04-0SV0-1	Dragon Light Linear Vertical Case – SS	- -	50	9" Pigtail
D04-0WH0-1	Dragon Light Linear Horizontal Case – White	- -	50	9" Pigtail
D04-0WV0-1	Dragon Light Linear Vertical Case – White	- -	50	9" Pigtail
D04-A000-1	Dragon Light Linear Body Amber – 9" Wire	 	50	9" Pigtail
D04-A001-1	Dragon Light Linear Body Amber – 36" Wire	 	50	36" Pigtail
D04-B000-1	Dragon Light Linear Body Blue – 9" Wire	 	50	9" Pigtail
D04-B001-1	Dragon Light Linear Body Blue – 36" Wire	 	50	36" Pigtail
D04-D000-1	Dragon Light Linear Body Deep Red – 9" Wire	 	50	9" Pigtail
D04-D001-1	Dragon Light Linear Body Deep Red – 36" Wire	 	50	36" Pigtail
D04-G000-1	Dragon Light Linear Body Green – 9" Wire	 	50	9" Pigtail
D04-G001-1	Dragon Light Linear Body Green – 36" Wire	 	50	36" Pigtail
D04-J001-1	Dragon Light Linear Body Jade – 36" Wire	 	50	9" Pigtail
D04-N001-1	Dragon Light Linear Body Orange – 36" Wire	 	50	36" Pigtail
D04-R000-1	Dragon Light Linear Body Red – 9" Wire	 	50	9" Pigtail
D04-R001-1	Dragon Light Linear Body Red – 36" Wire	 	50	36" Pigtail
D04-U001-1	Dragon Light Linear Body Ultraviolet – 36" Wire	 	50	36" Pigtail
D04-W000-1	Dragon Light Linear Body White – 9" Wire	 	50	9" Pigtail
D04-W001-1	Dragon Light Linear Body White – 36" Wire	 	50	36" Pigtail
D04-W00F-1	Dragon Light Linear Body White Flood – 9" Wire	 	50	9" Pigtail
D14 - Dragon Light - Oval Series				Pg 18
D14-0B00-1	Dragon Light Oval Case – Black	- -	50	9" Pigtail
D14-0S00-1	Dragon Light Oval Case – SS	- -	50	9" Pigtail
D14-0W00-1	Dragon Light Oval Case – White	- -	50	9" Pigtail
D14-A000-1	Dragon Light Oval Body Amber – 9" Wire	 	50	9" Pigtail
D14-A001-1	Dragon Light Oval Body Amber – 36" Wire	 	50	36" Pigtail
D14-B000-1	Dragon Light Oval Body Blue – 9" Wire	 	50	9" Pigtail
D14-B001-1	Dragon Light Oval Body Blue – 36" Wire	 	50	36" Pigtail
D14-D000-1	Dragon Light Oval Body Deep Red – 9" Wire	 	50	9" Pigtail
D14-D001-1	Dragon Light Oval Body Deep Red – 36" Wire	 	50	36" Pigtail
D14-G000-1	Dragon Light Oval Body Green – 9" Wire	 	50	9" Pigtail
D14-G001-1	Dragon Light Oval Body Green – 36" Wire	 	50	36" Pigtail
D14-J001-1	Dragon Light Oval Body Jade – 36" Wire	 	50	36" Pigtail
D14-N001-1	Dragon Light Oval Body Orange – 36" Wire	 	50	36" Pigtail
D14-R000-1	Dragon Light Oval Body Red – 9" Wire	 	50	9" Pigtail

Part No.	Part Description	Color	STD Pack	Wire/Conn
D14-R001-1	Dragon Light Oval Body Red – 36" Wire	 	50	36" Pigtail
D14-U000-1	Dragon Light Oval Body Ultraviolet – 9" Wire	 	50	9" Pigtail
D14-U001-1	Dragon Light Oval Body Ultraviolet – 36" Wire	 	50	36" Pigtail
D14-W000-1	Dragon Light Oval Body White – 9" Wire	 	50	9" Pigtail
D14-W001-1	Dragon Light Oval Body White – 36" Wire	 	50	36" Pigtail
D14-W00F-1	Dragon Light Oval Body White Flood – 9" Wire	 	50	9" Pigtail
E03 - Eon Series Light				Pg 19
E03-000G-1	Eon Light Linear Vertical Case Gasket	- -	50	9" Pigtail
E03-00HG-1	Eon Light Linear Horizontal Case Gasket	- -	50	9" Pigtail
E03-0SH0-1	Eon Light Linear Horizontal Case SS	- -	50	9" Pigtail
E03-0SV0-1	Eon Light Linear Vertical Case SS	- -	50	9" Pigtail
E03-A001-1	Eon Light Linear Body Amber – 36" Wire	 	50	36" Pigtail
E03-A003-1	Eon Light Linear Body Amber Dual Intensity – 9" Wire	 	50	9" Pigtail
E03-B001-1	Eon Light Linear Body Blue – 36" Wire	 	50	36" Pigtail
E03-D001-1	Eon Light Linear Body Deep Red – 36" Wire	 	50	36" Pigtail
E03-D003-1	Eon Light Linear Body Deep Red Dual Intensity – 9" Wire	 	50	9" Pigtail
E03-G001-1	Eon Light Linear Body Green – 36" Wire	 	50	36" Pigtail
E03-J001-1	Eon Light Linear Body Jade – 36" Wire	 	50	36" Pigtail
E03-L000-1	Eon Light Linear Body Neutral White – 9" Wire	 	50	9" Pigtail
E03-M000-1	Eon Light Linear Body Warm White – 9" Wire	 	50	9" Pigtail
E03-M00F-1	Eon Light Linear Body Warm White Flood – 9" Wire	 	50	9" Pigtail
E03-N001-1	Eon Light Linear Body Orange – 36" Wire	 	50	36" Pigtail
E03-RGB1-1	Eon Light Linear Body RGB – 82" Wire	 	50	82" Sheathed
E03-W000-1	Eon Light Linear Body White – 9" Wire	 	50	9" Pigtail
E03-W001-1	Eon Light Linear Body White – 36" Wire	 	50	36" Pigtail
E03-W00F-1	Eon Light Linear Body White Flood – 9" Wire	 	50	9" Pigtail
E06 - Silho-X 4" Series				Pg 22
E06-LNF0-1	Silho-X 4" Round Neutral White Light Nickel Trim Ring	 	10	9" Pigtail
E06-LNFR-1	Silho-X 4" Round Neutral White/Red Light Nickel Trim Ring	 	10	9" Pigtail
E06-LS00-1	Silho-X 4" Round Neutral White Light SS Trim Ring	 	10	9" Pigtail
E06-LS0R-1	Silho-X 4" Round Neutral White/Red Light SS Trim	 	10	9" Pigtail
E06-LSB0-1	Silho-X 4" Round Neutral White/Blue Light SS Trim	 	10	9" Pigtail
E06-MN00-1	Silho-X 4" Round Warm White Light Nickel Trim Ring	 	10	9" Pigtail
E06-MS00-1	Silho-X 4" Round Warm White Light SS Trim Ring	 	10	9" Pigtail
E06-MS0F-1	Silho-X 4" Round Warm White Light Diffuse Lens SS	 	10	9" Pigtail
E06-MS0R-1	Silho-X 4" Round Warm White/Red Light SS Trim	 	10	9" Pigtail
E06-RS00-1	Silho-X 4" Round Red Light SS Trim Ring	 	10	9" Pigtail
E06-WB00-1	Silho-X 4" Round White Light Black Powder Coat Trim Ring	 	10	9" Pigtail
E06-WN00-1	Silho-X 4" Round White/Red Light Nickel Trim Ring	 	10	9" Pigtail
E06-WN0R-1	Silho-X 4" Round White/Red Light Nickel Trim Ring	 	10	9" Pigtail
E06-WS00-1	Silho-X 4" Round White Light SS Trim Ring	 	10	9" Pigtail
E06-WS0B-1	Silho-X 4" Round White/Blue Light SS Trim Ring	 	10	9" Pigtail
E06-WS0F-1	Silho-X 4" Round White Light Diffuse Lens SS Trim	 	10	9" Pigtail
E06-WS0R-1	Silho-X 4" Round White/Red Light SS Trim Ring	 	10	9" Pigtail

Part No.	Part Description	Color	STD Pack	Wire/Conn
E06-WSRF-1	Silho-X 4" Round White/Red Light Diffuse Lens SS		10	9" Pigtail
E07 - Emergency Vehicle Interior Light				Pg 29
E07-LC00-1	White Emergency Vehicle Interior Light – Chrome Trim		10	9" Pigtail
E07-LW00-1	White Emergency Vehicle Interior Light – White Trim		10	9" Pigtail
E07-WC00-1	White Emergency Vehicle Interior Light – Chrome Trim		10	9" Pigtail
E07-WW00-1	White Emergency Vehicle Interior Light – White Trim		10	9" Pigtail
E08 - Emergency Vehicle Interior Light				Pg 29
E08-LC00-1	8" EV Neutral White Interior Light – Chrome Trim – 31 LEDs		15	9" Pigtail
E08-LC10-1	8" EV Neutral White Interior Light – Chrome Trim – 18 LEDs		15	9" Pigtail
E08-LCR0-1	8" EV Neutral White/Red Interior Light – Chrome Trim		15	9" Pigtail
E08-LW00-1	8" EV Neutral White Interior Light – White Trim – 31 LEDs		15	9" Pigtail
E08-LW10-1	8" EV Neutral White Interior Light – White Trim – 18 LEDs		15	9" Pigtail
E08-LWR0-1	8" EV Neutral White/Red Interior Light – White Trim		15	9" Pigtail
E08-WC00-1	8" EV Cool White Interior Light – Chrome Trim – 31 LEDs		15	9" Pigtail
E08-WC10-1	8" EV Cool White Interior Light – Chrome Trim – 18 LEDs		15	9" Pigtail
E08-WCR0-1	8" EV Cool White/Red Interior Light – Chrome Trim		15	9" Pigtail
E08-WW00-1	8" EV Cool White Interior Light – White Trim – 31 LEDs		15	9" Pigtail
E08-WW10-1	8" EV Cool White Interior Light – White Trim – 18 LEDs		15	9" Pigtail
E08-WWR0-1	8" EV Cool White/Red Interior Light – White Trim		15	9" Pigtail
E10 - Ground/Pump Panel Light				Pg 21
E10-W000-1	EV Ground/Pump Panel Light		10	9" Sheathed
E10-WS00-1	EV Ground/Pump Panel Light with SS Bracket		10	9" Sheathed
E11 - Silho-X 1.5" Series				Pg 22
E11-AS01-1	Silho-X 1.5" Round Amber Light SS Trim – 36" Wire		10	36" Pigtail
E11-BS01-1	Silho-X 1.5" Round Blue Light SS Trim – 36" Wire		10	36" Pigtail
E11-DS01-1	Silho-X 1.5" Round Deep Red Light SS Trim – 36" Wire		10	36" Pigtail
E11-GS01-1	Silho-X 1.5" Round Green Light SS Trim – 36" Wire		10	36" Pigtail
E11-JS01-1	Silho-X 1.5" Round Jade Light SS Trim – 36" Wire		10	36" Pigtail
E11-LS00-1	Silho-X 1.5" Round Neutral White Light SS Trim – 9" Wire		10	9" Pigtail
E11-MN00-1	Silho-X 1.5" Round Warm White Light Nickel Trim – 9" Wire		10	9" Pigtail
E11-MS00-1	Silho-X 1.5" Round Warm White Light SS Trim – 9" Wire		10	9" Pigtail
E11-MS0F-1	Silho-X 1.5" Round Warm White Light Diffuse Lens SS – 9" Wire		10	9" Pigtail
E11-NS01-1	Silho-X 1.5" Round Orange Light SS Trim – 36" Wire		10	36" Pigtail
E11-RS00-1	Silho-X 1.5" Round Red Light SS Trim Ring – 9" Wire		10	9" Pigtail
E11-WN00-1	Silho-X 1.5" Round White Light Nickel Trim Ring – 9" Wire		10	9" Pigtail
E11-WS00-1	Silho-X 1.5" Round White Light SS Trim – 9" Wire		10	9" Pigtail
E11-WS01-1	Silho-X 1.5" Round White Light SS Trim – 36" Wire		10	36" Pigtail
E11-WS0F-1	Silho-X 1.5" Round White Light Diffuse Lens SS Trim – 9" Wire		10	9" Pigtail
E13 - Silho-X 2.75" Series				Pg 22
E13-LS00-1	Silho-X 2.75" Round LP Neutral White Light – SS Trim Ring		20	9" Pigtail
E13-LS0R-1	Silho-X 2.75" Round LP Neutral White/Red Light – SS Trim		20	9" Pigtail
E13-MS00-1	Silho-X 2.75" Round LP Warm White Light – SS Trim Ring		20	9" Pigtail
E13-MS0F-1	Silho-X 2.75" Round LP Warm White Light Diffuse Lens – SS Trim		20	9" Pigtail
E13-MS0R-1	Silho-X 2.75" Round LP Warm White/Red Light – SS Trim Ring		20	9" Pigtail

Part No.	Part Description	Color	STD Pack	Wire/Conn
E13-RS00-1	Silho-X 2.75" Round LP Red Light – SS Trim Ring	 	20	9" Pigtail
E13-WS00-1	Silho-X 2.75" Round LP White Light – SS Trim Ring	 	20	9" Pigtail
E13-WSOF-1	Silho-X 2.75" Round LP White Light Diffuse Lens – SS Trim Ring	 	20	9" Pigtail
E13-WSOR-1	Silho-X 2.75" Round LP White/Red Light – SS Trim Ring	 	20	9" Pigtail
E13-MN00-1	Silho-X 2.75" Round LP Warm White Light – Nickel Trim Ring	 	20	9" Pigtail
E13-WN00-1	Silho-X 2.75" Round LP White Light – Nickel Trim Ring	 	20	9" Pigtail
E13-AB10-1	Silho-X 2.75" Round LP Amber Light – Black Trim Ring	 	20	9" Pigtail
E13-AW10-1	Silho-X 2.75" Round LP Amber Light – White Trim Ring	 	20	9" Pigtail
E13-BB10-1	Silho-X 2.75" Round LP Blue Light – Black Trim Ring	 	20	9" Pigtail
E13-BW10-1	Silho-X 2.75" Round LP Blue Light – White Trim Ring	 	20	9" Pigtail
E13-GB10-1	Silho-X 2.75" Round LP Green Light – Black Trim Ring	 	20	9" Pigtail
E13-GW10-1	Silho-X 2.75" Round LP Green Light – White Trim Ring	 	20	9" Pigtail
E13-RB10-1	Silho-X 2.75" Round LP Red Light – Black Trim Ring	 	20	9" Pigtail
E13-RW10-1	Silho-X 2.75" Round LP Red Light – White Trim Ring	 	20	9" Pigtail
E13-WB10-1	Silho-X 2.75" Round LP White Light – Black Trim Ring	 	20	9" Pigtail
E13-WW10-1	Silho-X 2.75" Round LP White White Light – White Trim Ring	 	20	9" Pigtail
E16 - High Output Dome Light				Pg 23
E16-LW00-1	E16 Interior SM Neutral White Oval Light White Base	 	20	9" Pigtail
E16-LWS0-1	E16 Interior SM Neutral White Oval Light White Base w/ Switch	 	20	9" Pigtail
E16-MW00-1	E16 Interior SM Warm White Oval Light White Base	 	20	9" Pigtail
E16-MWS0-1	E16 Interior SM Warm White Oval Light White Base w/ Switch	 	20	9" Pigtail
E16-WW00-1	E16 Interior SM White Oval Light White Base	 	20	9" Pigtail
E16-WWS0-1	E16 Interior SM White Light White Base w/ Switch	 	20	9" Pigtail
E18 - 4.5" Utility Light				Pg 24
E18-LC00-1	E18 4.5" Utility Light Neutral White	 	10	9" Pigtail
E18-LCS0-1	E18 4.5" Utility Light Neutral White w/ Switch	 	10	9" Pigtail
E18-WC00-1	E18 4.5" Utility Light Cool White	 	10	9" Pigtail
E18-WCS0-1	E18 4.5" Utility Light Cool White w/ Switch	 	10	9" Pigtail
E20 - Orion Series Surface Mount Dome Light				Pg 24
E20-LA00-1	Orion 6" Interior Light – Neutral White Aluminum Trim Ring	 	5	9" Pigtail
E20-LA0R-1	Orion 6" Interior Light – Neutral White/Red Aluminum Trim Ring	 	5	9" Pigtail
E20-LC00-1	Orion 6" Interior Light – Neutral White Chrome Trim Ring	 	5	9" Pigtail
E20-LC0R-1	Orion 6" Interior Light – Neutral White/Red Chrome Trim Ring	 	5	9" Pigtail
E20-MA00-1	Orion 6" Interior Light – Warm White Aluminum Trim Ring	 	5	9" Pigtail
E20-MA03-1	Orion 6" Interior Light – Tri-Level Intensity Warm WHT Alum Trim	 	5	9" Pigtail
E20-MA0R-1	Orion 6" Interior Light – Warm White Aluminum Trim Ring	 	5	9" Pigtail
E20-MC00-1	Orion 6" Interior Light – Warm White Chrome Trim Ring	 	5	9" Pigtail
E20-WC00-1	Orion 6" Interior Light – White Chrome Trim Ring	 	5	9" Pigtail
E20-WC0R-1	Orion 6" Interior Light – White/Red Chrome Trim Ring	 	5	9" Pigtail
E20-WCB0-1	Orion 6" Interior Light – White/Blue Light Chrome Trim Ring	 	5	9" Pigtail
E20-WN00-1	Orion 6" Interior Light – White Light Nickel Trim Ring	 	5	9" Pigtail
E20-WN0R-1	Orion 6" Interior Light – White/Red Light Nickel Trim Ring	 	5	9" Pigtail
E25 - 3" Spring Mounted Dome Light				Pg 25
E25-L000-1	3" Spring Mounted Dome Light – Neutral White	 	10	9" Sheathed

Part No.	Part Description	Color	STD Pack	Wire/Conn
E25-L0S0-1	3" Spring Mounted Dome Light – Neutral White w/ Switch	 	10	9" Sheathed
E25-M000-1	3" Spring Mounted Dome Light – Warm White	 	10	9" Sheathed
E25-M0S0-1	3" Spring Mounted Dome Light – Warm White w/ Switch	 	10	9" Sheathed
E25-W000-1	3" Spring Mounted Dome Light – Cool White	 	10	9" Sheathed
E25-W0S0-1	3" Spring Mounted Dome Light – Cool White w/ Switch	 	10	9" Sheathed
E26 - 4.5" Spring Mounted Dome Light				Pg 25
E26-L000-1	4.5" Spring Mounted Dome Light – Neutral White	 	10	9" Sheathed
E26-L0S0-1	4.5" Spring Mounted Dome Light – Neutral White w/ Switch	 	10	9" Sheathed
E26-LP00-1	4.5" Spring Mounted Premium Dome Light – Neutral White	 	10	9" Sheathed
E26-LPS0-1	4.5" Spring Mounted Premium Dome Light – Neutral White w/ Switch	 	10	9" Sheathed
E26-M000-1	4.5" Spring Mounted Dome Light – Warm White	 	10	9" Sheathed
E26-M0S0-1	4.5" Spring Mounted Dome Light – Warm White w/ Switch	 	10	9" Sheathed
E26-MP00-1	4.5" Spring Mounted Premium Dome Light – Warm White	 	10	9" Sheathed
E26-MPS0-1	4.5" Spring Mounted Premium Dome Light – Warm White w/ Switch	 	10	9" Sheathed
E26-W000-1	4.5" Spring Mounted Dome Light – Cool White	 	10	9" Sheathed
E26-W0S0-1	4.5" Spring Mounted Dome Light – Cool White w/ Switch	 	10	9" Sheathed
E26-WP00-1	4.5" Spring Mounted Premium Dome Light – Cool White	 	10	9" Sheathed
E26-WPS0-1	4.5" Spring Mounted Premium Dome Light – Cool White w/ Switch	 	10	9" Sheathed
E27 - 3" Surface Mounted Dome Light				Pg 25
E27-L000-1	3" Surface Mounted Dome Light – Neutral White	 	10	9" Sheathed
E27-L0S0-1	3" Surface Mounted Dome Light – Neutral White w/ Switch	 	10	9" Sheathed
E27-M000-1	3" Surface Mounted Dome Light – Warm White	 	10	9" Sheathed
E27-M0S0-1	3" Surface Mounted Dome Light – Warm White w/ Switch	 	10	9" Sheathed
E27-W000-1	3" Surface Mounted Dome Light – Cool White	 	10	9" Sheathed
E27-W0S0-1	3" Surface Mounted Dome Light – Cool White w/ Switch	 	10	9" Sheathed
E28 - 4.5" Surface Mounted Dome Light				Pg 25
E28-L000-1	4.5" Surface Mounted Dome Light – Neutral White	 	10	9" Sheathed
E28-L0S0-1	4.5" Surface Mounted Dome Light – Neutral White w/ Switch	 	10	9" Sheathed
E28-LP00-1	4.5" Surface Mounted Premium Dome Light – Neutral White	 	10	9" Sheathed
E28-LPS0-1	4.5" Surface Mounted Premium Dome Light – Neutral White w/ Switch	 	10	9" Sheathed
E28-M000-1	4.5" Surface Mounted Dome Light – Warm White	 	10	9" Sheathed
E28-M0S0-1	4.5" Surface Mounted Dome Light – Warm White w/ Switch	 	10	9" Sheathed
E28-MP00-1	4.5" Surface Mounted Premium Dome Light – Warm White	 	10	9" Sheathed
E28-MPS0-1	4.5" Surface Mounted Premium Dome Light – Warm White w/ Switch	 	10	9" Sheathed
E28-W000-1	4.5" Surface Mounted Dome Light – Cool White	 	10	9" Sheathed
E28-W0S0-1	4.5" Surface Mounted Dome Light – Cool White w/ Switch	 	10	9" Sheathed
E28-WP00-1	4.5" Surface Mounted Premium Dome Light – Cool White	 	10	9" Sheathed
E28-WPS0-1	4.5" Surface Mounted Premium Dome Light – Neutral White w/ Switch	 	10	9" Sheathed
E30 - High Performance Recessed Ceiling Light				Pg 28
E30-L000-1	Recessed 4K White 42 LED Light 6"x17.5"	 	16	9" Pigtail
E30-L00M-1	Recessed 4K White 42 LED Light 6"x17.5" w/ Motion Detection	 	16	9" Pigtail
E30-L00R-1	Recessed 4K White/Red 42/16 LED Light 6"x17.5"	 	16	9" Pigtail
E30-L010-1	Recessed 4K White 21 LED Light 6"x17.5"	 	16	9" Pigtail
E30-L01R-1	Recessed 4K White/Red 21/16 LED Light 6"x17.5"	 	16	9" Pigtail

Part No.	Part Description	Color	STD Pack	Wire/Conn
E30-L0S0-1	Recessed 4K White 42 LED Light 6"x17.5" Switched	 	16	9" Pigtail
E30-L0SR-1	Recessed 4K White/Red 42/16 LED Light 6"x17.5" Switched	 	16	9" Pigtail
E30-L1S0-1	Recessed 4K White 21 LED Light 6"x17.5" Switched	 	16	9" Pigtail
E30-L1SR-1	Recessed 4K White/Red 21/16 LED Light 6"x17.5" Switched	 	16	9" Pigtail
E34 - 3/4" Grommet Mount Step Accent Lights				Pg 23
E34-BB00-1	3/4" Grommet Mount Blue Step Accent Light Black Trim	 	10	9" Pigtail
E34-BC00-1	3/4" Grommet Mount Blue Step Accent Light Chrome Trim	 	10	9" Pigtail
E34-RB00-1	3/4" Grommet Mount Red Step Accent Light Black Trim	 	10	9" Pigtail
E34-RC00-1	3/4" Grommet Mount Red Step Accent Light Chrome Trim	 	10	9" Pigtail
E34-WB00-1	3/4" Grommet Mount White Step Accent Light Black Trim	 	10	9" Pigtail
E34-WC00-1	3/4" Grommet Mount White Step Accent Light Chrome Trim	 	10	9" Pigtail
E35/E36/E38 - Linear Area Light				Pg 27
E35-LB00-1	Linear LED SM Light Neutral White – Black Body 9Watt	 	40	9" Sheathed
E35-LB0S-1	Linear LED SM Light Neutral White – Blk Body 9Watt w/ Switch	 	40	9" Sheathed
E35-MB00-1	Linear LED SM Light Warm White – Black Body 9Watt	 	40	9" Sheathed
E35-WB00-1	Linear LED SM Light White – Black Body 9Watt	 	50	9" Sheathed
E35-WB0S-1	Linear LED SM Light White – Black Body 9Watt w/ Switch	 	50	9" Sheathed
E35-WB24-1	Linear LED SM Light White – Black Body 9Watt 24Volt	 	20	9" Sheathed
E36-LB00-1	Linear LED SM Light Neutral White – Black Body 18Watt	 	40	9" Sheathed
E36-LB0S-1	Linear LED SM Light Neutral White – Blk Body 18W w/ Switch	 	40	9" Sheathed
E36-LB24-1	Linear LED SM Light Neutral White – Black Body 18W 24Volt	 	15	9" Sheathed
E36-MB00-1	Linear LED SM Light Warm White – Black Body 18Watt	 	10	9" Sheathed
E36-WB00-1	Linear LED SM Light White – Black Body 18Watt	 	50	9" Sheathed
E36-WB0S-1	Linear LED SM Light White – Black Body 18Watt w/Switch	 	50	9" Sheathed
E36-WB24-1	Linear LED SM Light White – Black Body 18Watt 24Volt	 	20	9" Sheathed
E38-LB00-1	Linear LED SM Light Neutral White – Black Body 36Watt	 	20	9" Sheathed
E38-LB0S-1	Linear LED SM Light Neutral White – Blk Body 36W w/ Switch	 	20	9" Sheathed
E38-LB24-1	Linear LED SM Light Neutral White – Black Body 36Watt 24Volt	 	15	9" Sheathed
E38-MB00-1	Linear LED SM Light Warm White – Black Body 36Watt	 	20	9" Sheathed
E38-WB00-1	Linear LED SM Light White – Black Body 36Watt	 	20	9" Sheathed
E38-WB0S-1	Linear LED SM Light White – Black Body 36Watt w/ Switch	 	20	9" Sheathed
E38-WB24-1	Linear LED SM Light White – Black Body 36Watt 24Volt	 	15	9" Sheathed
E39 - Fluorescent Replacement Kit				Pg 26
E39-L000-1	LED Neutral White Light Replacement Kit for P716 & P718	 	5	9" Pigtail
E39-L010-1	LED Neutral White Light Replacement Kit for 712XL	 	5	9" Pigtail
E39-L00R-1	LED Neutral White/Red Light Replacement Kit for P716 & P718	 	5	9" Pigtail
E41 - Flexible Weather Resistant Lighting Strips				Pg 20
E41-000V-1	2 Wire Termination	- -	-	-
E41-304X-1	Flexible LED Light RGB 18" – Four-Wire	 	1	18" Sheathed
E41-W010-1	Flexible LED Light White 4.5" – No Wire	 		Made to Order
E41-A010-1	Flexible LED Light Amber 4.5" – No Wire	 		Made to Order
E41-B010-1	Flexible LED Light Blue 4.5" – No Wire	 		Made to Order
E41-G010-1	Flexible LED Light Green 4.5" – No Wire	 		Made to Order
E41-R010-1	Flexible LED Light Red 4.5" – No Wire	 		Made to Order

Part No.	Part Description	Color	STD Pack	Wire/Conn
----------	------------------	-------	----------	-----------

Available in custom length sections from 4.5" – 16.5'
*4.5" Increments only





E96 - Trailer/Marine LED Surface Mount Spotlight - One Pair				Pg 26
--	--	--	--	--------------

E96-WS00-1	Marine Docking Light – One Pair	 	12	9" Pigtail
------------	---------------------------------	---	----	------------

































E99 - Dimmer Switches				Pg 33
------------------------------	--	--	--	--------------

E99-D001-1	Dimmer Rotary	- -	1	-
E99-D002-1	Dimmer Slide	- -	1	-

K40 5"x 3.3" Emergency Flasher				Pg 30
---------------------------------------	--	--	--	--------------





















K40-AA00-1	K40 AutoSync Amber Flasher Lamp Amber Lens	 	10	9" Pigtail
K40-AC00-1	K40 AutoSync Amber Flasher Lamp Clear Lens	 	10	9" Pigtail
K40-BB00-1	K40 AutoSync Blue Flasher Lamp Blue Lens	 	10	9" Pigtail
K40-BC00-1	K40 AutoSync Blue Flasher Lamp Blue Lens	 	10	9" Pigtail
K40-GC00-1	K40 AutoSync Green Flasher Lamp Clear Lens	 	10	9" Pigtail
K40-RR00-1	K40 AutoSync Red Flasher Lamp Red Lens	 	10	9" Pigtail
K40-RC00-1	K40 AutoSync Red Flasher Lamp Clear Lens	 	10	9" Pigtail
K40-WC00-1	K40 AutoSync White Flasher Lamp Clear Lens	 	10	9" Pigtail
K40-AAS0-1	K40 Steady Amber Turn Lamp Amber Lens	 	10	9" Pigtail
K40-ACS0-1	K40 Steady Amber Flasher Lamp Clear Lens	 	10	9" Pigtail
K40-BBS0-1	K40 Steady Blue Flasher Lamp Blue Lens	 	10	9" Pigtail
K40-BCS0-1	K40 Steady Blue Flasher Lamp Clear Lens	 	10	9" Pigtail
K40-GCS0-1	K40 Steady Green Flasher Lamp Clear Lens	 	10	9" Pigtail
K40-RRS0-1	K40 Steady Red Flasher Lamp Red Lens	 	10	9" Pigtail
K40-RCS0-1	K40 Steady Red Flasher Lamp Clear Lens	 	10	9" Pigtail
K40-WCS0-1	K40 Steady White Flasher Lamp Clear Lens	 	10	9" Pigtail

K50 5"x 2" Emergency Flasher				Pg 30
-------------------------------------	--	--	--	--------------

K50-AA00-1	K50 AutoSync Amber Flasher Lamp Amber Lens	 	10	9" Pigtail
K50-AC00-1	K50 AutoSync Amber Flasher Lamp Clear Lens	 	10	9" Pigtail
K50-BB00-1	K50 AutoSync Blue Flasher Lamp Blue Lens	 	10	9" Pigtail
K50-BC00-1	K50 AutoSync Blue Flasher Lamp Blue Lens	 	10	9" Pigtail
K50-GC00-1	K50 AutoSync Green Flasher Lamp Clear Lens	 	10	9" Pigtail
K50-RR00-1	K50 AutoSync Red Flasher Lamp Red Lens	 	10	9" Pigtail
K50-RC00-1	K50 AutoSync Red Flasher Lamp Clear Lens	 	10	9" Pigtail
K50-WC00-1	K50 AutoSync White Flasher Lamp Clear Lens	 	10	9" Pigtail
K50-AAS0-1	K50 Steady Amber Turn Lamp Amber Lens	 	10	9" Pigtail
K50-ACS0-1	K50 Steady Amber Flasher Lamp Clear Lens	 	10	9" Pigtail
K50-BBS0-1	K50 Steady Blue Flasher Lamp Blue Lens	 	10	9" Pigtail
K50-BCS0-1	K50 Steady Blue Flasher Lamp Clear Lens	 	10	9" Pigtail
K50-GCS0-1	K50 Steady Green Flasher Lamp Clear Lens	 	10	9" Pigtail
K50-RRS0-1	K50 Steady Red Flasher Lamp Red Lens	 	10	9" Pigtail
K50-RCS0-1	K50 Steady Red Flasher Lamp Clear Lens	 	10	9" Pigtail
K50-WCS0-1	K50 Steady White Flasher Lamp Clear Lens	 	10	9" Pigtail























K60 6"x 4" Emergency Flasher				Pg 31
-------------------------------------	--	--	--	--------------

































K60-AA00-1	K60 AutoSync Amber Flasher Lamp Amber Lens	 	10	9" Pigtail
K60-AC00-1	K60 AutoSync Amber Flasher Lamp Clear Lens	 	10	9" Pigtail
K60-BB00-1	K60 AutoSync Blue Flasher Lamp Blue Lens	 	10	9" Pigtail

Part No.	Part Description	Color	STD Pack	Wire/Conn
K60-BC00-1	K60 AutoSync Blue Flasher Lamp Clear Lens		10	9" Pigtail
K60-GC00-1	K60 AutoSync Green Flasher Lamp Clear Lens		10	9" Pigtail
K60-RR00-1	K60 AutoSync Red Flasher Lamp Red Lens		10	9" Pigtail
K60-RC00-1	K60 AutoSync Red Flasher Lamp Clear Lens		10	9" Pigtail
K60-WC00-1	K60 AutoSync White Flasher Lamp		10	9" Pigtail
K60-AAS0-1	K60 Steady Amber Flasher Lamp Amber Lens		10	9" Pigtail
K60-ACS0-1	K60 Steady Amber Flasher Lamp Clear Lens		10	9" Pigtail
K60-BBS0-1	K60 Steady Blue Flasher Lamp Blue Lens		10	9" Pigtail
K60-BCS0-1	K60 Steady Blue Flasher Lamp Clear Lens		10	9" Pigtail
K60-GCS0-1	K60 Steady Green Flasher Lamp Clear Lens		10	9" Pigtail
K60-RRS0-1	K60 Steady Red Flasher Lamp Red Lens		10	9" Pigtail
K60-RCS0-1	K60 Steady Red Flasher Lamp Clear Lens		10	9" Pigtail
K60-WCS0-1	K60 Steady White Flasher Lamp Clear Lens		10	9" Pigtail
K60-AAA0-1	K60 AutoSync Amber Flasher Amber Lens Arrow Mask		10	9" Pigtail
K60-A3S0-1	K60 Steady Amber Turn Lamp Amber Lens Arrow Mask		10	9" Pigtail
K60-AAT0-1	K60 Steady Amber Turn Lamp Amber Lens		10	9" Pigtail
K60-ACA0-1	K60 Steady Amber Turn Lamp Clear Lens Arrow Mask		10	9" Pigtail
K60-ACT0-1	K60 Steady Amber Turn Lamp Clear Lens		10	9" Pigtail
K60-WBU0-1	K60 White Backup Lamp		10	9" Pigtail
K60-STR0-1	K60 Steady Red STT Lamp Red Lens		10	9" Pigtail
K60-STC0-1	K60 Steady Red STT Lamp Clear Lens		10	9" Pigtail

K70 7"x 3" Emergency Flasher

Pg 31

K70-AA00-1	K70 AutoSync Amber Flasher Lamp Amber Lens		10	9" Pigtail
K70-AC00-1	K70 AutoSync Amber Flasher Lamp Clear Lens		10	9" Pigtail
K70-BB00-1	K70 AutoSync Blue Flasher Lamp Blue Lens		10	9" Pigtail
K70-BC00-1	K70 AutoSync Blue Flasher Lamp Blue Lens		10	9" Pigtail
K70-GC00-1	K70 AutoSync Green Flasher Lamp Clear Lens		10	9" Pigtail
K70-RR00-1	K70 AutoSync Red Flasher Lamp Red Lens		10	9" Pigtail
K70-RC00-1	K70 AutoSync Red Flasher Lamp Clear Lens		10	9" Pigtail
K70-WC00-1	K70 AutoSync White Flasher Lamp Clear Lens		10	9" Pigtail
K70-AAS0-1	K70 Steady Amber Turn Lamp Amber Lens		10	9" Pigtail
K70-ACS0-1	K70 Steady Amber Flasher Lamp Clear Lens		10	9" Pigtail
K70-BBS0-1	K70 Steady Blue Flasher Lamp Blue Lens		10	9" Pigtail
K70-BCS0-1	K70 Steady Blue Flasher Lamp Clear Lens		10	9" Pigtail
K70-GCS0-1	K70 Steady Green Flasher Lamp Clear Lens		10	9" Pigtail
K70-RRS0-1	K70 Steady Red Flasher Lamp Red Lens		10	9" Pigtail
K70-RCS0-1	K70 Steady Red Flasher Lamp Clear Lens		10	9" Pigtail
K70-WCS0-1	K70 Steady White Flasher Lamp Clear Lens		10	9" Pigtail
K70-AAT0-1	K70 Steady Amber Turn Lamp Amber Lens		10	9" Pigtail
K70-ACT0-1	K70 Steady Amber Turn Lamp Clear Lens		10	9" Pigtail
K70-WBU0-1	K70 White Backup Lamp		10	9" Pigtail
K70-STR0-1	K70 Steady Steady Red STT Lamp Red Lens		10	9" Pigtail
K70-STC0-1	K70 Steady Red STT Lamp Clear Lens		10	9" Pigtail
K70-SW00-1	K70 High Output Scene Lamp		10	9" Pigtail

Part No.	Part Description	Color	STD Pack	Wire/Conn
K90 9"x 7" Emergency Flasher				Pg 32
K90-AA00-1	K90 AutoSync Amber Flasher Amber Lens		10	9" Pigtail
K90-AC00-1	K90 AutoSync Amber Flasher Clear Lens		10	9" Pigtail
K90-BB00-1	K90 AutoSync Blue Flasher Blue Lens		10	9" Pigtail
K90-BC00-1	K90 AutoSync Blue Flasher Clear Lens		10	9" Pigtail
K90-GG00-1	K90 AutoSync Green Flasher Green Lens		10	9" Pigtail
K90-GC00-1	K90 AutoSync Green Flasher Clear Lens		10	9" Pigtail
K90-RR00-1	K90 AutoSync Red Flasher Red Lens		10	9" Pigtail
K90-RC00-1	K90 AutoSync Red Flasher Clear Lens		10	9" Pigtail
K90-WC00-1	K90 AutoSync White Flasher Clear Lens		10	9" Pigtail
K90-RA00-1	K90 AutoSync Combination Red/Amber Flasher		10	9" Pigtail
K90-RB00-1	K90 AutoSync Combination Red/Blue Flasher		10	9" Pigtail
K90-RW00-1	K90 AutoSync Combination Red/White Flasher		10	9" Pigtail
K90-WB00-1	K90 AutoSync Combination White/Blue Flasher		10	9" Pigtail
K90-RRS0-1	K90 Steady Red Flasher Red Lens		10	9" Pigtail
K90-RCS0-1	K90 Steady Red Flasher Clear Lens		10	9" Pigtail
K90-AAS0-1	K90 Steady Amber Flasher Amber Lens		10	9" Pigtail
K90-ACS0-1	K90 Steady Amber Flasher Clear Lens		10	9" Pigtail
K90-BBS0-1	K90 Steady Blue Flasher Blue Lens		10	9" Pigtail
K90-BCS0-1	K90 Steady Blue Flasher Clear Lens		10	9" Pigtail
K90-GGS0-1	K90 Steady Green Flasher Green Lens		10	9" Pigtail
K90-GCS0-1	K90 Steady Green Flasher Clear Lens		10	9" Pigtail
K90-WCS0-1	K90 Steady White Flasher Clear Lens		10	9" Pigtail
K90-RAS0-1	K90 Steady Combination Red/Amber Flasher		10	9" Pigtail
K90-RBS0-1	K90 Steady Combination Red/Blue Flasher		10	9" Pigtail
K90-RWS0-1	K90 Steady Combination Red/White Flasher		10	9" Pigtail
K90-WBS0-1	K90 Steady Combination Blue/White Flasher		10	9" Pigtail
K90-WBU0-1	K90 White Backup Lamp		10	9" Pigtail
K90-AAT0-1	K90 Stop/Turn/Tail Amber Lamp Amber Lens		10	9" Pigtail
K90-ACT0-1	K90 Stop/Turn/Tail Amber Lamp Clear Lens		10	9" Pigtail
K90-STR0-1	K90 Stop/Turn/Tail Red Lamp Red Lens		10	9" Pigtail
K90-STC0-1	K90 Stop/Turn/Tail Red Lamp Clear Lens		10	9" Pigtail
K90-SW00-1	K90 High Output Scene Light		10	9" Pigtail





Other Combinations Available. Call for Details







K Series Anchor/Screw Kits

K40-0100-1	K40 Anchor/Screw Kit	- -	1	-
K50-0100-1	K50 Anchor/Screw Kit	- -	1	-
K70-0100-1	K70 Anchor/Screw Kit	- -	1	-
K90-0100-1	K90 Anchor/Screw Kit	- -	1	-

Lxx - License Plate Lamp



Pg 10-11

L10-WB00-1	License Plate Lamp Vertical Plain Mount – Black Base		10	9" Pigtail
L10-WB9B-1	License Plate Lamp Vertical Plain Mount – Black Base w/ .180" Bullet		10	9" / 0.180" Bul
L10-WC00-1	License Plate Lamp Vertical Plain Mount –Chrome Base		10	9" Pigtail
L11-WB00-1	License Plate Lamp Vertical Plain Mount – Black Base		10	9" Pigtail

Part No.	Part Description	Color	STD Pack	Wire/Conn
L11-WB9B-1	License Plate Lamp Vertical Plain Mount – Black Base w/ .180" Bullet		10	9" / 0.180" Bul
L11-WC00-1	License Plate Lamp Vertical Plain Mount – Chrome Base		10	9" Pigtail
L12-WB00-1	License Plate Lamp Horizontal Plain Mount – Black Base		10	9" Pigtail
L12-WB5B-1	License Plate Lamp Horizontal Plain Mount – Black Base w/ .180" Bullet		10	9" / 0.180" Bul
L12-WC00-1	License Plate Lamp Horizontal Plain Mount – Chrome Base		10	9" Pigtail
L34-WC9B-1	3/4" Bullet Style License Lamp – Large Grommet w/ .180" Bullet		10	9" / 0.180" Bul
L34-WG9B-1	3/4" Bullet Style License Lamp – Standard Grommet w/ .180"Bullet		10	9" / 0.180" Bul







S10 - 2.5" Round P2 Rated Sidemarker

Pg 15

S10-0G00-1	2.5" Round Sidemarker Grommet	- -	150	-
S10-AA00-1	2.5" Round Amber P2 Sidemarker with Reflectivity		150	Fem 2-Pole
S10-RR00-1	2.5" Round Red P2 Sidemarker with Reflectivity		150	Fem 2-Pole

S15 - PC Rated Sidemarker

Pg 14

S15-0B00-1	Model S150 Base Black	- -	100	-
S15-0C00-1	Model S150 Base Chrome	- -	100	-
S15-0G00-1	Model S150 Grommet	- -	100	-
S15-AA00-1	Model S150 Amber PC Sidemarker Amber Lens		120	Fem 2-Pole
S15-AC00-1	Model S150 Amber PC Sidemarker Clear Lens		120	Fem 2-Pole
S15-AC0P-1	Model S150 Amber PC Sidemarker Clear Lens 6" Pigtail		200	9" Pigtail
S15-RR00-1	Model S150 Red PC Sidemarker Red Lens		200	Fem 2-Pole
S15-RC00-1	Model S150 Red PC Sidemarker Clear Lens		120	Fem 2-Pole
S15-RC0P-1	Model S150 Red PC Sidemarker Clear Lens 6" Pigtail		200	9" Pigtail

S17 - PC/P2 Rated Sidemarker

Pg 12

S17-AA00-1	2.5" Amber Surface Mounted Sidemarker Amber Lens		10	9" Pigtail
S17-AC00-1	2.5" Amber Surface Mounted Sidemarker Clear Lens		10	9" Pigtail
S17-RR00-1	2.5" Red Surface Mounted Sidemarker Red Lens		10	9" Pigtail
S17-RC00-1	2.5" Red Surface Mounted Sidemarker Clear Lens		10	9" Pigtail

S18 - PC/P2 Rated Sidemarker





































































Pg 12

































S18-AA00-1	3.7" Amber Surface Mounted Sidemarker Amber Lens		10	9" Pigtail
S18-AC00-1	3.7" Amber Surface Mounted Sidemarker Clear Lens		10	9" Pigtail
S18-AAG0-1	3.7" Amber Surface Mounted Sidemarker Amber Lens, Self Grounding		10	9" Pigtail
S18-ACG0-1	3.7" Amber Surface Mounted Sidemarker Clear Lens, Self Grounding		10	9" Pigtail
S18-RR00-1	3.7" Red Surface Mounted Sidemarker Red Lens		10	9" Pigtail
S18-RC00-1	3.7" Red Surface Mounted Sidemarker Clear Lens		10	9" Pigtail
S18-RRG0-1	3.7" Red Surface Mounted Sidemarker Red Lens, Self Grounding		10	9" Pigtail
S18-RCG0-1	3.7" Red Surface Mounted Sidemarker Clear Lens, Self Grounding		10	9" Pigtail
S18-LC00-1	3.7" Neutral White Surface Mounted Area/Accent Light		10	9" Pigtail
S18-WC00-1	3.7" Cool White Surface Mounted Area/Accent Light		10	9" Pigtail





S19 - PC Rated Sidemarker

Pg 14

S19-0B00-1	Black 1" x 4" Self Grounding Base	- -	100	-
S19-0S00-1	Chrome 1" x 4" Self Grounding Base	- -	100	-
S19-AA00-1	1" x 4" Amber PC Rated Sidemarker Amber Lens		100	No Wire/ 0.156" Bul
S19-AC00-1	1" x 4" Amber PC Rated Sidemarker Clear Lens		100	No Wire/ 0.156" Bul
S19-RR00-1	1" x 4" Red PC Rated Sidemarker Red Lens		100	No Wire/ 0.156" Bul
S19-RC00-1	1" x 4" Red PC Rated Sidemarker Clear Lens		100	No Wire/ 0.156" Bul



























Part No.	Part Description	Color	STD Pack	Wire/Conn
S21 - P2 Rated Sidemarker				Pg 17
S21-0G00-1	Sidemarker Gasket	- -	100	-
S21-0S00-1	2" Oval Sidemarker SS Trim Ring	- -	100	-
S21-AA00-1	2" Oval Amber Sidemarker Amber Lens	 	100	9" Sheathed
S21-AC00-1	2" Oval Amber Sidemarker Clear Lens	 	100	9" Sheathed
S21-RR00-1	2" Oval Red Sidemarker Red Lens	 	100	9" Sheathed
S21-RC00-1	2" Oval Red Sidemarker Clear Lens	 	100	9" Sheathed
S22 - 2"x 6" PC Sidemarker				Pg 16
S22-AA00-1	Amber 2"x 6" PC Sidemarker With Reflector	 	100	Two Pole (S99-36xx-1)
S22-RR00-1	Red 2"x 6" PC Sidemarker With Reflector	 	100	Two Pole (S99-36xx-1)
S30 - 2" round P2 Rated Sidemarker				Pg 15
S30-0G00-1	2" Round Sidemarker Grommet	- -	125	-
S30-AA00-1	2" Round Amber Sidemarker Amber Lens	 	125	Fem 2-Pole
S30-AC00-1	2" Round Amber Sidemarker Clear Lens	 	125	Fem 2-Pole
S30-RR00-1	2" Round Red Sidemarker Red Lens	 	125	Fem 2-Pole
S30-RC00-1	2" Round Red Sidemarker Clear Lens	 	125	Fem 2-Pole
S33 - P2 Rated Sidemarker				Pg 13/19
S33-0S00-1	3/4" Mini Sidemarker Stainless Steel Trim Ring	- -	100	-
S33-AA00-1	3/4" Mini P2 Amber Sidemarker Amber Lens, Black Ground	 	100	9" Sheathed Black-GND
S33-AA09-1	3/4" Mini P2 Amber Sidemarker Amber Lens	 	100	9" Sheathed White-GND
S33-AA9B-1	3/4" Mini P2 Amber Sidemarker Amber Lens w/ .180" Bullets	 	100	9" Sheathed 0.180" Bul
S33-AA9H-1	3/4" Mini P2 Amber Sidemarker Amber Lens 18" Wire	 	100	18" Sheathed White-GND
S33-AAFB-1	3/4" Mini P2 Amber Sidemarker Amber Lens 18" Wire w/ .180" Bullet	 	100	18" Sheathed 0.180" Bul
S33-AC00-1	3/4" Mini P2 Amber Sidemarker Clear Lens, Black Ground	 	100	9" Sheathed Black-GND
S33-AC09-1	3/4" Mini P2 Amber Sidemarker Clear Lens	 	100	9" Sheathed White-GND
S33-AC9B-1	3/4" Mini P2 Amber Sidemarker Clear Lens w/ .180" Bullets	 	100	9" Sheathed 0.180" Bul
S33-AC9H-1	3/4" Mini P2 Amber Sidemarker Clear Lens 18" Wire	 	100	18" Sheathed White-GND
S33-ACFB-1	3/4" Mini P2 Amber Sidemarker Clear Lens 18" Wire w/ .180" Bul	 	100	18" Sheathed 0.180" Bul
S33-BC00-1	3/4" Low Profile Blue Indicator, Black Ground	 	100	9" Sheathed Black-GND
S33-GC00-1	3/4" Low Profile Green Indicator, Black Ground	 	100	9" Sheathed Black-GND
S33-RC00-1	3/4" Mini P2 Red Sidemarker Clear Lens, Black Ground	 	100	9" Sheathed Black-GND
S33-RC09-1	3/4" Mini P2 Red Sidemarker Clear Lens	 	100	9" Sheathed White-GND
S33-RC9B-1	3/4" Mini P2 Red Sidemarker Clear Lens w/ .180" Bullets	 	100	9" Sheathed 0.180" Bul
S33-RC9H-1	3/4" Mini P2 Red Sidemarker Clear Lens 18" Wire	 	100	18" Sheathed White-GND
S33-RCFB-1	3/4" Mini P2 Red Sidemarker Clear Lens 18" Wire w/ .180" Bullets	 	100	18" Sheathed 0.180" Bul
S33-RR00-1	3/4" Mini P2 Red Sidemarker Red Lens, Black Ground	 	100	9" Sheathed Black-GND
S33-RR09-1	3/4" Mini P2 Red Sidemarker Red Lens	 	100	9" Sheathed White-GND
S33-RR9B-1	3/4" Mini P2 Red Sidemarker Red Lens w/ .180" Bullets	 	100	9" Sheathed 0.180" Bul
S33-RR9H-1	3/4" Mini P2 Red Sidemarker Red Lens 18" Wire	 	100	18" Sheathed White-GND
S33-RRFB-1	3/4" Mini P2 Red Sidemarker Red Lens 18" Wire w/ .180" Bullets	 	100	18" Sheathed 0.180" Bul
S33-WC00-1	3/4" Low Profile White Indicator, Black Ground	 	100	9" Sheathed Black-GND
S33-WC0B-1	3/4" Low Profile White Indicator, Black Ground w/ .180" Bullets	 	100	9" Sheathed 0.180" Bul
S34 - PC Rated Sidemarker				Pg 13
S33-0S00-1	3/4" Mini Sidemarker Stainless Steel Trim Ring	- -	100	-

Part No.	Part Description	Color	STD Pack	Wire/Conn
S34-AA00-1	3/4" Mini PC Amber Light Amber Lens, Black Ground		100	9" Sheathed Black-GND
S34-AA09-1	3/4" Mini PC Amber Light Amber Lens		100	9" Sheathed White-GND
S34-AA9B-1	3/4" Mini PC Amber Light Amber Lens w/ .180" Bullet		100	9" Sheathed 0.180" Bul
S34-AC00-1	3/4" Mini PC Amber Light Clear Lens, Black Ground		100	9" Sheathed Black-GND
S34-AC09-1	3/4" Mini PC Amber Light Clear Lens		100	9" Sheathed White-GND
S34-AC9B-1	3/4" Mini PC Amber Light Clear Lens w/ .180" Bullet		100	9" Sheathed 0.180" Bul
S34-RC00-1	3/4" Mini PC Red Light Clear Lens, Black Ground		100	9" Sheathed Black-GND
S34-RC09-1	3/4" Mini PC Red Light Clear Lens		100	9" Sheathed White-GND
S34-RC9B-1	3/4" Mini PC Red Light Clear Lens w/ .180" Bullet		100	9" Sheathed 0.180" Bul
S34-RR00-1	3/4" Mini PC Red Light Red Lens, Black Ground		100	9" Sheathed Black-GND
S34-RR09-1	3/4" Mini PC Red Light Red Lens		100	9" Sheathed White-GND
S34-RR9B-1	3/4" Mini PC Red Light Red Lens w/ .180" Bullet		100	9" Sheathed 0.180" Bul
S34-RR30-1	Over 80" 3 Red Mini PC Sidemarkers 12" Lead		100	12" Sheathed White-GND
S34-RR31-1	Over 80" 3 Red Mini PC Sidemarkers 48" Lead		100	48" Sheathed White-GND
S36 - Sidemarker				Pg 16
S36-AA10-1	S36 P2 Sidemarker Amber Light Amber Lens		100	Two Pole (S99-36xx-1)
S36-AC10-1	S36 P2 Sidemarker Amber Light Clear Lens		100	Two Pole (S99-36xx-1)
S36-RR10-1	S36 P2 Sidemarker Red Light Red Lens		100	Two Pole (S99-36xx-1)
S36-RC10-1	S36 P2 Sidemarker Red Light Clear Lens		100	Two Pole (S99-36xx-1)
S36-AA20-1	S36 PC Sidemarker Amber Light Amber Lens 2 LEDs		100	Two Pole (S99-36xx-1)
S36-AC20-1	S36 PC Sidemarker Amber Light Clear Lens 2 LEDs		100	Two Pole (S99-36xx-1)
S36-RR20-1	S36 PC Sidemarker Red Light Red Lens 2 LEDs		100	Two Pole (S99-36xx-1)
S36-RC20-1	S36 PC Sidemarker Red Light Clear Lens 2 LEDs		100	Two Pole (S99-36xx-1)
S50 - Heavy Duty ID Bar				Pg 7
S50-AAB0-1	S50 Tri-Bar Black Body Amber Light Amber Lens		25	9" Sheathed White-GND
S50-ACB0-1	S50 Tri-Bar Black Body Amber Light Clear Lens		25	9" Sheathed White-GND
S50-RRB0-1	S50 Tri-Bar Black Body Red Light Red Lens		25	9" Sheathed White-GND
S50-RCB0-1	S50 Tri-Bar Black Body Red Light Clear Lens		25	9" Sheathed White-GND
S90 - Heavy Duty Miniature Bi-color Fender Light				Pg 17
S90-OSS0-1	Fender Sidemarker Light SS Stamping	- -	150	-
S90-0000-1	Fender Sidemarker Light Amber/Red Combination		150	9" Pigtail
S90-0B20-1	Fender Sidemarker Light Wire Guide Cover Black	- -	150	-
S90-0C20-1	Fender Sidemarker Light Wire Guide Cover Chrome	- -	150	-
S90-0B00-1	Fender Sidemarker Light Wire Guide Black	- -	150	-
S90-0C00-1	Fender Sidemarker Light Wire Guide Chrome	- -	150	-
S90-0BS0-1	Fender Sidemarker Light Wire Guide Black - 4 Hole	- -	150	-
S90-0CS0-1	Fender Sidemarker Light Wire Guide Chrome - 4 Hole	- -	150	-
T1x - Low Profile Tail Light/ID Bar				Pg 7
T10-0C00-1	Low Profile STT/ID Bar Chrome Bezel	- -	100	-
T10-AA00-1	Low Profile Turn Amber Light Amber Lens		100	9" Pigtail
T10-AC00-1	Low Profile Turn Amber Light Clear Lens		100	9" Pigtail
T10-LC00-1	Low Profile High Output Auxiliary Light		100	9" Pigtail
T10-RR00-1	Low Profile STT Red Light Red Lens		100	9" Pigtail
T10-RC00-1	Low Profile STT Red Light Clear Lens		100	9" Pigtail

Part No.	Part Description	Color	STD Pack	Wire/Conn
T10-RR0B-1	Low Profile STT Red Light Red Lens w/ .180" Bullets		100	9" / 0.180" Bul
T11-RC00-1	Low Profile ID Bar/Third Brake Red Light Clear Lens		100	9" Pigtail
T11-RR00-1	Low Profile ID Bar/Third Brake Red Light Red Lens		100	9" Pigtail
T12-AA00-1	Low Profile ID Bar Amber Light Amber Lens		100	9" Pigtail
T12-AC00-1	Low Profile ID Bar Amber Light Clear Lens		100	9" Pigtail
T12-RR00-1	Low Profile ID Bar Red Light Red Lens		100	9" Pigtail
T12-RC00-1	Low Profile ID Bar Red Light Clear Lens		100	9" Pigtail
T12-RR0B-1	Low Profile ID Bar Red Light Red Lens w/ .180" Bullets		100	9" / 0.180" Bul
T12-RW00-1	Low Profile ID Bar Red/White Load Lamp Clear Lens		100	9" Pigtail
T13-RR00-1	Low Profile ID Bar/Turn Signals Red Light Red Lens		100	9" Pigtail
T13-RC00-1	Low Profile ID Bar/Turn Signals Red Light Clear Lens		100	9" Pigtail



T40 - 4" Round Stop-Turn-Tail





Pg 4

T40-0G00-1	4" Round Grommet	- -	100	-
T40-0S00-1	4" Round SS Trim Ring	- -	100	-
T40-AA0A-1	4" Round Amber Turn Lamp Amber Lens Amp Connection		100	Amp
T40-AA0P-1	4" Round Amber Turn Lamp Amber Lens Pigtail		100	9" Pigtail
T40-AA0T-1	4" Round Amber Turn Lamp Amber Lens Tri-Pole		100	3-Pole
T40-AAFA-1	4" Round Amber Turn Lamp Amber Lens Amp Connection Flange		100	Amp
T40-AAFB-1	4" Round Amber Turn Lamp Amber Lens .180" Bullets Flange		100	9" / 0.180" Bul
T40-AAFP-1	4" Round Amber Turn Lamp Amber Lens Pigtail Flange		100	9" Pigtail
T40-AAFT-1	4" Round Amber Turn Lamp Amber Lens Tri-Pole Flange		100	3-Pole
T40-AC0A-1	4" Round Amber Turn Lamp Clear Lens Amp Connection		100	Amp
T40-AC0P-1	4" Round Amber Turn Lamp Clear Lens Pigtail		100	9" Pigtail
T40-AC0T-1	4" Round Amber Turn Lamp Clear Lens Tri-Pole		100	3-Pole
T40-ACFA-1	4" Round Amber Turn Lamp Clear Lens Amp Connection Flange		100	Amp
T40-ACFP-1	4" Round Amber Turn Lamp Clear Lens Pigtail Flange		100	9" Pigtail
T40-ACFT-1	4" Round Amber Turn Lamp Clear Lens Tri-Pole Flange		100	3-Pole
T40-RR0A-1	4" Round STT Lamp Red Light Red Lens Amp Connection		100	Amp
T40-RR0B-1	4" Round STT Lamp Red Light Red Lens .180" Bullets		100	9" / 0.180" Bul
T40-RR0P-1	4" Round STT Lamp Red Light Red Lens Pigtail		100	9" Pigtail
T40-RR0T-1	4" Round STT Lamp Red Light Red Lens Tri-Pole		100	3-Pole
T40-RRFA-1	4" Round STT Lamp Red Light Red Lens Amp Connection Flange		100	Amp
T40-RRFB-1	4" Round STT Lamp Red Light Red Lens .180" Bullets Flange		100	9" / 0.180" Bul
T40-RRFP-1	4" Round STT Lamp Red Light Red Lens Pigtail Flange		100	9" Pigtail
T40-RRFT-1	4" Round STT Lamp Red Light Red Lens Tri-Pole Flange		100	3-Pole
T40-RC0A-1	4" Round STT Lamp Red Light Clear Lens Amp Connection		100	Amp
T40-RC0P-1	4" Round STT Lamp Red Light Clear Lens Pigtail		100	9" Pigtail
T40-RC0T-1	4" Round STT Lamp Red Light Clear Lens Tri-Pole		100	3-Pole
T40-RCFA-1	4" Round STT Lamp Red Light Clear Lens Amp Conn. Flange		100	Amp
T40-RCFP-1	4" Round STT Lamp Red Light Clear Lens Pigtail Flange		100	9" Pigtail
T40-RCFT-1	4" Round STT Lamp Red Light Clear Lens Tri-Pole Flange		100	3-Pole

T41 - 4" Round Reverse Lamp



Pg 8

T41-WC0A-1	4" Round 2x Reverse Lamp Amp Connection		100	Amp
T41-WC0B-1	4" Round 2x Reverse Lamp .180" Bullet Connection		100	9" / 0.180" Bul

Part No.	Part Description	Color	STD Pack	Wire/Conn
T41-WC0P-1	4" Round 2x Reverse Lamp Pigtail Connection		100	9" Pigtail
T41-WC0T-1	4" Round 2x Reverse Tri-Pole Connection		100	3-Pole
T41-WCFA-1	4" Round 2x Reverse Amp Connection Flange Mount		100	Amp
T41-WCFP-1	4" Round 2x Reverse Pigtail Connection Flange Mount		100	9" Pigtail
T41-WCFT-1	4" Round 2x Reverse Tri-Pole Connection Flange Mount		100	3-Pole



























T44 - 4" Interior Dome Light

Pg 27

T44-WD0B-1	4" Round Grommet Mount Dome Light w/ .180" Bullets		140	9" / 0.180" Bul
T44-WDFB-1	4" Round Flange Mount Dome Light w/ .180" Bullets		140	9" / 0.180" Bul



T60 - 6" Grommet Mount Oval Stop-Turn-Tail





















































































Pg 2

























T60-0G00-1	6" Oval Grommet	- -	-	-
T60-0GP0-1	6" Oval Grommet Gray	- -	-	-
T60-AAHA-1	6" Oval Amber Turn Horizontal Mount Amber Lens Amp Conn.		100	Amp
T60-AAHP-1	6" Oval Amber Turn Horizontal Mount Amber Lens Pigtail Conn.		140	9" Pigtail
T60-AAHT-1	6" Oval Amber Turn Horizontal Mount Amber Lens Tri-Pole Conn.		100	3-Pole
T60-AAVA-1	6" Oval Amber Turn Vertical Mount Amber Lens Amp Connection		100	Amp
T60-AAVP-1	6" Oval Amber Turn Vertical Mount Amber Lens Pigtail Connection		140	9" Pigtail
T60-AAVT-1	6" Oval Amber Turn Vertical Mount Amber Lens Tri-Pole Conn.		100	3-Pole
T60-ACHA-1	6" Oval Amber Turn Horizontal Mount Clear Lens Amp Connection		100	Amp
T60-ACHP-1	6" Oval Amber Turn Horizontal Mount Clear Lens Pigtail Conn.		140	9" Pigtail
T60-ACHT-1	6" Oval Amber Turn Horizontal Mount Clear Lens Tri-Pole Conn.		100	3-Pole
T60-ACVA-1	6" Oval Amber Turn Vertical Mount Clear Lens Amp Connection		100	Amp
T60-ACVP-1	6" Oval Amber Turn Vertical Mount Clear Lens Pigtail Connection		140	9" Pigtail
T60-ACVT-1	6" Oval Amber Turn Vertical Mount Clear Lens Tri-Pole Conn.		100	3-Pole
T60-RRHA-1	6" Oval STT Horizontal Mount Red Lens Amp Connection		100	Amp
T60-RRHB-1	6" Oval STT Horizontal Mount Red Lens .180" Bullet Connection		140	9" / 0.180" Bul
T60-RRHP-1	6" Oval STT Horizontal Mount Red Lens Pigtail Connection		140	9" Pigtail
T60-RRHT-1	6" Oval STT Horizontal Mount Red Lens Tri-Pole Connection		100	3-Pole
T60-RRVA-1	6" Oval STT Vertical Mount Red Lens Amp Connection		100	Amp
T60-RRVP-1	6" Oval STT Vertical Mount Red Lens Pigtail Connection		140	9" Pigtail
T60-RRVT-1	6" Oval STT Vertical Mount Red Lens Tri-Pole Connection		100	3-Pole
T60-RCHA-1	6" Oval STT Horizontal Mount Clear Lens Amp Connection		100	Amp
T60-RCHP-1	6" Oval STT Horizontal Mount Clear Lens Pigtail Connection		140	9" Pigtail
T60-RCHT-1	6" Oval STT Horizontal Mount Clear Lens Tri-Pole Connection		100	3-Pole
T60-RCVA-1	6" Oval STT Vertical Mount Clear Lens Amp Connection		100	Amp
T60-RCVP-1	6" Oval STT Vertical Mount Clear Lens Pigtail Connection		140	9" Pigtail
T60-RCVT-1	6" Oval STT Vertical Mount Clear Lens Tri-Pole Connection		100	3-Pole
T60-WCHP-1	6" Oval Tail Light White		140	9" Pigtail
T60-WCVA-1	6" Oval Tail Light White – Vertical Grommet Mount Amp Conn.		100	Amp

T61 - Surface mount Oval Stop-Turn-Tail

Pg 3

T61-0B00-1	6" Oval Srfce Mount Trim Ring Black	- -	-	-
T61-0C00-1	6" Oval Srfce Mount Trim Ring Chrome	- -	-	-
T61-0G00-1	6" Oval Srfce Mount Gasket	- -	-	-
T61-AAHA-1	6" Oval Amber Turn Horiz Srfce Mount Amber Lens Amp Conn.		100	Amp
T61-AAHP-1	6" Oval Amber Turn Horiz Srfce Mount Amber Lens Pigtail Conn.		140	9" Pigtail

Part No.	Part Description	Color	STD Pack	Wire/Conn
T61-AAHT-1	6" Oval Amber Turn Horiz Srfce Mount Amber Lens Tri-Pole Conn.	 	100	3-Pole
T61-AAVA-1	6" Oval Amber Turn Vert Srfce Mount Amber Lens Amp Conn.	 	100	Amp
T61-AAVP-1	6" Oval Amber Turn Vert Srfce Mount Amber Lens Pigtail Conn.	 	140	9" Pigtail
T61-AAVT-1	6" Oval Amber Turn Vert Srfce Mount Amber Lens Tri-Pole Conn.	 	100	3-Pole
T61-ACHA-1	6" Oval Amber Turn Horiz Srfce Mount Clear Lens Amp Conn.	 	100	Amp
T61-ACHP-1	6" Oval Amber Turn Horiz Srfce Mount Clear Lens Pigtail Conn.	 	140	9" Pigtail
T61-ACHT-1	6" Oval Amber Turn Horiz Srfce Mount Clear Lens Tri-Pole Conn.	 	100	3-Pole
T61-ACVA-1	6" Oval Amber Turn Vert Srfce Mount Clear Lens Amp Connection	 	100	Amp
T61-ACVP-1	6" Oval Amber Turn Vert Srfce Mount Clear Lens Pigtail Conn.	 	140	9" Pigtail
T61-ACVT-1	6" Oval Amber Turn Vert Srfce Mount Clear Lens Tri-Pole Conn.	 	100	3-Pole
T61-RRHA-1	6" Oval STT Horizontal Srfce Mount Red Lens Amp Connection	 	100	Amp
T61-RRHB-1	6" Oval STT Horizontal Srfce Mount Red Lens .180" Bullet Conn.	 	140	9" / 0.180" Bul
T61-RRHP-1	6" Oval STT Horizontal Srfce Mount Red Lens Pigtail Connection	 	140	9" Pigtail
T61-RRHT-1	6" Oval STT Horizontal Srfce Mount Red Lens Tri-Pole Connection	 	100	3-Pole
T61-RRVA-1	6" Oval STT Vertical Srfce Mount Red Lens Amp Connection	 	100	Amp
T61-RRVP-1	6" Oval STT Vertical Srfce Mount Red Lens Pigtail Connection	 	140	9" Pigtail
T61-RRVT-1	6" Oval STT Vertical Srfce Mount Red Lens Tri-Pole Connection	 	100	3-Pole
T61-RCHA-1	6" Oval STT Horizontal Srfce Mount Clear Lens Amp Connection	 	100	Amp
T61-RCHP-1	6" Oval STT Horizontal Srfce Mount Clear Lens Pigtail Connection	 	140	9" Pigtail
T61-RCHT-1	6" Oval STT Horizontal Srfce Mount Clear Lens Tri-Pole Conn.	 	100	3-Pole
T61-RCVA-1	6" Oval STT Vertical Srfce Mount Clear Lens Amp Connection	 	100	Amp
T61-RCVP-1	6" Oval STT Vertical Srfce Mount Clear Lens Pigtail Connection	 	140	9" Pigtail
T61-RCVT-1	6" Oval STT Vertical Srfce Mount Clear Lens Tri-Pole Connection	 	100	3-Pole
T61-WCHP-1	6" Oval White Light Surface Mount Clear Lens Pigtail Connection	 	140	9" Pigtail
T61-WCOA-1	6" Oval White Light Grommet Mount Clear Lens Amp Connection	 	100	Amp
T62 - Flush Mount Oval Tail				Pg 4
T62-AAHA-1	6" Oval Turn Horizontal Flush Mount Amber Lens Amp Connection	 	120	Amp
T62-RCHA-1	6" Oval Tail Horiz Flush Mount Red Light Clear Lens Amp Conn	 	120	Amp
T62-RCVA-1	6" Oval Tail Vert Flush Mount Red Light Clear Lens Amp Conn.	 	120	Amp
T62-RRHA-1	6" Oval Tail Horiz Flush Mount Red Light Red Lens Amp Conn.	 	120	Amp
T62-RRVA-1	6" Oval Tail Vert Flush Mount Red Light Red Lens Amp Conn.	 	120	Amp
T62-WCVA-1	6" Oval Tail Vertical Flush Mount White	 	120	Amp
T66 - Universal Mount Oval Stop-Turn-Tail				Pg 5
T66-AA0A-1	6" Oval 6 LED Turn Grommet Mount Amber Lens Amp Conn.	 	120	Amp
T66-AA0P-1	6" Oval 6 LED Turn Grommet Mount Amber Lens Pigtail Conn.	 	140	9" Pigtail
T66-AA0T-1	6" Oval 6 LED Turn Grommet Mount Amber Lens Tri-Pole Conn.	 	120	3-Pole
T66-AC0A-1	6" Oval 6 LED Turn Grommet Mount Clear Lens Amp Conn.	 	120	Amp
T66-AC0P-1	6" Oval 6 LED Turn Grommet Mount Clear Lens Pigtail Conn.	 	140	9" Pigtail
T66-AC0T-1	6" Oval 6 LED Turn Grommet Mount Clear Lens Tri-Pole Conn.	 	120	3-Pole
T66-RR0A-1	6" Oval 6 LED STT Grommet Mount Red Lens Amp Connection	 	120	Amp
T66-RR0P-1	6" Oval 6 LED STT Grommet Mount Red Lens Pigtail Connection	 	140	9" Pigtail
T66-RR0T-1	6" Oval 6 LED STT Grommet Mount Red Lens Tri-Pole Conn.	 	120	3-Pole
T66-RC0A-1	6" Oval 6 LED STT Grommet Mount Clear Lens Amp Connection	 	120	Amp
T66-RC0P-1	6" Oval 6 LED STT Grommet Mount Clear Lens Pigtail Connection	 	140	9" Pigtail

Part No.	Part Description	Color	STD Pack	Wire/Conn
T66-RC0T-1	6" Oval 6 LED STT Grommet Mount Clear Lens Tri-Pole Conn.	 	120	3-Pole
T66-RRSP-1	6" Oval 6 LED STT Surface Mount Red Lens Pigtail Connection	 	140	9" Pigtail
T66-WCRB-1	6" Oval 6 LED White Reverse Light .180" Bullet Connection	 	140	9" / 0.180" Bul
T66-WCRT-1	6" Oval 6 LED White Reverse Light Tri-Pole Connection	 	120	3-Pole
T80 - Low Profile Multifunction Box Tail Light				Pg 6
T80-RRLG-1	8 Function 8" Box Tail Light Left Side Pigtail Conn. w/ Ground Ring	 	32	9" Pigtail Gnd Ring
T80-RRLP-1	8 Function 8" Box Tail Light Left Side Pigtail	 	32	9" Pigtail
T80-RRRG-1	7 Function 8" Box Tail Light Right Side Pigtail Conn. w/ Ground Ring	 	32	9" Pigtail Gnd Ring
T80-RRRP-1	7 Function 8" Box Tail Light Right Side Pigtail	 	32	9" Pigtail
T85 - Low Profile Multifunction Box Tail Light				Pg 6
T85-RRLG-1	8 Function 4" Box Tail Light Left Side Pigtail Conn. & Ground Ring	 	32	9" Pigtail Gnd Ring
T85-RRLP-1	8 Function 4" Box Tail Light Left Side Pigtail	 	32	9" Pigtail
T85-RRRG-1	7 Function 4" Box Tail Light Right Side Pigtail Conn. & Ground Ring	 	32	9" Pigtail Gnd Ring
T85-RRRP-1	7 Function 4" Box Tail Light Right Side Pigtail	 	32	9" Pigtail
Wires & Connectors				Pg 33
S99-0010-1	2-Pole .156" Bullets 6" Wire w/ #6 GND Lug	- -	-	-
S99-0035-1	S35 2-Pole Sure-Seal w/ .180" Bullet and #6 GND Lug 90 degrees	- -	-	-
S99-0A35-1	S35 2-Pole Sure-Seal w/ .180" Bullet and 1" #10 GND Lug	- -	-	-
S99-1A35-1	S35 2-Pole Sure-Seal 8" Leads	- -	-	-
S99-3600-1	2-Pole Connector w/ Bullet Ends	- -	-	-
S99-3610-1	2-Pole Connector w/ Bullet Ends and Grommet	- -	-	-
T99-0010-1	3-Pole .156" Bullet 12" wire w/ #6 GND Lug - Straight	- -	-	-
T99-0020-1	3-Pole .156" Bullet 12" wire w/ #6 GND Lug - 90 degrees	- -	-	-
T99-0040-1	Amp - Pigtail Wire Adapter	- -	-	-
T99-0050-1	Amp - Tri-Pole Adapter	- -	-	-
T99-0060-1	3-Pole .156" Bullets with 6" wires	- -	-	-

TecNiq^{inc}

Changing the Shape of Light™



www.TecNiqInc.com



Lifetime Limited Warranty

TecNiq, Inc. extends a Lifetime Limited Warranty to the original purchaser that the TecNiq, Inc. Lamp is free from defects in workmanship and/or materials only. TecNiq, Inc. will replace any TecNiq, Inc. lamp to the original consumer/purchaser if the lamp fails due to defects in workmanship and/or materials only. TecNiq, Inc. products are incompatible with many chemicals and/or cleaners, and the Limited Lamp Warranty does not apply to damage associated with or caused by incompatible chemicals and/or cleaners. The Limited Lamp Warranty is not transferable and applies to only the original installation of the lamp for as long as the original consumer/purchaser owns the vehicle. To be eligible for coverage under the Lifetime Limited Warranty protection, the TecNiq, Inc. product must remain intact, free from physical abuse, and have been properly installed. The Lifetime Limited Warranty does not constitute in any way a product guaranty, and TecNiq, Inc. does not hereby assume any obligation of any kind whatsoever other than sending a free replacement product as applicable under the Lifetime Limited Warranty. TecNiq, Inc. does not warrant its products as to their fitness for any special use or function.