

INSTRUCTION MANUAL



**TEAC** **A-2340**  
**A-3340**  
® 4 CHANNEL SIMUL-SYNC  
STEREO TAPE DECKS

## CONTENTS

Introduction .....	1
Rear panel connections .....	4
Connections to and from the 2340/3340 .....	5
Location of controls .....	7
Threading the tape .....	10
Playback operation .....	12
General recording information .....	14
Recording operation .....	20
Maintenance .....	26
Specifications .....	28
Optional accessories .....	29

## INTRODUCTION

Your new TEAC 2340/3340 has been manufactured under the strictest quality control procedures, each unit has been thoroughly checked at the factory. Should any damage have been incurred during transit or should you have any doubts as to its performance, contact your dealer as soon as possible. Our investigation has shown that approximately 40% of the calls for service immediately after purchase, result from improper operation of the equipment. Therefore it is important that you thoroughly read and understand this manual before placing the unit in operation.

A lack of, or improper cleaning can also result in a degradation of performance. Careful observation of the cleaning and servicing hints contained in this manual will contribute to a lengthened trouble free unit life.

In this manual all 2340/3340 control designations will be in upper case letters, exactly as they appear on the tape deck. External amplifier controls will be in lower case letters and may not correspond to those on your amplifier.

Throughout the manual you will see repeated references to "front" and "rear" amplifiers. These terms do not refer to location of the amplifiers but to the normal placement of the four microphones used for true 4-channel recording. The usual practice is to have two microphones placed at the front of the recording studio and two more at the rear. When installing the 4-channel playback system, speaker placement should be in accordance with the placement of the microphones during recording. Hence "front" and "rear" amplifiers. The front amplifier amplifies the signals from the front, left and right tracks (Tracks #1 and #3), the rear amplifier is fed with the signals from the remaining two tracks (Tracks #2 and #4). When playing stereo (2-channel 4-track) tapes, only the front amplifier is used unless your system incorporates a method of paralleling the amplifiers.

### ● INSTALLATION SUGGESTIONS

Do not operate this unit near heating appliances or on top of an amplifier where amplifier heat would contribute to a rise in temperature. Do not place the unit where it will be exposed to direct summer sunlight. Temperature extremes will not only cause degradation of sound quality but will

also shorten the useful operating life of the unit. Avoid temperatures higher than 100°F.

In low temperature locations lubricants will harden and satisfactory operation cannot be expected. Operation will be sluggish and an overload may be placed on the drive motors. Avoid temperatures lower than 40°F.

High humidity locations will shorten equipment life due to corrosion and possible fungus growth on printed circuit boards.

Should you be in an area where line voltage fluctuation is severe, the use of an automatic voltage controller is recommended.

3-motor decks naturally generate more heat than 1-motor units; therefore, it is extremely important that you choose a level space which affords adequate ventilation in the placement of your tape deck. This is especially true if you choose to operate your tape deck in a horizontal position (in which it will get noticeably warmer) - so avoid placement on thick carpets for example.

#### ● SERVICE

Should the equipment need repair, contact the dealer where it was purchased, or the TEAC authorized service center nearest you.

- 1) The warranty period is described in the enclosed warranty card. Read the card for complete details.
- 2) For repairs after expiration of the warranty period a service charge will be made in addition to the price of repair parts.
- 3) If only repair parts are required, place your order with your dealer or any TEAC authorized service center.

#### ● NOTE

Although the unit may still be under the warranty period, you may be charged for repairs made necessary by misuse, or damage incurred as a result of improper operation.

## ● CHANGING THE POWER LINE SETTING

The deck is adjusted to the power voltage and frequency indicated on the carton, before shipment from the factory. If it is to be used under different power ratings, the tape deck must be reset as outlined below:

Note: Always disconnect the power cord from the AC outlet before resetting.

### WHEN VOLTAGE IS DIFFERENT

The unit may be set for 100, 117, 200, 220 and 240 volts AC. To change the voltage, unscrew the fuse in the center of the voltage selector plug. Pull out the plug and reinsert it so that the desired voltage shows in the cutout. Reinstall the fuse.

### WHEN FREQUENCY IS DIFFERENT

1. Remove the power cord and all connecting cables.
2. Take off tape deck rear cover by removing the screws holding it.
3. The belt linking the motor pulley and flywheel must be repositioned.  
The motor pulley on the unit has two steps and difference in rotation due to a different power frequency is compensated for by changing the belt step on the pulley. Reposition the belt with your fingers, at the flywheel first and then at the pulley when switching from 60Hz to 50Hz, or the pulley first and then the flywheel when changing from 50Hz to 60Hz.
4. After repositioning belt, rotate the flywheel several turns with your finger to make sure the belt is correctly seated on the steps.
5. The frequency selector switch inside the tape deck must be switched to the frequency of the power line.
6. Reinstall the rear cover of tape deck.

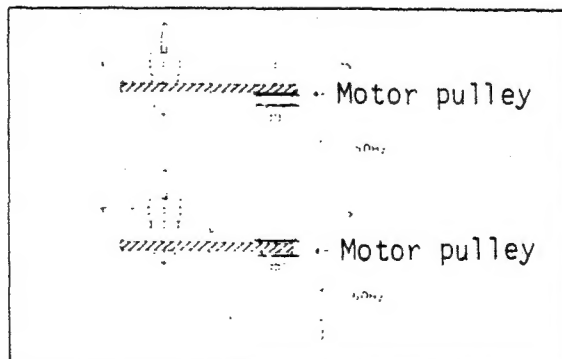
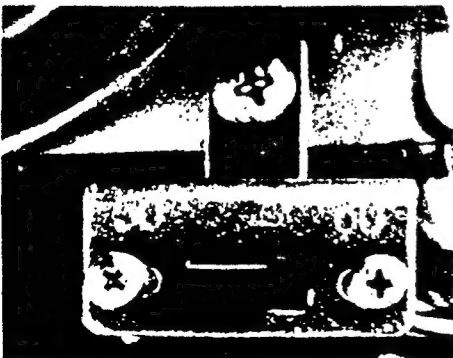

## REAR PANEL CONNECTIONS

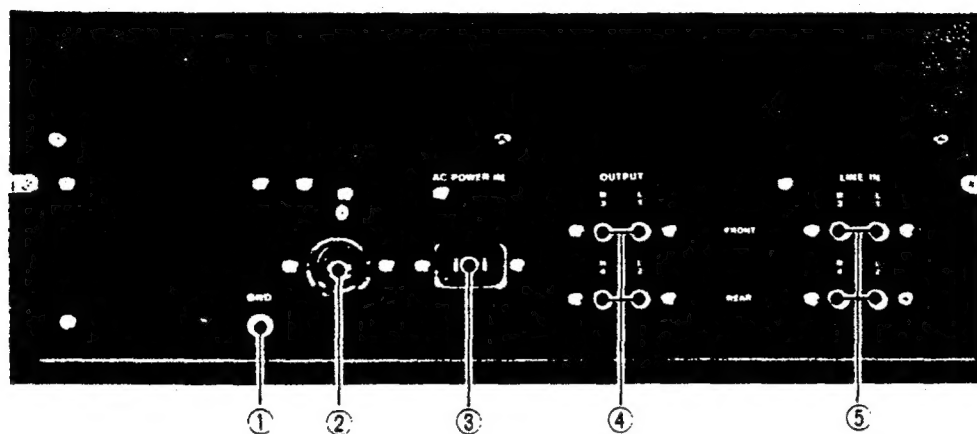

1. Ground terminal
2. Fuse 2A
3. AC power in
4. OUTPUT terminals
5. LINE IN terminals

R - right    L - left

### Before making connections

1. Set the POWER switch button to OFF.
2. Make sure the power line voltage and frequency to be used matches those on the card attached to the deck. If they do not match, change the setting after carefully reading "changing the power line setting", page 3.

# CONNECTIONS TO AND FROM THE 2340/3340

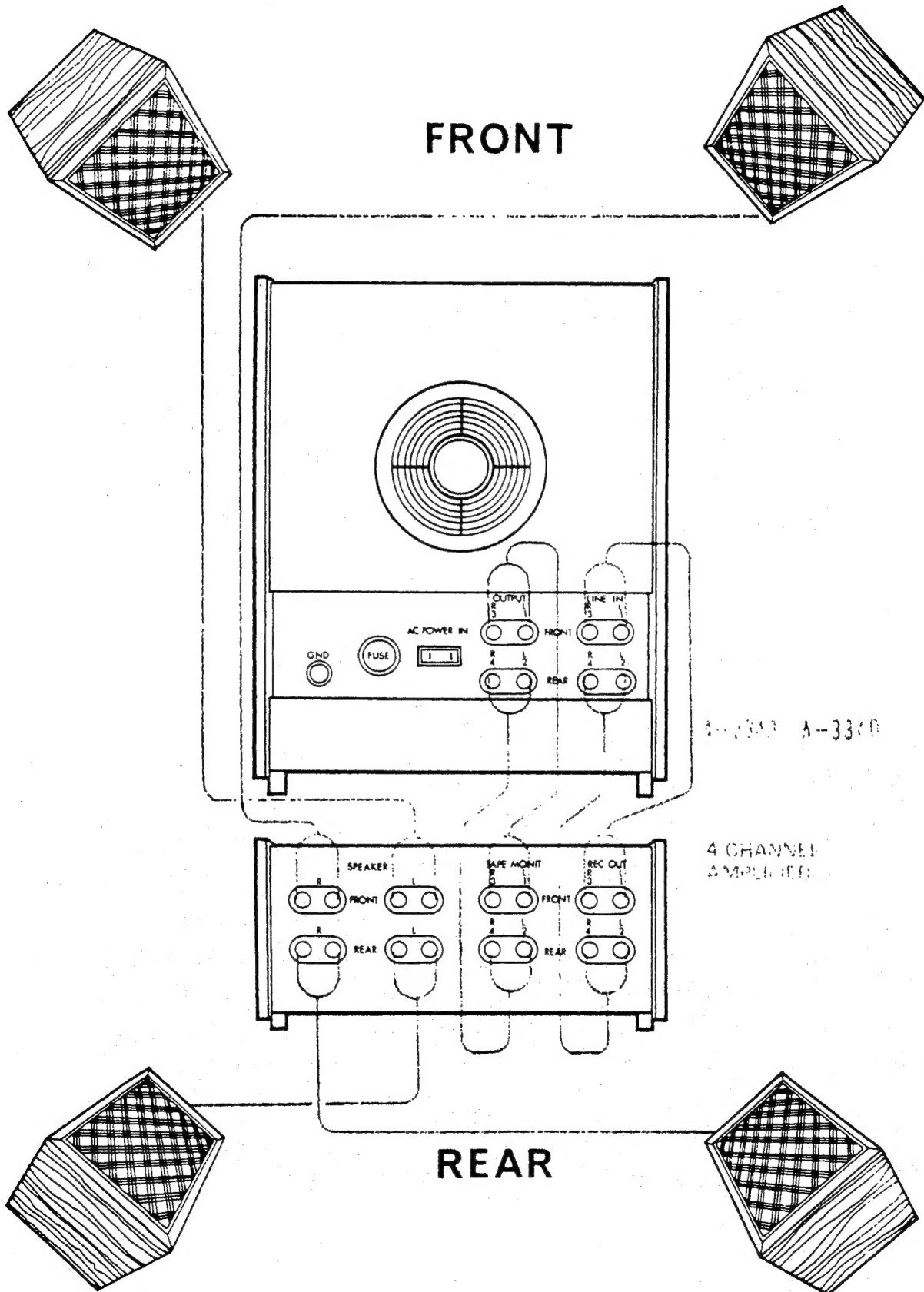

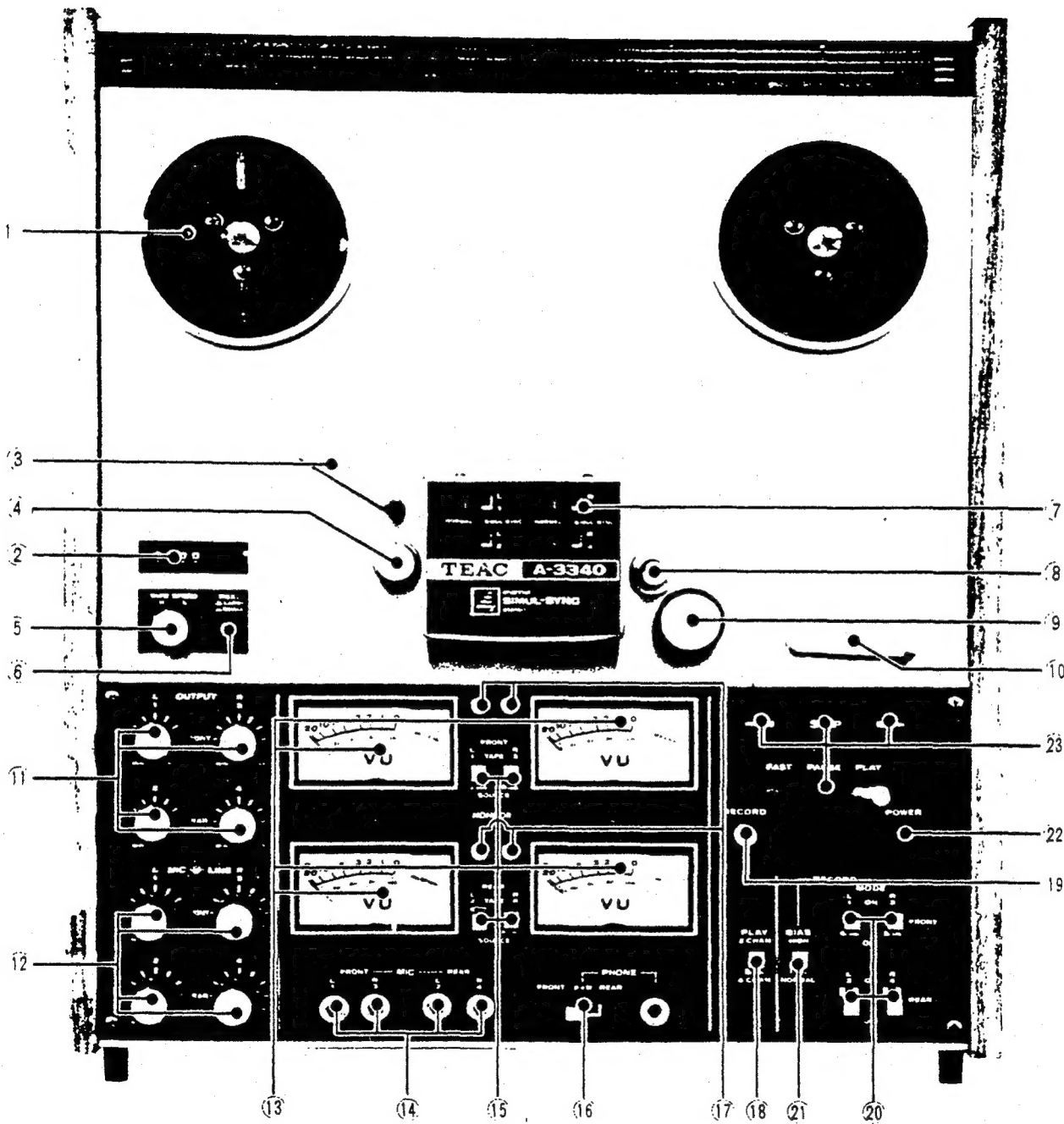





11. OUTPUT level controls:

The 4 independent output controls provide complete flexibility during playback of 4 channel tapes or SIMUL-SYNC recordings. They also control the output volume at the headphone jacks.

12. MIC-LINE recording level controls:

These dual concentric knobs control the recording signal levels from the 8 recording inputs. MIC/LINE mixing can be accomplished by varying the individual input levels.

13. VU meters:

Provide individual channel monitoring during record or playback. VU meter placement corresponds to the usual speaker geometry for 4 channel playback.

14. MICROPHONE jacks:

Front right and left, Rear right and left. Input impedance 600 ohms.

15. MONITOR select switches:

These switches perform a triple function, they allow you to monitor either the source signal before it is recorded, or the signal from the tape after it is recorded. In addition they select the signal (tape or source) to be displayed on the VU meters and to be present at the headphone receptacle.

16. PHONE selector switch and jack:

Phone jack accepts any standard 3 conductor headphone plug, headset impedance is 8 ohms. The PHONE selector switch permits monitoring of front channels, rear channels or front and rear channels combined.

17. RECORD lights:

Illuminate to indicate which tracks or channels are in the recording mode.

18. PLAY button:

Selects either 2-channel(stereo) or 4-channel operation during playback. Switch must be in 4-channel position for 4-channel or SIMUL-SYNC recording. In 2-channel position lower 2 VU meter lights are extinguished.

19. RECORD button:

This button in conjunction with the forward play button ► places the deck in the recording mode.

20. RECORD MODE switches:

Allow selection of channel or channels to be recorded.

21. RECORD BIAS switch: (See BIAS SETTING, page 19 )  
Selects the proper bias level for conventional tapes or Low Noise/High Output tapes.  
HIGH: Used when recording Low Noise/High Output tapes such as Scotch 203, BASF LP-35LH etc.  
LOW : Used when recording conventional tapes such as Scotch 150, Sony Super 150 etc.  
Has no effect during playback.
22. POWER switch:  
VU meters will illuminate when this switch is depressed. To turn off power, depress again and release.
23. Tape transport buttons, Tape mode lever:  
With the tape mode lever below these buttons at PLAY and the ► depressed, the tape will be transported from left to right.  
With the tape mode lever at FAST, depressing either the ◀ or ► button will cause the tape to be wound rapidly in the direction of the arrow.  
STOP button; stops the tape in any mode of operation and also disengages the record mode.  
PAUSE ; temporarily stops the tape in the recording mode without disengaging the recording mode.  
During playback (left to right only) you may engage the recording mode at any time by simultaneously pressing the ► and the RECORD button. This feature is most useful for editing or for eliminating unwanted material.

## REEL PLACEMENT (either reel)

1. Loosen the reel shaft tip fully CCW (counter-clockwise). See Ref.1 in the picture below.
2. Match the inner 3 index tabs (Ref. 3) and the outer 3 index tabs (Ref. 2) so they are aligned. This is done by turning the outer 3 index tabs slightly CCW until the inner and outer index tabs are in a straight line with each other.
3. With the fingers of both hands, grasp the reel and place the center hole partially over the reel shaft up. (Ref. 1) Then gently rotate the reel CCW while sliding the reel fully onto the turntable. When the outer 3 index tabs (Ref. 2) are fully visible above the reel, you may proceed to step 4.
4. Carefully rotate the 3 outer index tabs (Ref.2) clockwise until they stop (approximately 60 degrees or 1/6 of a revolution). Turn the reel shaft tip (Ref. 1) clockwise approximately 3 revolutions until it is finger-tip tight. Check that the outer index tabs are still in the clockwise position, about mid-way between the corresponding slots on the reel.
5. Repeat the above steps in the same sequence for the other reel.

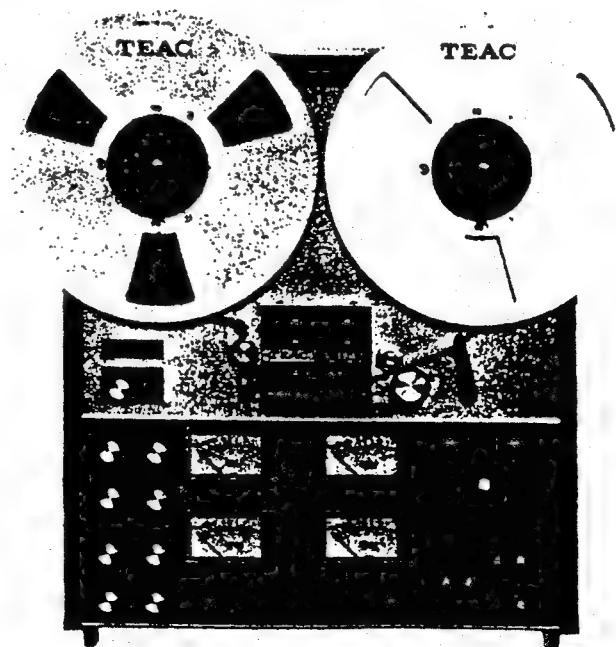
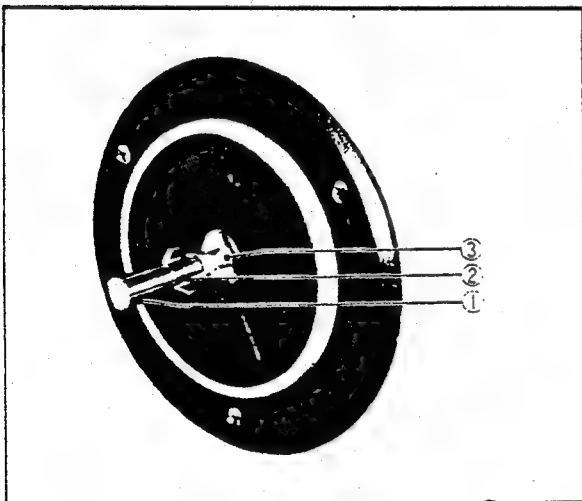

## THREADING THE TAPE

Turn metal post in center of turntable fully counterclockwise to align the reel index tabs, place full reel of tape on left turntable so that tape unwinds in a counterclockwise direction. Rotate metal post clockwise to lock reel into position on turntable.

If large center (NAB 10-1/2") reels are to be used, insert the plastic reel adapters into the center of the metal reels before placing them on the turntables, then secure as outlined above.

(The 3340 only)

Place an empty reel of the same size and hub diameter on the right reel turntable and lock the center post by turning it clockwise.

If large center (NAB 10-1/2") reels are to be used, insert the plastic reel adapters into the center of the metal reels before placing them on the turntables, then secure as outlined above. If standard center 10-1/2" reels (metal) are used, place a TEAC reel adjusting disc on each turntable before mounting the metal reels. This will compensate for the slight difference in thickness between metal and plastic reels.

Unwind a length of tape and thread it through each part in the order shown below;

1. over the left tension arm,
2. under the guide post,
3. across front face of head assembly,
4. between capstan and pinch roller,
5. under tape guide of shut-off lever,
6. Secure end of tape to empty reel, insert the end of the tape into the notch of the reel, while holding tape against reel rotate the reel so as to wind tape two or three times around the reel.
7. While holding left reel stationary, rotate the right reel counterclockwise to take up slack in the tape. Take up tape slack until the shut-off lever is brought to its full up position.
8. Place tape mode lever at PLAY position, tape will move from left to right reel when ► button is depressed.

## PLAYBACK OPERATION

### PLAYBACK OF 4-TRACK 4-CHANNEL STEREO TAPES

1. Thread tape on deck.
2. Set all SIMUL-SYNC switches to NORMAL position.
3. Set TAPE SPEED knob to speed at which tape was recorded.
4. Slide PLAY switch to 4 CHAN position.
5. Place all 4 MONITOR switches in TAPE position.
6. Move tape mode lever to PLAY position. Depress the ► button.
7. When playback begins, reset index counter to zero. Advance the OUTPUT controls until all 4 VU meters are indicating at or near the 0 VU area of the scale.
8. Make final volume, tone and balance adjustments with the controls of the Front and Rear power amplifiers.
9. You may now wish to stop the tape, rewind it to zero on the index counter and enjoy playback from the beginning.

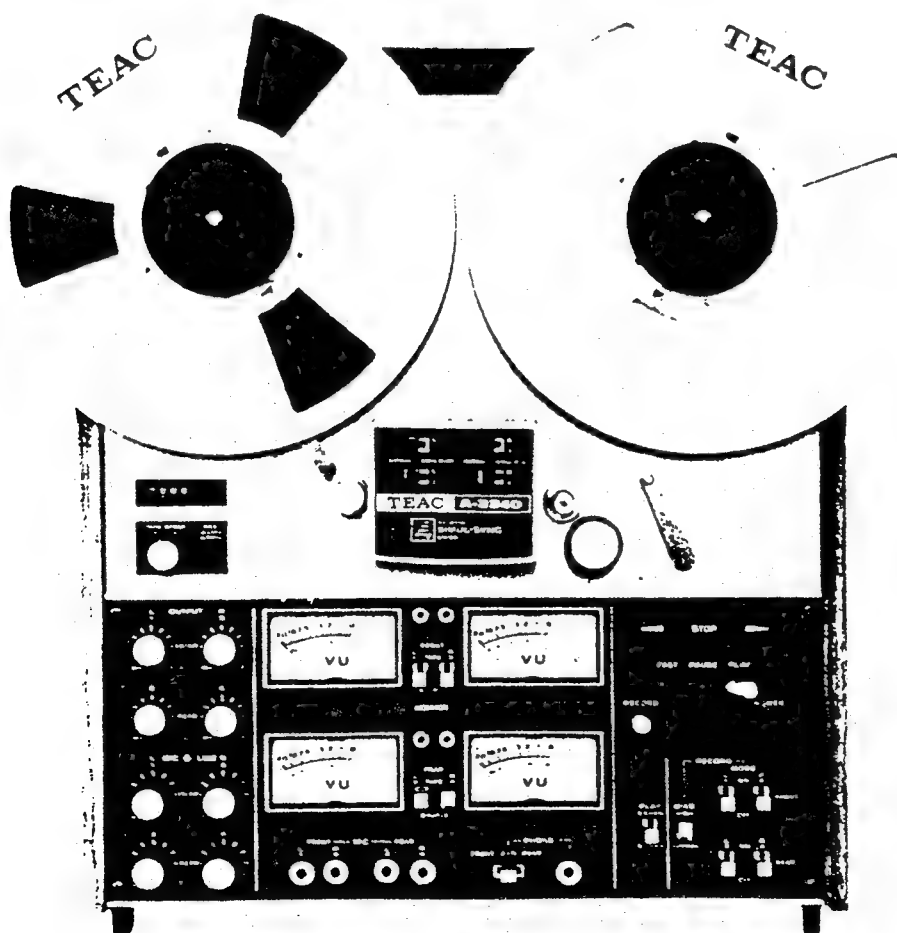

#### PLAYBACK OF 4-TRACK, 2 CHANNEL STEREOGRAPHIC TAPES

1. Thread tape on deck.
2. Set all SIMUL-SYNC switches to NORMAL position.
3. Set TAPE SPEED knob to speed at which tape was recorded.
4. Slide the PLAY switch to the 2 CHAN position. Lower VU meter lights will extinguish.
5. To use headphones, place PHONE switch in FRONT position.
6. Place the upper 2 MONITOR switches to TAPE position.
7. Move tape mode lever to PLAY position, depress the ► button.
8. When playback begins, reset index counter to zero. Advance the L-1 and R-3 OUTPUT controls so that VU meters indicate in the 0 VU area of the scale.
9. Make final volume, tone and balance adjustments with the controls of the Front amplifier.
10. After completion of playback of the first 2 tracks, interchange the reels between left and right turntables and playback the remaining 2 tracks.

#### PLAYBACK OF 4-TRACK MONOPHONIC TAPES

In this mode only one of the Front audio channels will be operated at a time. Normal playback sequence for monophonic tapes is, track 1, 4, 3 and finally 2. In this operation only the Front amplifier is used and only the upper control settings of the 2340/3340 will be operated. PLAY switch must be in the 2 CHAN position.

Track 1 will be played first, the L-1 OUTPUT control will be advanced, the R-3 OUTPUT knob will be fully counterclockwise. Upon completion of track 1 the reels are interchanged between left and right turntables, the tape started again and playback of track 4 is now accomplished.

When track 4 has been played, reels are again interchanged however at this point the L-1 OUTPUT knob is fully retarded and the R-3 OUTPUT control is set at mid position. Tracks 3 and 2 are played back in the same manner as were tracks 1 and 4 above.

## GENERAL RECORDING INFORMATION

### A NOTE ABOUT 4-CHANNEL STEREO

The 2340/3340 combines the best features of high quality 4-track, 2-channel operation with 4-channel stereo capability. To avoid any confusion between 4-track stereo and 4-channel stereo, remember that conventional tape recordings for home use have been standardized on a 4-track system; wherein the program material in the forward mode (tracks 1 and 3) is different from the program material in the reverse mode (tracks 4 and 2).

Hence 4-track stereo is 2-channel stereo in both the forward and reverse mode.

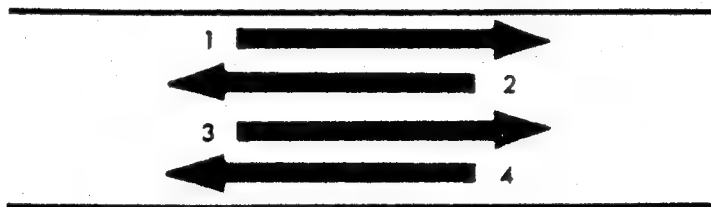

In 4-channel stereo, however, the program material is obtained from all 4 tracks simultaneously.

Hence 4-channel stereo is possible in the forward mode only.



Note: "Channel" refers to a separate, isolated information source, whereas "track" refers to the recorded format on the tape itself. 4-track 2-channel stereo, therefore, requires only one stereo amplifier system and two speakers;



4-channel stereo, on the other hand, requires two stereo amplifier systems and four speakers.

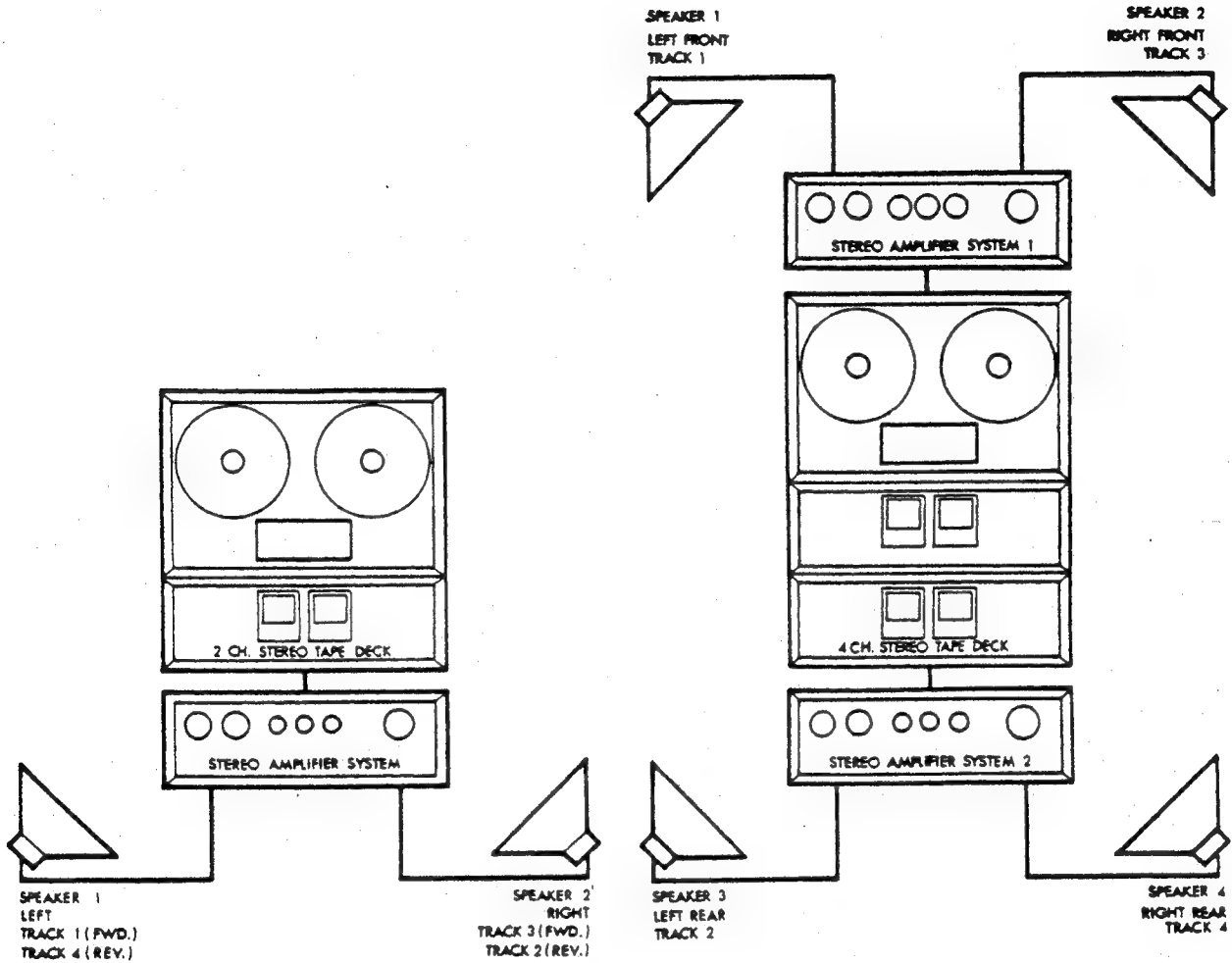

### GENERAL TRACK INFORMATION

Sound recordings are made in a strip on the magnetic surface of a recording tape. This magnetized strip is called the "Track". The full tape width divided by two is called "2" track recording, and the full tape width divided into quarters is called a "4" track recording.

● "2" track recording

2-track recording is mainly employed in radio stations and professional recording studios for stereo recording, in this case both tracks are recorded simultaneously and in the same direction. 2-track recording in the home is usually done one track at a time and is played back monaurally.

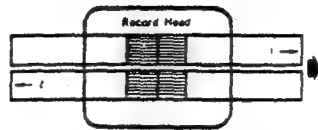

2 Track recording (Monaural)

● "4" track recording (Monophonic)

In this mode, each of the four tracks is recorded individually. At the end of the tape the reels are interchanged between left and right and the next track is recorded. The order in which the tracks are recorded is 1, 4, 3 and lastly 2.

Note: With tape threaded on the machine the tracks are numbered 1 through 4, from the top to the bottom, viewed from the base side of the tape.

4-track recording gives maximum playback time however the benefits of stereo reproduction are lost.

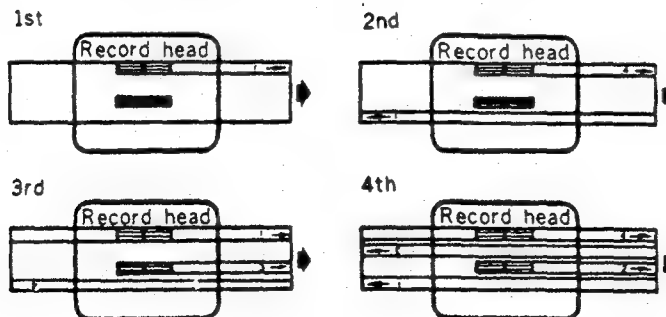

4 Track recording (Monaural)

● "4" track recording (Stereophonic)

In this mode two tracks are recorded simultaneously, on the first pass of the tape, tracks 1 and 3 are recorded. The left and right reels are then interchanged and tracks 2 and 4 are recorded. The left channel sound will be on tracks 1 and 4 and

the right channel sound will be on tracks 2 and 3. 4-track recording in stereo will provide the best possible stereophonic reproduction and is the most widely used recording method today.

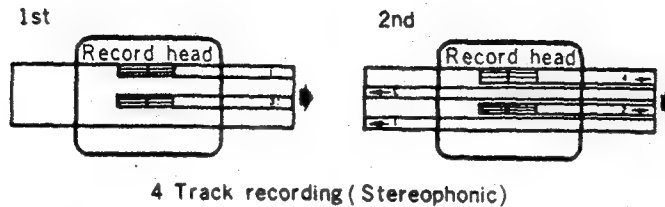

● "4" track recording (4-CHANNEL STEREO)

In this mode all 4 tracks are recorded simultaneously from left to right. Each track contains discrete but synchronized program material. A 4 section playback head is utilized and 4 amplifiers and 4 speaker systems are required. Tracks 1 and 3 are called "Front" left and right respectively, tracks 2 and 4 are called "Rear" left and right. Front and rear correspond to the usual speaker placement in the room relative to the position of the audience. 4-channel playback provides a concert hall realism and presence not available from conventional 2 channel stereo systems. 4-track 4-channel tapes must be played on a player incorporating a 4-track head and four independent playback amplifiers.



● Playback compatibility

A 4-track stereo tape deck can play back both 4-track and 2-track tapes and from the point of compatibility has the widest range of utilization.

When playing a 2-track stereo tape on a 4-track recorder, track 1 will be completely covered by the head, track 2 however will be slightly off alignment but stereo can still be enjoyed by compensating for the slight loss of 2-track volume with the volume or balance controls. On the other hand a 4-track tape cannot be played back on a 2-track (Monophonic) recorder as both tracks 1 and 2 will be reproduced together resulting in mixed unintelligible sound.

## SKILLFUL SETTING OF RECORDING LEVEL

Two important factors are required in a good sound tape. A properly recorded tape should provide a broad frequency response with a minimum of noise and distortion. Although the frequency response is actually determined by the tape deck performance characteristics and quality of the tape used, variation of the recording level has a great affect on the end result.

In order to make a recording with mimimum noise, it is desirable to record at the highest possible level just before distortion is introduced. Even then it is not always necessary to record at the maximum volume level of the music or to maintain the level meter indication at the dividing line between the red and black zone (0 VU). It must be kept in mind that any tape will suddenly increase in distortion, and recording sensitivity of the high notes will slightly decrease when the recording level exceeds a certain point. For this reason, a standard level of 0 dB is established with an ample margin of safety taken into consideration. In actuality, it is best to become fully acquainted with the performance of the tape and the deck you are using before determining the operating level.

Experimentation while using the "monitor" feature will quickly acquaint you with the best recording level for the type tape you are using.

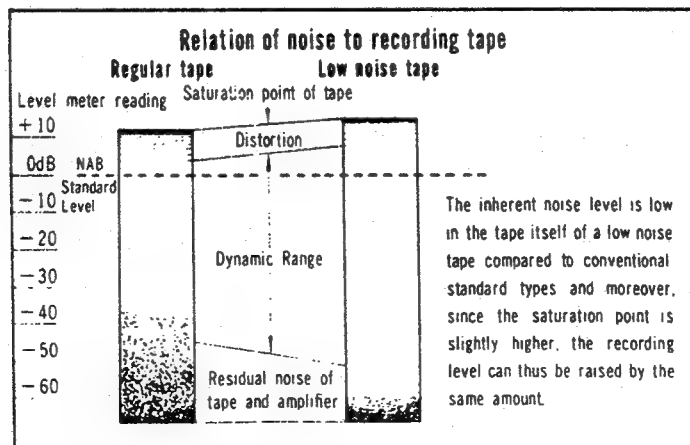

## BIAS SETTING

Record bias is a high frequency (inaudible) signal fed to the erase and record heads while the recording of program material is being accomplished. The RECORD BIAS switch provides two preset levels of the recording bias signal. The newer Low Noise/High Output tapes require a higher bias signal than do conventional tapes. Therefore when recording on high performance tapes such as Scotch 203, BASF LP-35-LH, Sony SLH-550, the RECORD BIAS switch should always be placed in the HIGH position.

When using conventional tape such as Scotch 150, BASF LP-35, Agfa PE-31, Sony S-100 etc. always place the RECORD BIAS switch in the NORMAL position. Failure to properly position the switch will result in a recording of inferior quality, high frequencies may be lost and sound will be unnatural.

Use of the HIGH position when recording high performance tapes will provide all the benefits of the low noise recording concept, wide dynamic range, large output signal, high signal to noise ratio and exceptional clarity of tone.

Bias switch may be in either position during playback as bias oscillator is turned off during playback operation.

## PAUSE CONTROL



The pause control is used while recording, to eliminate unwanted program material such as station breaks, commercials, applause, etc. It stops the recording process while keeping the recording amplifiers and the bias oscillator in the "ready" state. The deck may be placed in the record mode with the tape mode lever in the PAUSE position. The RECORD light will glow red to indicate that you are ready to record, recording will begin as you move the tape mode lever from the PAUSE to the PLAY position. To stop recording momentarily, move the lever back to the PAUSE position.

## RECORDING OPERATION

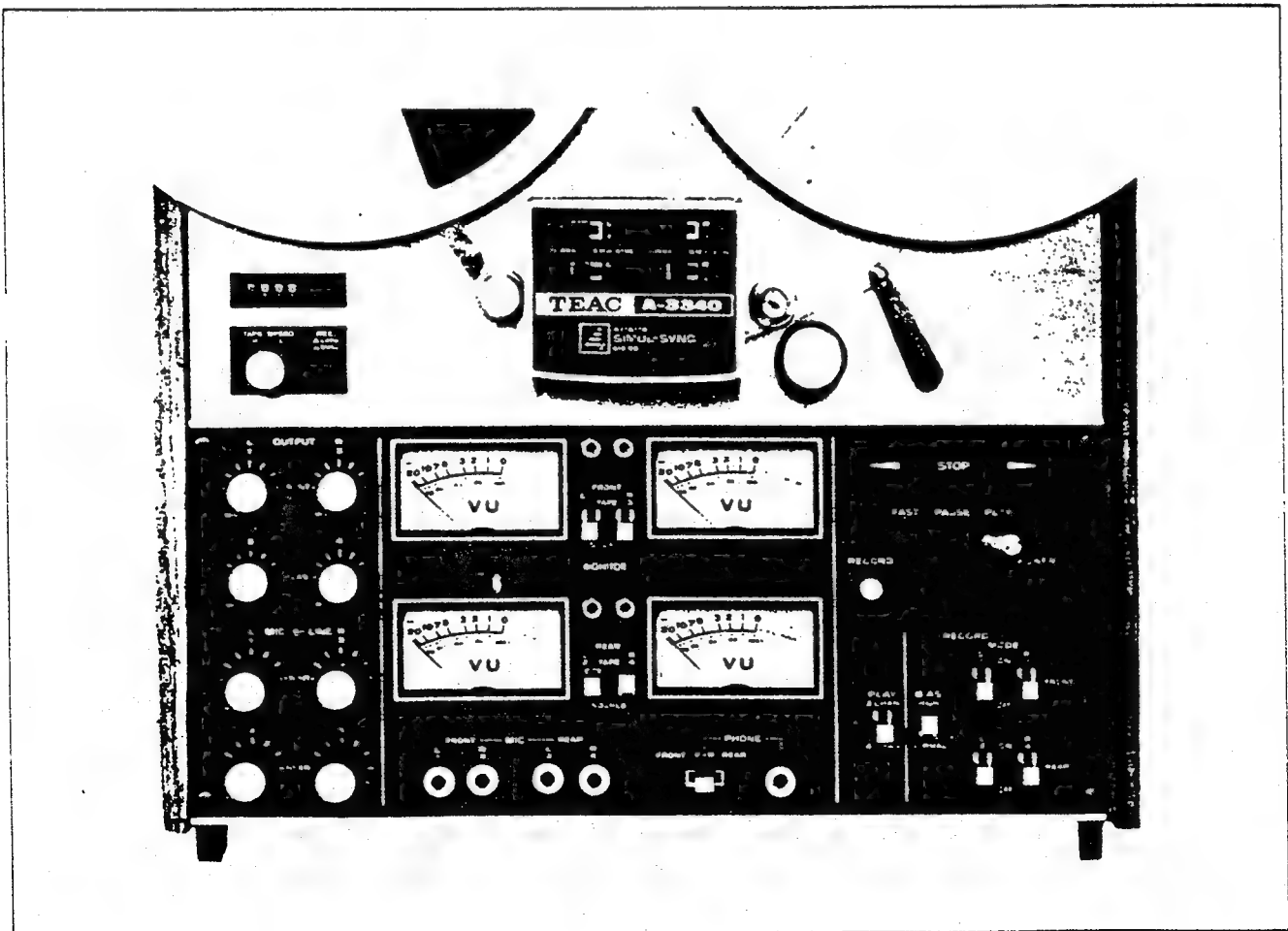
1. The 2340/3340 is capable of monophonic, 2-channel stereo and 4-channel stereo recording.
2. Recordings may be made from a tuner, record player, another tape deck, or from a live source.
3. When recording from a stereo tuner or record player attach the appropriate output connections on the tuner/receiver to the corresponding LINE IN jacks on the 2340/3340. Place the MONITOR switch to SOURCE and note that the recording level may be adjusted by the controls marked LINE. Note also that the input signal will be displayed on the VU meters.
4. When recording with microphones, use the input jacks marked MIC and regulate the volume with the corresponding control. If you wish to monitor the material, remember that live speakers in proximity to an open mike will cause feedback; thus headphones are ideal for microphone monitoring.



#### 4-TRACK 4-CHANNEL STEREO RECORDING

1. THREAD A BLANK TAPE ON DECK, FULL REEL ON LEFT TURNTABLE.
2. SET TAPE SPEED KNOB TO DESIRED SPEED, INDEX COUNTER TO ZERO.
3. PLACE ALL 4 SIMUL-SYNC SWITCHES IN NORMAL POSITION.
4. PLACE ALL 4 MONITOR SWITCHES IN SOURCE POSITION.
5. PLACE ALL 4 RECORD MODE SWITCHES TO ON POSITION.
6. POSITION THE BIAS SWITCH TO THE PROPER POSITION FOR THE TYPE TAPE TO BE RECORDED.  
HIGH: FOR LOW NOISE/HIGH OUTPUT TAPES SUCH AS SCOTCH 203 OR BASF LP-35LH.  
NORMAL: FOR CONVENTIONAL TAPES SUC AS SCOTCH 150 OR EQUIVALENT.
7. CONNECT THE RECORDING SOURCE TO EITHER THE LINE IN OR FRONT-MIC-REAR JACKS. MIC/LINE MIXING MAY BE READILY ACCOMPLISHED WITH THE 2340/3340. WITH A SOURCE OF INSTRUMENTAL MUSIC FED TO THE LINE IN JACKS AN 4 MICROPHONES CONNECTED TO THE FRONT PANEL MICROPHONE JACKS, THE RESULTANT SOUND MIX CAN BE CONTROLLED BY THE INDIVIDUAL MIC/LINE INPUT LEVEL CONTROLS AND MAY BE READILY MONITORED WITH HEADPHONES.  
WHEN RECORDING FROM MICROPHONES MONITORED OF THE RECORDED SOUND IS BEST ACCOMPLISHED BY USE OF HEADPHONES. WHILE IT IS POSSIBLE TO MONITOR THROUGH SPEAKERS POWERED BY THE FRONT AN REAR AMPLIFIERS, CLOSE PROXIMITY TO THE MICROPHONES WILL RESULT IN FEEDBACK AND/OR HOWLING.
8. PLACE TAPE MODE LEVER AT PAUSE POSITION. SIMULTANOUSLY PRESS THE RECORD AND  BUTTONS. DECK IS NOW IN RECORD MODE, ALL RECORD INDICATOR LIGHTS (CENTERED ABOVE THE VU METERS) SHOULD ILLUMINATE. RECORDING SIGNAL WILL BE DISPLAYED ON THE VU METERS.
9. WHILE MONITORING THE SOURCE SIGNAL WITH HEADPHONES, ADJUST THE MIC OR LINE INPUT LEVEL CONTROLS SO THAT THE SIGNAL PEAKS ARE AT OR NEAR THE 0 VU POINT ON EACH METER.
10. TAPE MOVEMENT (AND REOCORDING) WILL BEGIN WHEN TAPE MODE LEVER IS MOVED FROM PAUSE TO PLAY POSITION. RECORDING MAY MOMENTARILY INTERRUPTED BY PLACING TAPE MODE LEVER IN THE PAUSE POSTITION.  
TO CEASE RECORDING AND DISENGAGE THE RECORD MODE SIMPLY PRESS THE STOP BUTTON. THE RECORD LIGHTS WILL EXTINGUISH AND THE TAPE WILL HALT.  
TO RESUME RECORDING, PLACE TAPE MODE LEVER AT PAUSE ONCE AGAIN PRESS THE RECORD AND  BUTTONS, RECORD LIGHTS WILL ALLUMINATE AND YOU ARE IN THE RECORDING MODE, MOVING THE LEVER TO PLAY POSITION WILL CAUSE THE TAPE TO MOVE.

THE RECORDING SOURCE MAY BE COMPARED WITH THE ACTUAL RECORDING BY MOVING THE MONITOR SWITCH FROM THE SOURCE TO THE TAPE POSITION. YOU WILL NOTE A SLIGHT TIME DIFFERENCE AS IN THE TAPE POSITION THE MONITORED SIGNAL IS BEING TAKEN FROM THE PLAYBACK HEAD A MOMENT AFTER BEING RECORDED.

THE PHONE SWITCH ALLOWS YOU TO MONITOR EITHER THE FRONT 2 TRACKS, THE REAR 2 TRACKS OR A COMBINATION OF ALL 4 TRACKS (F \* R).

#### 4 TRACKS, 2 CHANNEL STEREOPHONIC RECORDING

STEREOPHONIC RECORDING IS ACCOMPLISHED IN THE SAME MANNER AS 4-CHANNEL STEREO RECORDING WITH THE FOLLOWING EXCEPTIONS.

ONLY THE L-1, R-3 CONTROLS WILL BE UTILIZED TO SET RECORDING OR PLAYBACK LEVELS.

L-2 AND R-4 CONTROLS SHOULD BE FULLY COUNTERCLOCKWISE.

RECORD MODE SWITCHES, L-1 AND R-3 ARE ON, L-2 AND R-4 MUST BE OFF.

PHONE SWITCH SHOULD BE IN FRONT POSITION.

PLAY SWITCH SHOULD BE IN 2 CHAN POSITION.

ONLY THE L-1, R-3 MIC/LINE JACKS ARE USED.

UPPER VU METERS WILL ILLUMINATE AND INDICATE, LOWER METERS ARE NOT USED.

WHEN THE FIRST 2 TRACKS (1 AND 3) HAVE BEEN RECORDED, STOP THE TAPE, INTERCHANGE THE REELS BETWEEN LEFT AND RIGHT AND PROCEED TO RECORD THE REMAINING 2 TRACKS (2 AND 4).

#### MONOPHONIC RECORDING

ANY TRACK MAY BE RECORDED INDEPENDENTLY WITH THE 2340/3340 BY USING ONLY THE CONTROLS APPLICABLE TO THAT TRACK AND DISABLING OR RETARDING THOSE THAT APPLY TO THE REMAINING 3 TRACKS. TRACKS MAY BE RECORDED IN ANY ORDER AND IN EITHER DIRECTION BY SIMPLY INTERCHANGING THE REELS BETWEEN THE LEFT AND RIGHT TURNTABLE.

IF THE TAPE IS TO BE USED ON A CONVENTIONAL 4-TRACK 2-CHANNEL MACHINE IT SHOULD BE RECORDED IN THE NORMAL SEQUENCE, THAT IS TRACKS 1, 4, 3 AND 2. BY SO DOING COMPATIBILITY IS MAINTAINED

WITH THOSE MACHINES NOT POSSESSING THE COMPLETE FLEXIBILITY OF THE 2340/3340.



## SIMUL-SYNC RECORDING

This is a recording technique wherein discrete, synchronized program material may be recorded independently on all 4 tracks. For instance, rhythm section may be recorded on track 1, brass section on track 3, vocals on track 2 and or 4. The resultant 4 synchronized tracks may be reproduced on a conventional 4 channel playback system with the sound mix readily controlled by the independent level controls. This feature has unlimited applications, an instrumental background may be placed on one track, a vocalist may add the voice selections at a later time, perfectly synchronized through the use of the SIMUL-SYNC feature.

SIMUL-SYNC, in simple terms, allows you to play back and monitor one track without time delay while recording a second, third or fourth track in perfect synchronization, any recorded track may be monitored and the remaining 3 tracks synchronized with it. The head function selector switches provide this feature by changing the function of the record head to playback when the switch is placed in the SIMUL-SYNC position, thereby eliminating the time delay which occurs during normal tape monitoring on conventional machines.

This feature permits maximum flexibility in the production of special effects tapes. Each track may be recorded independently and the resultant sound mix played back and re-recorded on a master tape using a second deck. With 8 individual input controls, MIC/LINE mixing can be accomplished on each track. Individual output controls for each track permit the final recording to be blended with each tracks output at the optimum level. In actuality the 2340/3340 functions as a complete recording console without the necessity of complex auxiliary equipment.

1. Make a monophonic recording of the basic program material on track 1. This will serve as the basic reference track for all additional recorded material. Make certain the L1 head switch is in the NORMAL position while recording.
2. With tape stopped, retard the L1 OUTPUT, place L1 MONITOR switch in TAPE position. Slide the L1 head function selector switch to SIMUL-SYNC position.

**CAUTION:** To prevent the recording of switch noise, NEVER CHANGE the position of the head function selector switches WHILE A RECORDING IS BEING MADE.

3. The track 1 recording material may now be monitored with headphones, move PHONE switch to FRONT position and regulate headphone volume with the L1 OUTPUT control. Since the L1 recording head is now being utilized as a playback monitor source, the signal level at the amplifier headphone jack will be small. If a greater level is desired plug the headphones into the front power amplifier monitor jacks and regulate the playback volume with the power amplifier volume control.
4. Rewind the tape to the starting position and make a recording on track 3 while monitoring the recorded material from track 1.

**CAUTION:** Use only the R3 RECORD MODE switch (ON position). Remember to move the L1 RECORD MODE switch to the OFF position before recording track 3.

### Normal Stereo Recording

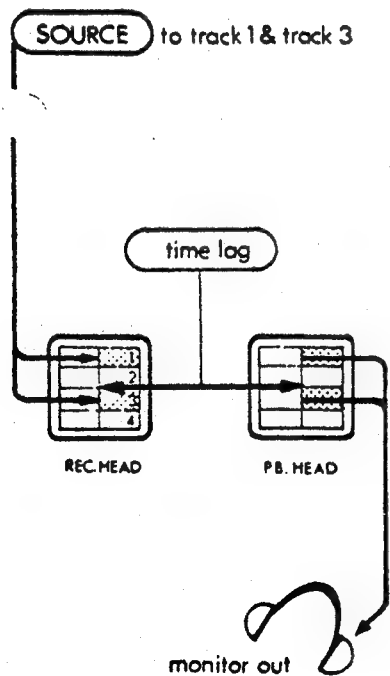

### Simul-Sync Recording

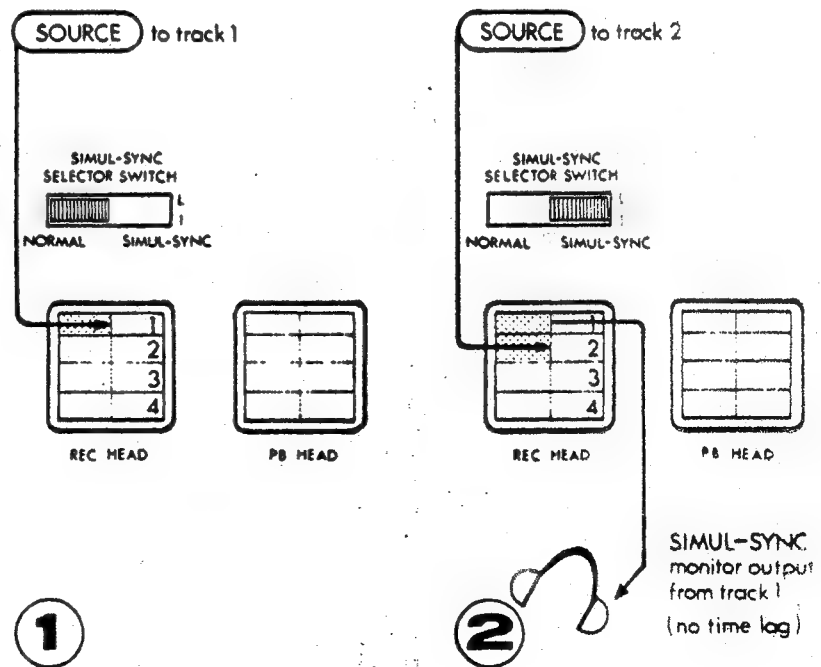

5. At this time you have synchronous but discrete program material on tracks 1 and 3 since the displacement between record and playback head is no longer a factor to be considered.
6. The remaining two tracks may be recorded simultaneously or independently and may be synchronized to track 1 or 3 as desired merely by selecting the track to be monitored. This is accomplished by selecting the SIMUL-SYNC position for the track to be monitored. Tracks 1 and 3 may be monitored simultaneously by placing the L1, R3 head function selector switches to the SIMUL-SYNC position.
7. Since all 4 MONITOR switches remain in the SOURCE position, all 4 tracks should be recorded at the optimum reference level. That is with the VU meter indications centered at or around the 0 VU point on the VU meter scale.
8. You now have discrete, synchronized program material on all four tracks, obviously therefore they may be played back simultaneously. The sound mix or blending is accomplished during the playback mode.
9. Any or all of the independent tracks may be erased and re-recorded as they can be easily synchronized to any remaining track by use of the appropriate head function selector switch.
10. During playback, all head function selector switches should be in the NORMAL position.

**CAUTION:** Again, to prevent the recording of switch noise, never change the position of the head function selector switches while a recording is being made. Retard the OUTPUT level control for the head or channel being switched before changing switch position. Do not change switch position while tape is in motion (recording or playback mode).

## MAINTENANCE

To insure continued top-performance operation, check with your nearest authorized service representative once a year for scheduled maintenance and lubrication. Because of the precision mechanics of your TEAC tape deck, disassembly by anyone other than an authorized service representative is not recommended.

### CLEANING

To prevent the loss of high frequency response and inadequate erasure, the heads should be cleaned frequently (after each eight to ten hours of use).

Use TEAC TZ-261A Head Cleaner, or a lintfree cloth moistened with alcohol, and carefully wipe the face of each head to remove all traces of dirt and magnetic oxide deposits.

Note: Use TEAC TZ-261B Rubber Cleaner for cleaning the rubber pinch roller; use TEAC TZ-252B for cleaning the panel and cabinet case.

### DEMAGNETIZATION

To maintain the best performance of your equipment, and to prevent gradual deterioration of your pre-recorded tapes, demagnetize the tape heads at least after every 50 hours of operation. (The serious recordist will demagnetize before each recording session.)

1. Turn the equipment off.
2. Attach the protective covering on the tip of TEAC model E-1 Head Demagnetizer, and energize the unit away from the immediate area of the tape deck.
3. Place the tip of the demagnetizer against the upper pole pieces of the tape head, and slowly move the tip downward toward the lower pieces. Alternate between the two pole pieces while slowly withdrawing the demagnetizer from the tape head.
4. Repeat this process on each head.
5. Turn off the demagnetizer out of the immediate area of the tape deck.

Note: Do not allow the demagnetizer to come too close to the level indicator meter; permanent damage may result.

## ERASING

The erase head of a given track is always energized during the record mode, in order to assure clean recordings; whatever noise or sound may have previously existed on that track is erased immediately before the new program material is recorded.

To erase a tape without recording new material, simply turn MIC and LINE controls to the minimum position, and operate the equipment for recording. (Remember that erasing, like recording, can be accomplished in the forward mode only.)

In the event that the entire tape is to be erased, a bulk eraser is the most efficient means.

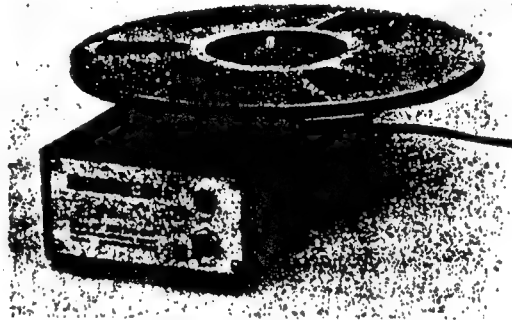

## MAKING SPLICES

1. Overlap the two ends of the tape and cut them approximately at a 60 degree angle. Align both ends with the back side up.

2. Cover the aligned ends with splicing tape, and press firmly.

Note: Never use conventional adhesive tape for splicing. Scotch Brand Splicing Tape is recommended.

3. Trim excess splicing tape, cutting slightly into the recording tape - this will eliminate the possibility of adhesive transfer to the tape heads and to the tape itself.

Note: It is advisable to demagnetize scissors with a bulk eraser when splicing recorded tapes.

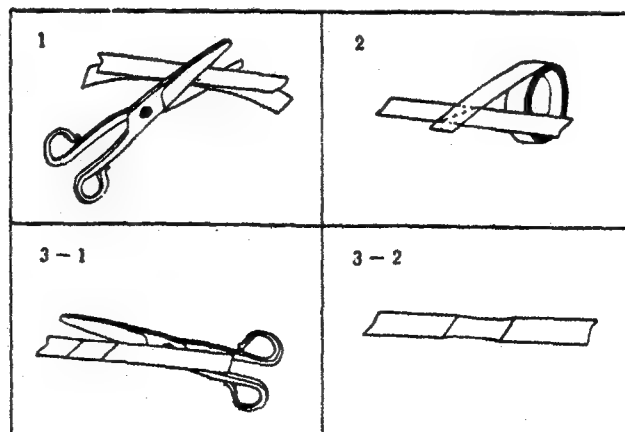

## OPTIONAL ACCESSORIES

### MC-201 Electret Condenser Microphone

Impedance : 10k ohms or 600 ohms  
Output : -48 dB (600 ohms)  
Frequency response : 50-15,000 Hz



### HP-101 Moving Coil Type Stereo Headphones

Impedance : 8 ohms  
Input sensitivity : 1 mW  
Maximum power : 500 mW  
Frequency response : 18-20,000 Hz



### AX-10 Sound-on-Sound and Stereo Echo Unit



### E-1 Head Demagnetizer

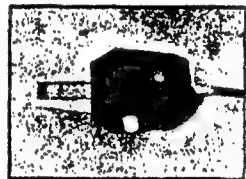

### E-2 Bulk Eraser

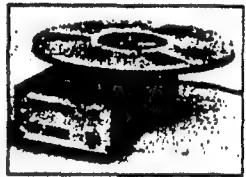

### RE-701 7" Plastic Reel, Large Hub

### RE-702 7" Plastic Reel, Small Hub

### RE-711 7" Metal Reel, Small Hub



### RE-1002 10-1/2" Metal Reel



### TZ-251A/TZ-251B Cleaner

TZ-251A Liquid Head Cleaner

TZ-251B Liquid Rubber Cleaner



ds	Three, 4 track-4 channel and 2 channel, stereo or mono (with SIMUL-SYNC switch) erase, record and playback
l Size	7" and 5"
e Speed	7-1/2 ips and 3-3/4 ips ( $\pm 0.5\%$ )
ors	1 dual speed hysteresis synchronous capstan motor 2 eddy current induction reel motors
and Flutter	0.08% at 7-1/2 ips 0.10% at 3-3/4 ips
quency Response	30 - 22,000 Hz ( $\pm 3$ dB, 40 - 18,000 Hz) at 7-1/2 ips 30 - 16,000 Hz ( $\pm 3$ dB, 40 - 10,000 Hz) at 3-3/4 ips
nal to Noise Ratio	55 dB
monic Distortion	1% at 1,000 Hz normal operating level
sstalk	60 dB at 1,000 Hz
ereo Channel Separation	50 dB at 1,000 Hz
t Winding Time	90 seconds for 1,200 feet
uts	Microphone: 0.25 mV/ -72 dB (600 - 10,000 ohms)
	Line : 0.1 V, 50,000 ohms or more
puts	Line : 0.3 V for load impedance of 10,000 ohms or more
	Headphones: 8 ohms
er Requirements	100/117/200/220/240 V AC, 50/60 Hz, 140 W
er ons	18-3/4"(H) x 17-5/16"(W) x 8-3/4"(D) [ 475(H) x 440(W) x 220(D)mm]
ght	46-1/4 lbs, [21 kg] net
andard Accessories	Empty reel, Input-output connection cord, Oil, Fuse, Cleaning stick, Silicone cloth, Rubber feet, AC power cord, Vinyl cover, Splicing tape

ifications were determined using low noise tape.

tures and specifications subject to change without notice.





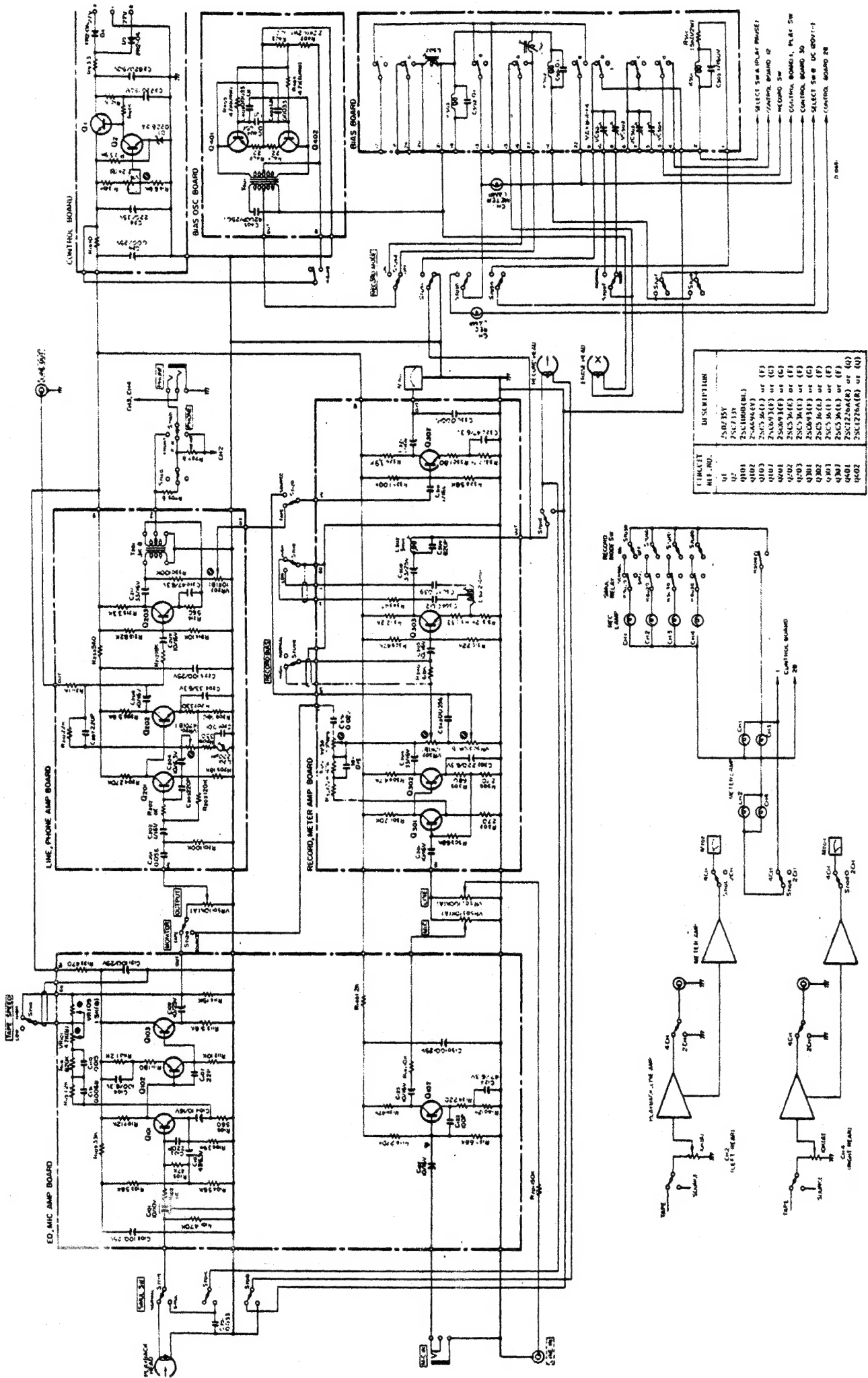

TEAC A-3340 SCHEMATIC DIAGRAM  
AMPLIFIER SECTION

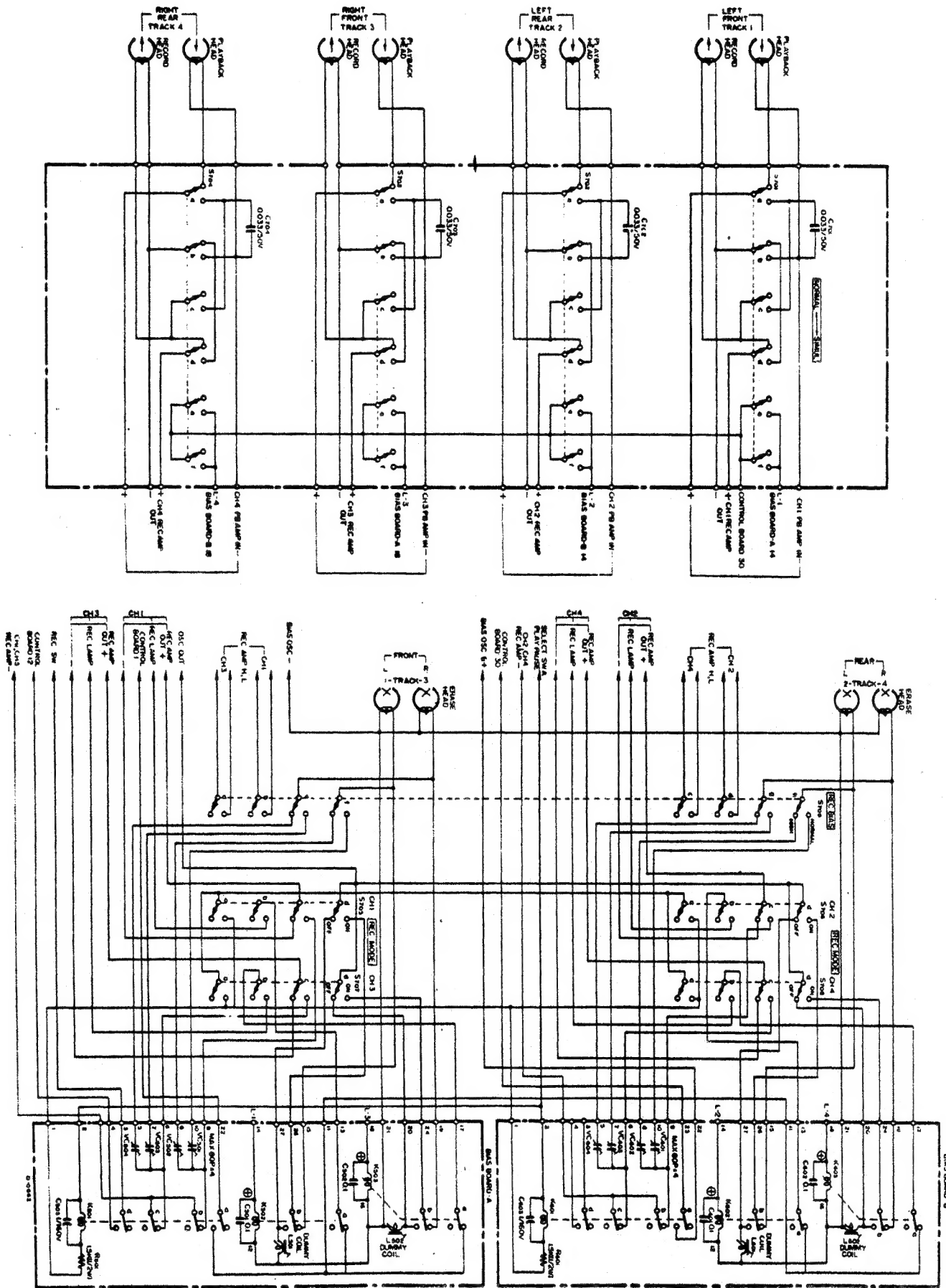

TEAC A-2340/A-3340 SCHEMATIC DIAGRAM  
 HEAD ASSEMBLY SECTION