

# S.M.S.L



## SD-9



## 产品说明书 | USER MANUAL

本说明书的内容可能会随版本更改, 如有变动, 恕不另行通知

The contents of this manual may be changed with the edition,  
and are subject to change without notice.

Ver 1.0

## 目录

安全注意事项/保修条款.....	01
产品特点.....	02
技术参数.....	03-04
媒体技术支持表.....	05
关于遥控器的使用.....	06
部件介绍.....	07
连接示意图.....	08-10
操作介绍.....	11-13
播放设置.....	14
系统设置.....	15-17
网络设置.....	18-19
正在播放.....	20
音乐库.....	21
音乐源.....	22-27
HiBy Link海贝连接.....	28
关于MQA.....	29

**contents**

Safety Notes/Warranty Terms.....	30
Features.....	31
Specifications.....	32-33
Formats.....	34
Remote control.....	35
Parts names and functions.....	36
Connecting your equipment.....	37-39
Operation introduction.....	40-42
Play settings.....	45
System Settings.....	44-46
Network Settings.....	47-48
Now playing.....	49
Music library.....	50
Music source.....	51-56
HiBy Link.....	57
About MQA.....	58

## 安全注意事项

- 请将本音响系统安装在通风良好、阴凉、干燥、干净的位置，远离直射阳光热源、振动、灰尘、潮湿或寒冷。
- 只能使用本机指定的电压。使用高于指定数值的电压很危险，而且可能导致火灾，损坏本机或造成人身伤害。对于使用高于指定电压造成的任何损害，我司将不负任何责任。
- 不要试图自行改造或修理本机。如果需要任何服务，请与销售或者我司客服人员联系。不管有任何理由，都没有打开机壳的必要。
- 如果打算长时间不使用本机（比如度假时），请从墙壁交流电源插座上断开电源线的连接。

### 重要提示：

本说明书所提到的产品规格和资讯仅供参考。如有内容更新，恕不另行通知。

## 保修条款

### 一、服务期限

佛山双木三林科技有限公司承诺产品的良好品质，产品自售出之后7天内正常使用情况下出现故障，客户可以选择退货或者保修（不影响二次销售才可退货）。正常使用一年内出现故障可以免费保修。

二、购买日期以销售商开出的购机发票或收据日期为准，网购可以交易截图为准。

### 三、有以下情况都不能享受“三包”服务

1. 一切人为因素损坏，包括非正常工作环境下使用或不按照说明书使用。
2. 用户私自拆机、改装、维修。
3. 使用非指定或许可的配件造成损坏的。
4. 机身的QC或保修贴损毁。
5. 不能出示有效购机凭证。
6. 不属于本公司产品。

### 四、保修方式为送修

此条款只适于中国大陆，其它地区请参考当地销售代理商的规定和国家法规。

## 产品特点

- 全格式播放,支持MQA、DSD、WAV、APE、FLAC、AIFF、MP3等;
- 全数字接口:USB、光纤、同轴、I2S、AES/EBU、蓝牙;
- 支持流媒体播放,包括DLNA和AirPlay;
- 支持USB硬盘,最大4TB容量,支持NTFS/FAT32文件系统;
- 支持HiBy Link,您可以使用手机APP对其进行控制;
- 支持有线或WIFI网络连接,支持2.4GHz和5GHz WIFI;
- 蓝牙支持发射和接收功能;
- USB DAC接收器,可连接电脑播放音乐;
- USB DAC发射器,可连接USB DAC(如SU-9)播放音乐;
- USB DAC/I2S 输出最高支持 PCM32bit/384kHz 和 DSD256;
- 通过HDMI物理接口的I2S LVDS电平输出;
- SPDIF接口支持DOP和D2P输出;
- 全新设计的UI,操作更简单;
- 内置高效率、低噪声开关电源;
- 钢化玻璃顶盖,美观大方!

## 温馨提示

固件及驱动下载:

<https://smsl-audio.com/>

## 技术参数

### 输入方式:

USB(A型) x2, USB(B型), micro SD卡, 蓝牙

### 输出方式:

光纤, 同轴, AES/EBU, 蓝牙, I2S(HDMI), USB(A型)

### 音频部分:

USB Audio

PCM

44.1kHz ~ 384kHz

DSD

DSD64~DSD256

USB Audio系统兼容性

Windows 7/8/8.1/10/11, Mac OS X, Linux

DSD D2P(DSD转PCM)

转换为 PCM 88.2kHz

DSD over PCM(DoP)

DoP64, DoP128

SPDIF DoP

DoP64

### USB部分:

版本

USB2.0高速

USB 最大输出电流

2A(为两个 USB 输出电流总和)

USB (B型)

DAC/拷贝音乐

文件系统

FAT/FAT32/NTFS

micro SD卡容量

最高支持 256GB容量

USB (U盘/硬盘)

最高支持 4TB容量

## 技术参数

### 蓝牙部分：

蓝牙版本	4.0
HiBy Link	支持
规格	
输出支持	SBC /AACPTX/LDAC /UAT
输入支持	SBC /AAC /LDAC /UAT
输入优先选择顺序	UAT → LDAC → AAC → SBC
输出优先选择顺序	UAT → LDAC → APTX → AAC → SBC

### 网络部分：

WIFI	2.4GHz/5GHz(共用天线)
网口规格	100Mb/s

### 其他

语言	中文, 英文
软件升级	Micro SD
功率消耗	20W
待机功率	<0.5W
尺寸	187.5 x 154 x 40 (mm)
重量	760g / 1.67 lbs

## 媒体技术支持表

格式	是否支持	条件	采样率(Hz)		位数	CUE	备注
			最低	最高			
APE	支持	FAST	8k	384k	16-24bit	支持	
	支持	Normal	8k	384k	16-24bit	支持	
	支持	High	8k	384k	16-24bit		
	支持	Extra high	8k	96k	16-24bit		176/192K 不支持
	不支持	Insane	8k				
WAV	支持		8k	384k	16-32bit	支持	DTS 编码不支持
WMA	支持		8k	96k	16-24bit		
WMALOSSLESS	支持		8k	96k	16-24bit		
FLAC	支持		8k	384k	16-24bit	支持	
DSF	支持		2.8M	11.2M	1bit		
DFF	支持		2.8M	11.2M	1bit		
ISO DSD	支持		2.8M	2.8M			
ISO DST	不支持						
AIFF	支持		8k	384k	16-32bit		
M4A	支持		8k	384k	16-24bit		
MP2	支持		8k	48k	16bit		
MP3	支持		8k	48k	16bit	支持	
AAC	支持		8k	48k	16bit		
OGG	支持		8k	48k	16bit		

注:

1. 此处标记是采样率不是文件码率。
2. Ape:32-192kHz 的 Insane 文件不支持。  
176.4kHz,192kHz 的 Extra high 文件不支持。
3. ISO8 的文件不支持。
4. 所有64k文件不支持。



## 关于遥控器的使用

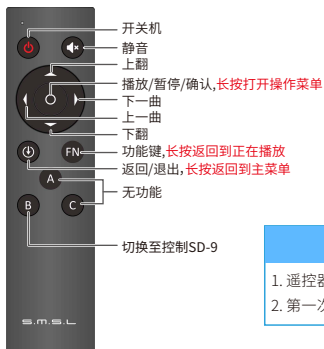

### 注意

1. 遥控器请使用2节7号(AAA)电池
2. 第一次操作SD-9时, 先按B键

在当前歌曲播放时间超过10秒, 按遥控器“向左”键, 播放从新开始播放当前歌曲, 未超过10秒, 播放上一曲。



## 部件介绍

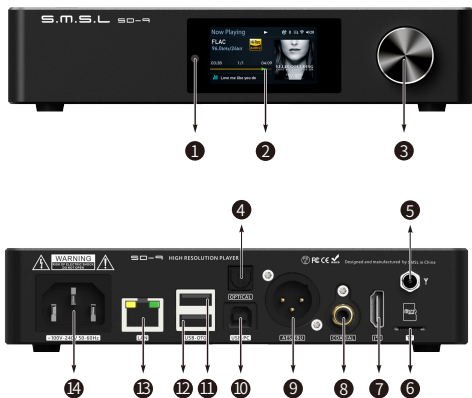

- |              |                       |              |
|--------------|-----------------------|--------------|
| 1 红外接收窗      | 2 显示屏                 | 3 旋钮         |
| 4 光纤输出       | 5 2.4G/5G双频天线         | 6 micro SD卡槽 |
| 7 I2S输出接口    | 8 同轴输出                | 9 AES输出      |
| 10 USB(B型)输入 | 11 OTG_1              | 12 OTG_2     |
| 13 网线接口      | 14 电源AC输入(100-240VAC) |              |

## 连接示意图

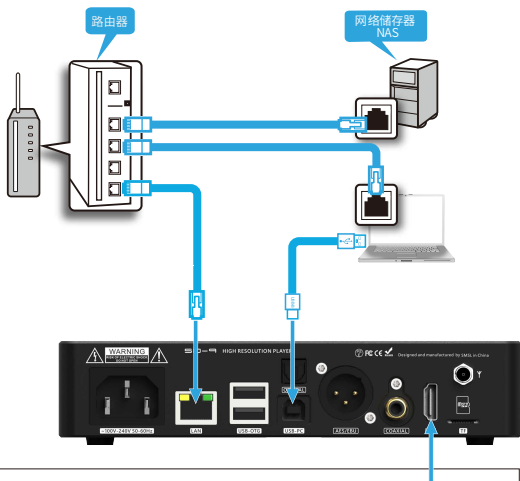

## I2S接口引脚定义

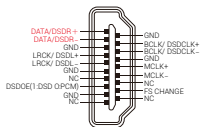

I2S 普通

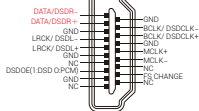

I2S 反相

## 连接示意图

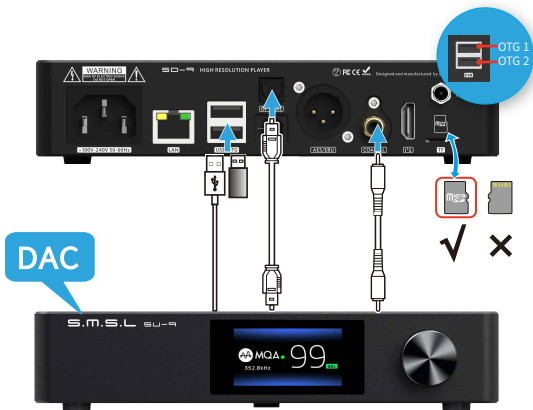

■ 两个USB A接口使用说明：

1. 用作USB硬盘输入时，上接口为OTG\_1，下接口为OTG\_2。

**注意：**两个USB输出电流总和不超过2A。

2. 其中1个用作USB输出，连接USB DAC时，显示“音频设备连接”，同时从这个USB接口输出数字信号，SD-9的其它输出无声。拔出时，显示“音频设备断开”，恢复原来输出。

**注意：**可能由于USB匹配问题，USB DAC不能连接成功



## 连接示意图

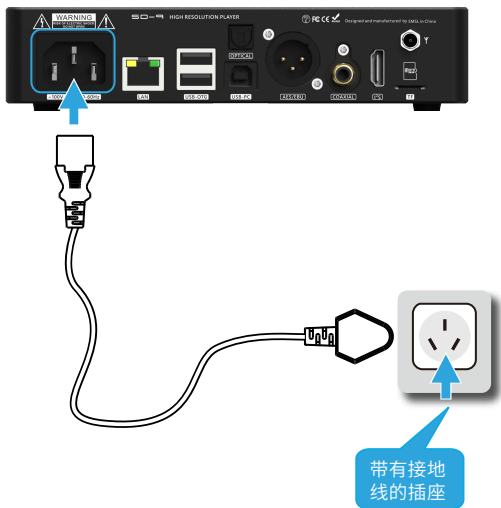

注意：请使用带接地线良好的电源插座，以确保安全及避免噪声。

## 操作介绍

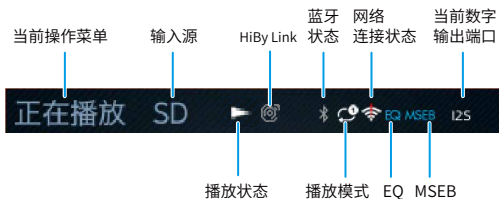

正在播放



音乐库



音乐源



播放设置



系统设置



网络设置

## 操作介绍

当初次使用时,请注意:

1. 遥控器在初次使用前先按"B"键,因为SMSL采用的是统一遥控的理念,可以用一个遥控器控制一整套SMSL的设备!

它们是:

- A: 功率放大器
- B: 播放器/耳机放大器
- C: 解码器

2. SD-9的电源状态是具备记忆功能的。
  - 不使用按键关机,直接拔掉电源线,下次插电会直接开机;
  - 长按旋钮/遥控关机后,下次插电不会直接开机。

## 旋钮功能介绍

单击	播放状态下:播放/暂停
	其它状态下:确认/进入
双击	返回/退出
长按	开、关机
右旋	下一个
左旋	上一个

## 操作介绍

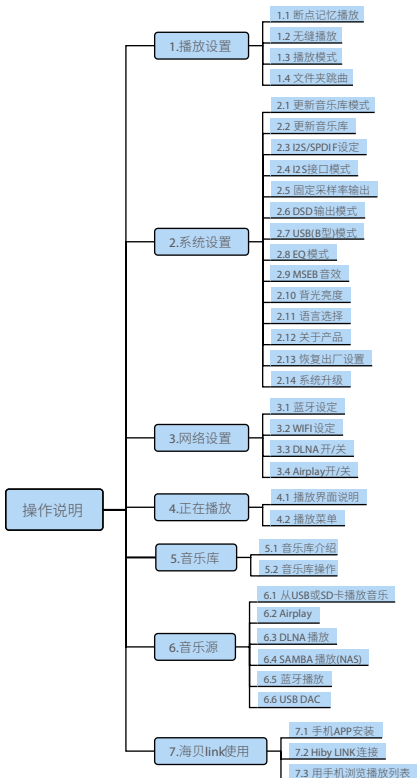



## 播放设置

首次使用,请先进行播放设置,以符合个人的使用习惯。

转动旋钮至“播放设置”,单击进入,分别设置“断点记忆播放”、“无缝播放”、“播放模式”、“文件夹跳曲”等。设置完成后双击退回首页。

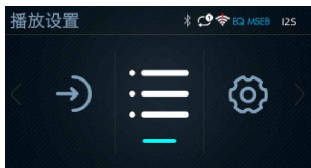

### 1.1 断点记忆播放:

“关闭”下一次开机不会播放上一次关机前的曲目。

“曲目”下一次开机自动显示上一次关机前的曲目。

“位置”下一次开机自动跳到上一次关机前曲目播放位置。



1.2 无缝播放:同采样率的歌曲切换没有停顿。

1.3 播放模式:1、列表播放 2、单曲循环 3、随机播放 4、列表循环。

1.4 文件夹跳曲:切换歌曲是可跳转到不同文件内的歌曲。

## 系统设置

首次使用, 请先进行系统设置, 以符合个人的使用习惯。



### 2.1 更新音乐库模式:

单击选择手动、自动。(注:此功能仅对 micro SD卡有效。)

### 2.2 更新音乐库:

扫描连接上的SD卡, OTG USB设备中的音乐到播放列表。

### 2.3 I2S/SPDIF:

选择输出是I2S或者SPDIF(光纤、同轴、AES/EBU)

### 2.4 I2S 反相:

I2S模式选择, 打开为反相模式。

### 2.5 固定采样率输出:

使输出的数字音频固定在所设定的频率, 这个设定可以帮助一些较旧的DAC正常接收高规格音频。

### 2.6 DSD输出模式

**D2P(DSD to PCM):** 将DSD信号转换成PCM输出, 当连接的DAC不支持DSD时使用, 系统默认转换成88.2kHz的采样率。

**DoP(DSD over PCM):** 将DSD信号封装成PCM, 达到使用光纤, 同轴, AES/EBU来传输DSD音频的目的, 最高支持到DoP64。

**DSD Native:** 直接DSD数据传输, 这个设置只支持使用I2S和USB音频输出接口。

## 系统设置

### 2.7 USB B口模式:

- 此设置只针对B型USB输入。
- DAC模式时,为USB DAC;
- USB模式时,用于连接电脑传输音乐。

### 2.8 EQ模式:打开或者关闭。

- EQ只能在采样率为44.1kHz, 48kHz时有效。
- 共8种预设EQ和1种自定义EQ;
- 自定义,共10段EQ (31Hz、62Hz、125Hz、250Hz、500Hz、1kHz、2kHz、4kHz、8kHz、16kHz), 调节范围是 $\pm 12$ dB。



### 2.9 MSEB(Magic Sound 8-ball) :

MSEB创新性的利用DSP对音频的成分进行量化, 然后从听感角度出发去调整音频效果!

- MSEB 生效范围是96kHz及其以下采样率的音频文件。
- 音效设置项总共包含10项,分别为:  
总温度、低音下潜度、低音弹性、厚度、人声、女毒、齿音低频、齿音高频、乐器瞬态、空气声。

## 系统设置

2.10 背光亮度:亮度调节分5级。

2.11 语言选择:简体中文、繁體中文、English。

2.12 关于产品:型号、外置内存、可用容量、蓝牙地址、固件版本

2.13 恢复出厂设定:重置机器所有选项设定,恢复到出厂设定。

2.14 系统升级:把升级固件下载到micro SD卡内,插入机器点击系统升级。

## 网络设置

单击进入设置界面。

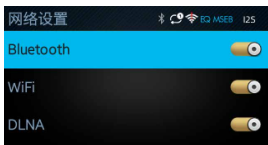

### 3.1 Bluetooth



3.1.1 蓝牙打开或关闭;

3.1.2 蓝牙设备名字:SD-9(xxxx), 这个"xxxx"用于识别单独每个不同的单元, 当你里有多于个SD-9时, 可以方便地识别它们。SD-9的蓝牙接收是一直打开的, 可以使用手机搜索并连接这个设备, 用手机控制或者传输音频到SD-9。

3.1.3 HiBy Link: 海贝连接打开或关闭, 此时SD-9的蓝牙输入功能切换为控制, 而不是音频。

- SD-9可以连接海贝(Hiby)APP, 装有海贝APP的手机来操作SD-9的播放列表。
- 如果要使用蓝牙来输入音频, 务必关掉SD-9的HiBy Link功能。

3.1.4 高音质: 这里可以选择蓝牙音频传输的格式, SD-9的蓝牙:

输入支持:UAT /LDAC /AAC /SBC格式

输出支持:UAT /LDAC /APT X /AAC /SBC

其中的优先顺序也是按照这个顺序的, 例如选项的是UAT格式, 但是如果另一端的设备不支持这个格式, 则系统会自动切换到另一端支持的格式, 如LDAC, 以此类推。

## 网络设置

### 3.1.5 蓝牙搜索：

这里用作蓝牙输出, 搜索与手机的蓝牙搜索类似, 用于连接其它蓝牙设备, 把SD-9播放的音频通过蓝牙输出到蓝牙耳机或者蓝牙音箱。

- 请确保你的蓝牙耳机或者音箱处于配对状态, 然后点击确定进入搜索, 搜索完成后可以在菜单下面找到你的蓝牙耳机或者音箱, 再点击你要连接的设备就可以配对并连接了。
- 蓝牙连接好后, 音频不但可以从蓝牙输出, 原先的输出接口依然有声音输出。

### 3.2 WiFi



#### 3.2.1 WiFi打开或关闭;

**3.2.2 WiFi搜索:** 点击进行搜索, 搜索完成后附近的WiFi都会出现在下面的菜单中, 选择要连接的名字, 并且使用遥控器输入密码。

- 注意: WiFi的名字请不要使用本机键盘不支持的字母或符号, 以免无法正常连接。
- 注意: 本机支持2.4GHz和5GHz的WiFi, 如果要同时使用蓝牙, 请尽量使用5GHz的WiFi, 因为蓝牙也使用2.4GHz的通讯频段, 它会和2.4GHz的WiFi产生一定的相互干扰, 影响通讯质量。



## 正在播放

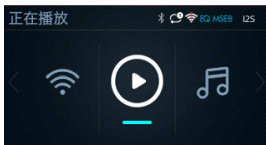

4.1 当SD-9没有正在进行播放音乐时,单击进入会自动切换至音乐库。

4.2 当SD-9在播放音乐页面时,长按遥控器中间键,可以执行4个操作:

1. 添加到“我的最爱”,
2. 添加到歌单,
3. “删除”此歌曲,
4. 播放模式(随机,重复全部,单曲重复,列表播放)



## 音乐库

### 5.1 音乐库介绍

音乐库实际上是分类的歌单列表,当插入新的储存设备时,可以在设置里面点"更新音乐库",系统此时会把储存设备里面的所有音乐更新到这里的播放列表。  
请注意: SD-9歌曲扫描最大数量是30,000,超出的部分会忽略掉。

- 最近播放
- 全部歌曲
- 我的最爱
- 专辑分类
- 风格分类
- 表演者分类
- 歌单

### 5.2 音乐库操作

进入歌单,定位到歌曲,长按遥控器中间键会打开操作菜单:

1. 添加到我的最爱;
2. 添加到播放列表.





## 音乐源



SD-9共有8种输入源:

- SD卡
- 局域网
- OTG\_1
- OTG\_2
- USB\_DAC
- DLNA
- AirPlay
- 蓝牙

### 6.1 SD卡

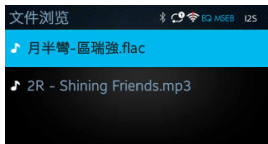

6.1播放SD卡或者USB储存器内的音乐, 这里的USB指的是2个USB(A型)接口, 在输入源菜单显示为OTG\_1, OTG\_2 它们都可以连接U盘或者移动硬盘, 最大支持4TB容量。

有2种方法:

1. 选择"音乐源", 选择SD/OTG, 直接浏览文件夹并且选择音频文件进行播放, 并且播放完成一个文件夹后, 它会自动播放下一个文件夹里面的音频文件。
2. 选择"系统设置"->"更新音乐库"  
更新音乐库后, 在"音乐库"里面选择"全部歌曲"便可以正常播放。

## 音乐源

### 6.2 SAMBA(NAS)局域网播放:

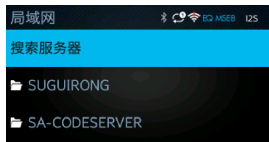

在“音乐源”菜单下,单击进入“局域网”,选择相应文件夹,读取歌曲进行播放。这个功能可以读取当前网络环境下的所有共享音乐包括NAS或者PC。

注意: 如果SD-9提示要输入用户名密码,则说明这个共享的文件没有正确设置。

下面就windows 10的共享文件举例说明:



## 音乐源



## 音乐源

### 6.3 USB DAC:

SD-9支持USB DAC功能, 使用USB(B型)接口输入。

- 使用前请确认此功能打开:

系统设置->USB模式, 选择DAC。

注意: 如果这里选择为USB, 则此时USB接口是用作与电脑连接传输音乐文件到SD卡或者U盘。

- 如果使用Windows的电脑连接, 请安装windows驱动。

下载地址是:<https://www.smsl-audio.com/portal/product/downlist/id/11.html>

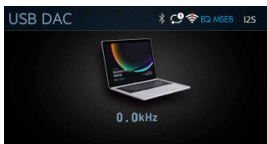

### 6.4 DLNA:

SD-9支持DLNA协议播放, 兼容大部分DLNA协议设备

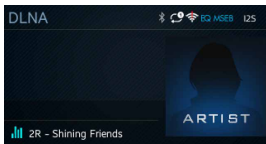

## 音乐源

下面以QQ音乐的QPLAY为例, 示范如何播放:

1. 手机安装QQ音乐, 并下载音乐播放;
2. 检查QPLAY功能和SD-9的DLNA是否有打开;

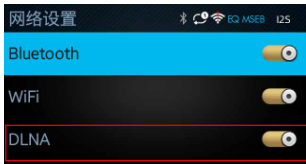

3. 确保手机和SD-9在同一个网络下;
4. 在弹出菜单选择QPLAY, 并且在弹出菜单中选择SD-9.



## 音乐源

### 6.5 苹果AirPlay功能：



#### 6.5 苹果AirPlay

SD-9支持苹果的AirPlay功能, 下面以iPhone为例示范如何播放:

1. 检查SD-9的AirPlay功能是否有打开, "网络设置->AirPlay";
2. 确保手机和SD-9在同一个网络下;
3. 在iPhone的"控制中心", 点开  标志, 在弹出菜单中选择SD-9就可以了, 如左图。

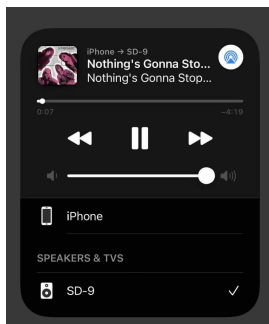

### 6.6 蓝牙输入

SD-9的蓝牙有输入和输出功能, 前面介绍了输出功能, 这里介绍的是输入功能:  
使用手机连接SD-9

1. 蓝牙功能必须打开;
2. 如果要用蓝牙输入音频, 则HiBy Link必须关闭;
3. 在手机上搜索SD-9并连接, 连接成功就可以播放音乐了。

## HiBy LINK海贝连接

SD-9支持HiBy LINK,也就是"海贝音乐"播放器里面的控制功能,用手机通过蓝牙连接SD-9,可以实现在手机里面控制SD-9播放,非常好用!

连接步骤:

1. 请确保SD-9的HiBy Link功能有打开,"网络设置"->"HiBy Link",打开。
2. 手机下载"海贝音乐",iPhone的用户请到AppStore下载,安卓用户请扫下面的二维码或者到HiBy官网下载。



3. 打开"海贝音乐",选择  图标,在下面可以找到SD-9,点击并连接,连接好后,就可以用"海贝音乐"来浏览SD-9里面的SD卡,USB的音乐并播放了。

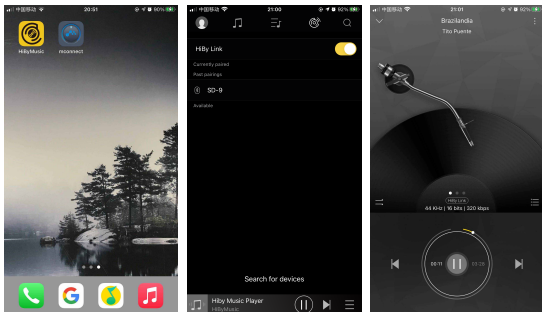

## 关于MQA

MQA (Master Quality Authenticated) 是一项屡获殊荣的英国技术, 是一种兼有极高的采样率和足够小的文件体积的高解析音频编码技术。SD-9采用MQA技术, 可以接收并解码MQA音频, 提供母带级别的声音。

有关更多信息, 请访问<https://www.mqa.co.uk/how-it-works>

## MQA文件播放

- SD-9只有USB接口支持MQA解码, 其它接口不支持!
- SD-9的MQA播放不要求使用特殊的播放软件, 例如foobar2000, Audirvanaplus只要支持ASIO或者WASAPI的音频输出就可以了, 并且在播放MQA音频时, 最好将电脑的音量调到最大, 以使得电脑的音频输出是最佳状态。
- MQA商标旁边的指示灯为绿色或蓝色亮起, 表示设备正在解码并播放MQA音频或文件, 并且确保输出音质与源素材一致。它呈蓝色亮起, 表示它正在播放MQA Studio文件, 该文件已经由艺术家/制作人或者版权所有人获得授权。
- 在播放MQA文件时, 显示屏显示的采样率为音频原始采样率。



MQA和声波标志是MQA Limited的注册商标。©2016



S.M.S.L

## Safety Notes

- Install this unit in a well ventilated, cool, dry, clean place-away from direct sunlight, heat sources, vibration, dust, moisture, or cold..
- Use the voltage specified on this unit Only. Using this unit with a higher voltage than specified is dangerous and may cause fire , damage to this unit, or personal injury. Our company will not be held responsible for any damage resulting from the use of this unit with a voltage other than that specified.
- Do not attempt to modify or fix this unit by yourself. Contact alesperson or customer service when any service is needed. The cabinet should never be opened for any reason.
- When not planning to use this unit for long periods of time (i.e. when going on vacation), disconnect the power cable from the AC wall outlet.

### **Important note:**

The product specifications and information mentioned in this manual are for reference only. The content of this manual is subject to change without notice.

## Warranty Terms

### 1.The Term of Service

Foshan Shuangmusanlin Technology Co., Ltd promises to offer good-quality products. If the product is broken in 7 days after purchasing when you use it normally, you can choose to send it back for return, replacement or repairing (only the product does not affect the second sales can be returned ). Repairing for free in one year if you use it normally.

2.Date of purchase is in accordance with the date on invoice or receipt used by seller, and if you buy it on line, you can show the screenshot of trade.

3.If an inappropriate usage causes the unit damaged, the warranty will be void. As below.

- All damages by inappropriate use, including using it under non-normal working environment or without following the instructions.
- Dismantling, refitting, repairing by user in private.
- Causing damage by using some fittings instead of the designative or accredited ones.
- Cannot provide credible proof of purchase.

4.Sending it back to our company for repairing.

5.Contact your S.M.S.L Audio reseller for a return or replacement.

## Features

- All format playback, support MQA, DSD, WAV, APE, FLAC, AIFF, MP3, etc.;
- All digital interface: USB, optical, coaxial, I2S, AES/EBU, Bluetooth;
- Support streaming media playback, including DLNA and AirPlay;
- Support USB HDD, up to 4TB capacity, and support NTFS/FAT32 file system;
- Support Hiby link, you can use Hiby mobile app to control it;
- Support wired or WIFI connection, support 2.4GHz and 5GHz WIFI;
- Bluetooth supports transmitting and receiving functions;
- USB DAC receiver, can connect to computer to play music;
- USB DAC transmitter, can connect to USB DAC (like SU-9) to play music;
- USB DAC/I2S output support up to PCM32bit/384kHz and DSD256;
- I2S LVDS level output via HDMI physical interface;
- SPDIF interfaces supports DOP and D2P output;
- The newly designed UI makes the operation easier;
- Built-in high efficiency, low noise switching power supply;
- Tempered glass top cover, nice and timeless!

## Note

**Firmware and driver download:** <https://www.smsl-audio.com/>

## Specifications

### INPUTS:

USB(type A) x2, USB(type B), micro SD, Bluetooth

### OUTPUTS:

Optical, Coaxial, AES/EBU, Bluetooth, I2S(HDMI), USB(type A)

### AUDIO SECTION

USB Audio

PCM

44.1kHz ~ 384kHz

DSD

DSD64~DSD256

USB System

windows 7/8/8.1/10/11, Mac OS X, Linux

DSD to PCM(D2P)

Convert to PCM 88.2kHz

DSD over PCM(DoP)

DoP64, DoP128

SPDIF DoP

DoP64

### USB SECTION

Version

USB2.0 high speed

USB Maximum current

2A (2 USB total)

USB (type B)

DAC/copy music

File system

FAT/FAT32/NTFS

Micro SD Capacity

up to 256 GB

Hard disk driver

up to 4 TB

## Specifications

### BLUETOOTH SECTION

Bluetooth version	4.0
HiBy Link	Supported
Format	
Output support	SBC /AAC /APTX/LDAC /UAT
Input support	SBC /AAC/LDAC /UAT
Input preference order	UAT → LDAC → AAC → SBC
Output preference order	UAT → LDAC → APTX → AAC → SBC

### NETWORK SECTION

WiFi	2.4GHz/5GHz(shared antenna)
Ethernet	100Mb/s

### GENERAL

Language	Chinese, English
Software update	Micro SD
Power consumption	20W
Standby Power	<0.5W
Size	187.5 x 154 x 40(mm)
Weight	760g / 1.67 lbs

## Formats

Format	Support	Level	Sampling rate(Hz)		Bit width	CUE	Remarks
			Min	Max			
APE	support	Fast	8K	384K	16-24bit	support	
	support	Normal	8K	384K	16-24bit	support	
	support	High	8K	384K	16-24bit		
	support	Extra high	8K	96K	16-24bit		176/192K not support
	not support	Insane	8K				
WAV	support		8K	384K	16-32bit	support	DTS not support
WMA	support		8K	96K	16-24bit		
WMALOSSLESS	support		8K	96K	16-24bit		
Flac	support		8K	384K	16-24bit	support	
DSF	support		2.8M	11.2M	1bit		
DFF	support		2.8M	11.2M	1bit		
ISO DSD	support		2.8M	2.8M			
ISO DST	not support						
AIFF	support		8K	384K	16-32bit		
M4A	support		8K	384K	16-24bit		
MP2	support		8K	48K	16bit		
MP3	support		8K	48K	16bit	support	
AAC	support		8K	48K	16bit		
OGG	support		8K	48K	16bit		

### Note:

1. The mark here is the rate of sampling is not a file rate.
2. Ape : 32-192kHz's Insane file does not support.  
176.4kHz, 192kHz's Extra high file does not support.
3. ISO8 files do not support.
4. ALL 64k files do not support.

## Remote control

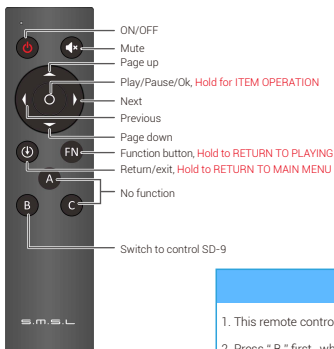

### Note

1. This remote controller use 2 x R03/AAA batteries.
2. Press " B " first , when using SD-9 for the first time!

When the playing time of the current song exceeds 10 seconds, press the "left" button on the remote control to start playing the current song from the beginning. If it does not exceed 10 seconds, the previous song will be played.

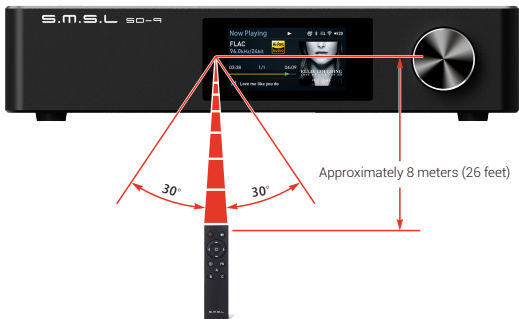

## Parts names and functions

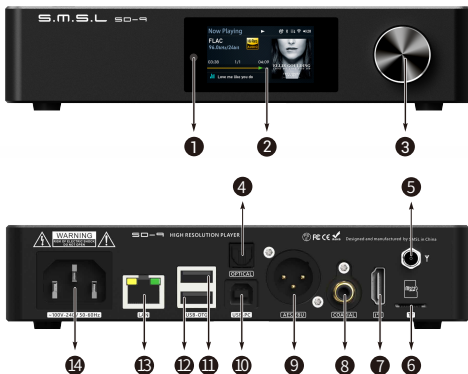

- |  |  |
|--|--|
| <b>1</b> Remote window                     | <b>8</b> Coaxial output                |
| <b>2</b> Display screen                    | <b>9</b> AES output                    |
| <b>3</b> Knob                              | <b>10</b> USB (B type) input           |
| <b>4</b> Optical output                    | <b>11</b> OTG_ONE                      |
| <b>5</b> 2.4G/5G dual frequency antenna    | <b>12</b> OTG_TWO                      |
| <b>6</b> Micro SD card slot                | <b>13</b> LAN interface                |
| <b>7</b> I <sup>2</sup> S output interface | <b>14</b> Power AC input<br>(100-240V) |



## Connecting your equipment

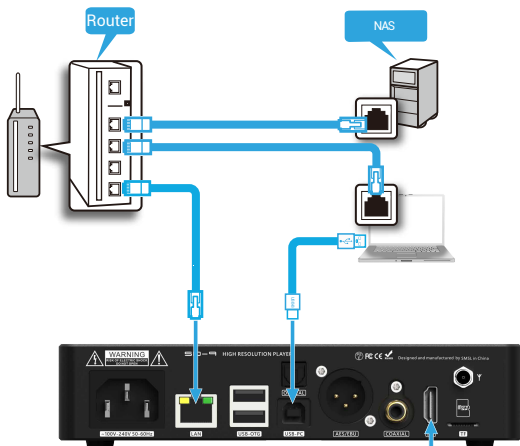

### I2S Pins Functions

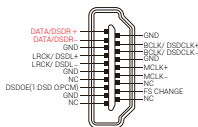

I2S NORMAL

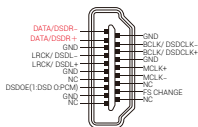

I2S INVERTED

## Connecting your equipment

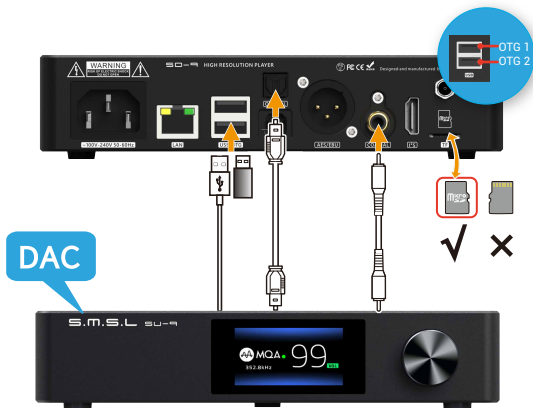

### ■ Instructions for the two USB A ports:

1. When used as a USB hard disk input, the upper interface is OTG\_1 and the lower interface is OTG\_2.

**Note: The sum of the two USB output currents does not exceed 2A.**

2. One of them is used as a USB output. When the USB DAC is connected, the "Audio Device Connection" is displayed, and at the same time, the digital signal is output from this USB interface, and the other output of the SD-9 are silent. When unplugged, "Audio Device Disconnect" is displayed, and the original output is restored.

**Note: The USB DAC cannot be successfully connected due to USB matching problems**

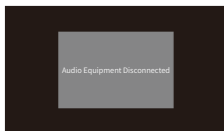
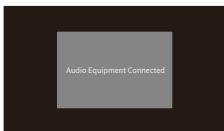

## Connecting your equipment

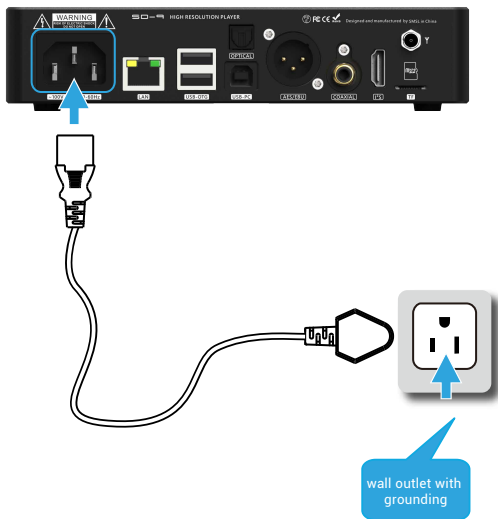

**Note:** Please use a power outlet with a good grounding wire to ensure safety and avoid noise.

## Operation introduction

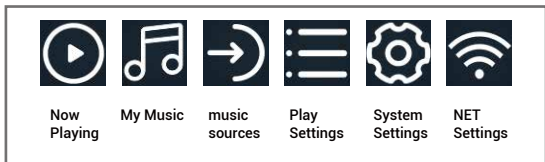
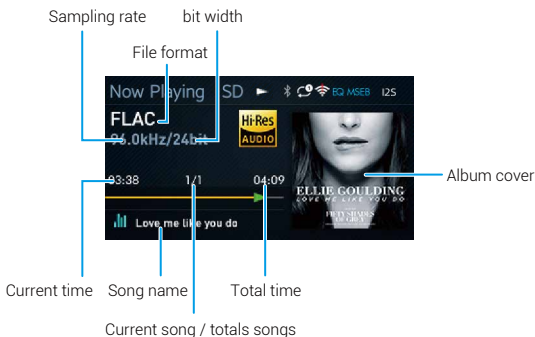
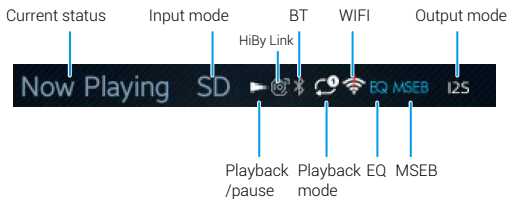

## Operation introduction

### When using for the first time, please note:

1. Press the "B" button before using the remote controller for the first time, because SMSL has the concept of unified remote control, user can use one remote control to control a whole set of SMSL equipment!

They are:

- A: power amplifier
- B: player / Headphone Amplifier
- C: DAC

2. The power state of SD-9 has memory

- Without use the button to shut down, directly unplug the power cord, the next plug will directly boot;
- Hold the knob/remote control power off, the next plug-in will not directly start.

## Knob functions

<b>Click</b>	In the playback state: play/pause
	In other states: confirm/enter
<b>Double-click</b>	Return/exit
<b>Long press</b>	Power on and off
<b>Rotate right</b>	Down
<b>Rotate left</b>	Up

## Operation introduction

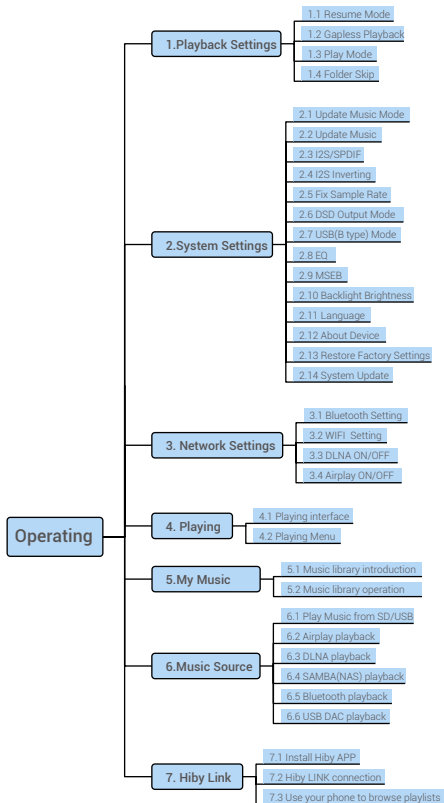

## Play settings

When using it for the first time, please set up the playback first to suit your personal usage habits.

Turn the knob to "Play Settings", click to enter, and set "Breakpoint Memory Play", "Seamless Play", "Play Mode", "Folder Skip" and so on. After setting, double-click to return to the home page.

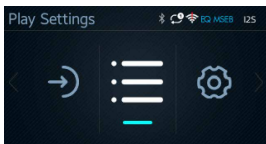

### 1.1 Breakpoint memory playback:

"Turn off" the next time you turn it on, the tracks before the last turn off will not be played.

"Tracks" will automatically display the tracks before the last shutdown the next time the computer is turned on.

"Position" will automatically jump to the track playing position before the last shutdown.

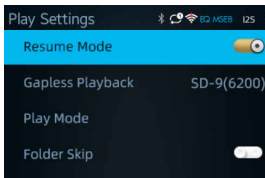

**1.2 Seamless playback:** There is no pause when switching songs with the same sampling rate.

**1.3 Play mode:** 1. List play 2. Single loop 3. Random play 4. List loop.

**1.4 Folder skip:** Switching songs can jump to songs in different files.

## System Settings

For the first use, please set up the system first to suit your personal usage habits.

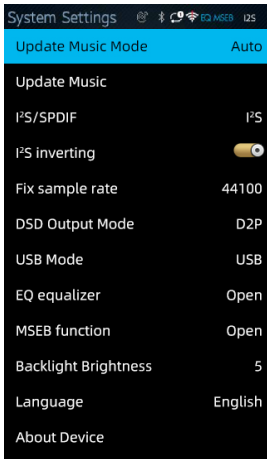

### 2.1 Update music library mode:

Click to select manual or automatic. (Note: This function is only valid for micro SD card.)

### 2.2 Update music library:

Scan the music of SD card, OTG USB device connected to the player list.

### 2.3 I2S/SPDIF:

Choose I2S or SPDIF (optical, coaxial, AES)

### 2.4 I2S inverting:

I2S mode selection, ON is Inverting mode!

### 2.5 Fixed sampling rate output:

The output digital audio is fixed at the set sampling frequency, This setting helps some older DACs work normally with hi-res music.

### 2.6 DSD output mode:

**2.6.1 D2P (DSD to PCM):** Converts DSD signal to PCM output. When the connected DAC does not support DSD, the system converts to 88.2khz sampling rate by default.

**2.6.2 DoP (DSD over PCM):** Package DSD signal into PCM to achieve the purpose of using optical, coaxial, AES / EBU to send DSD audio, up to dop64.

**2.6.3 DSD Native:** Direct DSD data transmission, This setting only supports I2S and USB audio output interface.



## System Settings

### 2.7 USB B port mode:

- This setting is only for type B USB input.
- DAC mode, it is USB DAC;
- USB mode, used to connect the computer to transfer music.

### 2.8 EQ MODE: Open or close.

- EQ is only valid when the sampling rate is 44.1kHz and 48kHz.
- There are 8 preset EQ and 1 custom EQ;
- Custom, a total of 10 EQ (31Hz, 62Hz, 125Hz, 250Hz, 500Hz, 1kHz, 2kHz, 4kHz, 8kHz, 16kHz), the adjustment range is + / - 12dB.

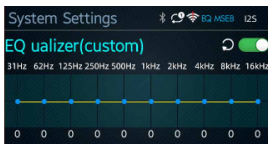
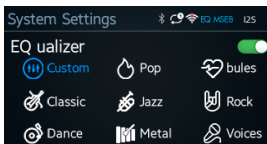

### 2.9 MSEB(Magic Sound 8-ball):

MSEB innovatively uses DSP to quantify the components of audio, and then adjusts the audio effect from the perspective of listening!

- The effective range of MSEB is 96kHz and below.
- There are 10 sound effects settings, which are:

Overall temperature, Bass extension, bass elasticity, Bass texture, Note Thickness, Vocals, Female overtones, Sibillance LF, Sibillance HF, Impulse response, air.

## System Settings

### 2.10 Backlight brightness:

There are 5 levels of brightness.

### 2.11 Language:

Simplified Chinese, Traditional Chinese, English.

### 2.12 About Device:

Model, TF card capacity, Remaining capacity, Bluetooth MAC, Firmware version

### 2.13 Restore Factory Settings:

Reset all options of the niut and restore to factory settings.

### 2.14 System Update:

Download the upgrade firmware to the TF card, insert it into the unit and click system update.

## Network Settings

Click to enter the setting interface.

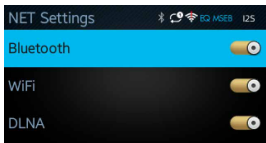

### 3.1 BLUETOOTH

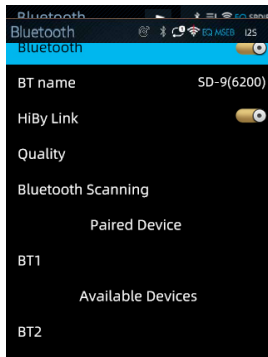

**3.1.1** Bluetooth ON/OFF;

**3.1.2 Bluetooth name:**SD-9(xxxx), the "xxxx" is used to identify individual units. When you have multiple SD-9's in it, it's used to identify them.

The Bluetooth reception of SD-9 is always on. You can use your mobile phone to search and connect the device, and use your mobile phone to control or transmit audio to SD-9.

**3.1.3** HiBy Link ON/OFF,when switched ON, the INPUT function of SD-9 is CONTROL,NOT audio.

- SD-9 can connect with HiBy app, and the mobile phone with HiBy app can operate SD-9's play list.
- If you want to use Bluetooth to input audio, be sure to turn off the HiBy link function of SD-9.

#### 3.1.4 Quality:

Here you can choose the Bluetooth communication format, SD-9 supports:

Input: UAT / LDAC / AAC / SBC

Output :UAT / LDAC / aptX/ AAC / SBC

The priority is also in this order. For example, the UAT format is selected. If the device at the other end does not support this format, the system will automatically switch to the format supported by the other end, such as LDAC, and so on.

## Network Settings

**3.1.5 Bluetooth Scanning:** It is used for Bluetooth output. The Scanning is similar to the Bluetooth Scanning of mobile phones. It is used to connect other Bluetooth devices and output the audio played by SD-9 to Bluetooth headset or Bluetooth speaker through Bluetooth.

- Please make sure that your Bluetooth headset or speaker is in pairing state, and then click OK to enter the Scanning. After the Scanning, you can find your Bluetooth headset or speaker in the follow menu, and then click the device you want to connect.
- After Bluetooth connection, audio can be output from Bluetooth, and the digital output interface still has sound output.

### 3.2 WIFI



#### 3.2.1 WIFI ON / OFF;

#### 3.2.2 Searching WiFi:

Click to search. After the search, the WiFi nearby will appear in the menu below. Select the name to connect and use the remote control to enter the password.

- Note: please don't use letters or symbols which are not supported by local keyboard to avoid connection failure.

- Note that this unit supports 2.4GHz and 5GHz WiFi. If you want to use Bluetooth at the same time, please try to use 5GHz WiFi, because Bluetooth also uses 2.4GHz communication frequency band, which will cause certain interference with 2.4GHz WiFi and affect the communication quality.

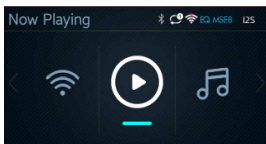
**NOW PLAYING****4.1**

When SD-9 is not playing music, click play and the system will automatically switch to music library.

**4.2**

when SD-9 is playing the music page, long press the middle key of the remote control to perform four operations:

1. Add to my favorite,
2. Add to playlist,
3. Delete the song,
4. Play mode(Shuffle, Repeat ALL, Repeat Track, List Play)

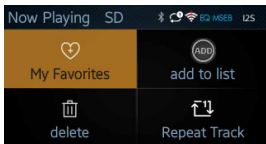

## Music library

### 5.1 Music library introduction

Music library is actually a classified list of songs. When a new storage device is inserted, you can click "update music" in the settings. At this time, the system will update all the music in the storage device to the play list here.

Please note: the maximum number of SD-9 songs scanned is 30,000 and the excess will be ignored.

- Recently played
- Open all
- My favorites
- Album
- Genre
- Artist
- Playlist

### 5.2 Music library operation

Enter the song list, locate the song, and hold the middle key of the remote control to open the operation menu:

1. Add to my favorite;
2. Add to the play list

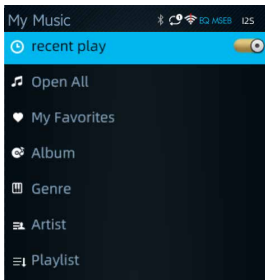

## Music source

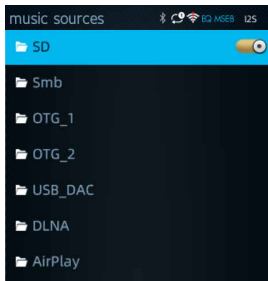

Eight input sources

- SD card
- LAN
- OTG\_one
- OTG\_two
- USB\_DAC
- DLNA
- AirPlay
- Bluetooth

### 6.1 SD card

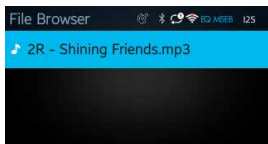

**6.1** Play the music in SD card or USB memory. USB(type A) interfaces which is displayed as OTG\_1, OTG\_2 in the "music sources", They can be connected to U disk or mobile hard disk, and the maximum capacity is 4TB.

There are 2 ways:

1. Select "Music Source", select SD / OTG, browse the folder directly and select audio files to play. After playing a folder, it will automatically play the audio files in the next folder.

2. Select "System Settings" -> "Update Music"

After updating the music library, select Open all in "My Music"

And then enjoy the music.

## Music source

### 6.2 SAMBA(NAS)

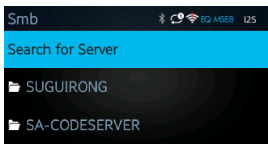

In the "music source" menu, click to enter the "SMB", select your PC or NAS, find the folder and songs to play. This function can read all the shared music in the current network environment, including NAS or PC.

Note: If SD-9 prompts you to enter the user name and password, the shared file is not set correctly.

Here is an example of windows 10 shared file:





## Music source

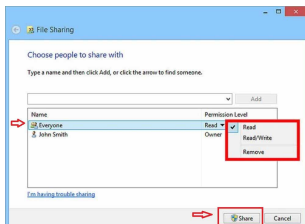

## Music source

### 6.3 USB DAC:

SD-9 supports USB DAC function and uses USB (type b) interface to input.

- Please confirm that this function is ON before use:

System Settings > USB mode, select DAC

Note: if USB is selected here, then USB interface is used to connect with computer and transfer music files to SD card or U disk

- If you use a Windows computer to connect, please install windows driver, the download address is:

<https://www.smsl-audio.com/portal/product/downloadlist/id/11.html>



### 6.4 DLNA

SD-9 supports DLNA protocol playback and is compatible with most DLNA protocol devices.

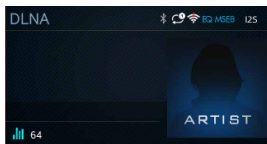

## Music source

SD-9 supports DLNA protocol playback and is compatible with most DLNA protocol devices. Take "mconnect" as an example to demonstrate how to play:

1. Install mconnect on mobile phone and download music and set to playing;
2. Check DLNA of SD-9 are turned on;



3. Make sure the mobile phone and SD-9 are in the same network;
4. Select "Play to" and then select SD-9 in the menu.



## Music source

### 6.5 Apple AirPlay

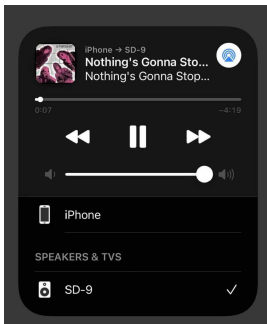
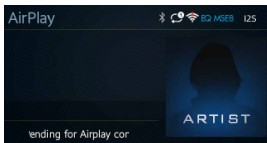

SD-9 supports Apple's AirPlay function. Take iPhone as an example to demonstrate how to play:

1. Check whether the SD-9's AirPlay function is turned on, "Network Settings > AirPlay";
2. Make sure the mobile phone and SD-9 are in the same network;
3. In the control center of iPhone, click the logo  and select SD-9 in the pop-up menu, as shown in the figure left.

### 6.6 Bluetooth input

The Bluetooth of SD-9 has input and output functions. The output function was introduced above, and the input function is introduced here.

Connect SD-9 with mobile phone

1. The Bluetooth function must be turned on;
2. If you want to use Bluetooth to input audio, HiBy Link must be closed;
3. Search for SD-9 on your mobile phone and connect it, you can play music after the connection is successful.

## HiBy Link

SD-9 supports HiBy link, which is the control function in the "HiBy music" player. You can connect SD-9 with your mobile phone through Bluetooth to control SD-9's playlist. It's very easy to use!

Connect Steps:

1. Please make sure that the HiBy link function of SD-9 is turned on, and "network settings" -> "HiBy link" is turned on
2. Download "HiBy music" from mobile phones. iPhone users can go to the Appstore to download it. Android users can scan the QR code below or download it from HiBy official website



3. Open "HiBy music", select the  icon, you can find SD-9 below, click and connect, after connecting, you can use "HiBy music" to browse SD-9 card, USB music and play.

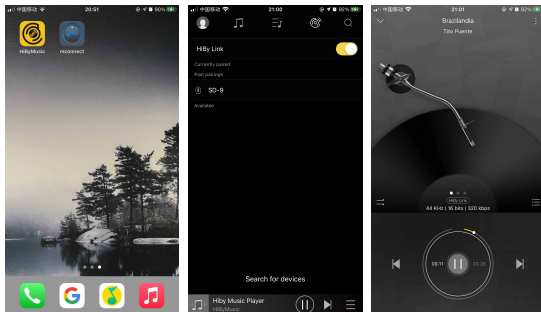

## About MQA

MQA (Master Quality Authenticated) is an award-winning British technology that delivers the sound of the original master recording. The master MQA file is fully authenticated and is small enough to stream or download. The SD-9 includes MQA technology, which enables you to playback MQA audio files and streams, delivering the sound of the original master recording.

Visit How it works <https://www.mqa.co.uk/how-it-works> for more information.

## MQA files playback

- Only the USB interface of SD-9 supports MQA decoding, other interfaces do not!
- SD-9 MQA playback does not require the use of special playback software, such as foobar2000, Audirvanaplus only needs to support ASIO or WASAPI audio output, and when playing MQA audio, it is best to adjust the computer's volume to the maximum to make the computer The audio output is the best.
- The indicator light next to the MQA trademark is green or blue, indicating that the device is decoding and playing MQA audio or files, and to ensure that the output sound quality is consistent with the source material. It lights up blue to indicate that it is playing an MQA Studio file, which has been authorized by the artist/producer or copyright owner.
- When playing an MQA file, the sampling rate displayed on the display screen is the original sampling rate of the audio.



MQA and the Sound Wave Device are registered trade marks of MQA Limited. © 2016