

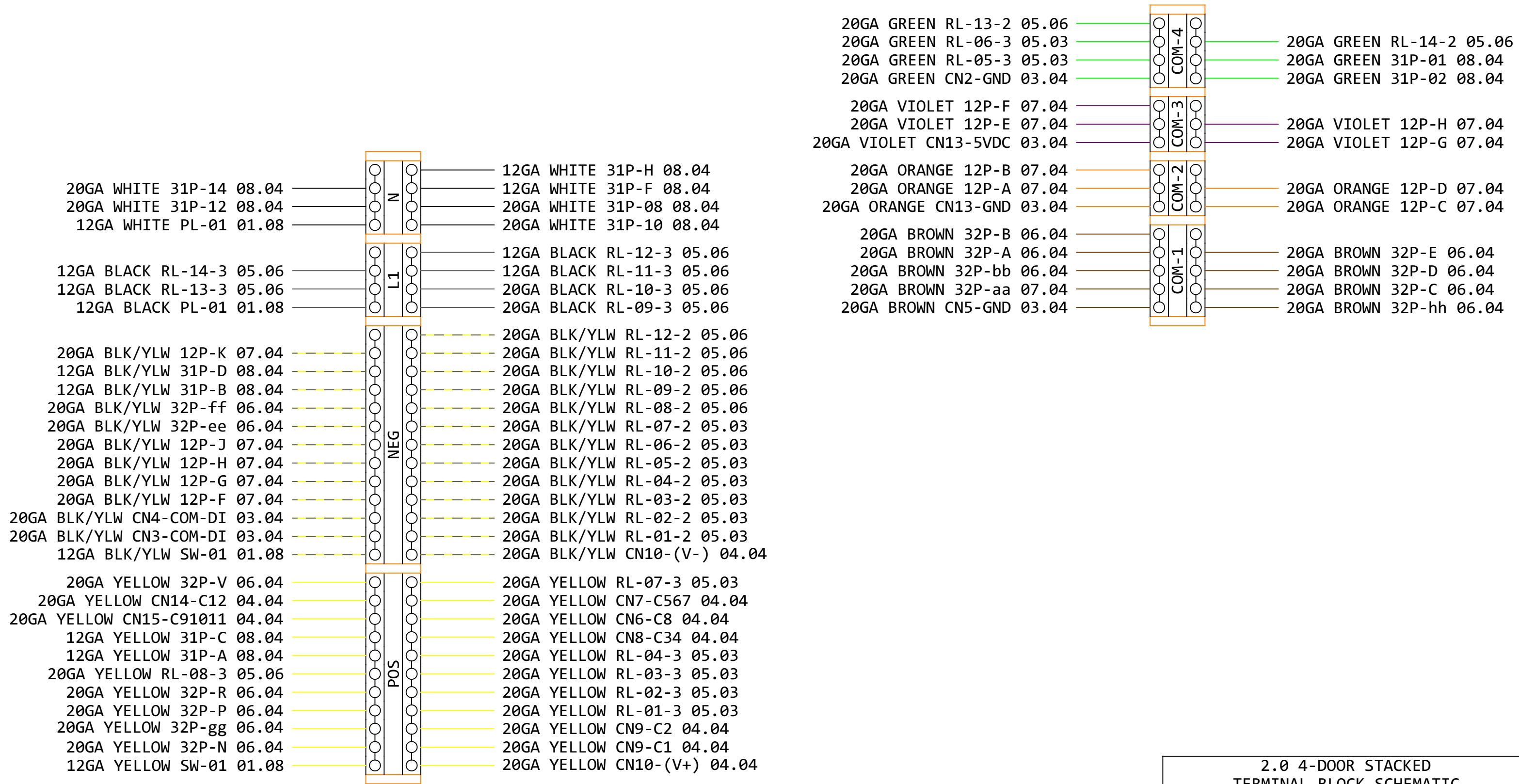

2.0 4-DOOR STACKED INPUT SCHEMATIC		
QUALSERV <small>SOLUTIONS INTERNATIONAL</small>	DWG SIZE: B	DWG#: 00000000
	7400 SOUTH 28th STREET FORT SMITH, AR 72908 PH. 800-642-2988 FAX. 479-646-5517	DATE: 6/2/2022
DRAWN BY: BDAVIDSON		PAGE: 01 OF 13
<small>NOTICE: THIS DRAWING IS THE PROPERTY OF QUALSERV SOLUTIONS INC. AND CONTAINS CONFIDENTIAL AND PROPRIETARY INFORMATION. NO PORTION OF THIS DRAWING MAY BE REPRODUCED OR COMMUNICATED WITHOUT EXPLICIT WRITTEN PERMISSION FROM QUALSERV SOLUTIONS INC.</small>		REV. 0

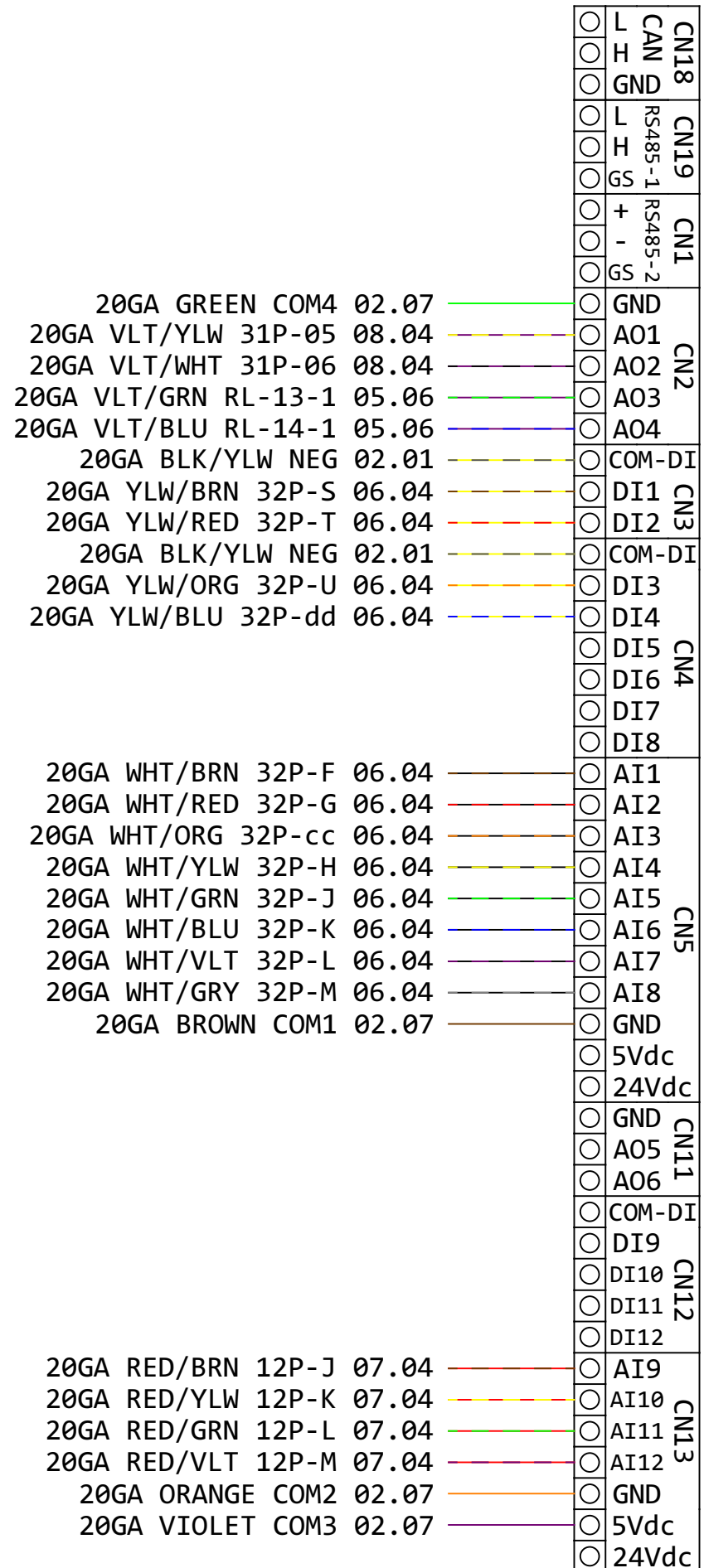

2.0 4-DOOR STACKED TERMINAL BLOCK SCHEMATIC		
 <small>7400 SOUTH 28th STREET FORT SMITH, AR 72908 PH. 800-642-2980 FAX. 479-646-5517</small>	DWG SIZE: B	DWG#: 00000000
	279 x 432 MM	DATE: 6/2/2022
DRAWN BY: BDAVIDSON		
PAGE: 02 OF 13		REV. 0

NOTICE: THIS DRAWING IS THE PROPERTY OF QUALSERV SOLUTIONS INTERNATIONAL, INC. AND CONTAINS CONFIDENTIAL AND PROPRIETARY INFORMATION. NO PORTION OF THIS DRAWING MAY BE REPRODUCED OR COMMUNICATED WITHOUT EXPLICIT WRITTEN PERMISSION FROM QUALSERV SOLUTIONS INTERNATIONAL, INC.



2.0 4-DOOR STACKED PLC BOTTOM SCHEMATIC		
 <small>7400 SOUTH 28th STREET FORT SMITH, AR 72908 PH. 800-642-2980 FAX. 479-646-5517</small>	DWG SIZE: B	DWG#: 00000000
	279 x 432 MM	DATE: 6/2/2022
DRAWN BY: BDAVIDSON		
PAGE: 03 OF 13		REV. 0

NOTICE: THIS DRAWING IS THE PROPERTY OF QUALSERV SOLUTIONS INTERNATIONAL, INC. AND CONTAINS CONFIDENTIAL AND PROPRIETARY INFORMATION. NO PORTION OF THIS DRAWING MAY BE REPRODUCED OR COMMUNICATED WITHOUT EXPLICIT WRITTEN PERMISSION FROM QUALSERV SOLUTIONS, INC.

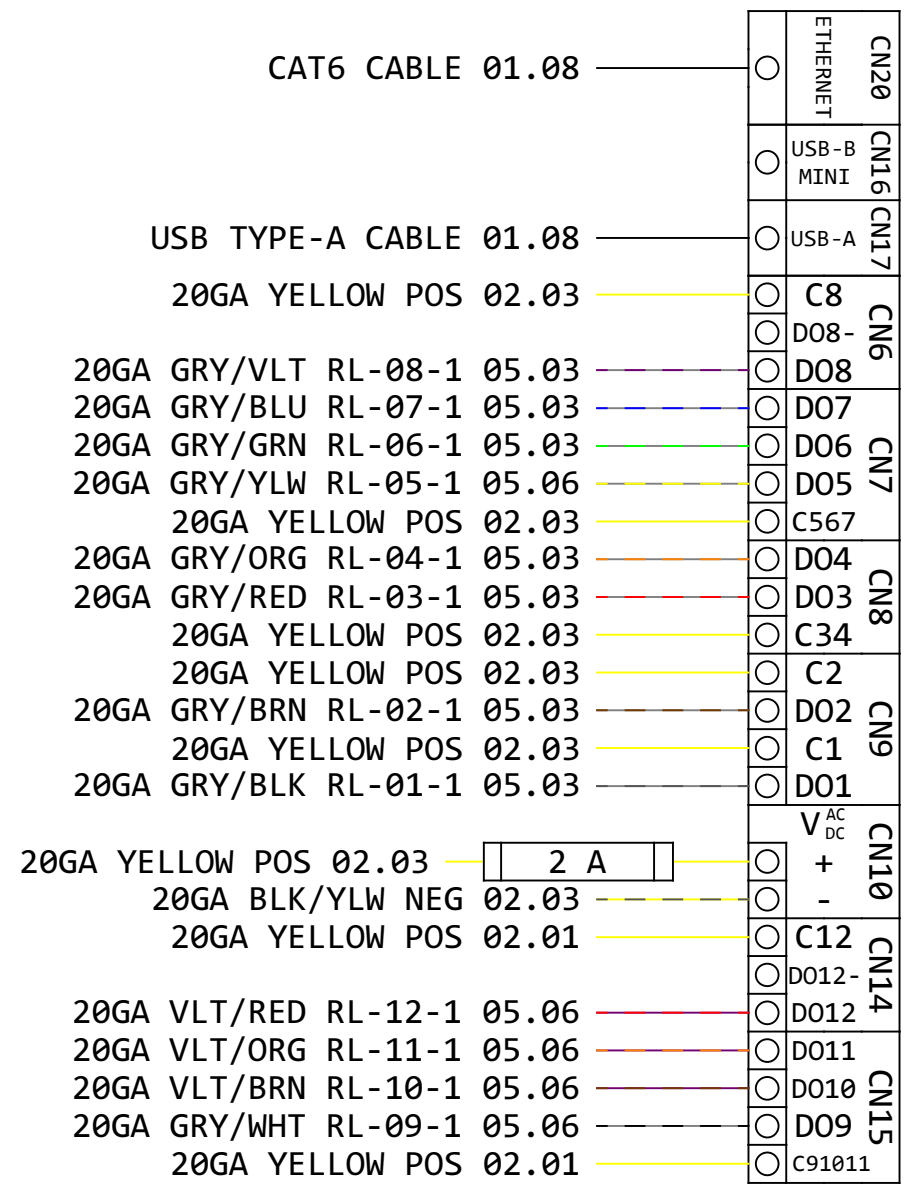

2.0 4-DOOR STACKED PLC TOP SCHEMATIC		
QUALSERV <small>SOLUTIONS INTERNATIONAL</small>	DWG SIZE: B	DWG#: 00000000
	7400 SOUTH 28th STREET FORT SMITH, AR 72908 PH. 800-642-2988 FAX. 479-646-5517	DATE: 6/2/2022
DRAWN BY: BDAVIDSON		
PAGE: 04 OF 13		REV. 0

NOTICE: THIS DRAWING IS THE PROPERTY OF QUALSERV SOLUTIONS INC. AND CONTAINS CONFIDENTIAL AND PROPRIETARY INFORMATION. NO PORTION OF THIS DRAWING MAY BE REPRODUCED OR COMMUNICATED WITHOUT EXPLICIT WRITTEN PERMISSION FROM QUALSERV SOLUTIONS INC.

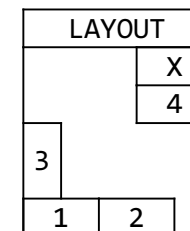
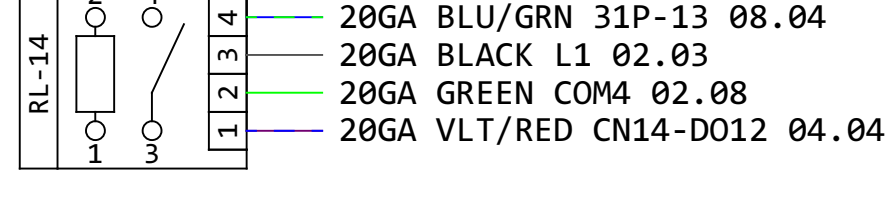
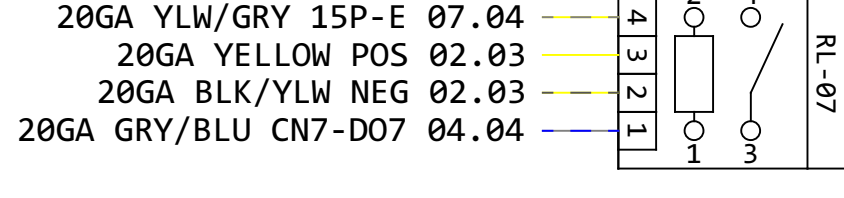
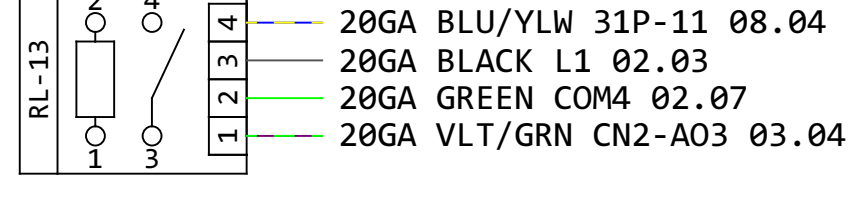
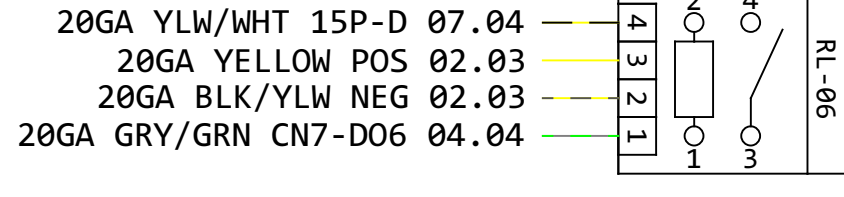
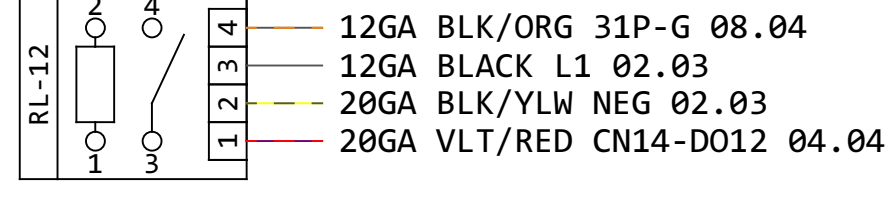
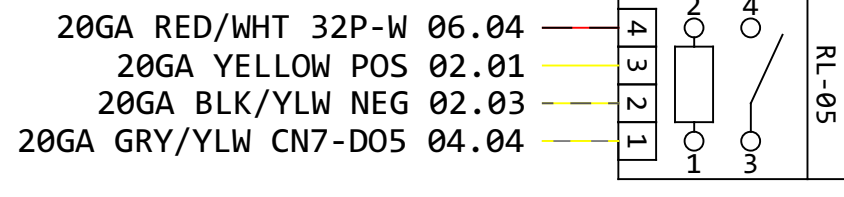
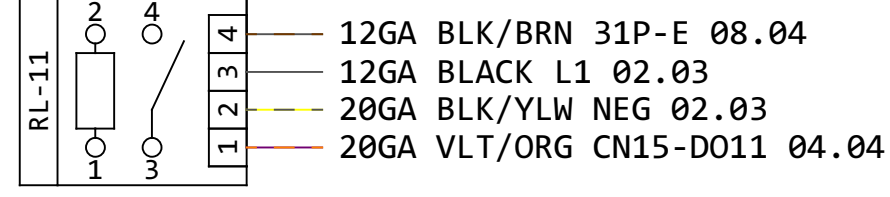
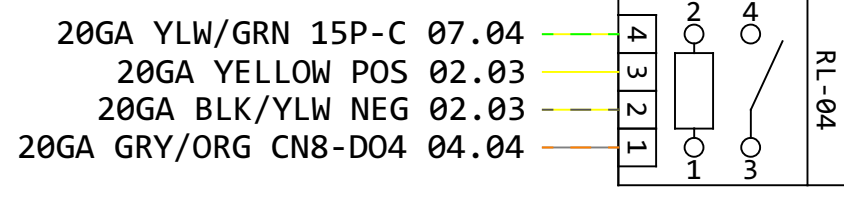
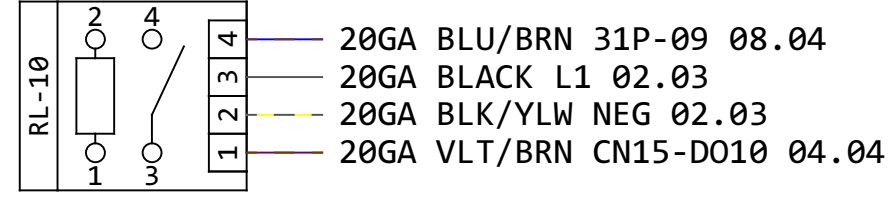
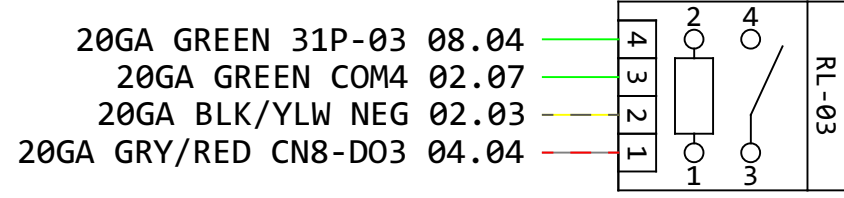
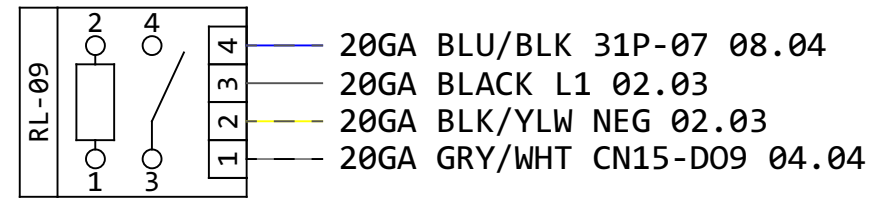
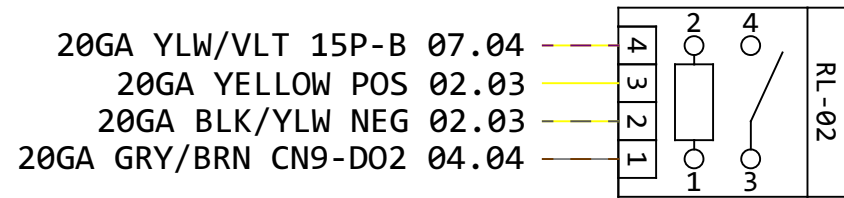
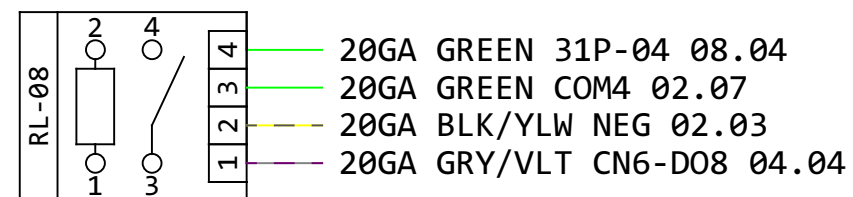
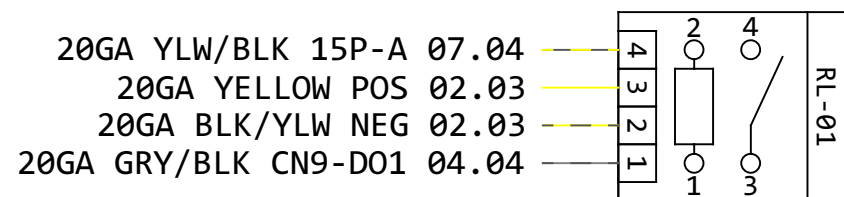

2.0 4-DOOR STACKED RELAY SCHEMATIC

 <small>7400 SOUTH 28th STREET FORT SMITH, AR 72908 PH. 800-642-2980 FAX. 479-646-5517</small>	DWG SIZE: B	DWG#: 00000000
	279 x 432 MM	DATE: 6/2/2022
DRAWN BY: BDAVIDSON		
PAGE: 05 OF 13		REV. 0

NOTICE: THIS DRAWING IS THE PROPERTY OF QUALSERV SOLUTIONS INTERNATIONAL, INC. AND CONTAINS CONFIDENTIAL AND PROPRIETARY INFORMATION. NO PORTION OF THIS DRAWING MAY BE REPRODUCED OR COMMUNICATED WITHOUT EXPLICIT WRITTEN PERMISSION FROM QUALSERV SOLUTIONS, INC.

20GA BROWN COM1 02.07	—	○	aa
20GA BROWN COM1 02.07	—	○	bb
20GA BROWN COM1 02.07	—	○	A
20GA BROWN COM1 02.07	—	○	B
20GA BROWN COM1 02.08	—	○	hh
20GA BROWN COM1 02.08	—	○	C
20GA BROWN COM1 02.08	—	○	D
20GA BROWN COM1 02.08	—	○	E
20GA WHT/BRN CN5-AI1 03.04	—	○	F
20GA WHT/RED CN5-AI2 03.04	—	○	G
20GA WHT/ORG CN5-AI3 03.04	—	○	cc
20GA WHT/YLW CN5-AI4 03.04	—	○	H
20GA WHT/GRN CN5-AI5 03.04	—	○	J
20GA WHT/BLU CN5-AI6 03.04	—	○	K
20GA WHT/VLT CN5-AI7 03.04	—	○	L
20GA WHT/GRY CN5-AI8 03.04	—	○	M
20GA YELLOW POS 02.01	—	○	N
20GA YELLOW POS 02.01	—	○	gg
20GA YELLOW POS 02.01	—	○	P
20GA YELLOW POS 02.01	—	○	R
20GA YLW/BRN CN3-DI1 03.04	—	○	S
20GA YLW/RED CN3-DI2 03.04	—	○	T
20GA YLW/ORG CN4-DI3 03.04	—	○	U
20GA YLW/BLU CN4-DI4 03.04	—	○	dd
20GA YELLOW POS 02.01	—	○	V
20GA RED/WHT RL-05-4 05.03	—	○	w
20GA BLK/YLW NEG 02.01	—	○	ff
20GA BLK/YLW NEG 02.01	—	○	ee
		○	1
		○	2
		○	3
		○	4

32-PIN CONNECTOR
4-DOOR STACKED SIGNAL CONNECTIONS

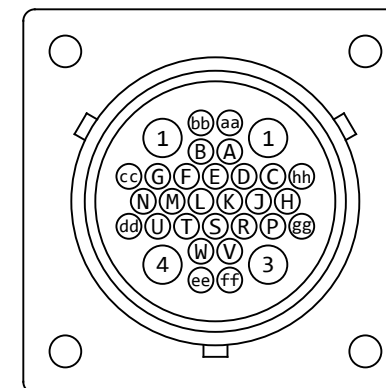

2.0 4-DOOR STACKED 32-PIN FLANGE RECEPTACLE SCHEMATIC		
QUALSERV <small>SOLUTIONS INTERNATIONAL</small>	DWG SIZE: B	DWG#: 00000000
	7400 SOUTH 28th STREET FORT SMITH, AR 72908 PH. 800-642-2980 FAX. 479-646-5517	DATE: 6/2/2022
NOTICE: THIS DRAWING IS THE PROPERTY OF QUALSERV SOLUTIONS INTERNATIONAL, INC. AND CONTAINS CONFIDENTIAL AND PROPRIETARY INFORMATION. NO PORTION OF THIS DRAWING MAY BE REPRODUCED OR COMMUNICATED WITHOUT EXPLICIT WRITTEN PERMISSION FROM QUALSERV SOLUTIONS, INC.		DRAWN BY: BDAVIDSON
		PAGE: 06 OF 13 REV. 0

20GA ORANGE COM2 02.07	—	○	A
20GA ORANGE COM2 02.07	—	○	B
20GA ORANGE COM2 02.08	—	○	C
20GA ORANGE COM2 02.08	—	○	D
20GA VIOLET COM3 02.07	—	○	E
20GA VIOLET COM3 02.07	—	○	F
20GA VIOLET COM3 02.08	—	○	G
20GA VIOLET COM3 02.08	—	○	H
20GA RED/BRN AI9 03.04	—	○	J
20GA RED/YLW AI10 03.04	—	○	K
20GA RED/GRN AI11 03.04	—	○	L
20GA RED/VLT AI12 03.04	—	○	M

**12-PIN CONNECTOR
TRANSDUCER CONNECTIONS**

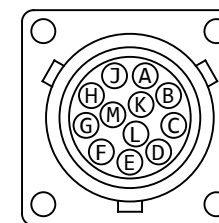

20GA YLW/BLK RL-01-4 05.03	—	○	A
20GA YLW/VLT RL-02-4 05.03	—	○	B
20GA YLW/GRN RL-04-4 05.03	—	○	C
20GA YLW/WHT RL-06-4 05.03	—	○	D
20GA YLW/GRY RL-07-4 05.03	—	○	E
20GA BLK/YLW NEG 02.01	—	○	F
20GA BLK/YLW NEG 02.01	—	○	G
20GA BLK/YLW NEG 02.01	—	○	H
20GA BLK/YLW NEG 02.01	—	○	J
20GA BLK/YLW NEG 02.01	—	○	K
		○	L
		○	M
		○	N
		○	1
		○	2

**15-PIN CONNECTOR
SOLENOID CONNECTIONS**

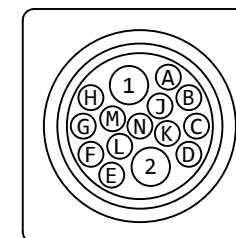

2.0 4-DOOR STACKED 12 & 15-PIN FLANGE RECPT SCHEMATIC		
QUALSERV <small>SOLUTIONS INTERNATIONAL</small>	DWG SIZE: B	DWG#: 000000000
	7400 SOUTH 28th STREET FORT SMITH, AR 72908 PH. 800-642-2980 FAX. 479-646-5517	DATE: 6/2/2022
DRAWN BY: BDAVIDSON		
PAGE: 07 OF 13		REV. 0

NOTICE: THIS DRAWING IS THE PROPERTY OF QUALSERV SOLUTIONS INC. AND CONTAINS CONFIDENTIAL AND PROPRIETARY INFORMATION. NO PORTION OF THIS DRAWING MAY BE REPRODUCED OR COMMUNICATED WITHOUT EXPLICIT WRITTEN PERMISSION FROM QUALSERV SOLUTIONS INC.

12GA YELLOW POS 02.01	—	○	A
12GA BLK/YLW NEG 02.01	- - -	○	B
12GA YELLOW POS 02.01	—	○	C
12GA BLK/YLW NEG 02.01	- - -	○	D
12GA BLK/BRN RL-11-4 05.06	—	○	E
12GA WHITE N 02.03	—	○	F
12GA BLK/ORG RL-12-4 05.06	—	○	G
12GA WHITE N 02.03	—	○	H
		○	I
		○	J
		○	K
		○	L
20GA GREEN COM4 02.03	—	○	1
20GA GREEN COM4 02.03	—	○	2
20GA GREEN RL-03-4 05.03	—	○	3
20GA GREEN RL-08-4 05.03	—	○	4
20GA VLT/YLW CN2-A01 03.04	- - -	○	5
20GA VLT/WHT CN2-A02 03.04	- - -	○	6
20GA BLU/BLK RL-09-4 05.06	—	○	7
20GA WHITE N 02.03	—	○	8
20GA BLU/BRN RL-10-4 05.06	—	○	9
20GA WHITE N 02.03	—	○	10
20GA BLU/YLW RL-13-4 05.06	- - -	○	11
20GA WHITE N 02.03	—	○	12
20GA BLU/GRN RL-14-4 05.06	—	○	13
20GA WHITE N 02.03	—	○	14
		○	15
		○	16
		○	17
		○	18
		○	19

31-PIN CONNECTOR
115V & COMPRESSOR DRIVER CONNECTIONS

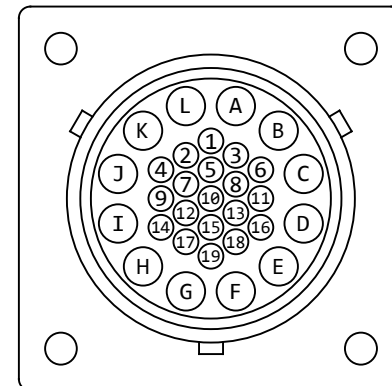

2.0 4-DOOR STACKED 31-PIN FLANGE RECEPTACLE SCHEMATIC		
QUALSERV <small>SOLUTIONS INTERNATIONAL</small>	DWG SIZE: B	DWG#: 00000000
	7400 SOUTH 28th STREET FORT SMITH, AR 72908 PH. 800-642-2980 FAX. 479-646-5517	DATE: 6/2/2022
<small>NOTICE: THIS DRAWING IS THE PROPERTY OF QUALSERV SOLUTIONS INC. AND CONTAINS CONFIDENTIAL AND PROPRIETARY INFORMATION. NO PORTION OF THIS DRAWING MAY BE REPRODUCED OR COMMUNICATED WITHOUT EXPLICIT WRITTEN PERMISSION FROM QUALSERV SOLUTIONS INC.</small>		DRAWN BY: BDAVIDSON
PAGE: 08 OF 13		REV. 0

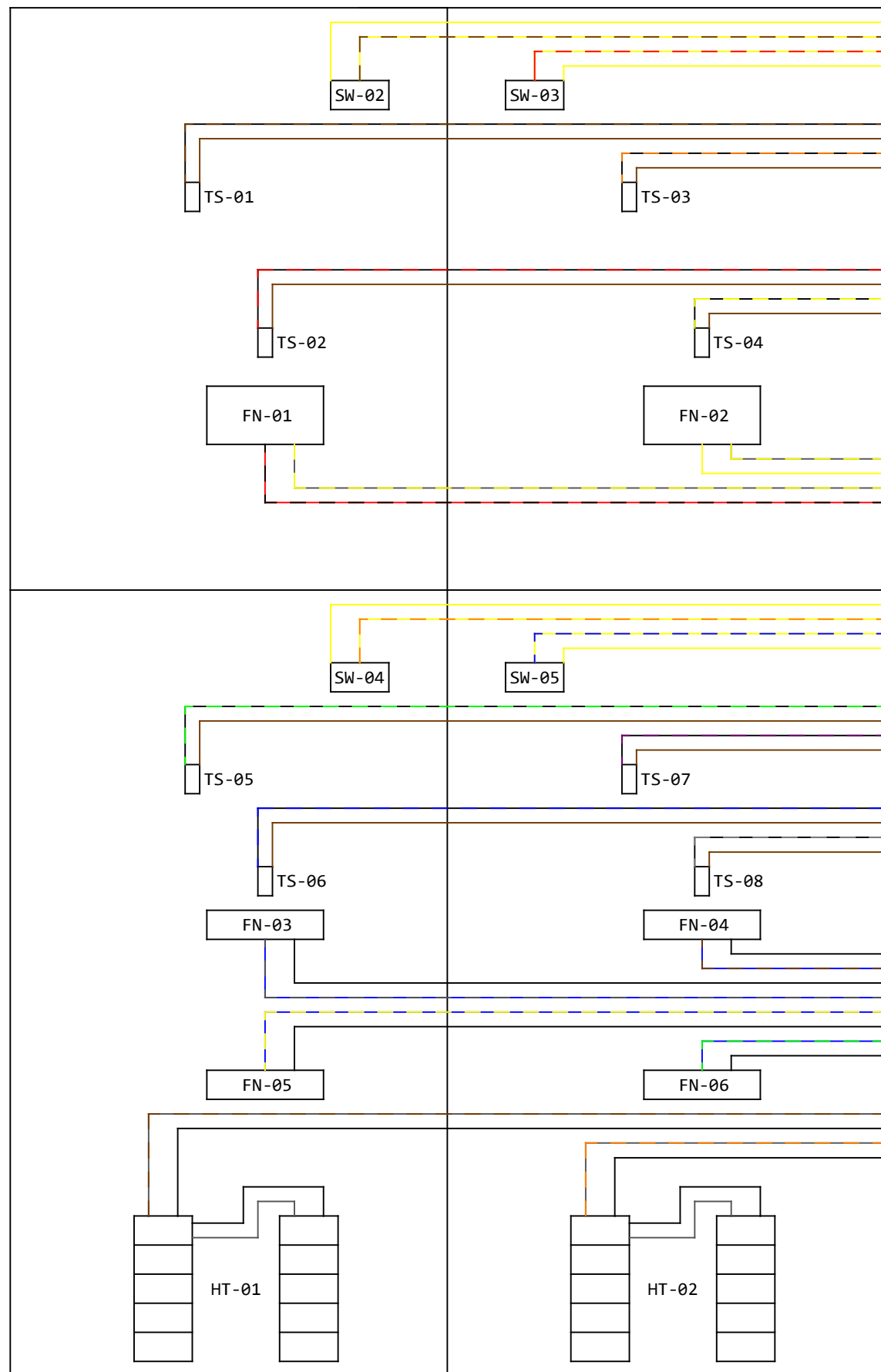

- SW-02 SIGNAL ----- 20GA YLW/BRN 32P-S 11.04
- SW-02 COM ----- 20GA YELLOW 32P-N 11.04
- SW-03 SIGNAL ----- 20GA YLW/RED 32P-T 11.04
- SW-03 COM ----- 20GA YELLOW 32P-gg 11.04
- TS-01 SIGNAL ----- 20GA WHT/BRN 32P-F 11.04
- TS-01 COM ----- 20GA BROWN 32P-aa 11.04
- TS-03 SIGNAL ----- 20GA WHT/ORG 32P-cc 11.04
- TS-03 COM ----- 20GA BROWN 32P-A 11.04
- TS-02 SIGNAL ----- 20GA WHT/RED 32P-G 11.04
- TS-02 COM ----- 20GA BROWN 32P-bb 11.04
- TS-04 SIGNAL ----- 20GA WHT/YLW 32P-H 11.04
- TS-04 COM ----- 20GA BROWN 32P-B 11.04
- FN-01 POS ----- 20GA RED/WHT 32P-W 11.04
- FN-01 NEG ----- 20GA BROWN 32P-ee 11.04
- FN-02 POS ----- 20GA WHT/ORG 32P-V 11.04
- FN-02 NEG ----- 20GA BROWN 32P-ff 11.04
- SW-04 SIGNAL ----- 20GA YLW/ORG 32P-U 11.04
- SW-04 COM ----- 20GA YELLOW 32P-P 11.04
- SW-05 SIGNAL ----- 20GA YLW/BLU 32P-dd 11.04
- SW-05 COM ----- 20GA YELLOW 32P-R 11.04
- TS-05 SIGNAL ----- 20GA WHT/GRN 32P-J 11.04
- TS-05 COM ----- 20GA BROWN 32P-hh 11.04
- TS-07 SIGNAL ----- 20GA WHT/VLT 32P-L 11.04
- TS-07 COM ----- 20GA BROWN 32P-D 11.04
- TS-06 SIGNAL ----- 20GA WHT/BLU 32P-K 11.04
- TS-06 COM ----- 20GA BROWN 32P-C 11.04
- TS-08 SIGNAL ----- 20GA WHT/GRY 32P-M 11.04
- TS-08 COM ----- 20GA BROWN 32P-E 11.04
- FN-03 POS ----- 20GA BLU/BLK 31P-07 13.04
- FN-03 NET ----- 20GA WHITE 31P-08 13.04
- FN-04 POS ----- 20GA BLU/BRN 31P-09 13.04
- FN-04 NET ----- 20GA WHITE 31P-10 13.04
- FN-05 POS ----- 20GA BLU/YLW 31P-11 13.04
- FN-05 NET ----- 20GA WHITE 31P-12 13.04
- FN-06 POS ----- 20GA BLU/GRN 31P-13 13.04
- FN-06 NET ----- 20GA WHITE 31P-14 13.04
- HT-01 POS ----- 12GA BLK/BRN 31P-E 13.04
- HT-01 NET ----- 12GA WHITE 31P-F 13.04
- HT-02 POS ----- 12GA BLK/ORG 31P-G 13.04
- HT-02 NET ----- 12GA WHITE 31P-H 13.04

2.0 4-DOOR STACKED
CABINET INTERIOR



DWG SIZE: B
DWG#: 00000000

7400 SOUTH 28th STREET FORT SMITH, AR 72908
PH. 800-642-2980 FAX. 479-646-5517

279 x 432 MM
DATE: 6/2/2022

NOTICE: THIS DRAWING IS THE PROPERTY OF QUALSERV SOLUTIONS INTERNATIONAL, INC. AND CONTAINS CONFIDENTIAL AND PROPRIETARY INFORMATION. NO PORTION OF THIS DRAWING MAY BE REPRODUCED OR COMMUNICATED WITHOUT EXPLICIT WRITTEN PERMISSION FROM QUALSERV SOLUTIONS, INC.

DRAWN BY: BDAVIDSON

PAGE: 09 OF 13 REV. 0

COMPRESSOR 1

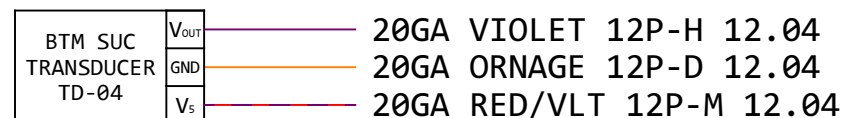
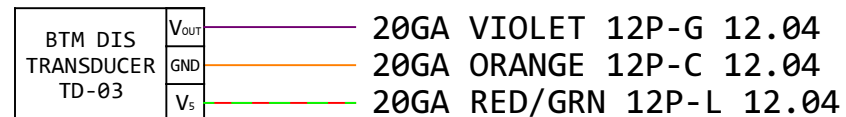
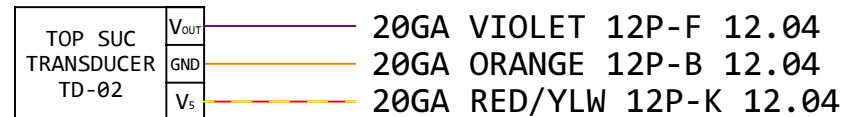
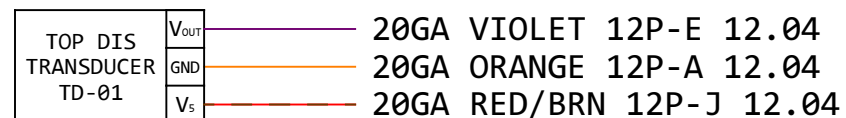
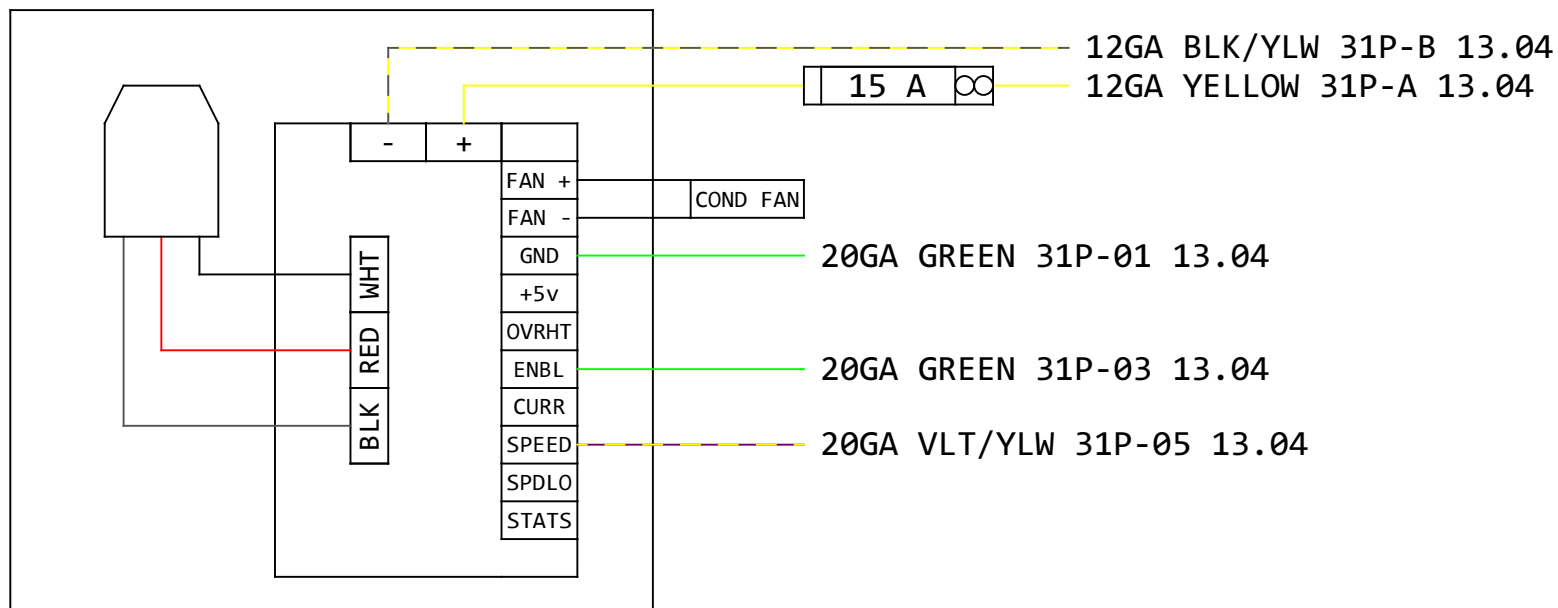

COMPRESSOR 2

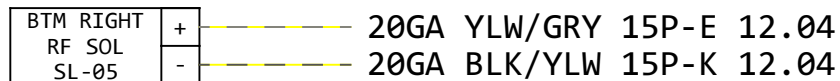
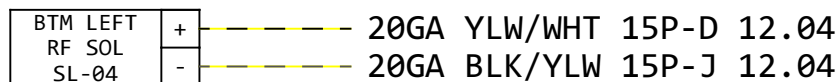
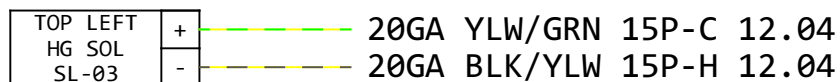
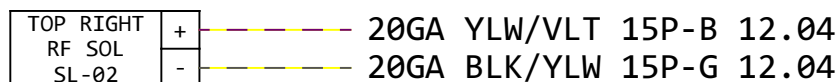
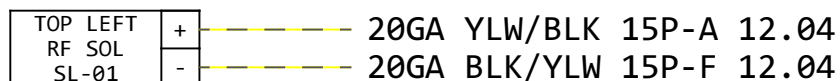
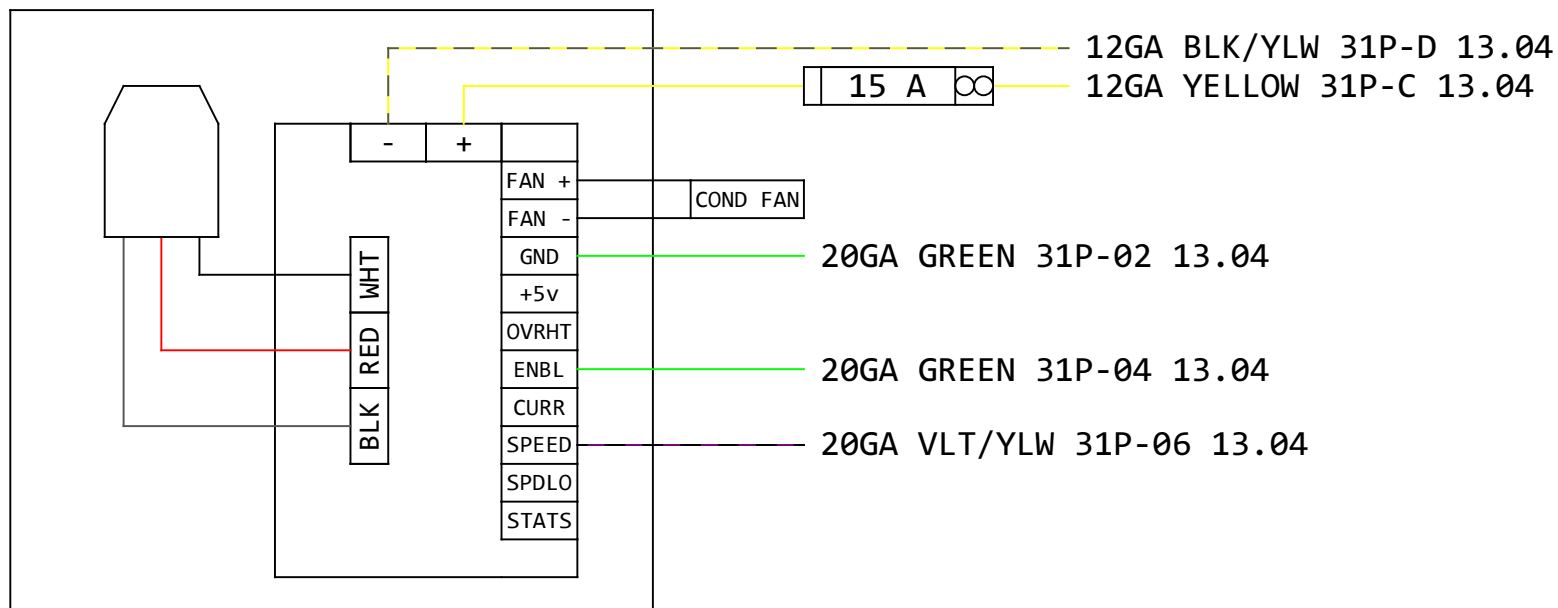

2.0 4-DOOR STACKED CABINET REAR EXTERIOR

QUALSERV SOLUTIONS INTERNATIONAL 7400 SOUTH 28th STREET FORT SMITH, AR 72908 PH. 800-642-2988 FAX. 479-646-5517	DWG SIZE: B	DWG#: 00000000
	279 x 432 MM	DATE: 6/2/2022
DRAWN BY: BDAVIDSON		
PAGE: 10 OF 13 REV. 0		

NOTICE: THIS DRAWING IS THE PROPERTY OF QUALSERV SOLUTIONS INTERNATIONAL, INC. AND CONTAINS CONFIDENTIAL AND PROPRIETARY INFORMATION. NO PORTION OF THIS DRAWING MAY BE REPRODUCED OR COMMUNICATED WITHOUT EXPLICIT WRITTEN PERMISSION FROM QUALSERV SOLUTIONS, INC.

20GA BROWN SN-01 09.07	aa
20GA BROWN SN-02 09.07	bb
20GA BROWN SN-03 09.07	A
20GA BROWN SN-04 09.07	B
20GA BROWN SN-05 09.07	hh
20GA BROWN SN-06 09.07	C
20GA BROWN SN-07 09.07	D
20GA BROWN SN-08 09.07	E
20GA WHT/BRN SN-01 09.07	F
20GA WHT/RED SN-02 09.07	G
20GA WHT/ORG SN-03 09.07	cc
20GA WHT/YLW SN-04 09.07	H
20GA WHT/GRN SN-05 09.07	J
20GA WHT/BLU SN-06 09.07	K
20GA WHT/VLT SN-07 09.07	L
20GA WHT/GRY SN-08 09.07	M
20GA YELLOW SW-02 09.07	N
20GA YELLOW SW-03 09.07	gg
20GA YELLOW SW-04 09.07	P
20GA YELLOW SW-05 09.07	R
20GA YLW/BRN SW-02 09.07	S
20GA YLW/RED SW-03 09.07	T
20GA YLW/ORG SW-04 09.07	U
20GA YLW/BLU SW-05 09.07	dd
20GA YELLOW FN-02 09.07	V
20GA RED/WHT FN-01 09.07	w
20GA BLK/YLW FN-02 09.07	ff
20GA BLK/YLW FN-01 09.07	ee
	1
	2
	3
	4

32-PIN CONNECTOR
4-DOOR STACKED SIGNAL CONNECTIONS

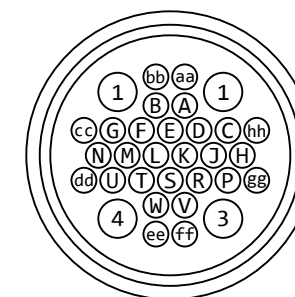

2.0 4-DOOR STACKED 32-PIN PLUG SCHEMATIC		
QUALSERV <small>SOLUTIONS INTERNATIONAL</small>	DWG SIZE: B	DWG#: 00000000
	7400 SOUTH 28th STREET FORT SMITH, AR 72908 PH. 800-642-2980 FAX. 479-646-5517	DATE: 6/2/2022
DRAWN BY: BDAVIDSON		
PAGE: 11 OF 13		REV. 0

NOTICE: THIS DRAWING IS THE PROPERTY OF QUALSERV SOLUTIONS INC. AND CONTAINS CONFIDENTIAL AND PROPRIETARY INFORMATION. NO PORTION OF THIS DRAWING MAY BE REPRODUCED OR COMMUNICATED WITHOUT EXPLICIT WRITTEN PERMISSION FROM QUALSERV SOLUTIONS INC.

20GA ORANGE	TD-01	10.06		A
20GA ORANGE	TD-02	10.06		B
20GA ORANGE	TD-03	10.06		C
20GA ORANGE	TD-04	10.06		D
20GA VIOLET	TD-01	10.06		E
20GA VIOLET	TD-02	10.06		F
20GA VIOLET	TD-03	10.06		G
20GA VIOLET	TD-04	10.06		H
20GA RED/BRN	TD-01	10.06		J
20GA RED/YLW	TD-02	10.06		K
20GA RED/GRN	TD-03	10.06		L
20GA RED/VLT	TD-04	10.06		M

12-PIN CONNECTOR
TRANSDUCER CONNECTIONS

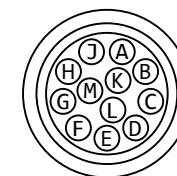

20GA YLW/BLK	SL-01	10.01		A
20GA YLW/VLT	SL-02	05.03		B
20GA YLW/GRN	SL-03	05.03		C
20GA YLW/WHT	SL-04	05.03		D
20GA YLW/GRY	SL-05	05.03		E
20GA BLK/YLW	SL-01	10.01		F
20GA BLK/YLW	SL-02	02.01		G
20GA BLK/YLW	SL-03	02.01		H
20GA BLK/YLW	SL-04	02.01		J
20GA BLK/YLW	SL-05	02.01		K
				L
				M
				N
				1
				2

15-PIN CONNECTOR
SOLENOID CONNECTIONS

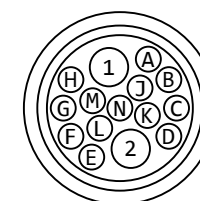

2.0 4-DOOR STACKED 12 & 15-PIN PLUG SCHEMATIC		
 <small>7400 SOUTH 28th STREET FORT SMITH, AR 72908 PH. 800-642-2980 FAX. 479-646-5517</small>	DWG SIZE: B	DWG#: 000000000
	279 x 432 MM	DATE: 6/2/2022
<small>NOTICE: THIS DRAWING IS THE PROPERTY OF QUALSERV SOLUTIONS INC. AND CONTAINS CONFIDENTIAL AND PROPRIETARY INFORMATION. NO PORTION OF THIS DRAWING MAY BE REPRODUCED OR COMMUNICATED WITHOUT EXPLICIT WRITTEN PERMISSION FROM QUALSERV SOLUTIONS INC.</small>		
DRAWN BY: BDAVIDSON		
PAGE: 12 OF 13		REV. 0

12GA YELLOW COMP1-POS	10.03	—	○	A
12GA BLK/YLW COMP1-NEG	10.03	- - -	○	B
12GA YELLOW COMP2-POS	10-03	—	○	C
12GA BLK/YLW COMP2-NEG	10.03	- - -	○	D
12GA BLK/BRN HT-01	09.07	—	○	E
12GA WHITE HT-01	09.07	—	○	F
12GA BLK/ORG HT-02	09.07	—	○	G
12GA WHITE HT-02	09.07	—	○	H
			○	I
			○	J
			○	K
			○	L
20GA GREEN COMP1-GND	10.02	—	○	1
20GA GREEN COMP2-GND	10.02	—	○	2
20GA GREEN COMP1-ENBL	10.02	—	○	3
20GA GREEN COMP2-ENBL	10.02	—	○	4
20GA VLT/YLW COMP1-SPEED	10.02	- - -	○	5
20GA VLT/WHT COMP2-SPEED	10.02	- - -	○	6
20GA BLU/BLK FN-03	09.07	—	○	7
20GA WHITE FN-03	09.07	—	○	8
20GA BLU/BRN FN-04	09.07	—	○	9
20GA WHITE FN-04	09.07	—	○	10
20GA BLU/YLW FN-05	09.07	- - -	○	11
20GA WHITE FN-05	09.07	—	○	12
20GA BLU/GRN FN-06	09.07	—	○	13
20GA WHITE FN-06	09.07	—	○	14
			○	15
			○	16
			○	17
			○	18
			○	19

31-PIN CONNECTOR
115V & COMPRESSOR DRIVER CONNECTIONS

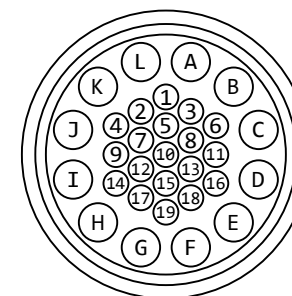

2.0 4-DOOR STACKED 31-PIN PLUG SCHEMATIC		
QUALSERV <small>SOLUTIONS INTERNATIONAL</small>	DWG SIZE: B	DWG#: 00000000
	7400 SOUTH 28th STREET FORT SMITH, AR 72908 PH. 800-642-2980 FAX. 479-646-5517	DATE: 6/2/2022
DRAWN BY: BDAVIDSON		
PAGE: 13 OF 13		REV. 0

NOTICE: THIS DRAWING IS THE PROPERTY OF QUALSERV SOLUTIONS INC. AND CONTAINS CONFIDENTIAL AND PROPRIETARY INFORMATION. NO PORTION OF THIS DRAWING MAY BE REPRODUCED OR COMMUNICATED WITHOUT EXPLICIT WRITTEN PERMISSION FROM QUALSERV SOLUTIONS INC.