



PTS-10T-3MA

**Operators
Manual**

Power Technology Southeast, Inc.
634 State Road #44 Leesburg, FL 34748-8103
◆ (352) 365-2777 ◆ Fax (352) 787-5545 ◆

FORWARD

You are now the proud owner of a Power Technology Generator powered by a Kubota engine. This engine is a product of Kubota's quality engineering and manufacturing. The engine is made with fine materials and manufactured under the strictest quality control standards and will assure you long satisfactory service. To obtain the best use of your engine, please read this manual carefully. It will help you become familiar with the operation of the engine and contains many helpful hints regarding engine maintenance. Continuing improvements and advancements in product design may have caused changes to your engine, which are not included in this manual.

Please contact Power Technology's Customer Service Department for latest information on your Kubota engine or for the number of your local Kubota dealer.

TO OUR CUSTOMERS

Thank you for your purchase of a Power Technology Generator. The information contained in this manual applies to PTS-10T-3 generators. Your generator was custom built to your specific requirements and may or may not be equipped with each of these options listed. Installation requirements will vary depending on your application; therefore Power Technology can only suggest general installation requirements. (See Installation Requirements in Section 3) Follow all Safety Instructions as outlined in Sections 1 and 3 of this manual. Other important Safety Precautions are posted through out the manual as well.

In the event you experience a problem with your generator please contact the sales dealer, one of our authorized service centers or Power Technology's Customer Service Department directly at 1-800-760-0027 from 8:00 a.m. to 5:00 p.m. EST. Please have the generator model and serial numbers available when you call. This will help expedite service and parts to you. Parts may be obtained directly through Power Technology and shipped the same day if ordered by 3:00 p.m. EST.

Generator Model Number _____

Generator Serial Number _____

POWER TECHNOLOGY SOUTHEAST, INC.

634 STATE RD. 44

LEESBURG, FL. 34748-8103

(352) 365-2777

FAX (352) 787-5545

www.PowerTech-Gen.com



Limited Warranty on Power Tech Generators

Power Technology Southeast, Inc. warrants to you, the original purchaser, that each product of our manufacture is free from defects in materials, and workmanship. That each generator will deliver its rated output as indicated on The Power Technology Nameplate, if properly installed, serviced, and operated under normal conditions in accordance with Power Technology's instructions.

THE WARRANTY COVERAGE TERMS:

2 years from date of purchase, or 3000 hours whichever comes first, or 36 months from the date of manufacture. Parts, and labor, including diagnostic labor, removal, and reinstallation are covered for the first 12 months from date in service or 1000 hours whichever comes first.

Parts and labor are covered only on the following generator and engine parts for 2 years or 3000 hours whichever comes first. Generator Parts: Main Rotor and Main Stator. Engine Parts: Cylinder Block, cylinder head, crankshaft, camshaft, cylinder head gears, connecting rods, flywheel and flywheel housing, intake and exhaust manifold (only if flexible connection is used).

- 3) Stand-by Units are covered for a period of 1 year from date of installation, or 1000 hours, or 24 months from the date of manufacture whichever comes first.
- 4) Replacement Parts are warranted: 30 days. (Excluding the following: voltage regulators, fuses, controllers, capacitors, brushes, and switches)

WHAT POWER TECHNOLOGY WILL DO:

Power Tech will at our option, repair or replace any part covered by this warranty which becomes defective, malfunctions or otherwise fails to conform to this warranty under normal use and service during the term of this warranty.

WHAT YOU MUST DO TO OBTAIN WARRANTY SERVICE:

In order to obtain warranty repairs you must deliver the product, together with proof of purchase to an authorized Power Tech service facility. In the case of repairs pertaining to the engine only, you must use an authorized dealer or distributor of that make of engine, to be covered under their warranty. Engines used in the manufacture of Power Tech products are warranted solely by the engine manufacturer.

PRIOR APPROVAL IS REQUIRED FOR ANY WARRANTY SERVICE

Failure to obtain authorization prior to the repair being performed will result in the claim being denied.

All claims must be submitted within 30 days of the repair. Along with the following: a copy of the original repair order, Power Tech authorization number, Power Tech serial number, and operation hours shown on the genset mounted hour meter.

THIS WARRANTY DOES NOT COVER THE FOLLOWING:

A. Normal wear items, including but not limited to: turbo-chargers, fuel injector (s), starter, alternator, and electronic components, as well as normal engine and/or generator wear. **A1.** Travel time and fuel charges to and from the repair facility or travel time and fuel charges for mobile service. (Except stationary units with a maximum of 2-hours travel time.) **B.** Defects, malfunctions or failure resulting from accidents, abuse, misuse, improper servicing, improper installation, improper storage, and lack of performance of required maintenance service. **C.** Products which have been subjected to alteration, modification, neglect or unauthorized repairs. **D.** Troubleshooting, routine service, tune-ups, replacement of filters, belts, coolant, lubricants, hoses, clamps, exhaust system components, fuel system components, gaskets and/or seals. **E.** Electrical items damaged by welding or jump-starting. **F.** Damage caused by water ingestion or electrolysis. **G.** Damage caused by ingestion of substances other than clean filtered air, fuel, or intake water. **H.** Damage caused by faulty repairs performed by a repair facility not authorized in writing by Power Tech. **I.** Damage caused by operation with improper fuel or at speeds, loads, conditions, modifications, or installation contrary to published specifications or recommendations. **J.** Original installation charges and startup costs. **K.** Removal and re-installation charges of more than 1-hour labor for outside units, 2-hours for compartment mounted units, and 3-hours for below deck marine units. Customer is responsible for additional labor/charges due to difficult access, removal or installation. **L.** Starting batteries and labor or charges related to battery service. **M.** Loss of revenue or the rental of equipment due to down time. **N.** Generator repairs made within the warranty period other than by an authorized Power Tech service dealer without prior written approval from Power Tech warranty department. **O.** Damage caused by negligent maintenance such as but not limited to: Failure to provide the specified type and quantity of lubricating oil, cooling air flow, and proper coolant mixture and level. Failure to provide adequate air intake/or maintenance of the air intake system. Failure to provide scheduled maintenance as prescribed in supplied manuals. **P.** Engine fluids such as fuel, oil or coolant/antifreeze. **Q.** Shop supplies such as adhesives, cleaning agents, rags, paint, or other miscellaneous supplies. **R.** Use of other than factory supplied or approved repair parts or procedures. Replacement of a failed Power Tech component with a non-Power Tech component voids the Power Tech warranty on that component and any and all failures related to that component. **S.** Fuel injection pumps repaired by anyone other than the factory authorized dealer or distributor of that engine. **T.** Expenses incurred investigating performance complaints unless defective Power Tech materials or workmanship are discovered. **U.** Generator sets used in rental applications. **V.** Cleaning, service, or repair of generator sets that have not been kept free of dirt, debris, or other items that prevent the unit from being able to operate properly. **W.** Any generator set not application approved. **X.** Loss of excitation due to prolonged storage. **Y.** Any damage attributed to low battery monitoring or automatic generator starting systems. **Z.** Optional accessories are warranted solely by the manufacturer of that item including but not limited to the following item: Block heaters, oil pan heaters, electric cooling fans, air-bag isolators, compartment heaters, fuel tanks, trailers, battery chargers, battery monitors.

To obtain warranty service: For your nearest Power Tech authorized service center, on the World Wide Web at: http://www.powertech-gen.com/parts_service.php

Call 1-352-365-2777 or write to Power Tech Warranty Department, P.O. Box 490133 Leesburg, FL 34749 USA.

Power Tech must be notified in writing within five (5) business days of any product failure.

General Conditions:

This Warranty is the sole property of the original owner /user.

A transfer of ownership shall terminate this Warranty.

This Warranty is only valid within the contiguous United States and Canada.

Warranty coverage is available outside the U.S. and Canada; please speak to a factory representative for those details.

This Warranty does not cover any products or parts not purchased from Power Technology.

Power Technology reserves the right to make design improvements and model changes without any obligation to change units or parts previously manufactured.

Warranty registration card must be completed and mailed to Power Tech at the above address to validate the Warranty.

This is the only express warranty on Power Tech products

No person, agent, or dealer is authorized to give any Warranties on behalf of Power Technology Southeast, Inc., and not to assume for Power Technology Southeast, Inc. any other liability in connection with any of its products unless made in writing and signed by an officer of Power Technology Southeast, Inc.

LIMITATIONS ON OUR RESPONSIBILITY WITH RESPECT TO PRODUCTS PURCHASED AND USED FOR PERSONAL, FAMILY OR HOUSEHOLD USE:

Our responsibility is to repair or replace defective parts as stated above. We will not be responsible for any other expenses, losses or inconvenience which you may Sustain as a result of the purchase, use, malfunction or defective condition of our products. **ANY IMPLIED WARRANTIES, INCLUDING WARRANTIES OF MERCHANTABILITY OR FITNESS FOR A PARTICULAR PURPOSE SHALL BE LIMITED IN DURATION TO THE PERIOD SET FORTH ABOVE.**

Some states do not allow limitations on how long an implied Warranty lasts or the exclusion or limitation of incidental or consequential damages, so the above

Limitations or exclusions may not apply to you. This Warranty gives you specific legal rights and you may have other rights which vary from state to state.

This Warranty is in lieu of all other Warranties, expressed or implied and of any other obligations or liability on our part.

Our responsibility for any and all losses and **IN NO EVENT WILL WE BE LIABLE FOR LOSS OF USE, LOSS OF PROFITS, INCONVIENCE, COMMERCIAL LOSS OR OTHER INCIDENTAL OR CONSEQUENTIAL DAMAGES WHATSOEVER.**

POWER TECHNOLOGY SOUTHEAST, INC.
Export Warranty on All Power Technology Products

The Power Technology standard commercial warranty shall be modified as follows for all sales and delivery of products outside of the United States and Canada.

The terms of the warranty shall be for a period of 12 months from the delivery to the first retail user.

Dealer shelf life shall be 6 months from date of shipment. In no case shall the warranty period exceed 18 months from date of shipment.

Warranty shall cover defected materials and workmanship for the above time period. Power Technology shall supply replacement parts at no charge. The customer shall be responsible for all transportation costs, import duties, legal documents including but not limited to import licenses, customs declaration or inspection services.

In all cases if local warranty services are available through manufacturers representation, manufacturers' standard warranty shall supersede Power Technology's warranty and any warranty or parts and labor shall be that of the manufacturer. The terms and conditions of the manufacturer warranty shall be those offered by the manufacturer for the country or region covered by the manufacturers' representative.

TABLE of CONTENTS

<u>SECTION 1:</u>		<u>“SAFETY”</u>	
SAFE OPERATION _____			1-4
 <u>SECTION 2:</u>		 <u>“ENGINE”</u>	
PRE-OPERATION CHECK _____			1
OPERATING INSTRUCTIONS for SUB-ZERO CONDITIONS _____			2-3
OPERATING THE ENGINE ES-52 CONTROLLED _____			4
ENGINE SPECIFICATIONS _____			5
ENGINE POWER FACTORS _____			6-7
ENGINE MAINTENANCE SERVICE SCHEDULE _____			8
ENGINE OIL MAINTENANCE _____			9
ENGINE COOLANT MAINTENANCE _____			10
OPERATING HOURS AND SERVICE LOG _____			11
ENGINE TROUBLESHOOTING GUIDES _____			12-14
 <u>SECTION 3:</u>		 <u>“GENERATOR END”</u>	
SAFETY PRECAUTIONS _____			1-2
INSTALLATION REQUIREMENTS & RECOMMENDATIONS _____			3
GENERATOR ASSEMBLY INFORMATION _____			4-5
ENGINE and GENERATOR DIAGRAM _____			6
SECTION A: GENERATOR _____			1-19
SECTION B: VOLTAGE REGULATORS and ENGINE CONTROLLER _____			1-9
SECTION C: WIRING SCHEMATIC _____			1-19
SECTION D: GENERATOR END TROUBLESHOOTING _____			1-3

SECTION 1 “SAFETY”

SAFE OPERATION

1-4

Observe Safety Instructions
Wear Safety Clothing
Check Before Operating the Engine
Keep Area Around the Engine Clean
Safe Handling of Fuel and Lubricants
Exhaust Gases and Fire Prevention
Escaping Fluids
Cautions Against Burns and Battery Explosion
Keep Hands and Body Away From Rotating Parts
Anti-Freeze and Disposal of Fluids
Conducting Safety Checks and Maintenance



This symbol, the industry’s “Safety Alert Symbol”, is used throughout this manual and on labels attached the machine itself. It warns of the potential for personal injury. It is essential that you carefully read the instructions and safety regulations before you attempt to assemble or use this unit.

 **WARNING:** Indicates a potentially hazardous situation, which may possibly result in serious injury or possible death.

 **CAUTION:** Indicates a potentially hazardous situation, which may possibly result in minor injury.

IMPORTANT: Indicates that equipment or property damage may result if instructions are not followed.

NOTE: Indicates helpful information.

SAFE OPERATION

Cautious operation is your best insurance against an accident. Read and understand this section carefully before operating the engine. All operators, no matter how knowledgeable they may be, should read this and other related manuals before operating the engine or any equipment attached to it. It is the owner's responsibility to instruct all operators in safe operation. Be sure to observe the following for safe operation.

OBSERVE SAFETY INSTRUCTIONS

- Read, understand and follow this “OPERATORS MANUAL” and “LABELS ON THE ENGINE” before starting and operating the engine.
- Learn how to operate and work safely. Know your equipment and its limitations. Always keep the engine in good condition.
- Before allowing other people to use your engine, explain how to operate and have them read this manual before operation.
- DO NOT modify the engine. UNAUTHORIZED MODIFICATIONS to the engine may impair the function and/or safety and affect engine life.

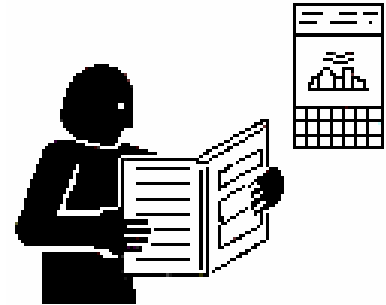

WEAR SAFETY CLOTHING

- DO NOT wear loose, torn or bulky clothing around machinery. Entanglement in rotating parts, controls or projections may cause personal injury.
- Use additional safety items, e.g. hardhat, eye protection, gloves, etc., as appropriate or required.
- DO NOT operate machinery or equipment while under the influence of alcohol, medication, or other drugs, or while fatigued.
- DO NOT wear radio or music headphones while operating engine.



CHECK BEFORE OPERATING THE ENGINE

- If the engine is malfunctioning DO NOT operate until repairs are made.
- Be sure all guards and shields are in place before operating the engine. Replace any that are damaged or missing.
- Check to see that the area around the engine is clear of foreign objects before starting.
- Always keep the engine at least 3 feet (1 meter) away from buildings or other facilities.
- DO NOT allow children or livestock to approach the machine while in operation.
- DO NOT start the engine by shorting across starter terminals.

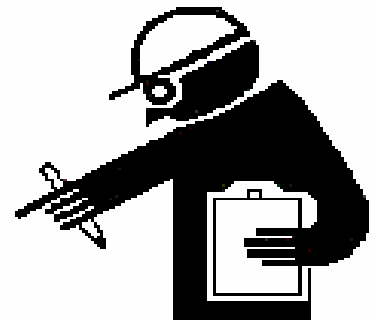

KEEP AREA AROUND THE ENGINE CLEAN

- Be sure to stop the engine before cleaning.
- Keep the engine clean and free of accumulated dirt, grease and trash.
- DO NOT stop the engine without idling; Temperatures around the engine rises suddenly. Keep the engine idling for about 5 minutes before stopping.



SAFE HANDLING OF FUEL AND LUBRICANTS

- Always stop the engine before refueling or lubricating.
- DO NOT smoke or allow flames or sparks in your working area. Fuel is extremely flammable and explosive. Never store flammable liquids in the engine compartment.
- Refuel at a well-ventilated and open place. If fuel or lubricants spill, clean up immediately and properly dispose of.
- DO NOT mix gasoline or alcohol with diesel fuel. The mixture can cause a fire.



EXHAUST GASES AND FIRE PREVENTION

- Engine exhaust fumes can be very harmful if allowed to accumulate. Be sure to run the engine in a well-ventilated area where there are no people or livestock near by.
- The exhaust gas from the muffler is very hot. To prevent a fire, do not expose dry grass, oil or any other combustible materials to exhaust gas. Keep the engine and mufflers clean all the time.
- To avoid a fire, be alert for leaks of flammables from hoses and lines. Be sure to check for leaks from hoses and pipes, such as fuel and hydraulic by following the maintenance check list.
- To avoid a fire, do not short across power cables and wires. Check to see that all power cables and wires are in good condition. Keep all power connections clean. Bare wire or frayed insulation can cause a dangerous electrical shock and personal injury.

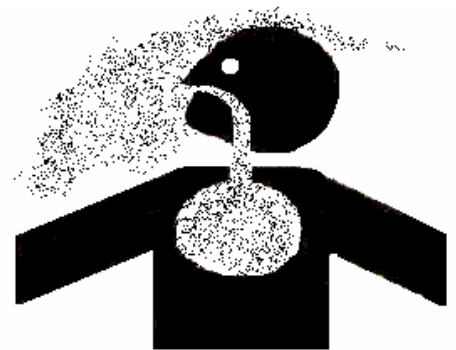

CALIFORNIA *Proposition 65 Warning*

Diesel Engine Exhaust and some
of it's constituents are known by the
State of California
to cause
Cancer, Birth Defects and Other
Reproductive harm.

ESCAPING FLUIDS

- Relieve all pressure in the air, oil and cooling systems before any lines, fittings or related items are removed or disconnected.
- Be alert for possible pressure release when disconnecting any dev from a system that is pressurized. DO NOT check for pressure leaks with your hands. High-pressure oil or fuel can cause personal injury.
- Escaping hydraulic fluid under pressure has sufficient force to penetrate skin causing serious personal injury.
- Fluid escaping from pinholes may be invisible. Use a piece of cardboard or wood to search for suspected leaks: do not use hands and body. Use safety goggles or other eye protection when checking for leaks.
- If injured by escaping fluid, see a medical doctor immediately. This fluid can produce gangrene or severe allergic reaction.

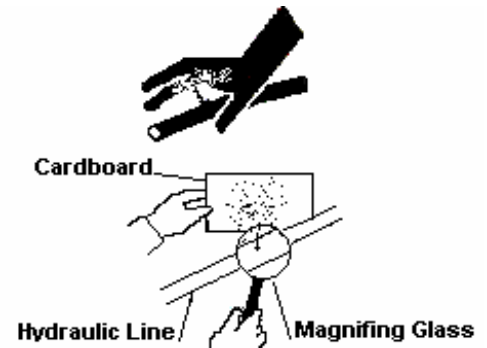

CAUTIONS AGAINST BURNS AND BATTERY EXPLOSION

- To avoid burns, be alert for hot components during operation and just after the engine has been shut off. Such as the muffler, muffler cover, radiator, piping, engine body, coolants, engine oil, etc.
- DO NOT remove the radiator cap while the engine is running or immediately after stopping. Wait approximately ten minutes for the radiator to cool before removing the cap.
- Be sure the radiator drain valve / petcock and hose clamps are tighten. Check radiator pressure cap and oil fill cap before operating the engine.
- The battery presents an explosive hazard. When the battery is being activated, hydrogen and oxygen gases are extremely explosive.
- Keep sparks and open flames away from the battery, especially during charging. DO NOT strike a match near the battery.
- DO NOT check a batteries charge by placing a metal object across the terminals. Use a voltmeter or hydrometer.
- DO NOT charge a battery if frozen, it may possibly explode. Frozen batteries must be warm up to at least 61°F (16°C) before charging.

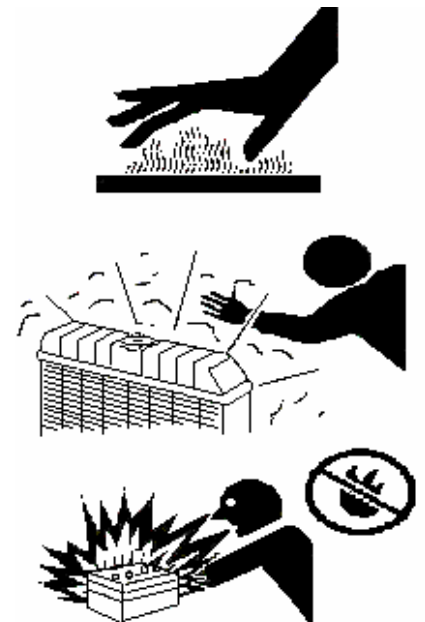

KEEP HANDS AND BODY AWAY FROM ROTATING PARTS

- Keep your hands and body away from all rotating parts, such as cooling fan, v-belts, pulleys and flywheel. Contact with these rotating parts can cause serious personal injury.
- Be sure to stop the engine before adjusting belt tension or checking the cooling fan.
- DO NOT run the engine without safety guards installed. Be sure the safety guards are properly aligned and securely fastened before operating the engine.

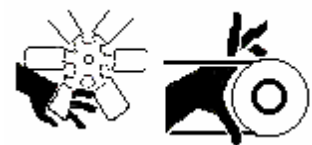

ANTI-FREEZE AND DISPOSAL OF FLUIDS

- Anti-freeze contains toxic chemicals. Wear rubber gloves when handling anti-freeze. In case of contact with skin, wash immediately to avoid personal injury.
- DO NOT mix different types of Anti-freeze. The mixture can produce a chemical reaction resulting in the formation of harmful substances. Only use anti-freeze that is recommended and approved by Caterpillar.
- Be mindful of the environment. Before draining any fluids, be prepared to dispose of them in a manner consistent with environmental protection regulations in your location.
- When draining fluids from the engine, use appropriate containers to hold the different fluids, do not mix fuel, oil or coolant together.
- Dispose of spent filter cartridges and batteries properly.
- DO NOT pollute the soil, or any water source. Never pour fluids down a drain.



CONDUCTING SAFETY CHECKS AND MAINTENANCE

- When performing safety checks or engine service, be sure the engine is level and well supported. Use approved stands designed for this type of service. DO NOT service an engine that is only supported by a lift jack or hoist.
- Detach the battery from the engine before conducting service. Put a “DO NOT OPERATE!” tag in the key switch to avoid accidental starting.
- To avoid sparks from an accidental short circuit always disconnect the 24 V DC power at the battery.
- Be sure to stop the engine and remove the key when conducting daily and periodic maintenance, servicing and cleaning.
- Check or conduct maintenance after the engine, radiator, muffler, or muffler cover has cooled off completely.
- Always use the appropriate tools and jig-fixtured when performing any service work. Be sure to understand and follow the instructions included with these tools.
- Use ONLY correct engine barring techniques for manually rotating the engine. DO NOT attempt to rotate the engine by pulling or prying on the cooling fan and V-belt. Serious personal injury or damage to the cooling fan may occur.
- Replace fuel hoses and hose clamps every 2 years or earlier whether they are damaged or not. They are made of rubber and are aged gradually.
- When service is performed with two or more people present, take care to perform all work safely. Be aware of their location especially when starting the engine.
- Keep a first aid kit and fire extinguisher handy at all times.

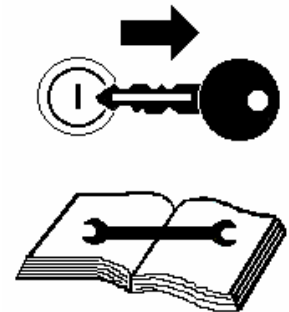

SECTION 2

“ENGINE”

PRE-OPERATION CHECK _____	1
Engine Break-in Period	
Daily Check	
OPERATING INSTRUCTIONS for SUB-ZERO CONDITIONS _____	2-3
Coolant System	
Lubricating System	
Fuel System	
Electrical System	
OPERATING THE ENGINE	
ES-52 CONTROLLED _____	4
Engine Starting Controls	
Check Engine After Starting	
Stopping the Engine	
ENGINE SPECIFICATIONS _____	5
Kubota Model's D-1105-T-E3B2	
Service Parts	
ENGINE POWER FACTORS _____	6-7
Power De-rating with Reduced Fuel for High Altitudes	
Atmospheric Pressure vs. Altitude	
Atmospheric Temperature & Humidity Power Lose	
Atmospheric Factors Chart	
Accessory Power Requirements	
ENGINE MAINTENANCE SERVICE SCHEDULE _____	8
ENGINE OIL MAINTENANCE _____	9
Checking Engine Oil Level	
Lubricating Oil Specifications	
Engine Refill Capacities	
Lubricating Oil Viscosity Recommendations	
ENGINE COOLANT MAINTENANCE _____	10
Coolant Recommendations	
Ethylene Glycol / Propylene Glycol	
Checking Radiator Coolant Level	
Coolant Service Life	
Checking Reservoir Tank Coolant Level	
Cleaning Radiator Core	
OPERATING HOURS AND SERVICE LOG _____	11
ENGINE TROUBLESHOOTING GUIDES _____	12-14
Engine Starts but Won't Run	
Engine Runs Rough or Slow	
Engine Will Not Start	

PRE-OPERATION CHECK

ENGINE BREAK-IN PERIOD

During the engine break-in period, observe the following recommendations:

1. Change the engine oil and oil filter cartridge after the first 50 hours of operation. (See “ENGINE OIL” in ENGINE MAINTENANCE SERVICE SCHEDULE).
2. In ambient temperature above 32°F (0°C) approximately 3-5 minutes without a load is sufficient for engine warm up. Allow additional warm up time when temperatures are below 32°F (0°C) before placing an operating load on the engine.

DAILY CHECK

To prevent future engine problems from occurring, it is important to know and keep track of the engines condition. Below are items to be Inspected and Checked on a daily basis.

CAUTION:

To avoid personal injury:

- Be sure all safety shields and guards are attached to the engine when operating.
 - To prevent a fire hazard, keep foreign materials, fuel and oil away from the battery, wiring, muffler and engine. Check and clear them daily. Be aware of the muffler and exhaust gas heat underneath the engine compartment, this heat may ignite grass or other flammable materials.
 - Follow all safety precautions as outlined in the “SAFE OPERATION” section.
1. For accurate readings the engine should be on level ground when checking engine fluids.
 2. Check fluids before starting the engine. (Cold Engine)
 - Lubrication System: Check Engine oil level
Check for Engine oil leaks
 - Cooling System: Check coolant level and condition
Check for coolant leaks
Check for proper installation of the radiator cap
 - Fuel System: Check for sufficient quantity of fuel
Check for fuel leaks
 3. Check engine after starting. (Warm Engine)
 - Proper Operation: Check for easy engine start
Check for fluid leaks
Check for abnormal engine noises
Check for abnormal exhaust gas

OPERATING INSTRUCTIONS for SUB-ZERO CONDITIONS

To operate a Power Technology Stand-By Generator System in sub-zero climates, advanced preparations to the Coolant System, Lubricating System, and Fuel System are essential. Start-up and Operating Procedures also require special consideration. The following is a list of procedures which Power Technology highly recommends before operating a Stand-By Generator System under extreme cold conditions.

COOLANT SYSTEM

Perform a visual inspection of the coolant system components and connections for signs of leakage, repair or replace as needed. Completely drain coolant from the system into a container for proper disposal. Flush system with clean water or use a commercially available radiator flush if necessary to remove deposits. Excessive build-up may require professional cleaning by a radiator shop. Also remember to clean away dirt and debris from the outside of the radiator. Use running water to clean dirt particles from between the fins. Never use a hard object to clean the radiator core.

Extreme cold will cause rubber products to become hard and brittle. Inspect hoses and belts for signs of cracking and wear, replace as needed.

To refill the coolant system, premix a 50/50 solution of Ethylene Glycol and distilled water. Following the Engine Manufacturers Manual fill the system to the recommended level and test run the engine to purge any trapped air. Recheck the coolant level and top off as needed.

NOTE: Use a Spectrometer to test and confirm the proper protection level of the coolant solution. A Hydrometer tester may be unreliable and should not be used.

Optional Coolant System Heater: Installing a coolant heater in a Stand-By Generator System will facilitate cold climate starting. These heaters are available in several configurations, including size, supply voltage and output wattage. Operating on the Thermosiphoning principle the coolant heater draws cold coolant from the lower engine block, heats the coolant, which rises and returns to the top of the engine thus circulating heated coolant throughout the engine. Coolant heaters are available in several thermostatically regulated ranges, also the heating element is protected by an overheat thermostat. To turn the coolant heater ON or OFF it may be wired into an oil pressure switch, which will turn OFF the heater when the engine starts and maintains oil pressure and back ON when the engine stops and oil pressure drops.

LUBRICATING SYSTEM

When operating a Stand-By Generator System in a sub-zero environment adhering to the Engine Oil Maintenance Schedule is crucial. Using the proper Viscosity and Grade of motor oil is extremely important as is installing an oil filter approved by the Engine Manufacturer. Incorrect oil viscosity and inferior grade filters may restrict oil flow through the engine during extreme cold conditions causing harmful wear to internal engine components.

Use high quality Multi-Viscosity oil, which meets or exceeds API specifications CD/CE or CF4. For temperatures (–20°C) 4°F and above use 5W-30 viscosity. For temperatures (–20°C) 4°F and below use 5W-20 viscosity.

FUEL SYSTEM

In temperate climatic conditions Diesel engines perform well using ASTM-2-D (No.2 Diesel Fuel). However, when temperatures drop below (0°C) 32°F it will be necessary to use ASTM-1-D (No.1 Diesel Fuel). Either type should exceed a minimum Cetane number of 45.

In extreme cold conditions with temperatures in the (-30°C) -22°F range it may be necessary to use Jet Fuel or No.1 Kerosene to start the engine.

ELECTRICAL SYSTEM

The electrical components must be able to endure the extra demand of sub-zero conditions and be capable of delivering the necessary power to start the engine. A well maintained and fully charged battery is essential. At temperatures above (0°C) 32°F the Battery must be capable of delivering a minimum of 675 CCA (Cold Cranking Amps). At temperatures below (0°C) 32°F the Battery must be capable of delivering a minimum of 1450 CCA.

Optional Air Intake Heater: Installing an air intake heater in a Stand-By Generator System will facilitate cold climate starting. The air intake heater consists of 3 glow plugs mounted just ahead of the air intake manifold. When activated during the starting cycle the air entering the engine is preheated, which helps the engine to start easier. Once started allow additional warm-up time for the engine to reach normal operating temperature before placing the generator into operation.

IMPORTANT: Never use Ether or other starting fluids to start a Diesel engine. Severe damage to the engine may occur.

OPERATING THE ENGINE

ES-52 CONTROLLED

ENGINE STARTING CONTROLS

- 1) Generator Main Switch must be in the ON position.
- 2) Toggle the Start/Stop Switch to the Start position.
- 3) Glow Plugs will preheat for 8 seconds. LED flashes slowly.
- 4) Preheating will cease during engine cranking cycle. LED continues flashing.
- 5) Engine begins an 8 seconds crank cycle, After 4 seconds of cranking the ES-52 will check for an AC signal from the generator. If an AC signal is verified the engine will start and the LED will remain ON during the normal run operation. If the AC signal is not verified the ES-52 will terminate the cranking cycle and LED will flash a fault code.
- 6) Starter disengages immediately after engine run is verified.
- 7) ES-52 deactivates the Low Oil Pressure and High Water Temperature Switches for 6 seconds, this will assure oil pressure build-up time. If oil pressure does not build-up the engine will immediately shut down and go into a fault mode. Likewise for a high temperature situation.
- 8) If engine will not start on the first attempt the ES-52 will initiate the start cycle 2 more times before going into a fault mode. Glow Plugs will preheat for 8 seconds per attempt. Engine will crank for 8 seconds per attempt.
- 9) To shut down the engine under normal operations, toggle the Start/Stop Switch to the Stop position.
- 10) If a fault occurs turn Generator Main Switch OFF and then ON to reset ES-52.

CHECKING ENGINE AFTER STARTING

- 1) Allow the engine to warm up 3 to 5 minutes before applying a load. In colder climates allow a few extra minutes longer.
- 2) Perform a visual inspection of all areas of the engine and generator.
- 3) Listen for any abnormal noises.
- 4) Check for any abnormal exhaust gases.

STOPPING THE ENGINE

It is recommended to disconnect or reduce the power load from the generator before shutting down the engine. Then follow the steps outlined above for normal shut down.

IMPORTANT: Damage to the Starter Motor, Starter Solenoid, Run Solenoid or any generator component due to excessive or prolonged starting attempts attributed to an external Low Battery Control Monitoring or Auto-Start System will not be covered by the Power Technology Southeast, Inc. Limited Warranty.

ENGINE SPECIFICATIONS

<u>MODEL</u>	<u>Kubota D-1105-T-E3B2</u>
Continuous Output	17HP/12.5KW @ 1800 rpm
Cubic Capacity	68.53in ³ (1.123.L)
Bore and Stroke	3.07” x 3.09” (78.0 x 78.4mm)
Cylinder Arrangement	3 In-Line
Firing Order	1-2-3
Compression Ratio	22:1
Engine Oil Capacity	5.38qts. (5.1L)
Coolant Capacity	3.27qts. (3.1L)
Fuel and Type	Diesel No. 2-D 4 Cycle

SERVICE PARTS

Power Technology Part

Filters:

Oil ----- 01FOS
Fuel ----- 08FF081
Air ----- 04FA2SE1

Belts:

With Alternator or Idler Pulley-----03BF1305

Thermostat-----03THM0305NEW

ENGINE POWER FACTORS

ALTITUDE POWER LOSS FACTORS

High altitudes can cause sizeable losses or reductions in available power. The exact amount of loss can be difficult to estimate, because these losses vary with the type of engine. Generally, two stroke engines lose more power than four stroke engines, and turbocharged or supercharged engines lose less power than naturally aspirated engines.

Naturally aspirated 4-cycle engines will lose roughly 3% power per 1000 feet in altitude rise. Therefore, an engine producing 100 HP at sea level will produce approximately 91 HP at 3000 feet elevation.

POWER DE-RATING WITH REDUCED FUEL FOR HIGH ALTITUDES

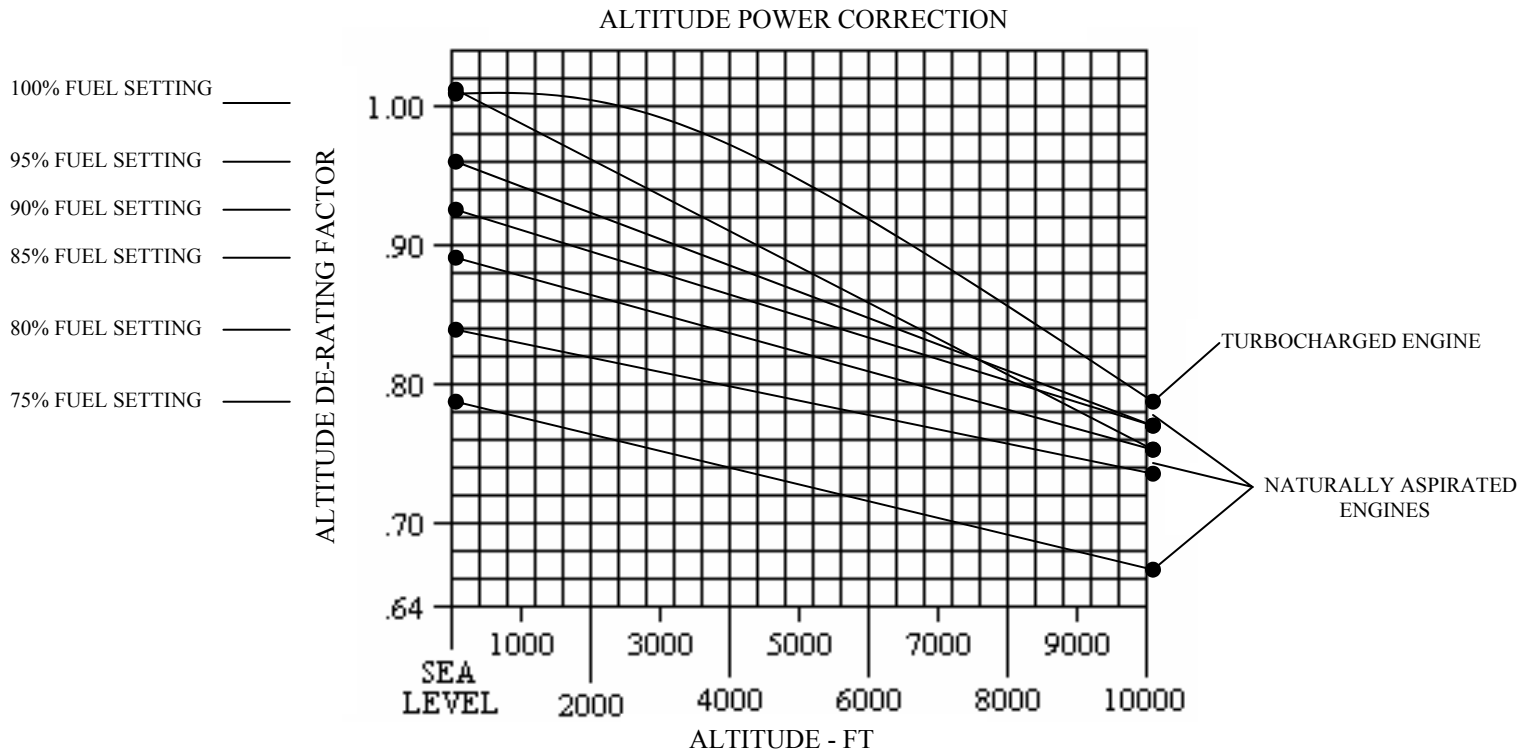

ATMOSPHERIC PRESSURE vs ALTITUDE

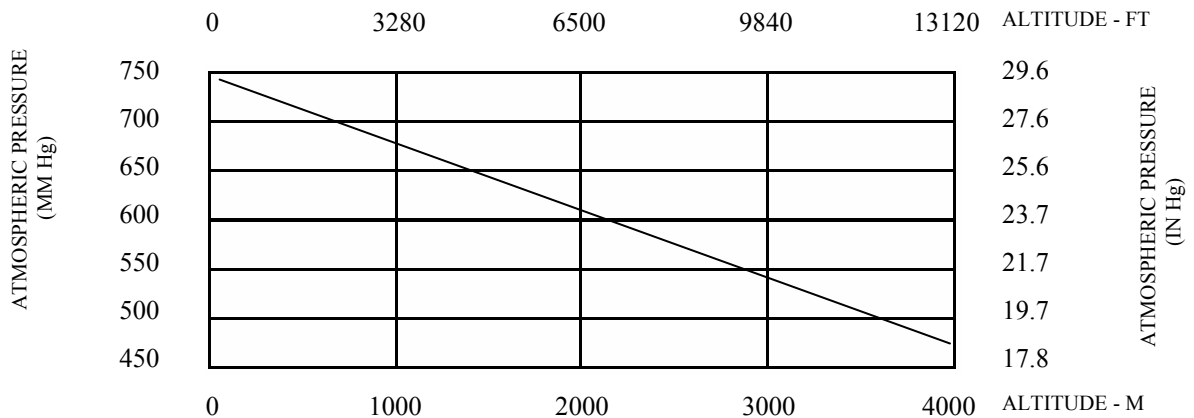

ATMOSPHERIC TEMPERATURE & HUMIDITY POWER LOSSES

These losses are generally considered to be nominal with values seldom exceeding 5%. Natural atmospheric variations, however, can combine causing nearly 20% de-rating. For example, air of 120°F (50°C) at 100% humidity. Even 100°F (40°C) temperature at 90% to 100% humidity will cause a 10% de-rating. The local and/or field operating conditions must be evaluated and the power de-rated from SAE J-1349 per these factors.

ATMOSPHERIC FACTORS CHART POWER AVAILABLE DUE TO TEMPERATURE AND HUMIDITY VARIATIONS

TEMPERATURE		RELATIVE HUMIDITY							
°C	°F	30%	40%	50%	60%	70%	80%	90%	100%
25	77	1.000	.997	.992	.990	.984	.980	.977	.973
30	86	.985	.980	.973	.969	.964	.957	.954	.949
35	95	.966	.960	.953	.947	.940	.934	.928	.920
40	104	.948	.940	.931	.924	.915	.907	.899	.892
45	113	.928	.919	.907	.897	.886	.878	.867	.855
50	122	.910	.895	.882	.869	.854	.841	.830	.815

ACCESSORY POWER REQUIREMENTS

Additional power deductions should be made for any accessories that are installed. These deductions are necessary to accurately identify the expected net power available for the prime power requirement. The accessory items are variable for each installation / application, and can't be determined or deducted by the engine manufacturer. The following accessories are typical in a Stand-By Generator application.

- Auxiliary Alternator / Generator End
- Engine Alternator
- Drive Belts and Pulleys
- Cooling Fan

Engine Maintenance Service Schedule

Maintenance Service Item	*See Note	Daily	Min. Every 25 Hours	Every 100 Hours	Every 250 Hours	Every 500 Hours	Every 1000 Hours	Remarks
Engine Oil Level Deterioration & Leakage		X						
Engine Oil Change	*			X				Or Once a Year
Oil Filter Change				X				Or Once a Year
Coolant Level		X						
Coolant Leakage		X						
Coolant Change							X	Or Once a Year
Fuel Level		X						As Necessary
Fuel Leakage		X						
Fuel Filter Replacement						X		Or Once a Year
Air Filter Replacement	**					X		Or Once a Year
Damaged Worn Or Loose Belts		X						Or Every Two Years
Replace Fuel Hoses							X	Or Every Two Years
Check Radiator Hoses & Clamps						X		Once a Year
Abnormal Engine Noise		X						
Abnormal Generator Noise		X						
Muffler Condition		X						
Exhaust Gas Condition		X						

* Engine oil and filter must be changed after the first 50 hours of operation. Then every 100 hours or once a year whichever comes first.

** Air filter replacement interval will vary depending on operating conditions. Adverse conditions may require frequent service.

NOTE: Under normal operation items such as Belts, Hoses and Filters are not covered by Power Technology Southeast, Inc. Limited Warranty.

ENGINE OIL MAINTENANCE

CHECKING ENGINE OIL LEVEL

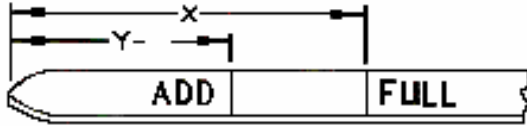

(Y) “ADD” mark. (X) “FULL” mark.

1. Maintain the engine oil level between “ADD” mark and “FULL” mark on oil level gauge. Do not fill crankcase above “FULL” mark.

2. Remove the oil filler cap and add oil, if necessary. Clean the oil filler cap. Install the oil filler cap.

The refill capacities for the engine crankcase reflect the approximate capacity of the crankcase or sump plus a standard oil filter. Auxiliary oil filter systems will require additional oil.

LUBRICATING OIL SPECIFICATION

Use only good quality lubricating oil, which meets or exceeds of the following Specification

API-CD
or
Higher

KUBOTA ENGINE REFILL CAPACITIES

D-1105-T-E3B2
Crankcase Oil Sump and Filter 5.38Qts. (5.1L)

LUBRICATING OIL VISCOSITY RECOMMENDATIONS

The minimum ambient temperature during cold engine start-up and the maximum ambient temperature during engine operation determine the proper SAE viscosity grade of oil.

Refer to the Engine Oil Viscosity Table below (Minimum Temperature) in order to determine the required oil viscosity for starting an engine in cold conditions.

Refer to the Engine Oil Viscosity Table below (Maximum Temperature) in order to select the oil viscosity for engine operation at the highest ambient temperature that is anticipated.

Ambient Temperature	Oil Viscosity
Above 25°C (77°F)	SAE 10W-30 SAE 30 or SAE 10W-40
0 to 25°C (32° to 77°F)	SAE 10W-30 SAE 20 or SAE10W-40
Below 0°C (32°F)	SAE 10W-30 SAE 10W or SAE 10W-40

ENGINE COOLANT MAINTENANCE

COOLANT RECOMMENDATIONS

For optimum performance, Power Technology recommends a 1:1 mixture of water / glycol.

NOTE: Use a mixture that will provide protection against the lowest ambient temperature.

NOTE: 100 percent pure glycol will freeze at a temperature of -23°C (-9°F).

Most conventional heavy-duty coolant / antifreezes use Ethylene Glycol. Propylene Glycol may also be used in a 1:1 mixture with water. Ethylene and Propylene Glycol provide similar protection against freezing and boiling. See the tables below.

ETHYLENE GLYCOL

	Freeze	Boil
<u>Concentration</u>	<u>Protection</u>	<u>Protection</u>
50 Percent	-36°C (-33°F)	106°C (223°F)
60 Percent	-51°C (-60°F)	111°C (232°F)

NOTE: Do not use Propylene Glycol. Use Ethylene Glycol in conditions that require additional protection against boiling or freezing.

CHECKING RADIATOR COOLANT LEVEL

Remove the radiator cap after the engine has completely cooled and check to see that coolant reaches the supply port.

1. Fill to the bottom of the fill neck and check after every 25 hours of operation.

COOLANT SERVICE LIFE

<u>Coolant Type</u>	<u>Service Life</u>
Commercial Heavy-Duty Coolant/Antifreeze that Meets “ASTM D5345”	3000 Service Hours or Two Years
Commercial Heavy-Duty Coolant/Antifreeze that Meets “ASTM D4985”	3000 Service Hours or One Year

NOTE: Do not use a commercial coolant/antifreeze that only meets the ASTM D3306 or D4656 specification. This type of coolant/antifreeze is made for light duty automotive applications.

CHECKING RESERVOIR TANK COOLANT LEVEL

(At a Minimum of 25 Hours of Operation)
Ensure that the coolant level of the radiator reservoir tank is between the upper limit (FULL) and the lower limit (LOW) on the side of the reservoir tank.

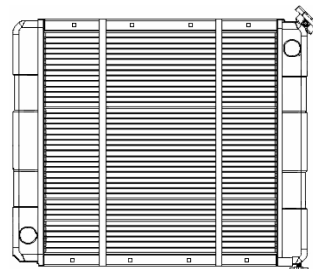

CLEANING RADIATOR CORE

Visually inspect the core for any obstructions such as dirt or debris. Use running water to clean particles from between fins.

IMPORTANT: Never use hard objects to clean radiator core, damage to core could result.

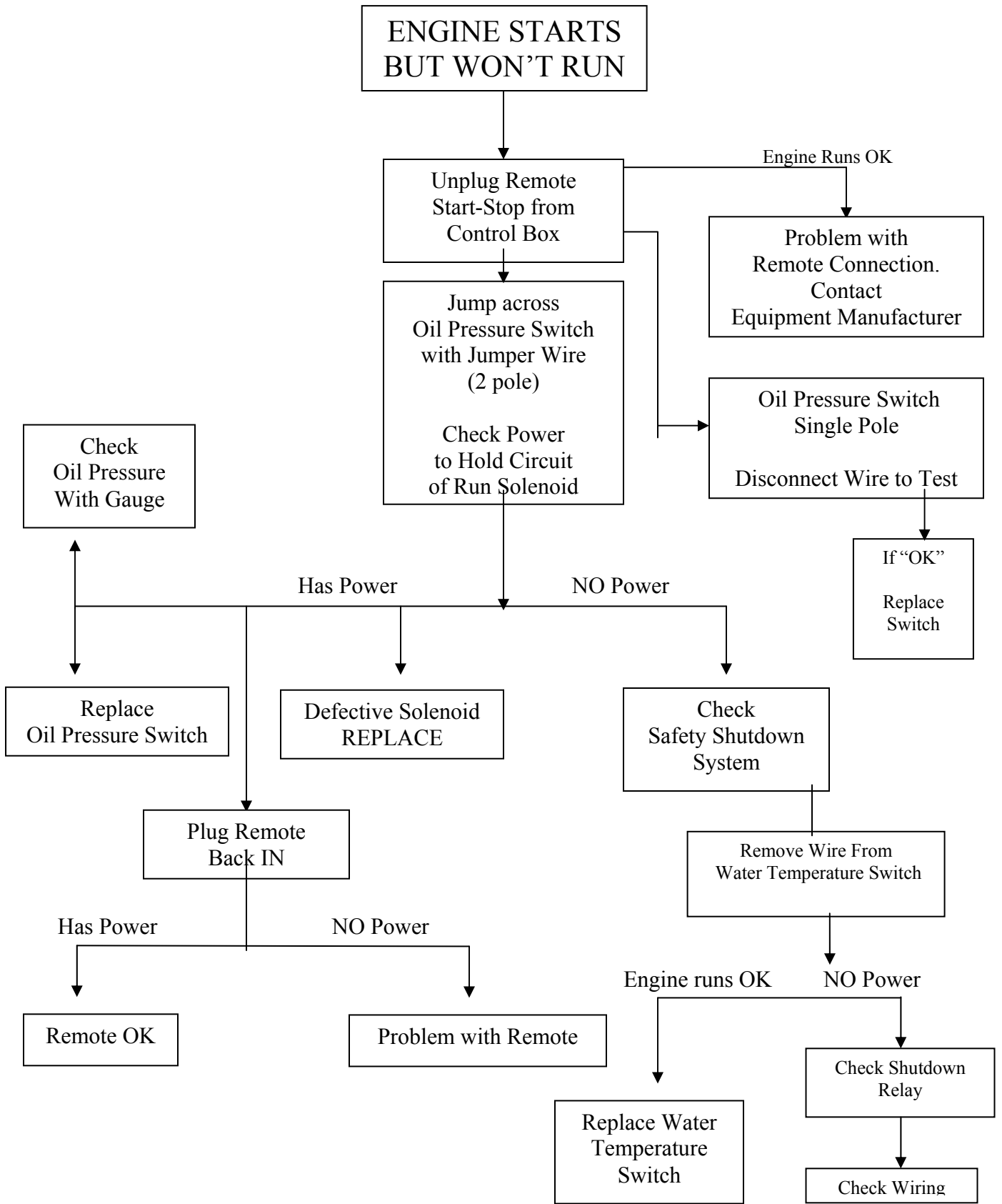

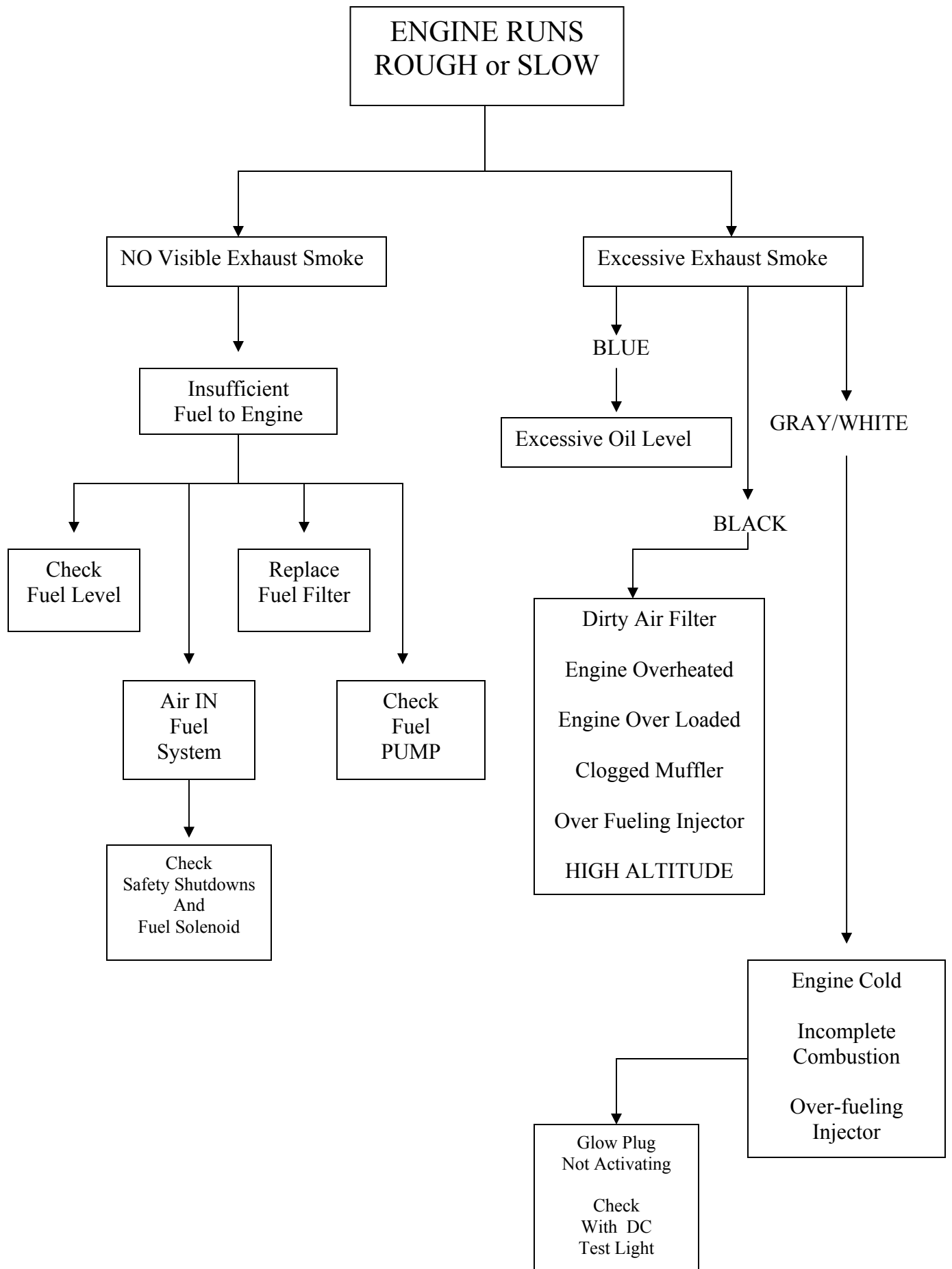

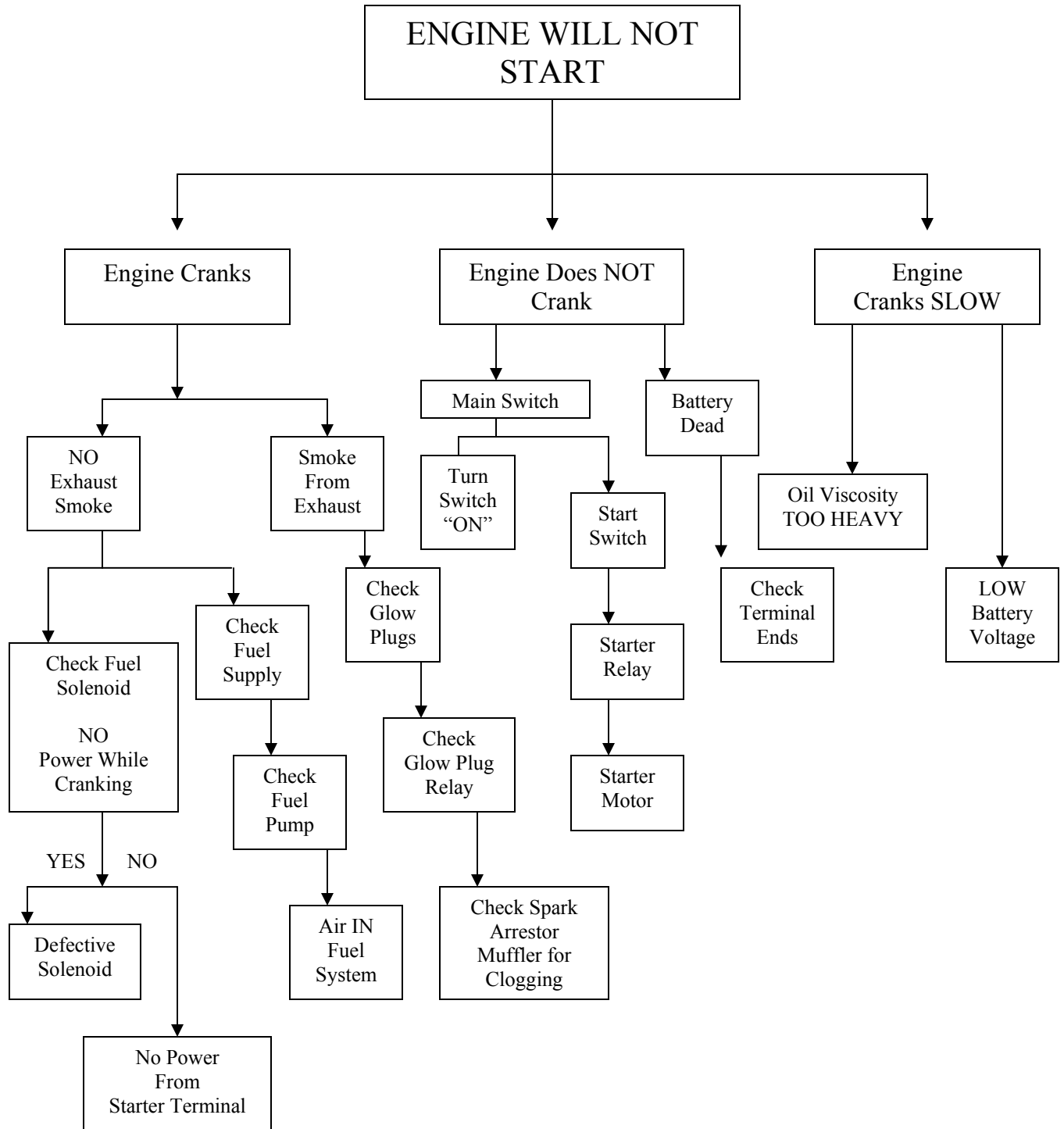

SECTION 3 “GENERATOR END”

SAFETY PRECAUTIONS _____	1-2
INSTALLATION REQUIREMENTS _____	3
GENERATOR ASSEMBLY INFORMATION _____	4-5
<u>SECTION A: GENERATOR</u>	
MARATHON MAGNAPLUS GENERATOR MANUAL _____	1-19
Installation	
Operation	
Maintenance	
<u>SECTION B: VOLTAGE REGULATORS and ENGINE CONTROLLERS</u>	
MARATHON SE350 VOLTAGE REGULATOR INSTRUCTION MANUAL _____	1-3
BASLER AVC64-4 ANALOG VOLTAGE CONTROLLER _____	4-6
ES-52 ENGINE CONTROL MODULE _____	7-8
APEC 3100 ELECTRONIC ENGINE SPEED GOVERNING SYSTEM _____	9
<u>SECTION C: WIRING SCHEMATICS</u>	
REDCO PANEL ASSEMBLY _____	1
120 VOLT, SINGLE PHASE, 4 WIRE CONNECTION “M” SERIES EXCITER TYPE _____	1
120/240 VOLT, SINGLE PHASE, 4 WIRE CONNECTION “M” SERIES EXCITER TYPE _____	2
220 VOLT, SINGLE PHASE, 4 WIRE EUROPEAN CONNECTION “M” SERIES EXCITER TYPE _____	3
RESISTANCE CHART 10KW “M” SERIES EXCITER TYPE _____	4
<u>SECTION D: GENERATOR END TROUBLESHOOTING GUIDES</u>	
ZERO OR LOW VOLTAGE _____	1
VOLTAGE TEST / 24 VOLT BATTERY TEST _____	2
OVERLOAD CONDITION _____	3

SAFETY PRECAUTIONS

A generator set can be potentially dangerous if not properly maintained and operated. The best Safe Guard against a dangerous situation is education, good judgment and common sense. For safe trouble free operation of your generator set some general precautions are listed below. Be sure to read, understand and follow these precautions. Please call Power Technology Southeast, Inc. with any concerns you may have with your generator set.

- 1) **HOT PIPING:** An engine and exhaust system may get extremely hot while running. Do not work on a generator set until it has sufficiently cooled.
- 2) **DANGEROUS FUELS:** Use extreme caution when handling, storing and using fuels. All fuels are highly explosive in a vaporous state. Store fuel in a well ventilated area away from spark producing equipment. Keep fuels and all chemicals out of the reach of children. Never add fuel to the tank while the engine is running. Spilled fuel may ignite on contact with hot parts or from ignition spark. Always keep fuel lines and connections tight and in good condition. Don't replace flexible fuel lines with rigid lines. If you notice any fuel leakage, fuel accumulation or electrical sparks, **DO NOT OPERATE THE GENERATOR SET.**
- 3) **EXPLOSIVE BATTERY GASES:** The gases generated by a battery being charged are highly explosive. Do not smoke or permit any flames or sparks to occur near a battery at any time, especially when it is being charged. Avoid contact between terminals with tools to prevent sparks and possible burns. Always remove wristwatch, rings, or other jewelry before handling a battery. Any compartment containing batteries should be well ventilated to prevent the accumulation of explosive gases. To avoid sparks never disturb the battery charging connections while the battery is being charged. Always turn off the battery charger before disconnecting terminal clips.
- 4) **ELECTROCUTION:** Failure to install a generator set with an electrical system consistent with governing regulations and standards is **UNLAWFUL** and may cause **ELECTROCUTION** of vehicle occupants. Your generator set must not be used to "Back Feed" by connecting it to a building or outdoor electrical circuit. Back feeding can cause serious injury or death to utility personnel working to repair a power outage and may also seriously injure persons in your vehicle. Unauthorized connections are unlawful in some states and/or localities. A transfer switch must be installed to prevent interconnection of the generator set power and outside power.
- 5) **MOVING PARTS:** Keep hands, feet, and clothing away from belts and related pulleys when unit is running. Replace guards, covers, and screens before operating the generator set. Serious personal injury may occur from contact with moving parts.
- 6) **HIGH VOLTAGE:** Remember the function of a generator set is to produce electricity. Wherever electricity is present there is a potential danger of electrocution. Apply the same precautions to the vehicles electrical appliances as you would for any home appliance. Keep away from electrical circuits and wiring while the generator set is running. Have electrical service performed only by qualified electricians. Be sure any unauthorized person; especially children are denied access to the generator set. Keep the compartment door securely latched or locked at all times. Be sure the generator is properly grounded. Never touch electrical leads or appliances with wet hands, or when standing on wet ground.

- 7) **EXPLOSION:** Never connect the negative (-) battery cable to the positive (+) connection terminal of the starter solenoid, or test the battery by shorting terminals together. This could ignite fuel vapors or cause the battery to explode. To disconnect the battery remove the negative battery cable first and reconnect it last. Do not modify the fuel tank or propulsion engine fuel system. Your vehicle must be equipped with a fuel pick-up arrangement as described in the Fuel System section of this manual. Fuel tank and installation must conform to applicable regulations.
- 8) **HOT COOLANT:** Allow engine to cool and release pressure from the cooling system before opening the radiator pressure cap. To release the pressure, cover the radiator cap with a thick cloth then turn it slowly counterclockwise to the first stop. After the pressure is released and the engine has cooled, remove the cap.
- 9) **LETHAL EXHAUST GAS:** When installing an exhaust system position the tail pipe end so that the discharged gases may not be drawn into the vehicle interior through windows, doors, air conditioners, etc. The engine powering your generator set discharges deadly carbon monoxide as part of the exhaust gas when running. It is essential that the exhaust system be leak proof and routinely inspected.
- 10) **EXCESSIVE NOISE:** Never operate the generator set without an adequate muffler or with a faulty exhaust system. Exposure to excessive noise can lead to a hearing impairment.
- 11) **ELECTRICAL SHOCK:** A battery can cause electrical burns and shocks. Use reasonable care when working near the battery to avoid electrical connections by contacting the battery terminals with tools. Remove wristwatch, rings and all jewelry when working on the generator set.
- 12) **BACKFIRE:** A sudden backfire can cause serious burns. Do not operate your generator set without its air cleaner / flame arrestor in place.
- 13) **FLASH FIRE:** A sudden flash fire can cause serious burns. To avoid the possibility of a flash fire do not smoke or permit a flame or spark to occur near the carburetor, fuel lines, fuel filter, fuel pump or other potential source of spilled fuel or vapors.
- 14) **FIRE HAZARD:** Be careful when parking your vehicle to prevent grass fires from being started by hot exhaust gases or exhaust system. Keep away from hot engine and generator parts to avoid burning yourself. Keep the generator set and compartment clean and free of debris, especially combustible materials. Never store fuel, oil or rags in the generator compartment.
- 15) **MARINE APPLICATION:** RV generator sets do not comply with United States Coast Guard (USCG) requirements. They must not be used for marine applications. Use only generator sets specified for marine use in a marine application. USCG regulation 33CFR183 requires a generator set to be ignition protected for use in a gasoline-fueled environment.
- 16) **UNIT STARTS WITHOUT NOTICE:** To prevent accidental starting on the units with remote start / stop switch, always disconnect the battery by removing the negative (-) terminal first and then the positive (+). Always disconnect the unit this manner before working on the generator or any equipment connected to it.
- 17) **LOOSE COMPONENTS:** Periodically check for and tighten any fasteners that may have become loose from vibration or road shock. Serious damage may possibly occur if components become dislodged or misaligned.

INSTALLATION REQUIREMENTS & RECCOMENDATIONS

Installation requirements may vary with each application depending on generator specification and optional equipment. Listed below are general recommendations for installing a Power Technology Stand-By Generator. Only qualified and licensed personnel should be employed to perform the installation. Follow all Safety Procedures outlined in this manual as well as those in the optional equipment manuals.

Depending on location, Local and or State Building Codes may apply to the installation. Be sure to check with the appropriate authorities prior to installation and obtain the required permits which apply.

NOTE: Damage to the generator and optional equipment due to improper installation may not be covered by Power Technology Southeast, Inc. Limited Warranty.

LOCATING THE GENERATOR:

A permanent location for the generator is a major factor to consider when planning an installation. These units are large and extremely heavy and will require a substantial foundation like a concrete slab to support its weight. Placing the generator directly on the earth is not recommended, dirt and debris can be drawn into the generator causing untimely component failure. Another consideration is water drainage, low lying areas prone to flooding should be avoided. Therefore planning for a permanent location is an important first step in the installation. Local and or State Building Codes may mandate dimensions and materials used in a foundation or slab.

SERVICABILITY:

As with any machine the generator will require periodic maintenance. Be sure the generator is accessible on all sides. Recommended clearance between the generator and other objects is at least 2 feet. This clearance is also required for proper ventilation and cooling. Avoid locating the generator next to an object which may cause an air flow restriction.

EXHAUST ROUTING:

The exhaust from the generator must be safely routed away from all building openings. Avoid exhausting near windows, doors, air handlers, roof eaves and vents. Avoid exhausting into confined areas with little or no air circulation. Avoid exhausting near neighboring structures as well. The exhaust system should be routinely inspected and maintained. Local and or State Building Codes may mandate exhaust routing.

ELECTRICAL CONNECTION:

In most installations the generator is connected to a buildings existing electrical system as a back-up electrical supply. This means the generator will be wired into the buildings electrical panel typically through an automatic transfer switch. Wiring and connections must be made by a licensed electrician in accordance with Local and or State Building Codes.

FUEL STORAGE:

Depending upon the specific application, the type of fuel storage tank and capacity must be considered. Typically a fuel storage tank which meets UL 142 Specifications is required. Location and connections may be mandated by Local and or State Building Codes. Consult your fuel supplier as to fuel maintenance and extended storage requirements. Adding a fuel stabilizer may be necessary to extend the usable fuel life.

GENERATOR ASSEMBLY INFORMATION

EXCITER TYPE GENERATOR

The exciter pole pieces contain residual magnetism, which sets up lines of force across the air gap to the exciter armature. When the exciter begins to rotate a voltage is induced and current flow is initiated in the exciter armature AC windings. This voltage is fed to the rotating rectifier assembly, rectified and fed to the alternator field, which sets up lines of force across the air gap to the alternator stator windings and to the output circuit.

A static voltage regulator is connected to the generator output. The regulator will rectify part of the output voltage to provide a DC voltage to the exciter field coils. This will increase the density of the lines of force in the exciter, increasing the voltage induced into the exciter armature windings, and therefore, to the rotating rectifiers. The rotating rectifier output will be increased which will increase the alternator field strength and generator output will build up its rated voltage. Adjustment of the generator output to the rated voltage level is accomplished by controlling the current fed to the exciter field coils. Regulation is automatic with the static type voltage regulator. An additional voltage adjustment range is provided if desired by turning the Voltage Adjust Rheostat.

ELECTRONIC VOLTAGE REGULATION

Electronic Voltage Regulator (EVR) also referred to, as an Automatic Voltage Regulator (AVR) is a very reliable device, which uses solid-state electronics to maintain voltage accuracy at $\pm 2\%$ of the regulated voltage. The Voltage Regulator is designed to automatically regulate and maintain the generated AC voltage through out the load range that is from no load to full load.

EXCITER FIELD COIL VOLTAGE SOURCE

Field coil DC voltage is obtained by rectifying the voltage from the phase to neutral line of the generator output, or either appropriate terminal to provide the needed voltage reference.

The rectifier bridge is an internal part of the static regulator. The static regulator senses a change in the generator output and automatically regulates current flow in the exciter field coil circuit to increase or decrease the exciter field strength. An adjustable rheostat sized to be compatible with the regulator is used to provide adjustment of the regulator sensing circuit.

ROTATING FIELD ASSEMBLY (ROTOR)

The rotating field assembly consists basically of four members: 1) the shaft assembly, 2) the core assembly, 3) the field coil damper windings, and 4) balance lugs to provide a high degree of static and dynamic balance.

CORE ASSEMBLY

The core assembly consists of a quantity of thin steel plates compressed and fastened together to form a single laminated assembly. The field windings are wound around this assembly.

FIELD COIL

Field coils of heavily insulated wire are “wet” wound directly onto the poles. Field coil leads are brought out to the rectifier assembly for connection to the source of DC excitation voltage.

BALANCE

The rotor assembly is precision balanced to a high degree of static and dynamic balance. Although the balance will remain dynamically stable at speeds in excess of the design frequencies, the prime mover should be adequately governed to prevent excessive over speed. High centrifugal forces created by excessive over speed may damage the rotor windings and field coils.

BEARING

The generator rotor assembly is suspended on a shielded factory lubricated ball bearing. A visual inspection of the bearing is recommended at typical service intervals. If signs of abnormal wear or leakage are observed, the bearing should be replaced. Never use liquids of any kind to clean the generator end and bearing.

STATOR ASSEMBLY

The stator assembly consists of laminations of steel mounted in a rolled steel frame. Random wound stator coils are fitted into the insulated slots.

SECTION A:

GENERATOR

MAGNAPLUS GENERATOR

280 -- 430 Frame
Installation, Operation and Maintenance
Manual

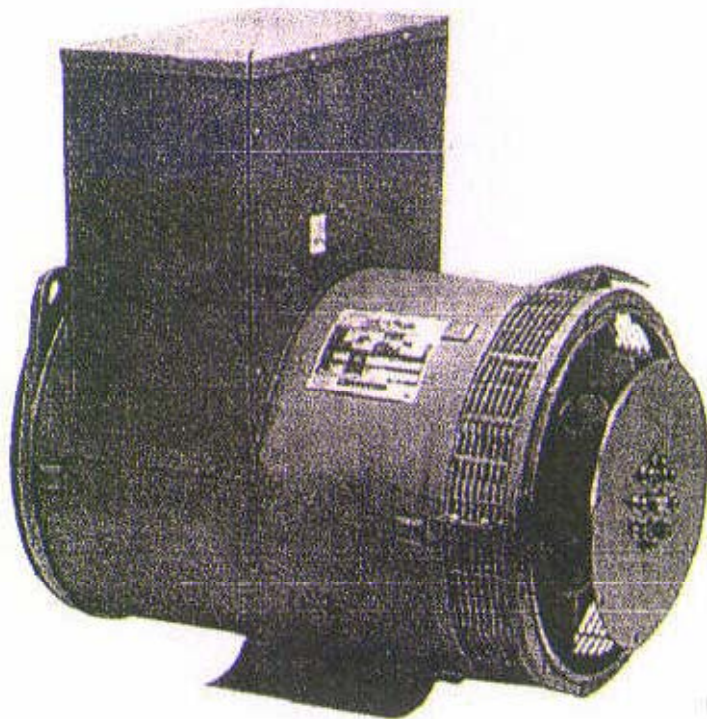

 **MARATHON**
ELECTRIC

A Subsidiary of Regal-Beloit Corporation

Marathon Electric
A Subsidiary of Regal-Beloit Corp.
100 East Randolph Street
P.O. Box 8003
Wausau, WI 54402-8003
Phone: (715)675 3311
Fax: (715)675 6361

CONTENTS

Safety	2
Receiving and Storage	2
Principles of Operation	3-4
Installation	4-6
Wiring Connections	6-9
Operation	9-10
Maintenance	10-11
Testing	11-12
Service	12-14
Troubleshooting	14-17
Specifications	18
Parts List & Recommended Spare Parts	19-20

SAFETY

PLEASE REMEMBER SAFETY FIRST. If you are not sure of the instructions or procedures contained herein, seek qualified help before continuing.

This service manual emphasizes the safety precautions necessary during the installation, operation, and maintenance of your MagnaPLUS generator. Each section of this manual has caution and warning messages. These messages are for your safety, and the safety of the equipment involved. If any of these cautions or warnings are not readily understood, seek clarification from qualified personnel before proceeding.

Before any service work is done, disconnect all power sources and lock out all controls to prevent an unexpected start-up of the generator set driver. Proper grounding (earthing) of the generator frame and distribution system in compliance with local and national electrical codes and specific site requirements must be provided. These safety precautions are necessary to prevent potential serious personal injury, or even death.

The hazards associated with lifting or moving your MagnaPLUS generator are pointed out in the installation and maintenance sections. Incorrect lifting or moving can result in personal injury or damage to the unit.

Prior to start-up of the unit ensure that all generator leads are properly connected to the generator link board located inside the connection box. Always assume that there will be voltage present at the generator terminals whenever the generator's shaft is rotating, and proceed accordingly. Residual voltage is present at the generator terminals and at the automatic voltage regulator panel connections even with the regulator fuse removed. Caution must be exercised, or serious injury or death can result.

This manual is not intended to be a substitute for properly trained personnel. Installation and repairs should only be attempted by qualified, trained people. The cautions and warnings point out known conditions and situations that are potentially hazardous. Each installation may well create its own set of hazards.

When in doubt, ask. Questions are much easier to handle than mistakes caused by a misunderstanding of the information presented in this manual.

RECEIVING AND STORAGE

RECEIVING AND STORAGE

Upon receipt of the generator, it is recommended that it be carefully examined for possible shipping damage. The generator was given to the freight carrier in good condition, thus, the carrier is responsible for the product from the factory dock to the destination. Any damage should be noted on the freight bill before acceptance of the shipment. Any claims for damage must be promptly filed with the delivering carrier.

UNPACKING AND HANDLING

Carefully read all instruction tags shipped with the unit. When lifting, attach an overhead crane to the lifting lug(s) on the generator frame. Apply lifting forces in a vertical direction. When transporting single bearing generators, the generator's rotor must be adequately supported to prevent damage.

WARNING

THE LIFTING LUG(S) ON THE GENERATOR ARE DESIGNED TO SUPPORT THE GENERATOR ONLY. DO NOT LIFT A COMPLETE GENERATOR AND DRIVER ASSEMBLY BY MEANS OF LIFTING LUG(S) ON THE GENERATOR. PERSONAL INJURY OR EQUIPMENT DAMAGE MAY RESULT.

STORAGE

In the event that the generator is not immediately installed on its prime mover, it is recommended that the unit be stored indoors in a clean, dry area which is not subject to rapid changes in temperature and humidity. If the generator is stored for a long period of time, the generator should be tested, cleaned and dried as required before being put into service. See the maintenance section of this manual for further information. If the unit has been stored in an area where it has been subject to vibration, it is recommended that the bearing(s) be inspected and replaced as necessary.

PRINCIPLES OF OPERATION

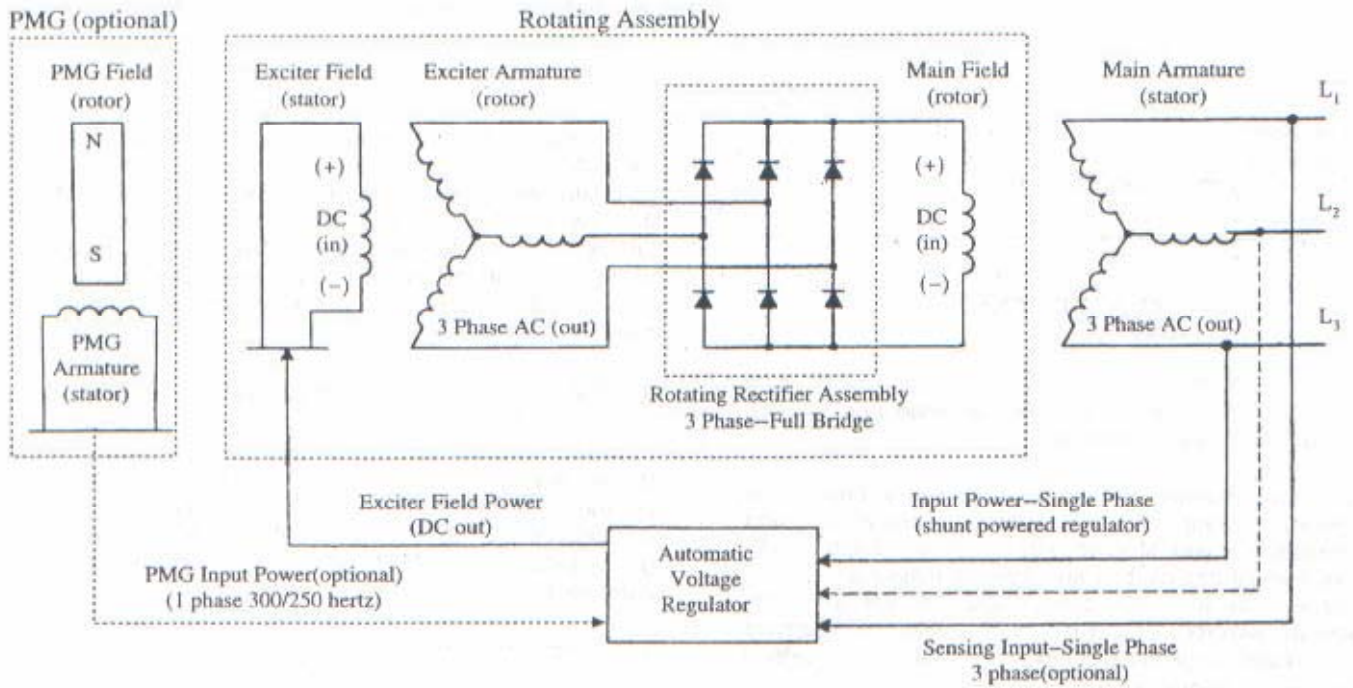

FIGURE 1—MagnaPLUS Circuit Diagram

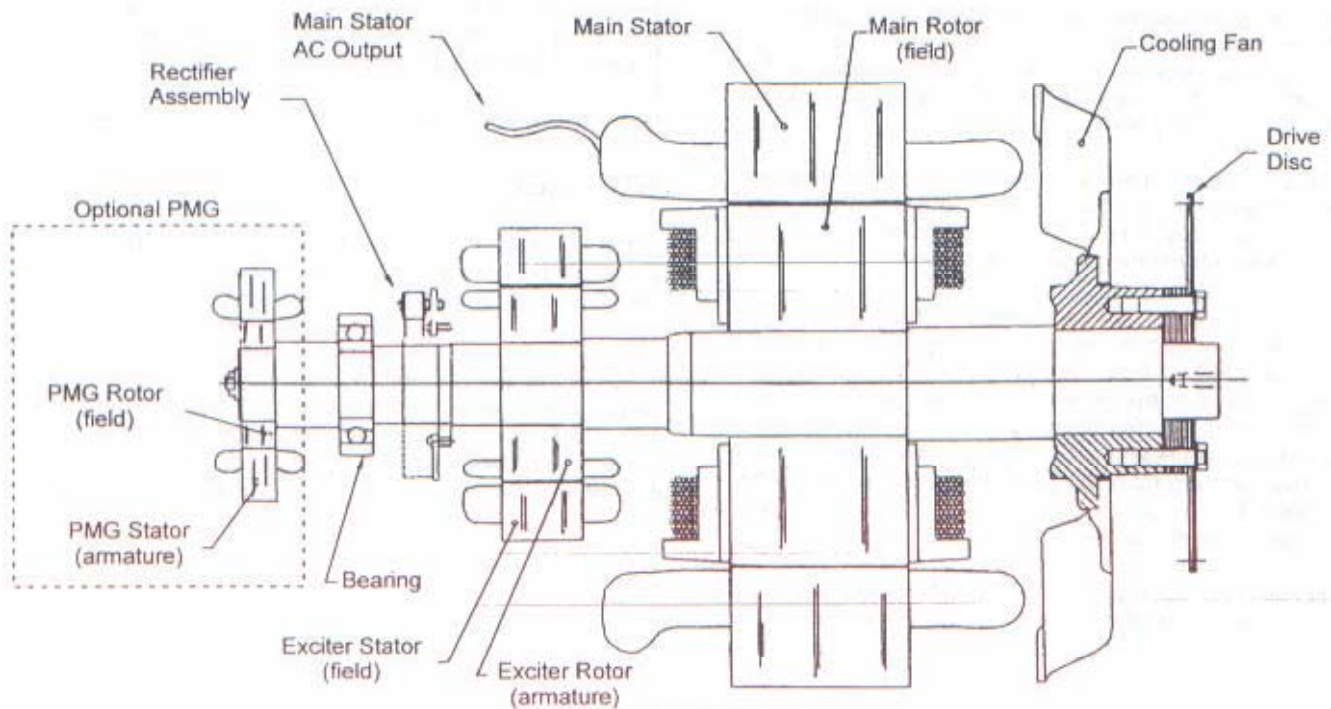

FIGURE 2—Typical MagnaPLUS Layout Diagram

PRINCIPLE OF OPERATION

MagnaPLUS generators are a brushless, self excited, externally voltage regulated, synchronous AC generator. The generator is made up of six major components: main stator (armature), main rotor (field), exciter stator (field), exciter rotor (armature), rectifier assembly, and voltage regulator. In understanding the above terminology, note the following: stators are stationary, rotors rotate, a field is an electrical input, and an armature is an electrical output. These system components are electrically interconnected as shown in figure 1 and physically located as shown in figure 2.

The generator's exciter consists of a stationary field and a rotating armature. The stationary field (exciter stator) is designed to be the primary source of the generator's residual magnetism. This residual magnetism allows the exciter rotor (armature) to produce AC voltage even when the exciter stator (field) is not powered. This AC voltage is rectified to DC by the rotating rectifier assembly and fed directly to the main rotor (field). As the generator shaft continues to rotate, the main rotor (field) induces a voltage into the generator's main stator (armature). At rated speed, the main stator's voltage produced by the residual magnetism of the exciter allows the automatic voltage regulator to function. The regulator provides voltage to the exciter resulting in a build-up of generator terminal voltage. This system of using residual magnetism eliminates the need for a special field flashing circuit in the regulator. After the generator has established the initial residual voltage, the regulator provides a controlled DC field voltage to the exciter stator resulting in a controlled generator terminal voltage.

Voltage Regulation

In the standard configuration (shunt excited), the automatic voltage regulator receives both its input power and voltage sensing from the generator's output terminals (See Figure 1). With the optional PMG configuration, the regulator receives input power from the PMG. The regulator automatically monitors the generator's output voltage against an internal reference set point and provides the necessary DC output voltage to the exciter field required to maintain constant generator terminal voltage. The generator's terminal voltage is changed by adjusting the regulator's reference set point. Consult the regulator manual for specific adjustment and operating instructions.

MOTOR STARTING

When a motor is started, a large surge of current is drawn by the motor. This starting current is equivalent to the motor's locked rotor or stall current and is 5 to 10 times normal full load current. When the generator supplies this in-rush of starting current, the generator voltage dips temporarily. If the motor is too large for the generator, the generator's voltage dips greater than 30 percent. This may result in the motor starter de-energizing or the motor stalling. MagnaPlus generators generally supply 3 to 4

horsepower per generator KW in motor starting capability. For specific data contact Marathon Electric.

PARALLEL OPERATION

All MagnaPlus generators are built with 2/3 pitch main stator windings and full amortisseur (damper) windings. These features make the MagnaPlus generators suitable for parallel operation when equipped with the proper voltage regulators and voltage regulator accessories. Consult with the factory for further information relative to parallel operations.

NONLINEAR LOADING

Solid state electronic control devices (variable frequency drives, precision motor controls, battery chargers, etc.) utilize electronic switching circuits (thyristors, SCRs, Diodes, etc.). These switching circuits introduce high frequency harmonics which distort the normal wave form of the generator. This creates additional heat in the generator windings and may cause the generator to over-heat. Problems which can occur are not limited to the generator. Poor wave shape may adversely effect various loads connected to the generator. Consult Marathon Electric for further information relative to nonlinear loads.

INSTALLATION

PREPARATION FOR USE

Although the generator has been carefully inspected and tested in operation prior to shipment from the factory, it is recommended that the generator be thoroughly inspected. Check all bolts for tightness and examine the insulation on lead wires for chafing prior to proceeding with installation. Remove all shipping tapes, bags, skids and rotor support blocking. For two bearing units, rotate the shaft by hand to ensure that it rotates smoothly without binding.

WARNING

DISABLE AND LOCKOUT ANY ENGINE CRANKING DEVICES BEFORE ATTEMPTING TO INSTALL OR SERVICE THE GENERATOR. FOR ELECTRIC START SETS, DISCONNECT THE CRANKING BATTERY. FOR AIR START, DISCONNECT THE AIR SUPPLY. FOR MOTOR GENERATOR SETS, OPEN THE POWER SUPPLY TO THE DRIVE MOTOR. FAILURE TO COMPLY WITH THESE SAFETY PROCEDURES COULD RESULT IN SEVERE PERSONAL INJURY OR EQUIPMENT DAMAGE.

NEVER "BAR OVER" THE ENGINE GENERATOR SET USING THE GENERATOR'S FAN. THE FAN IS NOT DESIGNED FOR THIS PURPOSE. BARRING OVER THE SET WITH THE FAN COULD DAMAGE THE FAN AND RESULT IN PERSONAL INJURY OR EQUIPMENT DAMAGE.

GENERATOR MOUNTING

Single Bearing Units.

Single bearing units are provided with an SAE flywheel housing adapter flange and flexible drive discs. Coupling the generator's shaft to the engine flywheel is accomplished with special steel drive discs bolted to the shaft. In addition to the drive discs, there may be a hub spacer, spacer discs, or a combination of hub spacer and spacer discs inserted between the drive discs and the shaft to achieve the proper shaft extension ("G" dimension per SAE J620c). Holes are provided in the periphery of the coupling discs which correspond to tapped holes in the prime mover's flywheel. The outside diameter of the drive discs fit in a rabbet in the flywheel so that concentricity is assured.

Grade 8 place bolts and hardened washers are recommended to mount the drive discs to the flywheel. DO NOT USE SPLIT TYPE LOCK WASHERS. Split lock washers when biting into the drive disc cause stress risers which may result in the disc fracturing.

The SAE flywheel housing adapter ring and the engine flywheel housing are designed to match each other with no further alignment necessary. Use grade 5 or greater mounting bolts. MagnaPLUS generator frames are constructed with two or three bolt holes per foot. The feet should be shimmed where necessary to obtain solid contact with the sub-base. With the frame securely bolted to the engine flywheel housing, there is no side thrust or pull on the generator frame, thus no real need to secure the feet with more than one bolt per foot.

GENERATOR MOUNTING

Two Bearing Generators--Direct Drive

Two bearing generators are provided with a keyed shaft extension. For direct drive generators, the assembler furnishes a flexible coupling which is installed between the

driver and the generator's shaft. Aligning the generator and its driver as accurately as possible will reduce vibration, increase bearing life, and ensure minimum coupling wear. It may be necessary to shim the generator feet for proper support and alignment. Secure the feet of the generator with grade 5 or greater bolts through the holes provided in the mounting feet. Consult the coupling manufacturer's instructions for alignment specifications and procedures.

GENERATOR MOUNTING

Two Bearing Units--Belt Driven

Two bearing MagnaPLUS generators can be belt driven provided belts are sized and applied correctly. Please refer to your supplier of belts and sheaves for correct sizing and tensioning specifications. A bearing life calculation should be performed. Marathon Electric recommends a minimum B-10 life of 40,000 hours. If cog type belts are used, a vibration may be introduced which could lead to premature failure of the bearings.

END PLAY TESTING

Refer to the engine manual for recommended end play specifications and measurement procedures. If end play is not to specification, it is an indication that the generator shaft is not moving freely in the assembly, and normal life of the thrust bearing could be impaired. Probable causes of this problem are:

1. Improper seating of drive discs in the flywheel resulting in misalignment.
2. Improper mating of generator frame to engine flywheel housing resulting in misalignment.
3. Improper "G" dimension per SAE J620c on either the engine or generator.

TORSIONAL VIBRATION

Torsional vibrations are generated in all rotating shaft systems. In some cases the amplitude of these vibrations at critical speeds may cause damage to either the generator, its driver, or both. It is therefore necessary to examine the torsional vibration effect on the entire rotating system. IT IS THE RESPONSIBILITY OF THE GENERATOR SET ASSEMBLER TO ASSURE THE TORSIONAL COMPATIBILITY OF THE GENERATOR AND ITS DRIVER. Drawings showing pertinent dimensions and weights of the rotating assembly will be supplied by Marathon Electric upon request.

ENVIRONMENTAL CONSIDERATIONS

The MagnaPLUS generator is designed for heavy duty industrial applications; however, dirt, moisture, heat and vibration are enemies of rotating electrical machinery. Excessive exposure to the elements may shorten generator life. The temperature of the cooling air entering the intake openings of the generator should not exceed the ambient temperature shown on the generator's nameplate. Generators intended for outdoor application should be protected with housings having adequate ventilation. Although the standard insulation systems are moisture and humidity resistant, space heaters are recommended for extreme conditions. If the generator is to be installed in an area where blowing sand and dust are present, the enclosure should be fitted with filters. Filters reduce erosion on the generator's insulation by blocking high velocity abrasive particles generated by the flow of cooling air through the generator. Consult the factory for appropriate filters and generator deratings required.

WIRING CONNECTIONS

Wiring of the generator and accessories should be done in accordance with good electrical practices. Follow government, industry and association standards.

The generator conduit box construction allows cable entry from multiple sides. A hole saw or other appropriate tool may be used to provide for conduit entrance. Protect the

interior of the generator from shavings when drilling or sawing. An approved connector must be used in conjunction with the conduit. To minimize the transmission of vibration, it is essential that flexible conduit be used for all electrical entrance to the generator conduit box.

All MagnaPLUS generators are equipped with link boards (terminal strips) for both internal and external connections. All connections made to the studs of the link board should be made with high quality ring terminals. Ring terminal sizes are: 6 mm (280 Series Frames) and 10 mm (360 and 430 Series Frames). Torque link board connections to the following specifications: 280 frame-5.4 NM (4 Ft Lb); 360 & 430 frame-27 NM (20 Ft Lb).

Refer to the connection diagram supplied with the generator and / or the proper diagrams shown in this manual. Install all inter-component and external wiring in accordance with national and local electrical codes. The neutral in the following connection diagrams shown below may be either grounded (earthed) or left above ground potential (floating). See national and local codes and / or the system distribution wiring schematic diagram for the proper connection of the neutral.

The following connection diagrams are shown for twelve lead generators. Ten lead generators have the same terminal designations except for leads T10, T11, and T12. These three leads are internally connected inside the generator and brought out as a single lead (TO). Ten lead generators can only be connected in a wye configuration

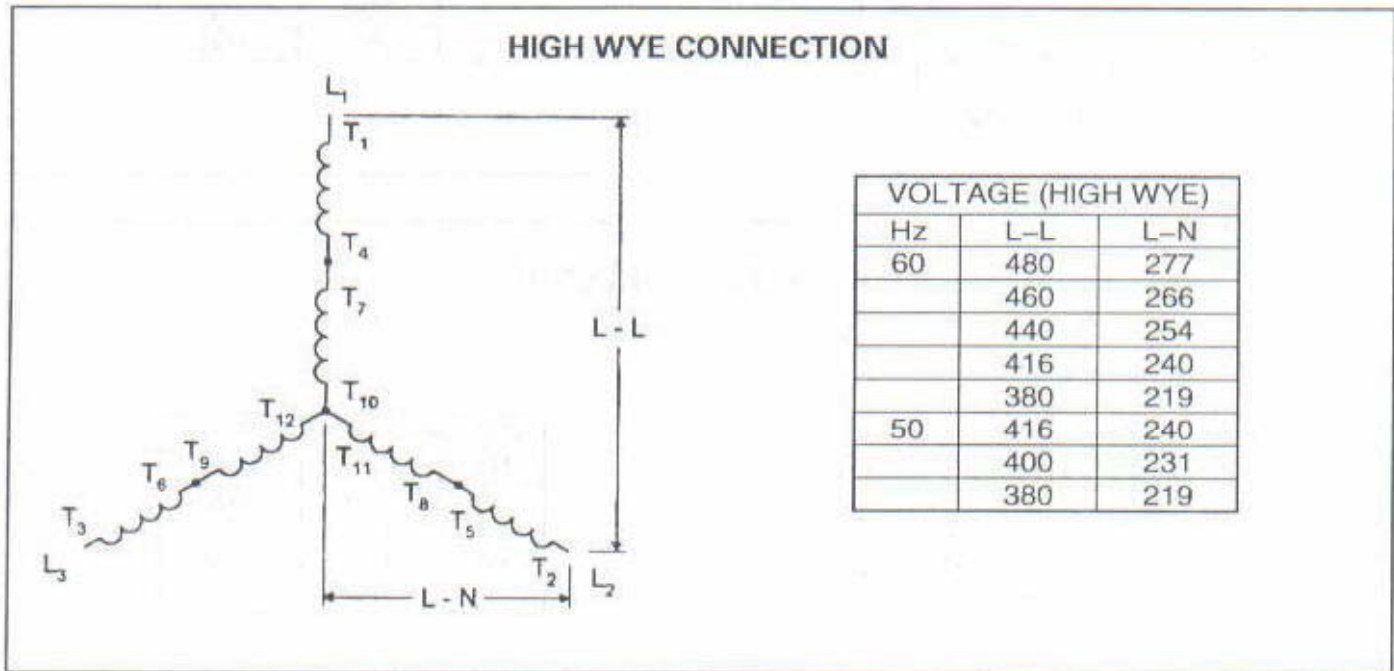

LOW WYE CONNECTION

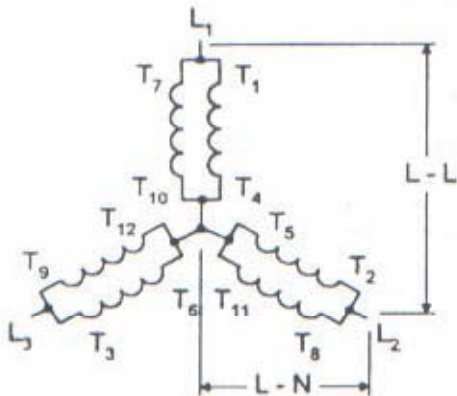

VOLTAGE (LOW WYE)		
Hz	L-L	L-N
60	240	139
	230	133
	220	127
	208	120
50	190	110
	208	120
	190	110

HIGH DELTA CONNECTION

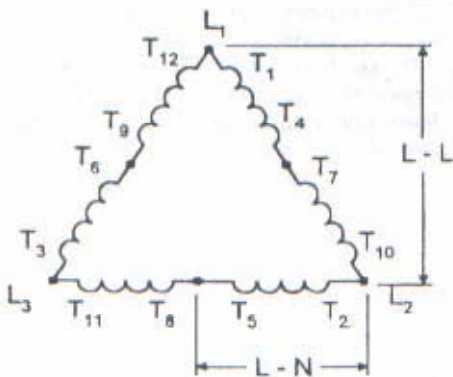

VOLTAGE (HIGH DELTA)		
Hz	L-L	L-N
60	277	139
	240	120
50	240	120
	220	110
	200	100

LOW DELTA CONNECTION

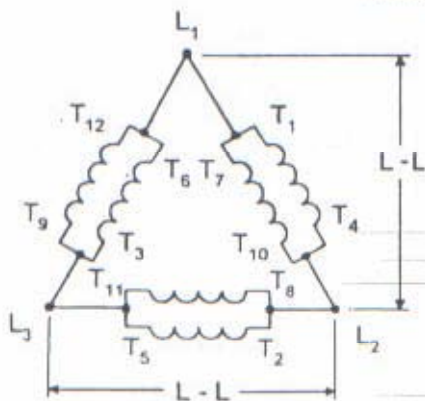

VOLTAGE (LOW DELTA)		
Hz	L-L	L-N
60	120	NA
	110	NA
50	110	NA
	100	NA

DOUBLE DELTA--SINGLE PHASE CONNECTION

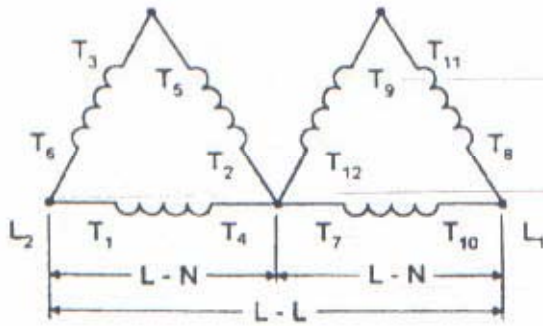

VOLTAGE (DOUBLE DELTA)		
Hz	L-L	L-N
60	240	120
	220	110
50	220	110

Note: Single phase KW/KVA ratings are approximately equal to 50% of the generator's three phase ratings

LOW ZIG ZAG--SINGLE PHASE CONNECTION

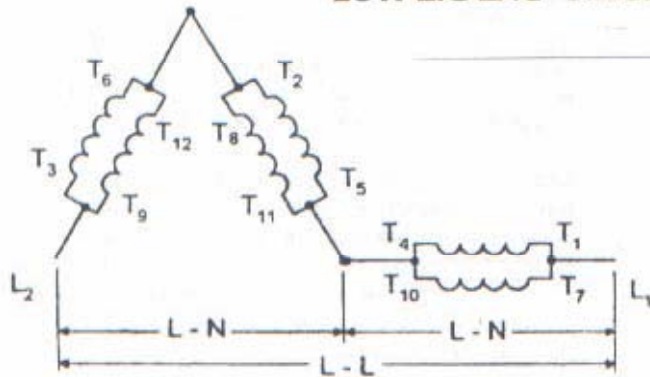

VOLTAGE (LOWZIGZAG)		
Hz	L-L	L-N
60	240	120
	220	110
50	220	110
	200	100

Note: Single phase KW/KVA ratings are approximately equal to 50% of the generator's three phase ratings

HIGH ZIG ZAG -- SINGLE PHASE CONNECTION

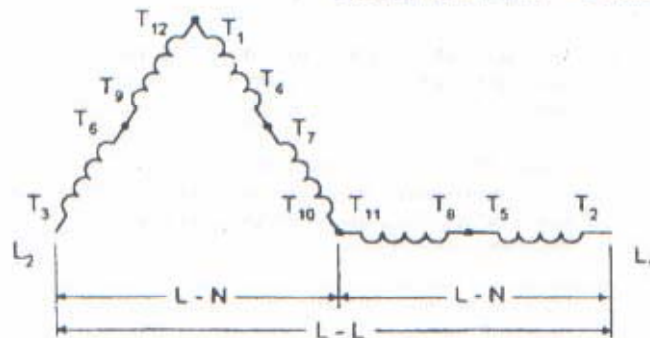

VOLTAGE (HIGH ZIGZAG)		
Hz	L-L	L-N
60	480	240
	460	220
50	415	208
	380	190

Note: Single phase KW/KVA ratings are approximately equal to 50% of the generator's three phase ratings

DEDICATED SINGLE PHASE CONNECTION

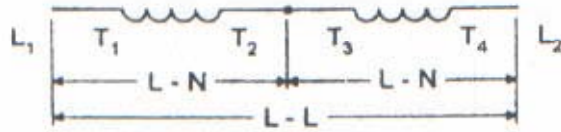

VOLTAGE (DEDICATED)		
Hz	L-L	L-N
60	240	120
	220	110
50	220	110
	200	100

OPERATION

PRE-START INSPECTION

Before starting the generator for the first time, the following inspection checks are recommended.

1. A visual inspection should be made for any loose parts, bad connections, or foreign materials.
2. Bar the set over by hand for at least 2 revolutions to be sure that there is no interference and that the set turns freely. If the set does not turn freely, check for clearance in the generator and exciter air gap.
3. Check all wiring against the proper connection diagrams, and ensure that all connections and terminations are tight and properly insulated.

WARNING

MAGNAPLUS GENERATORS MAY HAVE VOLTAGE PRESENT AT THE LEAD TERMINALS WHEN THE SHAFT IS ROTATING. DO NOT PERMIT OPERATION OF THE GENERATOR UNTIL ALL LEADS HAVE BEEN CONNECTED AND INSULATED. FAILURE TO DO THIS MAY RESULT IN PERSONAL INJURY OR EQUIPMENT DAMAGE

4. Verify that all equipment is properly grounded (earthed).
5. Clear the surrounding area of any materials that could be drawn into the generator.
6. Check all fasteners for tightness.
7. Check all access plates, covers, screens and guards. If they have been removed for assembly or inspection, reinstall and check for security.

8. Review all prime mover prestart-up instructions, and ensure that all recommended steps and procedures have been followed.
8. Remove any masking materials affixed during painting. Inspect the generator, prime mover, and any accessory equipment to ensure that nameplates, and all safety warning / caution signs and decals provided with the equipment are in place and clearly visible.

Note: It is strongly recommended that the authority having jurisdiction over the installation site be consulted to determine if any additional warning or caution notices, or additional safety devices are required by local codes / standards. Any such required notices or devices should be installed prior to initial startup.

START-UP

The following procedure should be followed when starting the generator set for the first time.

1. The generator output must be disconnected from the load. Be sure that the main circuit breaker or fused disconnect is in the open position.
2. Open the input power to the automatic voltage regulator. Remove the fuse or disconnect and insulate one of the regulator input power leads. (See separate regulator manual)
3. Verify that all prime mover start-up procedures have been followed.
4. If the unit is provided with space heaters, ensure that they are de-energized. In some installations, a set of auxiliary contacts on the main circuit breaker or transfer switch will automatically open the space heater circuit when the generator is connected to the load.
5. Start the prime mover, and adjust it for proper speed. See generator nameplate.

- The purpose of this initial test with the regulator out of the circuit is to detect any wiring mistakes without exposing the unit to undue risk. Check all line to line and line to neutral voltages for balanced voltage. If voltages are balanced, shut down the set and reconnect the regulator. If voltages are unbalanced, shut down the equipment and check for improper wiring. If the problem persists, consult the factory.

With the regulator de-energized, the residual voltage should be 10-25% of rated value. It is recommended that this residual voltage and driver RPM be recorded for use as a future troubleshooting benchmark.

WARNING

THE FOLLOWING TEST MUST BE CONDUCTED BY QUALIFIED ELECTRICAL PERSONNEL. LETHAL VOLTAGE MAY BE PRESENT AT BOTH THE GENERATOR AND VOLTAGE REGULATOR TERMINALS DURING THIS PROCEDURE. CAUTION MUST BE EXERCISED NOT TO COME INTO PERSONAL CONTACT WITH LIVE TERMINALS, LINKS, OR STUDS. SERIOUS INJURY OR DEATH COULD RESULT.

- Start the set and adjust the terminal voltage to the desired value by means of the regulator voltage adjustment. If the regulator is equipped with a stability adjustment, follow the instructions in the regulator manual to adjust the stability. Again, check all line to line and line to neutral voltages for balance. It is recommended practice to record the no load excitation (DC voltage to the exciter stator), generator terminal voltage, and driver speed as a benchmark for future troubleshooting.
- Close the main circuit breaker to the load.
- Monitor the generator output current to verify that it is at or below nameplate value.
- Check generator speed (frequency) under load. Adjust as necessary (Refer to prime mover or governor manuals)

SHUTDOWN PROCEDURE

There are no specific instructions for shutting down the generator, however, several good practices should be observed to prolong equipment life.

- It is advisable to disconnect all loads (open main circuit breaker or disconnect) prior to shutdown. This is especially important if loads can be damaged by low voltage or low frequency conditions during generator "coast down".
- Isolate all conditions that could apply voltage to the

generator terminals while the generator is at rest. Failure to comply could result in personnel injury or equipment damage.

- If the unit is equipped with space heaters, verify that the heater circuit is energized.

MAINTENANCE

The following maintenance procedures should be followed to ensure long equipment life and satisfactory performance. Maintenance intervals will depend upon operating conditions.

- Routinely check intake and exhaust air screens to ensure that they are clean and free of debris. Clogged intake air screens will reduce cooling air flow and result in higher operating temperatures. This will reduce generator life and may result in generator damage.
- All MagnaPLUS generators are equipped with double shielded ball bearings lubricated for the life of the bearing. Every 1,000 hours check the bearing(s) for smooth, quiet operation. For continuous duty generators, recommended practice is to replace the bearing during major overhauls of the engine.
- Periodically inspect the unit for any buildup of contamination (dirt, oil, etc.) on the winding. If the wound components have become coated with heavy concentrations of oil and grime, the unit should be disassembled and thoroughly cleaned. This operation is not one that can be accomplished effectively on site, but rather one that should be conducted by an authorized service center equipped with the appropriate apparatus and solvents necessary to properly clean and dry the generator.

WARNING

THE FOLLOWING TEST MUST BE CONDUCTED BY QUALIFIED ELECTRICAL PERSONNEL. LETHAL VOLTAGE MAY BE PRESENT AT BOTH THE GENERATOR AND VOLTAGE REGULATOR TERMINALS DURING THIS PROCEDURE. CAUTION MUST BE EXERCISED NOT TO COME INTO PERSONAL CONTACT WITH LIVE TERMINALS, LINKS, OR STUDS. SERIOUS INJURY OR DEATH COULD RESULT.

- Every 2,000 operating hours or in conjunction with scheduled engine maintenance, check the DC no load excitation voltage per item #7 in the startup procedure. Compare this voltage with the value recorded during initial startup. If this value of no load excitation voltage is markedly higher than the benchmark reading, it is an indication of problems in either the exciter, main field, or the rotating rectifier assembly. Ensure that RPM is the same as initial test.

5. Monitor and record insulation resistance with a 500 volt mega-ohm meter. The minimum acceptable reading is 2 mega-ohms. If the reading drops below the minimum, the generator should be cleaned and dried at an authorized service shop. Consult Marathon Electric for more information.

DRYING WINDINGS

Generators in service may inadvertently have their windings exposed to splashing or sprayed water. Units that have been in transit or storage for long periods of time may be subjected to extreme temperature and moisture changes causing excessive condensation. Regardless of the source of moisture, wet windings should be thoroughly dried out before operating the unit. If this precaution is not taken, serious damage to the generator can result. The following procedures may be utilized in drying the generator's windings. The method selected will be influenced by winding wetness and situation limitations.

Space Heaters

An electric heater may have been supplied with the generator. When energized from a power source other than the generator, the heater will gradually dry the generator. This process can be accelerated by enclosing the unit with a covering and inserting additional heating units. A hole should be left at the top of the covering to permit the escape of moisture. Care should be taken not to overheat various accessory equipment mounted with the generator.

Forced Air

Another method to dry the generator is to run the set with no excitation (see startup procedure item #2). The natural flow of ambient air through the generator will tend to dry the windings. This method can be accelerated by adding a source of heat at the air intake to the generator. Heat at point of entry should not exceed 80 C (180° F).

TESTING

Visual Inspection

Remove covers and look for any obvious problems: burnt windings, loose connections, broken wires, frayed insulation, cracked brackets, missing hardware, etc. Check for foreign objects which may have been drawn into the generator. Verify that the generator's air gaps (main rotor and exciter) are free from obstructions. If possible, rotate the generator manually to ensure free rotation. Never "bar over" the engine generator set using the generator fan.

WARNING

THE FOLLOWING TEST MUST BE CONDUCTED BY QUALIFIED ELECTRICAL PERSONNEL. LETHAL VOLTAGE MAY BE PRESENT AT BOTH THE GENERATOR AND VOLTAGE REGULATOR TERMINALS DURING THIS PROCEDURE. CAUTION MUST BE EXERCISED NOT TO COME INTO PERSONAL CONTACT WITH LIVE TERMINALS, LINKS, OR STUDS. SERIOUS INJURY OR DEATH COULD RESULT.

CONSTANT EXCITATION TEST (12V BATTERY TEST)

The generator "no load" voltage is dependent on exciter input voltage and generator speed. With the generator operating at rated speed and 12 volts dc applied to the exciter field, the generator's terminal voltage will be near rated value.

1. Shutdown the generator set and connect a voltmeter on the generator terminals.
2. Disconnect the regulator's F+ (F1) and F-(F2) leads and connect them to a 12V battery. Caution should be taken to ensure that the battery is not exposed to any potential arcing.
3. With no load on the generator (main breaker open) run the generator at rated speed. Measure the generator's terminal voltage and compare this value with values recorded during installation.

If voltage readings are normal, the main generator and excitation are operating properly. Troubleshooting should continue with the regulator. If readings are not normal the problem is in the generator. Continue testing diodes, surge suppressor, and windings.

Continuity / Resistance Test

The generator has four components which can be checked using an ohm meter: exciter stator, exciter rotor, main stator and main rotor. Each of these components are comprised of various windings which form a complete electrical path of relatively low resistance. Using an ohm meter measure the loop resistance of each component. Compare these measured values with the values listed in the specification section of this manual. Note that very small resistance values require precision equipment to make accurate measurements; however, a standard ohm meter will provide a good indication of winding continuity.

Insulation Test

Insulation resistance is a measure of the integrity of the insulating materials that separate the electrical windings from the generator's steel core. This resistance can degrade over time or be degraded by contaminants: dust, dirt, oil, grease, and especially moisture. Most winding failures are due to a breakdown in the insulation system. In many cases, low insulation resistance is caused by moisture collected when the generator is shutdown.

Insulation resistance is measured with a megger (mega-ohm meter). A megger measures insulation resistance by placing 500 volts between the winding and the frame of the generator. Caution must be taken to remove all electronic devices (regulators, diodes, surge protectors, capacitors, protective relays, etc.) from the winding circuit before checking the insulation. Winding insulation can be checked on the main stator, main rotor, exciter stator, and exciter rotor. Minimum resistance is 2 mega-ohms. If the winding resistance is low it must be dried (see maintenance section) or repaired.

DIODE TESTING

If the generator is close coupled to an engine, it may be necessary to "bar over" the engine in order to gain access to a given area of the rectifier assembly. NEVER use the generator's fan as a fulcrum to accomplish this. Use the engine manufacturer's recommended practice to manually turn over the engine. To prevent possible injury to personnel, and damage to the equipment, ensure that the engine cannot start during this procedure.

Remove the two main rotor leads and the three exciter rotor leads from the rectifier assembly (figure 4). The rectifier assembly is now electrically isolated from the generator. The diodes remain mounted and the diode leads remain connected to the terminal posts. Using an ohmmeter or a battery light continuity tester, place one test probe on the diode lead terminal post. In succession, touch the other test probe to the lead screw hole in each heat sin. Reverse the probes and repeat the procedure. You have now tested the three diodes connected to this terminal post in both the forward and reverse direction. Repeat the procedure using the other diode terminal post.

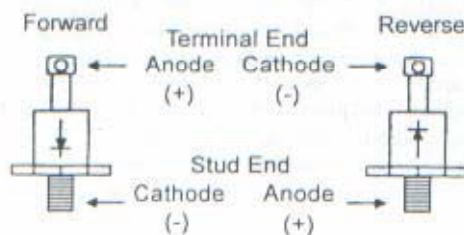

FIGURE 3: DIODE POLARITY

When the positive test probe is connected to the diode's anode and the negative test probe is connected to the diode's cathode (forward biased), the diode will switch on and conduct electricity (figure 3). This is observed by a low resistance reading when using an ohm meter or the lighting of the bulb when using a battery light continuity tester. Reversing the test leads (reverse biased) will result in the diode switching off and no electricity will be conducted. The results of these tests should indicate one of three conditions:

1. **Good Diode:** Will have a much greater resistance in one direction than the other. Typical reverse biased resistance will be 30,000 ohms or greater, while forward biased resistance will be less than 10 ohms. The battery-light tester will have the light "on" in one direction and "off" in the other.
2. **Shorted condition:** Ohmmeter reading will be zero, or very low in both directions. The continuity tester will have the light "on" in both directions.
3. **Open condition:** Ohmmeter will have a maximum (infinity) reading in both directions. Continuity tester light will be off in both directions.

Diode failure after a 25 hour "run-in" period is generally traceable to external causes such as a lightning strike, reverse current, line voltage spikes, etc. All 6 diodes are essentially in the same circuit. When a diode is stressed to failure, there is no easy method to determine remaining life in the other diodes. To avoid possible continued failures, it is recommended that the entire rectifier assembly be replaced rather than replacing individual diodes.

SERVICE

GENERAL

The service procedures given in this section are those which can reasonably be conducted on-site with a minimum number of special tools and equipment. All service procedures should be conducted by qualified maintenance personnel. Replacement parts may be ordered through an authorized service center or directly from the factory.

FIELD FLASHING

Restoring Residual Magnetism (not applicable on PMG equipped generators)

To restore residual magnetism to the generator, connect a 12 volt battery to the exciter field while the generator using the following procedure:

1. **Shutdown the generator set.** Remove the exciter field leads F+ and F- from the regulator.

CAUTION:

Failure to remove the exciter field leads from the automatic voltage regulator during flashing procedures may destroy the regulator.

2. Connect the F+ and F- leads to the battery's corresponding positive and negative terminals. This should be done using an appropriate length of lead wire to separate the battery from the point of connection (batteries may explode when exposed to an electric arc). After 3 to 5 seconds, remove the F- lead. An inductive arc should result. If no arc is drawn, repeat the procedure.
3. Reconnect the F+ and F- leads to the regulator. Restart the generator and verify that terminal voltage is developed. If terminal voltage does not develop, repeat the field flashing procedure and / or consult the trouble shooting section.

BEARING REMOVAL

Prior to performing this operation, it is suggested that the alternator's shaft be rotated until two of the main rotor poles are in a vertical position. Once the bearing bracket is backed out, the rotor will drop on the main stator core. Having the rotor in this position will limit the amount of rotor drop to that of the air gap. Visually inspect the bearing bore for damage or wear. If worn or damaged, replace prior to reassemble.

Opposite Drive End Bearing Bracket Removal.

Prior to proceeding with bracket removal, disconnect exciter field leads F+ and F- from the automatic voltage regulator and ensure that they are free to move when the bearing bracket is removed. Remove the bearing bracket retaining bolts. Using a pair of screw drivers, wedge the bracket off the frame. After approximately 1/8 inch, the bracket will clear the locating register on the frame and will drop until the rotor is resting on the main stator core. Continue to pull the bracket free from the bearing. Visually inspect the bearing bore and o-ring (if equipped) for damage or wear. If worn or damaged, repair or replace prior to reassembly.

Drive End Bearing Bracket Removal, Two Bearing Units.

Remove any drive arrangement from the generator shaft extension. Remove the bearing lock ring retaining screws. There is no o-ring in the drive end bearing bracket. The shaft extension must be supported before proceeding further. A hoist and sling, jack, or some other means of support with a capacity of 2 tons should be used.

Remove the bearing bracket retaining cap screws. Using a flat bladed screw driver or chisel, pry the bracket back from the frame. After approximately 1/8 inch, the bracket will

clear the locating register on the frame. Lower the shaft extension until the rotor is resting on the main stator core. Continue to pull the bracket free from the bearing. Visually inspect the bearing bore for damage or wear. If worn or damaged, sleeve or replace prior to reassembly.

Reassembly note: Before the bearing bracket is seated against the frame, a threaded rod may be used to help align the inner bearing cap with the bearing bracket.

BEARING REPLACEMENT

Using a bearing puller, remove the existing bearing. It is strongly recommended that the bearing be replaced any time the it is removed from the shaft. ALWAYS install the same type and size bearing that was supplied as original equipment. Order by part number from the parts list, and include the unit serial number and part number when ordering. Heat the bearing to a maximum of 100°C(212°F) in an oven. Apply a thin coat of clean lubricating oil to the press-fit area of the rotor shaft. Using suitable heat resistant gloves, install the bearing over the end of the shaft until it seats against the shaft shoulder. The bearing should slide on the shaft and be seated without excessive force. Should the bearing bind on the shaft prior to being seated against the shoulder, a piece of tubing slightly larger than the press fit area can be used to drive the bearing to its final position. Using light taps with a soft mallet, apply pressure to the inner race only.

RECTIFIER ASSEMBLY REMOVAL

The rectifier assembly cannot be removed until the opposite drive end bearing bracket and bearing have been removed (see bearing removal procedure). Remove the three exciter rotor leads from the heat sinks and the two main rotor leads from the main rotor posts (see Figures 4). Remove the screws securing the rectifier assembly and pull the assembly free from the shaft.

DIODE REPLACEMENT

Prior to installing a replacement diode on the heat sink, apply a thin film of conductive heat sink compound around the base of the diode (do not coat the threads). When installing a diode on the heat sink, care should be taken not to over torque the retaining nut which could cause damage to the device. Torque to 28 pound-inches. If not damaged, the existing diode lead wire may be unsoldered from the failed diode, and resoldered on the replacement.

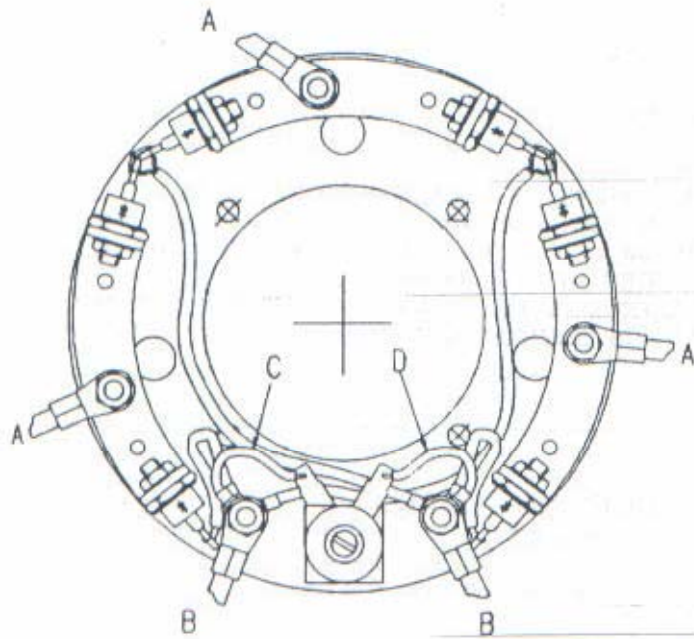

430 FRAME

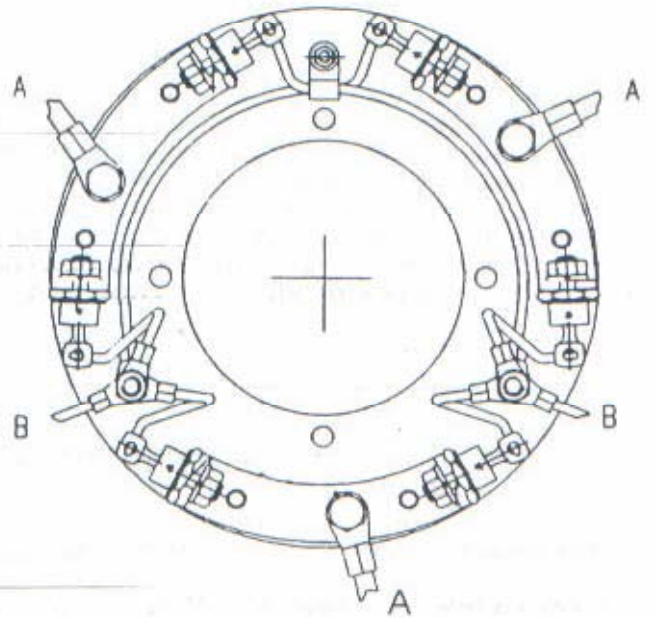

280 / 360 FRAME

A-Exciter Rotor Lead, B-Main Rotor Lead, C-Red(+)Suppressor Lead, D-Black(-)Suppressor Lead

FIGURE 4: ROTATING RECTIFIER ASSEMBLY

RETURNED GOODS

Contact Marathon Electric Manufacturing Corporation for authorization before returning any product. We can not be responsible for any items returned without authorization.

CAUTION

Single bearing generators must have their rotor assembly properly secured to prevent damage during transit to the factory, or to an authorized service center.

TROUBLESHOOTING

This section is intended to suggest a systematic approach to locating and correcting generator malfunctions. The section is arranged according to the symptoms of the problem. The steps have been arranged in an attempt to do the easy checks first and prevent further damage when troubleshooting a disabled machine.

The first step of troubleshooting is to gather as much information as is possible from operating personnel and individuals present during the failure. Typical information includes: how long the unit had been operating; what loads were on line; weather conditions; protective equipment that did or did not function. In addition, information as to the operating condition of the generator's prime mover is vital. Has the prime mover been maintaining constant speed? If not, have there been extended periods of under speed operation? Has the prime mover experienced an over-speed condition? If yes, what was the maximum speed, and how long did the unit operate at the elevated speed?

The generator speed should be maintained at rated nameplate value during all operating tests. The frequency of the generator depends upon rotational speed. Most regulators used with MagnaPLUS generators have built in under frequency protection such that if the speed is reduced more than 5%, the voltage will drop off rather rapidly with further reductions in speed.

WARNING

HIGH VOLTAGES MAY BE PRESENT AT THE GENERATOR'S TERMINALS WHEN THE UNIT IS RUNNING. SOME ACCESSORY EQUIPMENT SUCH AS SPACE HEATERS MAY BE ENERGIZED FROM AN OUTSIDE POWER SOURCE WHEN THE UNIT IS AT REST. TOOLS, EQUIPMENT, CLOTHING AND YOUR BODY MUST BE KEPT CLEAR OF ROTATING PARTS AND ELECTRICAL CONNECTIONS. SPECIAL PRECAUTIONS MUST BE TAKEN DURING TROUBLESHOOTING SINCE PROTECTIVE COVERS AND SAFETY DEVICES MAY BE REMOVED OR DISABLED TO GAIN ACCESS AND PERFORM TESTS. BE CAREFUL. SERIOUS PERSONAL INJURY OR DEATH CAN RESULT FROM THESE HAZARDS. CONSULT QUALIFIED PERSONNEL WITH ANY QUESTIONS.

GENERATOR PRODUCES NO VOLTAGE CHECK AND REMEDY

CAUSE	CHECK AND REMEDY
Voltmeter off or defective	Check voltage with a separate meter at the generator terminals.
Incorrect or defective connections	Verify generator connections. See drawings supplied with the generator or lead connection diagrams in this manual. Inspect all wiring for loose connections, open circuits, grounds, and short circuits.
Loss of residual	Flash the field. Refer to field flashing in the service section. If the generator is equipped with a PMG, field flashing is not necessary-check regulator fuse and input power from the PMG.
Defective diodes, suppressor, or windings	Test the generator using the 12 volt battery test as specified in the testing section. If the results indicate generator problems, perform insulation, continuity, and diode tests as specified in the testing section.
Regulator protection operating	Adjust regulator. Consult regulator manual.
Regulator inoperative	Adjust or replace regulator. Consult regulator manual.

GENERATOR PRODUCES LOW VOLTAGE, NO LOAD CHECK AND REMEDY

CAUSE	CHECK AND REMEDY
Underspeed operation	Check speed using a tachometer or frequency meter.
Voltmeter off or defective	Check voltage with a separate meter at the generator terminals.
Incorrect or defective connections	Verify generator connections. See drawings supplied with the generator or lead connection diagrams in this manual. Inspect all wiring for grounds, open circuits and short circuits.
Loss of regulator power	Check regulator fuse and input power. Input power is produced by the generator's residual voltage or from an optional PMG.
Regulator adjustment	Adjust regulator settings. Consult regulator manual.
Regulator incorrectly connected	Review the generator connection diagram or reference the regulator manual.
Defective diodes, suppressor, or windings	Test the generator using the 12 volt battery test as specified in the testing section. If the results indicate generator problems, perform insulation, continuity, and diode tests as specified in the testing section.
Regulator inoperative	Adjust or replace regulator. Consult regulator manual.

GENERATOR PRODUCES LOW VOLTAGE WHEN LOAD APPLIED

CAUSE	CHECK AND REMEDY
Excessive load	Reduce load. The load on each leg should be evenly balanced, and rated current should not be exceeded on any leg.
Large motor starting or low load power factor	Motor starting currents are too large for the generator. When starting multiple motors, sequence the motors and start the largest motors first. Reduce lagging power factor load.
Driver speed droop or belt slip	Check driver. If belt driven, check belt tension. Check under frequency setting on regulator. Under frequency voltage roll-off may be activated.
Reactive droop	If the generator is equipped for parallel operation, some droop is normal as reactive load increases. When operating as a single unit, the parallel CT can be shorted to eliminate this effect. Refer to Regulator manual.
Line drop	If voltage is proper at generator terminals but low at load terminals, increase external wire size.
Defective diodes, suppressor, or windings	Test the generator using the 12 volt battery test as specified in the testing section. If the results indicate generator problems, perform insulation, continuity, and diode tests as specified in the testing section.

GENERATOR PRODUCES FLUCTUATING VOLTAGE

CAUSE	CHECK AND REMEDY
Fluctuating engine speed	Check engine and governor systems for malfunctions. Check load for fluctuation.
Regulator stability	Adjust Regulator stability. Refer to Regulator manual.
Regulator external rheostat	Replace defective or worn rheostat. Use shielded cable to minimize electrical noise.
Defective rectifier assembly	Check assembly for loose connections. Test the diodes as specified in the test section.
Loose terminal or load connections	Improve connections both mechanically and electrically.
Defective regulator	Replace regulator.

GENERATOR PRODUCES HIGH VOLTAGE

CAUSE	CHECK AND REMEDY
Faulty metering	Check voltage with separate meter at generator terminals.
Incorrect connections	Verify generator connections. Refer to drawing supplied with the generator or connection diagrams in this manual.
Regulator adjustments	Adjust regulator. Consult regulator manual.
Leading power factor	Check the power factor of the load. If power factor is leading, change load configuration. Excessive leading power factor (capacitors) can cause voltage to climb out of control.
Incorrect regulator connection	Verify regulator voltage sensing is connected correctly. Consult regulator manual.
Defective regulator	Replace regulator.

GENERATOR BUILDS VOLTAGE FROM STARTUP, THEN GOES TO LOW(RESIDUAL) VOLTAGE

CAUSE

CHECK AND REMEDY

Regulator protective circuit operating

Check indicators on regulator. Correct problems and adjust regulator as is required. Refer to regulator manual.

GENERATOR IS OVERHEATING

CAUSE

CHECK AND REMEDY

Generator is overloaded

Reduce load Check with ammeter and compare with nameplate rating.

Clogged ventilating screens

Clean air passages.

High room temperature or altitude

Improve ventilation or reduce load.

Insufficient circulation of cooling air

Generator location and enclosure design must provide adequate air flow and minimize recirculation of hot air.

Unbalanced load

The load on each leg should be as evenly balanced as possible and should not exceed rated current on any one leg.

GENERATOR PRODUCES MECHANICAL NOISE

CAUSE

CHECK AND REMEDY

Defective bearing

Replace bearing.

Loose or misaligned coupling

Tighten, realign, or replace coupling.

Belt slap or loose guards

Check belt tensioning. Check belt guard fasteners.

EQUIPMENT RUNS NORMALLY ON UTILITY POWER, BUT WILL NOT RUN ON GENERATOR SET

CAUSE

CHECK AND REMEDY

Distorted voltage waveform

Analyze load. Excessive SCR (thyristor) loading will cause distortion. Some equipment may be sensitive to distorted waveforms. Refer to Marathon Electric.

Improper generator voltage or frequency

Check name plates of devices comprising the load. Compare required voltage and frequency with that of the generator. Adjust driver speed and/or generator voltage as necessary to match generator output to load requirements.

CAUTION: Compare required voltage, frequency, and KVA with generator nameplate to ensure adequate generator capacity. If in doubt, consult Marathon Electric for information regarding generator capacity.

SPECIFICATIONS

MODEL / FRAME SIZE	EXCITER RESISTANCE	
	STATOR	ROTOR
281, 282, 283, 284	23.0	.120
361, 362, 363—three phase	23.5	.120
361, 362, 363—dedicated single phase	23.0	.135
431, 432, 433—three phase	20.33	.076
431, 432—dedicated single phase	18.0	.105

MODEL	GENERATOR RESISTANCE		EXCITER FIELD NO LOAD VOLTS 480 V / 60HZ	NO LOAD TERMINAL VOLTAGE WITH 12 VDC FIXED EXCITATION HIGH WYE / 60 HZ HIGH WYE / 50 HZ	
	STATOR*	ROTOR			
281PSL1500	4.20	.400	11.0	485	400
281PSL1501	4.15	.400	11.0	490	404
281PSL1502	3.20	.439	9.0	528	435
282PSL1503	2.00	.470	10.4	500	415
282PSL1504	1.51	.512	11.3	490	400
282PSL1505	1.00	.575	10.0	515	415
283PSL1506	.681	.654	11.0	495	400
283PSL1507	.480	.758	12.0	480	390
284PSL1508	.346	.875	12.0	480	375
361PSL1600	.381	.750	11.8	485	400
361PSL1601	.264	.810	12.5	475	385
361PSL1602	.181	.990	14.1	460	370
362PSL1604	.138	1.05	12.2	480	380
362PSL1606	.0980	1.20	10.8	500	405
363PSL1607	.0692	1.37	12.2	475	380
431PSL6202	.0214	.8114	15.1	440	360
431PSL6204	.0477	.6373	13.6	455	385
431PSL6206	.0371	.6793	13.82	455	370
431PSL6208	.0133	.715	12.20	475	390
432PSL6210	.0214	.8114	15.1	440	360
432PSL6212	.0226	.8656	14.1	445	385
433PSL6216	.01215	1.0672	16.2	425	345
433PSL6220	.01214	.9743	15.6	430	350

* Stator resistance measured line to line in a high wye connection.

DEDICATED SINGLE PHASE	GENERATOR RESISTANCE		EXCITER FIELD NO LOAD VOLTS / 60 HZ
	STATOR	ROTOR	
281PSL1511	1.420	.381	8.3
281PSL1512	1.106	.395	8.1
281PSL1513	.632	.430	8.7
282PSL1514	.436	.450	9.2
282PSL1515	.240	.520	9.7
283PSL1516	.160	.620	13.3
284PSL1517	.0918	.760	12.2
284PSL1518	.0610	.857	16.6
361PSL1611	.0695	.750	17.5
361PSL1612	.0434	.857	16.1
361PSL1613	.0369	.926	13.6
362PSL1615	.0191	1.20	17.0
363PSL1617	.0119	1.35	23.0
431PSL1811	.0248	.516	9.9
431PSL1813	.0129	.615	13.8
432PSL1814	.00931	.643	15.1
432PSL1815	.00723	.852	11.2

PARTS LIST – SINGLE BEARING Typical Generator Cross Section

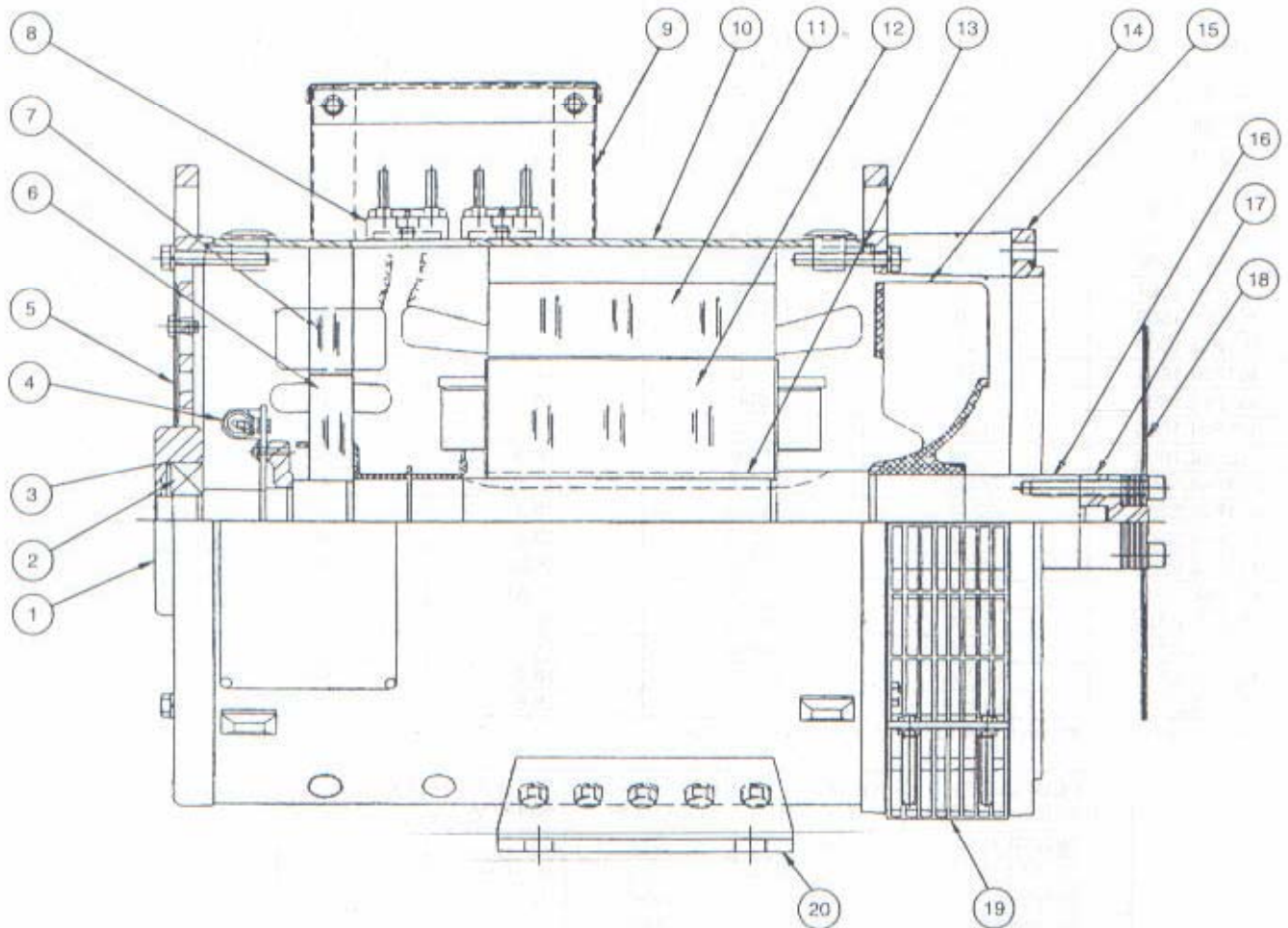

Reference Number	Part Name	Reference Number	Part Name
1	End Bracket(under end cover 360 & 430 frames)	11	Main Stator
2	Bearing	12	Main Rotor
3	O-ring(280 frame only)	13	Rotor Integral Keyway
4	Rectifier Assembly	14	Fan
5	Air Intake Screen (280 frame only)	15	Mounting Adapter (SAE)
6	Exciter Sotor	16	Shaft
7	Exciter Stator	17	Drive Hub
8	Link Board (terminal block)	18	Drive Disk (SAE)
9	Conduit Box	19	Exhaust Screen (drip cover not shown)
10	Generator Frame	20	Mounting Base

Note: Illustration above is a 280 frame MagnaPlus. Other Frame sizes are typical. Optional PMG not shown. The generator model and serial numbers are required when ordering parts.

SECTION C:

WIRING SCHEMATICS

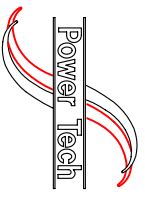

POWER TECHNOLOGY SOUTHEAST, INC.
 634 STATE ROAD 44
 LEESBURG, FLORIDA 34748-8102
 (352)365-2777 FAX (352)787-5545

FOR : MIL AIR EQ36
 TYPE: DC CONTROL WIRING MIL AIR EQ36
 PART :
 DWN. BY : KEVIN MILLER

DATE : 28MAY08
 SCALE : NOT TO SCALE

SHEET
1 of 1

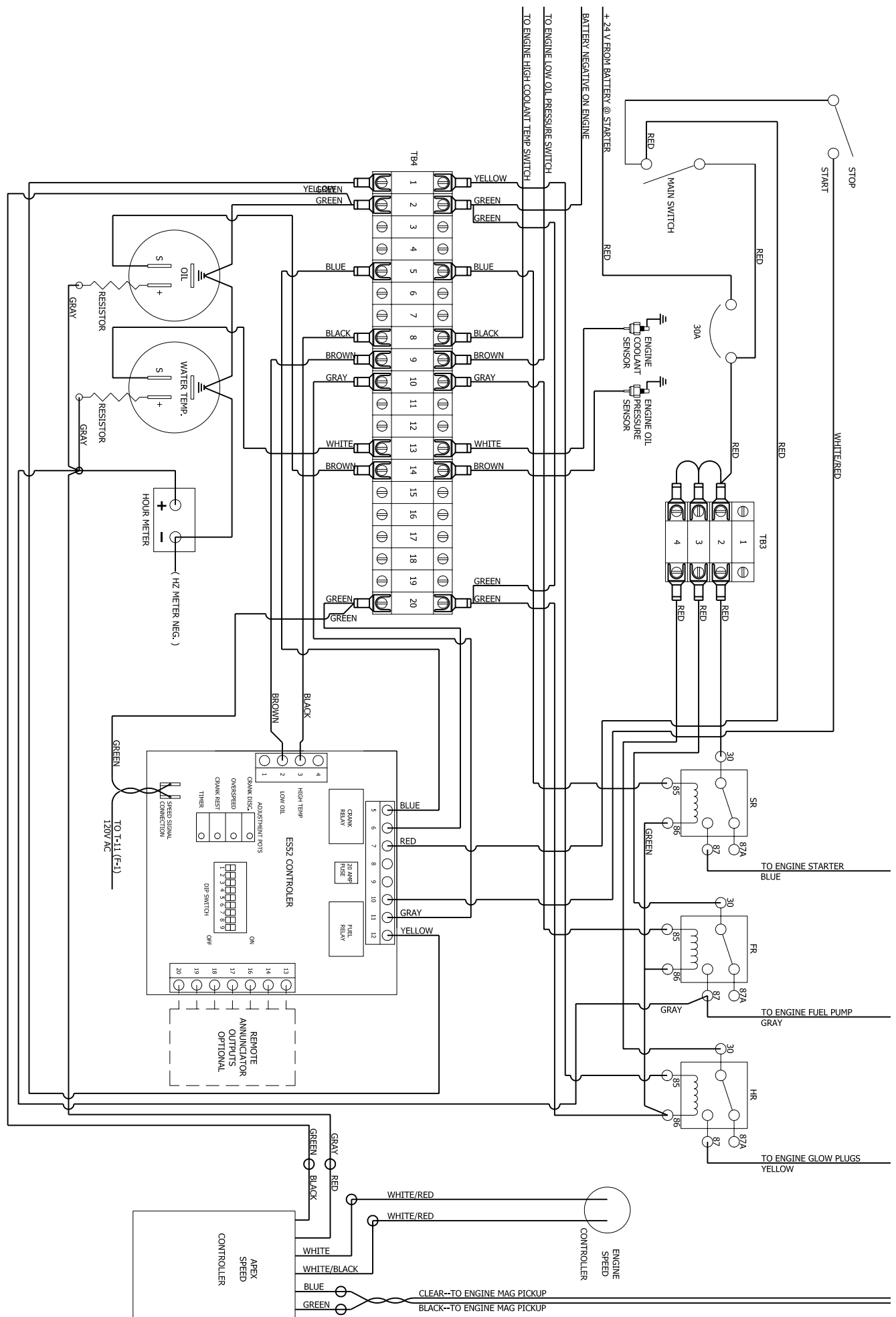

STOP
START

+ 24 V FROM BATTERY @ STARTER
BATTERY NEGATIVE ON ENGINE

TO ENGINE LOW OIL PRESSURE SWITCH
TO ENGINE HIGH COOLANT TEMP SWITCH

MAIN SWITCH

30A
ENGINE OIL PRESSURE SENSOR
COOLANT PRESSURE SENSOR

TB3
1 RED
2 RED
3 RED
4 RED

TO ENGINE STARTER BLUE

TO ENGINE FUEL PUMP GRAY

TO ENGINE GLOW PLUGS YELLOW

ENGINE SPEED CONTROLLER

CLEAR--TO ENGINE MAG PICKUP
BLACK--TO ENGINE MAG PICKUP

APEK SPEED CONTROLLER

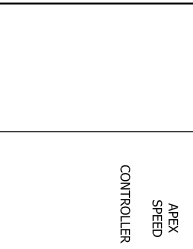
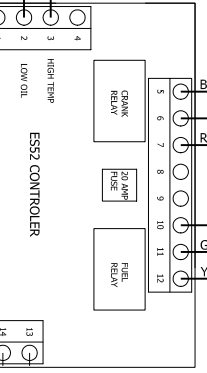

TO T-141 (F-1)
120V AC

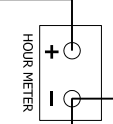
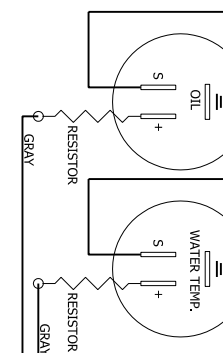

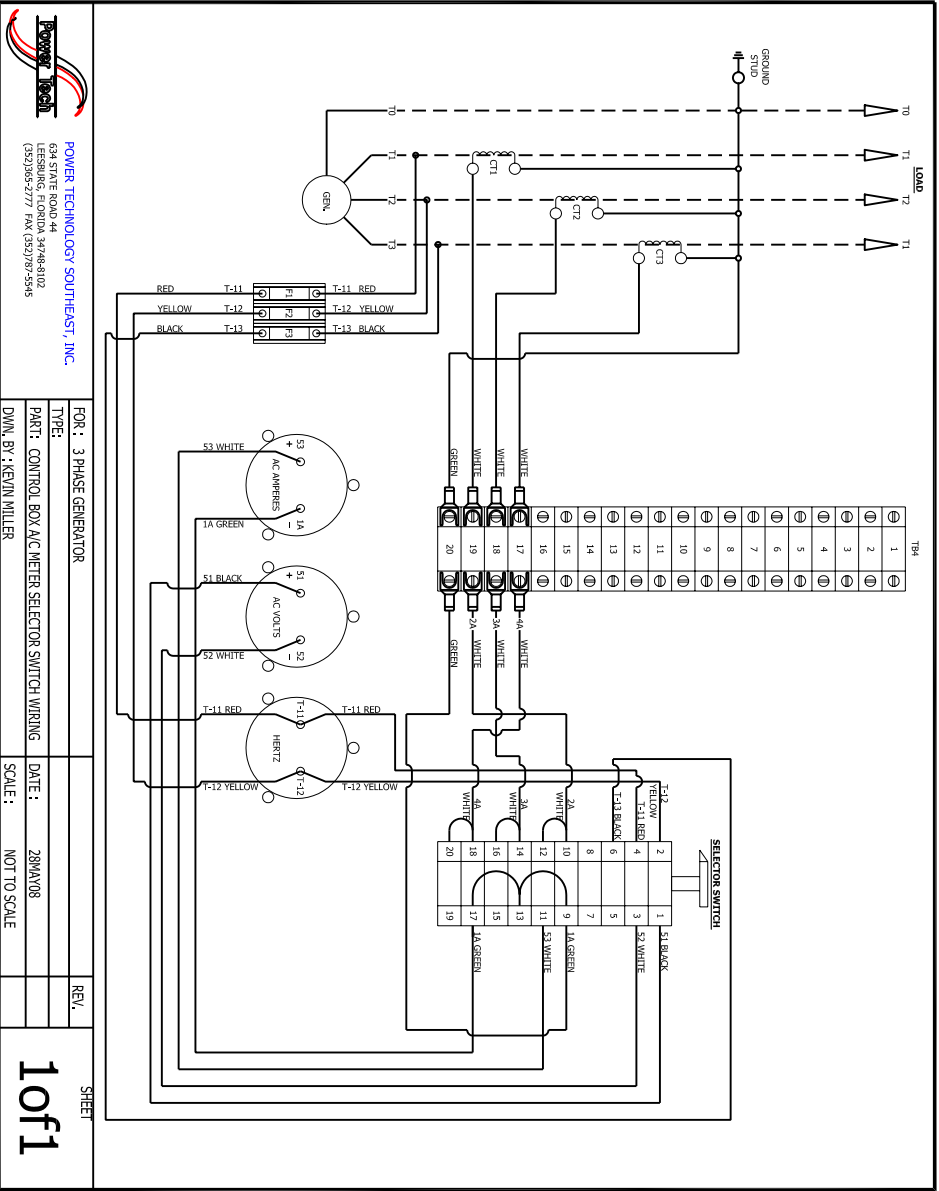

Power Tech
 POWER TECHNOLOGY SOUTHEAST, INC.
 634 STATE ROAD 44
 WOODBRIDGE, VA 22191
 (520)565-2777 FAX (520)787-5945

FOR: 3 PHASE GENERATOR
 TYPE: CONTROL BOX AC METER SELECTOR SWITCH WIRING
 PART: CONTROL BOX AC METER SELECTOR SWITCH WIRING
 DWN. BY: KEVIN MILLER
 DATE: 28MAY08
 SCALE: NOT TO SCALE

REV. _____
 SHEET
1 of 1

SECTION D:

GENERATOR END
TROUBLESHOOTING GUIDE

