

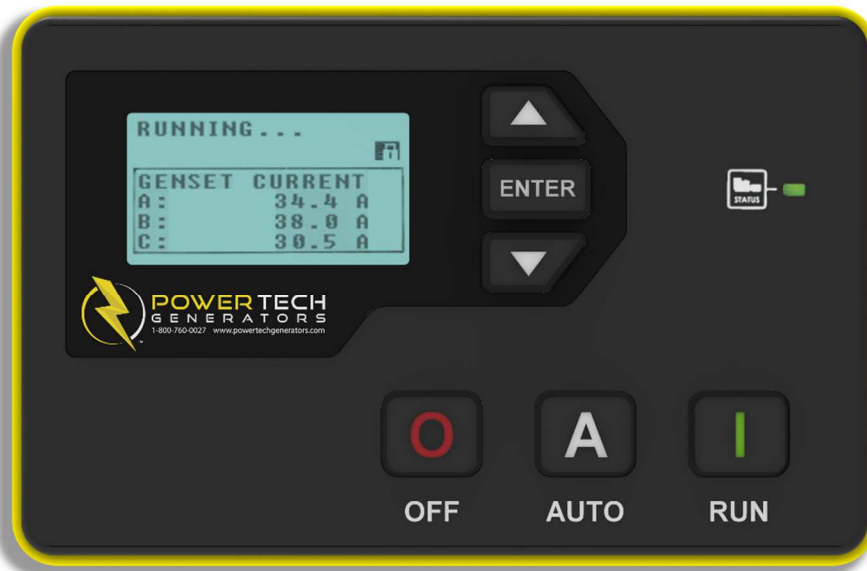

POWERTECH
GENERATORS
SOLUTIONS FOR MOBILE APPLICATIONS

TRP REMOTE PANEL



INSTALLATION GUIDE



! WARNING:

Breathing diesel engine exhaust exposes you to chemicals known to the State of California to cause cancer and birth defects or other reproductive harm.

- Always start and operate the engine in a well-ventilated area.
- If in an enclosed area, vent the exhaust to the outside.
- Do not modify or tamper with the exhaust system.
- Do not idle the engine except as necessary.

For more information go to www.P65warnings.ca.gov/diesel

! WARNING:

This product can expose you to chemicals including carbon monoxide and benzene, which are known to the State of California to cause cancer and birth defects or other reproductive harm.

For more information go to www.P65Warnings.ca.gov.

TABLE OF CONTENTS

Table of Contents	3
Foreword	4
Safety	5
Safety Notes	5
Operating Safety	6
Introduction.....	11
Interface	12
LCD Display	12
LED Status Light	12
Buttons	13
Controller Operation.....	14
Modes.....	14
Viewing Parameters	14
Event History	15
Installation	16
Mounting.....	16
Wiring	17
Mounting Diagram.....	18
Revisions.....	19



FOREWORD

Thank you for your purchase of a PowerTech generator set. It is engineered to the utmost quality standards, manufactured in a strict quality control environment, and will assure you a long, satisfactory service. To have the best performance from your PowerTech generator, please fully read and understand this manual.

This installation guide is written to provide you with the information you need to install, operate, and understand the TRP remote panel. This manual was up to date at time of printing/downloading, due to our continuous improvement of our products, we reserve the right to change the information contained in this manual without notice.

For more complete information on the safe operation and maintenance of your generator, refer to the Operation and Maintenance Manual supplied with your generator.

For technical questions on your generator please contact your sales dealer, one of our authorized service centers or PowerTech's Customer Service Department at 1-800-760-0027. To expedite your call, please have the generator model and serial numbers available.

For service parts, please contact PowerTech's Parts Department at 1-800-760-0027 or order directly from our website at www.powertechgenerators.com.



**634 SR 44 W.
Leesburg, FL 34748
Toll Free: 800-760-0027
Fax: 352-787-5545
www.powertechgenerators.com**

SAFETY

SAFETY NOTES



This symbol indicates a safety alert. It is used to indicate potential personal injury hazards. Obey all safety messages that follow this symbol to avoid possible injury and death.

This manual has several types of safety precautions and instructions: DANGER, WARNING, CAUTION, NOTICE, and Note.

DANGER

Danger indicates the presence of a hazard that ***will cause severe personal injury, death, or substantial property damage.***

WARNING

Warning indicates the presence of a hazard that ***can cause severe personal injury, death, or substantial property damage.***

CAUTION

Caution indicates the presence of a hazard that ***will or can cause minor personal injury or property damage.***

NOTICE

Notice communicates installation, operation, or maintenance information that is safety related but not hazard related.

Note

Note indicates additional important or helpful information.

OPERATING SAFETY



Before operating this generator, be sure to read and understand all instructions. This generator set has been designed for safe operation in a specific application. **DO NOT** modify or use this generator set for any application other than that it has been designed for. Improper usage can cause damage, injury, or death. All installation and service work must be performed by properly trained and qualified personnel. Electrical installation, troubleshooting, and repair should only be performed by a qualified electrician.

The following guidelines should always be obeyed.

- Read, understand and follow all safety precautions and warnings before operating the generator set.
- Be sure to read and follow all safety decals affixed to the generator set.
- **DO NOT** modify the generator set. Unauthorized modifications may affect the life of the generator set; as well as, result in injury or death.
- The area around the generator set should be clean and free of debris.
- **DO NOT** operate machinery or equipment while under the influence of alcohol, medication, other drugs, or while fatigued.
- When connecting the generator set, be sure to follow any local, state, and National Electric Code (NEC) guidelines.

Accidental Start-up

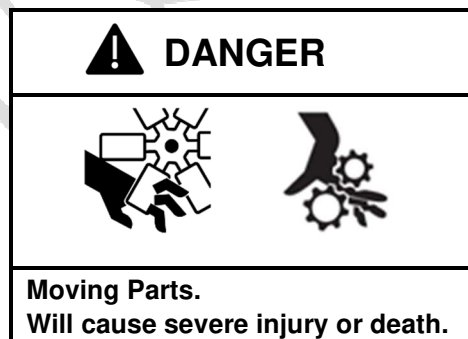
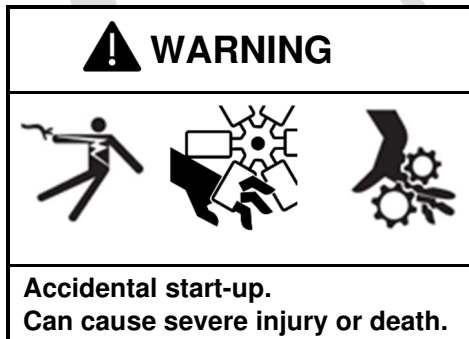

This generator set may start without warning. While in operation, there may be exposed moving parts.

- Before working on the generator set or connected equipment, ensure the generator set is disabled. The genset may be disabled by first properly shutting down the generators set. Next, disconnect the battery cables, negative (-) lead first, and/or turn the battery disconnect switch (if equipped) to the OFF position.

Moving Parts

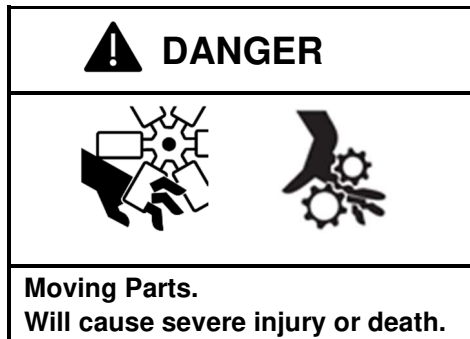

While in operation, there may be exposed moving parts.

- **DO NOT** wear loose, torn, or bulky clothing around the generator set.
- Be sure all guards and shields are in place before operating the generator set.
- Keep your hands and body away from all rotating parts, such as cooling fan, belts, pulleys, etc.
- Stop and disable the generator set before servicing.

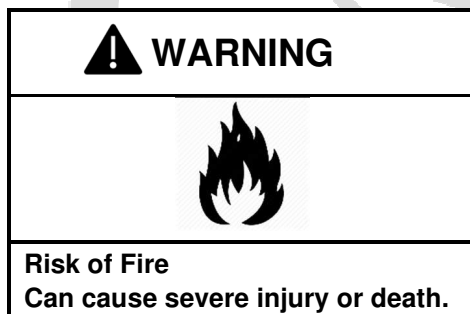

Fire



A fire can cause severe injury or death. To reduce the risk of fire:

- **DO NOT** smoke near the fuel system or fuel tank.
- **DO NOT** operate the generator set in the vicinity of spilled fuels or flammable vapors.
- **DO NOT** operate the generator set in the presence of fuel leaks, fuel accumulation, or other flammable materials.
- Keep the engine and engine bay clean and free of accumulated dirt, grease, and trash.
- Keep the genset idling for 5-6 minutes before stopping. Temperatures around the genset may increase suddenly.
- **DO NOT** fill the fuel tank near open flames or while smoking.
- Shut down the generator set and allow it to cool before fueling.
- **DO NOT** run the generator set with a damaged, loose, or missing fuel cap.
- If fuel or lubricants spill, clean up immediately and properly dispose of.
- **DO NOT** attempt to use ether or other starting aids. Doing so may cause a flash fire and/or damage the engine.
- Inspect and replace any damaged wiring if necessary.

Engine Exhaust

 WARNING

Carbon Monoxide Can cause severe nausea, fainting, or death.

During operation, the generator set will release engine exhaust into the surrounding atmosphere. This exhaust contains carbon monoxide, an odorless, colorless, tasteless, nonirritating gas. The inhalation of carbon monoxide, even for a short period, can result in death. To reduce the risk of carbon monoxide poisoning:

- Avoid breathing engine exhaust while working on or around the generator set.
- **DO NOT** run the generator indoors unless the exhaust is routed outside properly.
- Routinely inspect the exhaust system for leaks and repair if necessary.
- **DO NOT** operate the generator set where exhaust fumes can accumulate and/or leak into an occupied space.
- **DO NOT** operate the generator set without a properly functioning exhaust system.

Carbon monoxide poisoning symptoms include the following:

- Dizziness, Light Headedness
- Physical Fatigue
- Weakness in muscles and joints
- Sleepiness
- Inability to Concentrate
- Mental Fatigue
- Blurred Vision
- Inability to Speak Clearly
- Stomachache, Nausea, and/or Vomiting

If you experience any of these symptoms, immediately seek fresh air. Remain active and do not sit, lie down, or fall asleep. Seek immediate medical attention if the symptoms do not improve when breathing fresh air.

Voltage Hazard



Whenever electricity is present, there is an electrocution risk. Following proper safety procedures can reduce the risk of electrocution.

- When connecting the generator set, be sure to follow any local, state, and National Electric Code (NEC) guidelines.
- Shut down the generator set and turn off all breakers before servicing the unit.
- Never make electrical connections while standing in water or on wet ground.
- Use extreme caution when testing voltage. It is advisable to have a trained and qualified person take the measurements.
- Inspect and replace any damaged wiring if necessary.
- Make sure all electrical covers are in place before operating the genset.

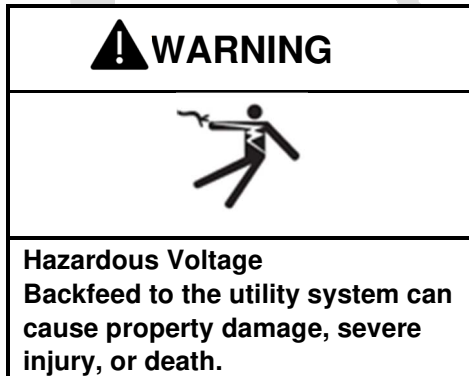



Whenever the generator set is connected as standby power, a transfer switch is required to prevent electrical backfeed into the utility electrical grid. Electrical backfeed is illegal and can result in the severe injury or death of utility company personnel working on power lines. The generator set must be installed following local, state, and National Electric Code (NEC) guidelines.

Burn Hazard

 WARNING

Hot Engine and Exhaust System Can cause severe injury or death.

 WARNING

Hot Coolant and Steam Can cause severe injury or death.

During operation, some components of the generator set can become extremely hot. These parts include, but are not limited to, the engine, exhaust manifold and piping, muffler, generator end, and voltage regulator. In addition, the engine coolant can become extremely hot and cause pressure to build up in the cooling system. Removing the pressure cap, before allowing the generator set to cool down, could cause hot coolant and/or steam to be released, resulting in severe injury or death.

- **DO NOT** touch or lean against hot exhaust or engine components.
- Allow the generator set to cool down completely before servicing.
- Never make electrical connections while standing in water or on wet ground.



INTRODUCTION

The TRP digital remote panel is designed to mimic the control panel installed on the generator set. It provides generator control and supplies all of the information displayed on the local controller in a more accessible and convenient location.

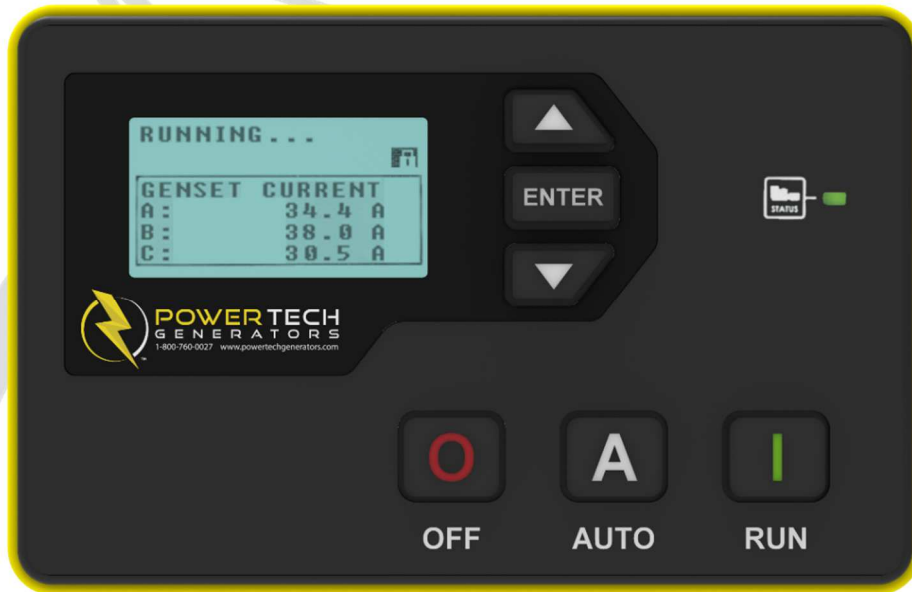

INTERFACE

LCD DISPLAY

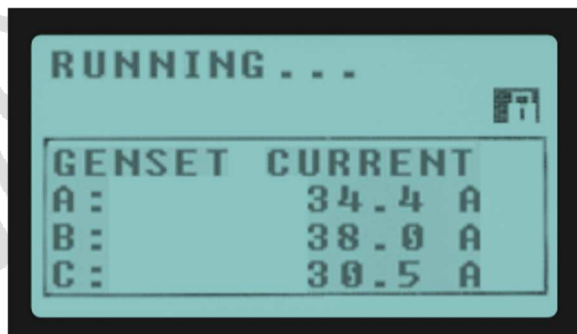

The LCD display is the primary source of information on the controller. The LCD display allows you to view and change settings, monitor engine sensors, and monitor generator output.

LED STATUS LIGHT

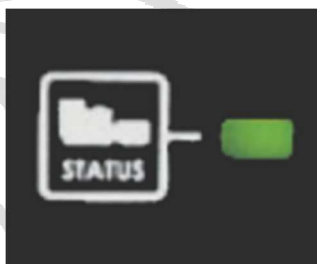







In addition to the LCD Display, the PTG series controller also has a Status LED on the front face. The Status LED color changes to show the status of the generator set.

- **Green** = Engine running with no issues
- **Amber** = Engine running with one or more warnings
- **Red** = Engine shut down for a failure



BUTTONS

The PTG series controller is controlled by the 6 buttons on the front face. The function of each buttons is described in the following chart.

Item	Name	Description
	OFF Button	Used for turning off the generator set or exiting out of AUTO mode. NOTE: The OFF button is not intended to function as an Emergency Stop. There are conditions in which it may not shutdown the generator set.
	AUTO Button	Used for placing the controller into AUTO mode. Once in AUTO mode the controller waits for a start command to be received.
	RUN Button	Used to start the engine manually. The OFF button must be used to shut down the engine if manually started from front panel.
	UP Button	Used for moving around in the menu, changing a settings value, or changing the currently displayed parameter page.
	ENTER Button	Used for entering the menu system, accepting settings, or locking the LCD screen when viewing parameters.
	DOWN Button	Used for moving around in the menu, changing a settings value, or changing the currently displayed parameter page.



CONTROLLER OPERATION

MODES

The following table describes the different operating modes of the controller:

Mode / State	Description
OFF	When in the OFF mode, the generator set is shutdown and cannot be remotely started. The generator set can be started manually from the local controller.
AUTO	When in the AUTO mode, the controller waits to receive an external start signal from a remote panel, transfer switch or other device.
RUNNING	When the generator set is running, the controller monitors engine & generator parameters and waits to receive a stop command.
FAILURE	When a failure occurs, the controller shuts down the generator set and displays the reason for failure. Unless the generator set is equipped with the remote reset option, the controller cannot be reset or started from a remote source unless the failure is cleared. The failure must be cleared using the OFF button on the local controller.

VIEWING PARAMETERS

Various engine and generator parameters can be viewed on the LCD display. The parameters will automatically scroll, but by pressing the UP or DOWN buttons you can scroll through to the information you want to see. Once on the information desired, press the ENTER button to lock the screen and prevent it from automatically scrolling. A lock icon will appear to signify that the display is locked. Press the ENTER button again to unlock it. What parameters are displayed depends on what mode the controller is in. If a parameter is highlighted, that indicates the parameter is outside the acceptable range and either a warning or fault will be displayed as well.

In OFF mode, no parameters are available.

In AUTO mode, the following parameters are available:

- Battery Voltage
- Engine Temperature
- Oil Pressure
- Engine Hours

While running, the following parameters are available:

- Battery Voltage
- Engine Temperature

- Oil Pressure
- Engine Hours (Total running time)
- Running Time (Current running time)
- Engine Speed
- AC Frequency
- Genset Voltage
- Genset Current (PTG410 local controller only)

EVENT HISTORY

The TRP remote panel can access the Event History stored on the local controller. Events range from starting and stopping to warnings and failures. Information stored in the Events History may be useful in determining when the generator set was last run, why the generator set shut down, and other troubleshooting.

To access the Event History:

- Press the OFF button to put the controller in OFF mode. The controller must be in the OFF mode in order to access the Event History.
- Press the ENTER button to bring up the menu.
- Use the UP or DOWN buttons to scroll until **Events History** is highlighted.
- Press the ENTER button to access the Event History.
- Once in the Event History, use the UP or DOWN buttons to scroll through all the stored events.
- Press the ENTER button to exit the Event History.

Each event in the Event History entry will have the following information:

- What event number it is out of the total number of events stored. The most recent events are displayed first and with the lowest number.
- The type of event
 - EVENT = Informational items
 - WARNING = A fault that needs to be corrected but did not result in a shutdown of the generator set.
 - FAILURE = A severe fault that resulted in the shutdown of the generator set. This needs to be corrected before attempting to restart the generator set.
- A description of the event.
- The time and date the event occurred.

Pressing and holding the OFF button will exit the menu and take you back to the main screen.



INSTALLATION

MOUNTING

The TRP Remote Panel should be firmly mounted on a sturdy, immovable surface where it is free of vibration, extreme temperatures, and exposure to liquids and condensation. There must also be enough space behind the mounting location to allow for the remote panel and wiring to recess without pinching the wires. A diagram is provided to aid in the location of the cut-out & mounting holes.

Improper mounting of the TRP Remote Panel can cause damage to the panel, mounting surface and/or the generator set

1. Cut out the opening in the mounting surface as shown in the diagram.
2. Loosen the screws in the mounting clip until they are flush with the surface of the clip.
3. Slide the clip towards the front of the display and remove.
4. Insert the remote panel into the cutout in the supplied mounting bracket.
5. Reinsert the clips into the slots in the remote panel and slide them toward the rear of the panel.
6. Tighten the screws until the panel is secure. **DO NOT** over tighten the screws. Over tightening the screws could result in damage to the panel and/or the mounting bracket.
7. Attach the wiring connections.
8. Insert the mounting bracket with remote panel installed into the cutout in the mounting surface.
9. Attach the mounting bracket to the mounting surface with appropriate hardware.

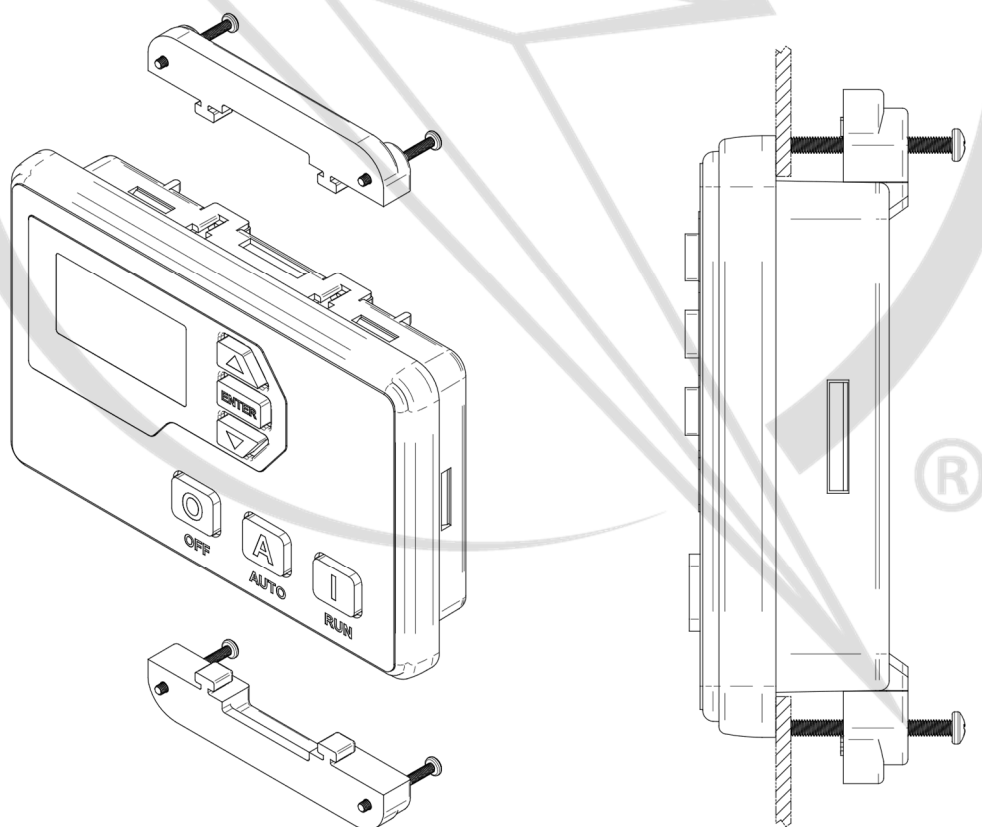

WIRING

To aid in installing the TRP Remote Panel, various remote harnesses are available in standard lengths of 15', 25', 35' & 50'. Contact PowerTech's Sales Department for assistance in selecting a remote harness.

If a remote harness is not purchased, a kit (part # 07CKTG) is available containing the connectors and pins required for connecting to the back of the remote panel. Reference the following chart to wire the TRP Remote Panel to your generator.

Use minimum 20 AWG wire and appropriate connectors (supplied in connector kit) to wire the panel to the generator, if no remote harness is purchased.

Pin #	Colors	Function	TRP Pin Location
B	Black & Orange (Twisted Pair)	Can High	J6-4
C	White & Orange (Twisted Pair)	Can Low	J6-5
E	Green	Ground (Must be grounded to generator)	J4-3
G	Red	Battery Power (+12VDC)	J4-1

NOTE: Remaining wires are not required for the TRP Remote Panel.

Generator Pigtail Pinout (viewed from wire insertion end of female plug)

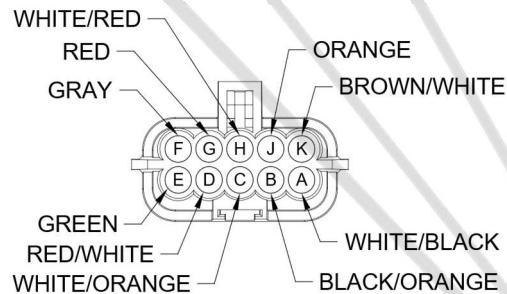

If desired, the connectors and pins can be purchased from the factory for harness construction.

Part	PowerTech Part Number
Male Connector	06P38225
Male Pin	06P31076
Wire Seal	06P39008
Cavity Plug	06P39011



MOUNTING DIAGRAM

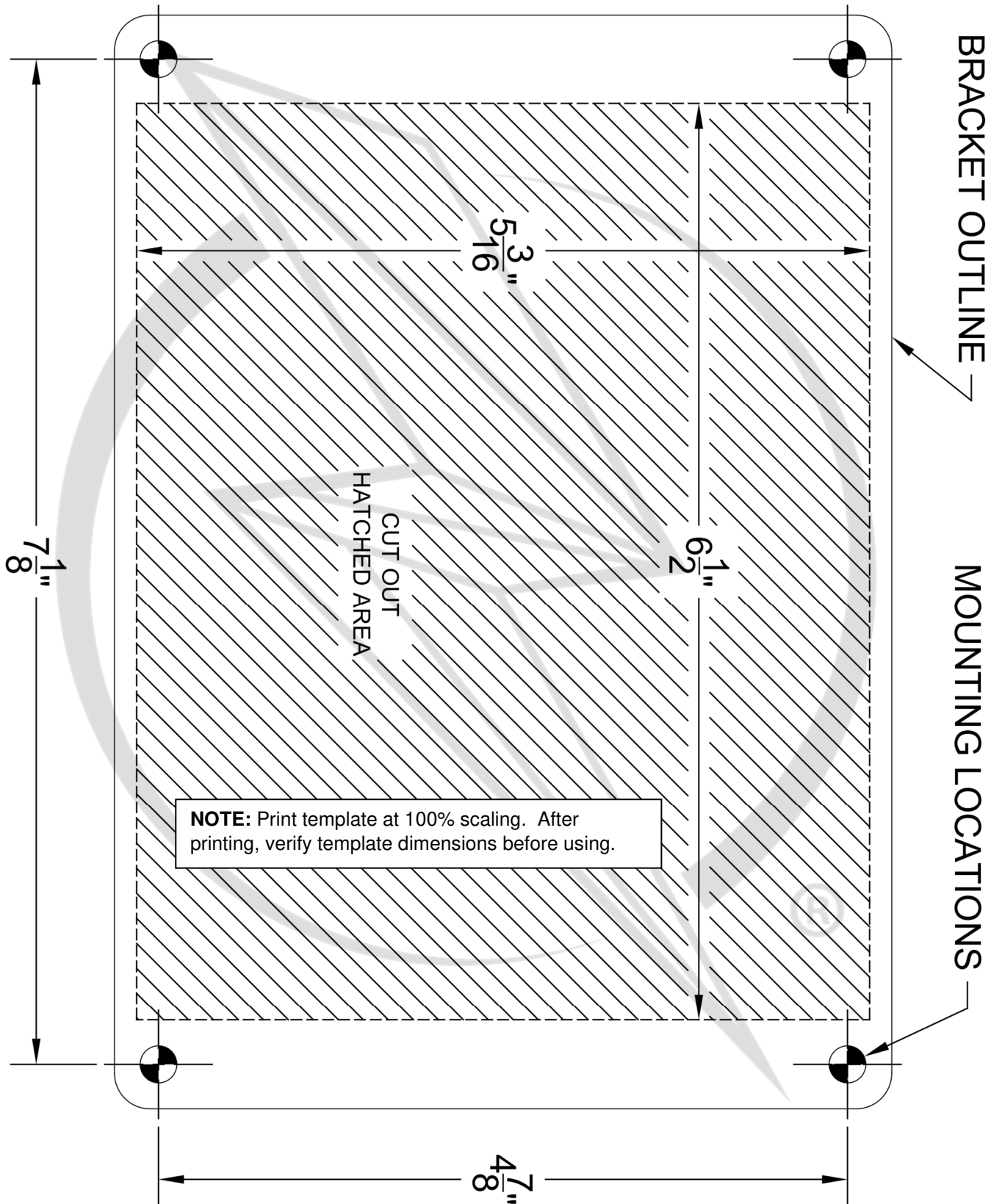

REVISIONS

Revision	Date
Initial Release	10/20/2021