

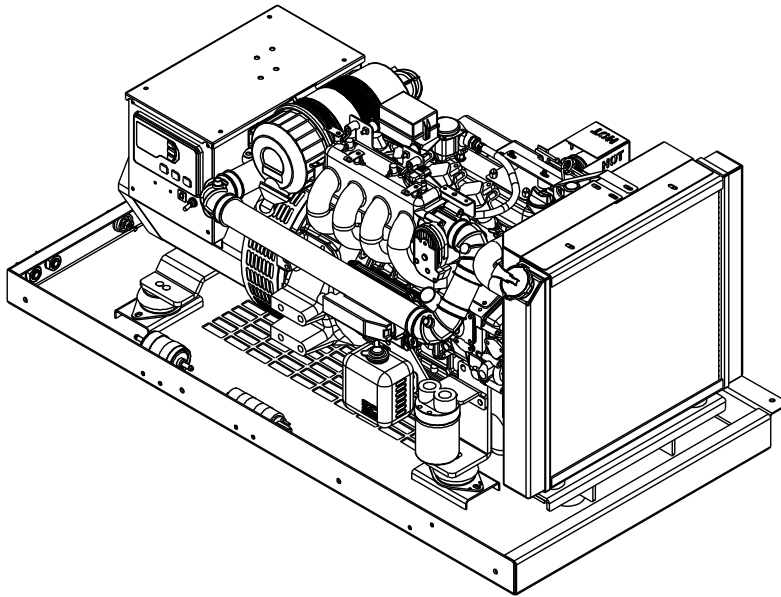

Generating Power to the World

OPERATORS MANUAL

MODEL: PTGK-12/15



Power Technology Southeast
634 State Road 44
Leesburg, FL 34748-8103
Phone: (352)-365-2777
Fax: (352) 787-5545



Generating Power to the World



Generating Power to the World

Table of Contents

FORWARD.....	5
TO OUR CUSTOMERS	5
Limited Warranty on Power Tech Generators.....	6
SAFE OPERATION.....	8
Proposition 65 Warning.....	8
CONDUCTING SAFETY CHECKS AND MAINTENANCE.....	13
Operating the Generator	14
Daily Pre Operational Checks	14
Using the PTG Series Controller.....	14
Front Panel Items.....	15
Using the Menu System	15
Modes, Starting and Stopping Methods.....	16
Engine Specifications.....	17
Engine Maintenance Schedule	18
Engine Oil Maintenance	19
Lubricating Oil Specifications	19
LUBRICATING OIL VISCOSITY	19
RECOMMENDATIONS.....	19
COOLANT RECOMMENDATIONS	20
CHECKING RADIATOR COOLANT LEVEL.....	20
COOLANT SERVICE LIFE	21
CHECKING RESERVOIR TANK	21
COOLANT LEVEL.....	21
CLEANING RADIATOR CORE.....	21
OPERATING HOURS and SERVICE LOG	22
GENERATOR ASSEMBLY INFORMATION.....	23
EXCITER TYPE GENERATOR	23
ELECTRONIC VOLTAGE REGULATION	23
VOLTAGE CONNECTION	23
EXCITER FIELD COIL VOLTAGE SOURCE	24
ROTATING FIELD ASSEMBLY (ROTOR)	24
CORE ASSEMBLY	24



Generating Power to the World

FIELD COIL.....	24
BALANCE.....	24
BEARING	25
STATOR ASSEMBLY	25
TROUBLESHOOTING	26
TROUBLE	26
POSSIBLE CAUSE	26
SUGGESTED ACTION	26



Generating Power to the World

FORWARD

You are now the proud owner of a Power Technology Southeast generator set, powered by an industrial Isuzu diesel engine. This generator set is a Part of Power Tech's Tier 4 Final Generator product line. It is the engineered to the utmost quality standards and manufactured in a strict quality control environment and will assure you a long, satisfactory service. To have the best performance from your Power Tech Generator, please fully read and understand this manual. This manual is written to better provide "YOU" with the information you need to operate and maintenance your generator. This manual was up to date at time of printing/downloading, there may be changes not reflected in your manual. If there is any questions please contact Power Technology's customer service dept.

TO OUR CUSTOMERS

Thank you for your purchase of a Power Technology Generator. In the event you experience a problem with your generator please contact the sales dealer, one of our authorized service centers or Power Technology's Customer Service Department directly at 1-800-760-0027 from 8:00 a.m. to 5:00 p.m. EST. Please have the generator model and serial numbers available when you call. This will help expedite service and parts to you. Parts may be obtained directly through Power Technology and shipped the same day if ordered by 3:00 p.m. EST.

Parts may be ordered any time at
WWW.POWERTECHPARTS.COM

To find a list of our dealers, scan
the QR code below





Generating Power to the World

Limited Warranty on Power Tech Generators

Power Technology Southeast, Inc. warrants to you, the original purchaser, that each product of our manufacture is free from defects in materials, and workmanship. That each generator will deliver its rated output as indicated on The Power Technology Nameplate, if properly installed, serviced, and operated under normal conditions in accordance with Power Technology's instructions.

THE WARRANTY COVERAGE TERMS:

2 years from date of purchase, or 3000 hours whichever comes first, or 36 months from the date of manufacture. Parts, and labor, including diagnostic labor, removal, and reinstallation are covered for the first 12 months from date in service or 1000 hours whichever comes first. Parts and labor are covered only on the following generator and engine parts for 2 years or 3000 hours whichever comes first. Generator Parts: Main Rotor and Main Stator. Engine Parts: Cylinder Block, cylinder head, crankshaft, camshaft, cylinder head gears, connecting rods, flywheel and flywheel housing, intake and exhaust manifold (only if flexible connection is used).

- 3) Stand-by Units are covered for a period of 1 year from date of installation, or 1000 hours, or 24 months from the date of manufacture whichever comes first.
- 4) Replacement Parts are warranted: 30 days. (Excluding the following: voltage regulators, fuses, controllers, capacitors, brushes, and switches)

WHAT POWER TECHNOLOGY WILL DO:

Power Tech will at our option, repair or replace any part covered by this warranty which becomes defective, malfunctions or otherwise fails to conform to this warranty under normal use and service during the term of this warranty.

WHAT YOU MUST DO TO OBTAIN WARRANTY SERVICE:

In order to obtain warranty repairs you must deliver the product, together with proof of purchase to an authorized Power Tech service facility. In the case of repairs pertaining to the engine only, you must use an authorized dealer or distributor of that make of engine, to be covered under their warranty. Engines used in the manufacture of Power Tech products are warranted solely by the engine manufacturer.

PRIOR APPROVAL IS REQUIRED FOR ANY WARRANTY SERVICE

Failure to obtain authorization prior to the repair being performed will result in the claim being denied.

All claims must be submitted within 30 days of the repair. Along with the following: a copy of the original repair order, Power Tech authorization number, Power Tech serial number, and operation hours shown on the genset mounted hour meter.

THIS WARRANTY DOES NOT COVER THE FOLLOWING:

A. Normal wear items, including but not limited to: turbo-chargers, fuel injector (s), starter, alternator, and electronic components, as well as normal engine and/or generator wear. **A1.** Travel time and fuel charges to and from the repair facility or travel time and fuel charges for mobile service. (Except stationary units with a maximum of 2-hours travel time.) **B.** Defects, malfunctions or failure resulting from accidents, abuse, misuse, improper servicing, improper installation, improper storage, and lack of performance of required maintenance service. **C.** Products which have been subjected to alteration, modification, neglect or unauthorized repairs. **D.** Troubleshooting, routine service, tune-ups, replacement of filters, belts, coolant, lubricants, hoses, clamps, exhaust system components, fuel system components, gaskets and/or seals. **E.** Electrical items damaged by welding or jump-starting. **F.** Damage caused by water ingestion or electrolysis. **G.** Damage caused by ingestion of substances other than clean filtered air, fuel, or intake water. **H.** Damage caused by faulty repairs performed by a repair facility not authorized in writing by Power Tech. **I.** Damage caused by operation with improper fuel or at speeds, loads, conditions, modifications, or installation contrary to published specifications or recommendations. **J.** Original installation charges and startup costs. **K.** Removal and re-installation charges of more than 1-hour labor for outside units, 2-hours for compartment mounted units, and 3-hours for below deck marine units. Customer is responsible for additional labor/charges due to difficult access, removal or installation. **L.** Starting batteries and labor or charges related to battery service. **M.** Loss of revenue or the rental of equipment due to down time. **N.** Generator repairs made within the warranty period other than by an authorized Power Tech service dealer without prior written approval from Power Tech warranty department. **O.** Damage caused by negligent maintenance such as but not limited to: Failure to provide the specified type and quantity of lubricating oil, cooling air flow, and proper coolant mixture and level. Failure to provide adequate air intake/or maintenance of the air intake system. Failure to provide scheduled maintenance as prescribed in supplied manuals. **P.** Engine fluids such as fuel, oil or coolant/antifreeze. **Q.** Shop supplies such as adhesives, cleaning agents, rags, paint, or other miscellaneous supplies. **R.** Use of other than factory supplied or approved repair parts or procedures. Replacement of a failed Power Tech component with a non-Power Tech component voids the Power Tech warranty on that component and any and all failures related to that component. **S.** Fuel injection pumps repaired by anyone other than the factory authorized dealer or distributor of that engine. **T.** Expenses incurred investigating performance complaints unless defective Power Tech materials or workmanship are discovered. **U.** Generator sets used in rental applications. **V.** Cleaning, service, or repair of generator sets that have not been kept free of dirt, debris, or other items that prevent the unit from being able to operate properly. **W.** Any generator set not application approved. **X.** Loss of excitation due to prolonged storage. **Y.** Any damage attributed to low battery monitoring or automatic generator starting systems. **Z.** Optional accessories are warranted solely by the manufacturer of that item including but not limited to the following item: Block heaters, oil pan heaters, electric cooling fans, air-bag isolators, compartment heaters, fuel tanks, trailers, battery chargers, battery monitors.

To obtain warranty service: For your nearest Power Tech authorized service center, on the World Wide Web at: http://www.powertech-gen.com/parts_service.php Call 1-352-365-2777 or write to Power Tech Warranty Department, P.O. Box 490133 Leesburg, FL 34749 USA.

Power Tech must be notified in writing within five (5) business days of any product failure. **General Conditions:**

This Warranty is the sole property of the original owner/user.

A transfer of ownership shall terminate this Warranty.



Generating Power to the World

This Warranty is only valid within the contiguous United States and Canada.

Warranty coverage is available outside the U.S. and Canada; please speak to a factory representative for those details.

This Warranty does not cover any products or parts not purchased from Power Technology.

Power Technology reserves the right to make design improvements and model changes without any obligation to change units or parts previously manufactured. Warranty registration card must be completed and mailed to Power Tech at the above address to validate the Warranty.

This is the only express warranty on Power Tech products

No person, agent, or dealer is authorized to give any Warranties on behalf of Power Technology Southeast, Inc., and not to assume for Power Technology Southeast, Inc. any other liability in connection with any of its products unless made in writing and signed by an officer of Power Technology Southeast, Inc.

LIMITATIONS ON OUR RESPONSIBILITY WITH RESPECT TO PRODUCTS PURCHASED AND USED FOR PERSONAL, FAMILY OR HOUSEHOLD USE:



Generating Power to the World

SAFE OPERATION

Observe Safety Instructions
 Wear Safety Clothing
 Check Before Operating the Engine
 Keep Area around the engine clean
 Safe Handling of Fuel and Lubricants
 Exhaust Gases and Fire Prevention
 Escaping Fluids
 Cautions against Burns and Battery Explosion
 Keep Hands and Body Away From Rotating Parts
 Anti-Freeze and Disposal of Fluids
 Conducting Safety Checks and Maintenance

CALIFORNIA

Proposition 65 Warning

Diesel Engine Exhaust and some of its constituents are known by the State of California to cause Cancer, Birth Defects and Other Reproductive harm.



These symbols, the industry's "Safety Alert Symbol", is used throughout this manual and on labels attached the machine itself. It warns of the potential for personal injury. It is essential that you carefully read the instructions and safety regulations before you attempt to assemble or use this unit.

WARNING: Indicates a potentially hazardous situation, which may possibly result in serious injury or possible death.

CAUTION: Indicates a potentially hazardous situation, which may possibly result in minor injury.

IMPORTANT: Indicates that equipment or property damage may result if instructions are not followed.

NOTE: Indicates helpful information.

Cautious operation is your best insurance against an accident. Read and understand this section carefully before operating the engine. All operators, no matter how knowledgeable they may be, should read this and other related manuals before operating the engine or any equipment attached to it. It is the owner's



Generating Power to the World

responsibility to instruct all operators in safe operation. Be sure to observe the following for safe operation.

OBSERVE SAFETY INSTRUCTIONS

- Read, understand and follow this “OPERATORS MANUAL” and “LABELS ON THE ENGINE” before starting and operating.
- Learn how to operate and work safely. Know your equipment and its limitations. Always keep the generator in good condition.
- Before allowing other people to use your engine, explain how to operate and have them read this manual before operation.
- DO NOT modify the engine. UNAUTHORIZED MODIFICATIONS to the engine may impair the function and/or safety and affect engine life.



WEAR SAFETY CLOTHING

- DO NOT wear loose, torn or bulky clothing around machinery. Entanglement in rotating parts, controls or projections may cause persona injury.
- Use additional safety items, e.g. hardhat, eye protection, gloves, etc., as appropriate or required.
- DO NOT operate machinery or equipment while under the influence of alcohol, medication, or other drugs, or while fatigued.
- DO NOT wear radio or music headphones while operating engine.



CHECK BEFORE OPERATING THE ENGINE

- If the engine is malfunctioning DO NOT operate until repairs are made.
- Be sure all guards and shields are in place before operating the engine. Replace any that are damaged or missing.
- Check to see that the area around the engine is clear of foreign objects before starting.
- Always keep the engine at least 3 feet (1 meter) away from buildings or other facilities.
- DO NOT allow children or livestock to approach the machine while in operation.
- DO NOT start the engine by shorting across starter terminals.





Generating Power to the World

KEEP AREA AROUND THE ENGINE CLEAN

- Be sure to stop the engine before cleaning.
- Keep the engine clean and free of accumulated dirt, grease and trash.
- DO NOT stop the engine without idling; Temperatures around the genset rises suddenly. Keep the genset idling for about 5 minutes before stopping?



SAFE HANDLING OF FUEL AND LUBRICANTS

- Always stop the engine before refueling or lubricating.
- DO NOT smoke or allow flames or sparks in your working area. Fuel is extremely flammable and explosive. Never store flammable liquids in the engine compartment.
- Refuel at a well-ventilated and open place. If fuel or lubricants spill, clean up immediately and properly dispose of.
- DO NOT mix gasoline or alcohol with diesel fuel. The mixture can cause a fire.

EXHAUST GASES AND FIRE PREVENTION

- Engine exhaust fumes can be very harmful if allowed to accumulate. Be sure to run the engine in a well-ventilated area where there are no people or livestock nearby.
- The exhaust gas from the muffler is very hot. To prevent a fire, do not expose dry grass, oil or any other combustible materials to exhaust gas. Keep the engine and mufflers clean all the time.
- To avoid a fire, be alert for leaks of flammables from hoses and lines. Be sure to check for leaks from hoses and pipes, such as fuel and hydraulic by following the maintenance check list.
- To avoid a fire, do not short across power cables and wires. Check to see that all power cables and wires are in good condition. Keep all power connections clean. Bare wire or frayed insulation can cause a dangerous electrical shock and personal injury.





Generating Power to the World

Escaping fluids

- Relieve all pressure in the air, oil and cooling systems before any lines, fittings or related items are removed or disconnected.
- Be alert for possible pressure release when disconnecting any device from a system that is pressurized. DO NOT check for pressure leaks with your hands. High-pressure oil or fuel can cause personal injury.
- Escaping hydraulic fluid under pressure has sufficient force to penetrate skin causing serious personal injury.
- Fluid escaping from pinholes may be invisible. Use a piece of cardboard or wood to search for suspected leaks: do not use hands and body. Use safety goggles or other eye protection when checking for leaks.
- If injured by escaping fluid, see a medical doctor immediately. This fluid can produce gangrene or severe allergic reaction.

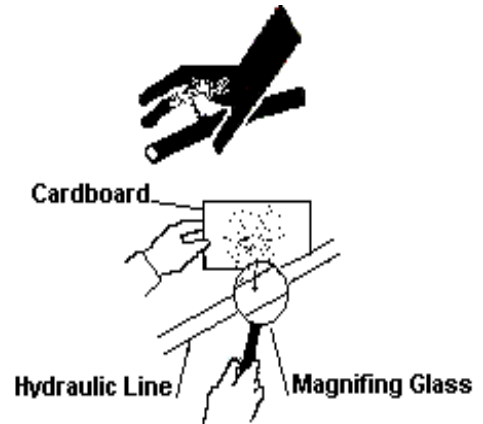

CAUTIONS AGAINST BURNS AND BATTERY EXPLOSION

- To avoid burns, be alert for hot components during operation and after the engine has been shut off. Such as the muffler, muffler cover, radiator, piping, engine body, coolants, engine oil, etc.
- DO NOT remove the radiator cap while the engine is running or immediately after stopping. Wait approximately ten minutes for the radiator to cool before removing the cap.
- Be sure the radiator drain valve / petcock and hose clamps are tightened. Check radiator pressure cap and oil fill cap before operating the engine.
- The battery presents an explosive hazard. When the battery is being activated, hydrogen and oxygen gases are extremely explosive.
- Keep sparks and open flames away from the battery, especially during charging. DO NOT strike a match near the battery.
- DO NOT check a batteries charge by placing a metal object across the terminals. Use a voltmeter or hydrometer.
- DO NOT charge a battery if frozen, it may possibly explode. Frozen batteries must be warm up to at least 61°F (16°C) before charging.



- **KEEP HANDS AND BODY AWAY FROM ROTATING PARTS**

- Keep your hands and body away from all rotating parts, such as cooling fan, v-belts, pulleys and flywheel. Contact with these rotating parts can cause serious personal injury.
- Be sure to stop the engine before adjusting belt tension or checking the cooling fan.
- DO NOT run the engine without safety guards installed. Be sure the safety guards are properly aligned and securely fastened before operating the engine.

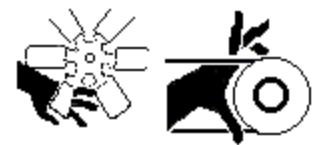



Generating Power to the World

ANTI-FREEZE AND DISPOSAL OF FLUIDS

- Anti-freeze contains toxic chemicals. Wear rubber gloves when handling anti-freeze. In case of contact with skin, wash immediately to avoid personal injury.
- DO NOT mix different types of Anti-freeze. The mixture can produce a chemical reaction resulting in the formation of harmful substances. Only use anti-freeze that is recommended and approved by Engine Manufacturer.
- Be mindful of the environment. Before draining any fluids, be prepared to dispose of them in a manner consistent with environmental protection regulations in your location.
- When draining fluids from the engine, use appropriate containers to hold the different fluids, do not mix fuel, oil or coolant together. Dispose of spent filter cartridges and batteries properly.
- DO NOT pollute the soil, or any water source. Never pour fluids down a drain.



Generating Power to the World

CONDUCTING SAFETY CHECKS AND MAINTENANCE

- When performing safety checks or engine service, be sure the engine is level and well supported. Use approved stands designed for this type of service.
- DO NOT service an engine that is only supported by a lift jack or hoist.
- Detach the battery from the engine before conducting service.
- To avoid sparks from an accidental short circuit always disconnect the 12V DC power at the battery.
- Be sure to stop the engine and remove the key when conducting daily and periodic maintenance, servicing and cleaning.
- Check or conduct maintenance after the engine, radiator, muffler, or muffler cover has cooled off completely.
- Always use the appropriate tools and jig-fixture when performing any service work. Be sure to understand and follow the instructions included with these tools.
- Use ONLY correct engine barring techniques for manually rotating the engine. DO NOT attempt to rotate the engine by pulling or prying on the cooling fan and V-belt. Serious personal injury or damage to the cooling fan may occur.
- Replace fuel hoses and hose clamps every 2 years or earlier whether they are damaged or not. They are made of rubber and are aged gradually.
- When service is performed with two or more people present, take care to perform all work safely. Be aware of their location especially when starting the engine.
- Keep a first aid kit and fire extinguisher handy at all times.

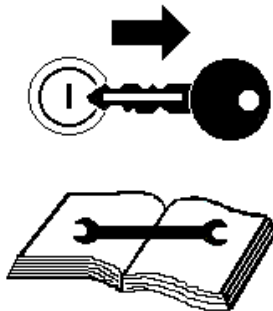



Generating Power to the World

Operating the Generator

Daily Pre Operational Checks

- Check the engine oil level to be appropriate level
- Check for tightness of battery cables/terminals.
- Check battery terminals for absence of corrosion
- Check coolant level for proper Fill (add if necessary)
- Check for absence of water in fuel (drain if necessary)
- Check for absence of DTC or failures
- Check for absence of excessive fan belt looseness

Using the PTG Series Controller

The LCD display is the primary source of information of the controller. The LCD allows you to view/change settings and monitor the status of sensors and other engine parameters.

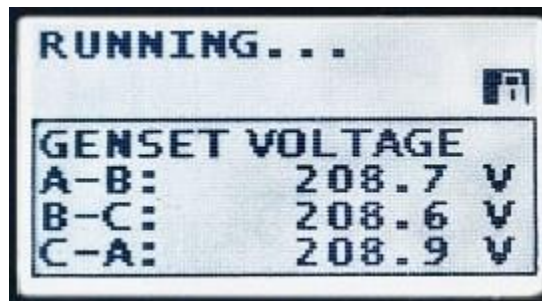







* **NOTE:** The genset mounted controller must be in "AUTO" mode in order to enable the remote panel functionality.



Generating Power to the World

Front Panel Items

Item	Name	Description
	Off Button	Used for turning off the engine or exiting out of Auto mode. This is not intended to function as an Emergency Stop as there are conditions in which it will not shutdown the engine.
	Auto Button	Used for placing the controller into Auto mode. Once in Auto the controller waits for a start command to be received.
	Run Button	Used to start the engine manually. Must use the Off button to shut down the engine if started from front panel.
	Up Button	Used for moving around in the menu, changing a settings value, or changing the currently displayed parameter page.
	Enter Button	Used for entering the menu system, accepting settings, or locking the LCD screen when viewing parameters.
	Down Button	Used for moving around in the menu, changing a settings value, or changing the currently displayed parameter page.
	Generator LED	Green = Engine running with no issues Amber = Engine running with warnings Red = Engine shutdown on failure

Using the Menu System

Task	Description
Entering Menu	When in the OFF mode, press the enter button to bring up the menu.
Navigating Menu	Once in the menu, use the up and down arrows to navigate. Pressing enter will move you into that menu.
Scroll Parameters	When in Auto or Running mode, pressing the up and down arrows will scroll through the parameters pages.
Lock Screen	When in Auto or Running mode, you can lock the screen onto a certain parameter page by pressing enter. You can unlock the screen by pressing enter again.
Events History	Once in the menu, select Events History to view the most recent controller event. Use the up and down arrows to navigate to other events. The controller can store up to 150 events. If more than 150 events occur, the oldest event is deleted to make room for the next event.



Generating Power to the World

Modes, Starting and Stopping Methods

The following table describes the different operating modes of the controller:

Mode / State	Description
OFF	When in the OFF mode, the engine cannot be remotely started.
Auto	When in the Auto mode, the engine waits to receive a start command.
Running	When engine is Running, the controller monitors engine parameters and waits to receive a stop command.
Failure	When a failure occurs, the controller shuts down the engine and displays reason for failure. The unit must be reset using the front panel OFF button with the exception of Modbus.
Menu	When in the menu you can change settings and view the events history.

**Generating Power to the World****Engine Specifications**

Engine Make:	Kubota
Engine Model:	WG1605
EPA Tier	Tier 2
Oil type	See page 9
Oil capacity	6.34 Qts (6L)
Air Filter P/N	04FA2E1
Inline Fuel Filter P/N	08FFG38
OIL Filter P/N	01FO1605



Generating Power to the World

Engine Maintenance Schedule

Maintenance Service Item	See notes	Daily	150 Hour Interval	500 Hour Interval	1000 Hour Interval	2000 Hour Interval	Remarks
Engine Oil Level deterioration & Leakage		x					
Engine Oil Change	x		x				Or Once a Year
Oil Filter Change			x				Or Once a Year
Coolant Level		x					
Coolant Leakage		x					
Coolant Change					x		Or Once a Year
Fuel Level		x					
Fuel Leakage		x					
Water in Fuel	x	x					
Primary Fuel filter Replacement	x			x			Or Once a Year
Air filter Replacement	x			x			Or Once a Year
Damaged, Worn or loose belts	x						Or Two Year Intervals
Replace Fuel Lines/Hoses					x		Or Two Year Intervals
Radiator Hoses and Clamps					x		Or Once a Year
Abnormal Engine Noise		x					
Exhausts Gas Condition		x					
Spark Plug Change						x	
Battery Check			x				
Battery Replace							

NOTE: Under normal operation, items such as belts, hoses and filters are not covered By Power Technology Southeast Limited Warranty.

*Engine Oil must be changed after the first 50 hours of service then in 150 hour intervals after the first 50 hours.

*Filter replacement intervals vary depending on quality of air, fuel, etc



Generating Power to the World

Engine Oil Maintenance

Checking the Engine Oil Level

- 1) Maintain Proper Oil Level Between “ADD”(Y) and “Full” (X) the oil level Gauge. DO NOT fill above “Full” mark as catastrophic engine damage will occur.



- 2) Remove the oil filler cap and add oil if necessary. Clean the oil filler cap with a clean rag or towel. Reinstall the oil filler cap by hand.

Lubricating Oil Specifications

Use only good quality Lubricating Oil, which meets the following Specifications.

API Class

CJ-4

Engine Oil

LUBRICATING OIL VISCOSITY

RECOMMENDATIONS

The minimum ambient temperature during cold engine start-up and the maximum ambient temperature during engine operation determine the proper SAE viscosity grade of oil.

Refer to the Engine Oil Viscosity Table below (Lowest Ambient Temperature) in order to determine the required oil viscosity for starting an engine in cold conditions.

Refer to the Engine Oil Viscosity Table below in order to select the oil viscosity for engine operation at the ambient temperature range that is anticipated.

Ambient Temperature Range

Above 25 C (77° F)	SAE 10W-30 or 15W-40
-10°C to 25°C (14° to 77° F)	SAE 10w-30 or 15W-40
Below -10° C (14°F)	SAE 10W-30



Generating Power to the World

COOLANT RECOMMENDATIONS

For optimum performance, Power Technology recommends a 1:1 mixture of water / glycol.

NOTE: Use a mixture that will provide protection against the lowest ambient temperature.

NOTE: 100 percent pure glycol will freeze at a temperature of -23°C (-9°F).

Most conventional heavy-duty coolant / antifreezes use Ethylene Glycol. Propylene Glycol may also be used in a 1:1 mixture with water. Ethylene and Propylene Glycol provide similar protection against freezing and boiling. See the tables below.

ETHYLENE GLYCOL			
	Freeze	Boil	
Concentration	Protection	Protection	
50 Percent	-36°C (-33°F)	106°C (223°F)	
60 Percent	-51°C (-60°F)	111°C (232°F)	

PROPYLENE GLYCOL			
	Freeze	Boil	
Concentration	Protection	Protection	
50 Percent	-29°C (-20°F)	106°C (223°F)	

NOTE: Do not use Propylene Glycol in concentrations that exceed 50 percent glycol because of Propylene Glycol's reduced heat transfer capability. Use Ethylene Glycol in conditions that require additional protection against boiling or freezing.

CHECKING RADIATOR COOLANT LEVEL

Remove the radiator cap after the engine has completely cooled and check to see that coolant reaches the supply port.

1. Fill to the bottom of the fill neck and check after every 25 hours of operation.



Generating Power to the World

GENERATOR ASSEMBLY INFORMATION

EXCITER TYPE GENERATOR

The exciter pole pieces contain residual magnetism, which sets up lines of force across the air gap to the exciter armature. When the exciter begins to rotate a voltage is induced and current flow is initiated in the exciter armature AC windings. This voltage is fed to the rotating rectifier assembly, rectified and fed to the alternator field, which sets up lines of force across the air gap to the alternator stator windings and to the output circuit. A static voltage regulator is connected to the generator output. The regulator will rectify part of the output voltage to provide a DC voltage to the exciter field coils. This will increase the density of the lines of force in the exciter, increasing the voltage induced into the exciter armature windings, and therefore, to the rotating rectifiers. The rotating rectifier output will be increased which increase the alternator field strength and generator output will build up its rated voltage. Adjustment of the generator output to the rated voltage level is accomplished by controlling the current fed to the exciter field coils. Regulation is automatic with the static type voltage regulator. An additional voltage adjustment range is provided if desired by turning the Voltage Adjust Rheostat.

ELECTRONIC VOLTAGE REGULATION

Electronic Voltage Regulator (EVR) also referred to, as an Automatic Voltage Regulator (AVR) is a very reliable device, which uses solid-state electronics to maintain voltage accuracy at $\pm 2\%$ of the regulated voltage. The Voltage Regulator is designed to automatically regulate and maintain the generated AC voltage throughout the load range that is from no load to full load.

VOLTAGE CONNECTION

The generator may be connected at the terminal board to deliver 120/240 volts to a 3 wire grounded neutral system.

If all equipment requires 120-volts then the 120-volt connection is preferred, even if two lines leave the same switch box. The two lines at the inputs to the switch box are both connected to the un-grounded 120-volt lines from the generator.

The 120-volt connection enables the Electronic Voltage Regulator (EVR) to hold the voltage very close to the 115 or 120 volts, as initially adjusted, regardless of the power distribution amount the different distribution lines. The 120-volt connection is recommended if the entire electrical load requires only 115 or 120 volts. Although the 120/240-volt connection may also be used when all loads requires only 110 volts, it should be pointed out that this connection, the 240-volts, is regulated and the lightly loaded phase, or line, will deliver a high line to neutral voltage and the heavily loaded phase will deliver a low line to neutral voltage. The heavily loaded line may have such a



Generating Power to the World

low voltage that air conditioning will have more difficulty in starting, and long starting lines may overload generator and trip circuit breakers.

For three phase connections, please contact Power Technology's Tech support Dept.

EXCITER FIELD COIL VOLTAGE SOURCE

Field coil DC voltage is obtained by rectifying the voltage from the phase to neutral line of the generator output, or either appropriate terminal to provide the needed voltage reference.

The rectifier bridge is an internal part of the static regulator. The static regulator senses a change in the generator output and automatically regulates current flow in the exciter field coil circuit to increase or decrease the exciter field strength. An adjustable rheostat sized to be compatible with the regulator is used to provide adjustment of the regulator sensing circuit.

ROTATING FIELD ASSEMBLY (ROTOR)

The rotating field assembly consists basically of four members: 1) the shaft assembly, 2) the core assembly, 3) the field coil damper windings, and 4) balance lugs to provide a high degree of static and dynamic balance.

CORE ASSEMBLY

The core assembly consists of a quantity of thin steel plates compressed and fastened together to form a single laminated assembly. The field windings are wound around this assembly.

FIELD COIL

Field coils of heavily insulated wire are "wet" wound directly onto the poles. Field coil leads are brought out to the rectifier assembly for connection to the source of DC excitation voltage.

BALANCE

The rotor assembly is precision balanced to a high degree of static and dynamic balance. Although the balance will remain dynamically stable at speeds in excess of the design frequencies, the prime mover should be adequately governed to prevent excessive over speed. High centrifugal forces created by excessive over speed may damage the rotor windings and field coils.



Generating Power to the World

BEARING

The generator rotor assembly is suspended on a shielded factory lubricated ball bearing. A visual inspection of the bearing is recommended at typical service intervals. If signs of abnormal wear or leakage are observed, the bearing should be replaced. Never use liquids of any kind to clean the generator end and bearing.

STATOR ASSEMBLY

The stator assembly consists of laminations of steel mounted in a rolled steel frame. Random wound stator coils are fitted into the insulated slots.



Generating Power to the World

TROUBLESHOOTING

TROUBLE	POSSIBLE CAUSE	SUGGESTED ACTION
Generator will not start via remote panel or other source	Generator is not in "auto" mode	Put Generator in Auto mode via controller
	Remote connection plug is not connected	Reconnect Remote control Plug
Engine does not crank from local controller	Battery is low or terminals are dirty.	Clean terminals and re-charge battery. Replace battery if necessary.
	Crank circuitry wiring improperly connected.	Refer to engine control wiring and check crank connections.
Engine cranks but doesn't start	Out of fuel.	Check fuel level, add fuel if necessary.
	Fuel relay damaged	Check fuel relay and replace if damaged.
	Fuel System lost prime	Use Primer on top of fuel filter
Engine Starts but shuts down after a few seconds	See failure on controller LCD Display	
Engine Starts but genset not producing Voltage	Main breaker is in the "off" position	Turn Main Breaker to the "on" position
	Visually inspect all Generator Output leads for connectivity	.

For all other trouble shooting issues please contact one of our dealers on our website. www.powertechgenerators.com or scan the QR code below.

