

Panasonic®

Operating Manual

Pure IP-PBX

Model No. **KX-TDE100**
KX-TDE200/KX-TDE600



Thank you for purchasing a Panasonic Pure IP-PBX.
Please read this manual carefully before using this product and save this manual for future use.

KX-TDE100/KX-TDE200: PMMPR Software File Version 2.0000 or later
KX-TDE600: PGMPR Software File Version 2.0000 or later

Document Version: 2008-10

Feature Highlights

IP Communication

This PBX supports IP communication using a variety of IP telephones, such as the KX-NT300 series with Self Labeling and/or Bluetooth® wireless headsets, and SIP Extensions (SIP Hardphone/SIP Softphone).

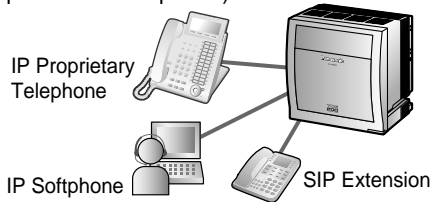

Consult your dealer

IP Softphone

You can install a software-based telephone (Panasonic IP Softphone) on your PC to make and receive calls using Internet Protocol (IP) and access PBX features without a wired IP Proprietary Telephone.

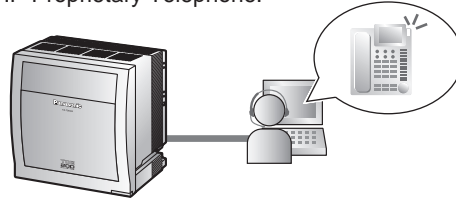

Consult your dealer

Cellular Phone Features

This PBX supports the use of cellular phones with the PBX. Cellular phones can make and receive calls as if they were registered extensions.

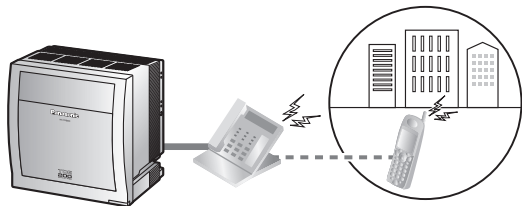

Consult your dealer

Wireless System

This PBX optionally supports a Portable Station (PS) system. PSs can be used in the PBX with other wired telephones.

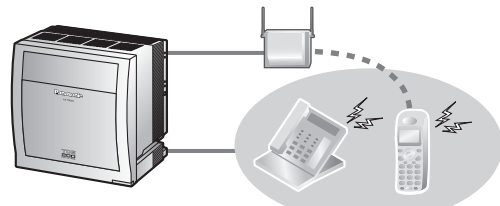

1.3.78 Wireless XDP Parallel Mode (Page 145)

Easy Operation

A Panasonic telephone that is equipped with a Navigator Key/Jog Dial and a display helps you to access desired features easily. Also, you will be informed of the arrival of an incoming call or a message waiting by the lamp if it is equipped.

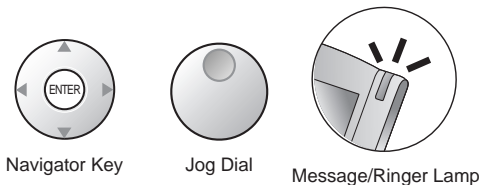

1.1 Before Operating the Telephones (Page 20)

Simplified Voice Message

You can set incoming calls to be redirected to your message box to let callers leave voice messages when you are unable to answer the phone.

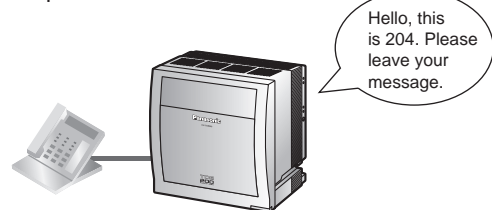

1.3.64 SVM (Simplified Voice Message) (Page 120)

**ACD Report Server
(KX-NCV200)**

This PBX supports Voice Processing Systems (VPS) with an ACD Report Server. In addition to VPS features, the ACD Report Server provides you with a variety of features, such as monitoring, reporting, and creating performance graphs, to manage call information efficiently.

<Report Sample: Incoming Calls>

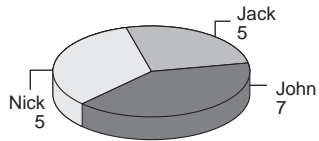

Consult your dealer

Phone Assistant (PA)

This application allows you to use your PC to access PBX features, providing advanced call handling capabilities to ensure that each call is handled efficiently.

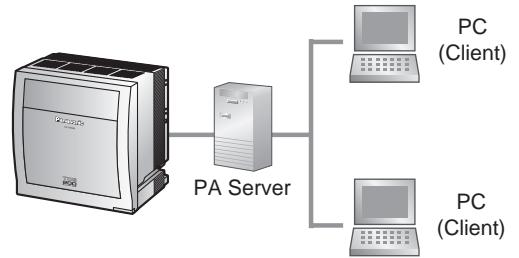

Consult your dealer

Call Center

This PBX offers a built-in Call Center feature called Incoming Call Distribution (ICD) Group. Incoming calls to an ICD Group can be queued or redirected to a preprogrammed destination, answered in order of priority and monitored by a supervisor extension.

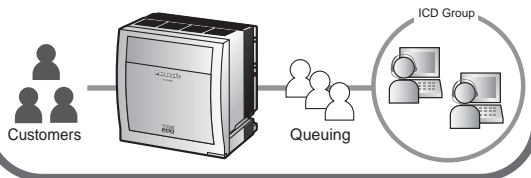

1.3.35 ICD GROUP FEATURES (Page 90)

In This Manual,

- The following abbreviations are used:
 - APT → Analog Proprietary Telephone
 - Display PT → Proprietary Telephone with a Display
 - DPT → Digital Proprietary Telephone
 - IP-PT → IP Proprietary Telephone
 - PS → Portable Station
 - PT → Proprietary Telephone
 - SIP Extension → Session Initiation Protocol Extension
 - SLT → Single Line Telephone
- The illustrations of the PBX are based on the KX-TDE200.
- The following icons are used frequently.



Hints



Conditions

Notice

- This PBX supports SIP (Session Initiation Protocol) Extensions. However, some PBX features may not be available for SIP Extensions, depending on your telephone type.
- Under power failure conditions, the connected telephones may not operate. Please ensure that a separate telephone, not dependent on local power, is available for emergency use.
- Prior to connection of this product, please verify that the intended operating environment is supported. Satisfactory performance cannot be guaranteed for the following:
 - interoperability and compatibility with all devices and systems connected to this product
 - proper operation and compatibility with services provided by telecommunications companies over connected networks

NOTES

- This manual provides basic information on how you can access commonly used PBX functions with proprietary telephones (PTs), single line telephones (SLTs), portable stations (PSs), and DSS Consoles. For detailed information about each feature or setting, refer to the Feature Manual or PC Programming Manual.
- In this manual, several kinds of PTs appear, as follows:
 - IP Proprietary Telephone (IP-PT)
 - Digital Proprietary Telephone (DPT)
 - Analog Proprietary Telephone (APT)
 - Proprietary Telephone with a Display (Display PT)"PT" is used as a generic term to represent all of these PTs. If a PBX feature only supports specific PTs, such as IP-PTs, the available telephone types are clearly indicated.
- IP-PTs/SIP Extensions may become busy and you may not be able to make or receive calls, depending on the network status.
- The contents of this manual apply to PBXs with a certain software version, as indicated on the cover of this manual. To confirm the software version of your PBX, refer to the PC Programming Manual or PT Programming Manual.
- Product specifications are subject to change without notice.

Notes for SIP Extension Users

Before using a SIP Extension, please read the following notes.

- a. The following features are available for SIP Extension users:
 - Making calls
 - Answering calls
 - Holding calls
 - Transferring calls (You cannot go on-hook before the transferred party answers.)
- b. The available operations using feature numbers are limited. Refer to the telephone types displayed at the top left of each operation.
- c. The operations for Call Forwarding (FWD)/Do Not Disturb (DND)/Personal Speed Dialing using the feature number, are not available. However, it is possible to enable these features at SIP Extensions if set through system programming.
Also, a KX-HGT100 user can store and dial personal speed dialing numbers in his/her telephone through KX-HGT100 programming.
- d. The tones listed in "4.3.1 Tone" are not available for SIP Extension users. Tones or the tone types may vary depending on the type of telephone being used. For example, when you put a call on hold, a specific tone for the SIP Extension may be heard, or no tone may be heard.
- e. Any number pressed while hearing a Busy/DND/Reorder tone, such as the feature number to activate Automatic Callback Busy, will be ignored.
- f. The operations for SIP Extensions may differ from the steps in this manual, and may vary depending on the type of telephone being used.

Safety Notices

Please observe the safety notices in this manual in order to avoid danger to users or other people, and prevent damage to property.

The notices are classified as follows, according to the severity of injury or damage:

<u>WARNING</u>	This notice means that misuse could result in death or serious injury.
<u>CAUTION</u>	This notice means that misuse could result in injury or damage to property.

Trademarks

- The Bluetooth® word mark and logos are owned by the Bluetooth SIG, Inc. and any use of such marks by Panasonic Corporation is under license.
- All other trademarks identified herein are the property of their respective owners.

Important Safety Instructions

When using your telephone equipment, basic safety precautions should always be followed to reduce the risk of fire, electric shock and injury to persons, including the following:

- Do not use the product near water, for example, near a bathtub, wash bowl, kitchen sink, or laundry tub, in a wet basement, or near a swimming pool.
- Avoid using wired telephones during an electrical storm. There is a remote risk of electric shock from lightning.
- Do not use a telephone in the vicinity of a gas leak to report the leak.

SAVE THESE INSTRUCTIONS

Important Information

SAVE THESE INSTRUCTIONS

WARNING

SAFETY REQUIREMENTS

For All Telephone Equipment

- The product may only be installed and serviced by qualified service personnel.
- To prevent possible fire or electric shock, do not expose the product to rain or moisture.
- Follow all warnings and instructions marked on the product.
- Do not place the product on an unstable surface, as a fall may cause serious internal damage.
- The product should only be connected to the type of electrical power supply specified on the product label. If you are not sure of the type of power supply to your home, consult your dealer or local power company.
- For safety purposes some products are equipped with a grounded plug. If you do not have a grounded outlet, please have one installed. Do not bypass this safety feature by tampering with the plug.
- Do not allow anything to rest on the power cord. Do not locate the product where the power cord may be stepped on or tripped on.
- To reduce the risk of fire or electric shock, do not overload wall outlets and extension cords.
- To reduce the risk of electric shock, do not disassemble the product. Only qualified personnel should service the product. Opening or removing covers may expose you to dangerous voltages or other risks. Incorrect reassembly can cause electric shock.
- Unplug the product from the wall outlet and have it serviced by qualified service personnel in the following cases:
 - a. When the power supply cord or plug is damaged or frayed.
 - b. If liquid has been spilled into the product.
 - c. If the product has been exposed to rain or water.
 - d. If the product does not operate according to the operating instructions. Adjust only the controls that are explained in the operating instructions. Improper adjustment of other controls may result in damage and may require service by a qualified technician to restore the product to normal operation.
 - e. If the product has been dropped or the cabinet has been damaged.
 - f. If product performance deteriorates.

For the PBX

- If damage to the unit exposes any internal parts, disconnect the power supply cord immediately and return the unit to your dealer.
- Unplug this unit from the AC outlet if it emits smoke, an abnormal smell or makes unusual noise. These conditions can cause fire or electric shock. Confirm that smoke has stopped and contact an authorized Panasonic Factory Service Center.
- This unit is equipped with a grounded plug. For safety reasons this plug must only be connected to a grounded outlet that has been installed according to applicable regulations.
- Do not insert objects of any kind into this product through its slots and openings, as they may touch dangerous voltage points or short out parts that could result in a risk of fire or electric shock. Never spill liquid of any kind on or in the product.
- Use only the power cord and batteries indicated in this manual. Do not dispose of batteries in a fire, as they may explode. Dispose according to local regulations.

CAUTION

SAFETY REQUIREMENTS

For All Telephone Equipment

- Unplug the product from the wall outlet before cleaning. Wipe the product with a soft cloth. Do not clean with abrasive powders or with chemical agents such as benzene or thinner. Do not use liquid cleaners or aerosol cleaners.
- The product should be kept free of dust, moisture, high temperature (more than 40 °C [104 °F]), and vibration, and should not be exposed to direct sunlight.

For the PBX

- When relocating the equipment, first disconnect the telecom connection before disconnecting the power connection. When the unit is installed in the new location, reconnect the power first, and then reconnect the telecom connection.
- The power supply cord is used as the main disconnect device. Ensure that the AC outlet is located near the equipment and is easily accessible.
- Slots and openings in the front, back and bottom of the cabinet are provided for ventilation; to protect it from overheating, these openings must not be blocked or covered. The openings should never be blocked by placing the product on a bed, sofa, rug, or other similar surface while in use. The product should never be placed near or over a radiator or other heat source. This product should not be placed in a sealed environment unless proper ventilation is provided.
- To protect this unit from static electricity, do not touch any external connectors of the unit.

SECURITY REQUIREMENTS

In order to use the PBX safely and correctly the Security Requirements below must be observed. Failure to do so may result in:

- Loss, leakage, falsification or theft of user information.
- Illegal use of the PBX by a third party.
- Interference or suspension of service caused by a third party.

What is User Information?

User Information is defined as:

1. Information stored on the SD Memory Card:
Phonebook data, user IDs, system settings data, passwords (User/Administrator/Installer), Personal Identification Numbers (PINs), etc.
2. Information sent from the PBX to a PC or other external device:
Phone call data (including telephone numbers of outside parties), call charge data, etc.

Requirements

1. The SD Memory Card contains software for all the processes of the PBX and all customer data. It can be easily removed and taken away from the PBX by a third party. Therefore, do not allow unauthorized access to prevent data leakage.
2. Always make backups of data stored on the SD Memory Card. For details, consult your dealer.
3. To prevent illegal access from the Internet, activate a Firewall.
4. To avoid unauthorized access and possible abuse of the PBX, we strongly recommend:
 - a. Keeping the password secret.
 - b. Selecting a complex, random password that cannot be easily guessed.
 - c. Changing your password regularly.
5. Perform the following when sending the PBX for repair or handing it over to a third party.
 - a. Make a backup of data stored on the SD Memory Card.
 - b. Using an SD formatter, format the SD Memory Card so that information cannot be retrieved from it.
6. To prevent data leakage, render the SD Memory Card physically unusable before disposal.

7. When user information is sent from the PBX to a PC or other external device, the confidentiality of that information becomes the responsibility of the customer. Before disposing of the PC or other external device, ensure that data cannot be retrieved from it by formatting the hard disk and/or rendering it physically unusable.

Notice

SAFETY REQUIREMENTS

For All Telephone Equipment

- Read and understand all instructions.

For the PBX

- Keep the unit away from heating appliances and devices that generate electrical noise such as fluorescent lamps, motors, and televisions. These noise sources can interfere with the performance of the PBX.
- If you are having problems making calls to outside destinations, follow this procedure to test the CO lines:
 1. Disconnect the PBX from all CO lines.
 2. Connect known working single line telephones (SLTs) to those CO lines.
 3. Make a call to an external destination using those SLTs.

If a call cannot be carried out correctly, there may be a problem with the CO line that the SLT is connected to. Contact your telephone company.

If all SLTs operate properly, there may be a problem with your PBX. Do not reconnect the PBX to the CO lines until it has been serviced by an authorized Panasonic Factory Service Center.

Notes

SAFETY REQUIREMENTS

For All Telephone Equipment

- Never attempt to insert wires, pins, etc. into the vents or holes of the product.

Attention

- When using a Panasonic proprietary telephone (PT), use only the correct Panasonic handset.
- For users of PC Phone (Free License Version) shipped with KX-DT301/KX-T7601 USB Module:
All features of the PC Phone software are available for 90 days from the date of installation.
After this period expires, the following buttons on the Operation Screen will become unavailable:
 - Recording
 - TAM
 - Voice Memo
 - Text Memo
 - SpeedTo continue using any of the corresponding features after the trial period, please purchase KX-TDA0350 (PC Phone, 5 licenses).

Notice for users in California

This product contains a CR coin cell lithium battery that contains perchlorate material—special handling may apply. See www.dtsc.ca.gov/hazardouswaste/perchlorate

F.C.C. REQUIREMENTS AND RELEVANT INFORMATION

1. Notification to the Telephone Company

This equipment complies with Part 68 of the FCC rules and the requirements adopted by the ACTA. On the side of this equipment is a label that contains, among other information, a product identifier in the following format:

- US:AAAEQ##TXXXX

If requested, this number must be provided to the telephone company.

Installation must be performed by a qualified professional installer. If required, provide the telephone company with the following technical information:

- Telephone numbers to which the system will be connected
- Make: Panasonic
- Model: KX-TDE100, KX-TDE200, and KX-TDE600
- Certification No.: found on the side of the unit
- Ringer Equivalence No.
KX-TDE100/KX-TDE200: 0.3A
KX-TDE600: 0.4B
- Facility Interface Code
KX-TDE100/KX-TDE200: 02LS2, 04DU9.BN/DN/1KN/1SN
KX-TDE600: 02LS2, 04DU9.BN/DN/1KN/1SN
- Service Order Code
KX-TDE100/KX-TDE200: 9.0F, 6.0P
KX-TDE600: 9.0F, 6.0P
- Required Network Interface Jack
KX-TDE100/KX-TDE200: RJ21X, RJ48C, RJ2HX
KX-TDE600: RJ21X, RJ48C

2. Ringer Equivalence Number (REN)

The REN is used to determine the number of devices that may be connected to a telephone line. Excessive RENs on a telephone line may result in the devices not ringing in response to an incoming call. In most but not all areas, the sum of RENs should not exceed five (5.0). To be certain of the number of devices that may be connected to a line, as determined by the total RENs, contact the local telephone company. For products approved after July 23, 2001, the REN for this product is part of the product identifier that has the following format:

- US:AAAEQ##TXXXX

The digits represented by 03 are the REN without a decimal point (e.g., 03 is a REN of 0.3). For earlier products, the REN is separately shown on the label.

3. Incidence of Harm to the Telephone Lines

If this equipment causes harm to the telephone network, the telephone company will notify you in advance that temporary discontinuance of service may be required. But if advance notice isn't practical, the telephone company will notify the customer as soon as possible. Also, you will be advised of your right to file a complaint with the FCC if you believe it is necessary.

4. Changes in Telephone Company Communications Facilities, Equipment, Operations and Procedures

The telephone company may make changes in its facilities, equipment, operations or procedures that could affect the operation of the equipment. If this happens the telephone company will provide advance notice in order for you to make necessary modifications to maintain uninterrupted service.

5. Trouble with this equipment

If trouble is experienced with this equipment, for repair or warranty information, please see the attached warranty, which includes the Service Center Directory. If the equipment is causing harm to the telephone

network, the telephone company may request that you disconnect the equipment until the problem is resolved.

6. Connection to Party Line

Connection to party line service is subject to state tariffs. Contact the state public utility commission, public service commission or corporation commission for information.

7. Combined Use with Alarm Equipment

If your home has specially wired alarm equipment connected to the telephone line, ensure the installation of this equipment does not disable your alarm equipment. If you have questions about what will disable alarm equipment, consult your telephone company or a qualified installer.

Note

This equipment has been tested and found to comply with the limits for a Class B digital device, pursuant to Part 15 of the FCC Rules. These limits are designed to provide reasonable protection against harmful interference in a residential installation. This equipment generates, uses, and can radiate radio frequency energy and, if not installed and used in accordance with the instructions, may cause harmful interference to radio communications. However, there is no guarantee that interference will not occur in a particular installation. If this equipment does cause harmful interference to radio or television reception, which can be determined by turning the equipment off and on, the user is encouraged to try to correct the interference by one or more of the following measures:

- Reorient or relocate the receiving antenna.
- Increase the separation between the equipment and receiver.
- Connect the equipment into an outlet on a circuit different from that to which the receiver is connected.
- Consult the dealer or an experienced radio/TV technician for help.

CAUTION

- Any changes or modifications not expressly approved by the party responsible for compliance could void the user's authority to operate this device.
When programming emergency numbers and/or making test calls to emergency numbers:
 - 1.** Remain on the line and briefly explain to the dispatcher the reason for the call before hanging up.
 - 2.** Perform such activities in the off-peak hours, such as early morning hours or late evenings.
- The software contained in the ARS and TRS features to allow user access to the network must be upgraded to recognize newly established network area codes and exchange codes as they are placed into service.

Failure to upgrade the on-premise PBXs or peripheral equipment to recognize the new codes as they are established will restrict the customer and users of the PBX from gaining access to the network and to these codes.

KEEP THE SOFTWARE UP TO DATE WITH THE LATEST DATA.

For 2.4 GHz Cell Station

Privacy of communications may not be ensured when using the wireless systems.

CAUTION

Any changes or modifications not expressly approved by the party responsible for compliance could void the user's authority to operate this device.

Note

This equipment has been tested and found to comply with the limits for a Class B digital device, pursuant to Part 15 of the FCC Rules. These limits are designed to provide reasonable protection against harmful interference in a residential installation. This equipment generates, uses, and can radiate radio frequency energy and, if not installed and used in accordance with the instructions, may cause harmful interference to radio communications. However, there is no guarantee that interference will not occur in a particular installation. If this equipment does cause harmful interference to radio or television reception, which can be determined by turning the equipment off and on, the user is encouraged to try to correct the interference by one or more of the following measures:

- Reorient or relocate the receiving antenna.
- Increase the distance between the equipment and receiver.
- Connect the equipment to an outlet on a circuit different from that to which the receiver is connected.
- Consult the dealer or an experienced radio/TV technician for help.

Some wireless telephones operate at frequencies that may cause interference to nearby TVs and VCRs. To minimize or prevent such interference, the base of the wireless telephone should not be placed near or on top of a TV or VCR. If interference is experienced, move the wireless telephone further away from the TV or VCR. This will often reduce, or eliminate, interference.

Operating near 2.4 GHz electrical appliances may cause interference. Move away from the electrical appliances.

CAUTION

To comply with FCC RF exposure requirements in uncontrolled environment:

- This equipment must be installed and operated in accordance with provided instructions and a minimum 20 cm (8 in) spacing must be provided between antenna and all person's body (excluding extremities of hands, wrist and feet) during wireless modes of operation.
- This transmitter must not be co-located or operated in conjunction with any other antenna or transmitter.

Medical—consult the manufacturer of any personal medical devices, such as pacemakers, to determine if they are adequately shielded from external RF (radio frequency) energy. (The unit operates in the frequency range of 2401 MHz to 2480 MHz, and the power output level can range from 0.004 W to 0.4 W.) Do not use the unit in health care facilities if any regulations posted in the area instruct you not to do so. Hospitals or health care facilities may be using equipment that could be sensitive to external RF (radio frequency) energy.

For DECT 6.0 Cell Station

Privacy of communications may not be ensured when using the wireless systems.

CAUTION

Any changes or modifications not expressly approved by the party responsible for compliance could void the user's authority to operate this device.

Note

This equipment has been tested and found to comply with the limits for a Class B digital device, pursuant to Part 15 of the FCC Rules. These limits are designed to provide reasonable protection against harmful interference in a residential installation. This equipment generates, uses, and can radiate radio frequency energy and, if not installed and used in accordance with the instructions, may cause harmful interference to radio communications. However, there is no guarantee that interference will not occur in a particular installation. If this equipment does cause harmful interference to radio or television reception, which can be determined by turning the equipment off and on, the user is encouraged to try to correct the interference by one or more of the following measures:

- Reorient or relocate the receiving antenna.
- Increase the distance between the equipment and receiver.
- Connect the equipment to an outlet on a circuit different from that to which the receiver is connected.
- Consult the dealer or an experienced radio/TV technician for help.

Some wireless telephones operate at frequencies that may cause interference to nearby TVs and VCRs. To minimize or prevent such interference, the base of the wireless telephone should not be placed near or on top of a TV or VCR. If interference is experienced, move the wireless telephone further away from the TV or VCR. This will often reduce, or eliminate, interference.

CAUTION

To comply with FCC RF exposure requirements in uncontrolled environment:

- This equipment must be installed and operated in accordance with provided instructions and a minimum 20 cm (8 in) spacing must be provided between antenna and all person's body (excluding extremities of hands, wrist and feet) during wireless modes of operation.
- This transmitter must not be co-located or operated in conjunction with any other antenna or transmitter.

Medical—consult the manufacturer of any personal medical devices, such as pacemakers, to determine if they are adequately shielded from external RF (radio frequency) energy. (The unit operates in the frequency range of 1920 MHz to 1930 MHz, and the output peak power level is less than 0.12 W.) Do not use the unit in health care facilities if any regulations posted in the area instruct you not to do so. Hospitals or health care facilities may be using equipment that could be sensitive to external RF (radio frequency) energy.

Table of Contents

1	Operation	19
1.1	Before Operating the Telephones	20
1.1.1	Before Operating the Telephones	20
1.2	Basic Operations	30
1.2.1	Making Calls	30
1.2.2	Answering Calls	32
1.3	Telephone Features and Operation	34
1.3.1	Absent Message	34
1.3.2	Account Code Entry	35
1.3.3	Alternate Calling—Ring/Voice	36
1.3.4	Automatic Callback Busy (Camp-on)	36
1.3.5	BGM (Background Music)	38
1.3.6	Call Hold	38
1.3.7	Call Monitor	41
1.3.8	Call Park	41
1.3.9	Call Pickup	43
1.3.10	Call Splitting	44
1.3.11	Call Transfer	45
1.3.12	CALL WAITING FEATURES	48
1.3.13	Call Waiting Tone	53
1.3.14	Character Entry	54
1.3.15	Conference	57
1.3.16	Conference, Unattended	61
1.3.17	Data Line Security	62
1.3.18	DISA (Direct Inward System Access)	63
1.3.19	DND (Do Not Disturb)	66
1.3.20	Door Open	69
1.3.21	Doorphone Call	70
1.3.22	EFA (External Feature Access)	71
1.3.23	Executive Busy Override	71
1.3.24	Extension Dial Lock	73
1.3.25	Extension Feature Clear	74
1.3.26	Extension PIN (Personal Identification Number)	75
1.3.27	External Relay	76
1.3.28	External Sensor	77
1.3.29	FWD (Call Forwarding)	77
1.3.30	Hands-free Answerback	84
1.3.31	Hands-free Operation	85
1.3.32	Headset Operation	85
1.3.33	HOSPITALITY FEATURES	89
1.3.34	Hot Line	89
1.3.35	ICD GROUP FEATURES	90
1.3.36	ICD Group Features—Call Log History for ICD Group	91
1.3.37	ICD Group Features—Incoming Call Queue Monitor	92
1.3.38	ICD Group Features—Log-in/Log-out	93
1.3.39	ICD Group Features—Log-in/Log-out Monitor and Remote Control	95
1.3.40	ICD Group Features—Manual Queue Redirection	97
1.3.41	ICD Group Features—Supervisory	97
1.3.42	Message Waiting	99
1.3.43	Mute	101
1.3.44	Off-hook Monitor	101
1.3.45	OHCA (Off-hook Call Announcement)	102

1.3.46	One-touch Dialing	102
1.3.47	Paging	103
1.3.48	Paralleled Telephone	104
1.3.49	PDN (Primary Directory Number)/SDN (Secondary Directory Number) Extension	105
1.3.50	Printing Message	108
1.3.51	Privacy Release	109
1.3.52	Private Network Features—CLIP (Calling Line Identification Presentation)	110
1.3.53	Private Network Features—CLIR (Calling Line Identification Restriction)	111
1.3.54	Private Network Features—COLP (Connected Line Identification Presentation)	111
1.3.55	Private Network Features—COLR (Connected Line Identification Restriction)	112
1.3.56	Private Network Features—Displaying Your Telephone Number on the Called Party's Telephone	112
1.3.57	Private Network Features—TIE Line Access	113
1.3.58	Quick Dialing	114
1.3.59	Redial, Last Number	114
1.3.60	Room Status Control	115
1.3.61	Self Labeling (KX-NT366 only)	118
1.3.62	Speed Dialing, Personal	119
1.3.63	Speed Dialing, System	120
1.3.64	SVM (Simplified Voice Message)	120
1.3.65	TAFAS (Trunk Answer From Any Station)	130
1.3.66	Timed Reminder	130
1.3.67	Time Service	132
1.3.68	Verification Code Entry	133
1.3.69	VOICE MAIL FEATURES	133
1.3.70	Voice Mail Features—LCS (Live Call Screening)	134
1.3.71	Voice Mail Features—Two-way Record	136
1.3.72	Voice Mail Features—Voice Mail Integration	137
1.3.73	Wake-up Call	138
1.3.74	Walking COS	140
1.3.75	Walking Extension	141
1.3.76	Walking Extension, Enhanced	142
1.3.77	Whisper OHCA	144
1.3.78	Wireless XDP Parallel Mode	145
1.4	Display Features	146
1.4.1	Call Log, Incoming	146
1.4.2	Call Log, Outgoing	148
1.4.3	Directories	151
1.4.4	System Feature Access	152
2	Manager Operation	157
2.1	Manager Service Features	158
2.1.1	Dial Tone Transfer	158
2.1.2	External BGM (Background Music)	158
2.1.3	OGM (Outgoing Messages)	158
2.1.4	Private Network Features—NDSS (Network Direct Station Selection) Monitor Release	160
2.1.5	Remote Extension Dial Lock	161
2.1.6	Time Service Mode Control	161
3	Customizing Your Phone & System	163
3.1	Personal Programming	164
3.1.1	Programming Information	164
3.1.2	Personal Programming	164

3.1.3	Programming Feature Clear	172
3.1.4	Customizing the Buttons	174
3.2	Manager Programming	179
3.2.1	Programming Information	179
3.2.2	Manager Programming	179
3.3	System Programming	182
3.3.1	Programming Information	182
3.3.2	System Programming	185
4	Appendix	189
4.1	Troubleshooting	190
4.1.1	Troubleshooting	190
4.2	Feature Number Table	193
4.2.1	Feature Number Table	193
4.3	Tone	201
4.3.1	Tone	201
	Index.....	205

Section 1

Operation

This chapter shows you step by step how to use each feature. Read this chapter to become familiar with the many useful features of this PBX.

1.1 Before Operating the Telephones

1.1.1 Before Operating the Telephones

◆◆ What Kind of Telephone Can Be Used?

You can use the following types of telephone with this PBX:

- Panasonic IP Proprietary Telephone (IP-PT)
(e.g., KX-NT346 or KX-NT366)
- SIP Extension
(e.g., KX-HGT100)
- Panasonic Proprietary Telephone (PT)
(e.g., KX-T7636 or KX-DT346)
- Panasonic Portable Station (PS)
(e.g., KX-TD7690)
- Single Line Telephone (SLT)
(e.g., rotary pulse telephone)

Which features are available depend on the type of telephone being used. If you are using a Panasonic proprietary telephone with a special feature button such as  or a display (Display PT) or both, you can follow the operation with the button or display messages for easy programming.

If you use a large display telephone (e.g., KX-NT346 or KX-T7636), you can follow the displayed messages to use the features. If your telephone does not have feature buttons and/or a display, you may operate the PBX by entering a feature number instead. Follow the operation for your type of telephone.

If you use a Console, you can use the buttons on the Console as the buttons on the connected proprietary telephone.

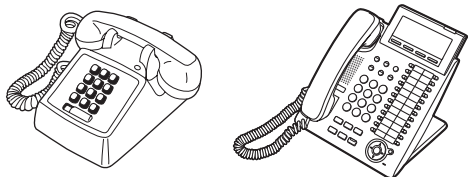

- If you use a Panasonic proprietary telephone which does not have feature buttons, you may change one of the unused flexible buttons to a feature button. Refer to "3.1.4 Customizing the Buttons".

Registration for your Portable Station (PS)/SIP Extension

Your PS/SIP Extension must be registered with the PBX and assigned an extension number before initial use, through system programming. To confirm the extension number of your PS, refer to "Your extension information" in "3.1.2 Personal Programming". For SIP Extension users, follow the instructions for your SIP Extension.

◆◆ Feature Numbers

To use certain features, you need to enter specified feature numbers (and an additional parameter, if required). There are two types of feature numbers as follows:

- Flexible feature number
- Fixed feature number

Fixed feature numbers cannot be changed. However, you can change the flexible numbers to other numbers for easier use. In this manual, the default numbers (factory installed) are used for operations.

A flexible number is shown as  (half-shaded key). Use the new programmed number if you have changed the feature number. Write the new number in the "Feature Number Table" (Appendix).



If you use a single line telephone which does not have the "*" or "#" keys; it is not possible to access features that have "*" or "#" in their feature numbers.

◆◆ Tone

You will hear various tones, during or after an operation, for confirmation. Refer to "4.3.1 Tone" (Appendix).

◆◆ Display

In this manual, you will see "the display ...". This refers to the display of a Panasonic proprietary telephone. If your telephone is not a Panasonic display proprietary telephone, the message will not be displayed.

If you use a Panasonic display proprietary telephone, the display helps you confirm the settings. Some proprietary telephones also give you easy access to features. A message is displayed depending on the feature. By pressing the corresponding button on the side or at the bottom of the display, or pressing the Navigator Key, you can access the desired feature.

Furthermore, depending on the display proprietary telephone, you can operate features or make calls using the display message. Refer to "1.4 Display Features".



Your Extension Number

If you use a Panasonic display proprietary telephone, you can check your own extension number on the display. Press the TRANSFER button or Soft (S1) button while on-hook.

◆◆ Using a Navigator Key/Jog Dial/Volume Key

The Navigator Key can be used for the display contrast and the volume control or you can search for desired items on the display. Press the Navigator Key/Volume Key or rotate the Jog Dial in the desired direction.

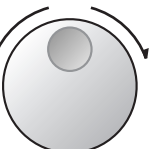
The contrast or the volume level and the items will change as follows:

Navigator Key	Jog Dial	Volume Key
<p>Up (Level increases)</p> <p>Left Right</p>  <p>Down (Level decreases)</p>	<p>Left (counter-clockwise)</p> <p>Right (clockwise)</p>  <p>Level decreases Level increases</p>	<p>Up (Level increases)</p>  <p>Down (Level decreases)</p>

◆◆ Examples

The displays and the illustrations shown as examples are from a telephone connected to the KX-TDE200.

◆◆ Restrictions

Some features may be restricted at your extension depending on system programming and the type of telephone being used.

◆◆ Icon Descriptions







The following icons show you the feature availability, notes and action to use the features.

	This feature cannot be used with a single line telephone.		Seize a CO line (One of the following). <ul style="list-style-type: none"> • Press the CO button. • Dial automatic line access number 9. • Dial CO line group access number and CO line group number.
	See "Programming" for Related Programming if necessary.		
	Off-hook (One of the following). <ul style="list-style-type: none"> • Lift the handset. • Press the SP-PHONE button. • Press the MONITOR button. (To start talking, lift the handset.) • Press TALK button. 		Press the Call button on the Doorphone.
	On-hook (One of the following). <ul style="list-style-type: none"> • Hang up. • Press the SP-PHONE button. • Press the MONITOR button. • Press CANCEL button. 		Press the hookswitch lightly.
	Press the corresponding feature button on the proprietary telephone.		Talk.
	Enter the required number. <Example> Enter the account code.		You will hear a busy, confirmation, dial, ring or ringback tone. B. Tone: Busy Tone C. Tone: Confirmation Tone D. Tone: Dial Tone R. Tone: Ring Tone R. B. Tone: Ringback Tone
	Dial an extension number.		Dial outside phone number.
	Dial the telephone number.		Press any dial key (0–9, *, #).
	Press the HOLD button on your SIP Extension.		



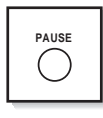
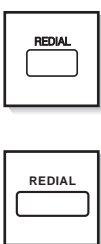

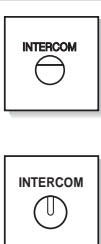

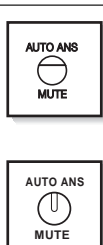





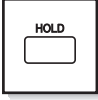



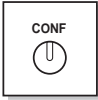

◆◆ When You Use a Panasonic Proprietary Telephone





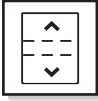

If you use a Panasonic proprietary telephone and the Console, they may have some of the useful feature buttons described below. For a PS user, refer to "Operating Instructions" for PS. These buttons make operations simple. The illustrations may differ from the buttons on your telephone.

Buttons on the PT

	<p>Flexible Buttons: Used to make or receive an outside call (CO button), or as a feature button. Button assignment is required. Refer to "Customized Buttons" for details.</p>		<p>SP-PHONE: Used for hands-free operation.</p>
	<p>AUTO DIAL/STORE: Used for System/Personal Speed Dialing or storing program changes.</p>		<p>PAUSE: Used to insert a pause when storing a telephone number. This button also functions as the PROGRAM button when there is no PROGRAM button on your telephone.</p>
	<p>REDIAL: Used to redial the last dialed number.</p>		<p>MESSAGE: Used to leave a message waiting indication or call back the party who left the message waiting indication.</p>
	<p>INTERCOM: Used to make or receive intercom calls.</p>		<p>Soft Buttons: Used to select the item displayed on the bottom of the display.</p>
	<p>MONITOR: Used for hands-free dialing. You can monitor the party's voice in hands-free mode.</p>		<p>AUTO ANS (Auto Answer)/MUTE: Used to receive an incoming call in hands-free mode or mute the microphone during a conversation.</p>

1.1.1 Before Operating the Telephones

 	<p>TRANSFER: Used to transfer a call to another party.</p>	 	<p>HOLD: Used to place a call on hold.</p>
 	<p>FLASH/RECALL: Used to disconnect the current call and make another call without hanging up. This button can also be used as a CANCEL button while on-hook.</p>	 	<p>CONF (Conference): Used to establish a multiple party conversation.</p>
	<p>VOICE CALL/MUTE: Used to monitor an intercom call automatically, but it cannot be used for hands-free conversations. It also mutes the handset microphone during a conversation.</p>	 	<p>Call Forwarding (FWD)/Do Not Disturb (DND): Used to perform Call Forwarding (FWD) or Do Not Disturb (DND).</p>
 	<p>PROGRAM: Used to enter and exit the Programming mode.</p>		<p>ANSWER: Used to answer an incoming call.</p>
	<p>RELEASE: Used to disconnect the line.</p>	   	<p>Navigator Key/Jog Dial/Volume Key: Used to adjust the volume and the display contrast or select desired items.</p>

	<p>Programmable Feature (PF): <i>Located on the upper part of the Flexible button array or on the DSS Console.</i> Assigns the desired button and used to access the stored feature. Mostly used as a One-touch Dialing button. (Only the "F and number" may be shown on some telephones.)</p>		<p>MODE: Used to shift the display to access various features.</p>
	<p>SELECT: Used to select the displayed item or to call the displayed phone number.</p>		<p>SHIFT: Used to access the second level of Soft button features.</p>
	<p>ENTER: Used to confirm the selected item.</p>		<p>CANCEL: Used to cancel the selected item.</p>
	<p>NEXT PAGE: Used to switch the page for the Self Labeling feature. (KX-NT366 only)</p>		

Customized Buttons

If the term is in parentheses like (Account) in this manual, it means a flexible button has been made into an "Account" button. To customize, refer to "3.1.4 Customizing the Buttons".

Button	Feature
Loop-CO (L-CO)	Used to access an idle CO line for making outside calls. Incoming outside calls from any CO line arrive at this button.
Group-CO (G-CO)	Used to access an idle CO line in a specified CO line group for making outside calls. Incoming calls from CO lines in the assigned CO line group arrive at this button.
Single-CO (S-CO)	Used to access a specified CO line for making or receiving outside calls.
Direct Station Selection (DSS)	Used to access an extension with one touch. It is also possible to be changed to the other feature button.
One-touch Dialing	Used to access a desired party or system feature with one touch.
Incoming Call Distribution Group (ICD Group)	Used to access a specified incoming call distribution group for making or receiving calls.
Message	Used to leave a message waiting indication or call back the party who left the message waiting indication.
Message for Another Extension	Used to have a Message button for another extension.

1.1.1 Before Operating the Telephones

Button	Feature
Call Forwarding (FWD)/Do Not Disturb (DND)—Both calls	Used to forward all calls to a specified destination or refuse.
FWD/DND—Outside calls	Used to forward CO line calls to a specified destination or refuse.
FWD/DND—Intercom calls	Used to forward intercom calls to a specified destination or refuse.
Group FWD—Both calls	Used to forward all the calls to your group to a specified destination.
Group FWD—Outside calls	Used to forward the CO line calls to your group to a specified destination.
Group FWD—Intercom calls	Used to forward the intercom calls to your group to a specified destination.
Account	Used to enter an account code.
Conference	Used to establish a multiple party conversation.
Terminate	Used to disconnect the current call and make another call without hanging up.
External Feature Access (EFA)	Used to access special features offered by a host PBX or a telephone company.
Call Park	Used to park or retrieve a call in a preset parking zone.
Call Park (Automatic Park Zone)	Used to park a call in an idle parking zone automatically.
Call Log	Used to show the incoming call information.
Call Log for ICD Group	Used to have a Call Log button for incoming call distribution group.
Log-in/Log-out	Used to switch between the log-in and log-out mode.
Log-in/Log-out of a specified group	Used to have a Log-in/Log-out button for another incoming call distribution group.
Log-in/Log-out for all groups	Used to have a Log-in/Log-out button for all groups.
Hurry-up	Used to transfer the longest waiting call in the queue of an incoming call distribution group to the overflow destination.
Wrap-up	Used to switch the wrap-up status, Ready and Not Ready mode.
System Alarm	Used to confirm a PBX error.
Time Service (Day/Night/Lunch/Break)	Used to switch the time service mode.
Answer	Used to answer an incoming call.
Release	Used to disconnect the line during or after a conversation or to complete a Call Transfer.
Toll Restriction (TRS)	Used to change the toll restriction level of other extension users temporarily.
Calling Line Identification Restriction (CLIR)	Used to switch between the CLIP and CLIR services.
Connected Line Identification Restriction (COLR)	Used to switch between the COLP and COLR services.
Headset	Used to talk using the headset.

Button	Feature
Time Service Switching Mode (Automatic/Manual)	Used to switch the time service mode, Automatic or Manual.
Two-way Record	Used to record a conversation into your own mailbox.
Two-way Transfer	Used to record a conversation into the mailbox of a specific extension.
One-touch Two-way Transfer	Used to record a conversation into the mailbox of a specific extension with one touch.
Live Call Screening (LCS)	Used to monitor your own voice mailbox while an incoming caller is leaving a message and, if desired, intercept the call.
Voice Mail Transfer	Used to transfer a call to the mailbox of a specified extension.
Network Direct Station Selection (NDSS)	Used to access an extension connected to other PBXs in the network with one touch.
CTI	Used to access CTI features.
Check-in	Used to switch the room status of extensions from Check-out to Check-in.
Check-out	Used to switch the room status of extensions from Check-in to Check-out.
Cleaned-up ^{*1}	Used to switch the room status of extensions between Ready and Not Ready.
Primary Directory Number (PDN)	Used to make and receive both outside and intercom calls.
Secondary Directory Number (SDN)	Used to show the current status of another extension, call the extension, and pick up or transfer calls to it.

^{*1} Only available for the KX-TDE600.

◆◆ How to Follow the Steps

An example of system operation is shown below.

◆◆ **Calling Another Extension** ----- **Feature title**

Intercom Call -----

PT/SLT/PS/SIP Extn.



Off-hook. Dial extension number or press DSS. Talk.

----- **Operation steps**
The description of the icons are explained on "Icon Descriptions".

----- **Conditions**

----- **Hints**

 **Customizing Your Phone**

- 3.1.2 Settings on the Programming Mode—**Preferred Line Assignment—Outgoing**
Select the seized line when going off-hook.
- 3.1.3 Customizing the Buttons
Create or edit a Direct Station Selection (DSS) button.

----- **Programming References:** The related or required programming is noted.

◆◆ Connection Example

This diagram shows you a connection example.

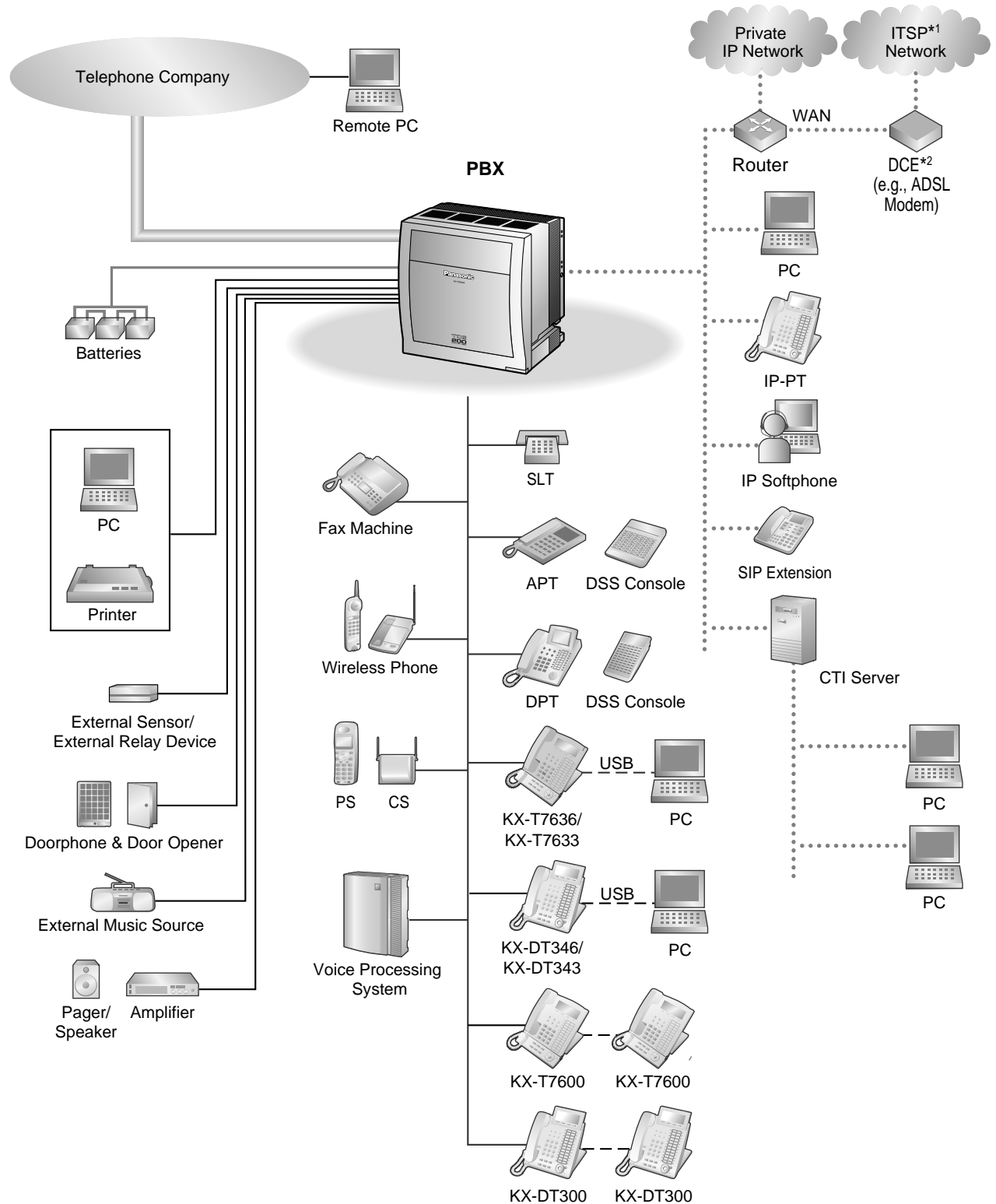

¹ ITSP: Internet Telephony Service Provider

² DCE: Data Circuit Terminating Equipment

1.2 Basic Operations

1.2.1 Making Calls

- ◆◆ Intercom Call
- ◆◆ Operator Call
- ◆◆ Calling an Outside Party

◆◆ Intercom Call

You can call another extension user.

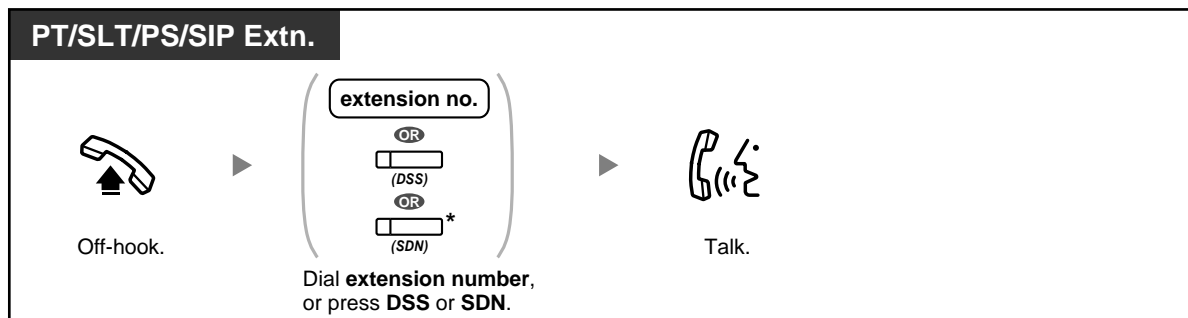

- The DSS button light shows the current status as follows:
Off: The extension is idle.
Red on: Your or another extension is using the line.
- * You have to press the SDN button once or twice depending on the mode of the SDN button. For details, refer to "1.3.49 PDN (Primary Directory Number)/SDN (Secondary Directory Number) Extension".



- To call using a directory, refer to "1.4.3 Directories".
- **For quick operation**
If you are an operator or dial some extensions frequently, DSS buttons are useful.
- **Hands-free Operation**
You can make an intercom call and have a conversation in hands-free mode using the SP-PHONE button (refer to "1.3.31 Hands-free Operation").



Customizing Your Phone

- 3.1.2 Personal Programming—**Preferred Line Assignment—Outgoing**
Select the seized line when going off-hook.
- 3.1.4 Customizing the Buttons
Create or edit a Direct Station Selection (DSS) button.

◆◆ Operator Call

You can call an extension or a group assigned as the operator.

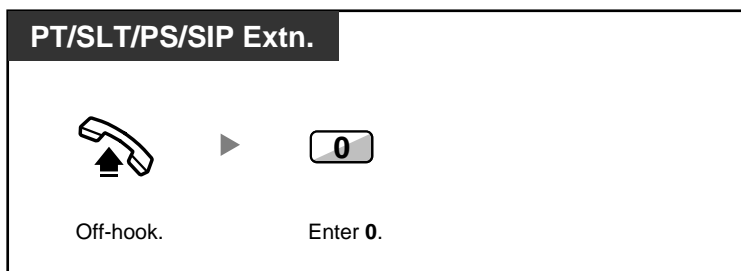

◆◆ Calling an Outside Party

You have to seize a CO line before dialing an outside phone number because external calls are made via your PBX.

Select one of the following methods:

Automatic Line Access

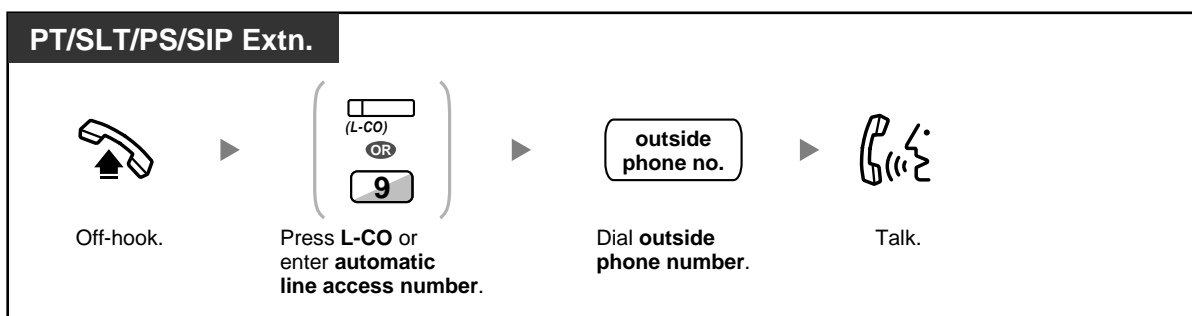

CO Line Group Access

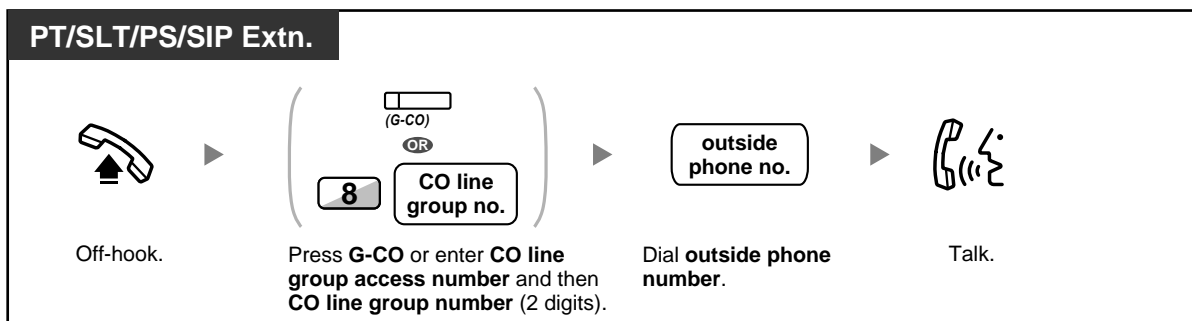

S-CO Line Access

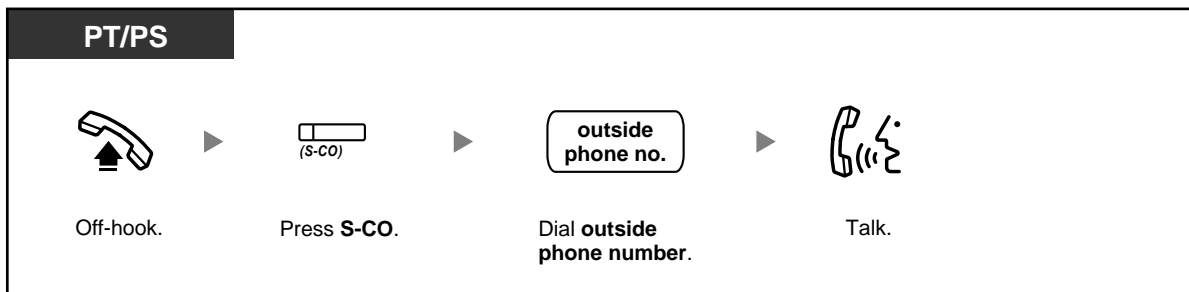

- Each of the S-CO button or G-CO button light shows the current status as follows:
Off: The line is idle.
Red on: The line is in use.
- You may be restricted from making a call to the specified outside party. To make a call, refer to "1.3.68 Verification Code Entry" or "1.3.74 Walking COS".



- **To confirm number before dialing**, you can enter a phone number and confirm it on the display and then go off-hook. (Predialing)
- **To make a call to another party without going on-hook**, press the FLASH/RECALL button. It will re-access the CO line and provide external dial tone. Pressing the Terminate button will provide intercom dial tone. You can dial the new phone number without going on/off-hook.
- **Hands-free Operation**
 You can make an outside call and have a conversation in hands-free mode using the SP-PHONE button (refer to "1.3.31 Hands-free Operation").



Customizing Your Phone

- 3.1.2 Personal Programming—**Preferred Line Assignment—Outgoing**
 Select the seized line when going off-hook.
- 3.1.4 Customizing the Buttons
 Create or edit a Loop-CO (L-CO) button, a Group-CO (G-CO) button, a Single-CO (S-CO) button or a Terminate button.

1.2.2 Answering Calls





- **You can select one of the following methods to answer calls:**
 - Lift the handset to receive the preferred line.
(Default: Ringing line is selected.)
 - Press the SP-PHONE button.
(Refer to "1.3.31 Hands-free Operation".)
 - Press the flashing CO, INTERCOM, ICD Group, PDN, or SDN button directly.
 - Press the Answer button.



Customizing Your Phone

- 3.1.2 Personal Programming—Preferred Line Assignment—Incoming
Select the seized line when going off-hook.
Alternate Receiving—Ring/Voice
Select the alerting method, either ring or the other party's voice.
- 3.1.4 Customizing the Buttons
Create or edit an Incoming Call Distribution Group (ICD Group), Primary Directory Number (PDN), or Secondary Directory Number (SDN) button.

1.3 Telephone Features and Operation

1.3.1 Absent Message

You can show the reason you do not answer, if the caller uses a Panasonic display proprietary telephone. There are eight preprogrammed messages and one for your personal message (16 characters). The selected message is shown on the display of your telephone.

Message no.	Message (Example)
1	Will Return Soon
2	Gone Home
3	At Ext %%% (Extension number)
4	Back at %:% (Hour:Minute)
5	Out until %/% (Month/Day)
6	In a Meeting
7	
8	
9	A message assigned for each extension. (Personal Absent Message)

To set

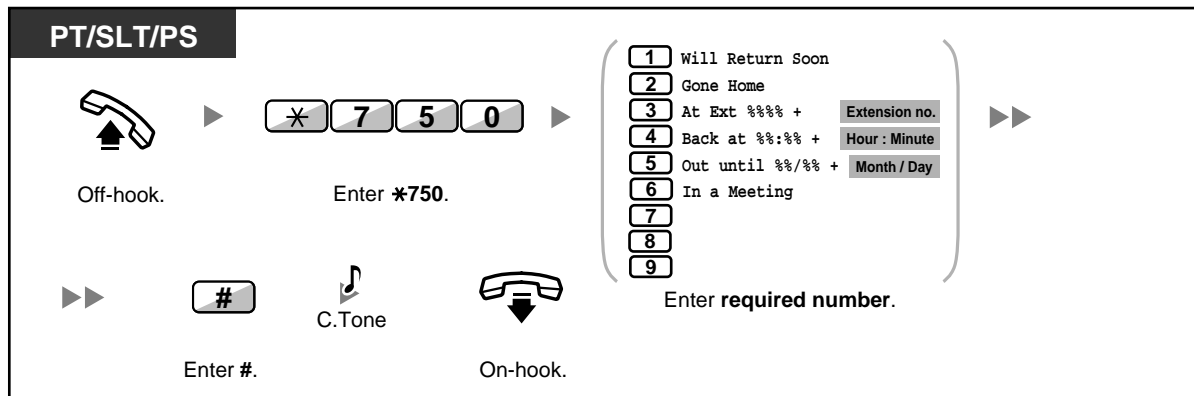

To cancel

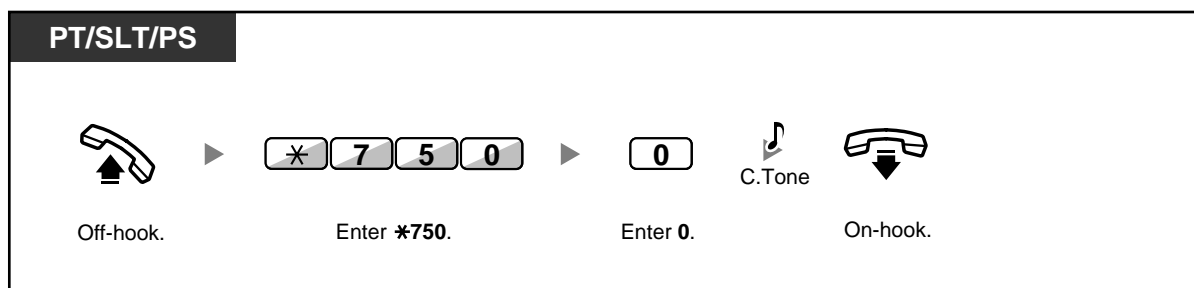



- Enter the desired value in the "%" positions. You must enter the correct number of characters as represented by the "%" using 0 to 9 or *.
- The preprogrammed messages can be changed through system programming.
- To create your personal message (Message no. 9), refer to "3.1.2 Personal Programming".

1.3.2 Account Code Entry

You may give a specified account code to extension users and check their telephone usage. You can specify an account code for each client and check the call duration.

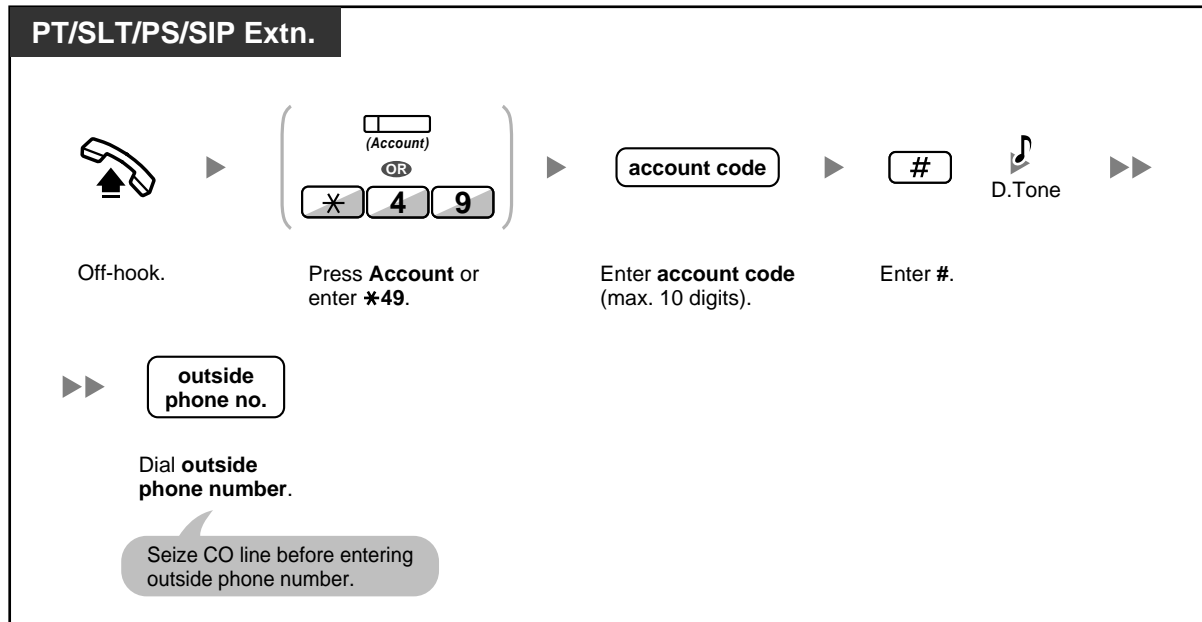

- **A Panasonic proprietary telephone extension user** can enter an account code during a conversation and when hearing reorder tone after the other party hangs up.
- Account codes may use the digits "0" through "9".
- Depending on the settings of your PBX, you may be required to enter an account code to make an outside call.
- **If you enter the wrong code**, press the "*" key and re-enter the account code.



- **For your convenience**, you can store the code with the phone number in the memory (e.g., Speed Dialing).



Customizing Your Phone

- 3.1.4 Customizing the Buttons
Create or edit an Account button.

1.3.3 Alternate Calling—Ring/Voice

The caller can alternate the alerting method, either ring or voice, when making an intercom call. On the other hand, any extension can set the alerting method, either ring or voice, when receiving an intercom call.

Ringing (Default): You can call the other party with a ring tone.

Voice-calling: You can talk to the other party immediately after confirmation tone.

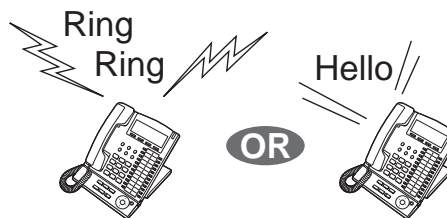

To change the method

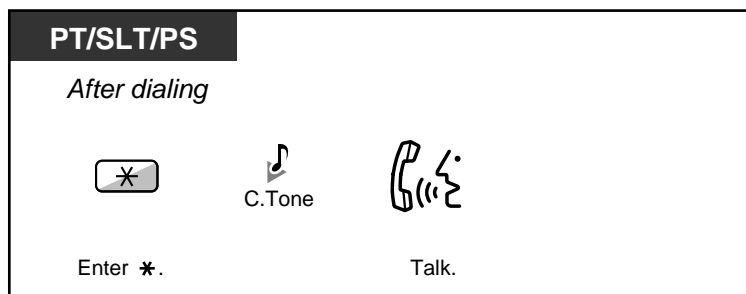

- Voice-calling from a SIP Extension is not available.
- If the called party uses a SIP Extension, single line telephone (SLT) or portable station (PS), Voice-calling is not available.
- This feature is not available when the called party's telephone is in the Voice Call Deny mode.



Customizing Your Phone

- 3.1.2 Personal Programming—**Alternate Receiving—Ring/Voice**
Select the alerting method, either ring or the other party's voice.

1.3.4 Automatic Callback Busy (Camp-on)

If a dialed extension or a desired CO line is busy, you can set the telephone to receive callback ringing:

- when a dialed extension becomes idle.
- when your desired CO line that is in use by another extension becomes idle.

You cannot set Automatic Callback Busy for a busy party outside of the PBX.

When you answer the callback ringing:

- For an outside call: The line is seized.
- For an intercom call: The called extension starts ringing automatically.

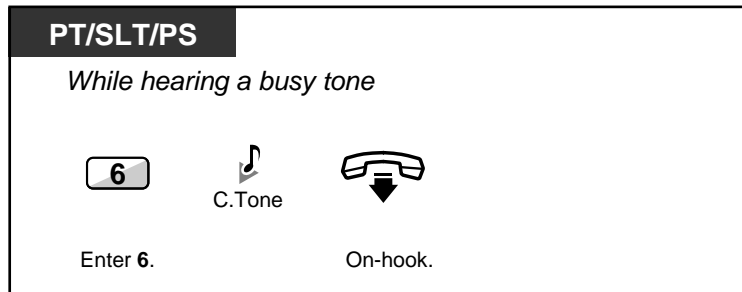
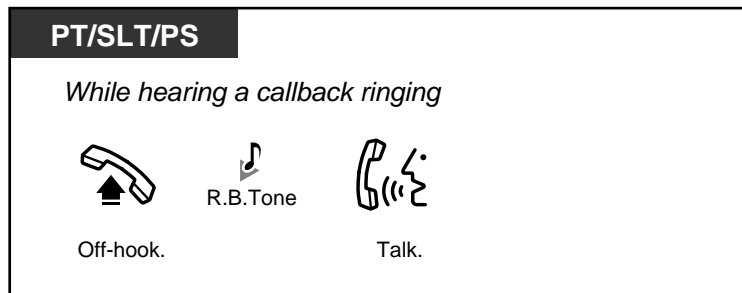
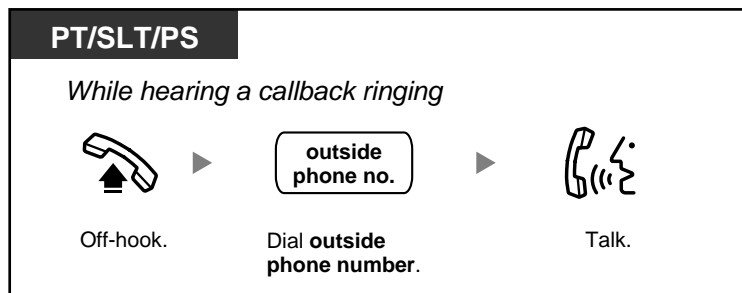
To set (for both extension and CO line)**To answer the callback ringing from an idle extension****To answer the callback ringing from an idle CO line**

- If you do not answer the callback ringing within 10 seconds, this feature will be canceled.

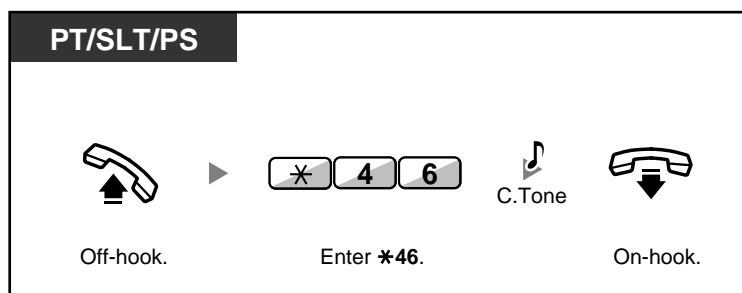
Automatic Callback Busy Cancel

1.3.5 BGM (Background Music)

You can listen to the background music through your telephone speaker while on-hook. An external music source, such as a radio, must be connected. If your extension becomes busy (off-hook, making or receiving a call etc.), the music stops temporarily. When you go back on-hook, the music starts again.



To select and set/cancel

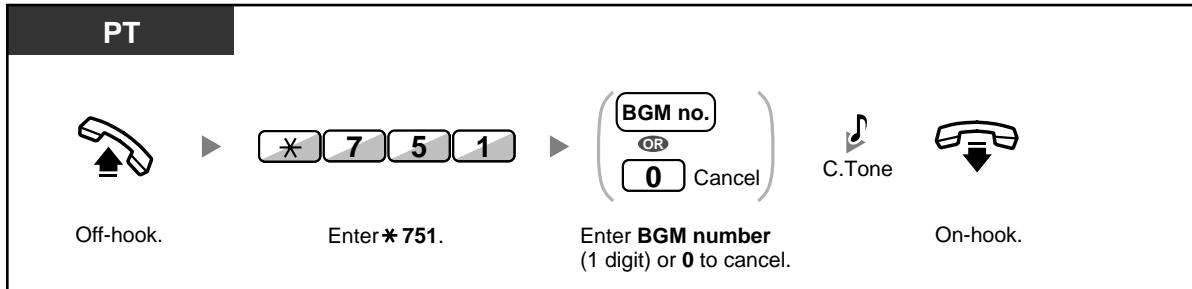

- System programming may be required for some IP-PT users to listen to background music.

1.3.6 Call Hold

There are two types of hold. The difference between them is whether other people can retrieve your held call (Regular Hold) or not (Exclusive Call Hold). As they can be alternated, ask your manager what the current mode is.





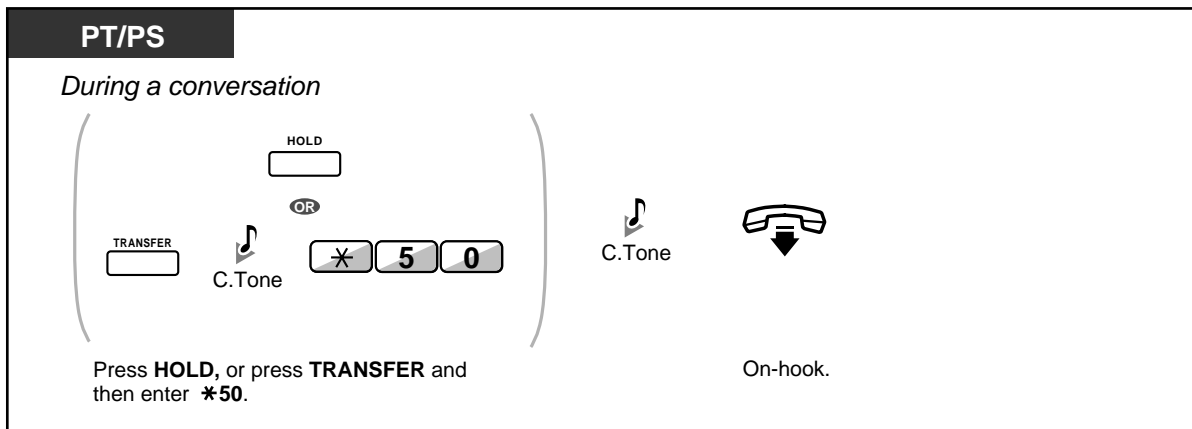

- **For users of SIP Extensions:**
The holding operation for SIP Extension users may differ from the steps in this section, and may vary depending on the type of telephone being used.

Call Hold



SLT



During a conversation

Press **Recall/ hookswitch**. Enter ***50**. On-hook.

SIP Extn.

During a conversation

  

Press **HOLD**. On-hook.

Call Hold Retrieve

PT/SLT/PS

● **At the holding extension (Call Hold Retrieve)**

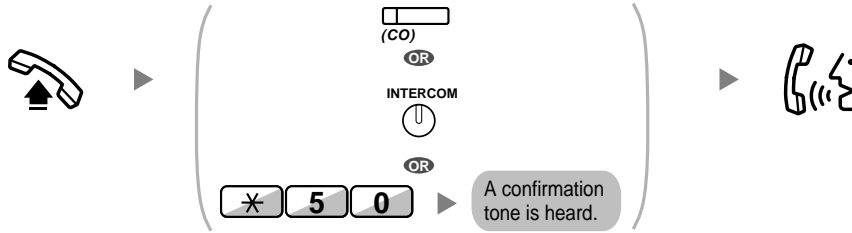

Off-hook. Press flashing **CO** or **INTERCOM**, or enter *** 50**. Talk.

● **To retrieve an outside call from another extension—only Regular Hold (Call Hold Retrieve—Specified with a held line number)**

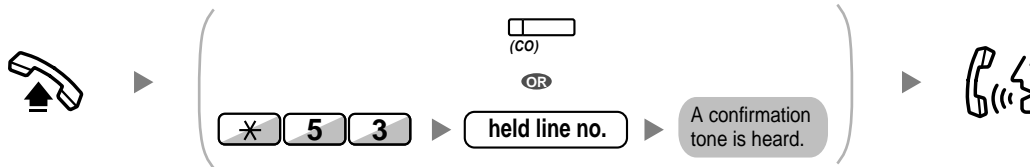

Off-hook. Press **CO**, or enter ***53** and then **held line number** (3 digits). Talk.

● **To retrieve an intercom call or outside call from another extension—only Regular Hold (Call Hold Retrieve—Specified with a holding extension number)**

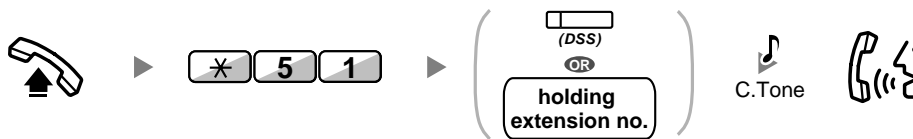

Off-hook. Enter ***51**. Press **DSS** or dial **holding extension number**. C.Tone Talk.

SIP Extn.



Off-hook. Press **HOLD**. Talk.



- The CO or INTERCOM button light shows the current status as follows:
 - Regular Hold mode
 - Flashing green slowly:** Your held call
 - Flashing red:** Another extension's held call
 - Exclusive Call Hold mode
 - Flashing green moderately:** Your held call
 - Red on:** Another extension's held call
- If a call is not retrieved within a specified time**, you will hear an alarm as a reminder (Hold Recall).
If an outside call is not answered within a specified time, it is automatically disconnected.
- Hold Mode Change (PT only)**
After pressing the HOLD button, if you press the HOLD button again, the status switches from the Regular Hold mode to the Exclusive Call Hold mode or from the Exclusive Call Hold mode to the Regular Hold mode.



- If **Automatic Call Hold** has been preprogrammed, you can put the current call on hold automatically by pressing another CO, ICD Group or INTERCOM button to make or answer another call.
- For the Call Hold Retrieve operation using a PDN/SDN button, refer to "1.3.49 PDN (Primary Directory Number)/SDN (Secondary Directory Number) Extension".

1.3.7 Call Monitor

A preprogrammed extension user can listen to the ongoing conversation of a busy extension user.

To monitor

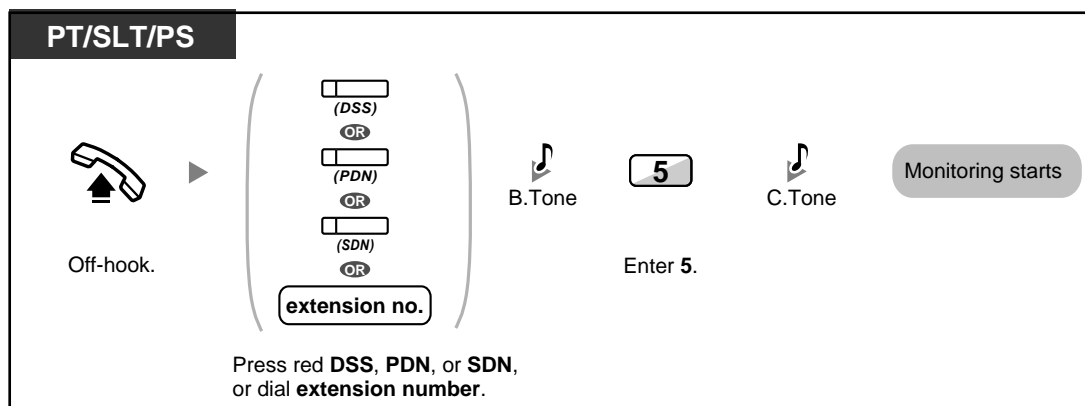

1.3.8 Call Park

You can put a call on hold in a common parking zone of the PBX so that any extension can retrieve the parked call. You can use this feature as a transferring feature.

A call can be put into either a specified parking zone (Specified) or any idle parking zone (Auto). If a Call Park button and Call Park (Automatic Park Zone) button have been established, you can select either way to park by simply pressing the corresponding button.

When a call is parked automatically, or more than one call has been parked at the same time, you need to specify the parking zone number to retrieve the required call.

To set

PT/PS

During a conversation



(Call Park)

Press **Call Park**.

PT/PS



During a conversation

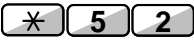

Press **TRANSFER**.

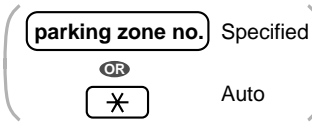

Enter ***52**.

Enter a specified **parking zone number** (2 digits) or press ***** to park at an idle parking zone automatically.



C.Tone



On-hook.

If you hear a busy tone, enter another parking zone number or press ***** again.

SLT

During a conversation



Press **Recall/hookswitch**.

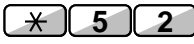

Enter ***52**.

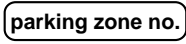

Enter a specified **parking zone number** (2 digits).



C.Tone



On-hook.

If you hear a busy tone, enter another parking zone number.

Call Park Retrieve

PT/PS



(Call Park)

Press a flashing **Call Park**.

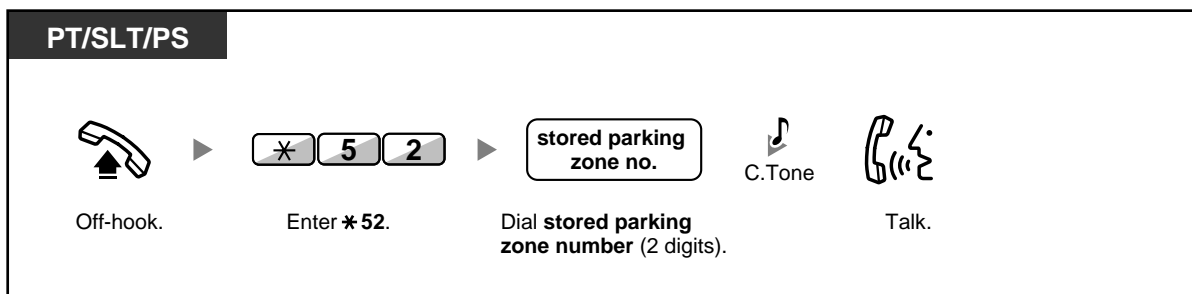

- If a call is parked automatically, confirm the parking zone number on the display.
- **If a call is not retrieved within a specified time**, you will hear an alarm as a reminder (Call Park Recall).
If an outside call is not answered within a specified time, it is automatically disconnected.



- **If you hear a reorder tone when retrieving a parked call**, there is no held call. Confirm the stored parking zone number.
- After you park a call, you can perform other operations.



Customizing Your Phone

- 3.1.4 Customizing the Buttons
Create or edit a Call Park button or Call Park (Automatic Park Zone) button.

1.3.9 Call Pickup

- ♦♦ Call Pickup
- ♦♦ Call Pickup Deny

♦♦ Call Pickup

You can answer an incoming call that is ringing at another extension or group from your phone without leaving your desk.

The following types of pickup are available:

Group Call Pickup: Picks up a call within your group.

Directed Call Pickup: Picks up a specified extension's call.

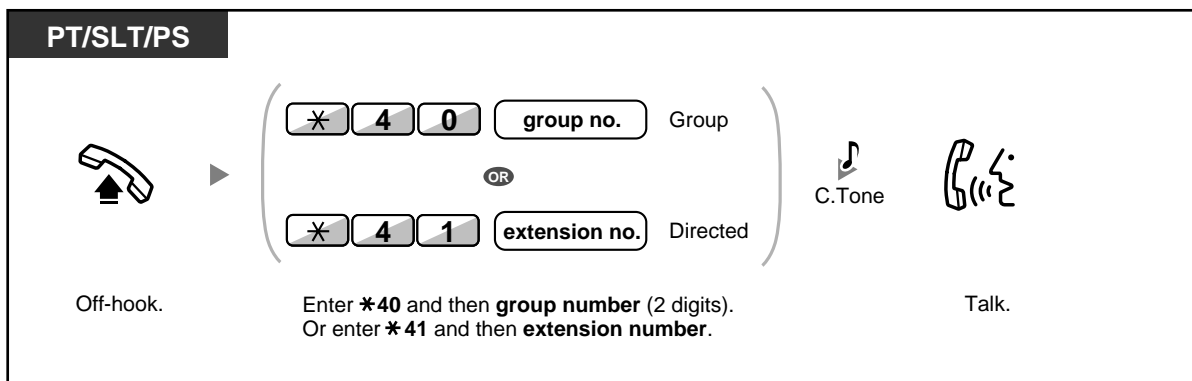



- If you receive a call waiting tone, you can ask a third party to pick up your second call with Directed Call Pickup.

◆◆ Call Pickup Deny

You can deny or allow other people to pick up your calls.

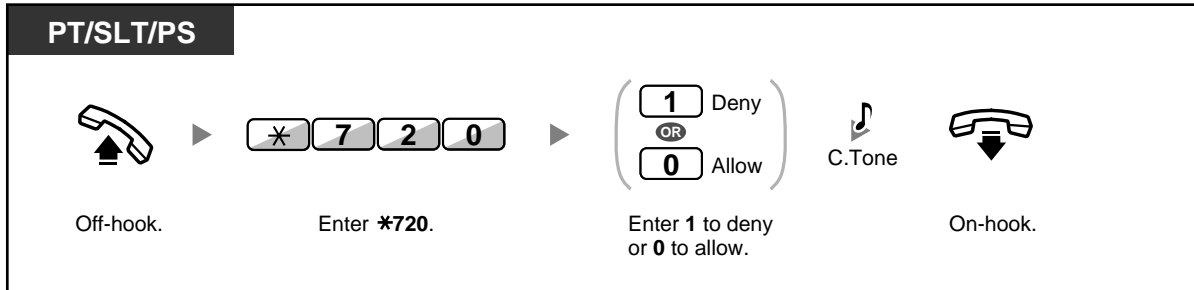

1.3.10 Call Splitting

When talking to one party while the other party is on hold, you can swap the calls back and forth (alternately).

To alternate between the parties leaving one party on hold temporarily

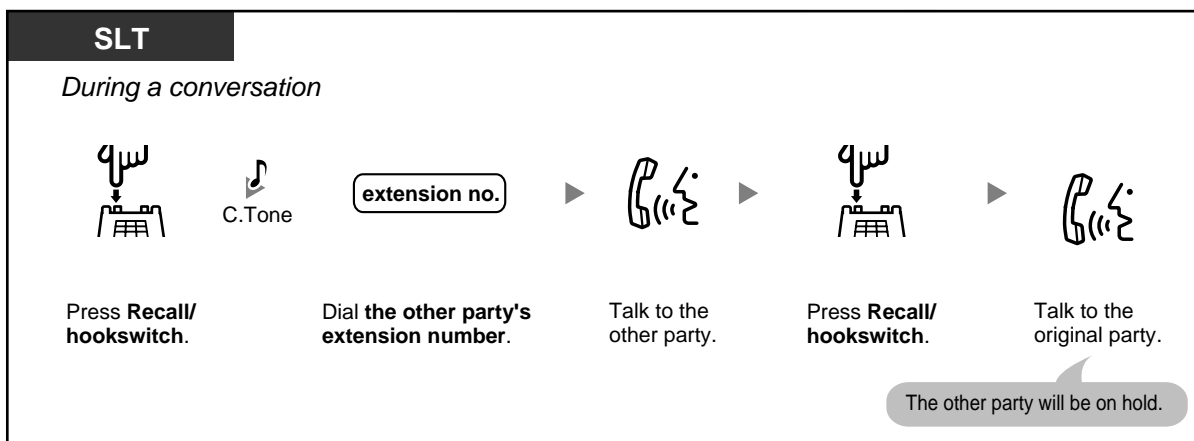
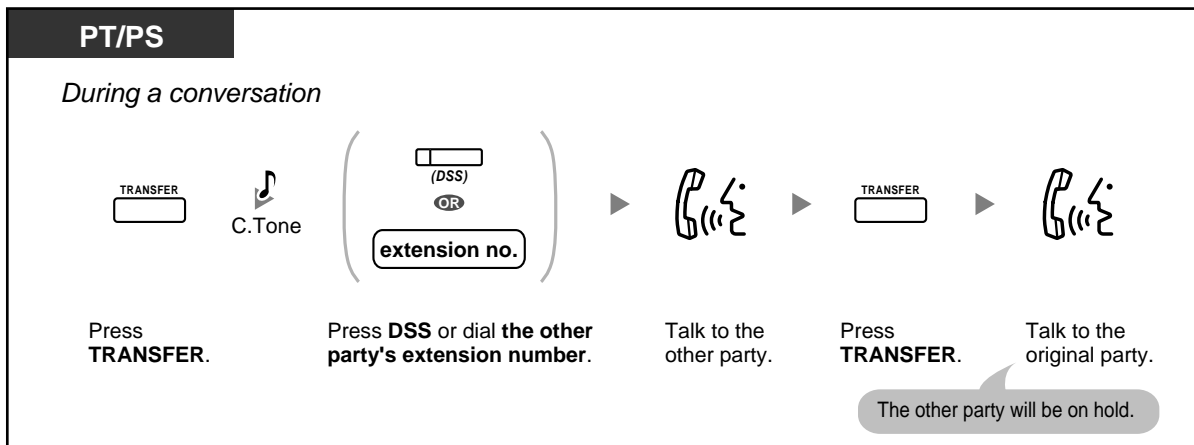

To leave the conversation and then let the two parties talk

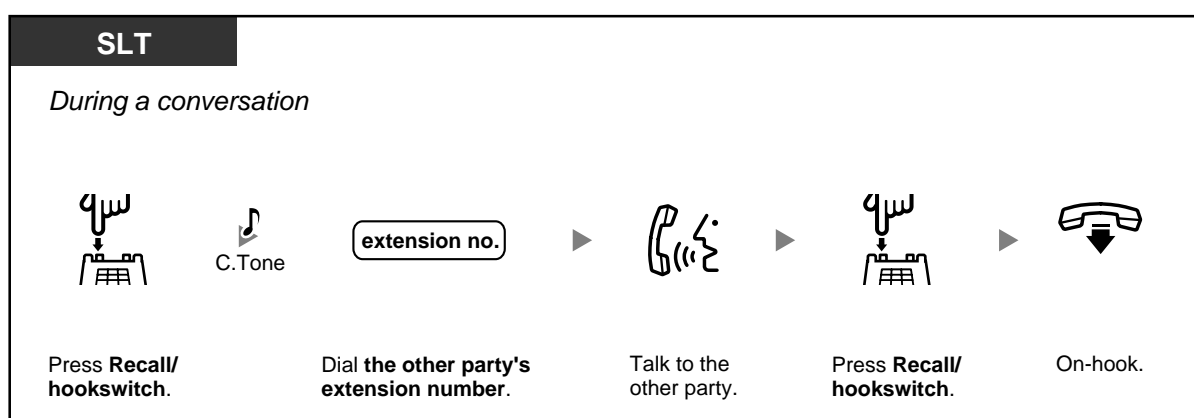
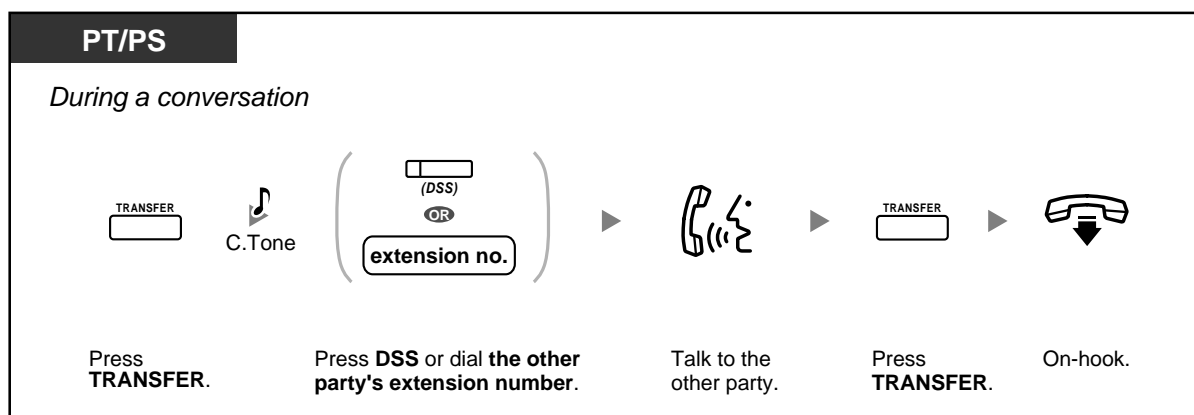

1.3.11 Call Transfer

- ◆◆ Transferring to an Extension in the PBX
- ◆◆ Transferring to an Outside Party Using the PBX Service



- You can transfer a held call without talking, and go on-hook even if the transferred party does not answer the call. (Not available for SIP Extensions.)
If a transferred call is not answered within a specified time, it will ring at a preprogrammed extension, if set, or at your extension again. If you are off-hook at that time, you will hear an alarm tone. If an outside call is not answered within a specified time, it is automatically disconnected.
- **For users of SIP Extensions:**
 - Even if your telephone has a TRANSFER button, you cannot use it to transfer calls. Please make sure to use the HOLD button.
 - The transfer operation for SIP Extension users may differ from the steps in this section, and may vary depending on the type of telephone being used.

◆◆ Transferring to an Extension in the PBX

To transfer

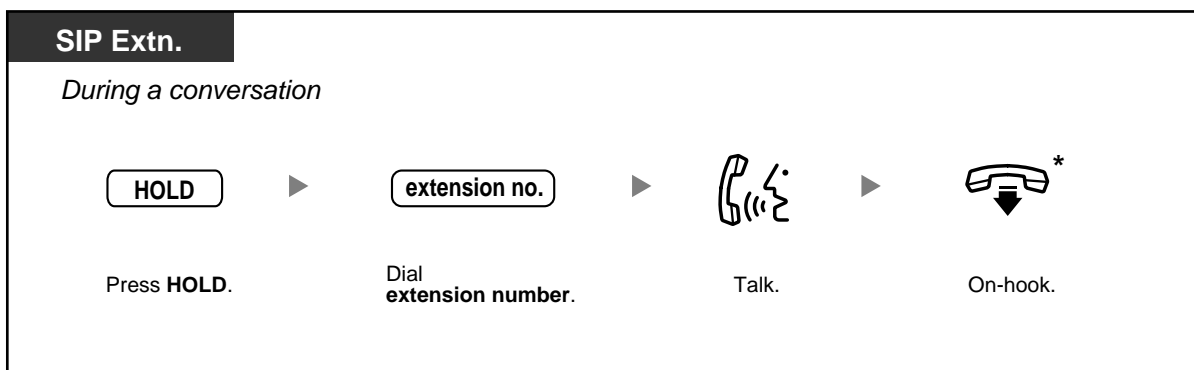
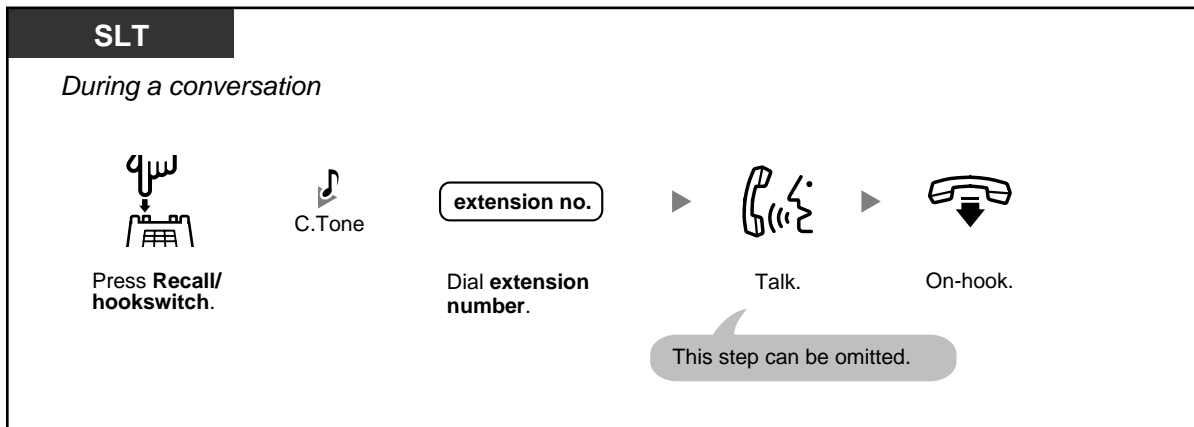
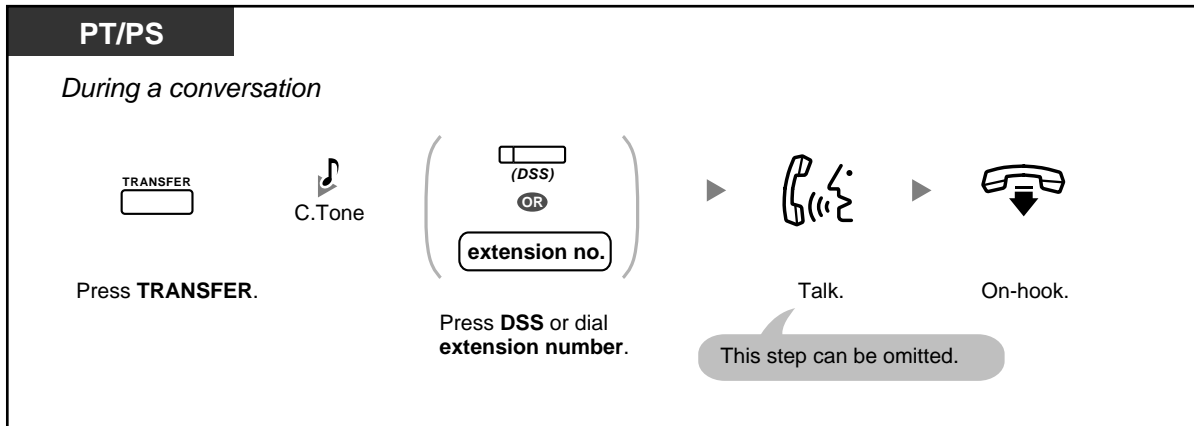

- * Instead of going on-hook, if you press the HOLD button once or twice (depending on the telephone being used), you can return to the held call, and the call with the transferred party will be disconnected.
- When you are not at your desk or not in the office and receive a forwarded outside call, for example on your cellular phone, it is possible to transfer the call to an extension in the PBX by pressing # + desired extension number (if enabled through system programming).



- For the transfer operation using an SDN button, refer to "1.3.49 PDN (Primary Directory Number)/SDN (Secondary Directory Number) Extension".

To transfer with one touch (One-touch Transfer)

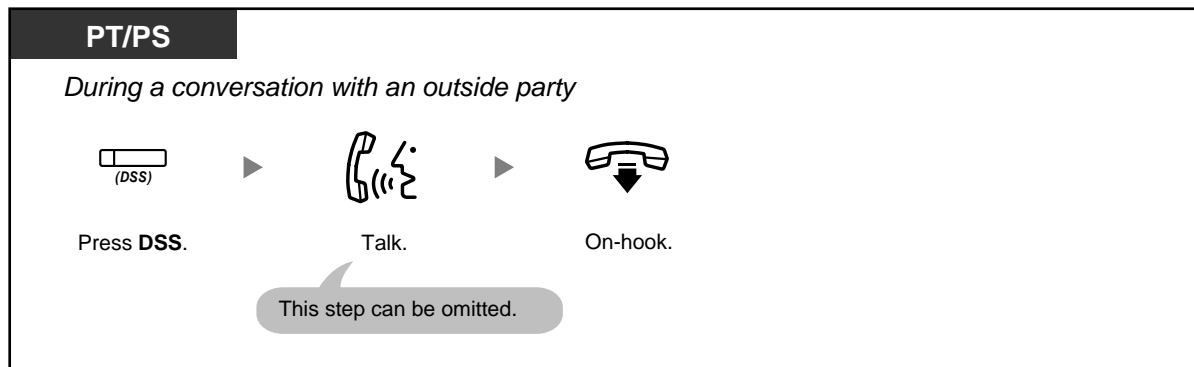

- System programming is required to use the One-touch Transfer feature during a conversation with an extension.

◆◆ Transferring to an Outside Party Using the PBX Service

Some extensions may be restricted from performing this feature.

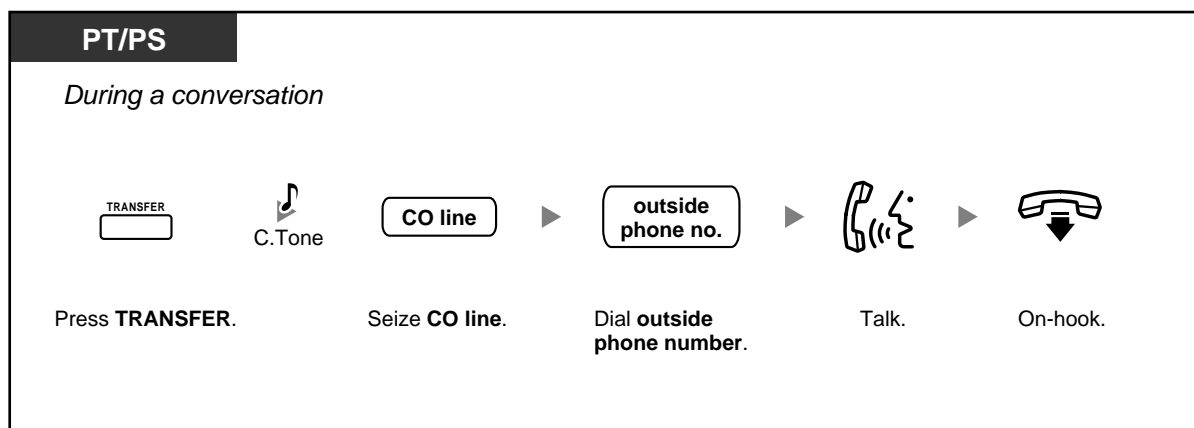

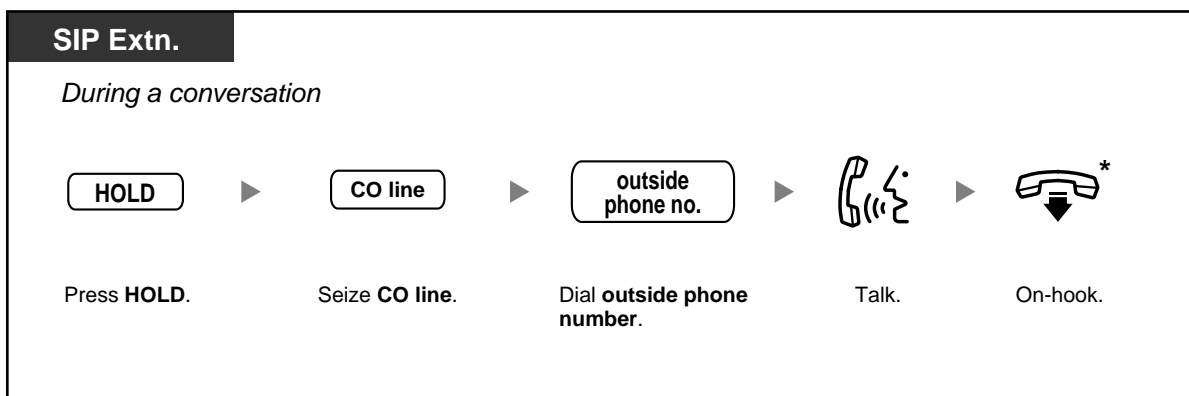
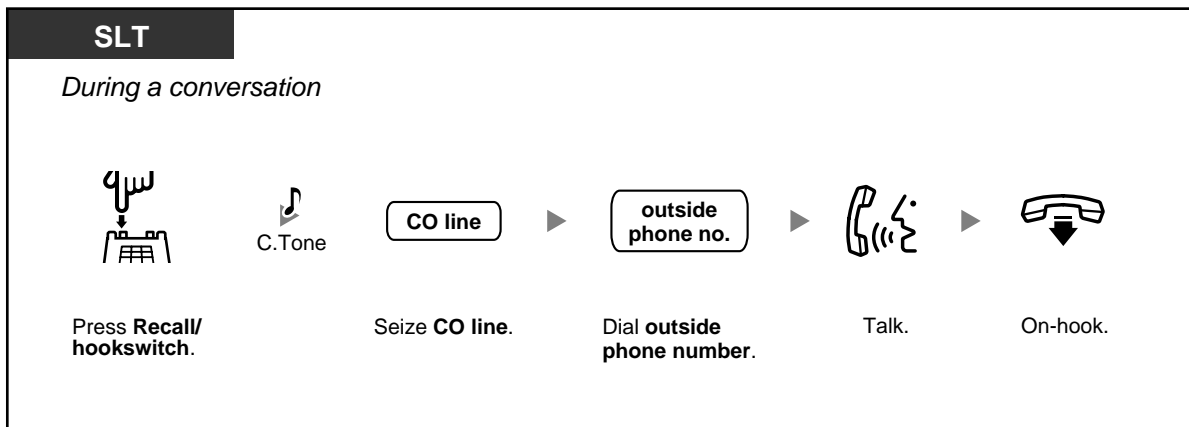

- * Instead of going on-hook, if you press the HOLD button once or twice (depending on the telephone being used), you can return to the held call, and the call with the transferred party will be disconnected.
- **Time limit**
Both the caller and the transferred party will hear an alarm tone fifteen seconds before a specified time period, and the call will be disconnected.
- **To return to the held call before the destination answers**, press the TRANSFER button, corresponding CO, ICD Group, or INTERCOM button, or the hookswitch.



Customizing Your Phone

- 3.1.4 Customizing the Buttons
Create or edit a Direct Station Selection (DSS) button.

1.3.12 CALL WAITING FEATURES

- ♦♦ Call Waiting (BSS [Busy Station Signaling])
- ♦♦ Answering Call Waiting in the PBX
- ♦♦ Answering Call Waiting from the Telephone Company

♦♦ Call Waiting (BSS [Busy Station Signaling])

◆ **For a caller**

You can inform a busy extension user that your call is waiting.

To send a call waiting

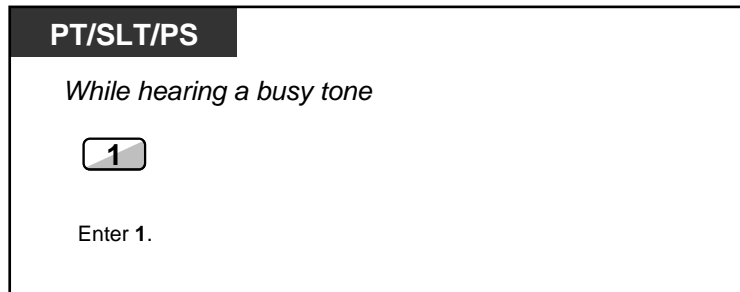

- **Depending on the type of the other party's telephone**, you may be able to talk to the other party using the speaker and the microphone (Off-hook Call Announcement [OHCA]), or you can send a call announcement through the handset (Whisper OHCA), if they are having another conversation using the handset. For more details on each feature, refer to "1.3.13 Call Waiting Tone", "1.3.45 OHCA (Off-hook Call Announcement)", or "1.3.77 Whisper OHCA".
- Depending on system programming and the called extension's setting, a call waiting tone may be sent automatically without performing the operation above. For details, refer to "**Automatic Call Waiting**" in "3.1.2 Personal Programming".

◆ For a called extension

A call waiting notification is sent to the busy extension user to notify him or her that a new incoming call is waiting. The extension can then answer the second call by either disconnecting the current call or placing it on hold.

One of the following notification methods can be assigned for each extension, depending on the type of telephone being used. (Default: Call Waiting Tone)

- **Call Waiting Tone:** A call waiting tone is heard through the built-in speaker of PT or handset of SLT (→ 1.3.13 Call Waiting Tone).
- **Off-hook Call Announcement (OHCA):** The caller's voice is heard through the built-in speaker (→ 1.3.45 OHCA (Off-hook Call Announcement)).
- **Whisper OHCA:** The caller's voice is heard through the handset (→ 1.3.77 Whisper OHCA).

◆◆ Answering Call Waiting in the PBX

During a conversation, a call waiting tone or voice announcement through the speaker or the handset occurs when an outside call has been received or another extension is letting you know a call is waiting. You must activate this feature to use it. (Default: Call Waiting Tone)

You can answer the second call by disconnecting (1) or holding (2) the current call.

1. To disconnect the current call and then talk to the new party

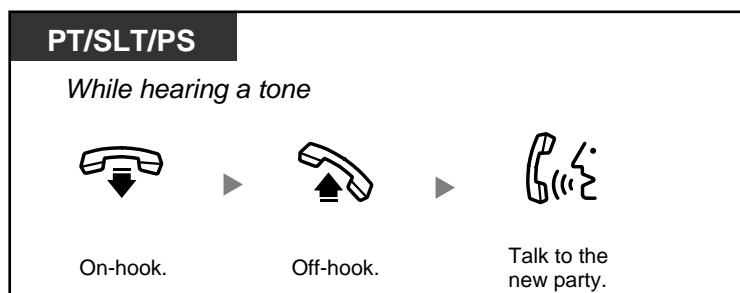

2. To hold the current call and then talk to the new party

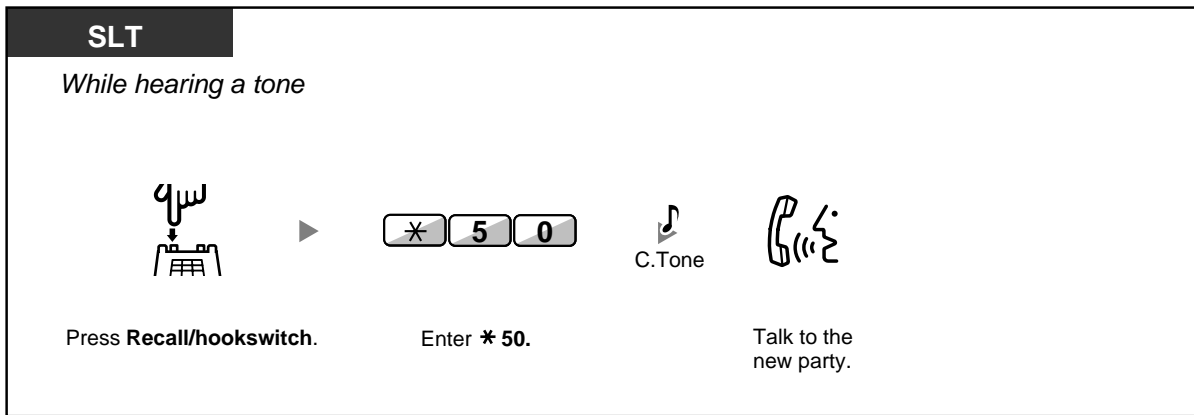
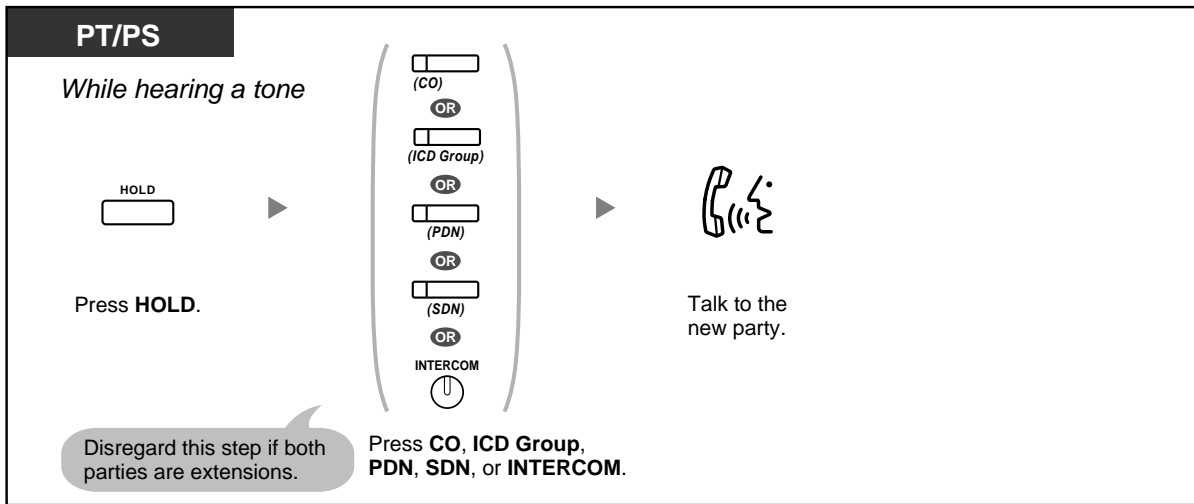

After talking to the new party (second call), you can disconnect (2.1) or hold (2.2) it and then retrieve the first call.

2.1 To disconnect the second call and then talk to the original party

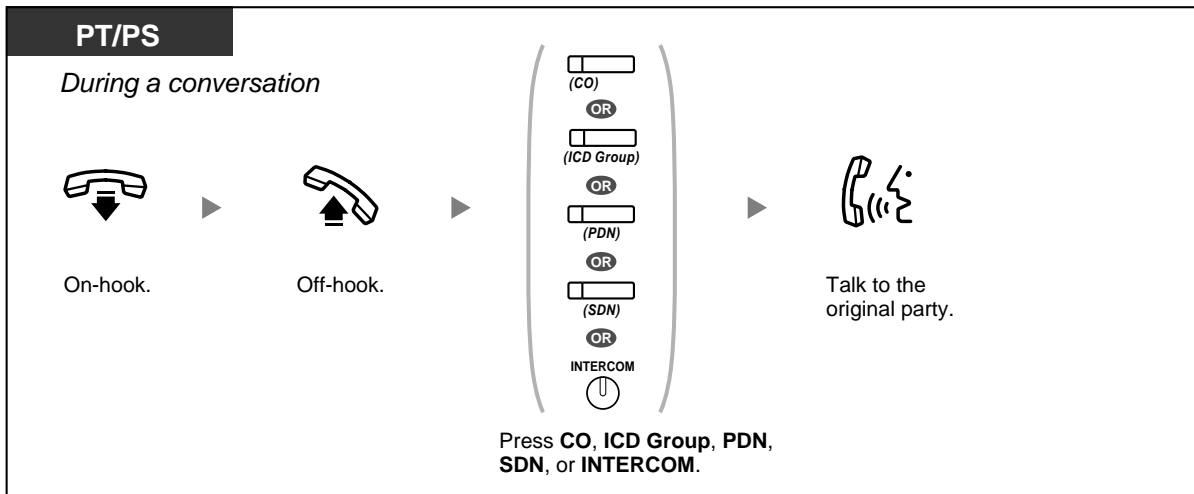

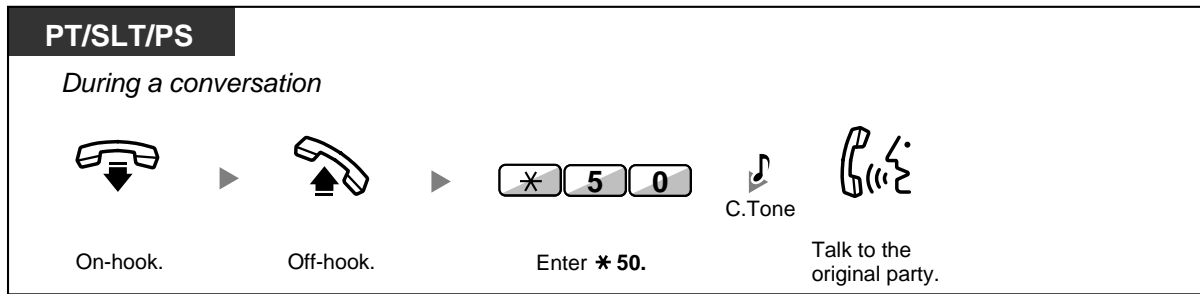

2.2 To hold the second call and then talk to the original party

After holding it, you can talk to the original party. Then, you can disconnect it and then talk to the new party again.

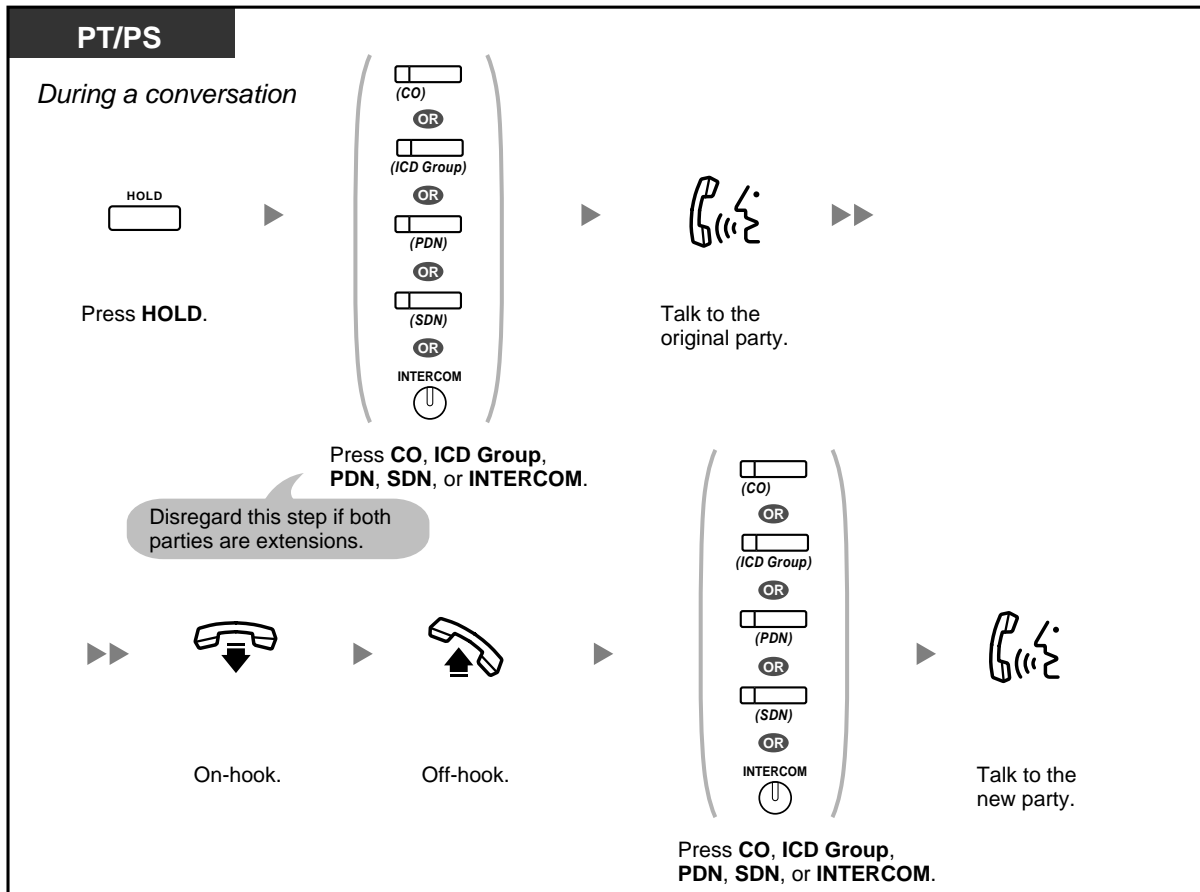

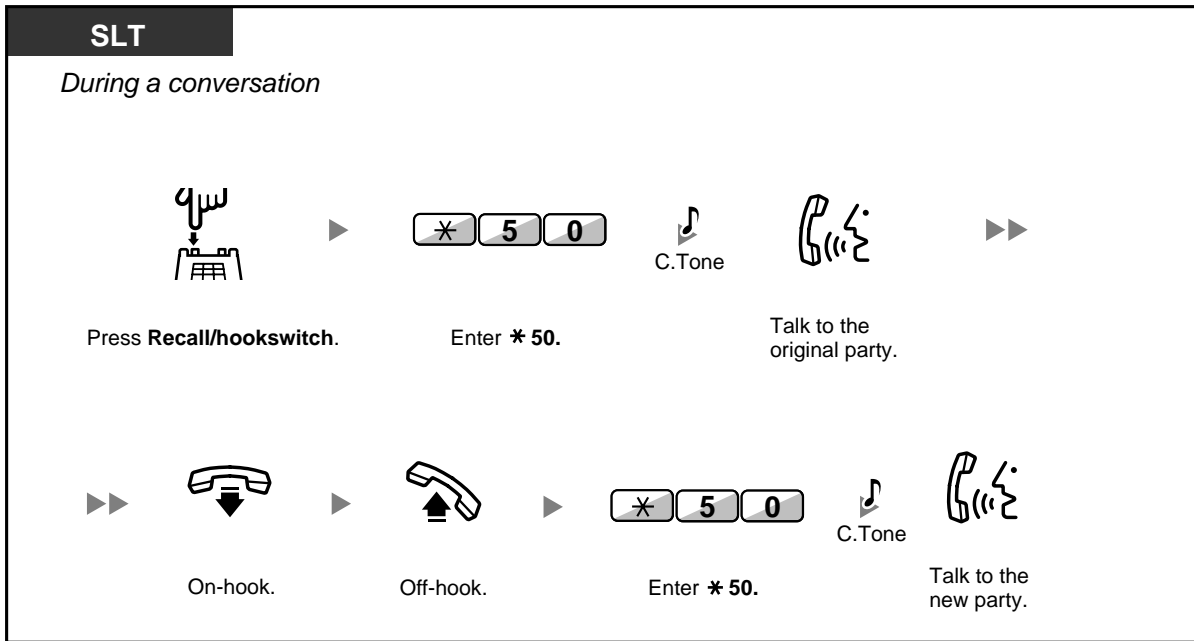

- **Depending on the type of your telephone**, you may be able to talk to the other party using the speaker and the microphone (Off-hook Call Announcement [OHCA]), or you can receive an announcement through the handset (Whisper OHCA), if you are having a conversation using the handset. For more details on each feature, refer to "1.3.13 Call Waiting Tone", "1.3.45 OHCA (Off-hook Call Announcement)", or "1.3.77 Whisper OHCA".
- The caller's name or number is displayed for five seconds in fifteen second intervals while waiting to be answered.



Customizing Your Phone

3.1.2 Personal Programming—Call Waiting Tone Type Selection

If you select "Tone 1", you will hear the same tone for Call Waiting from an outside party and an extension. If you select "Tone 2", you will hear different tones for Call Waiting from an outside party and an extension.

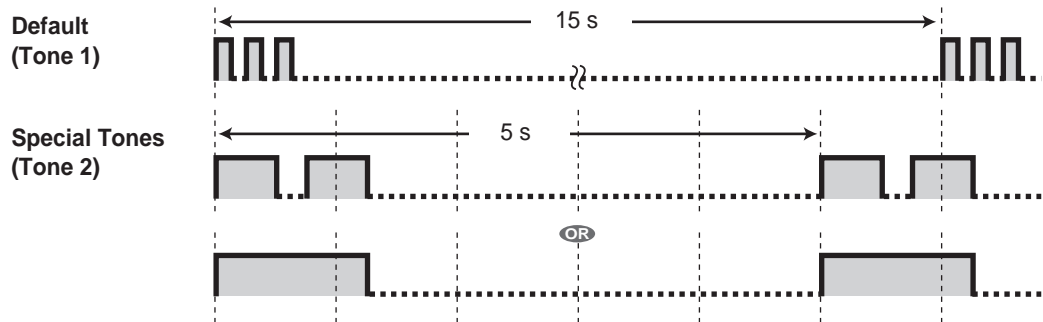

◆◆ Answering Call Waiting from the Telephone Company

This is an optional telephone company service. You can receive a call waiting tone with the caller's name or telephone number information. For details, consult your telephone company.

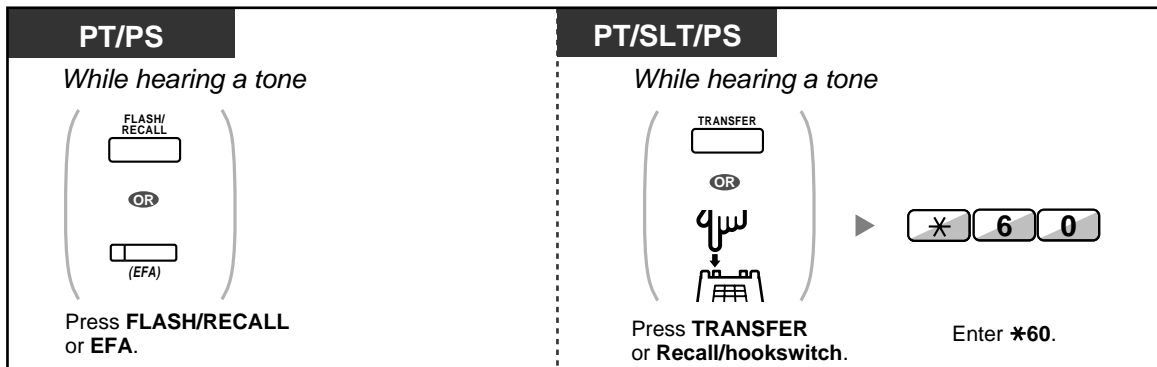

- **To return to the original party**, repeat the operation.
- In this case, the FLASH/RECALL button on proprietary telephones must be set to External Feature Access (FEFA) mode through system programming.
- The caller's telephone number will not be displayed on telephones or wireless phones connected to SLT ports.



Customizing Your Phone

- 3.1.4 Customizing the Buttons
Create or edit an External Feature Access (EFA) button.

1.3.13 Call Waiting Tone

During a conversation, you can be informed of a waiting call with a call waiting tone through the built-in speaker of your PT or the handset of your SLT.

To set/cancel for intercom calls (Manual Call Waiting)

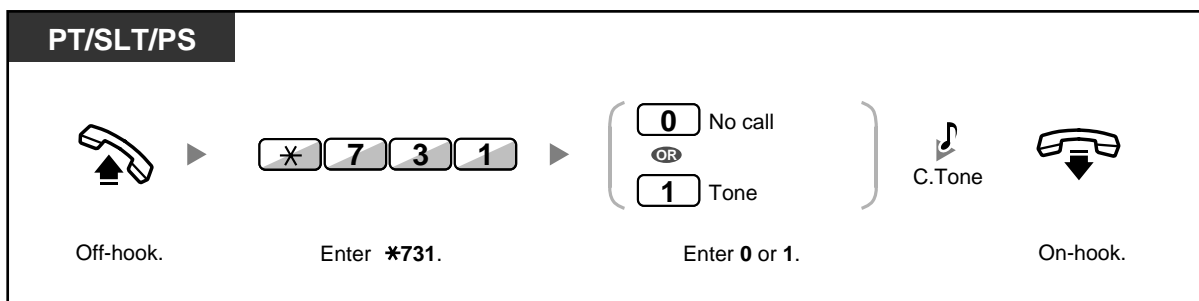

To set/cancel for outside calls (Automatic Call Waiting)

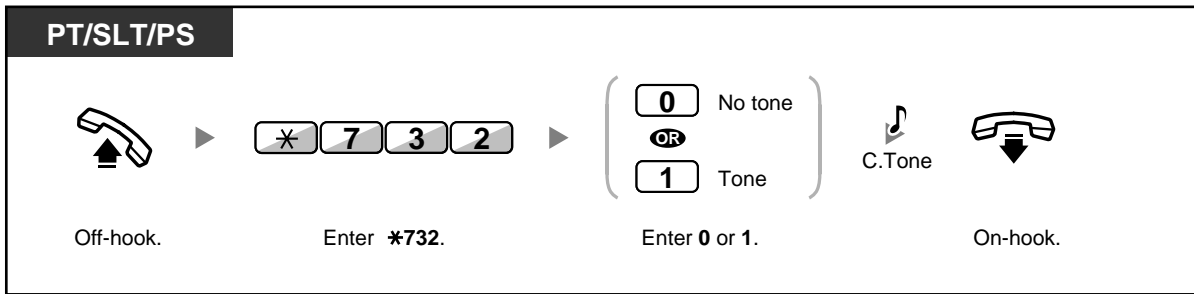

- To change the tone from a PT, refer to "3.1.2 Personal Programming".



- For information about answering a waiting call, refer to "1.3.12 CALL WAITING FEATURES".

1.3.14 Character Entry

You can enter the following characters. The tables show you the characters available for each button. Table 1 or Table 2 can be programmed.

Table 1 (Standard mode)

Times Buttons	1	2	3	4	5	6	7	8	9
1	!	?	"	1					
2	A	B	C	a	b	c	2		
3	D	E	F	d	e	f	3		
4	G	H	I	g	h	i	4		
5	J	K	L	j	k	l	5		
6	M	N	O	m	n	o	6		
7	P	Q	R	S	p	q	r	s	7
8	T	U	V	t	u	v	8		
9	W	X	Y	Z	w	x	y	z	9
0	(Space)	.	,	'	:	;	0		
*	/	+	-	=	<	>	*		
#	\$	%	&	@	()	€	£	#



Table 2 (Option mode)

Times Buttons	1	2	3	4	5	6	7	8	9	10	11	12	13	14	15
1	!	?	"	ä	ö	ü	1								
2	A	B	C	a	b	c	À	Á	Â	Ã	Ä	Å	Æ	Ç	2
3	D	E	F	d	e	f	Ð	È	É	Ê	Ë	3			
4	G	H	I	g	h	i	Ì	Í	Î	Ï	4				
5	J	K	L	j	k	l	5								
6	M	N	O	m	n	o	Ñ	Ò	Ó	Ô	Õ	Ö	Ø	Œ	6
7	P	Q	R	S	p	q	r	s	Š	ß	7				
8	T	U	V	t	u	v	Ù	Ú	Û	Ü	8				
9	W	X	Y	Z	w	x	Y	z	Ý	Ž	9				
0	(Space)	.	,	'	:	;	0								
*	/	+	-	=	<	>	*								
#	\$	%	&	@	()	€	£	#						

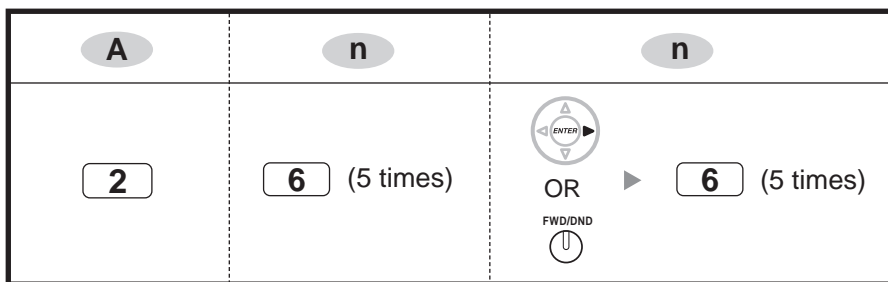
<Example> To enter "Ann"



Note

- To erase the character on the cursor, press CLEAR.
- To move the cursor to the left, press .
- To move the cursor to the right, press . When entering two or more characters that use the same button consecutively (e.g. "G" and "I"), you must press this button or the FWD/DND button after entering the first character.
- If the SELECT button is pressed, the characters for each button will be displayed in reverse order.
- To toggle between Table 1 and Table 2 when using a KX-T7600 series DPT, press the leftmost soft button.

1.3.15 Conference

- Conference
- Leaving Three-party Conference

◆◆ Conference

You can add one or more parties to your conversation.

To establish a conference call

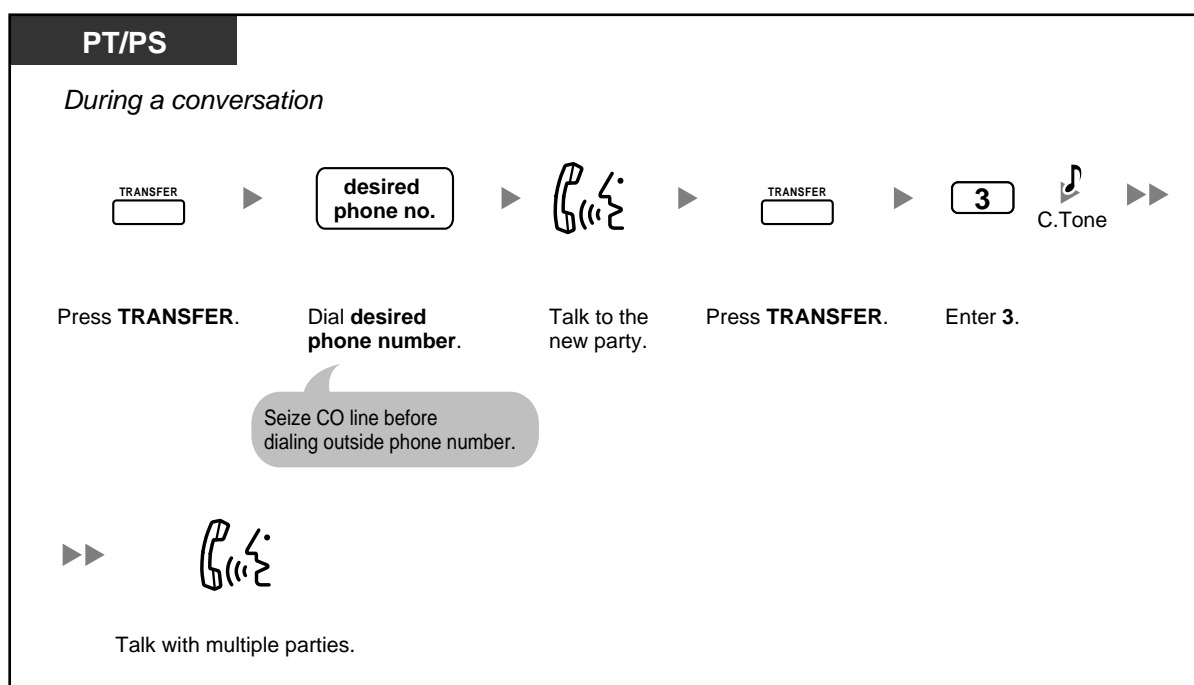
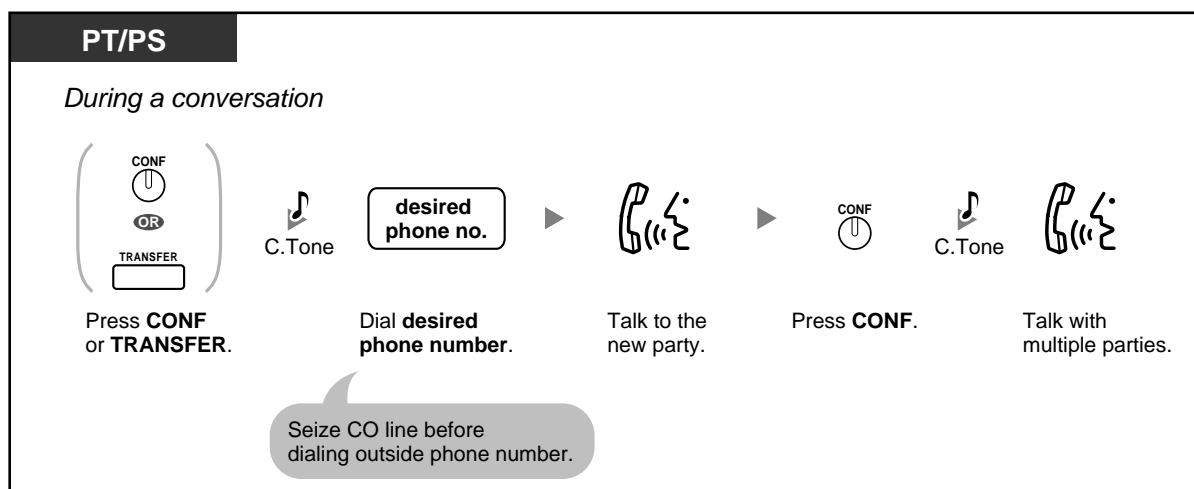

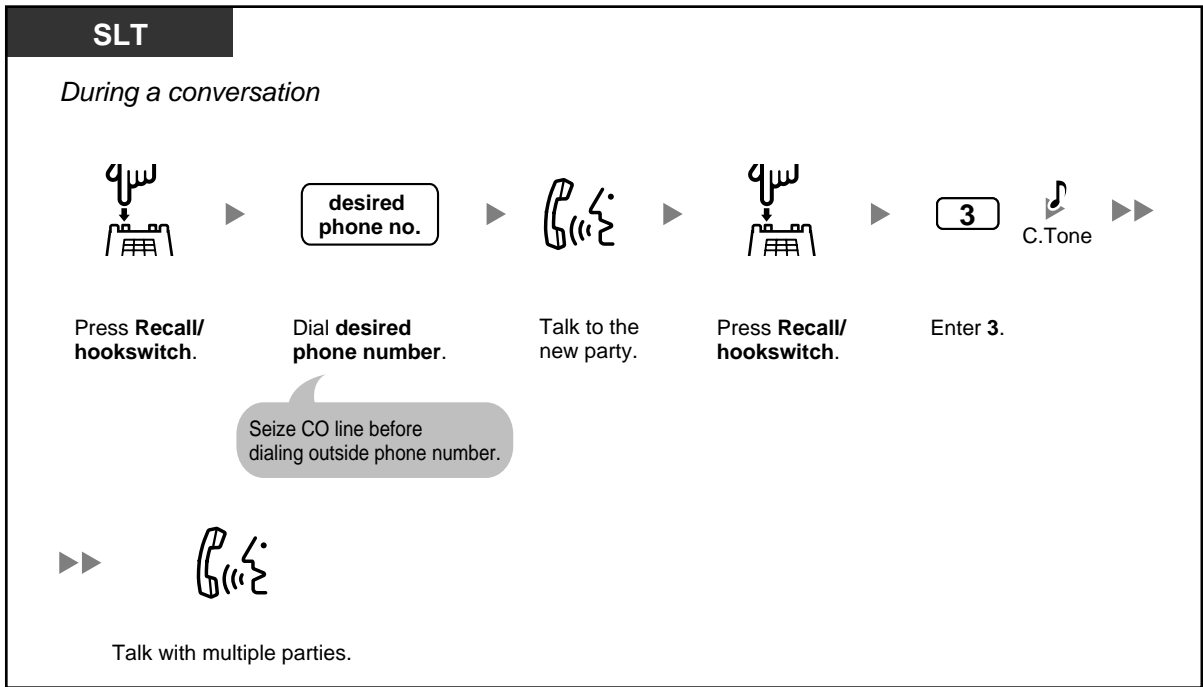

To establish a conference call when receiving a call from an outside party during a two-party conversation

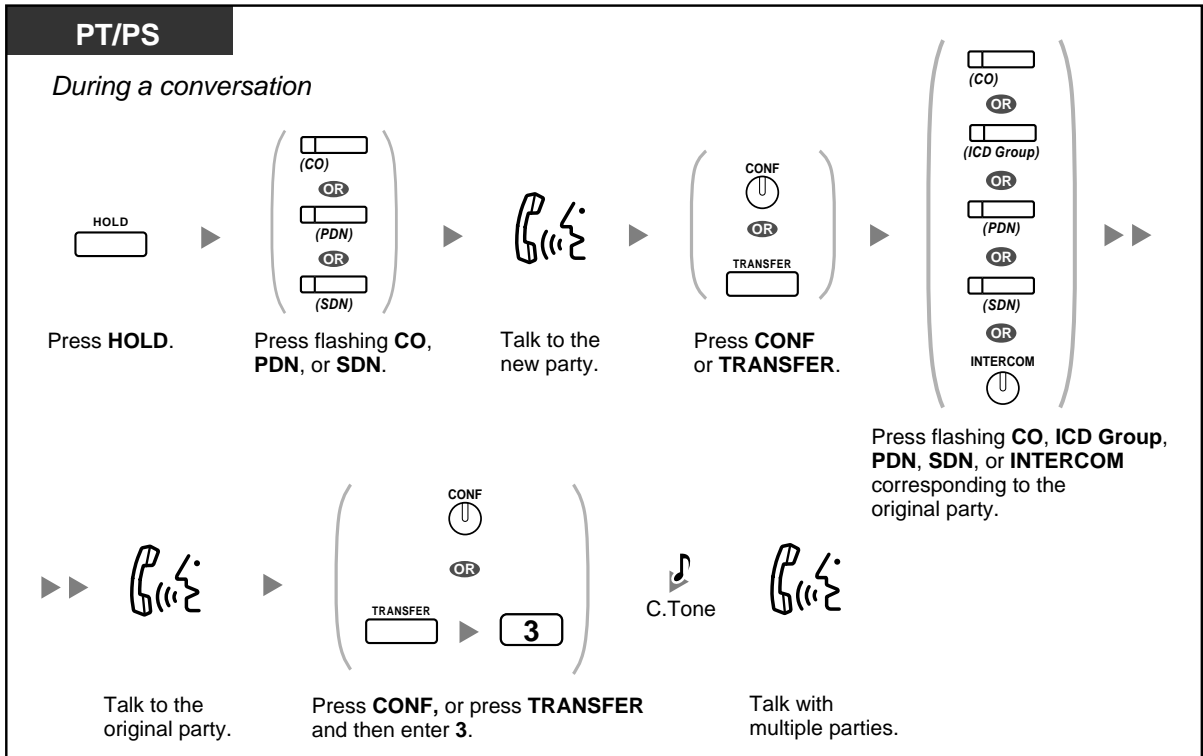

To add four or more parties to a conference

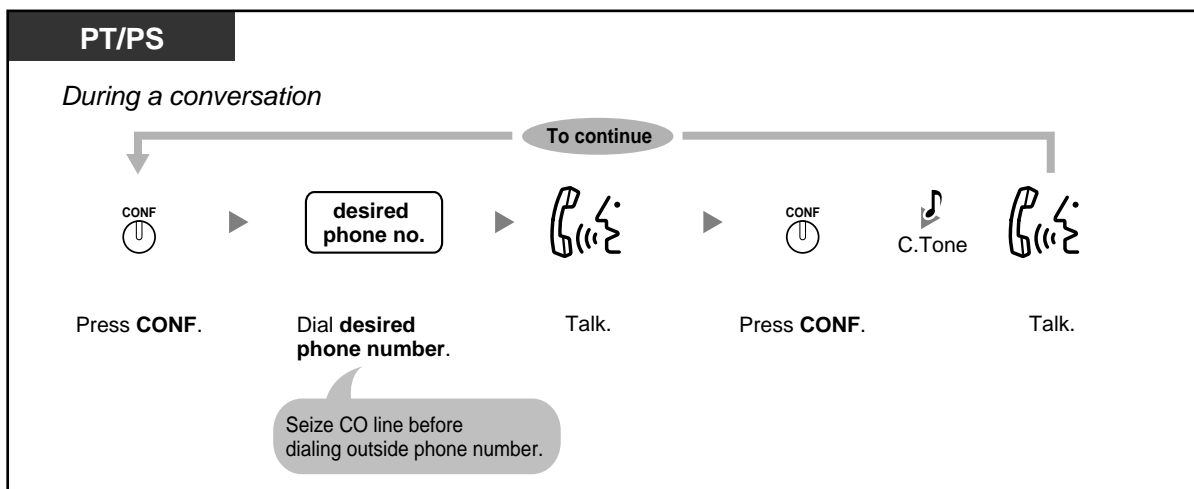

To add another party on hold to a conference

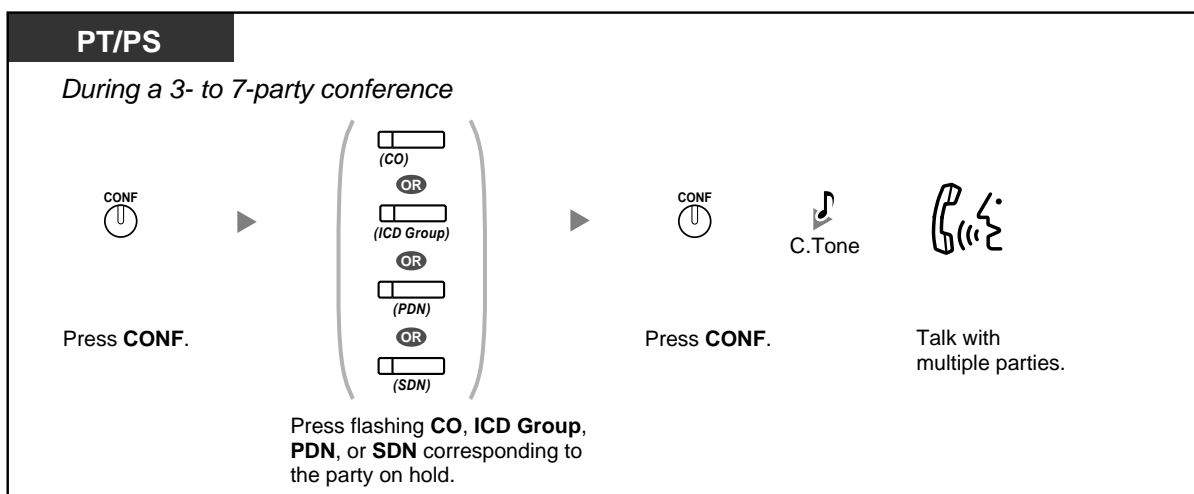

To talk to two parties alternately in a three-party conversation

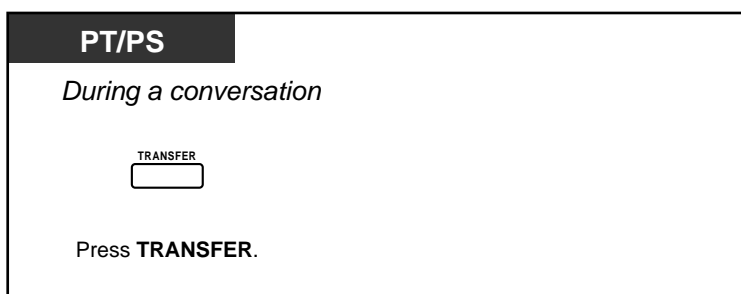

SLT

During a conversation



Press **Recall/hookswitch**.

To disconnect one party and then talk to the other in a three-party conversation

PT/PS

During a conversation

TRANSFER

▶

FLASH/RECALL *

▶

(CO)
OR

(ICD Group)
OR

(PDN)
OR

(SDN)
OR

INTERCOM

▶



Talk.

Press **TRANSFER** once or twice to establish a conversation with the party to be disconnected.

The other party will be put on hold.

Press **FLASH/RECALL**.

Press flashing **CO, ICD Group, PDN, SDN, or INTERCOM** corresponding to the original party.



- * In this case, the FLASH/RECALL button on a proprietary telephone must be set to Flash/Recall mode through system programming.
- During a three-party conversation, pressing the TRANSFER button or Recall/hookswitch alternates between the two other parties in the conversation.
- You can have a conference with a maximum of eight parties (comprising intercom or CO lines) simultaneously.
- During a conversation involving four or more parties, you cannot disconnect one party and maintain the conversation with the other parties.
- SIP Extensions cannot originate a conference call, but can be added as a member.



Customizing Your Phone

- 3.1.4 Customizing the Buttons
Create or edit a Conference button.

◆◆ Leaving Three-party Conference

The person who originated a conference with two other parties can leave the conference, and allow the other parties to continue the conversation.

To leave a conference involving at least one other extension

PT/SLT/PS

During a three-party conference



On-hook.

To leave a conference involving two outside parties

PT/PS

During a three-party conference



Press **TRANSFER**. On-hook.

SLT

During a three-party conference



Press **Recall/hookswitch**. On-hook.



- To leave a conference call involving two outside parties and have the conversation continue, your extension must be enabled to transfer calls to CO lines through COS programming.

1.3.16 Conference, Unattended

The person who originated a conference can leave the conference, and allow the other parties to continue the conversation.



To leave a conference

PT/PS

During a 3- to 7-party conference



Press **CONF**. On-hook.

To return while others are talking

PT/PS

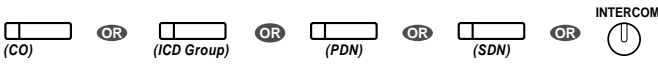

Press flashing green **CO**, **ICD Group**, **PDN**, **SDN**, or **INTERCOM**.

To complete a conversation

PT/PS

During a conversation



On-hook.



• **Time limit**

Both parties will hear an alarm tone before a specified timeout. The originating extension user will hear an alarm tone before timeout. The call is disconnected when the timer runs out unless the originating extension returns to the conference.



Customizing Your Phone

- 3.1.4 Customizing the Buttons
Create or edit a Conference button.

1.3.17 Data Line Security

You can protect the line against audible notification tones, such as a call waiting tone during a conversation. Set this feature if your extension has a data communication device, such as a PC or fax machine connected to ensure secure data transmission.

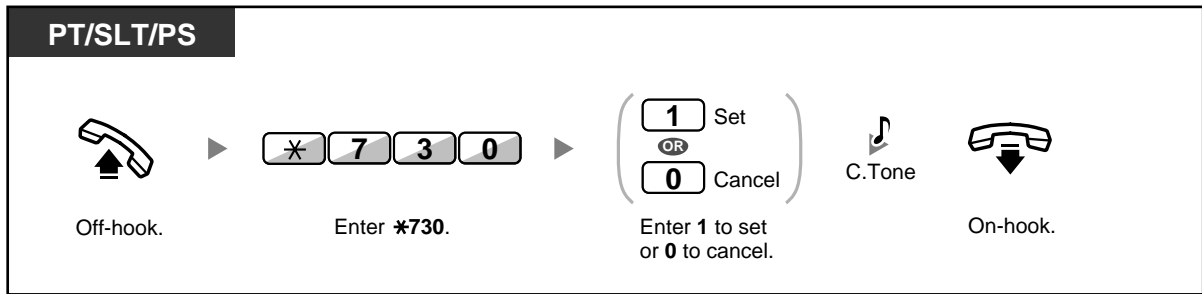
To set/cancel**1.3.18 DISA (Direct Inward System Access)**

- Calling through DISA

◆◆ **Calling through DISA**

When outside callers access extensions in the PBX, a prerecorded message greets the caller and gives information about how to access an extension. You do not need the operator's assistance.

You may be able to access system features or call an outside party with your password depending on the security mode.

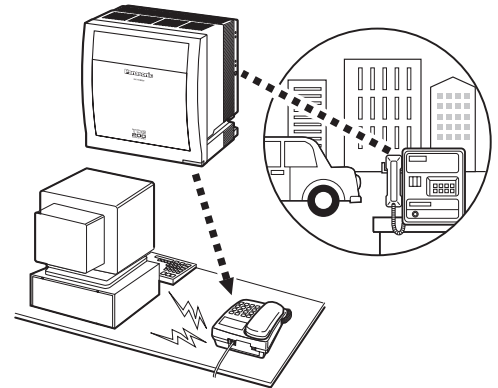

To call an extension

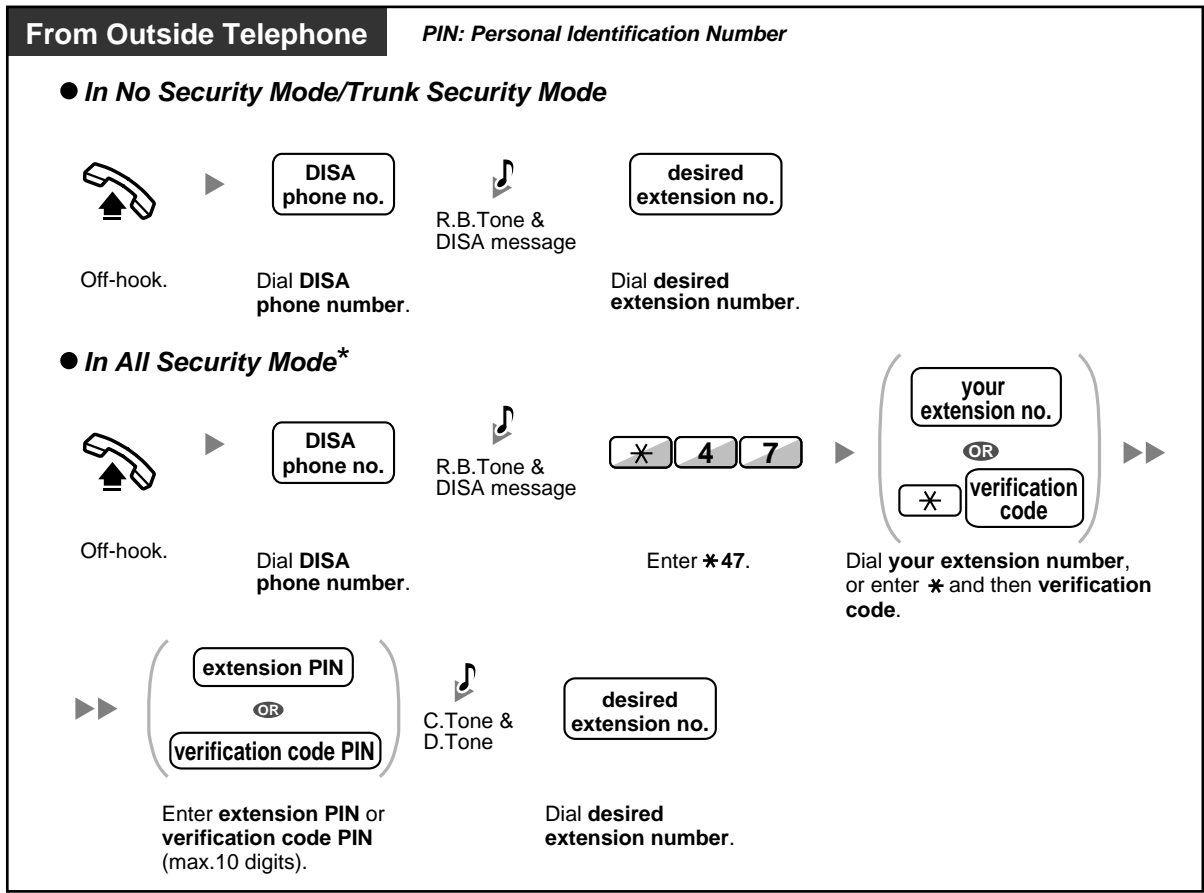

To call an outside party

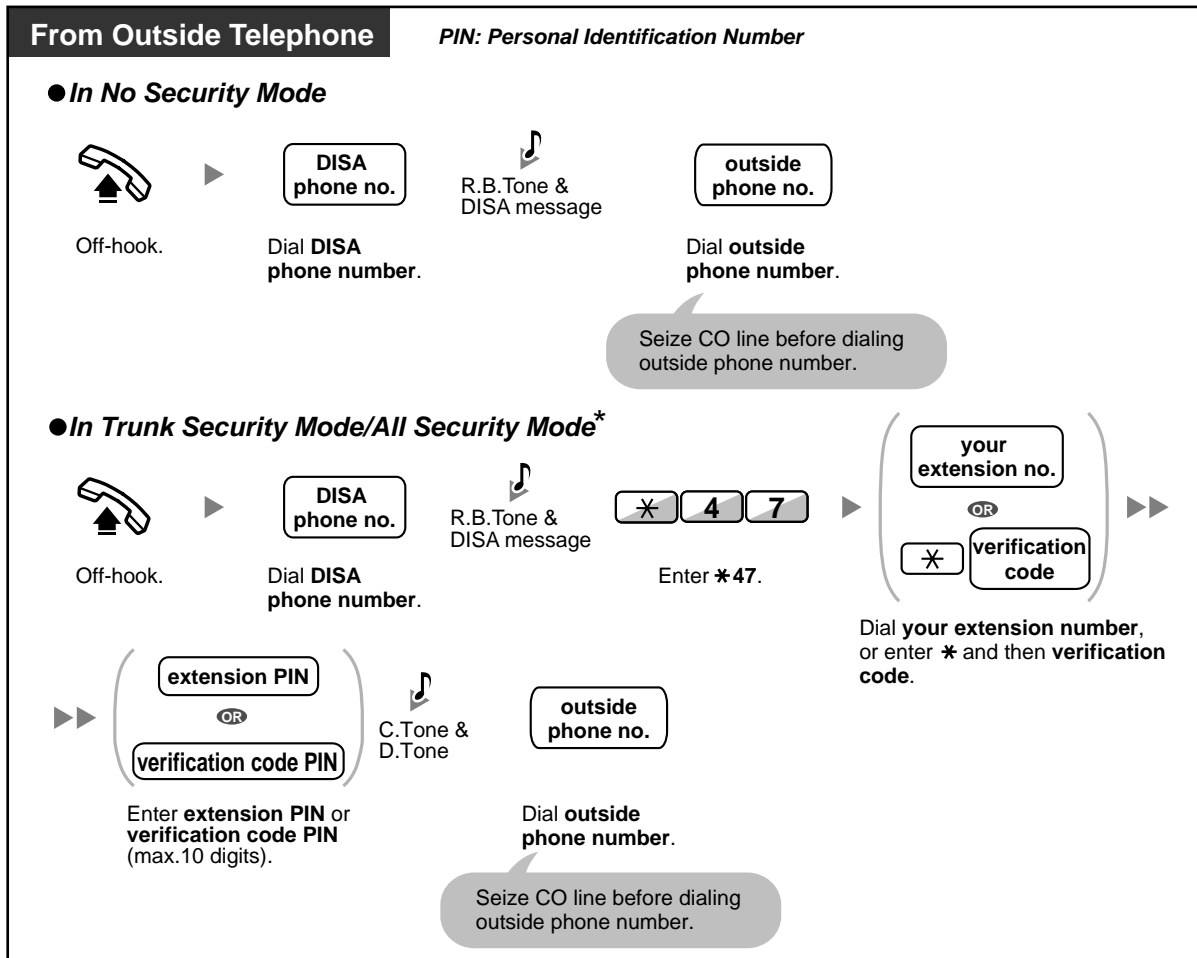

- * Callers from preprogrammed outside numbers can access the PBX through DISA without a password (extension PIN/verification code PIN) (**DISA Automatic Walking COS**).

To retry

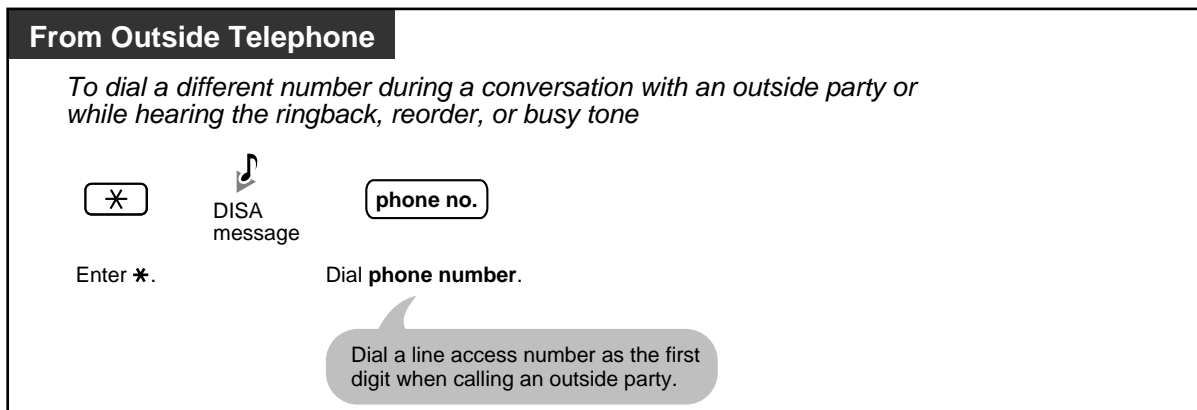



CAUTION

There is a risk that fraudulent telephone calls will be made using the CO-to-CO Line Call feature of DISA.

The cost of such calls will be billed to the owner/renter of the PBX.

To protect the PBX from this kind of fraudulent use, we strongly recommend:

- a. Enabling DISA security (CO Line Security or All Security).
 - b. Keeping your passwords (verification code PIN/extension PIN) secret.
 - c. Selecting complex, random PINs that cannot be easily guessed.
 - d. Changing PINs regularly.
- **Time Limit**
Both parties will hear an alarm tone fifteen seconds before the specified time limit. To extend, press any dial button except *.
 - **If Built-in Automated Attendant service is set**, you can access the desired extension simply by pressing a single digit (0–9) from the options given the prerecorded message.

1.3.19 DND (Do Not Disturb)

- DND (Do Not Disturb)
- DND Override
- Switching FWD/DND Status Using Fixed FWD/DND Button

◆◆ DND (Do Not Disturb)

You can set this feature to prevent incoming calls from ringing at your extension. This can be useful, for example, when you are in a meeting or busy.

To set/cancel

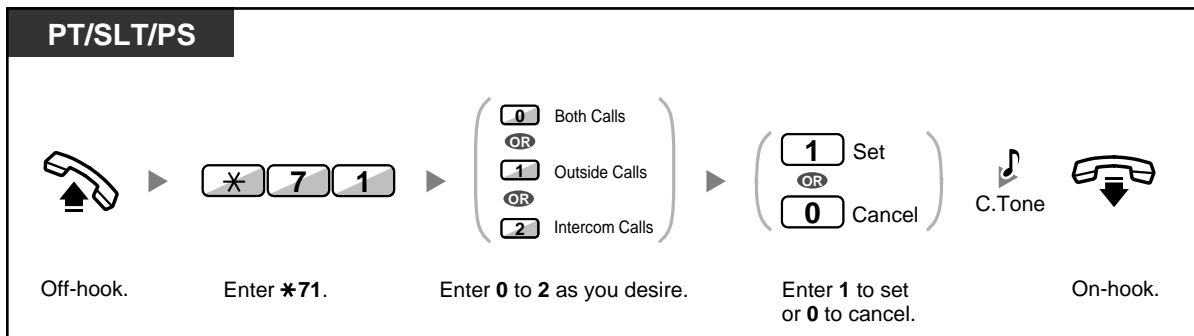

- When using a proprietary telephone, you can set or cancel DND by pressing the FWD/DND button (fixed button) instead of "*710"



- The FWD/DND button light shows the current status as follows:
 - Off:** Both features are not set.
 - Flashing red slowly:** FWD mode
 - Red on:** DND mode
- The system has two modes: (1) FWD/DND Cycle Switch Mode and (2) FWD/DND Setting Mode. Ask your manager what mode your system is in if you are not sure.

(1) When in FWD/DND Cycle Switch Mode:

Pressing the FWD/DND button (fixed button) while in idle status will cycle the setting as shown below:



(2) When in FWD/DND Setting Mode:

Pressing the FWD/DND button (fixed button) while in idle status allows you to switch the FWD/DND status and set the FWD destination (refer to "Switching FWD/DND Status Using Fixed FWD/DND Button").

Note

A FWD/DND button (customized button) is always in FWD/DND Cycle Switch Mode: the mode cannot be changed.

- If your extension has set this feature, a calling extension will hear DND tone.
- If this feature is set, the Call Forwarding (FWD) feature does not work.
- Specified extensions can override this feature and call DND extensions (DND Override).
- When using a SIP Extension, you cannot set/cancel the DND feature at your extension. However, this feature is available if set through system programming.
- When making a call using an SDN button to a PDN extension with DND set, this feature will temporarily be deactivated.
- When intercom calls are set to be handled differently from outside calls (DND set/cancel), we recommend establishing buttons for both FWD/DND—Outside calls and FWD/DND—Intercom calls, because:
 - the light patterns of the FWD/DND—Both calls button (including FWD/DND button [fixed button]) will indicate the setting for either outside calls or intercom calls, but not both.

Note

The DND icon on PS display reflects the setting for outside calls only.

- pressing the FWD/DND—Both calls button (including FWD/DND button [fixed button]) will not change the FWD or DND mode for intercom calls and outside calls separately.



Customizing Your Phone

- 3.1.4 Customizing the Buttons
 - Create or edit FWD/DND (Both calls, Outside calls, Intercom calls) buttons.

◆◆ DND Override

The preprogrammed extension can call someone who has set the DND feature.

To call

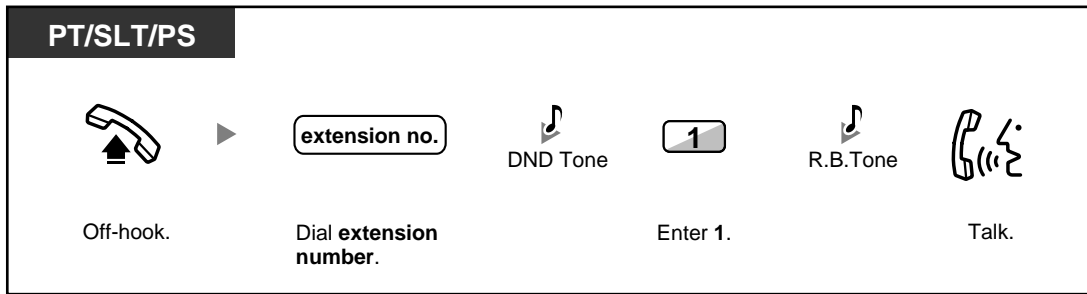

◆◆ **Switching FWD/DND Status Using Fixed FWD/DND Button**

Using a proprietary telephone (PT), you can easily switch the FWD/DND status for outside/intercom calls without clearing any FWD destination that was set previously.



To switch the FWD/DND status for outside calls

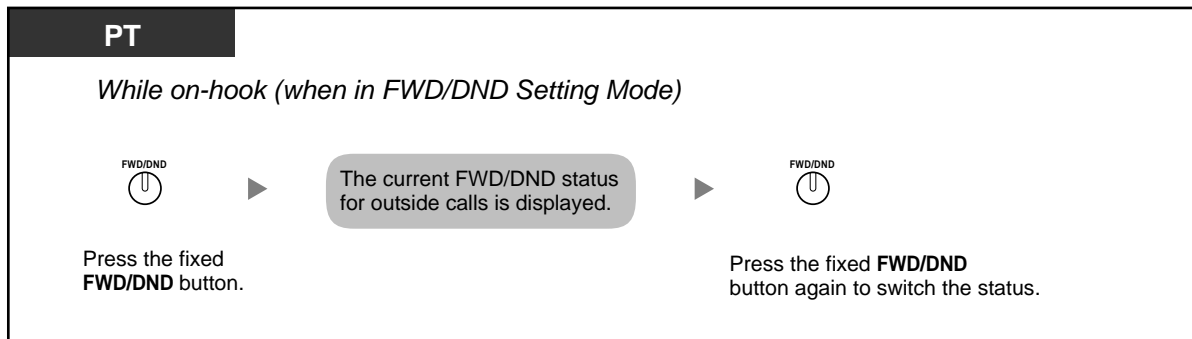

To switch the FWD/DND status for intercom calls

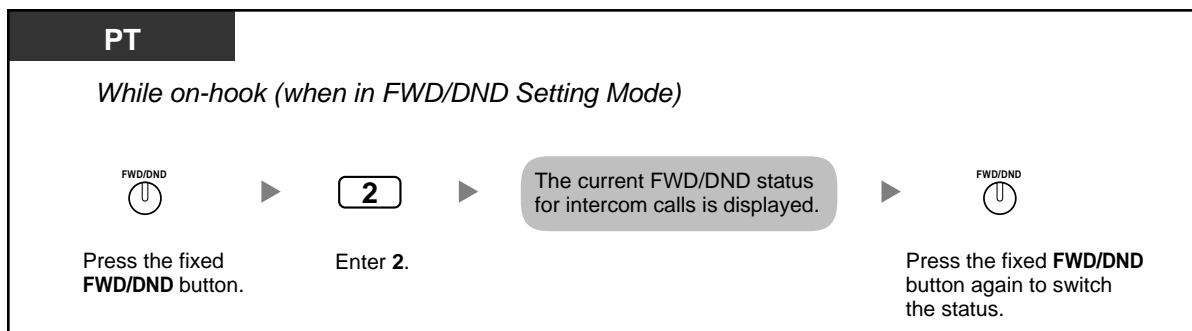

To set and clear FWD/DND for outside/intercom calls

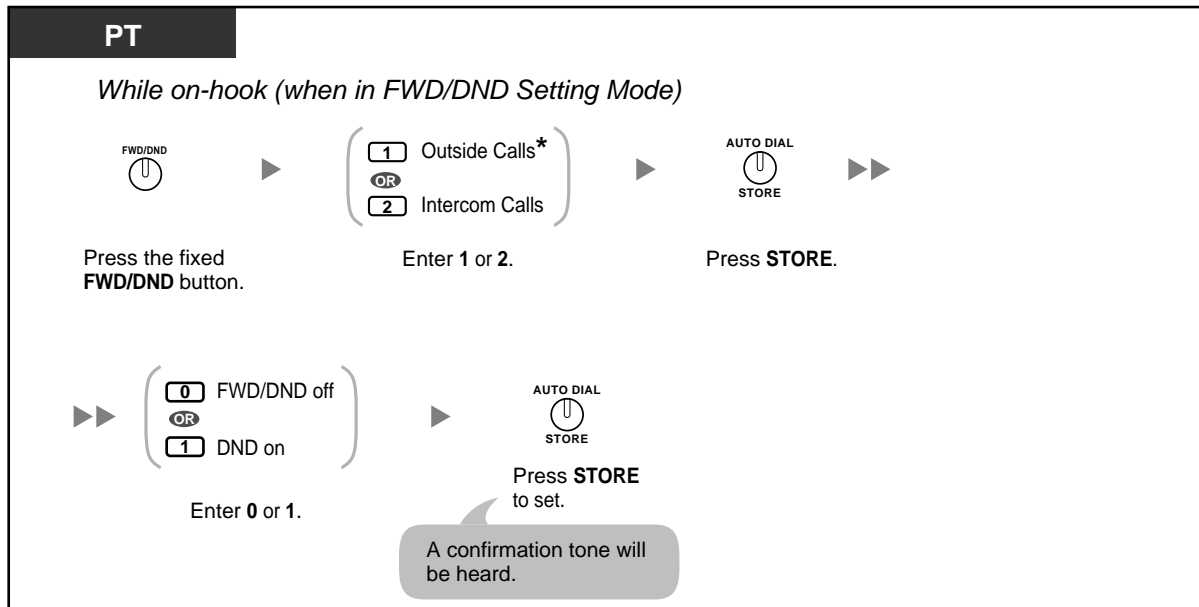

- * This step can be omitted.

1.3.20 Door Open

A preprogrammed extension can open a door from the extension.

From a preprogrammed extension

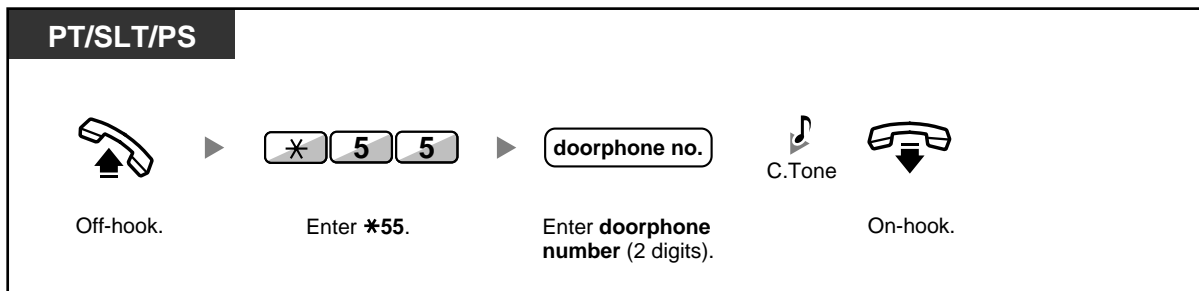

From any extension while talking to the doorphone

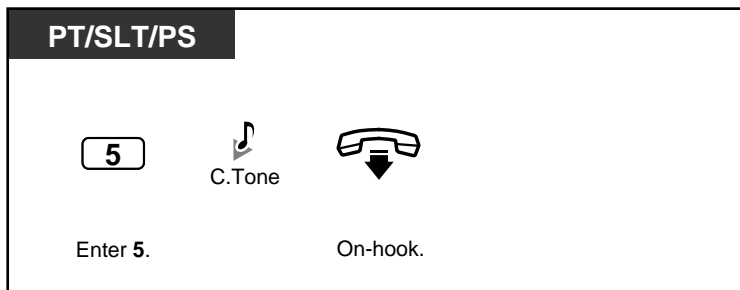



- The door open will be triggered for a specified time period.

1.3.21 Doorphone Call

Preprogrammed extensions or an outside party can receive a call from a doorphone, and talk to the person through the doorphone.

To call from the doorphone

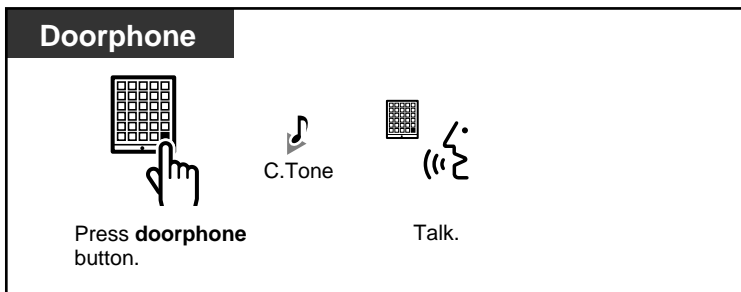

To answer a call from the doorphone

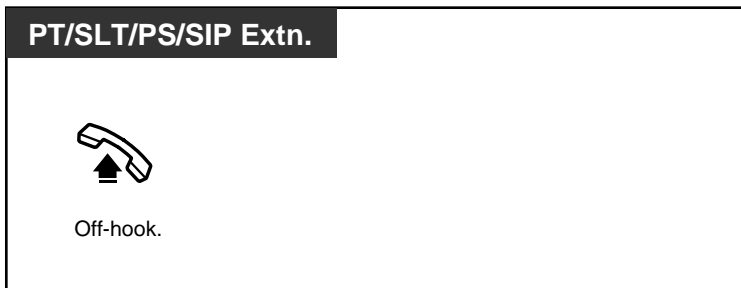

To call the doorphone

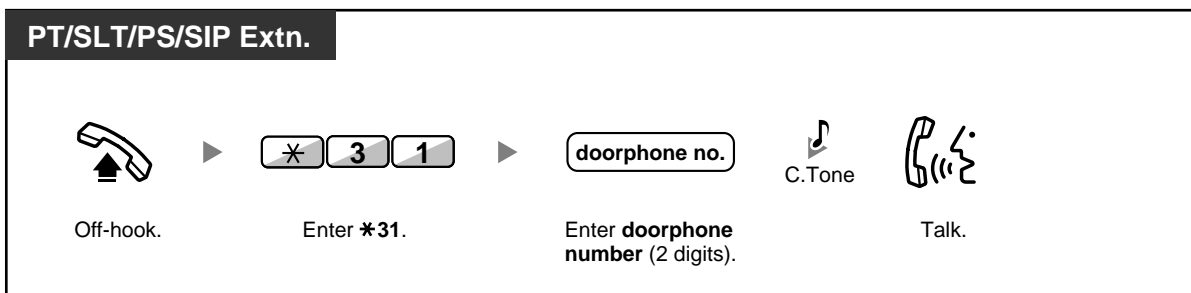

- If no one answers a doorphone call within a specified time period, the call is canceled.

1.3.22 EFA (External Feature Access)

You can access special features (e.g., Call Waiting offered by a host PBX or telephone company). This feature is only effective for an outside call.

<Example> To hold the current call and then talk to the new party

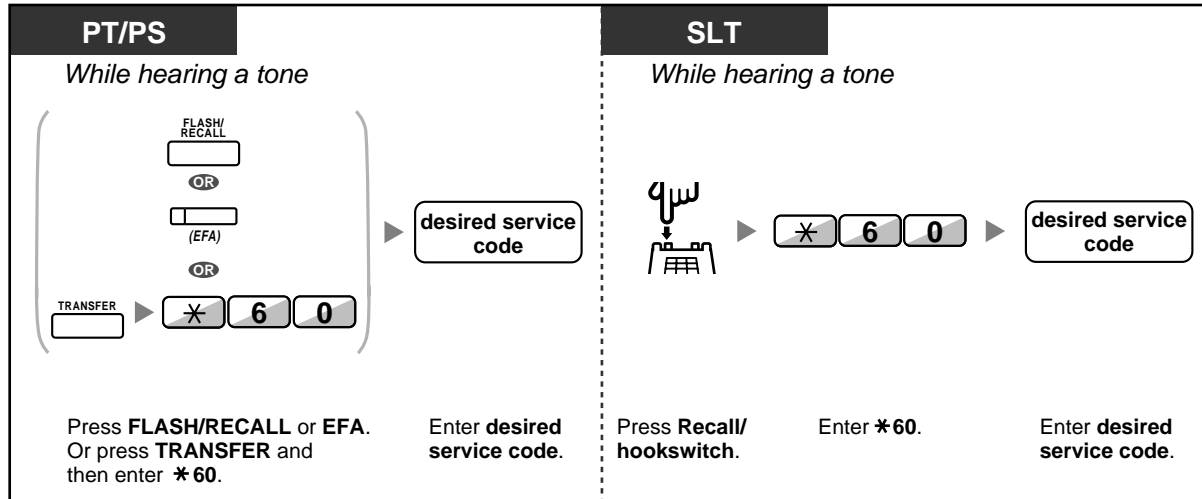

- In this case, the FLASH/RECALL button on a proprietary telephone must be set to External Feature Access (EFA) mode through system programming.



Customizing Your Phone

- 3.1.4 Customizing the Buttons
Create or edit an External Feature Access (EFA) button.

1.3.23 Executive Busy Override

- ◆◆ Executive Busy Override
- ◆◆ Executive Busy Override Deny

◆◆ Executive Busy Override

A preprogrammed extension can call someone who is busy on the telephone and establish a three-party conversation.

To join an intercom call

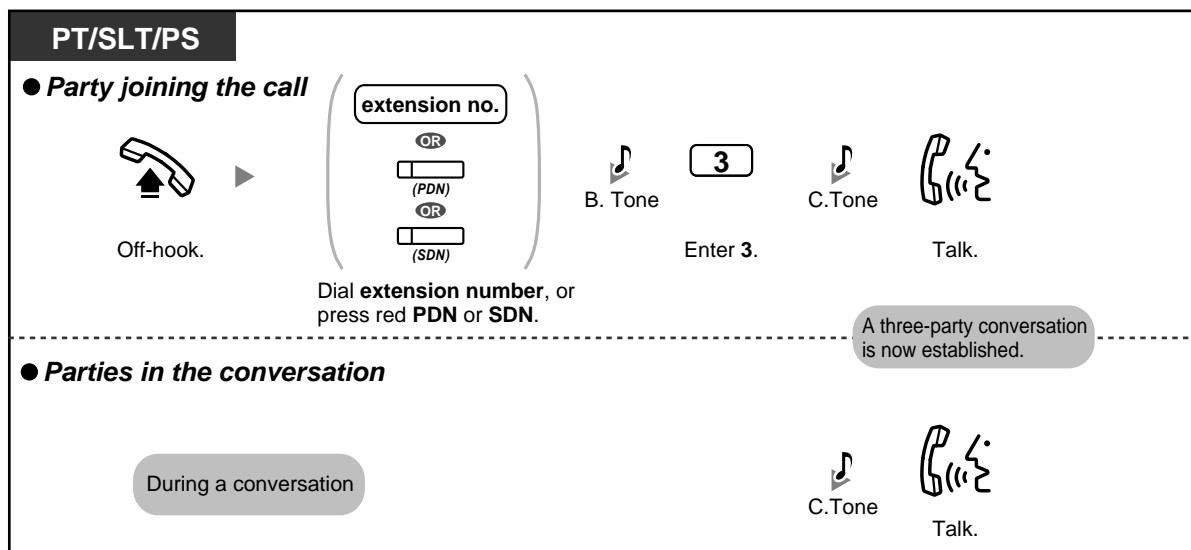

To join an outside call

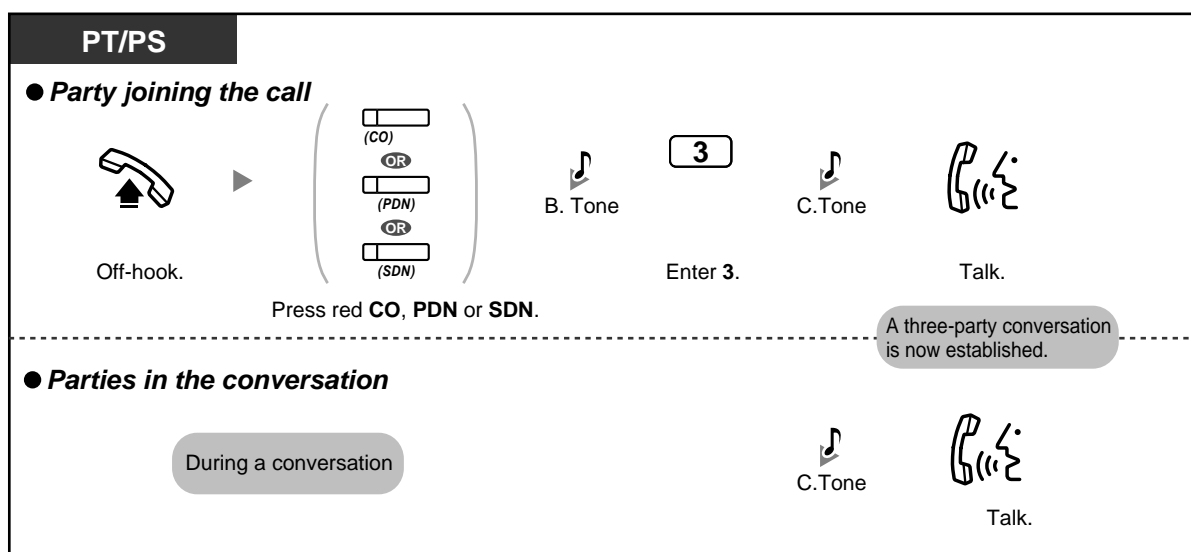

- To join another conversation, you must have Executive Busy Override enabled at your extension through COS programming.
- It is possible for an originating extension to leave a three-party conversation with an outside party and let the two other parties talk by simply going on-hook.
- Executive Busy Override is not available when making a call to a SIP Extension.

◆ For the originating extension

To talk to each party alternately

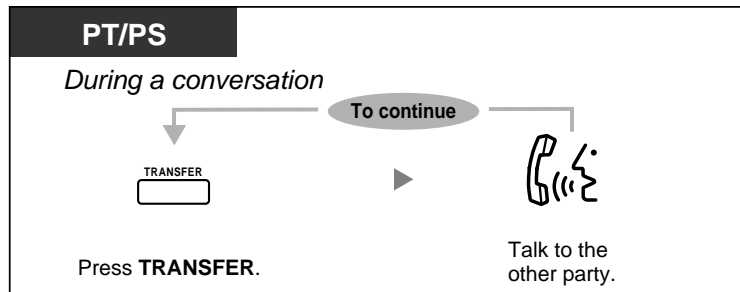

◆◆ Executive Busy Override Deny

A preprogrammed extension user can prevent his calls from being interrupted by another extension user (Default: Allow other users to interrupt calls).

To set

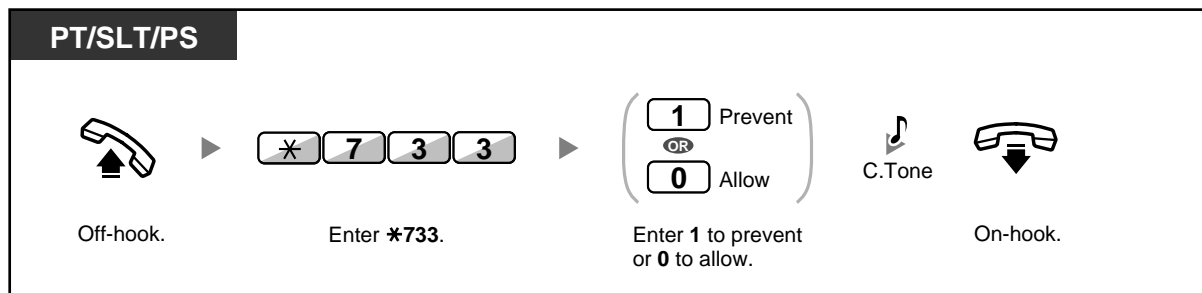

1.3.24 Extension Dial Lock

You can lock your extension so that other users cannot make unauthorized outside calls. This feature is also known as Electronic Station Lockout.

To lock

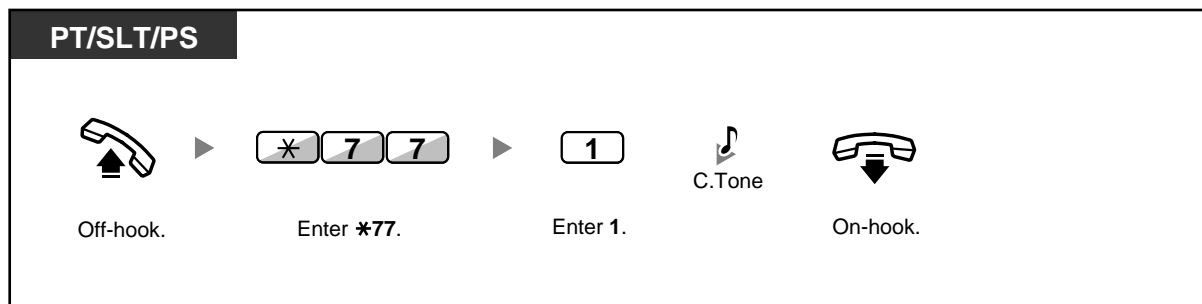

To unlock

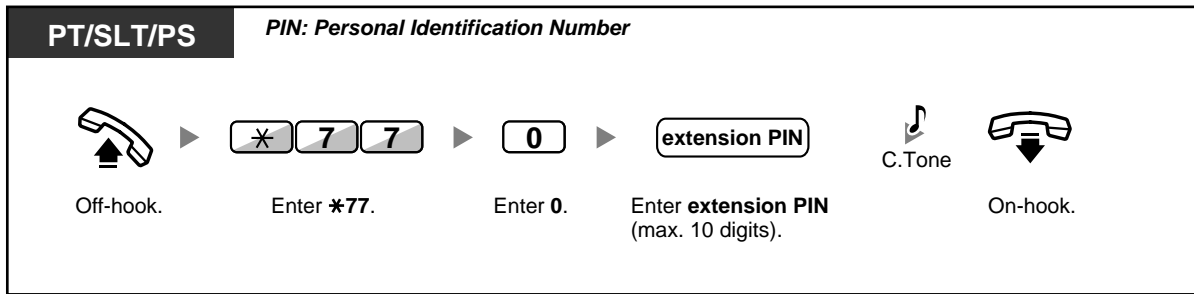

- **If you forget the extension PIN or cannot unlock your extension**, consult your manager. The manager can clear your extension PIN, or unlock your extension. Then, you can set the new PIN and unlock your extension by entering it.
- If your extension is locked by this feature, it cannot perform the following operations:
 - Making outside calls
 - Changing the call forwarding destination
- If you do not set extension PIN, you cannot lock and unlock your extension.

To make an outside call while your extension is locked

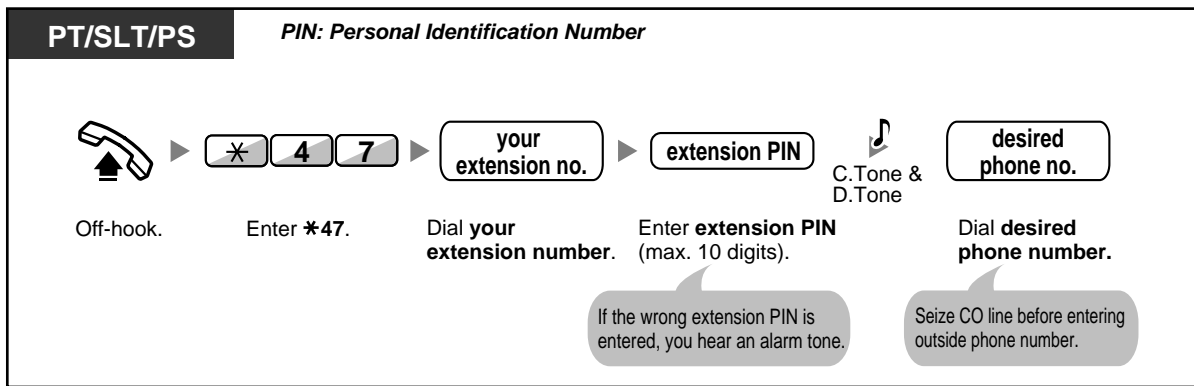

- After you make an outside call, Extension Dial Lock is automatically activated again.

1.3.25 Extension Feature Clear

You can reset the settings of the following features on your extension to the default settings with one operation. This feature is also known as Station Program Clear.

Features	Default Setting
Hot Line ^{*1}	Off
Message Waiting—(All the messages that have been left by other extension users)	Off
Call Pickup Deny	Allow
Call Forwarding (FWD) ^{*1}	Off
Absent Message	Off

Features	Default Setting
Paging Deny	Allow
Timed Reminder	Cleared
Do Not Disturb (DND) ^{*1}	Off
Call Waiting ^{*1}	Enable—Tone
Executive Busy Override	Allow
BGM	Off
Data Line Security	Off
Paralleled Telephone	The telephone in parallel rings.
Log-in/Log-out	Log-in

^{*1} These features may not be reset, depending on system programming.

To reset

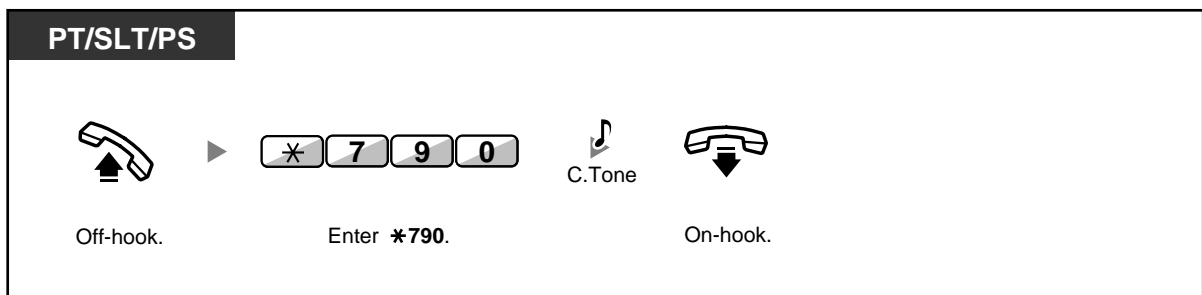

- After performing Extension Feature Clear, the setting of Call Waiting becomes "Enable—Tone". In this case, dial tone 2 will be heard when you go off-hook.

1.3.26 Extension PIN (Personal Identification Number)

You can assign a password to each extension.

The following features require an extension PIN.

1. Screening calls (1.3.70 Voice Mail Features—LCS (Live Call Screening))
2. Prohibiting other people from seeing your personal speed dialing directory, call log, and SVM log (Display Lock)
3. Using the same settings as your extension at other extensions (1.3.75 Walking Extension)
4. Remote Control Operation (1.3.74 Walking COS)
5. Extension Dial Lock Clear

To set

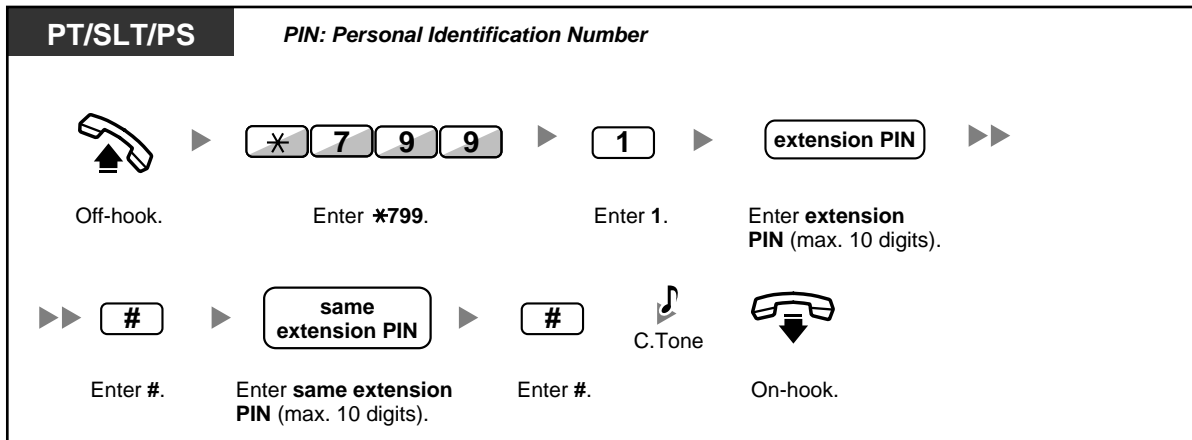

To cancel

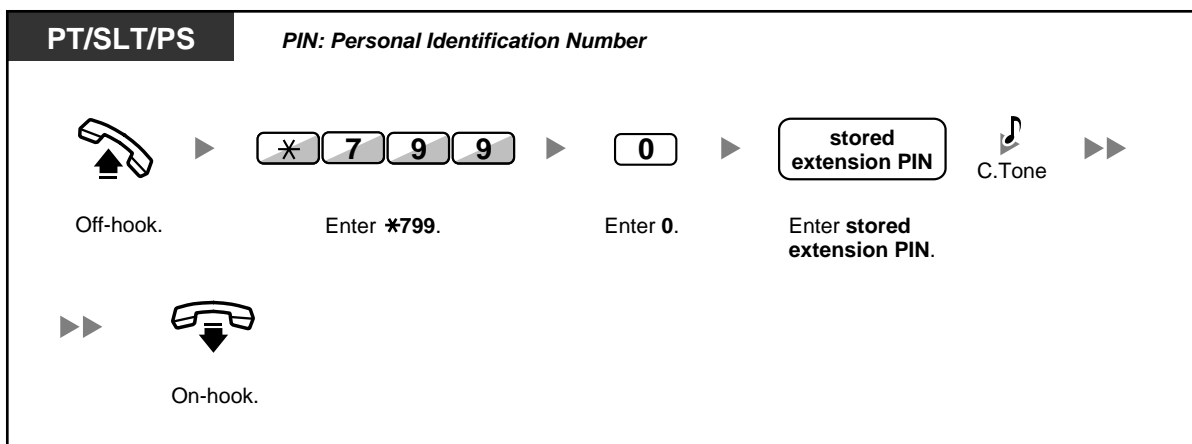
**CAUTION**

There is a risk that fraudulent telephone calls will be made if a third party discovers your password (extension PIN).

The cost of such calls will be billed to the owner/renter of the PBX.

To protect the PBX from this kind of fraudulent use, we strongly recommend:

- a. Keeping your PIN secret.
 - b. Selecting a complex, random PIN that cannot be easily guessed.
 - c. Changing your PIN regularly.
- Valid numbers for an extension PIN are "0" through "9".
 - If the wrong extension PIN is entered for a preprogrammed number of times, the PIN is locked.
 - If you forget your extension PIN or your extension PIN is locked, your manager can clear the extension PIN and extension PIN lock.

1.3.27 External Relay

Preprogrammed extensions can switch on a relay (e.g., alarm) connected to the PBX.

To switch on the relay

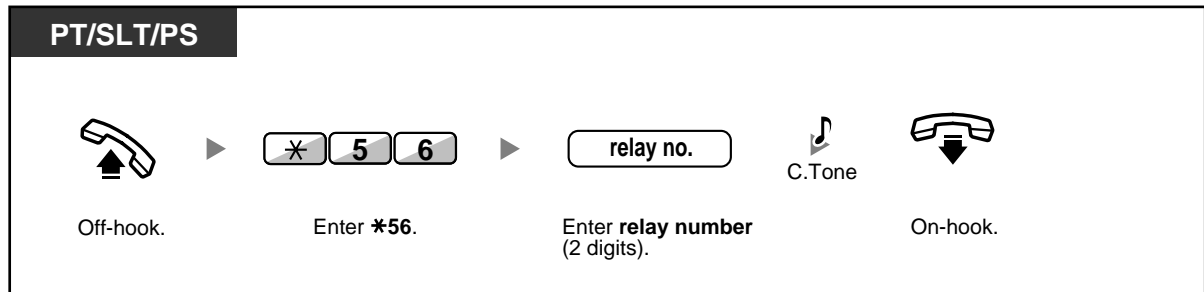

- The relay will be switched off after a specified time period.

1.3.28 External Sensor

Preprogrammed extensions can receive an alert call from an external sensor (e.g., security alarm) connected to the PBX.

To answer a sensor call

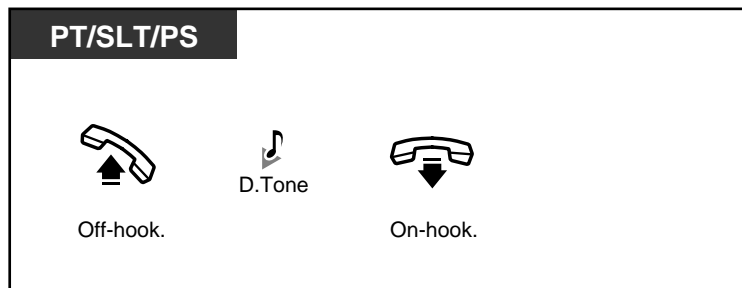

- If you do not answer a sensor call within a specified time period, the sensor call will stop.

1.3.29 FWD (Call Forwarding)

- ◆◆ FWD (Call Forwarding)
- ◆◆ FWD/DND Settings Using Fixed FWD/DND Button

◆◆ FWD (Call Forwarding)

You can have your incoming calls forwarded to a specified destination.

All Calls:

All calls are forwarded. Preset extensions may also forward from their own receiving group.

Busy:

All calls are forwarded when your extension is busy.

No Answer:

All calls are forwarded when you do not answer the call within a specified time period.

Busy/No Answer (BSY/NA):

All calls are forwarded when you do not answer within a specified time period or when your extension is busy.

Follow Me (From):

If you fail to set the above-mentioned "All Calls" to forward before you leave your desk, you can set the same feature from the destination extension.

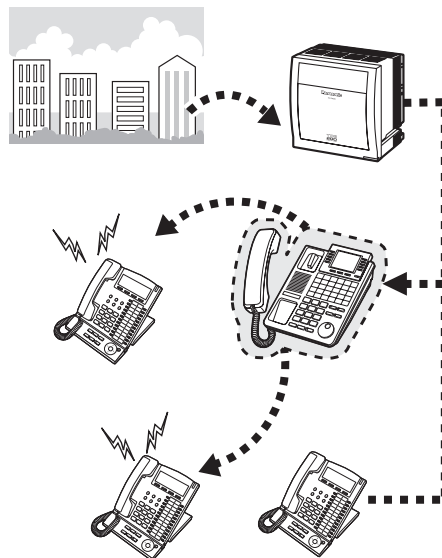

- Incoming calls can be forwarded up to four times.
- When using a SIP Extension, you cannot set/cancel the FWD feature at your extension. However, this feature is available if a forward destination is set through system programming.



- You can set the floating extension number of a voice mail group or the ESVM card as a forward destination.
- You can set your cellular phone as the forward destination.
- **Boss & Secretary feature**
The extension which has been set as the destination can call the forwarding extension.

<Example>

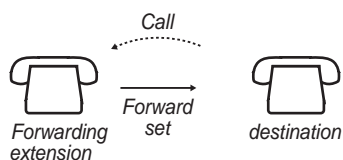

To set/cancel

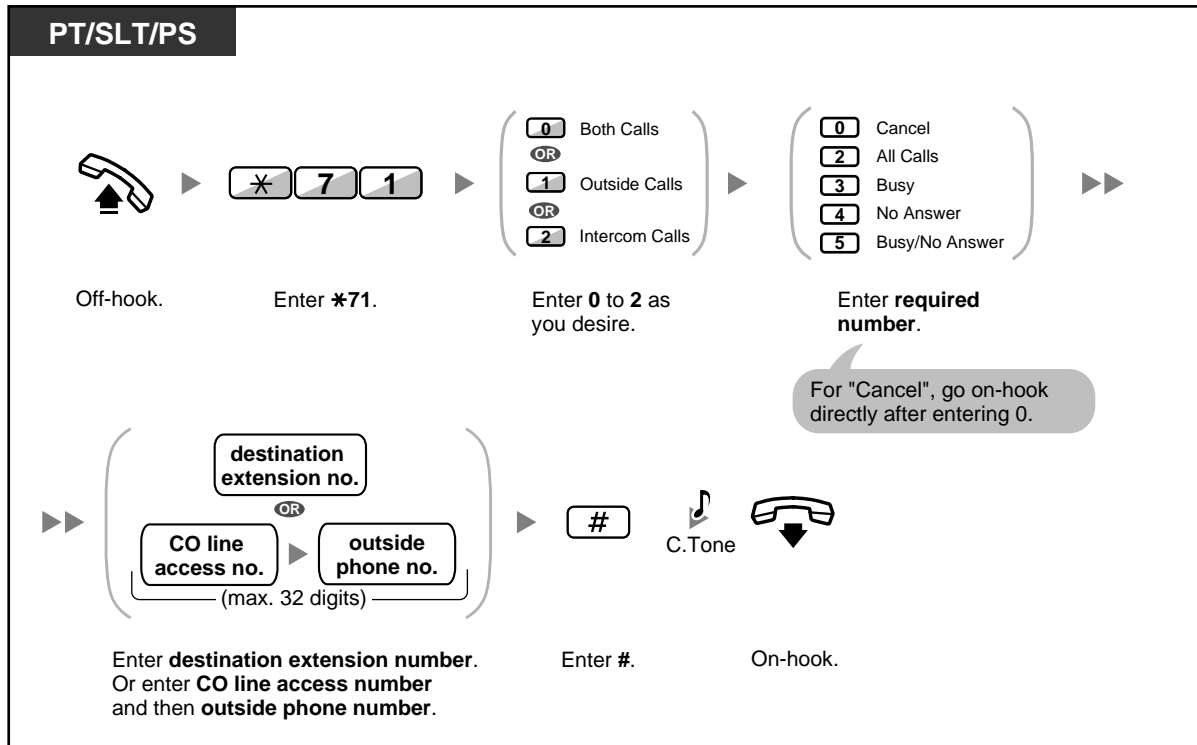

To set Follow Me from another extension

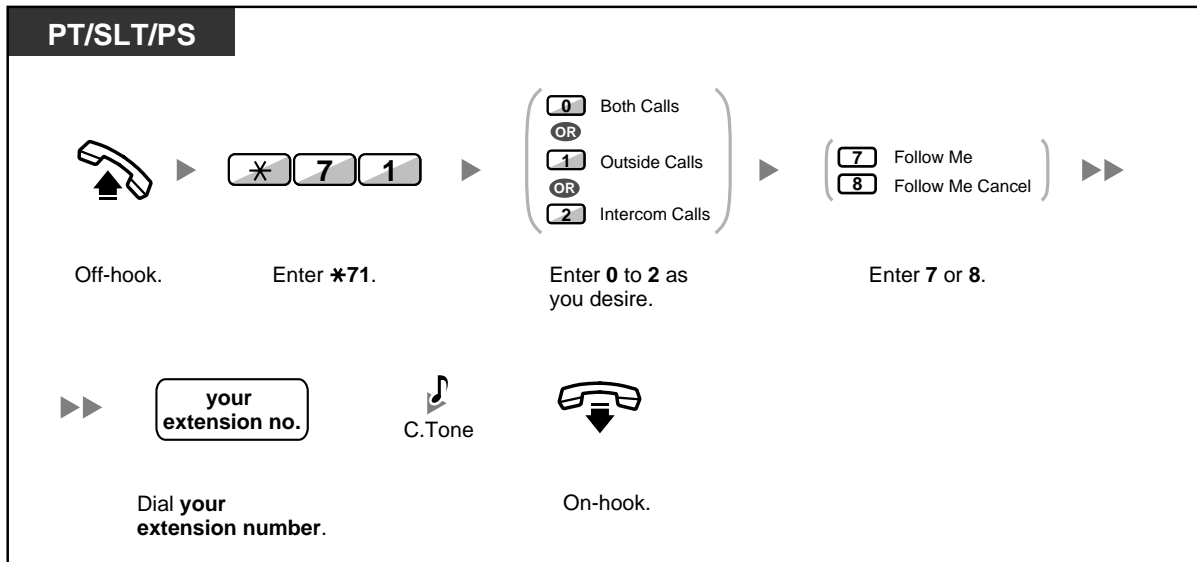

- It is not possible to set Follow Me from a SIP Extension. However, it is possible to set it on a SIP Extension from another extension that is not a SIP Extension.



- When using a proprietary telephone, you can set or cancel Call Forwarding by pressing the FWD/DND button (fixed button) instead of "*710".

To set the timer for "No Answer" and "Busy/No Answer"

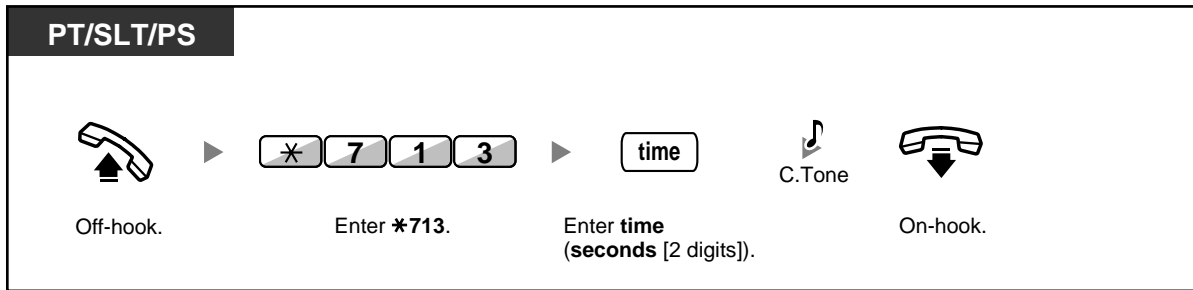

Call Forwarding (FWD) for your Incoming Call Distribution Group

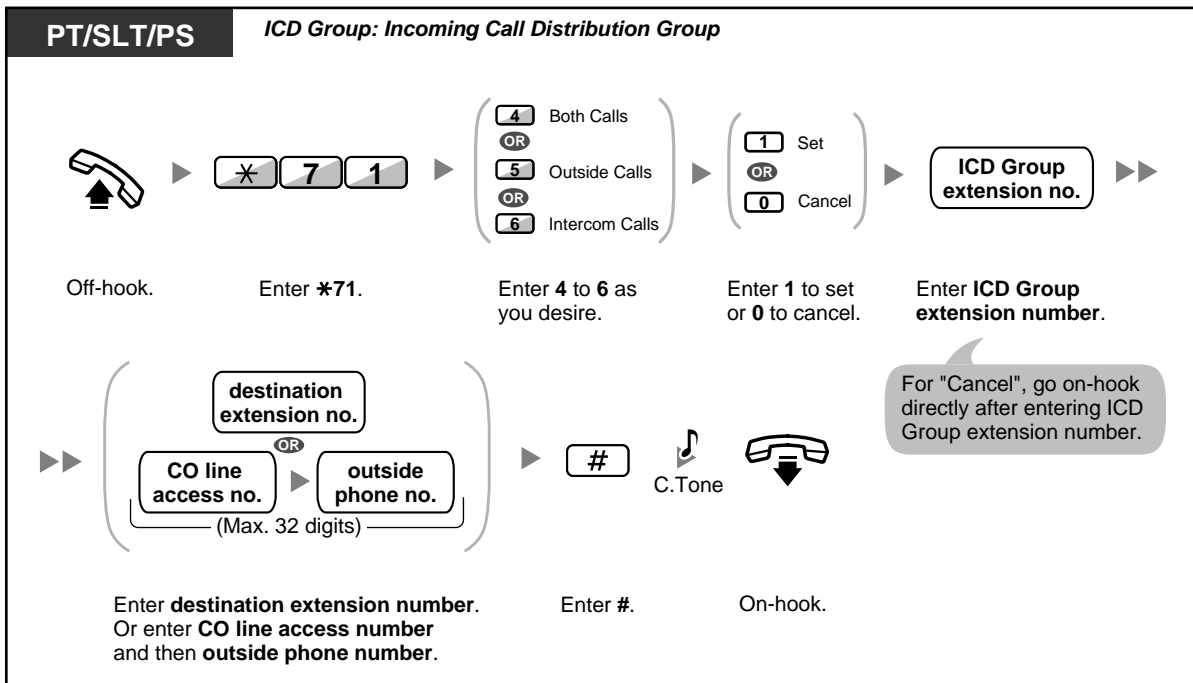



- The FWD/DND button light shows the current status as follows:
 - Off:** Both features are not set.
 - Flashing red slowly:** FWD mode
 - Red on:** DND mode
- The Group FWD button light shows the current status as follows:
 - Off:** No set
 - Flashing red slowly:** FWD mode
- The system has two modes: (1) FWD/DND Cycle Switch Mode and (2) FWD/DND Setting Mode. Ask your manager what mode your system is in if you are not sure.

(1) When in FWD/DND Cycle Switch Mode:

Pressing the FWD/DND button (fixed button) while in idle status will cycle the setting as shown below:



(2) When in FWD/DND Setting Mode:

Pressing the FWD/DND button (fixed button) while in idle status allows you to switch the FWD/DND status and set the FWD destination (refer to "◆◆ FWD/DND Settings Using Fixed FWD/DND Button").

Note

A FWD/DND button (customized button) is always in FWD/DND Cycle Switch Mode: the mode cannot be changed.

- Transferred outside calls are also forwarded to the destination assigned for outside calls.
- When intercom calls are set to be handled differently from outside calls (forwarding type, forward destination), we recommend establishing buttons for both FWD/DND—Outside calls and FWD/DND—Intercom calls, and/or Group FWD—Outside calls and Group FWD—Intercom calls, because:
 - the light patterns of the FWD/DND—Both calls button (including FWD/DND button [fixed button]) and the Group FWD—Both calls button will indicate the setting for either outside calls or intercom calls, but not both.

Note

The FWD icon on PS display reflects the setting for outside calls only.

- pressing the FWD/DND—Both calls button (including FWD/DND button [fixed button]) or the Group FWD—Both calls button will not change the FWD or DND mode for intercom calls and outside calls separately.



Customizing Your Phone

- 3.1.4 Customizing the Buttons
 - Create or edit FWD/DND (Both calls, Outside calls, Intercom calls) buttons, or Group FWD (Both calls, Outside calls, Intercom calls) buttons.

◆◆ FWD/DND Settings Using Fixed FWD/DND Button

Using a proprietary telephone (PT), you can easily switch the FWD/DND status, and set the forward destination for outside/intercom calls with the FWD/DND button (fixed button). It is also possible to set outside telephone numbers (e.g., your cellular phone) as forward destinations for up to 4 Virtual PSs* in an Incoming Call Distribution (ICD) group, to ring together with other ICD group members for calls to the group.



The following settings are available:

- Switching the FWD/DND status and setting FWD destination for outside/intercom calls
- Timer for "No Answer" and "Busy/No Answer"
- Forwarding status (on/off) and outside destinations to ring in parallel for outside calls for up to 4 virtual PSs in an ICD group

* Virtual PS

A virtual PS is a dedicated extension number assigned to a non-existent portable station (PS) to allow access to outside destinations such as a cellular phone.

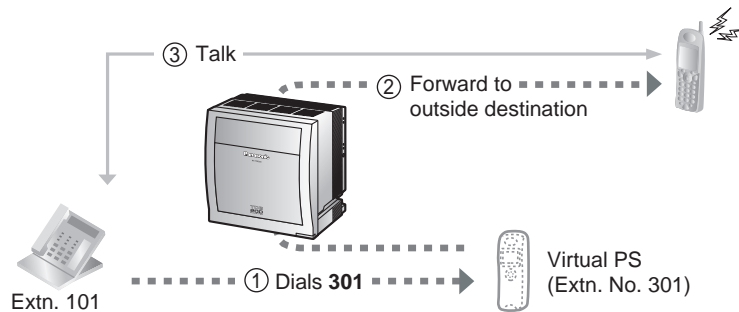

To switch FWD/DND status for outside calls

PT

While on-hook (when in FWD/DND Setting Mode)

Press the fixed FWD/DND button.

The current FWD/DND status for outside calls is displayed.

Press the fixed FWD/DND button again to switch the status.

To switch FWD/DND status for intercom calls

PT

While on-hook (when in FWD/DND Setting Mode)

Press the fixed FWD/DND button.

2

Enter 2.

The current FWD/DND status for intercom calls is displayed.

Press the fixed FWD/DND button again to switch the status.



- When you switch the FWD/DND status, any FWD destination that was set previously is not cleared.

To set and clear FWD/DND for outside/intercom calls

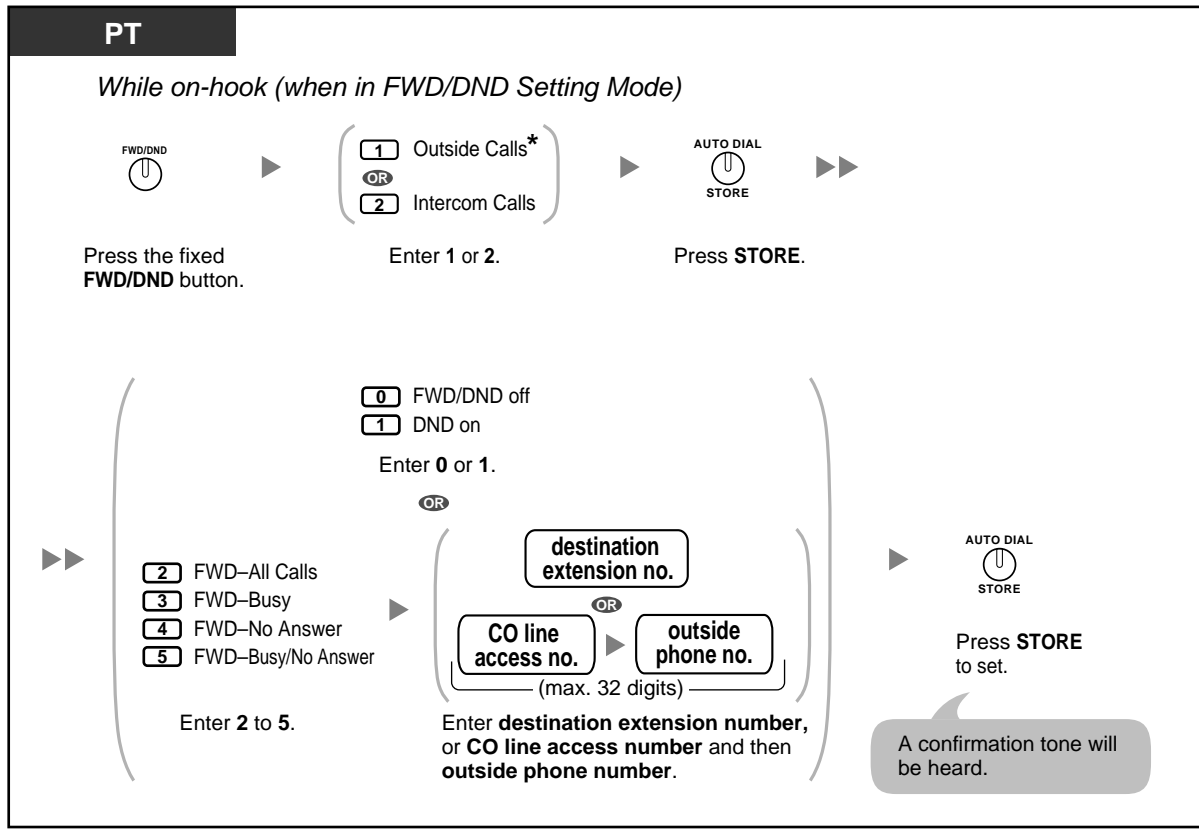

- * This step can be omitted.

To set the timer for "No Answer" and "Busy/No Answer"

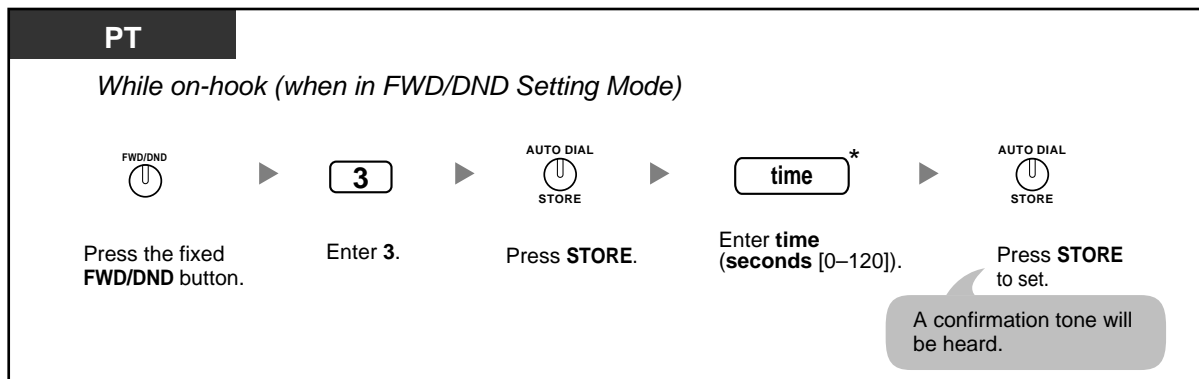

- * You can enter the time as a 1-3 digit number. For example, 15 seconds can be entered as "15" or "015".

To set forwarding status and outside destinations to ring in parallel for outside calls to an ICD group

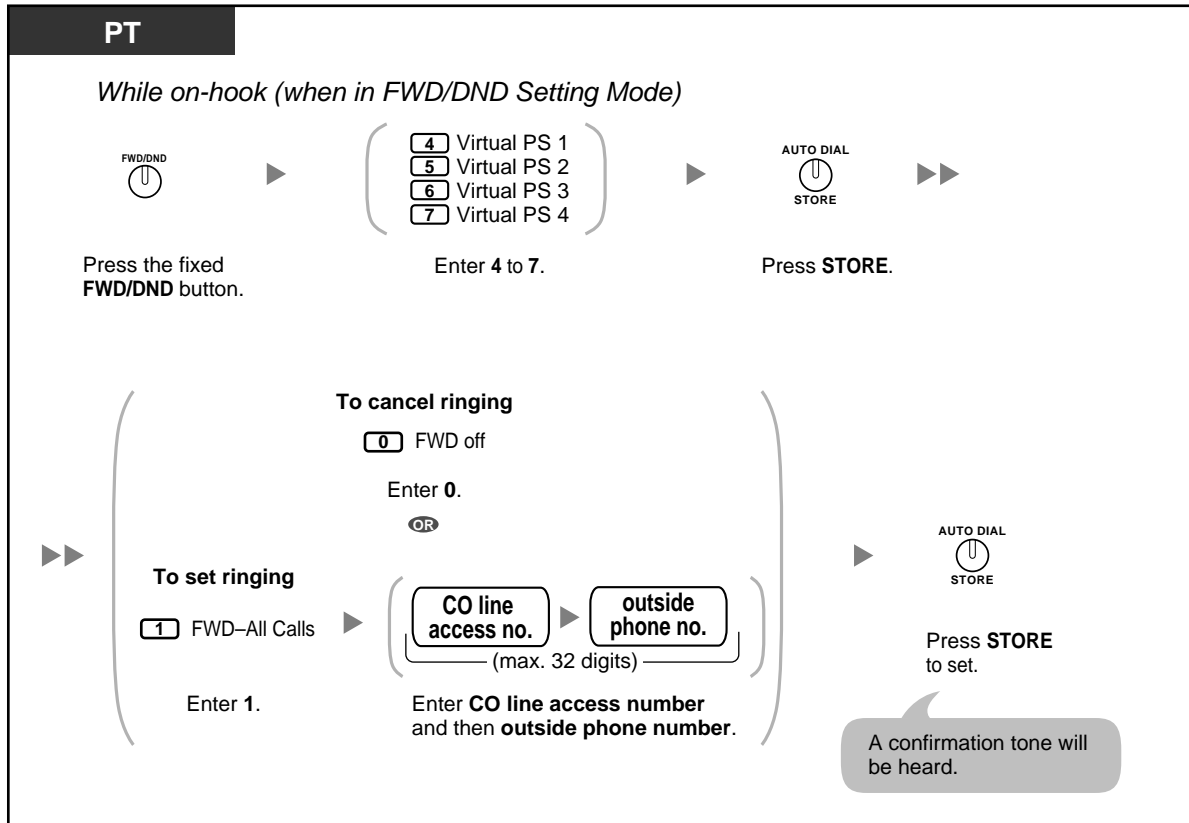

- Only one extension assigned as member 1 in each ICD group can perform the settings for virtual PSs.
- It is possible to switch the forwarding status (on/off) of a virtual PS by entering the number (4–7) of that extension, then pressing the fixed FWD/DND button, instead of pressing the AUTO DIAL/STORE button.

1.3.30 Hands-free Answerback

You can answer an incoming call without going off-hook as soon as the line is connected. When an intercom call arrives, you will hear the caller talking without the phone ringing. When an outside call arrives, you will hear the caller talking after a preprogrammed number of rings. Hands-free Answerback for outside calls requires System Programming.

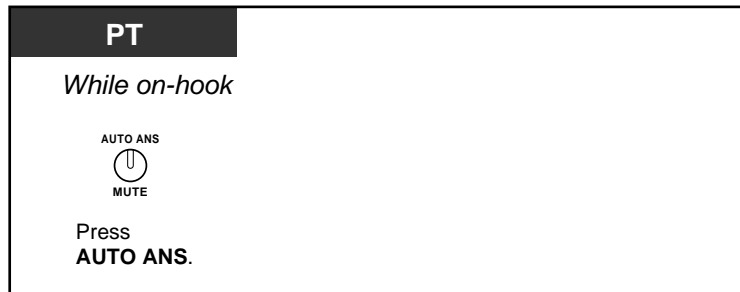

To set/cancel

- The AUTO ANS button light shows the current status as follows:
Off: Not set
Red on: Set
- PS users: Refer to "Operating Instructions" for PS.

1.3.31 Hands-free Operation

You can have a conversation in hands-free mode using the SP-PHONE button.

**To make/answer a call**

- When performing hands-free operation:
 - **If it is difficult to hear the other party's voice,**
Increase the volume using the Navigator Key, Jog Dial, or Volume Key.
 - **If the other party has difficulty hearing you,**
Decrease the volume.
 - **If the other party reports that your voice echoes,**
Use the telephone in a room that has curtains, carpeting or both.
 - **If parts of the conversation cannot be heard,**
If you and the other party speak at the same time, parts of your conversation may be lost. To avoid this, try to speak alternately.

1.3.32 Headset Operation

- ◆◆ Headset Operation

- ◆◆ Answer/Release Button

◆◆ Headset Operation

You can have a conversation using a headset.

In this case, you must select "Headset on" in programming mode or set the Headset button on (red) in advance.

This feature is also known as Handset/Headset Selection.



To talk using the headset



To use the handset during a conversation using the headset



To talk in hands-free mode during a conversation using the headset



- The Headset button light shows the current status as follows:
Off: Headset mode off
Red on: Headset mode on



- **For KX-NT300 series (except KX-NT321)/KX-DT343/KX-DT346 telephone users:**
 - With the KX-NT300 series (except KX-NT321)/KX-DT343/KX-DT346 telephones, you can use a Bluetooth wireless headset registered on your extension as a headset.
 - **Operating Distance**
Please keep the telephones with connected Bluetooth Modules, 3 m (9 ft 10 in) or more apart from each other. Also, if a Bluetooth headset is in use near a telephone with a connected Bluetooth Module, other than the one it is registered to, noise may be heard. Move away from the telephone and closer to the one it is registered to, to improve the signal.
 - **Noise**
Signals are transmitted between this module and the Bluetooth headset using radio waves. For maximum distance and noise free operation, it is recommended that the module is situated away from electrical appliances such as faxes, radios, PCs, or microwaves.
 - Systems using the 2.4 GHz ISM (Industrial, Scientific and Medical) band may interfere with this product. Examples of such systems are cordless telephones, wireless LAN, Home RF, microwave ovens and other ISM devices. These systems may cause minor noise.



Customizing Your Phone

- 3.1.2 Personal Programming—◆◆ **Headset Operation**
Select the equipment to use.
- 3.1.4 Customizing the Buttons
Create or edit a Headset button.

◆◆ Answer/Release Button

Customized Answer and Release buttons can make using a headset much easier. You can answer incoming calls or disconnect the line with these buttons. Some DSS Consoles have fixed ANSWER and RELEASE buttons.



To answer



To transfer a call

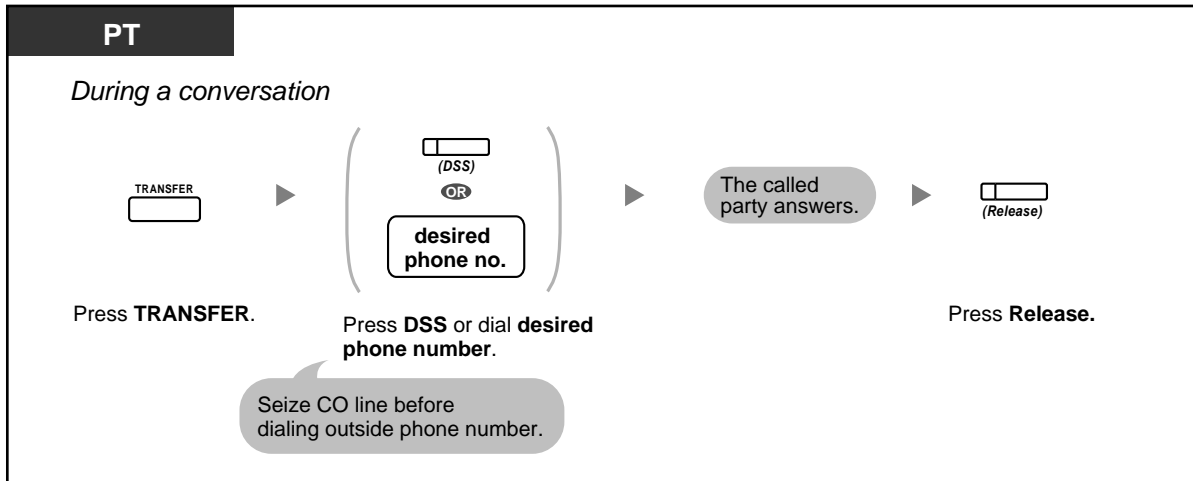

To talk to a waiting caller

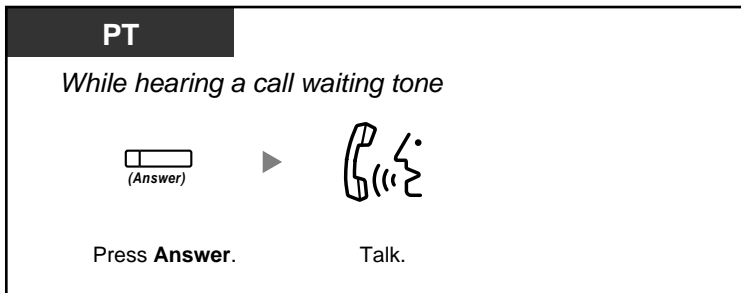

To transfer an outside call to an extension with a one-touch operation

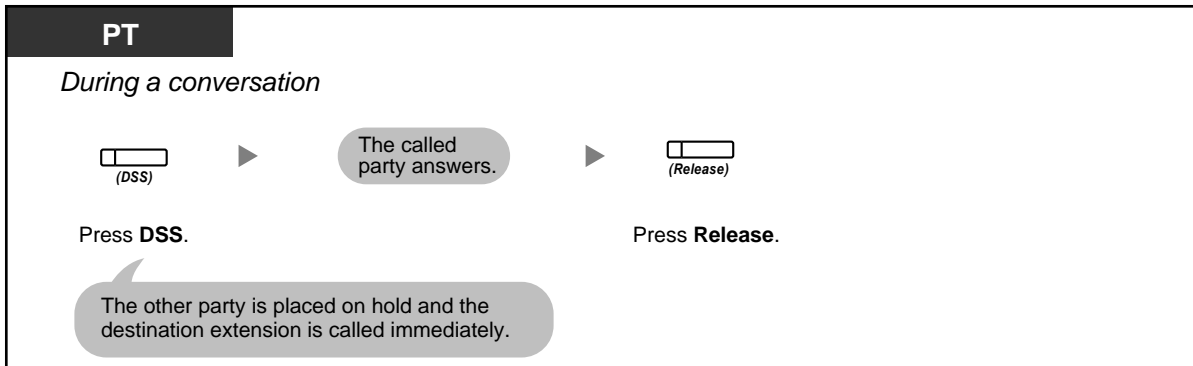

To end a conversation

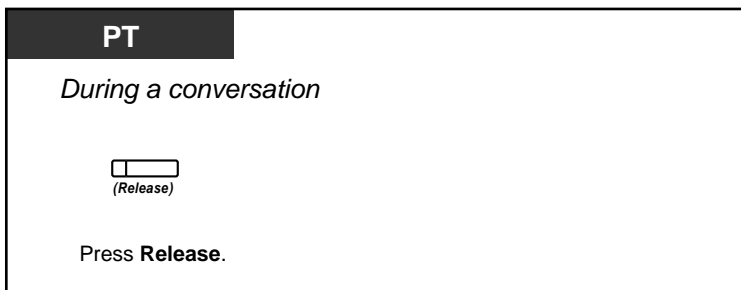



Customizing Your Phone

- 3.1.4 Customizing the Buttons
Create or edit an Answer button or a Release button.

1.3.33 HOSPITALITY FEATURES

In a hotel-type environment, an extension assigned as a hotel operator can be used to view and set the check-in/check-out/cleaned-up (Ready or Not Ready)^{*1} status of each guest room extension. This allows the hotel operator to manage guests and rooms with just a telephone. In addition, the hotel operator can set timed reminders remotely for guest rooms.

Features	Description
Room Status Control	An extension assigned as a hotel operator can set the check-in/check-out/cleaned-up (Ready or Not Ready) status of rooms remotely. (→ 1.3.60 Room Status Control)
Remote Wake-up Call	A hotel operator can set a timed reminder for a room remotely. (→ 1.3.73 Wake-up Call)

*1 The Cleaned-up feature is only available for the KX-TDE600.

1.3.34 Hot Line

You can make an outside call simply by going off-hook if you have preprogrammed your phone. This feature is also known as Pickup Dialing.

To store a phone number

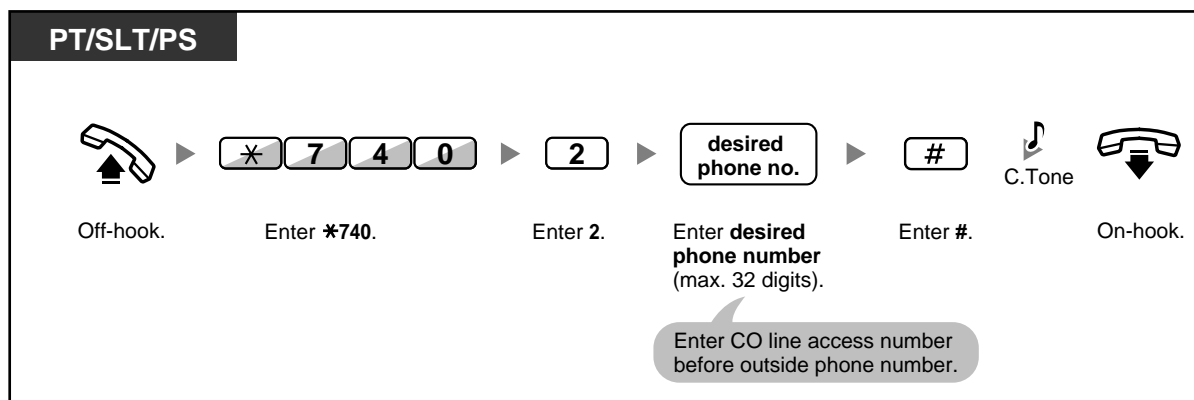

To set/cancel

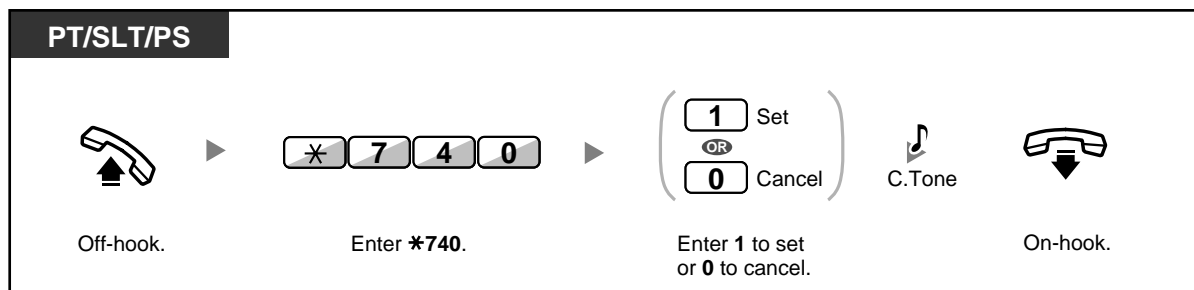

To dial



- **To call another party**, dial the desired party’s phone number before the preprogrammed number is dialed.
- You should assign the intercom line as the seized line when going off-hook. (Preferred Line Assignment—Outgoing)
- It is possible to increase the delay before Hot Line is activated through system programming. This can be useful if you require more time after going off-hook to dial another telephone number or extension number.



Customizing Your Phone

- 3.1.2 Personal Programming—**Preferred Line Assignment—Outgoing**
Select the seized line when going off-hook.

1.3.35 ICD GROUP FEATURES

An incoming call distribution (ICD) group is a group of extensions assigned through system programming to receive calls (for example, as a call center). The PBX has several features that support using extensions in ICD groups, as follows:

Features	Description
Log-in/Log-out	You can log in to or out of an ICD group, to control whether you receive calls from the group. (→ 1.3.38 ICD Group Features—Log-in/Log-out)
Supervisory Features	An extension assigned as a supervisor (supervisor extension) can monitor and control the status of each member within the ICD group, using a 6-line display PT. (→ 1.3.41 ICD Group Features—Supervisory)
Manual Queue Redirection (Hurry-up Transfer)	You can forward the longest waiting call in the queue of calls to the ICD group to a preprogrammed destination manually. (→ 1.3.40 ICD Group Features—Manual Queue Redirection)
Call Forwarding (FWD) for your ICD Group	You can set a forward destination for your ICD group. (→ Call Forwarding (FWD) for your Incoming Call Distribution Group)

1.3.36 ICD Group Features—Call Log History for ICD Group

An extension assigned as a supervisor (supervisor extension) can confirm the incoming call log for the incoming call distribution (ICD) group.
To perform this operation, the supervisor has to enter incoming call queue monitoring mode first.



To enter incoming call queue monitoring mode

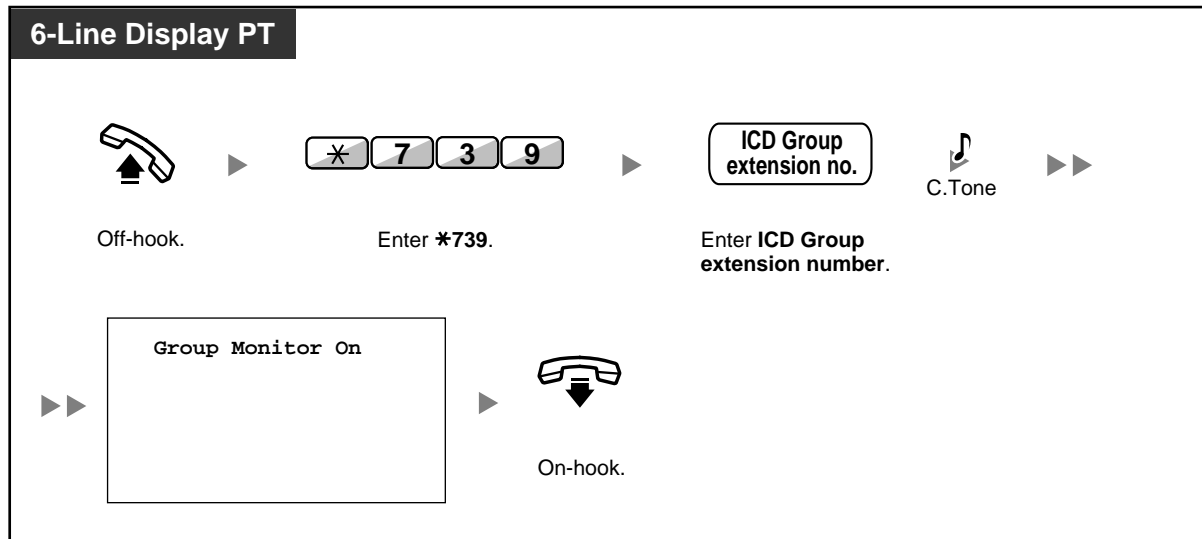

To confirm the Call Log History

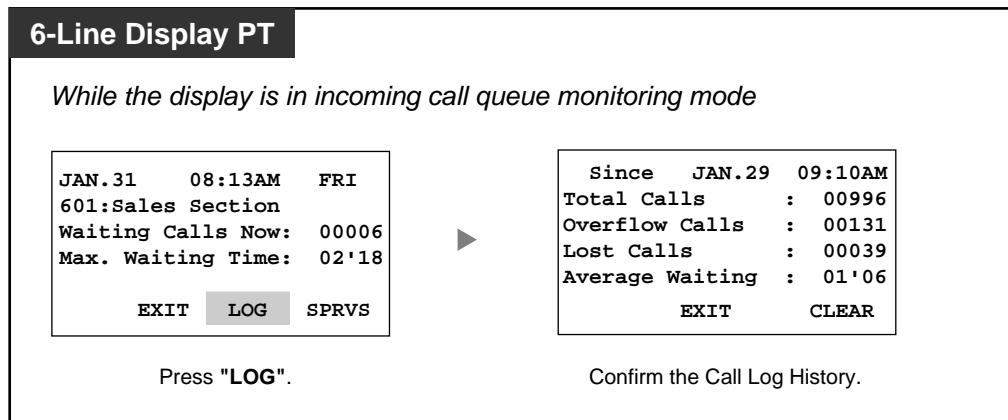

To clear Call Log History

6-Line Display PT

While the Call Log History is displayed

```

Since JAN.29 09:10AM
Total Calls      : 00996
Overflow Calls   : 00131
Lost Calls      : 00039
Average Waiting  : 01'06
EXIT            CLEAR
    
```

Press "CLEAR".



- If the accumulated data exceeds the maximum number that can be displayed (99999), "*****" is shown on the display. To reinitialize the display, clear the Call Log History.
- For information about other supervisory features, refer to "1.3.41 ICD Group Features—Supervisory".

1.3.37 ICD Group Features—Incoming Call Queue Monitor

An extension assigned as a supervisor (supervisor extension) can monitor the status of waiting calls to be answered in the queue for an incoming call distribution (ICD) group.



To monitor the waiting call status

6-Line Display PT

Off-hook. Enter *739. ICD Group extension no. C.Tone

Enter ICD Group extension number.

Group Monitor On

On-hook.

```

JAN.31 08:13AM  FRI
601:Sales Section
Waiting Calls Now: 00006
Max. Waiting Time: 02'18
EXIT LOG SPRVS
    
```

Confirm the status of queued calls.



- If an ICD group has an overflowed call, the display shows the status automatically.



- For information about other supervisory features, refer to "1.3.41 ICD Group Features—Supervisory".

1.3.38 ICD Group Features—Log-in/Log-out

You can control your status in an incoming call distribution (ICD) group. When in the Log-out mode, incoming calls to the group will not ring at your extension. When you return, calls will again ring at your extension. (Default: Log-in)
 Even if your extension is logged-in, you can have a specified time period (wrap-up time) when you will not receive calls after completing a previous call. This time can be used for you to write a report and so on.
 You can also manually select "Not Ready" mode to temporarily leave an ICD group.

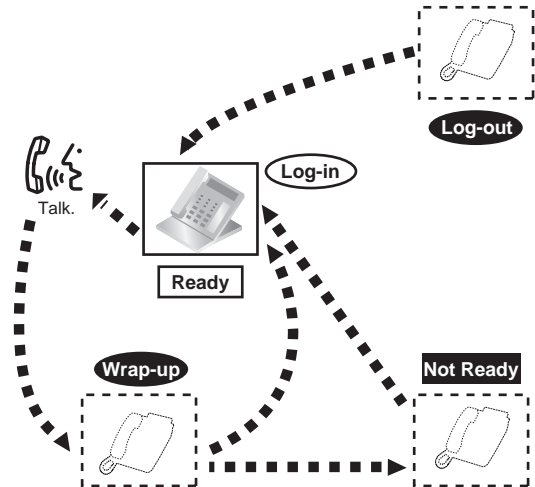

To set Log-in/Log-out

PT/SLT/PS *ICD Group: Incoming Call Distribution Group*



Off-hook.

* 7 3 6

Enter ***736**.

0 Log-out
OR
1 Log-in

Enter **0** or **1**.

ICD Group extension no.

Specified

OR

*

All

Enter **ICD Group extension number** or *****.



C.Tone



On-hook.

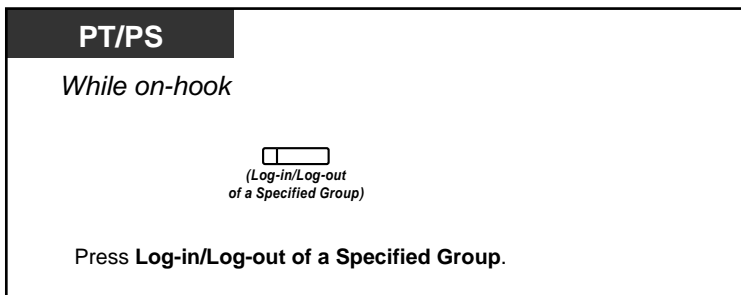
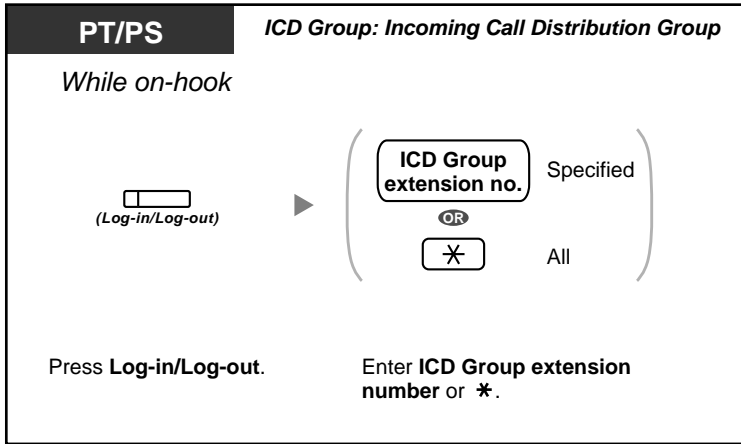

To enter/leave Not Ready mode

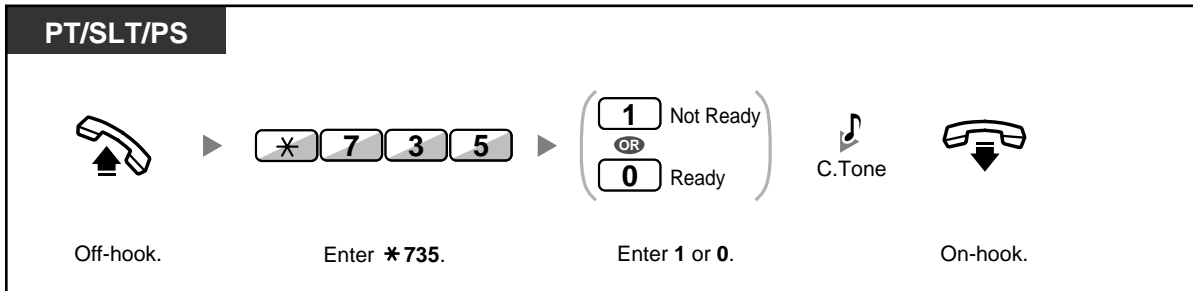

To set/cancel Not Ready mode or to leave Wrap-up mode (To enter Ready mode)

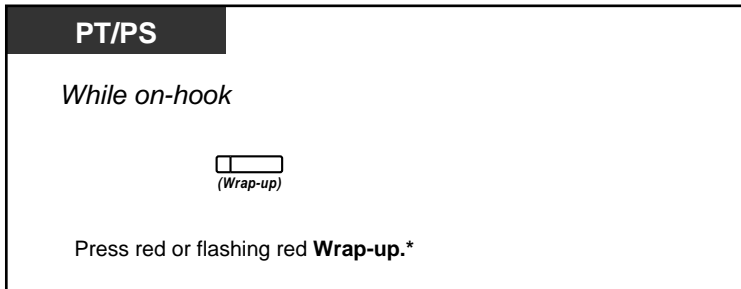



- * The status will be as follows:
Ready → Not Ready
Not Ready → Ready
Wrap-up → Not Ready
- The Log-in/Log-out of a specified group button light shows the current status as follows:
Off: Log-in mode
Red on: Log-out mode
- The Wrap-up button alternates the setting of Wrap-up mode, Not Ready mode or Ready mode. The Wrap-up button light shows the current status as follows:
Off: Ready mode
Red on: Not Ready mode
Flashing red: Wrap-up mode
- In Wrap-up mode/Not Ready mode, your extension does not receive calls through any group, even if it belongs to multiple groups.
- The last remaining logged-in extension may not be allowed to log out, depending on system programming.
- The Supervisor extension can control the Log-in/Log-out status of other extensions. For more information, refer to "1.3.39 ICD Group Features—Log-in/Log-out Monitor and Remote Control".



- For information about other ICD group features, refer to "1.3.35 ICD GROUP FEATURES".



Customizing Your Phone

- 3.1.4 Customizing the Buttons
Create or edit a Log-in/Log-out button, a Log-in/Log-out of a specified group button or a Wrap-up button.

1.3.39 ICD Group Features—Log-in/Log-out Monitor and Remote Control

An extension assigned as a supervisor (supervisor extension) can monitor the Log-in/Log-out status of incoming call distribution (ICD) group members with the lights of corresponding DSS buttons. The supervisor extension can change the Log-in/Log-out status of an extension by pressing the corresponding DSS button.

To perform this operation, the supervisor has to enter incoming call queue monitoring mode first.



To enter incoming call queue monitoring mode

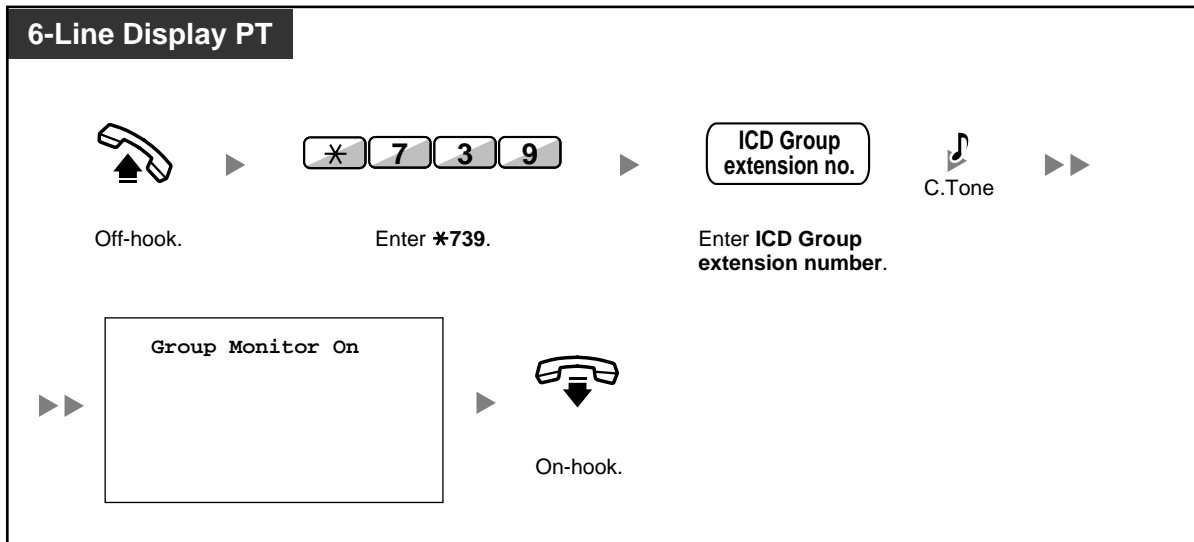

To monitor the Log-in/Log-out status

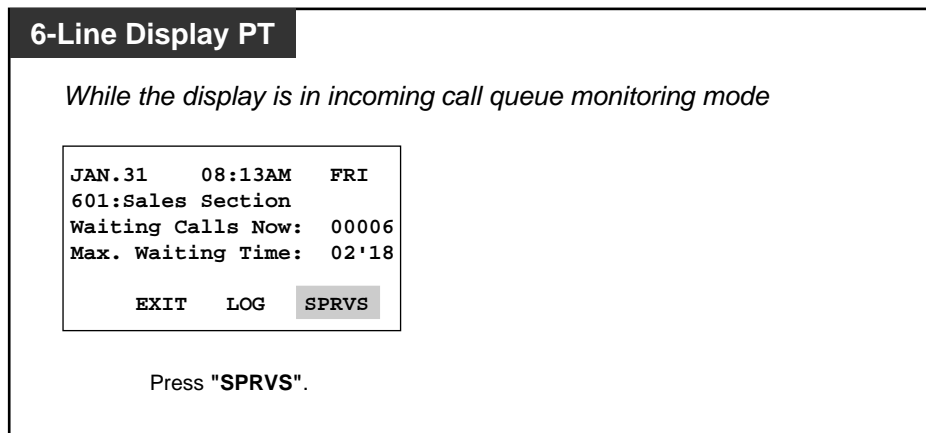

- While in Log-in/Log-out monitoring mode, the lights of DSS buttons for the ICD group members indicate their status as follows:
Off: Out of the ICD group.
Green on: Log-in mode (Ready). The extension user is ready to answer calls.
Flashing Green: Log-in mode (Not Ready). The extension user is not ready to answer calls.
Red on: Log-out mode.

To change the Log-in/Log-out mode

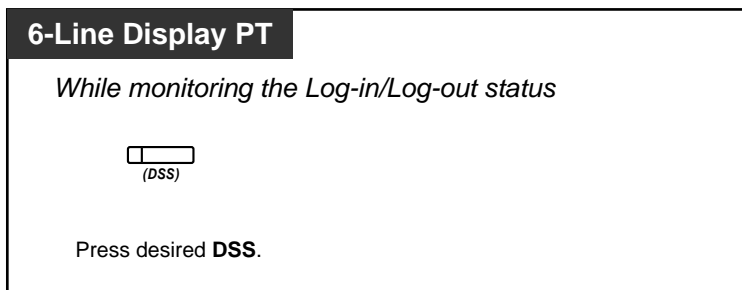



- Depending on the current status of the ICD group member, pressing the DSS button changes the status as follows:
Log-in mode (Not Ready) → Log-in mode (Ready)
Log-in mode (Ready) → Log-out mode
Log-out mode → Log-in mode (Ready)



- For information about other supervisory features, refer to "1.3.41 ICD Group Features—Supervisory".

1.3.40 ICD Group Features—Manual Queue Redirection

When your incoming call distribution (ICD) group is busy and other outside calls arrive, the arriving calls are put in a waiting queue. Extensions can check the status of the queue with the Hurry-up button light, and forward the longest waiting call in the queue to a preset destination manually. This feature is also known as Hurry-up Transfer.



To forward the waiting call

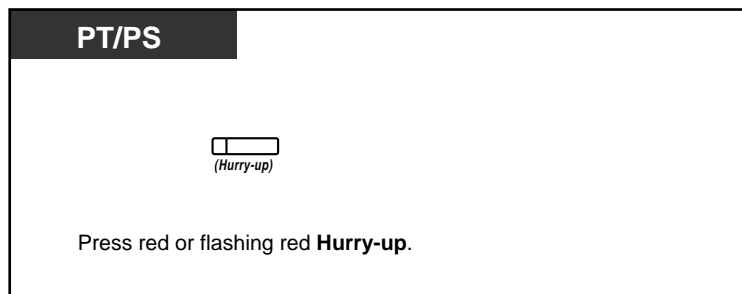

- The Hurry-up button light shows the current status as follows:
Off: No waiting call.
Red on: Some calls are waiting.
Flashing red: The number of calls exceeds the manual queue redirection level.



- For information about other ICD group features, refer to "1.3.35 ICD GROUP FEATURES".



Customizing Your Phone

- 3.1.4 Customizing the Buttons
Create or edit a Hurry-up button.

1.3.41 ICD Group Features—Supervisory

An extension assigned as a supervisor (supervisor extension) can monitor and control the status of other members in an Incoming Call Distribution (ICD) group using a 6-line display PT, as follows:

Features	Description
Incoming Call Queue Monitor	The supervisor extension can monitor the status of calls waiting in the queue to be answered. (→ 1.3.37 ICD Group Features—Incoming Call Queue Monitor)
Log-in/Log-out Monitor and Remote Control	The supervisor extension can monitor the Log-in/Log-out status of the ICD group members with the lights of corresponding DSS buttons. The supervisor extension can change their Log-in/Log-out status by pressing the corresponding DSS button. (→ 1.3.39 ICD Group Features—Log-in/Log-out Monitor and Remote Control)
Call Log History	The supervisor extension can confirm the incoming call log for the ICD group. (→ 1.3.36 ICD Group Features—Call Log History for ICD Group)

Using these features, for example, if extension 101 is logged out but the user is at his/her extension, and Incoming Call Queue Monitor shows that a call is waiting in the queue, the supervisor extension can change the status of extension 101 to Log-in. The waiting call will then be automatically directed to that extension. The following chart shows the flow of supervisory displays and access operations:

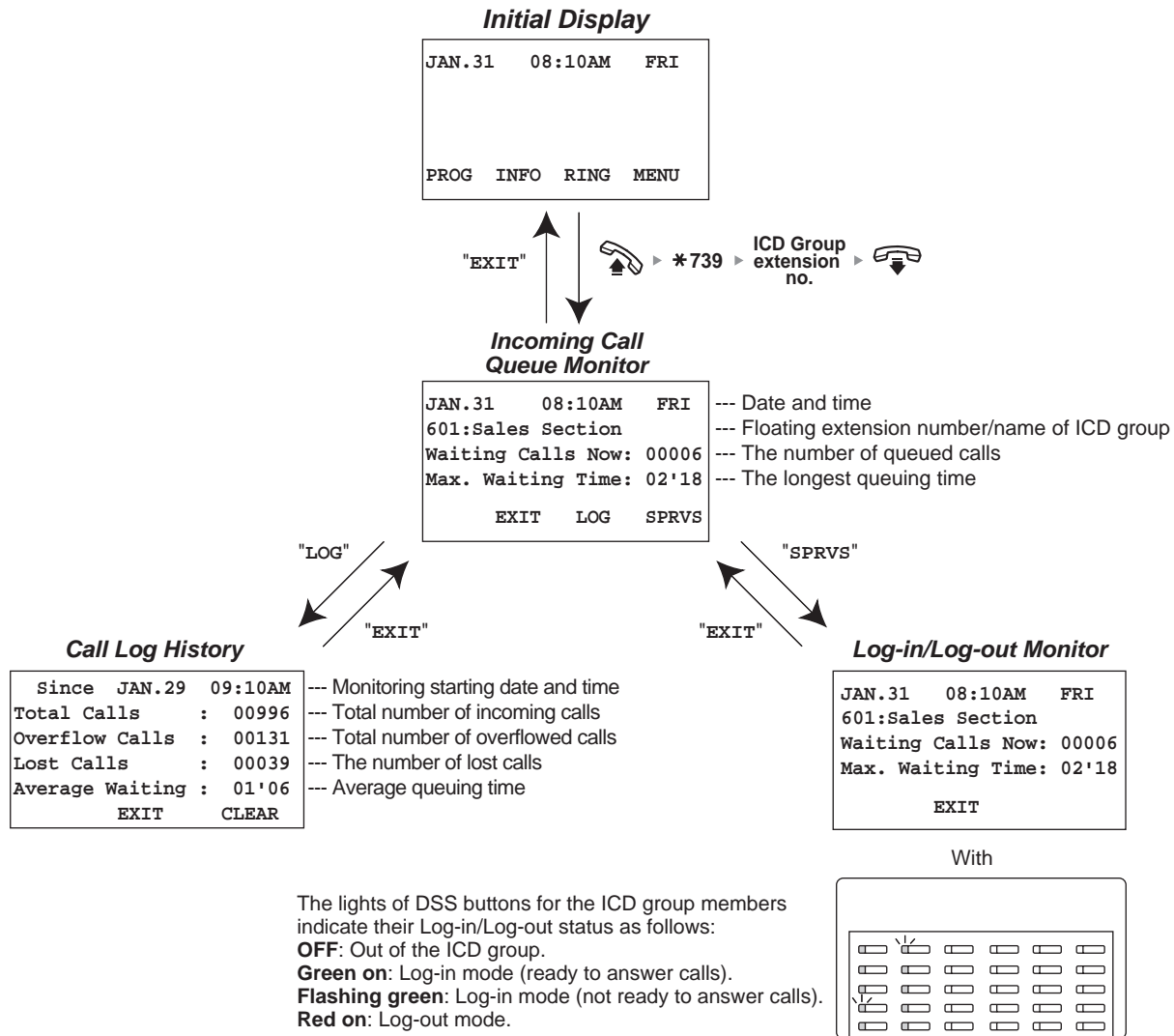



- For information about other ICD group features, refer to "1.3.35 ICD GROUP FEATURES".

1.3.42 Message Waiting

◆ For a caller

When the called extension is busy or does not answer your call, you can leave a notification so that the called party may call you back.

◆ For a called extension

As a message receiver, the Message button light or Message/Ringer Lamp lets you know that a call has been received. If you receive notification, you can call back the caller by a simple operation.

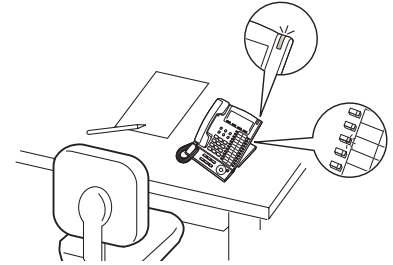

Note

This feature is not available for SIP extensions (except the KX-HGT100). For KX-HGT100 users, refer to the Quick Reference Guide of the KX-HGT100 for instructions.

◆ For a caller

To leave a message waiting indication

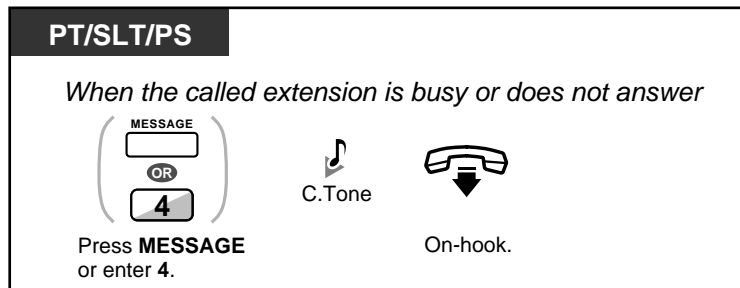

To leave/cancel a message waiting indication

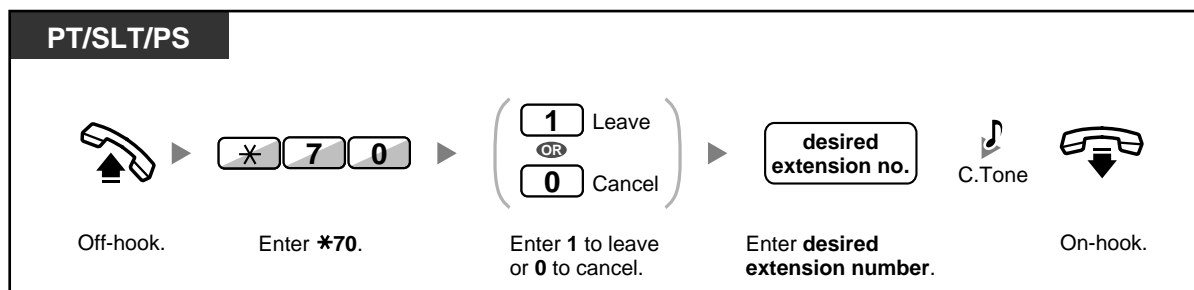

- When making a call to SIP Extensions, you cannot leave a message waiting notification. If you perform the operation to leave a message waiting notification to a SIP Extension, you will hear a reorder tone.

◆ For a called extension

To check the left message and call back

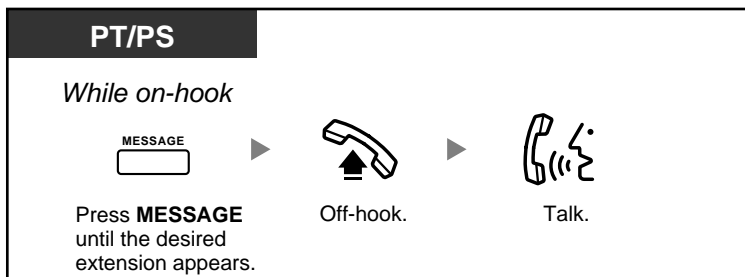

To call back

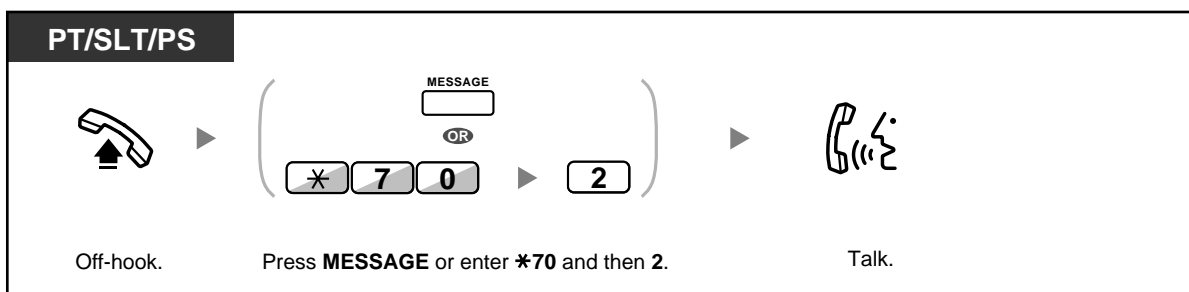

To clear message waiting indications left on your extension

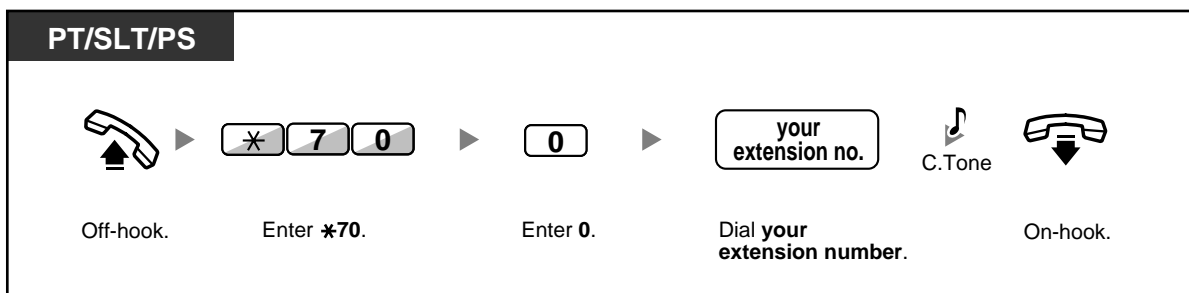

- The Message button light or Message/Ringer Lamp shows the current status as follows:
Off: No message
Red on: You have a message
- The display shows the messages starting with the most recent call.
- At a called extension, the MESSAGE button allows you to clear message waiting indications if you do not want to call the callers back. To clear, press the MESSAGE button and then press the soft button.
- On your PT, you can establish one or more Message for Another Extension buttons. These buttons can accept the message waiting notification of other extensions or various incoming call distribution groups. In other words, you can monitor the message waiting notifications of other telephones.
- A single line telephone extension user will receive a special dial tone as message waiting notification when going off-hook.
- The message waiting lamp of a single line telephone can also let you know that you have a message in the same way as the Message button.



Customizing Your Phone

- 3.1.4 Customizing the Buttons
 Create or edit a Message button or Message for Another Extension button.

1.3.43 Mute

You can disable the microphone or the handset to consult privately with others in the room while listening to the other party on the phone through the speaker or the handset.



To set/cancel

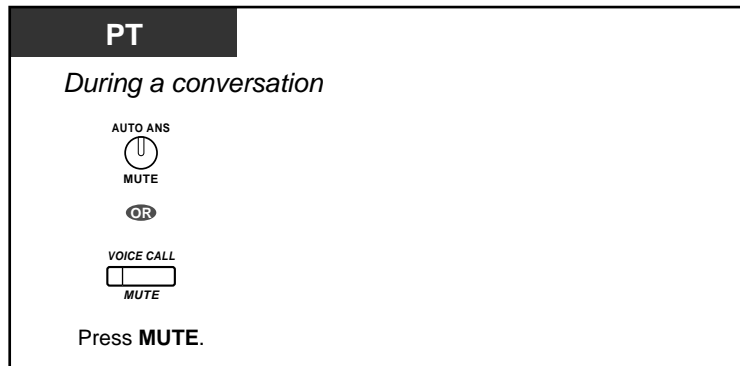

- The AUTO ANS/MUTE or VOICE CALL/MUTE button light shows the current status as follows:
 - Off:** Normal
 - Flashing red:** Mute
- If mute is used during OHCA, it will become Handset Mute.

1.3.44 Off-hook Monitor

You can let other people in the room listen to the conversation through the speaker while continuing the conversation using the handset.



To set/cancel



- The SP-PHONE button light shows the current status as follows:
 - Off:** The voice is heard through the handset.
 - On:** The voice is heard through the speaker and the handset.
- This feature is only available with certain proprietary telephones, and requires system programming.

1.3.45 OHCA (Off-hook Call Announcement)

During a conversation, you can be informed of a waiting call with a voice announcement. You can hear the caller's voice through the built-in speaker, and talk to the caller while the current call is continued using the handset.

To set/cancel for intercom calls (Manual Call Waiting)

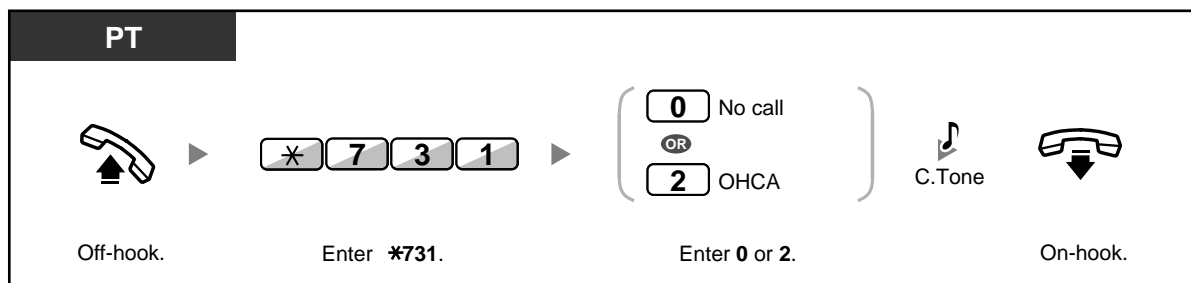

- OHCA is only available with certain digital proprietary telephones.
- OHCA is not available for outside calls; only call waiting tone can be set (refer to "1.3.13 Call Waiting Tone").
- A PDN extension can only receive OHCA or Whisper OHCA from the corresponding SDN extension. When a call is made from another extension, a PDN extension will receive a call waiting tone. (→ 1.3.49 PDN (Primary Directory Number)/SDN (Secondary Directory Number) Extension)



- For information about answering a waiting call, refer to "1.3.12 CALL WAITING FEATURES".

1.3.46 One-touch Dialing

You can store a phone number into the flexible button for one-touch operation.

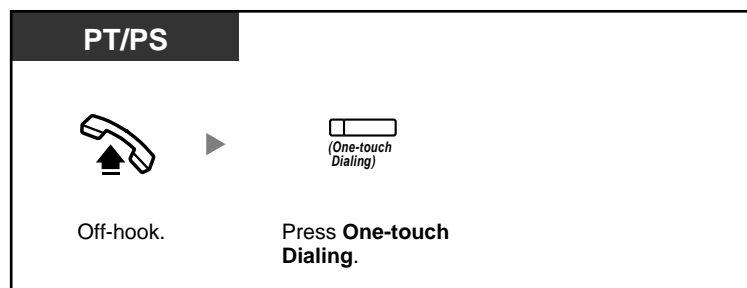

Customizing Your Phone

- 3.1.4 Customizing the Buttons
Create or edit a One-touch Dialing button, store the desired phone number or feature number.

1.3.47 Paging

- ◆◆ Group Paging
- ◆◆ Paging and then Transferring a Call
- ◆◆ Paging Deny

◆◆ Group Paging

You can make a voice announcement to proprietary telephones or external speakers or both in the preset group simultaneously. A person who has been paged can answer the page at any extension.

To page

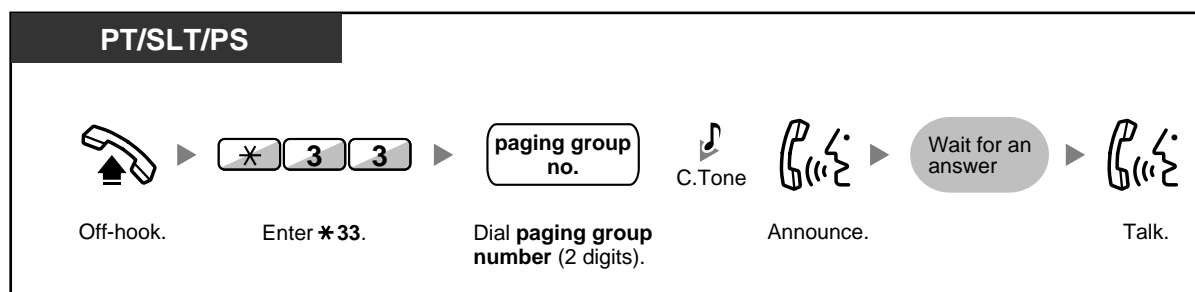

- If the group which you paged is already being used for paging, you hear a busy tone.

To answer

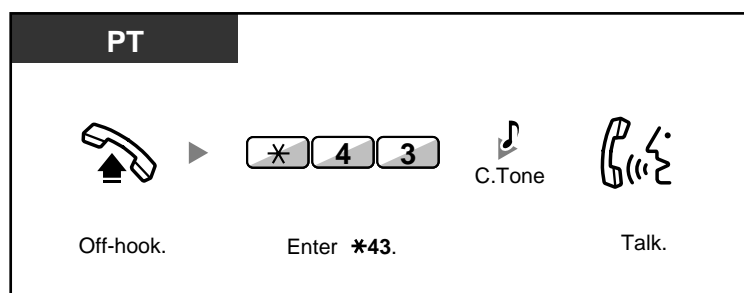

- The following are extensions that cannot receive a paging announcement:
 - Portable station
 - Single line telephone
 - Proprietary telephone that is ringing or busy
 - Proprietary telephone in Paging Deny mode
 - Proprietary telephone in DND mode
- System programming may be required for some IP-PT users to receive paging announcements.
- Even if the announcement is not paging your extension, you can answer it, if it is paging your group.

◆◆ Paging and then Transferring a Call

You can transfer a call after making paging announcements.

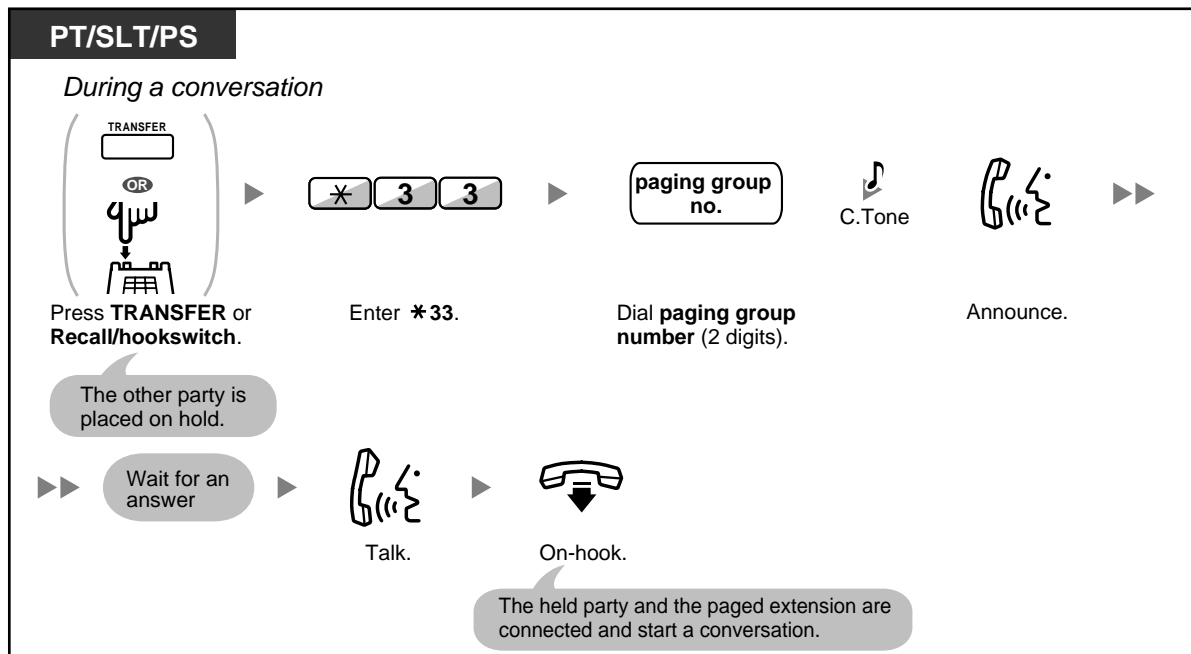

- After you go on-hook, the caller can talk to the person who answers the page.

◆◆ Paging Deny

You can set your extension not to receive paging announcements.

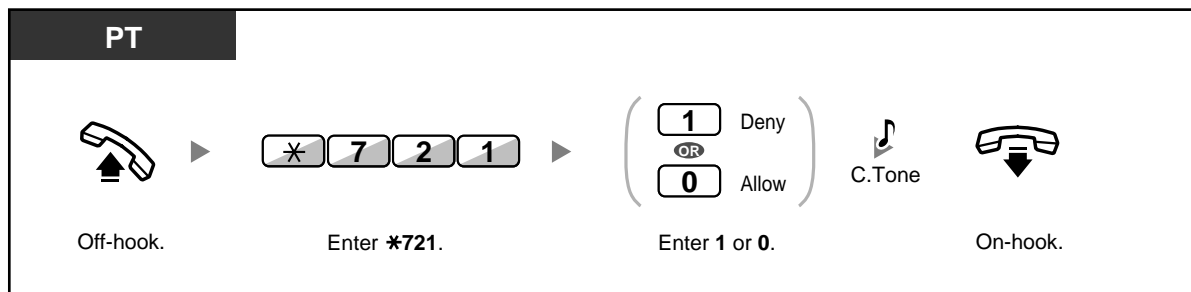

1.3.48 Paralleled Telephone

A digital proprietary telephone extension user can choose whether the single line telephone connected in parallel will ring or not, when an incoming call is received.
(Default: Ring)



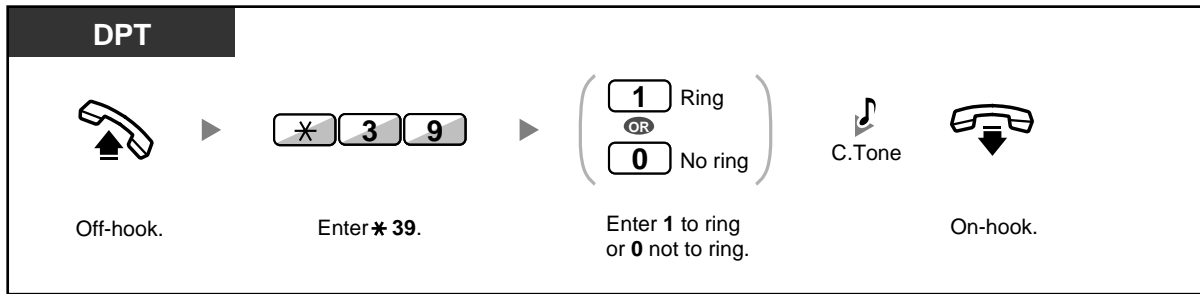

- **Even if "No ring" is selected**, calls can be made and answered on the single line telephone by lifting the handset.
- **If you go off-hook while your paralleled telephone is in use**, the call will switch over to you.

1.3.49 PDN (Primary Directory Number)/SDN (Secondary Directory Number) Extension

Primary Directory Number (PDN) buttons and Secondary Directory Number (SDN) buttons are useful when extension users will handle calls for other extensions. For example, a secretary or multiple secretaries can handle calls and check the call status of a boss or multiple bosses. The functions of PDN and SDN buttons are as follows:



PDN button: This button can be used to make and receive all calls (including both outside and intercom calls). Having multiple PDN buttons allows multiple calls to be queued at the extension. Extensions that have a PDN button are called PDN extensions.

SDN button: The light of an SDN button displays the current call status of the registered extension, similar to a DSS button. In addition, this button can be used to perform the following operations:

- call the PDN extension (◆◆ SDN Direct Dial)
- answer calls ringing at the PDN extension
- hold calls and retrieve calls held by the PDN extension (◆◆ Call Hold and Call Hold Retrieve)
- transfer calls to the PDN extension (◆◆ Call Transfer Using SDN Button)

Extensions that have an SDN button are called SDN extensions.



- The extension that is registered as the destination of an SDN button must have at least one PDN button.
- One extension can have up to 8 PDN buttons.
- An extension can have only one SDN button for each PDN extension.
- A PDN extension can only receive OHCA or Whisper OHCA from the corresponding SDN extension. When a call is made from another extension, a PDN extension will receive a call waiting tone.
- The button light of each PDN/SDN button shows the current status as follows:

Light Pattern	PDN Button Status	SDN Button Status
Off	The PDN extension is idle.	
Green on	The extension is on a call using the PDN button.	The extension is on a call using an SDN button.

Light Pattern	PDN Button Status	SDN Button Status
Flashing green slowly	A call is on hold at the PDN extension (Regular Hold).	A call answered with the SDN button is on hold (Regular Hold).
Flashing green moderately	A call is on hold temporarily or on Exclusive Call Hold.	A call answered with the SDN button is on hold temporarily or on Exclusive Call Hold.
Flashing green rapidly	The PDN extension is receiving an incoming call.	An SDN extension is receiving a Hold Recall or callback ringing from a call answered with the SDN button.
Red on	A corresponding SDN extension is using the line.	The corresponding PDN extension or another corresponding SDN extension is using the line.
Flashing red slowly	A corresponding SDN extension is holding a call.	Another corresponding SDN extension, or the PDN extension itself, is holding a call.
Flashing red rapidly	The PDN extension is receiving an incoming call to an incoming call distribution (ICD) group.	The corresponding PDN extension is receiving an incoming call.

◆◆ SDN Direct Dial

Using an SDN button, you can easily call the corresponding PDN extension. SDN buttons are in one of two modes depending on system programming, and the operation procedure differs as follows:

Enhanced DSS Key Mode



Standard SDN Key Mode

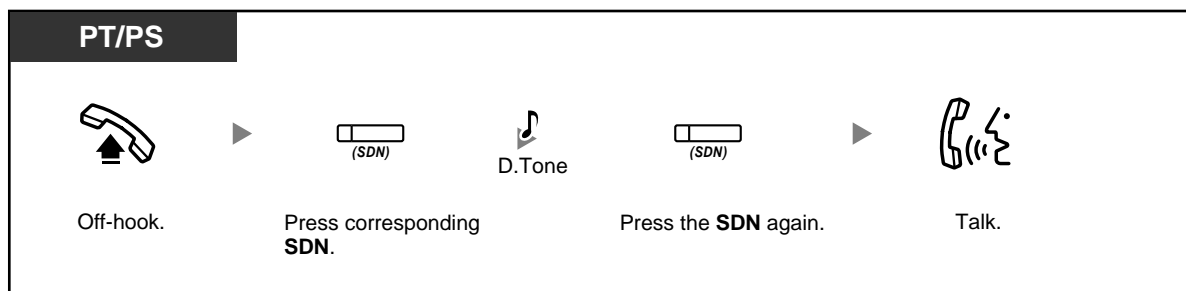



- When performing SDN Direct Dial to call the corresponding PDN extension, the SDN button light shows the current status of the destination extension as follows:
Green on: You are using the line.
Red on: The line is being used. (The PDN extension, or another SDN extension when multiple extensions have SDN buttons to a same PDN extension, is using the line.)
- Even if a PDN extension has set Do Not Disturb (DND), you can call the extension as normal by pressing the SDN button.



- When an SDN button is in Standard SDN Key Mode, you can dial a telephone number while hearing a dial tone, instead of pressing the SDN button again. Depending on system programming, your call will be made using either your normal calling privileges (Class of Service) or those of the corresponding PDN extension (**SDN Walking COS**).

◆◆ Call Hold and Call Hold Retrieve

You can put calls answered with a PDN or SDN button on hold normally (**1.3.6 Call Hold**). You can also retrieve a call held at your extension/another extension with a simple operation, regardless of the call type.

Call Hold Retrieve

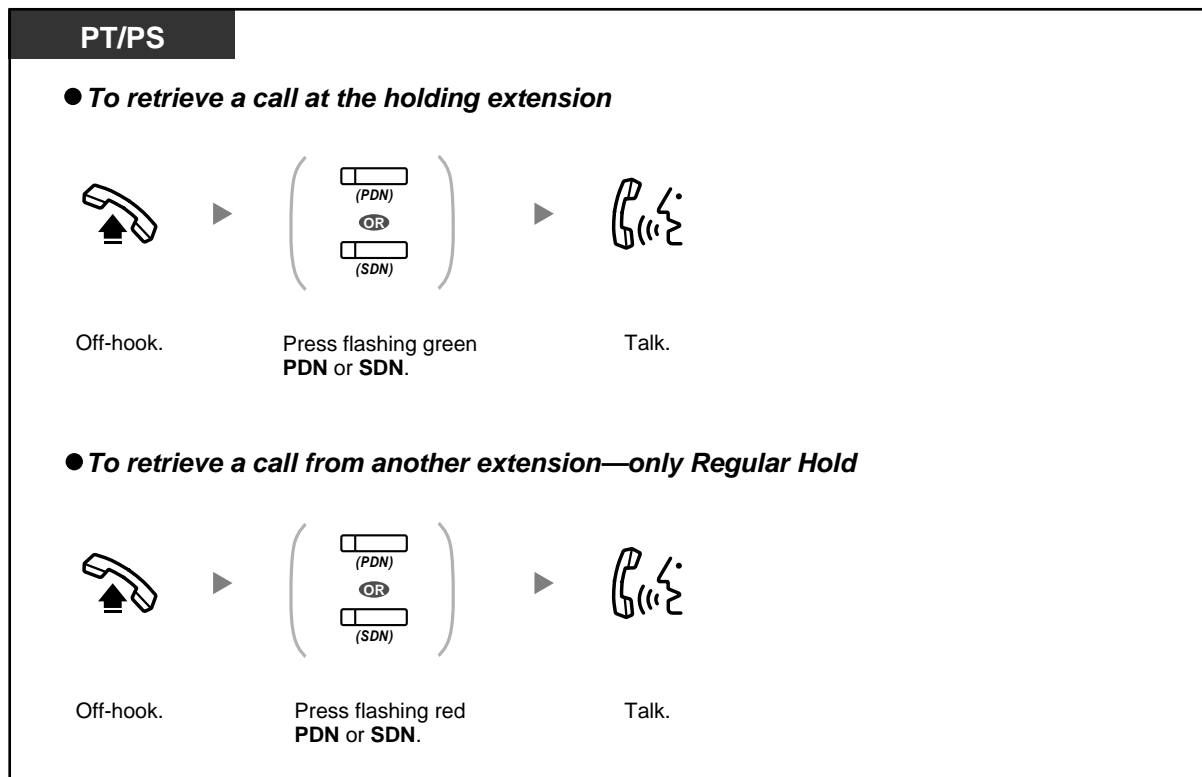

- If a call is not retrieved within a specified time**, you will hear an alarm as a reminder (Hold Recall).
 If an outside call is not answered within a specified time, it is automatically disconnected.



- If **Automatic Call Hold** has been preprogrammed, you can put the current call on hold automatically by pressing another PDN button to make or answer another call.

◆◆ Call Transfer Using SDN Button

You can transfer a call to a PDN extension with a simple operation using a corresponding SDN button.

To transfer a call to a PDN extension

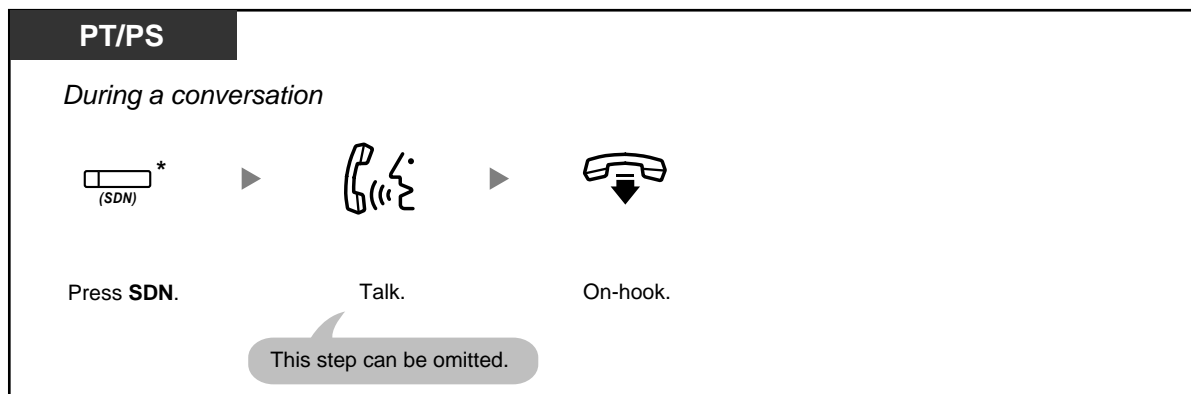

- System programming is required to use this feature during a conversation with an extension.
- * When an SDN button is in Standard SDN Key Mode, you have to press the SDN button twice to transfer the call, unless you used that SDN button to answer an incoming call.



Customizing Your Phone

- 3.1.2 Personal Programming—**Preferred Line Assignment—Incoming**
Select the seized line when going off hook.
- 3.1.2 Personal Programming—**Preferred Line Assignment—Outgoing**
Select the seized line when going off-hook.
- 3.1.4 Customizing the Buttons
Create or edit a Primary Directory Number (PDN) or Secondary Directory Number (SDN) button.

1.3.50 Printing Message

You can record a variety of information from your extension using up to 8 preprogrammed messages. Message information from all extensions is recorded with the PBX. For example, it is possible to use this feature as a time card by selecting preprogrammed "sign in" and "sign out" messages.

In a hotel-type environment, this feature can be used to record room information from a room extension. For a list of preprogrammed messages, consult your dealer.

To let a third party join your conversation and establish a three-party conversation

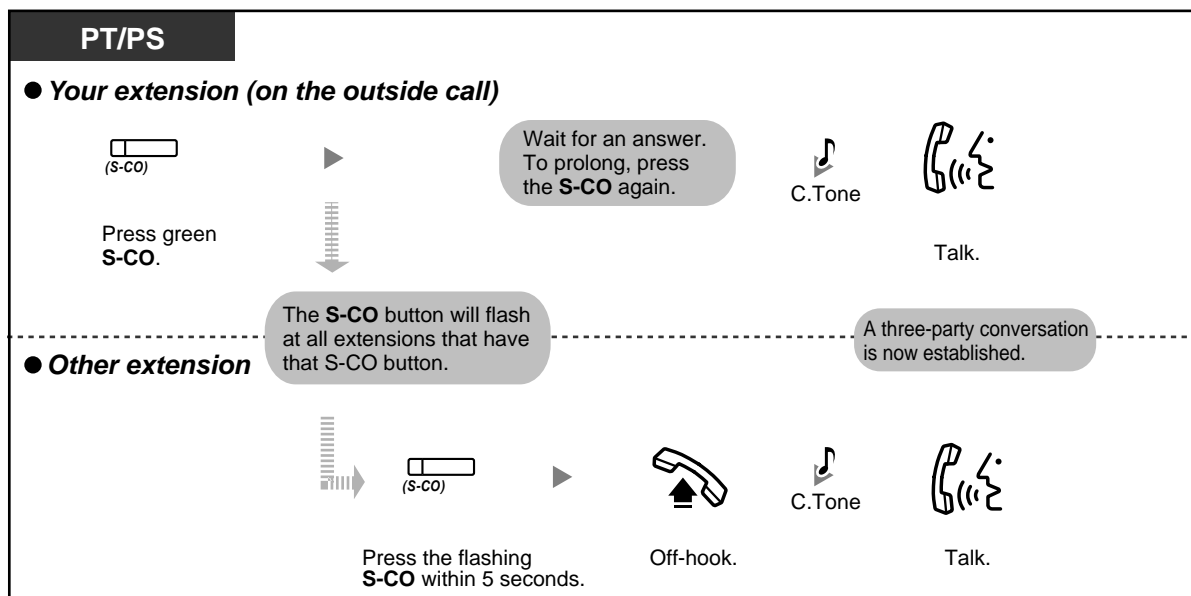

- Only an S-CO button can be used for this operation.
- You can leave a three-party conversation and let the two other parties talk by simply going on-hook.

1.3.52 Private Network Features—CLIP (Calling Line Identification Presentation)

When making a call through a private network, you can present your preprogrammed telephone number to the called party.

You can select the telephone number sent, either the number of the line used or the number assigned to your extension.

If you select "Public", the calling/called party sees the number of the line used (subscriber's number).

If you select "Your extension", they see the telephone number assigned on your extension.

To show either the number assigned to the CO line or your extension

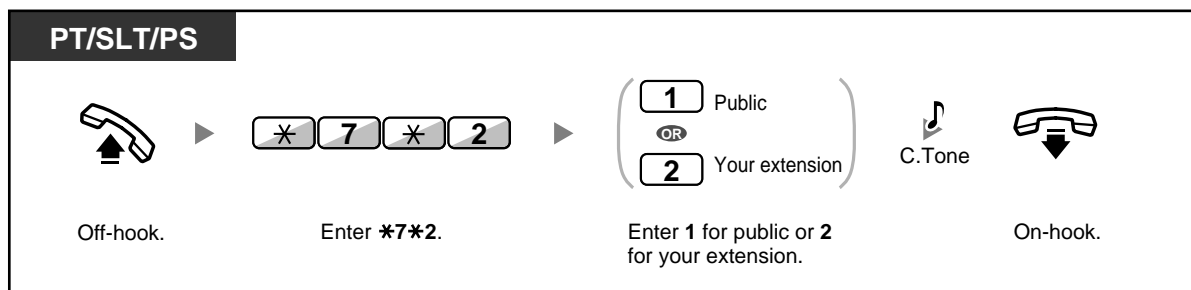

- If you use the ICD Group button to make a call to the other party, the telephone number assigned to the ICD group will be used.

1.3.53 Private Network Features—CLIR (Calling Line Identification Restriction)

When making a call through a private network, you can select whether the called party can see your telephone number or not.

To show/prevent

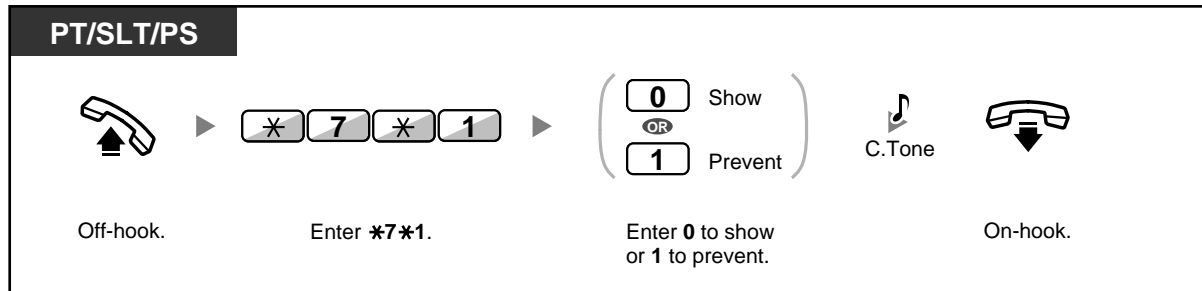

- You can change the mode by pressing a preset CLIR button while on-hook. The CLIR button light shows the current status as follows:
Off: shows your telephone number.
Red on: prevents your telephone number being displayed.



Customizing Your Phone

- 3.1.4 Customizing the Buttons
 Create or edit a Calling Line Identification Restriction (CLIR) button.

1.3.54 Private Network Features—COLP (Connected Line Identification Presentation)

When receiving a call through a private network, you can present your preprogrammed telephone number to the calling party.

You can select the telephone number sent, either the number of the line used or the number assigned to your extension.

If you select "Public", the calling/called party sees the number of the line used (subscriber's number).

If you select "Your extension", they see the telephone number assigned on your extension.

To show either the number assigned to the CO line or your extension

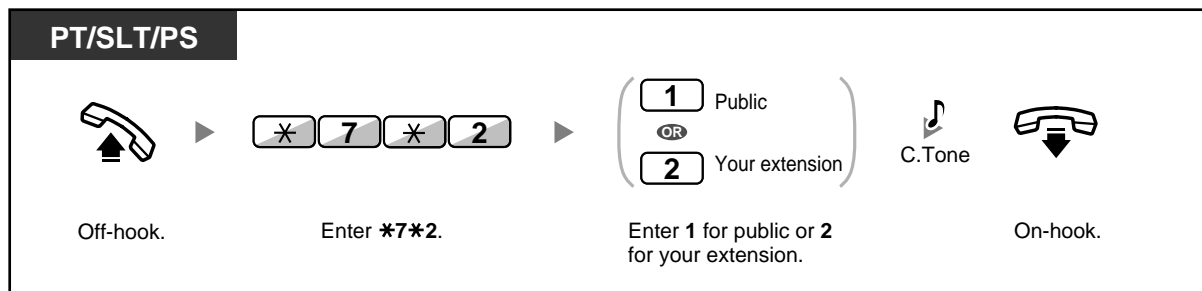

1.3.55 Private Network Features—COLR (Connected Line Identification Restriction)

When receiving a call through a private network, you can select whether the caller can see your telephone number or not.

To show/prevent

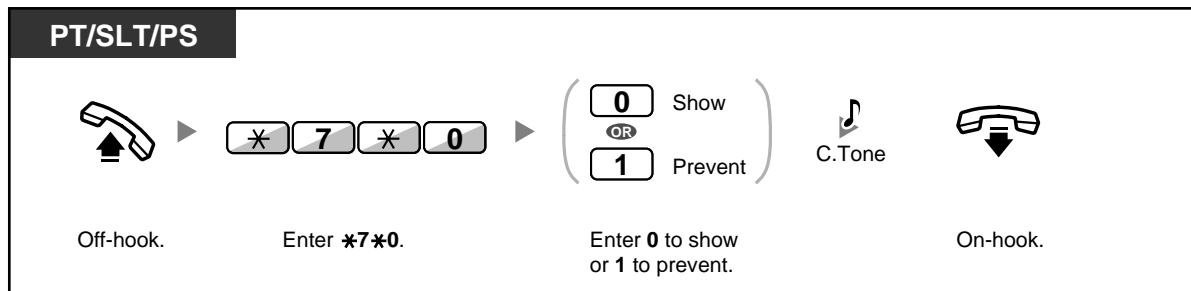

- You can change the mode by pressing a preset COLR button while on-hook. The COLR button light shows the current status as follows:
Off: shows your telephone number.
Red on: prevents your telephone number being displayed.



Customizing Your Phone

- 3.1.4 Customizing the Buttons
 Create or edit a Connected Line Identification Restriction (COLR) button.

1.3.56 Private Network Features—Displaying Your Telephone Number on the Called Party's Telephone

When making a call through a private network, you can present your telephone number to the called party. The number assigned to your extension will be displayed on the display of the other party's telephone.



To show

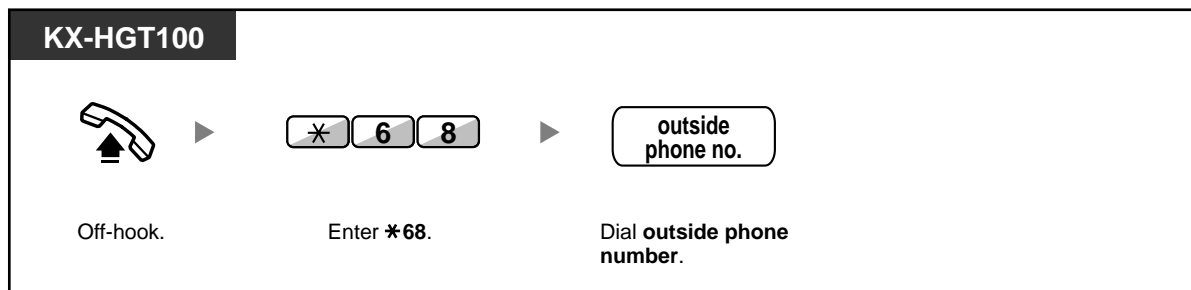

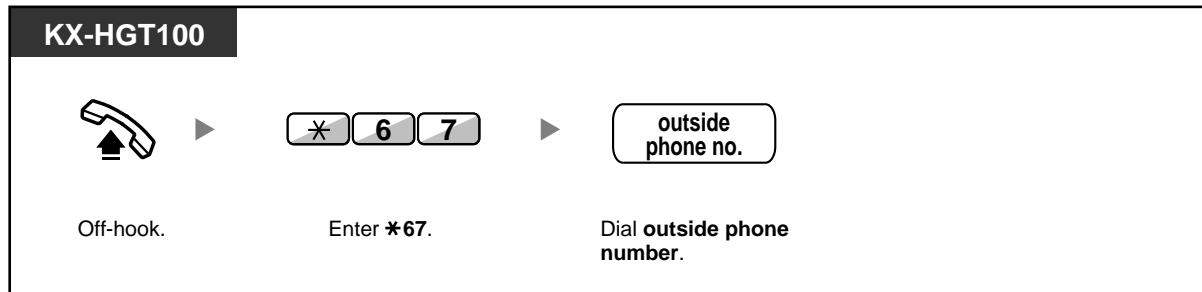
To prevent (not show)

Availability of this feature depends on the following:

- The ISDN service of the other party's telephone company
- The telephone service of the other party's ITSP (Internet Telephony Service Provider)
- The settings of the other party's telephone equipment

1.3.57 Private Network Features—TIE Line Access

You can access extensions connected to other PBXs in a private network.

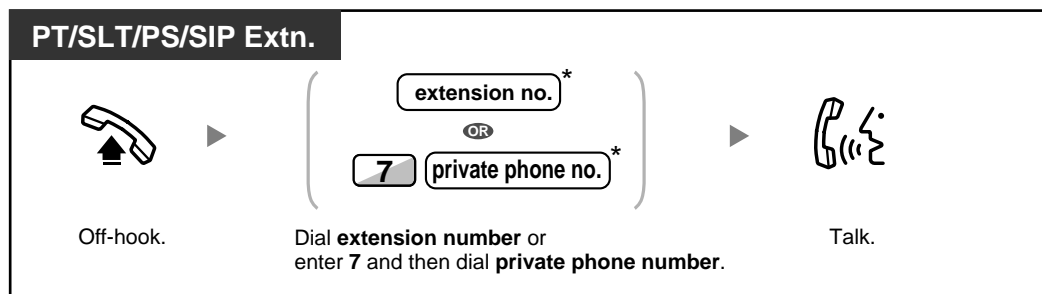
To call

- * Which type of telephone number must be entered depends on the settings of your PBX.

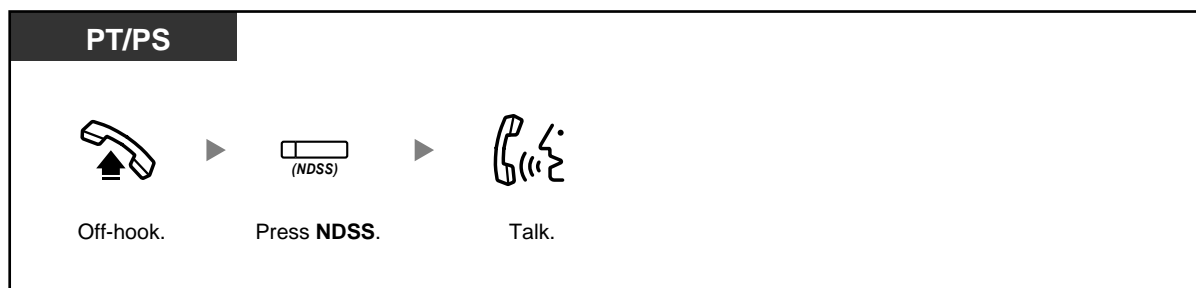
To call with one touch



- To start monitoring another PBX extension after customizing an NDSS button, go off-hook, press the NDSS button, and go on-hook. The NDSS button light will show the current status as follows:
Off: The extension is idle.
Red on: The extension is busy.



Customizing Your Phone

- 3.1.4 Customizing the Buttons
Create or edit a Network Direct Station Selection (NDSS) button.

1.3.58 Quick Dialing

You can make a call simply by pressing the preprogrammed number for quick dialing.

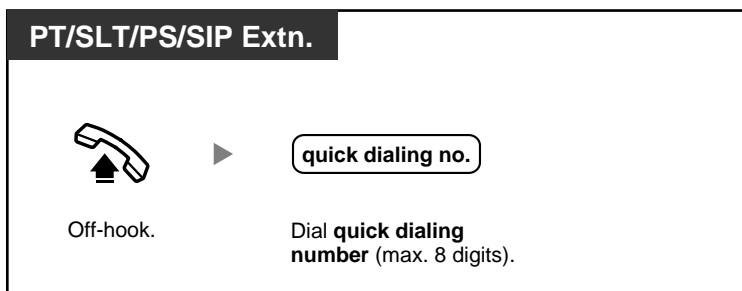

- This is a useful feature for hotels. For example, to dial Room Service, dial the digit "3", not the full extension number.

1.3.59 Redial, Last Number

This is convenient when calling the same outside party again.

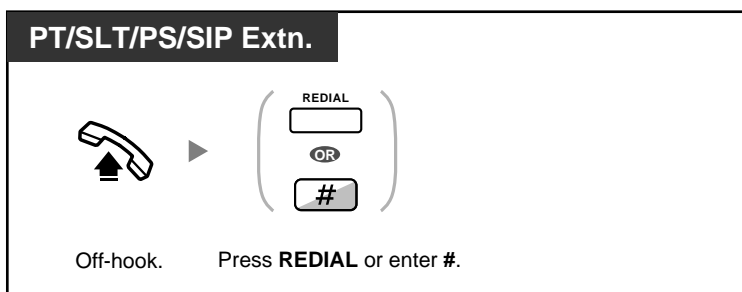

- Up to 32 digits can be stored and redialed.
- After pressing REDIAL, if you hear a busy tone again, press REDIAL to retry.

1.3.60 Room Status Control

In a hotel-type environment, an extension assigned as a hotel operator can check guests into or out of rooms and confirm that the room is clean and ready for the next guest by changing the room status of the corresponding extension. The hotel operator's extension must have flexible buttons assigned as Check-in, Check-out, and Cleaned-up^{*1} buttons, and a DSS button for each extension that will be used in a guest room.



*1 The Cleaned-up feature is only available for the KX-TDE600.



- The hotel operator must be using a 6-line display PT to use the Room Status Control features.
- While in Room Status Control mode:
 - a. The hotel operator's extension can only check extensions in/out and ready/not ready. All other operations will be ignored.
 - b. The light of each DSS button shows the room status of the corresponding extension as follows:

For the KX-TDE100/KX-TDE200

Off: Checked-out

Red on: Checked-in

For the KX-TDE600

Off: Checked-out and Ready

Flashing Red: Checked-out and Not Ready

Red on: Checked-in

[Light Pattern Example: Checked-in Mode]

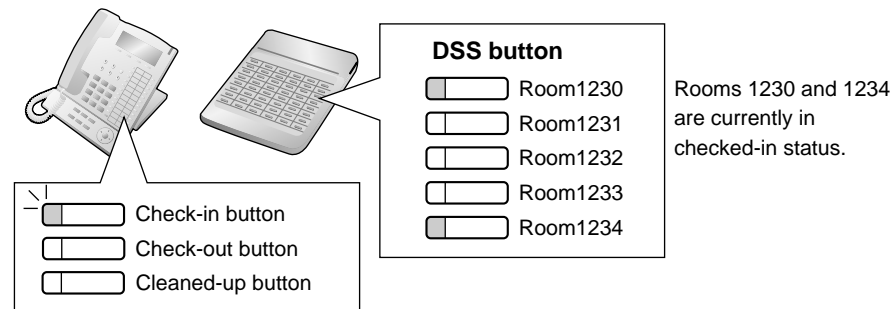

- c. The lights of other buttons may not show their normal display.
- d. The hotel operator's extension is considered to be busy. Callers to that extension will hear a busy tone.

To check in a guest

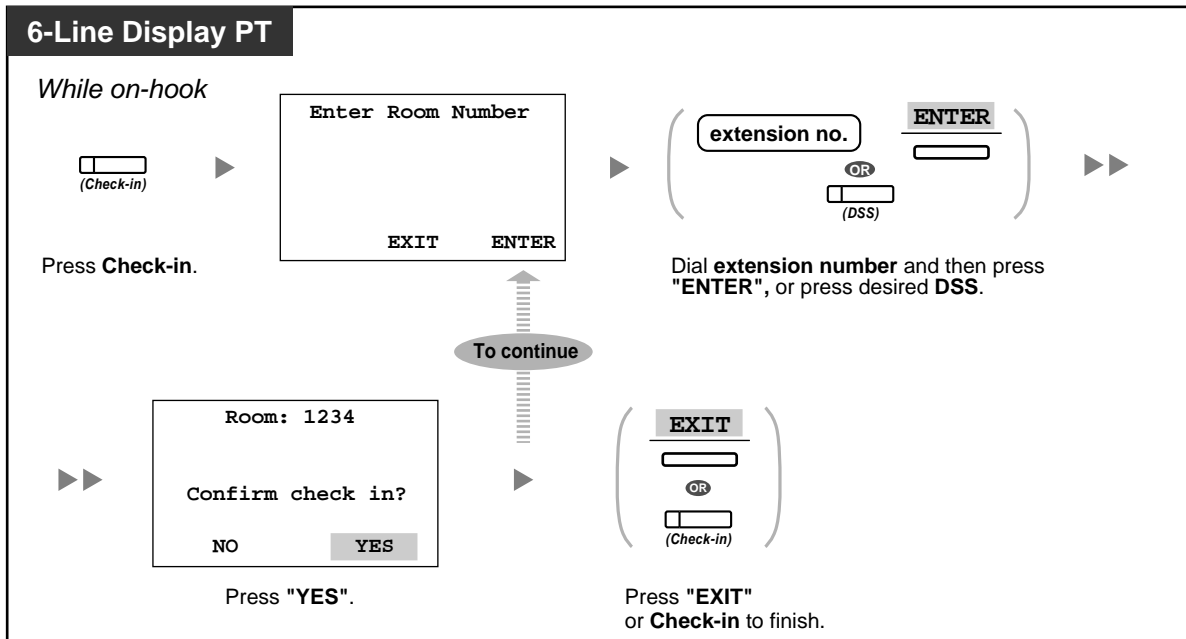

- After check-in, Remote Extension Dial Lock is deactivated, and the guest can make outside calls from the room extension. (Refer to "2.1.5 Remote Extension Dial Lock".)
- When the room status of extensions is changed, detailed room status information is recorded with the PBX automatically. This requires system programming.
<Example>

Date	Time	Ext	CO	Dial Number
02/02/00	03:07PM	1234		Check in

To check out a guest

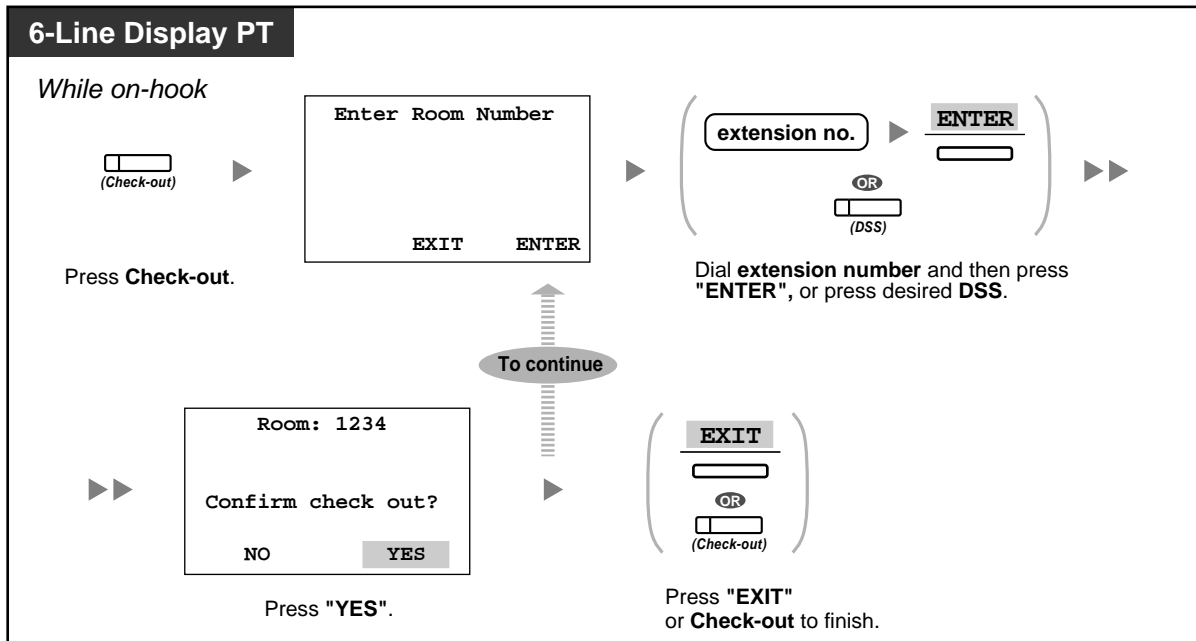

- After check-out, Remote Extension Dial Lock is activated, and outside calls from the room extension are restricted. (Refer to "2.1.5 Remote Extension Dial Lock".)
- After check-out, wake-up call and Call Log information for the room extension are cleared automatically. In addition, features set on the room extension are reset to the default settings. For a list of features that are reset, refer to "1.3.25 Extension Feature Clear".
- When the room status of extensions is changed, detailed room status information is recorded with the PBX automatically. This requires system programming.
<Example>

Date	Time	Ext	CO	Dial Number
02/03/00	08:08AM	1234		Check out

To change the cleaning status of a room (KX-TDE600 only)

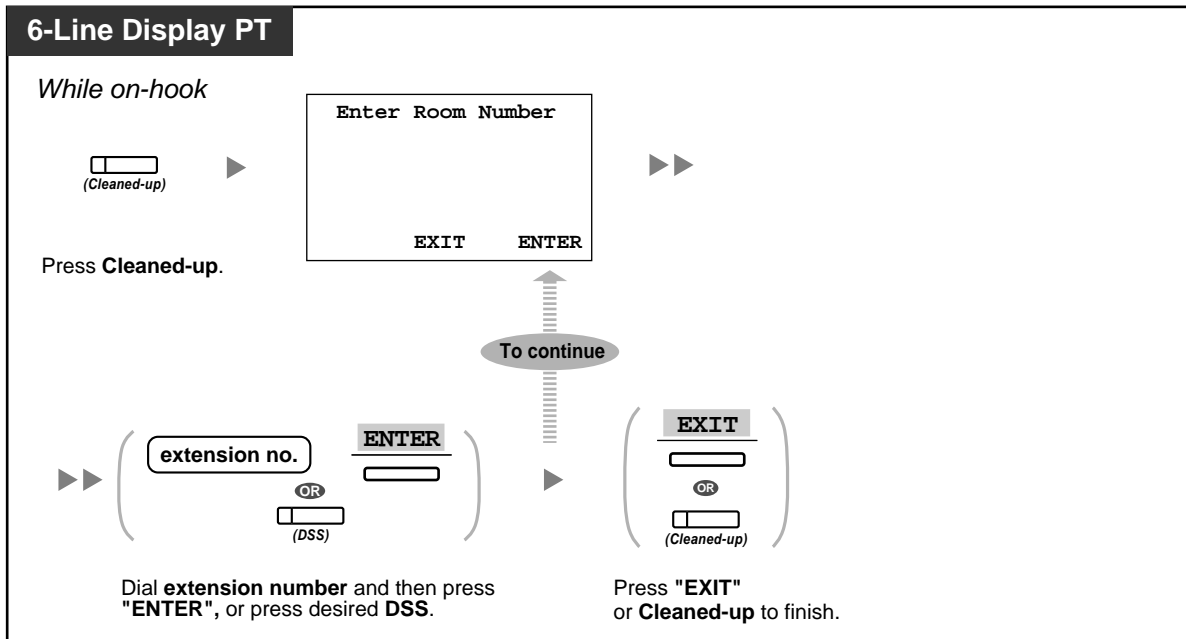

- For information about other Hospitality features, refer to "1.3.33 HOSPITALITY FEATURES".



Customizing Your Phone

- 3.1.4 Customizing the Buttons
Create or edit a Check-in, Check-out, or Cleaned-up button.

1.3.61 Self Labeling (KX-NT366 only)

The KX-NT366 IP-PT has 12 flexible buttons, and a display for each button to show what feature, telephone number or extension number is assigned to it. The display can also be switched to show 3 other sets (Pages) of 12 flexible buttons assignment by pressing the NEXT PAGE key. Different features, telephone numbers or extension numbers can be assigned to each button in every set. This means that 48 flexible buttons are available to an extension user.

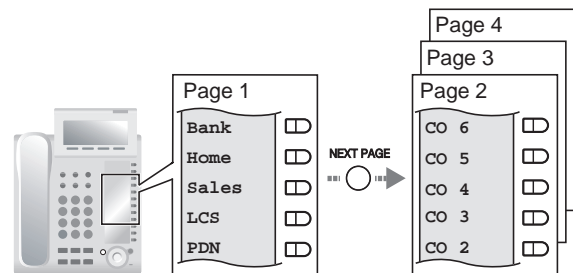

To switch display



- When you answer an incoming call or when you seize a CO line, the display automatically changes to the page that contains the green lit button.
- After customizing each button, you can set the displayed text for the button. For details about customizing buttons, refer to "3.1.4 Customizing the Buttons".

1.3.62 Speed Dialing, Personal

You can store up to 100 numbers at your extension for your personal use. This feature is also known as Station Speed Dialing.

To store a phone number

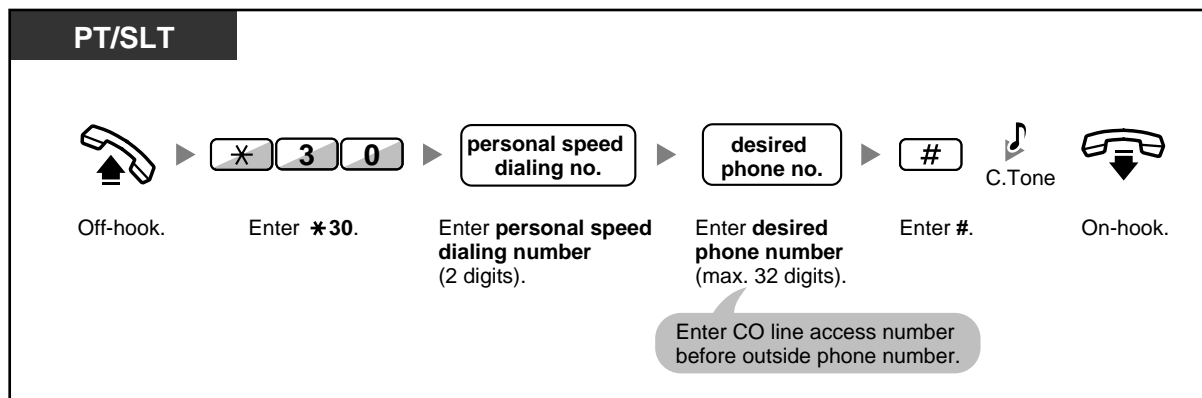

To dial

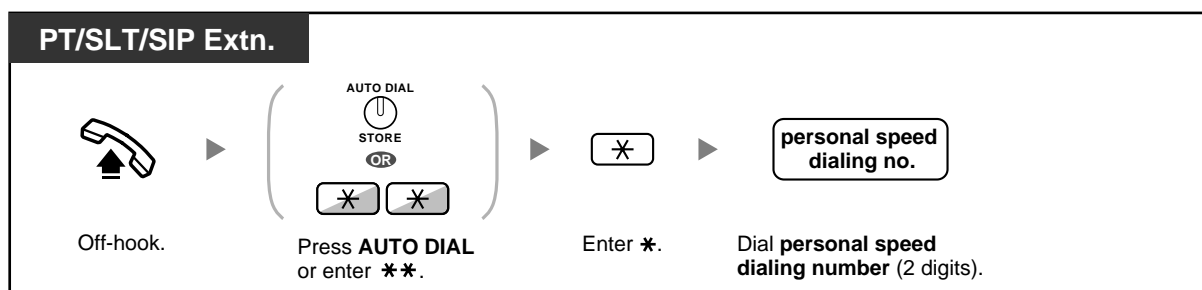

- A SIP Extension user cannot store personal speed dialing numbers at his/her extension. However, it is possible to use the personal speed dialing numbers that are stored in the PBX, through system programming.



- To call using a directory, refer to "1.4.3 Directories".
- A KX-HGT100 user can store and dial personal speed dialing numbers in his/her own telephone. Refer to the Quick Reference Guide of the KX-HGT100 for instructions.

1.3.63 Speed Dialing, System

You can make calls using speed dialing numbers stored in the PBX.

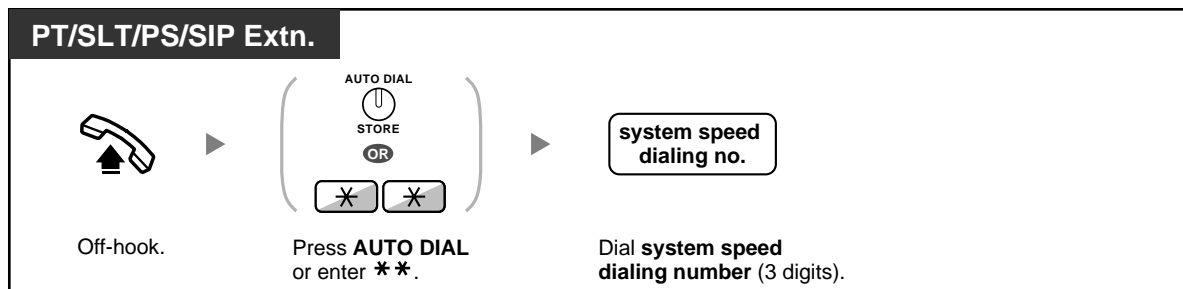

- To call using a directory, refer to "1.4.3 Directories".

1.3.64 SVM (Simplified Voice Message)

Your PBX can provide you with answering machine service.

Your extension is assigned a message box, into which callers can leave voice messages for you.

After callers reach your message box, they will hear your personal greeting message. You can record two kinds of personal greetings: a normal greeting message and a greeting message for each time mode. You can also play back and clear your greeting messages and the voice messages left by callers.

- ◆◆ Recording a Normal Greeting Message
- ◆◆ Recording a Greeting Message for Each Time Mode
- ◆◆ Redirecting Your Calls to Your Message Box
- ◆◆ Leaving Voice Messages
- ◆◆ Listening to Voice Messages Left by Callers
- ◆◆ Accessing Your Message Box from an Outside Telephone
- ◆◆ Accessing the Message Box of Another Extension from Your Extension



- This feature is not available for SIP Extensions.
- You may hear a busy tone when trying to access your message box if too many other users are already accessing their message boxes. In that case, wait a few minutes and try again.
- If the used recording space (including greeting messages and voice messages left by callers) for the SVM feature reaches a certain limit, the display informs you that the recording space is almost full, and you will hear dial tone 3 when going off-hook.

Dial Tone 3





- Operation Reference When Accessing Your Message Box**
 After entering the SVM feature number (*38), the operations below are available by entering the corresponding numbers.

Operation No.	Operation
0	To clear the normal greeting message
1	To record a normal greeting message
2	To play back the normal greeting message
3	To listen to voice messages left by callers
8	To set a greeting message for each time mode
# 6	To leave a voice message to another extension's message box.

◆◆ Recording a Normal Greeting Message

To record

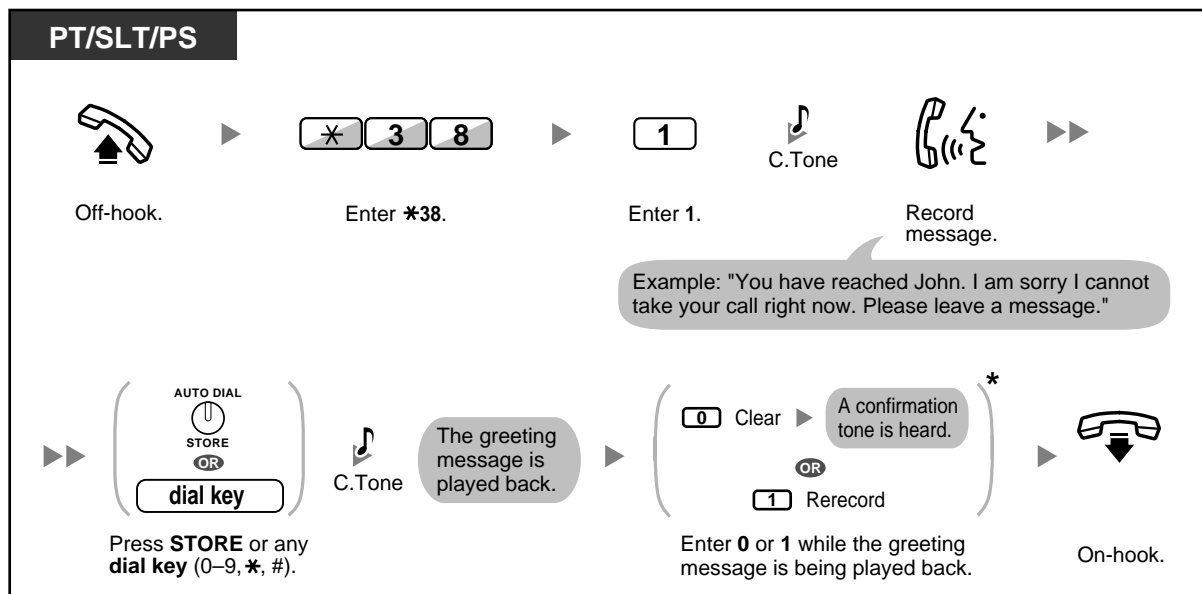

To play back

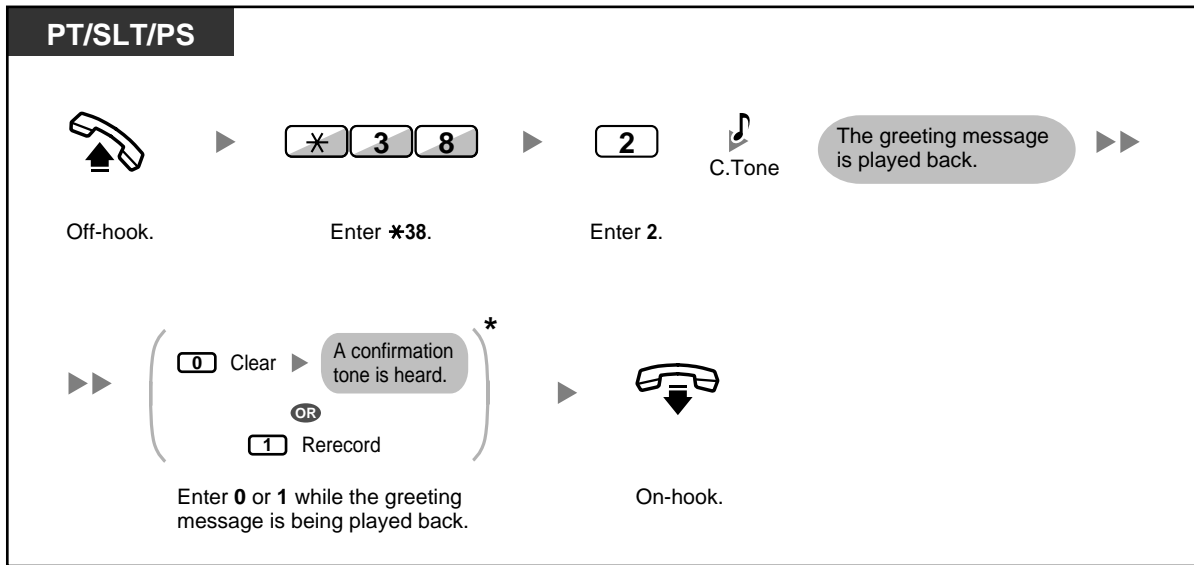

- * This step can be omitted.

To clear

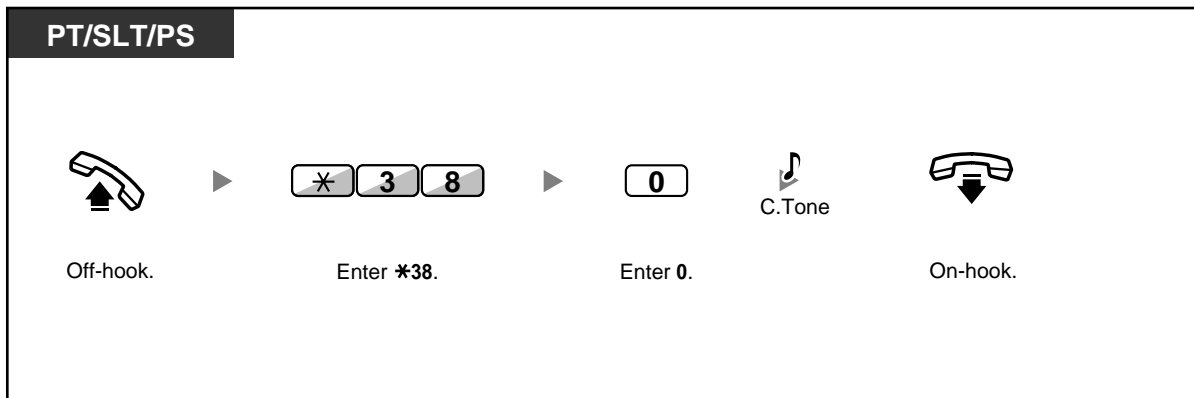

◆◆ Recording a Greeting Message for Each Time Mode

In addition to a normal greeting message, you can record a specific greeting message for each time mode (day/lunch/break/night).

To record

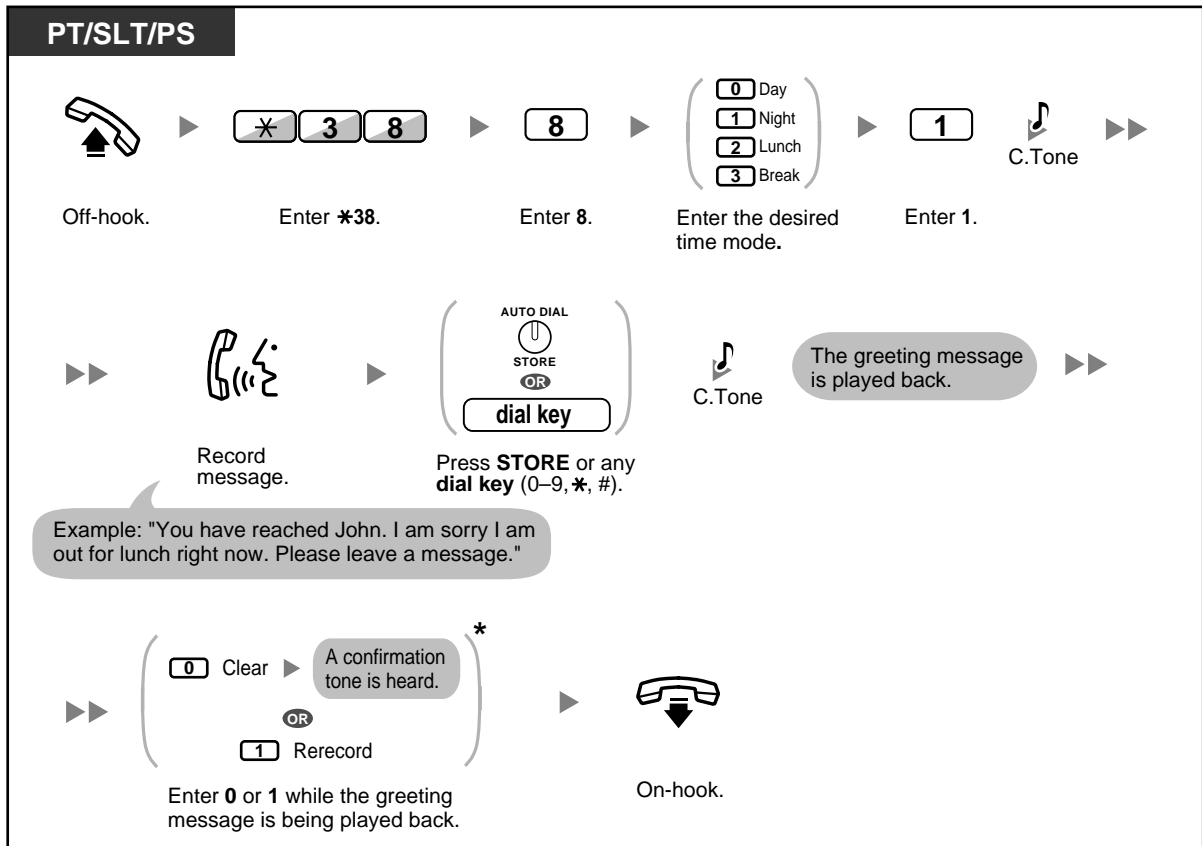

To play back

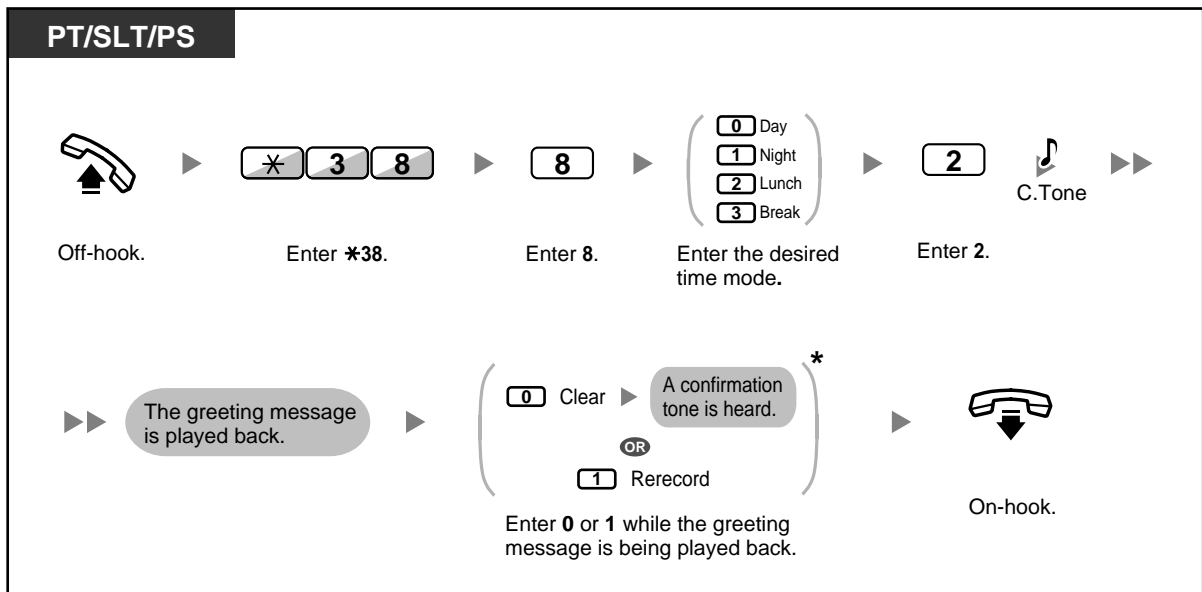

- * This step can be omitted.

To clear

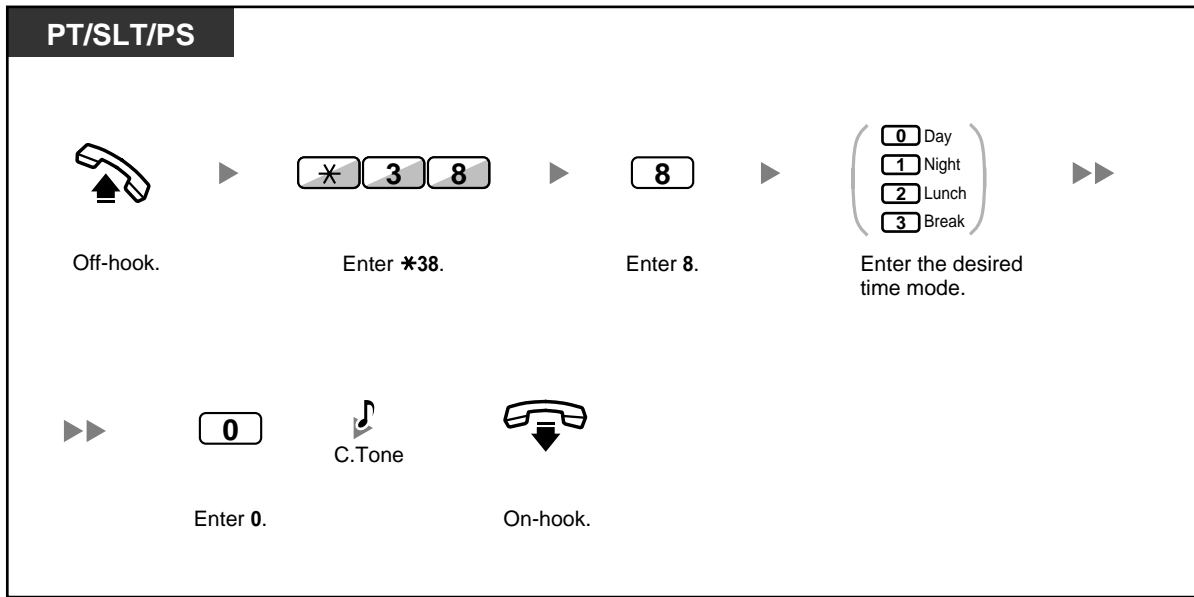

- If both the greeting message for a certain time mode and the normal greeting message have been recorded, callers will hear the greeting message for that time mode. However, if no greeting message has been recorded for a certain time mode, the normal greeting message will be played instead.

◆◆ **Redirecting Your Calls to Your Message Box**

You can set incoming calls to be redirected to your own message box so that callers can leave voice messages when you cannot answer the phone.

To set/cancel

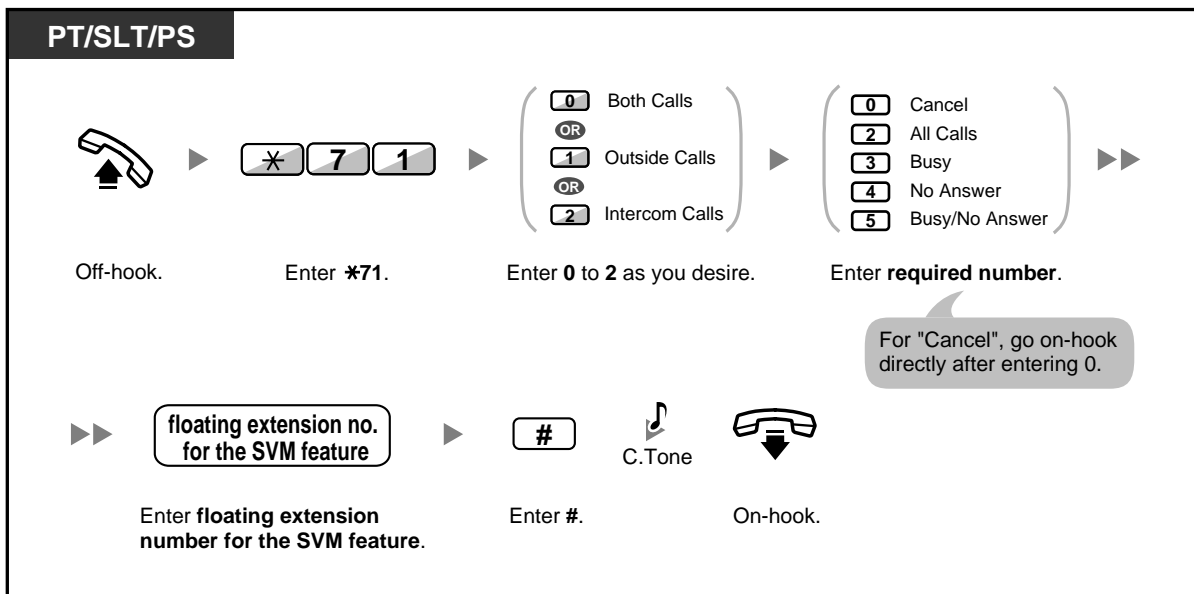



- The default floating extension number for the SVM feature is 591.

◆◆ Leaving Voice Messages

If the extension user you called is not able to answer your call, and your call is redirected to the message box, you will hear the greeting message. Then, you can leave a voice message for that extension. It is also possible to leave a voice message directly in the message box of a desired extension by following the steps below:

To leave a voice message directly to another extension's message box

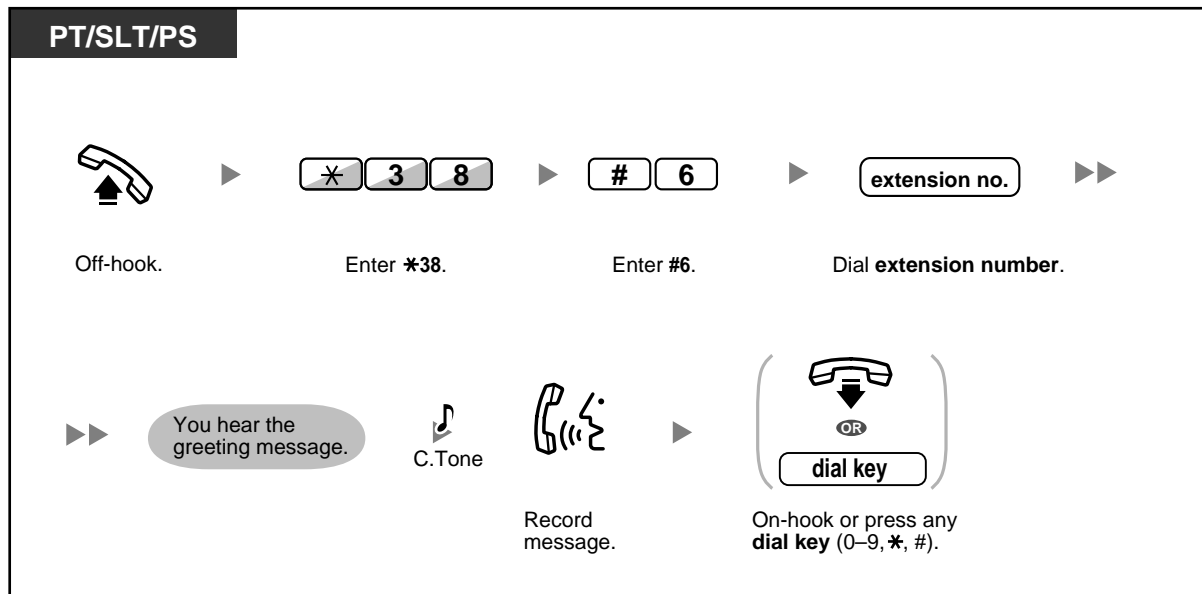

- Voice message recording will stop, you will hear a notification tone, and the call will be disconnected, in the following cases:
 - the recording time for the voice message reaches the preprogrammed limit. (default: 120 seconds)
 - the recording space for the SVM feature reaches the limit.



- When you are on the phone, you can transfer the call directly to the message box of a desired extension by placing the call on hold temporarily, then pressing *38 + #6 + the desired extension number. This allows the caller to leave a voice message in the message box of the desired extension.

◆◆ Listening to Voice Messages Left by Callers

When a caller leaves a voice message, information about that caller is also recorded as the SVM Log. The SVM Log can be viewed using the display of a PT or PS by pressing the Message button.

To listen to voice messages

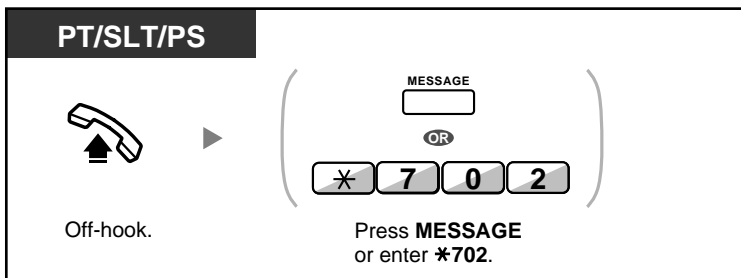
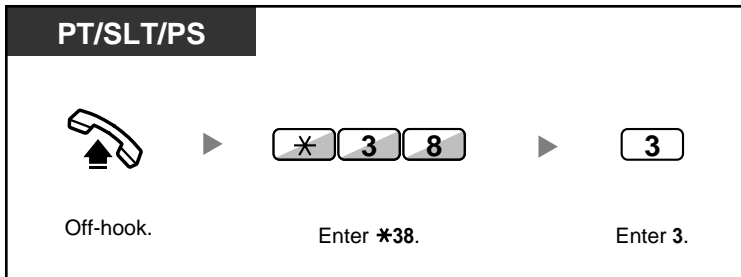
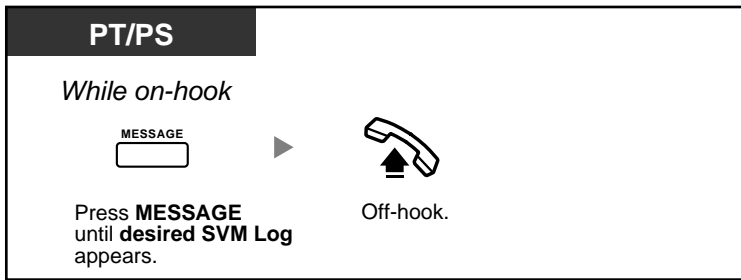

To clear the voice message that you are listening to

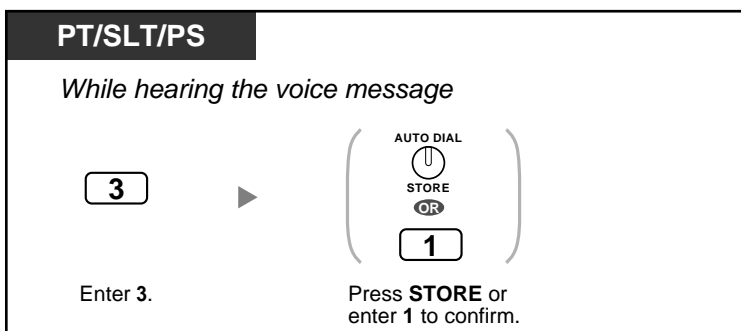

- Various operations are available by entering numbers while you are listening to a recorded voice message using any of the methods described above. The available options are as follows:

Operation No.	Operation
1 / # *	To play back the voice message from the beginning
2	To go to the next voice message

Operation No.	Operation
3	To clear the voice message (Press the AUTO DIAL/STORE button or enter 1 to confirm.)
4	To call back the caller who left the voice message
5	To go back to the previous voice message
# 6	To leave a voice message directly in the message box of another extension (Enter desired extension number.)
# 8	To play back your greeting message and record a voice message in your own message box
# 9	To end the call

- In addition to the caller information that is recorded in the Call Log, the following SVM Log information is recorded with voice messages left by callers:
 - Caller's Name
 - Caller's Telephone Number
 - Time recording started
 - Voice Message Status
 - "New" is displayed for voice messages that have not previously been listened to.
 - "Old" is displayed for voice messages that have previously been listened to.

Please note that the information shown on the display may vary depending on the information that was received and the type of telephone used. Only users of a 6-line display PT can view all of the above information.
- You can lock the SVM Log display by using an extension PIN (Personal Identification Number) to prevent other users from viewing the information and from playing back your voice messages (Display Lock). Refer to "3.1.2 Personal Programming".
- If your telephone has a Message for Another Extension button, you can access the message box of another extension and listen to voice messages for that extension.
- If a new voice message has been left in your message box, you will hear dial tone 4 after going off-hook. In addition, if your telephone has a Message button or Message/Ringer Lamp, the corresponding button or lamp will light when a voice message has been left.

Dial Tone 4



To listen to voice messages while your display is locked

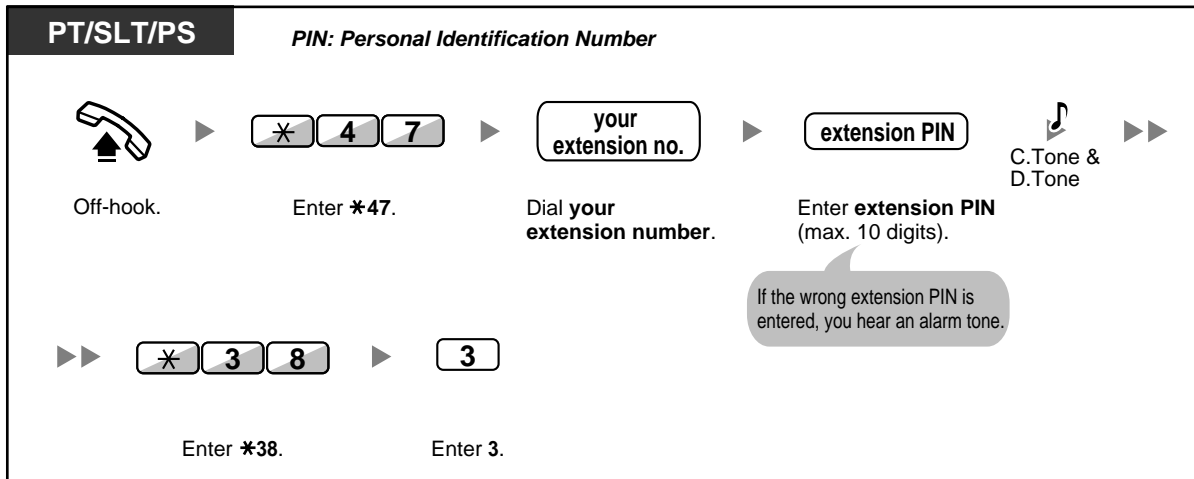

- When you press the Message button while on-hook to play back voice messages, Display Lock is temporarily deactivated.

To clear voice messages from the SVM Log

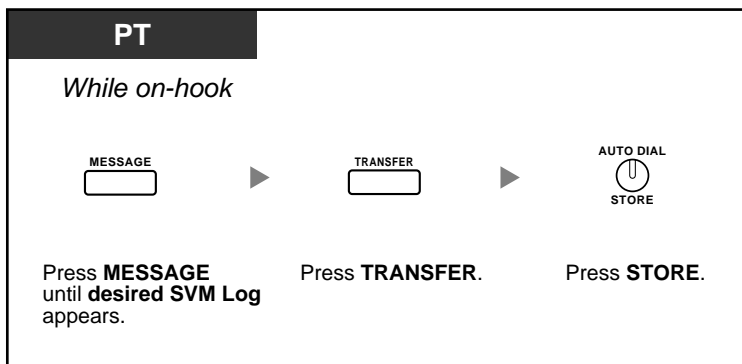

◆◆ Accessing Your Message Box from an Outside Telephone

You can remotely access your message box and perform any operations of the SVM feature through a CO line as if you were at your own extension.

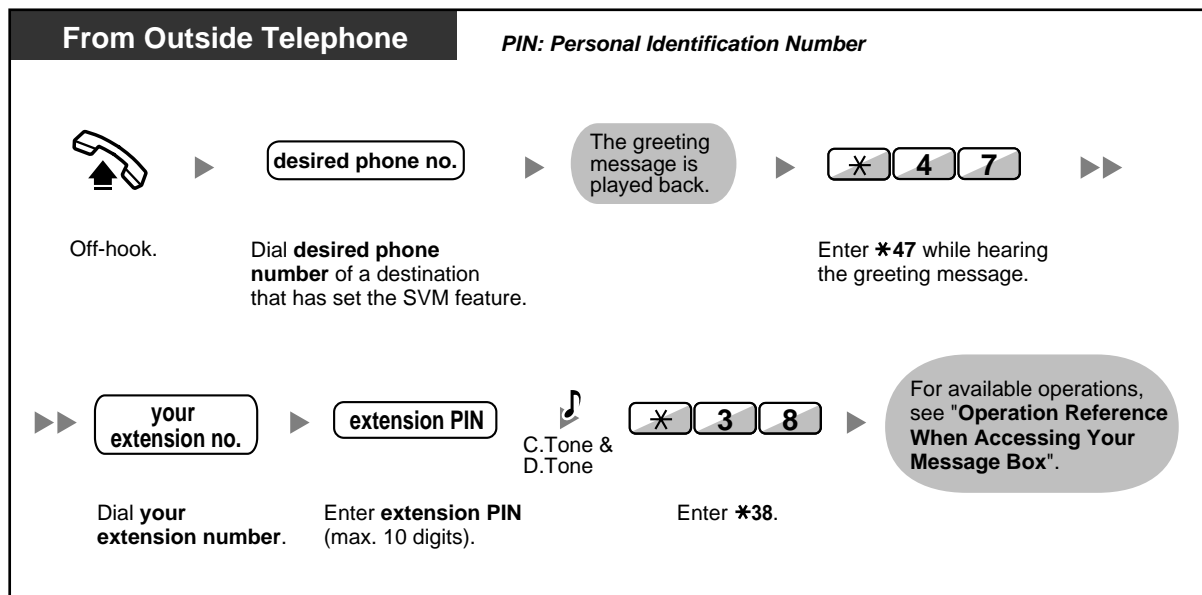

- If you hear a reorder tone when you try to leave a voice message directly in the message box of another extension, that message box is unavailable. You can enter another extension number by pressing "*".
- When accessing your message box from an outside telephone, you cannot call back callers who have left voice messages by pressing 4 while hearing the voice message.

To listen to voice messages left in the message box of another extension

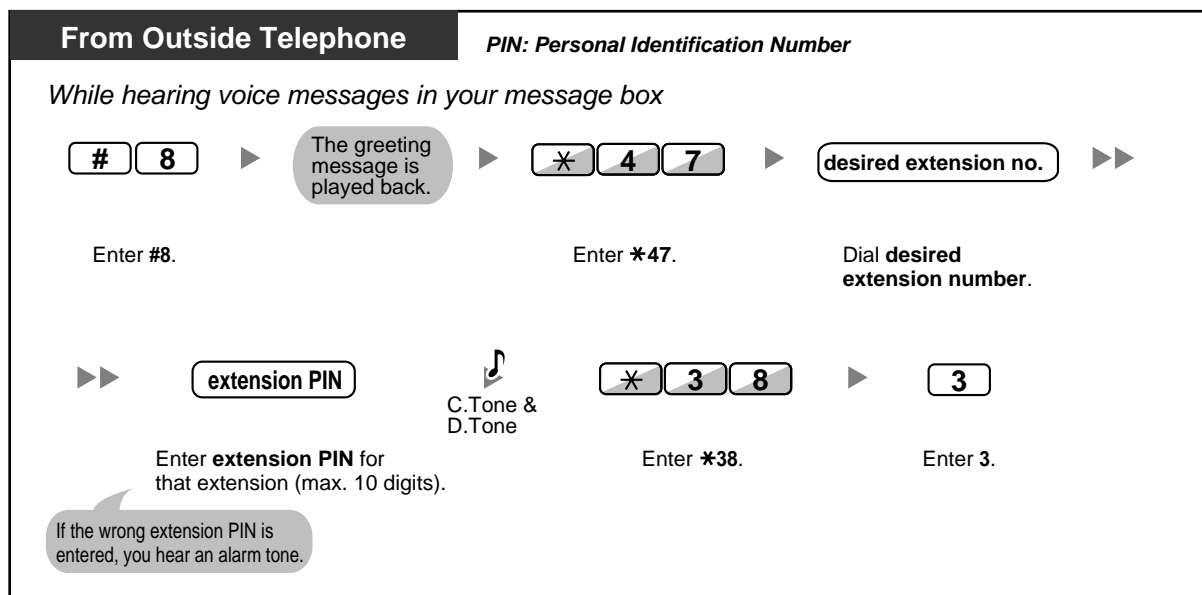

◆◆ Accessing the Message Box of Another Extension from Your Extension

You can access the message box of another extension (for example, to record a greeting message for that extension) by following the steps below:

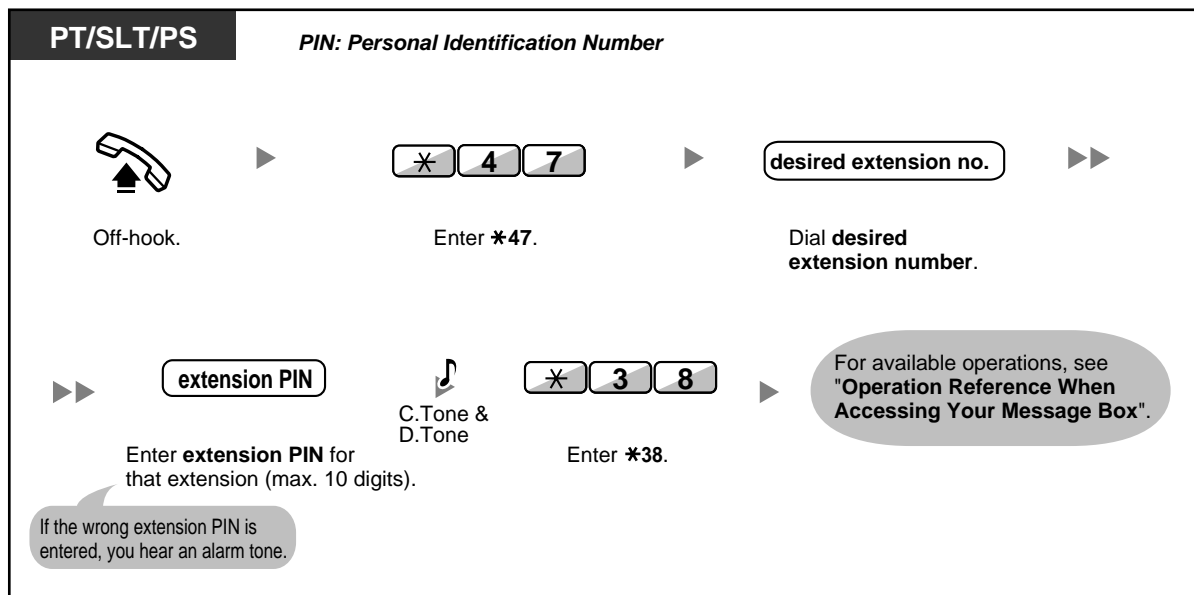

1.3.65 TAFAS (Trunk Answer From Any Station)

You can be notified of incoming outside calls through an external speaker. These calls can be answered from any extension.

Through an external speaker

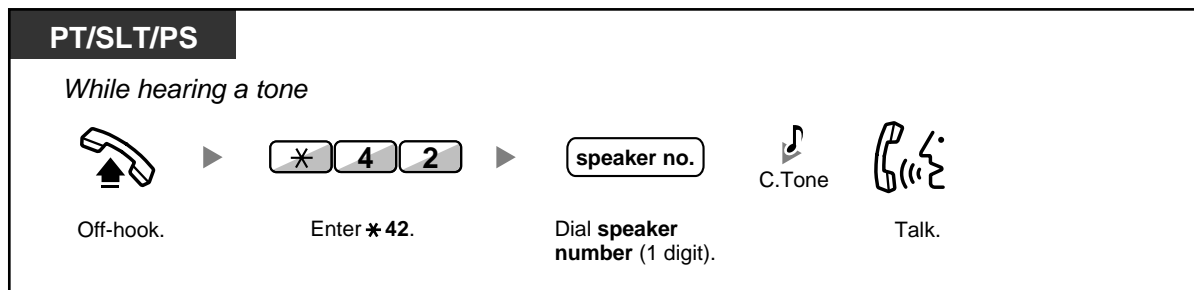

- You can also receive a paging announcement via a speaker with this operation.

1.3.66 Timed Reminder

You can set an alarm at your telephone as a reminder of a meeting or appointment. The alarm can occur either once or daily (every day until canceled) at a preset time. When you go off-hook to answer, you will hear a special dial tone or prerecorded message.



- This feature can also be set remotely by an extension assigned as a hotel operator (Remote Wake-up Call). The most recent setting will be valid no matter which extension made the setting. For information about setting a Remote Wake-up Call, refer to "1.3.73 Wake-up Call".

To set

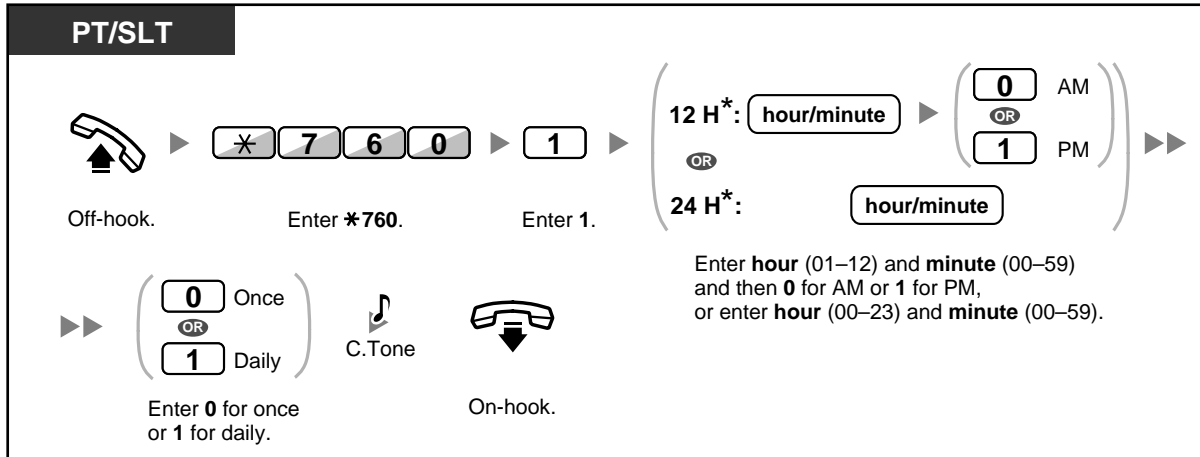

- * Enter the time in the format assigned to your PBX (12-hour or 24-hour).

To cancel

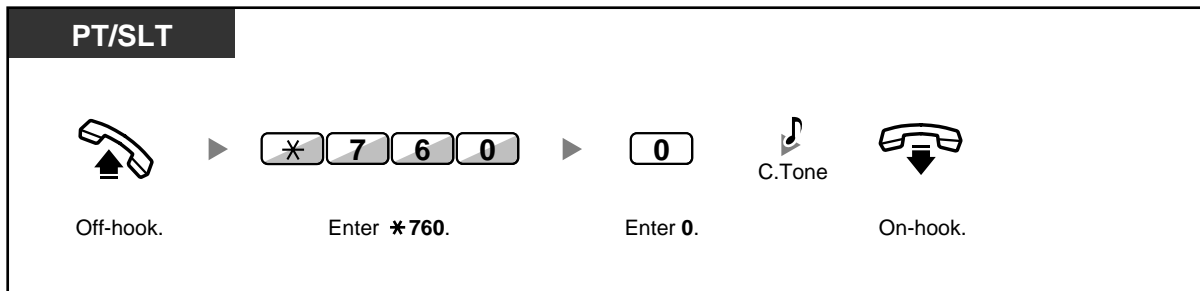

To stop or answer the ringback

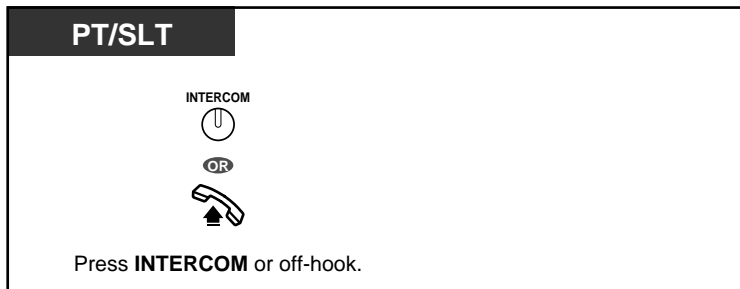

To confirm



- You can also confirm the timed reminder by using the soft button.
- The alarm keeps ringing for preprogrammed seconds.
- **If you receive an incoming call during ringback**, the ringing starts after the ringback stops.
- **If you are having a conversation exceeding alarm ringing period**, the ringback will start after your conversation.

1.3.67 Time Service

You can check the current status of the Time Service on the display.

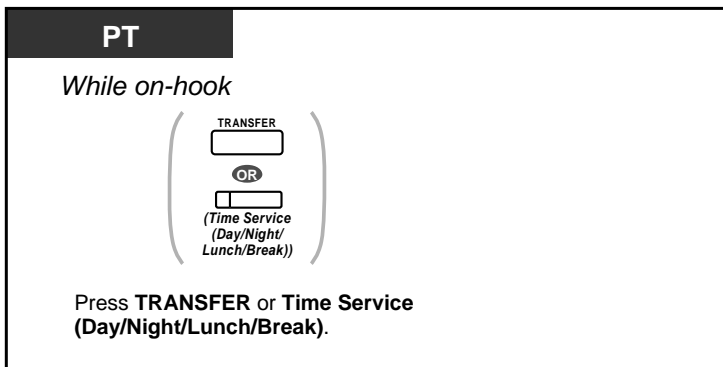

- The Time Service (Day/Night/Lunch/Break) button light always shows the current status as follows:
 - Off:** Day mode
 - Green on:** Lunch mode
 - Flashing green:** Break mode
 - Red on:** Night mode
 - Flashing red:** Holiday mode
- Any extension user except the managers can check the current status by pressing the Time Service (Day/Night/Lunch/Break) button.



Customizing Your Phone

- 3.1.4 Customizing the Buttons
 - Create or edit a Time Service (Day/Night/Lunch/Break) button.

1.3.68 Verification Code Entry

You can use your calling privileges (Class of Service) at another extension. You can override restrictions which have been set at that extension. To use this feature, a verification code and verification code PIN (Personal Identification Number) are required.

To call

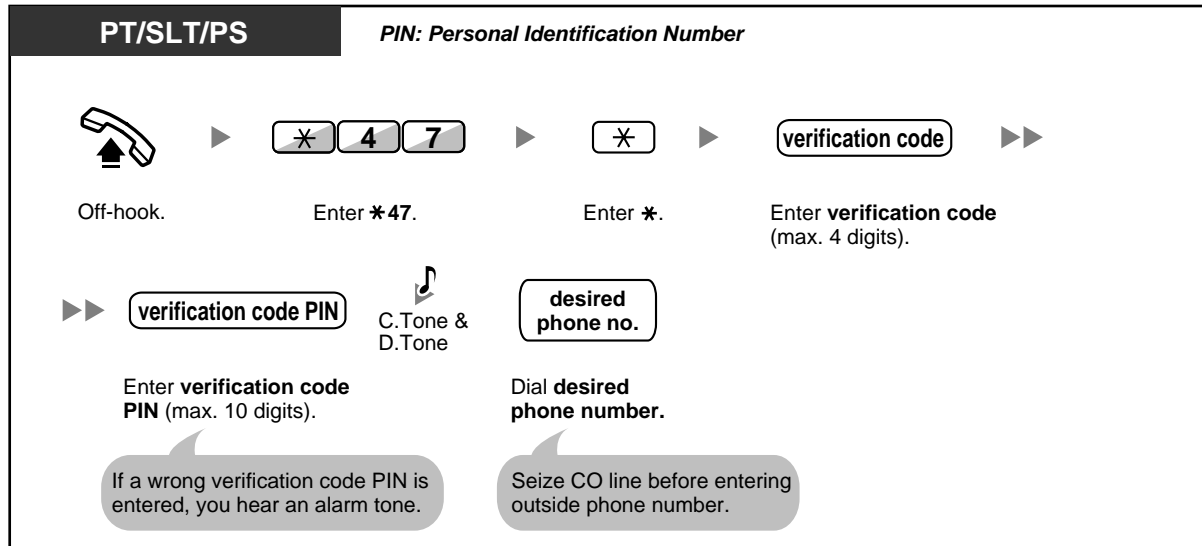

1.3.69 VOICE MAIL FEATURES

The following services are available using a Voice Processing System:

Features	Description
Voice Mail Integration	You or an outside party can access the Voice Processing System from a telephone. (→ 1.3.72 Voice Mail Features—Voice Mail Integration)
Live Call Screening (LCS)	Using a Panasonic Voice Processing system that supports digital integration (e.g., KX-TVA series), you can monitor a call without answering while the caller is leaving a message in your mailbox. (→ 1.3.70 Voice Mail Features—LCS (Live Call Screening))
Two-way Record	Using a Panasonic Voice Processing system that supports digital integration (e.g., KX-TVA series), you can record a conversation into a mailbox while talking on the phone. (→ 1.3.71 Voice Mail Features—Two-way Record)



- Voice Processing System features are not available for SIP Extension users. However, a KX-HGT100 user can use some of the Voice Processing System features. Refer to the Quick Reference Guide of the KX-HGT100 for details about available features.

1.3.70 Voice Mail Features—LCS (Live Call Screening)

Using a Panasonic Voice Processing system that supports digital integration (e.g., KX-TVA series), you can monitor a call without answering while the caller is leaving a message in your mailbox. If you so desire, you can answer the call while monitoring. There are two methods available as follows:



Hands-free mode (Default):

You can monitor the message automatically, live through the telephone speaker.

Private mode:

You will hear an alarm tone while the caller is leaving a message.

Before operating

- Create a Live Call Screening (LCS) button (Personal Programming).
- Select the mode, either Hands-free or Private (Personal Programming).
- Set the extension PIN (Personal Identification Number).
- Set the Live Call Screening feature.

To set Live Call Screening

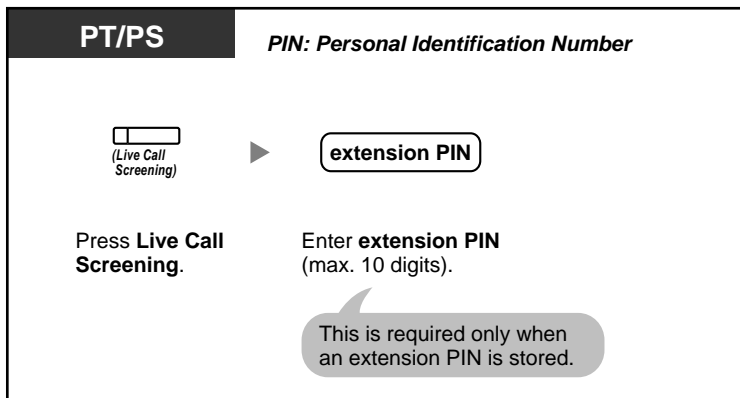

To cancel Live Call Screening

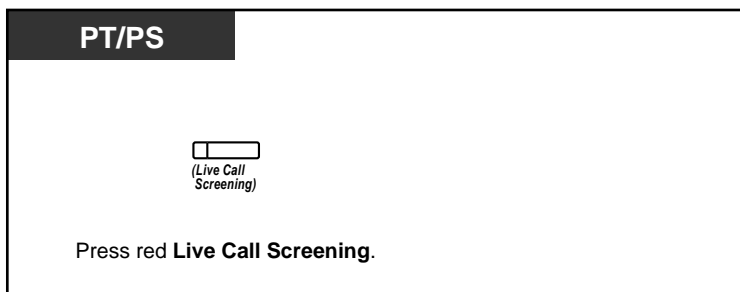

Operation Flowchart

The operations in the shaded areas can be done hands-free.

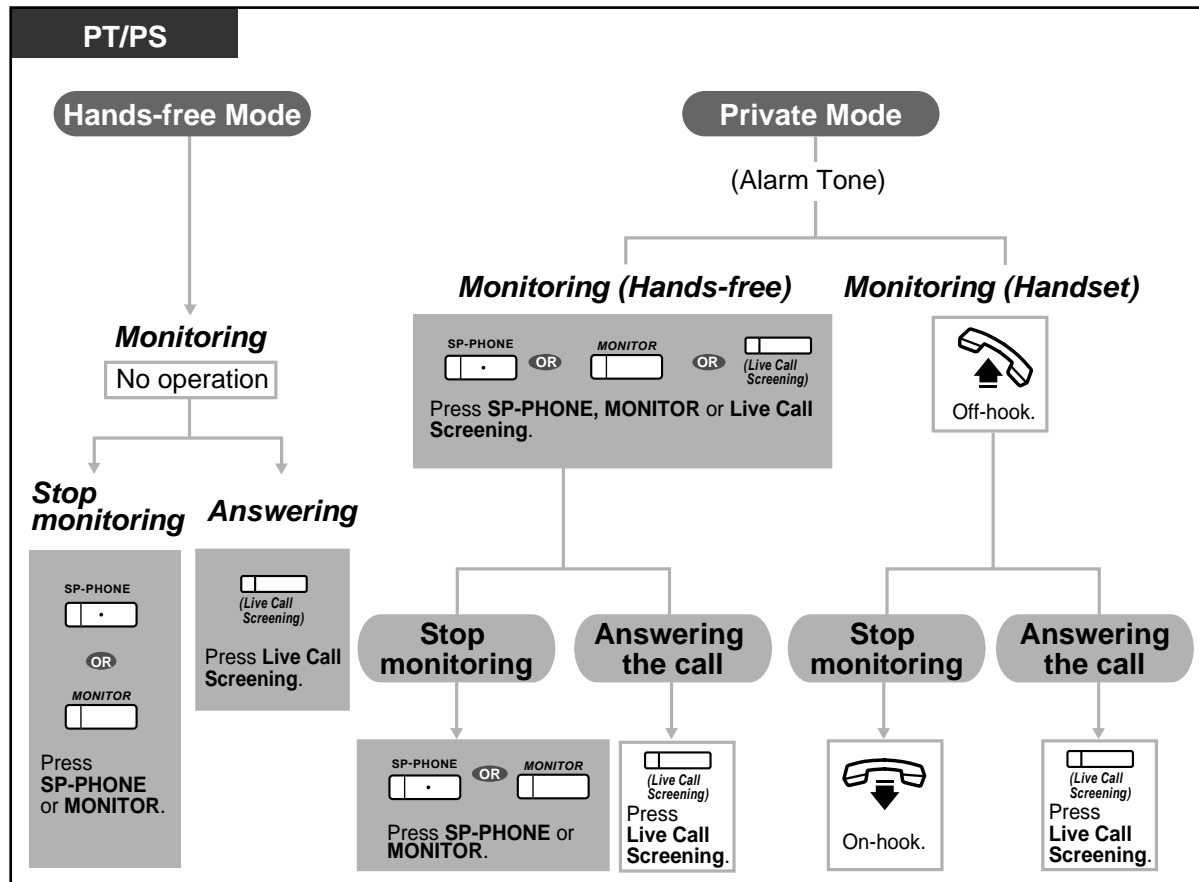

- The Live Call Screening (LCS) button light shows the feature status as follows:
 - Off:** LCS is off.
 - Flashing green rapidly:** Alerting in the Private mode.
 - Flashing green slowly:** Monitoring.
 - Red on:** LCS is on.
- The manager extension can clear an extension PIN.
- This feature is available for a single line telephone if it is connected to a proprietary telephone in parallel. (Private mode only)
To answer the call while monitoring, press Recall/hookswitch.
- Only the handset monitoring in the Private mode is available for PS users.



- For information about other Voice Mail features, refer to "1.3.69 VOICE MAIL FEATURES".



Customizing Your Phone

- 3.1.2 Personal Programming—**Live Call Screening Mode Set**
Select the mode, either monitoring the message through the speaker automatically or receiving, while the caller leaves a message.
- 3.1.4 Customizing the Buttons
Create or edit a Live Call Screening (LCS) button.

1.3.71 Voice Mail Features—Two-way Record

Using a Panasonic Voice Processing system that supports digital integration (e.g., KX-TVA series), you can record a conversation into a mailbox while talking on the phone. You can select the mailbox each time you record a conversation.



To record into your mailbox

PT/PS

During a conversation



(Two-way Record)

To stop recording, press this button again.

Press **Two-way Record**.

To record into another mailbox (Two-way Transfer)

PT/PS

During a conversation



(Two-way Transfer)

▶



(DSS)

OR

another extension no.

Press **Two-way Transfer**.

Press **DSS** or enter **another extension number**.

To stop recording, press this button again.

To record into another mailbox with one touch (One-touch Two-way Transfer)

PT/PS

During a conversation



(One-touch Two-way Transfer)

Press **One-touch Two-way Transfer**.



- The Two-way Record button light, Two-way Transfer button light or One-touch Two-way Transfer button light shows the current status as follows:
Off: Not recording.
On: Recording the conversation.



- **Note:**
Many states have imposed regulations on the manner in which 2-way telephone conversations may be recorded, so you should inform the other party that the conversation is being recorded. Consult your local telephone company for further information.
- For information about other Voice Mail features, refer to "1.3.69 VOICE MAIL FEATURES".



Customizing Your Phone

- 3.1.4 Customizing the Buttons
Create or edit a Two-way Record button, a Two-way Transfer button and a One-touch Two-way Transfer button.

1.3.72 Voice Mail Features—Voice Mail Integration

If you cannot answer calls, you can forward them to your mailbox. You can select the type of incoming calls (Intercom Calls/Outside Calls/Both Calls). If your telephone has a Message button, the Message light turns on and lets you know you have messages. Even if a Message button is not provided, you will hear an indication tone* when going off-hook.

You can also transfer received outside calls to a mailbox so that calling parties can leave messages. If you create a Voice Mail Transfer button on your phone, the transfer is done without knowing the mailbox number (**Voice Mail Transfer**).

The duration for recording depends on the voice processing system.

To forward your calls to your mailbox

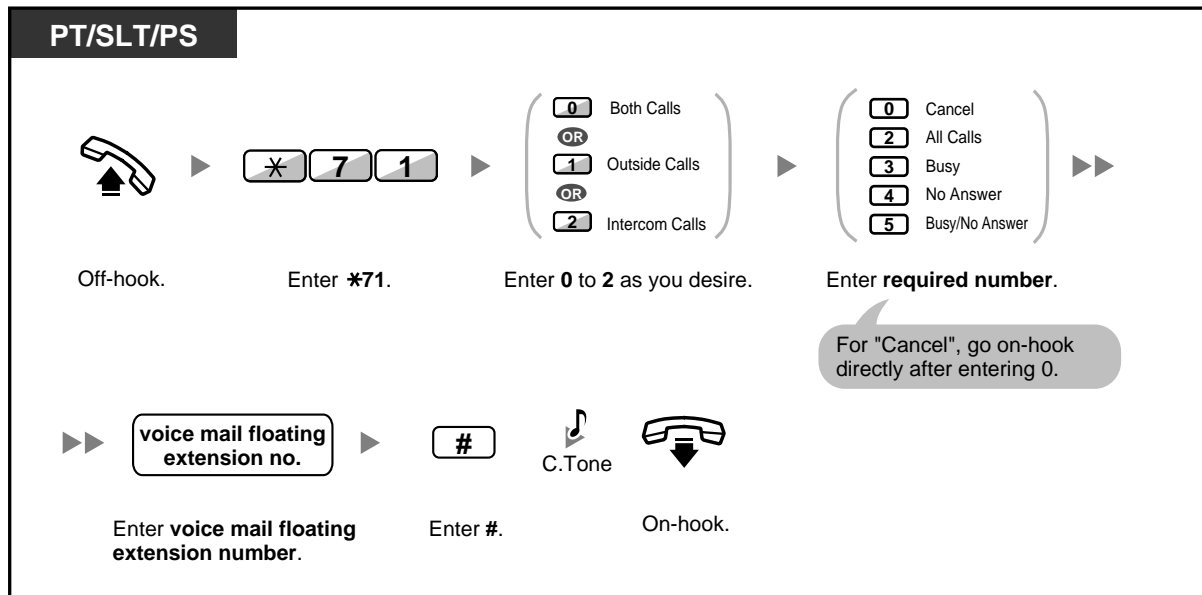

To transfer a call to a mailbox (Voice Mail Transfer)

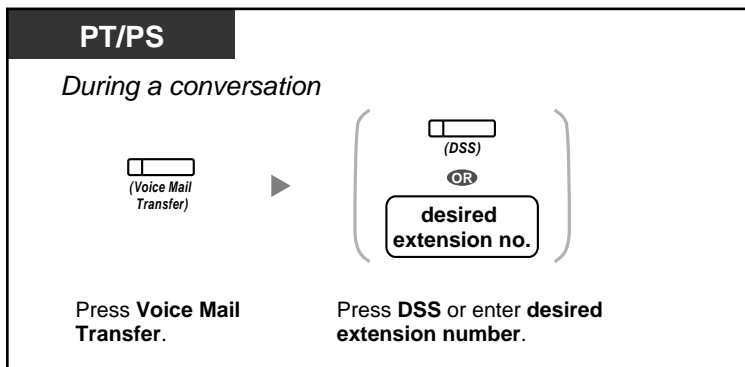

To listen to messages

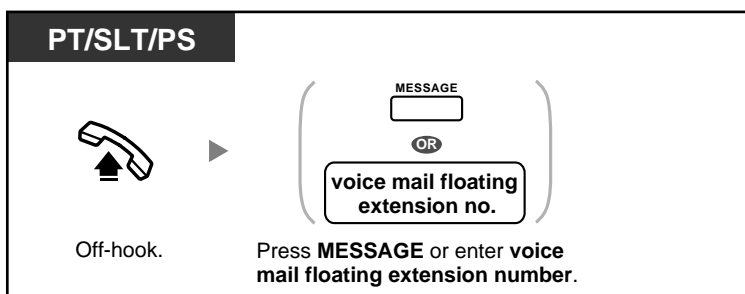

* Indication tone after going off-hook.



- You can access a voice mail with one-touch.



- The default voice mail floating extension number is 500.
- For information about other Voice Mail features, refer to "1.3.69 VOICE MAIL FEATURES".



Customizing Your Phone

- 3.1.4 Customizing the Buttons
Create or edit a Voice Mail Transfer button or a Message button.

1.3.73 Wake-up Call

In a hotel-type environment, an extension assigned as a hotel operator can remotely set or cancel a timed reminder to a room extension (Remote Wake-up Call). This allows guests to request wake-up calls without having to program the extension themselves. The hotel operator can also confirm the current timed reminder setting for a room extension.





- This feature can also be set from a room extension (Timed Reminder). The most recent setting will be valid no matter which extension made the setting. For information about setting a Timed Reminder, refer to "1.3.66 Timed Reminder".

To set

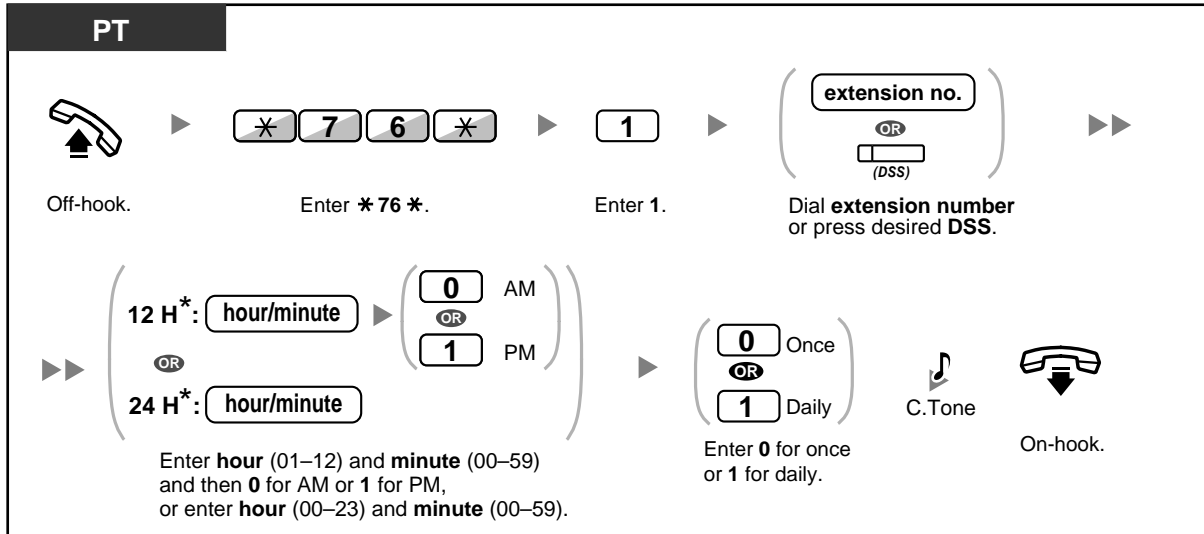

- * Enter the time in the format assigned to your PBX (12-hour or 24-hour).

To cancel

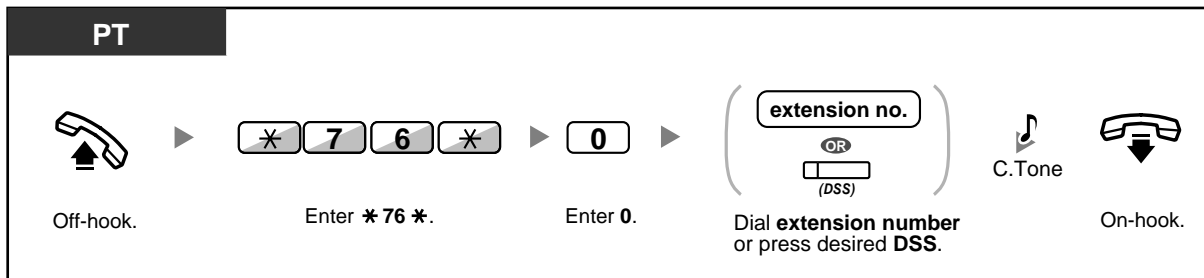

To confirm

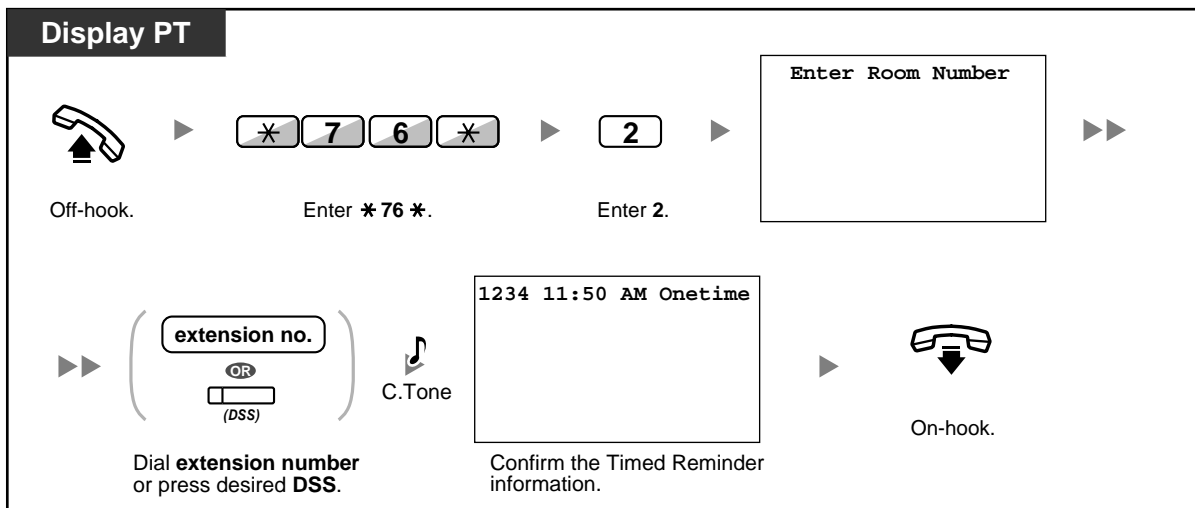

- When a timed reminder starts, and when it is answered or not answered, detailed timed reminder information is recorded automatically. This requires system programming.
<Example>

Date	Time	Ext	CO	Dial Number
02/02/00	02:45PM	1234		Timed Reminder/Start
02/02/00	02:46PM	1234		Timed Reminder/No Answer
02/02/00	02:47PM	1234		Timed Reminder/Answer



- Users of PTs without displays can confirm only whether a timed reminder has been set or not by following the steps shown above. If set, a confirmation tone will be heard.
- For information about other Hospitality features, refer to "1.3.33 HOSPITALITY FEATURES".

1.3.74 Walking COS

You can use your calling privileges (Class of Service) at another extension. You can override restrictions which have been set at that extension. To use this feature, an original extension number and an extension PIN (Personal Identification Number) are required.

After performing the Walking COS feature, you can set the following features on your telephone from another extension or through DISA.

- Call Forwarding (FWD)/Do Not Disturb (DND)
- Changing the Log-in/Log-out Status of Extensions
- Absent Message
- Extension Dial Lock
- Time Service—Changing the Time Mode (Day/Night/Lunch/Break)

To make a call or set features from another extension

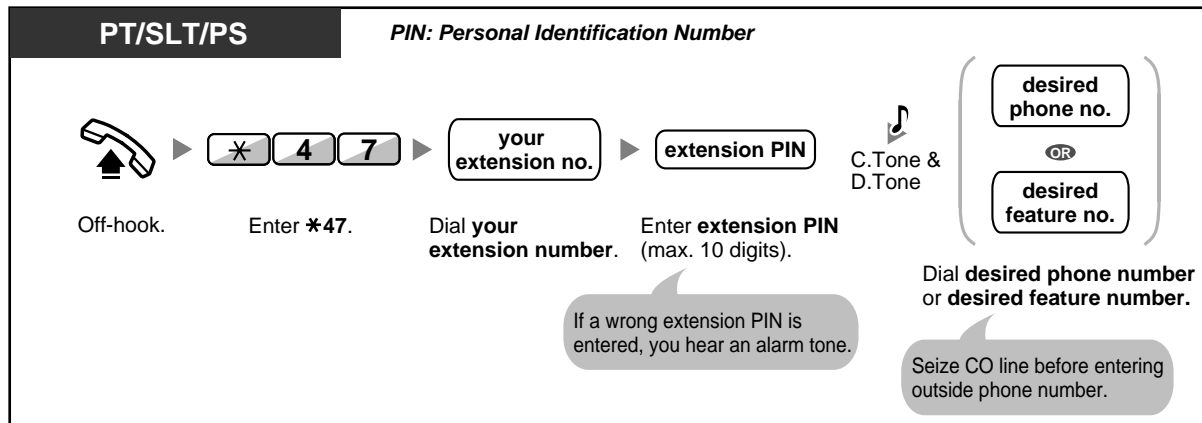

To make a call or set features through DISA

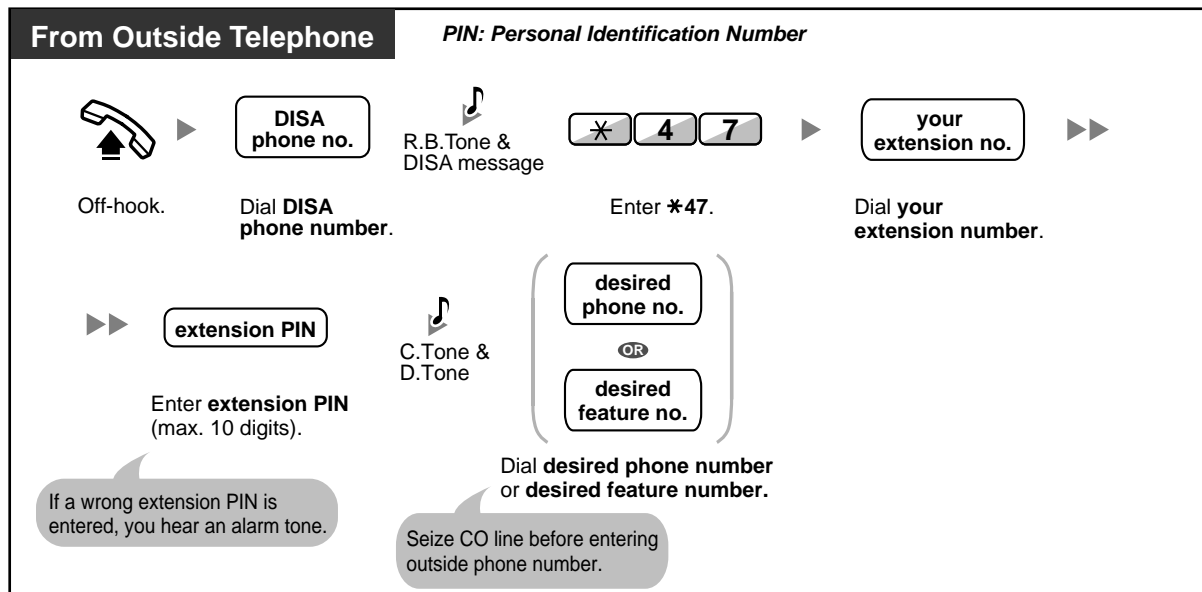

1.3.75 Walking Extension

You can exchange the settings set at another extension with your own settings. This allows you to use your own settings, including your extension number, on another person's extension. Settings such as extension number and One-touch Dialing memory are available at the new extension. It is also possible to exchange the DSS Console settings along with the extension settings. Walking Extension is useful, for example, when you move to a new location in the office.

This feature is also known as Walking Station.

To exchange your settings with another extension

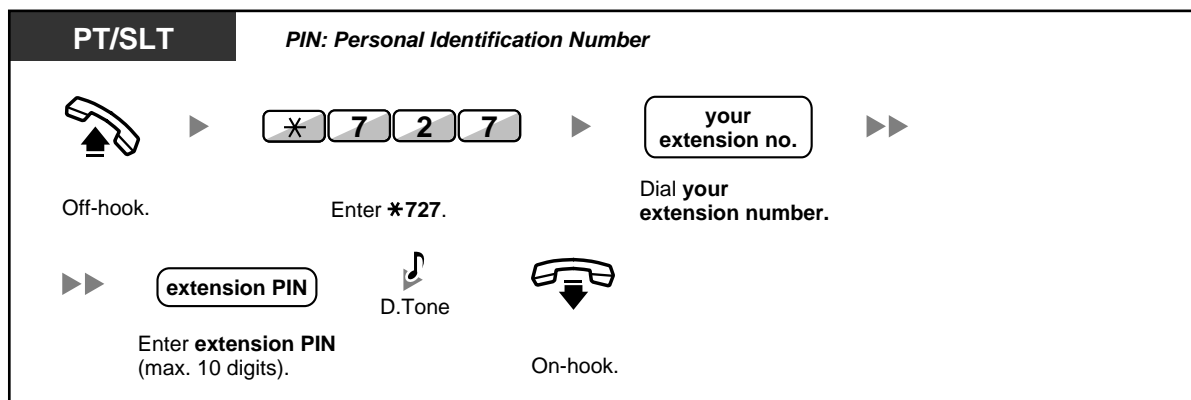

- An extension personal identification number (PIN) is required to use this feature. Refer to "1.3.26 Extension PIN (Personal Identification Number)".
- Your previous extension will receive the old settings of your new extension.
- Extension settings can be exchanged between SLT and SLT, PT and PT, or SLT and PT.
- If you are using a KX-NT300 series (except KX-NT321)/KX-DT343/KX-DT346 telephone with a Bluetooth wireless headset, and exchange the settings with another KX-NT300 series (except KX-NT321)/KX-DT343/KX-DT346 telephone user, you cannot use your Bluetooth wireless headset at the other extension.
Bluetooth wireless headsets are registered on extensions themselves. Therefore, you have to register a Bluetooth wireless headset on each desired extension. For details about registration, refer to "Bluetooth Registration" in "3.1.2 Personal Programming".

1.3.76 Walking Extension, Enhanced

In addition to exchanging the settings between extensions (Walking Extension), you can change the status of your extension to "Service-in" or "Service-out" (Enhanced Walking Extension).

Service-in: An extension is in use (normal status).

Service-out: Extension Dial Lock (→ 1.3.24 Extension Dial Lock) and Do Not Disturb (DND) (→ 1.3.19 DND (Do Not Disturb)) are activated on an extension, and the extension user cannot make unauthorized outside calls nor receive calls.

This feature is useful when:

- one person uses the same extension settings at different locations, such as another branch office or at home
- two or more people use the same telephone in turn

<Example (a)> When using extension settings at a different location

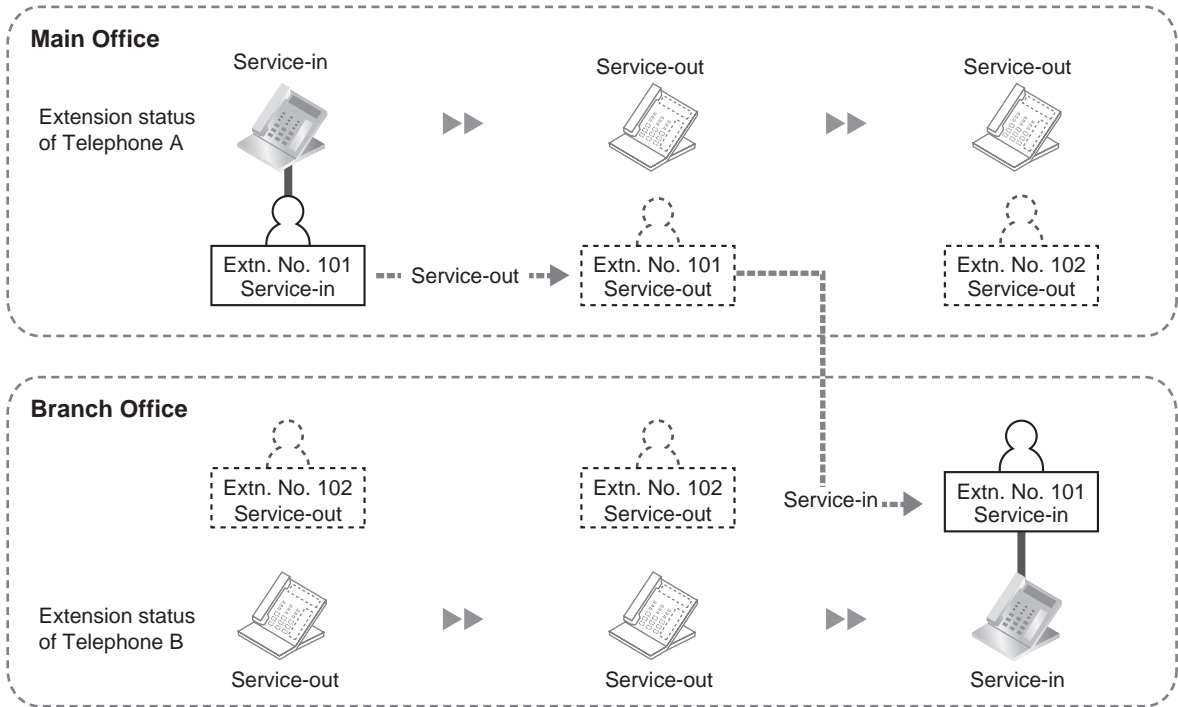

In this example, extension user A sets his/her own extension status to "Service-out" at the main office. Then, he/she can set another extension status to "Service-in" at the branch office to have his/her own extension settings available at the extension.

<Example (b)> When two users share one telephone

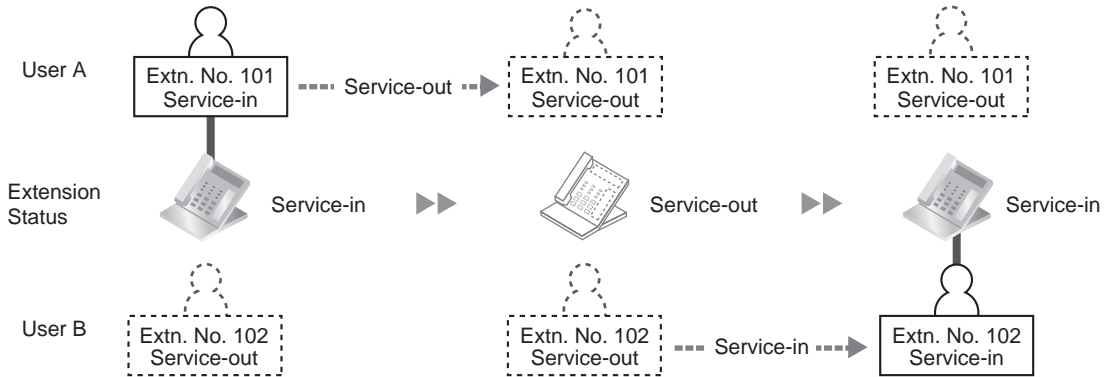

In this example, extension users A and B work in shifts and use the same extension in turn. User A sets the extension status to "Service-out" when he/she finishes work. Then, user B can set the extension status to "Service-in" and have his/her own settings available at the extension.

To set an extension to Service-out status

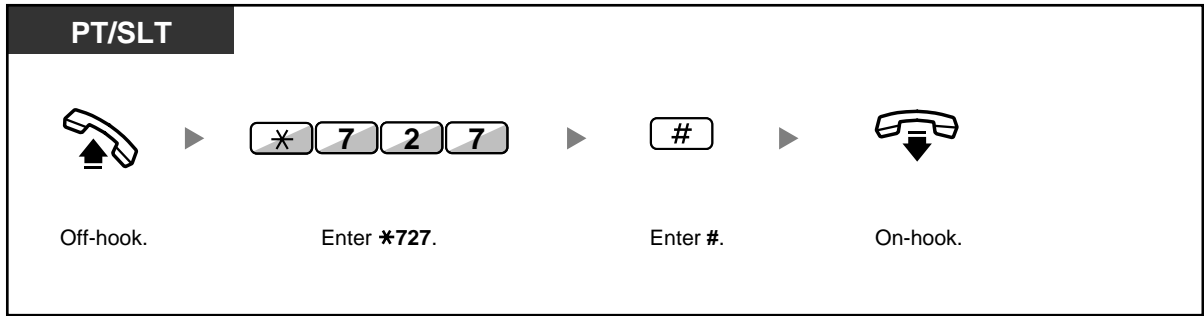

To set an extension to Service-in status and have your own settings available

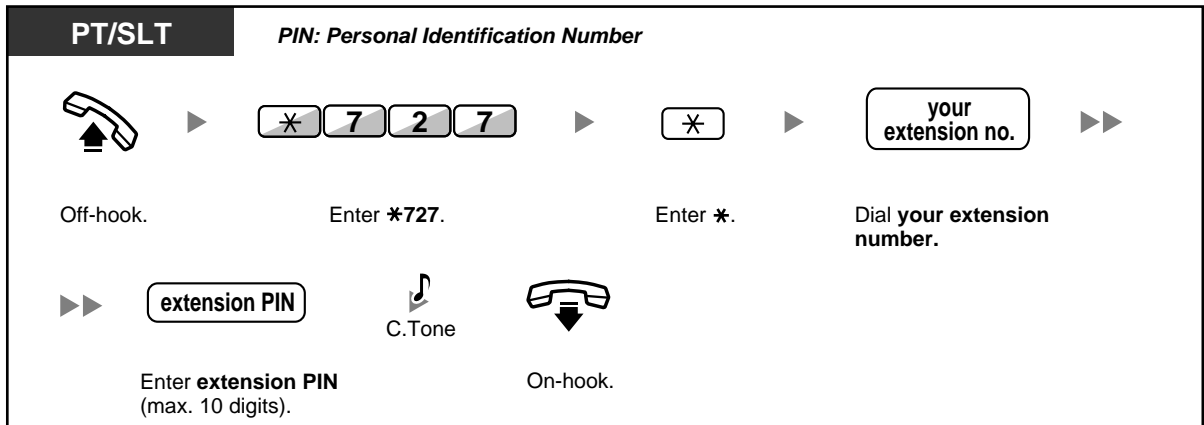

- An extension personal identification number (PIN) is required to use this feature. Refer to "1.3.26 Extension PIN (Personal Identification Number)".
- Extension settings can be exchanged between SLT and SLT, PT and PT, or SLT and PT.

1.3.77 Whisper OHCA

During a conversation, you can be informed of a waiting call with a voice announcement. You cannot talk to the caller, but you can hear the caller speaking through the handset.

To set/cancel for intercom calls (Manual Call Waiting)

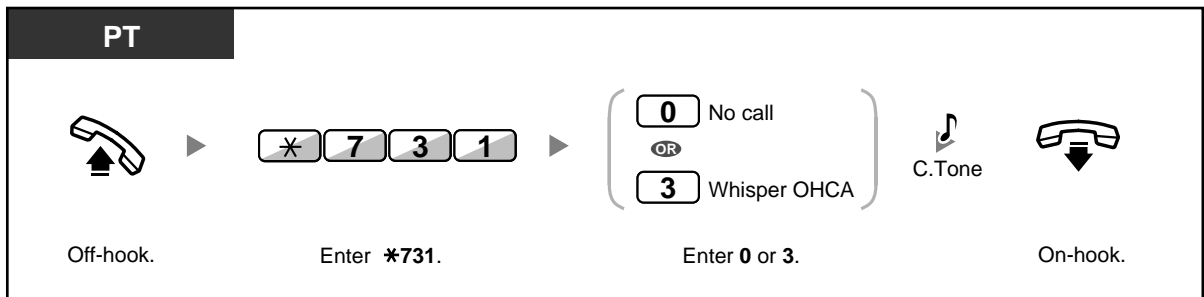



- Whisper OHCA is only available with certain digital proprietary telephones and IP proprietary telephones. In addition, both you and the other party must use supported telephones.
- Whisper OHCA is not available for outside calls; only call waiting tone can be set (refer to "1.3.13 Call Waiting Tone").
- A PDN extension can only receive OHCA or Whisper OHCA from the corresponding SDN extension. When a call is made from another extension, a PDN extension will receive a call waiting tone. (→ 1.3.49 PDN (Primary Directory Number)/SDN (Secondary Directory Number) Extension)



- For information about answering a waiting call, refer to "1.3.12 CALL WAITING FEATURES".

1.3.78 Wireless XDP Parallel Mode

Your PS can be used in parallel with a PT or SLT.

When in this mode, incoming calls to a wired telephone also ring the paired PS.



To set

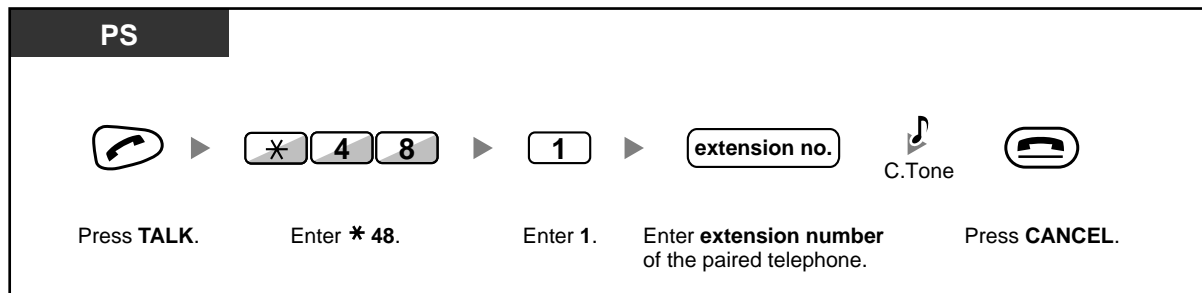

To cancel

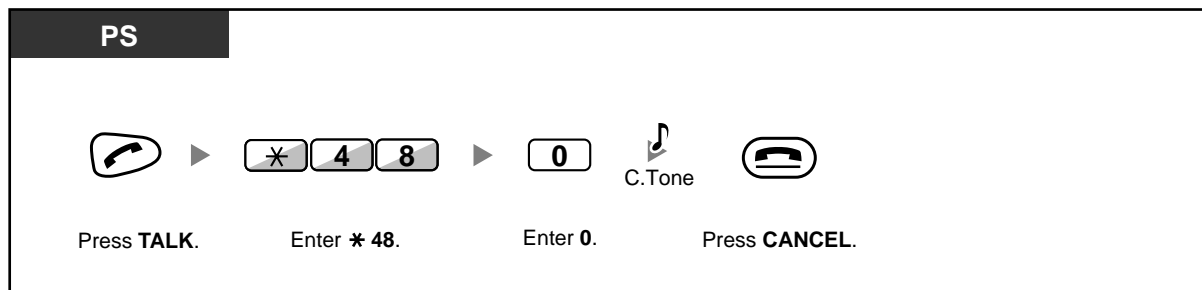

- Some wired telephones are prohibited from using this feature.
- If you go off-hook while your paralleled telephone is in use**, the call will switch over to you.

1.4 Display Features

1.4.1 Call Log, Incoming

When you receive an outside call or an external sensor call, call information is recorded automatically in the incoming call log. A preprogrammed number of calls can be logged per extension. When the call log is full and other call arrives, the oldest call is deleted.

You can modify the logged telephone number using the display proprietary telephone or the portable station. When the Call Log button light turns on, there is a call which you did not answer.

The following information is logged.

Telephone Information	KX-T7636/KX-T7633/ KX-T7630/KX-T7433	3-line display PT except KX-T7633/KX-T7630/ KX-T7433	1-line or 2-line display PT
	KX-NT300 series (except KX-NT321)/KX-DT300 series (except KX-DT321)/KX-NT136		KX-NT321/KX-NT265/ KX-DT321
	KX-TD7695/KX-TD7685/ KX-TD7694/KX-TD7684/ KX-TD7690/KX-TD7680		Wireless phone (KX-TD7895)
	Wireless phone (KX-TD7896)		Wireless phone (KX-TD7895/KX-T7885)
	6-line display PT		
Caller's Name	✓	✓	✓
Date/Time call received	✓	✓	—
Answered or Not Answered	✓	✓	—
Confirmed or Not Confirmed			—
Caller's Phone Number	✓	—*1	—*1

*1 If the caller's name is not logged, the caller's phone number is displayed.
If the caller's name is logged, the caller's phone number is not displayed.

The incoming call log information is displayed as follows:

[With Caller's Name]

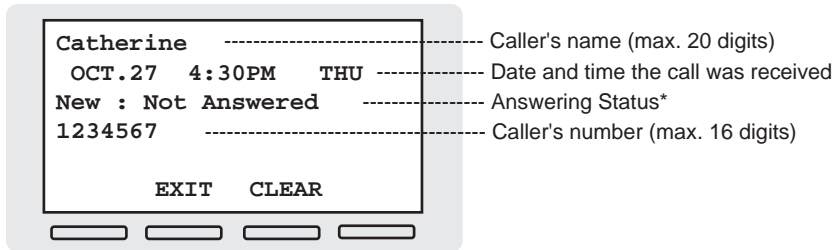

[Without Caller's Name]

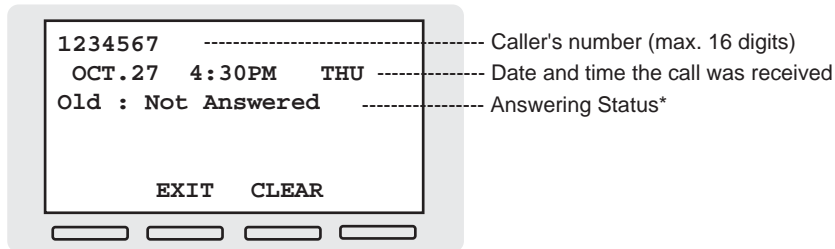

*: "New" is displayed for call logs which have not previously been viewed;
 "Old" is displayed for call logs which have previously been viewed.

To view the log information with the Call Log button

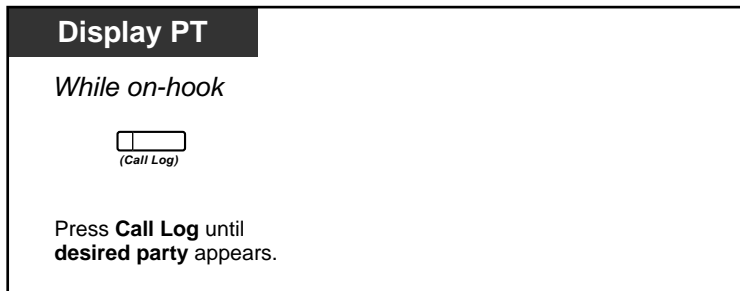

To view the log information with the Navigator key

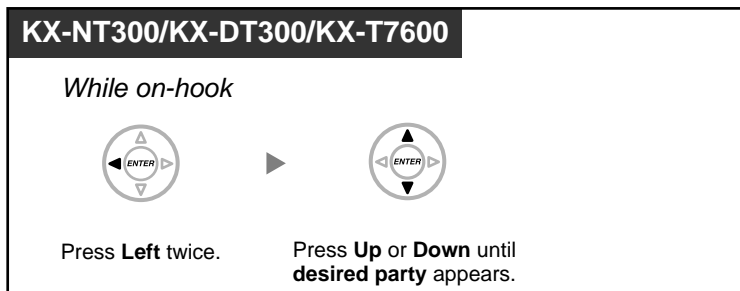

To clear the log information

Display PT

While viewing the log information

(Call Log)

OR

ENTER

▶

TRANSFER

Press **Call Log**, or **Up** or **Down** until **desired party** appears. Press **TRANSFER**.

To call

Display PT

While viewing the log information

(Call Log)

OR

ENTER

▶



Press **Call Log**, or **Up** or **Down** until **desired party** appears. Off-hook.



- The Call Log button light shows the current status as follows:
Off: No incoming call, or you have already viewed the call log.
Red on: You have missed calls to view.
- If your call is answered by another extension, the caller's information is recorded in the logs of both your extension and the answering extension.
- You can lock your call log display by using an extension PIN (Personal Identification Number), so that you can prohibit access to your logged information. Refer to "3.1.2 Personal Programming".
- You can also have a Call Log button for an ICD Group (Incoming Call Distribution Group).
- If a call arrives while you are using the call log, the call log display will be replaced with the caller's information.
- PS user: Refer to "Operating Instructions" for PS.
- Caller information received with a call waiting tone from the telephone company will not be logged in the call log.



Customizing Your Phone

- 3.1.4 Customizing the Buttons
 Create or edit a Call Log button or Call Log for ICD Group button.

1.4.2 Call Log, Outgoing

You can redial using the outgoing call log.

To call

KX-NT300/KX-DT300/KX-T7600

While on-hook



Press **Left**. Press **Up** or **Down** until **desired number** appears. Off-hook.

To call with the REDIAL button

Display PT

While on-hook

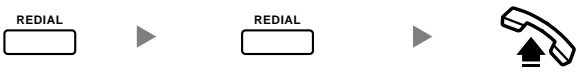

Press **REDIAL** to display the outgoing call log.* Press **REDIAL** until **desired number** appears. Off-hook.



- * System programming is required for this operation.
- This operation is available only for digital proprietary telephones with a display.

To store the caller's information in personal speed dialing

Display PT

When the desired party is displayed



Press **STORE**.

<Operation Example: Storing the caller's information in personal speed dialing>

[Initial Display]

OCT.27 03:13PM THU

PROG INFO RING MENU

1 Press 

Outgoing Call Log

EXIT ENTER

2 Press  until desired number is selected.

1234567890
106
->12341115678
0001112223333
301

EXIT CLEAR ENTER

3 Press 

05:12341115678
Name?

ABCD EXIT CLEAR ENTER

4 Enter name.

05:12341115678
Ann

ABCD EXIT CLEAR ENTER

5 Press 

3 Press 

05:12341115678
Name?

ABCD EXIT CLEAR ENTER

4 Enter name.

05:12341115678
Ann

ABCD EXIT CLEAR ENTER

5 Press 

- You can lock your call log display by using an extension PIN (Personal Identification Number), so that you can prohibit access to your logged information. Refer to "3.1.2 Personal Programming".
- If a call arrives while you are using the call log, the call log display will be replaced with the caller's information.
- PS user: Refer to "Operating Instructions" for PS.

- To enter characters, refer to "1.3.14 Character Entry".

150 | Operating Manual

Document Version 2008-10

1.4.3 Directories

You can select and call using the directories (*Personal Speed Dialing Directory, System Speed Dialing Directory and Extension Number Directory*).

Only personal directories can be stored, edited or deleted on your extension.

If a call arrives while you are using a directory, the display will be replaced with the caller's information.

- ◆◆ Calling with the Directory
- ◆◆ Storing New Names and Numbers

◆◆ Calling with the Directory

To select and call

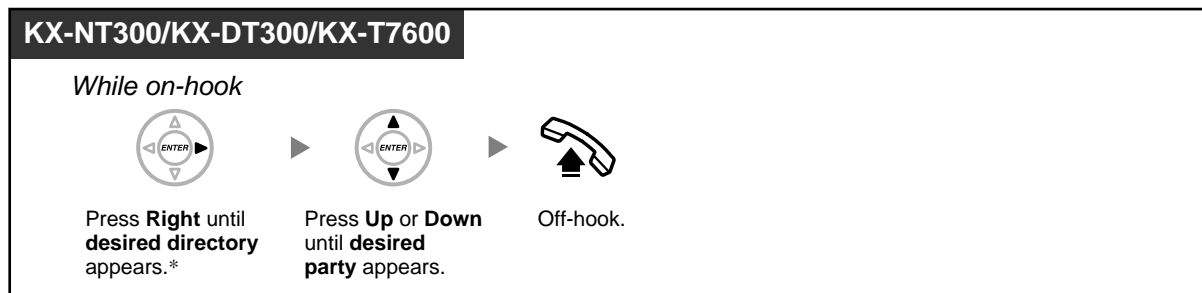

- * The display order is as follows:
One time: Personal Speed Dialing Directory
Two times: System Speed Dialing Directory
Three times: Extension Number Directory
- To cancel or exit, press the CANCEL or FLASH/RECALL button.
- You can lock your personal speed dialing directory by using an extension PIN (Personal Identification Number), so that you can prohibit access to it. Refer to "3.1.2 Personal Programming".



- Directory entries generally should include name and number. If the name is not registered, an entry cannot be displayed.
- The System Speed Dialing Directory can be displayed simply by pressing the AUTO DIAL button while on-hook.

◆◆ Storing New Names and Numbers

To store a Personal Speed Dialing Directory item

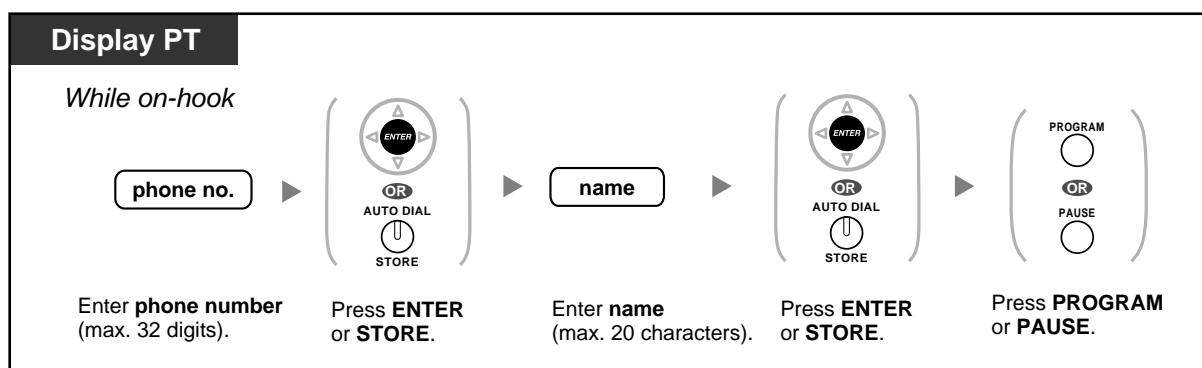

<Operation Example: Storing a name and an outside phone number in the Personal Speed Dialing Directory>

[Initial Display]

1 While on-hook, enter the **phone number** you want to store.

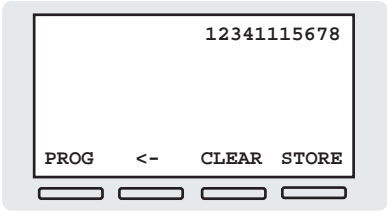

2 Press  to store.

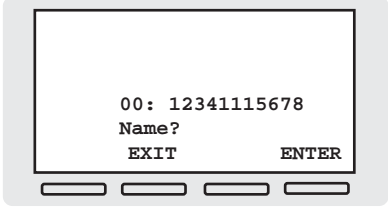

3 Enter the **name** to be displayed for the number.

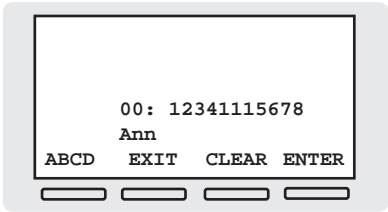

4 Press  to store.



- Telephone number and name on the display are stored using the first spare Personal Speed Dialing memory available.
- PS user: Refer to "Operating Instructions" for PS.



- To enter characters, refer to "1.3.14 Character Entry".
- For more details, refer to "To store the names and numbers in personal speed dialing" in "3.1.2 Personal Programming".

1.4.4 System Feature Access

You can access commonly used features with the "Feature Access" menu.

To select a feature from the "Feature Access" menu

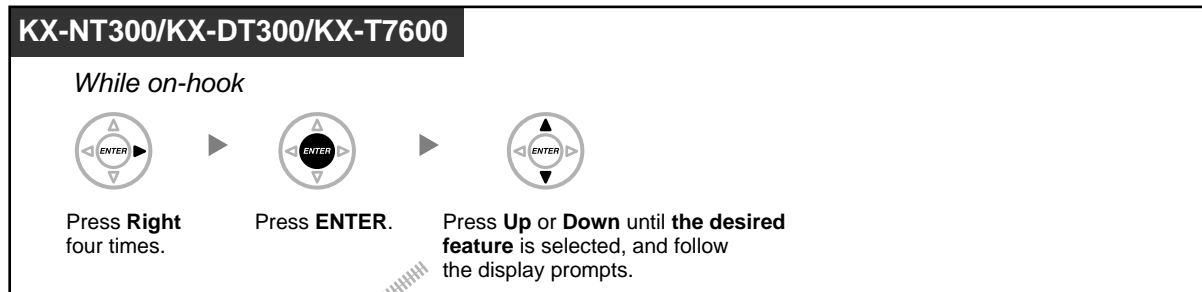

Features	Description
Call Back Cancel	You can cancel Automatic Callback Busy. (→ 1.3.4 Automatic Callback Busy (Camp-on))
Call Pickup Directed	You can pick up a call ringing at a specified extension. (→ 1.3.9 Call Pickup)
Call Pickup Group	You can pick up a call ringing at another extension within a call pickup group. (→ 1.3.9 Call Pickup)
Doorphone Call	You can call a doorphone. (→ 1.3.21 Doorphone Call)
Door Open	You can open a door. (→ 1.3.20 Door Open)
External BGM	A manager extension can turn on/off background music through external speakers. (→ 2.1.2 External BGM (Background Music))
Paging	You can make a voice announcement through the built-in speakers of proprietary telephones (PTs) and/or external speakers. (→ 1.3.47 Paging)
External Relay ON	You can switch on a relay. (→ 1.3.27 External Relay)



- This feature is not available for the KX-NT321 and KX-DT321.

<Display Prompts>

● [Call Back Cancel]

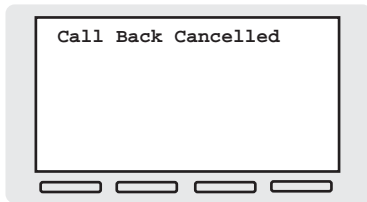
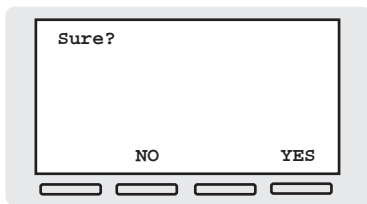
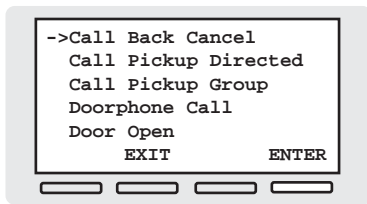

● [Call Pickup Directed]

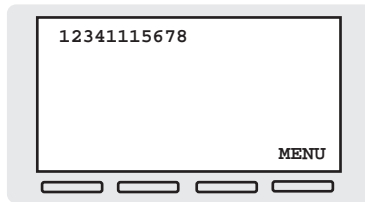
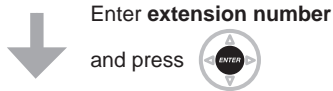
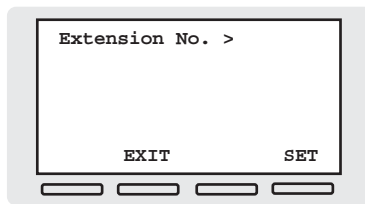
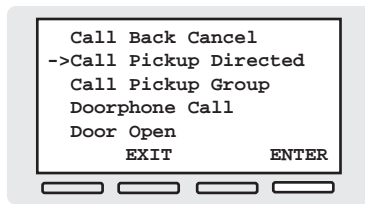

You are connected with the caller, and the caller's number is displayed.

● [Call Pickup Group]

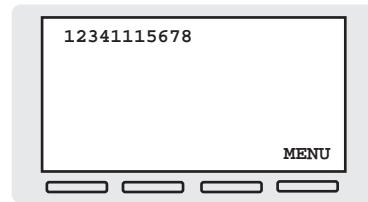
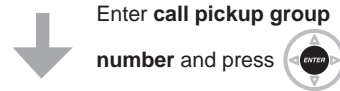
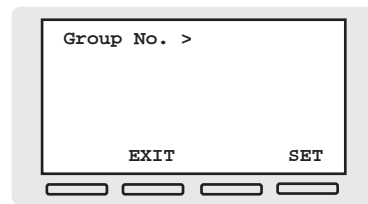
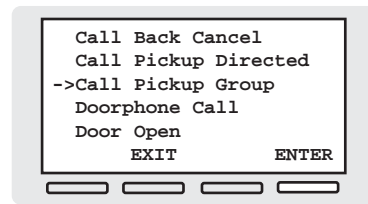

You are connected with the caller, and the caller's number is displayed.

● [Doorphone Call]

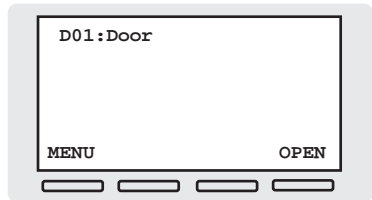
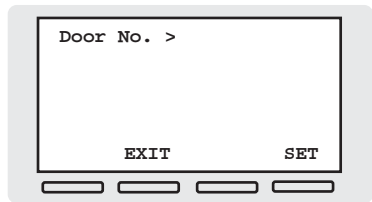
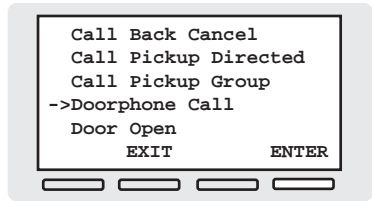

● [Door Open]

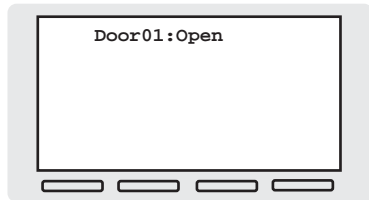
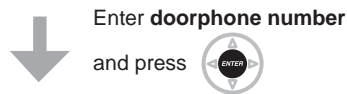
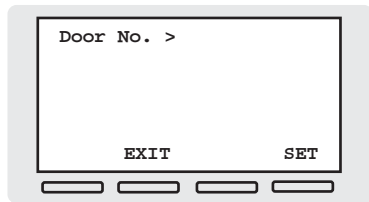
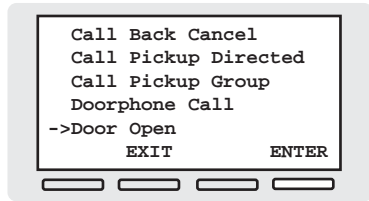

● [External BGM]

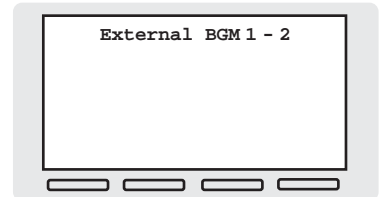
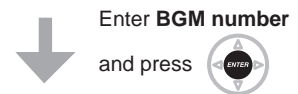
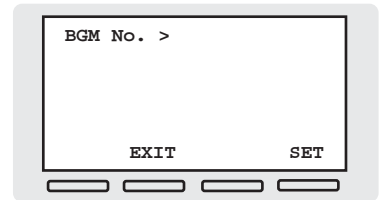
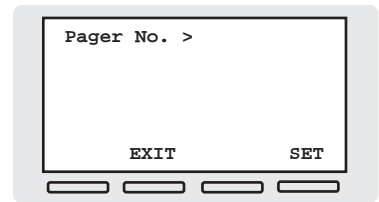
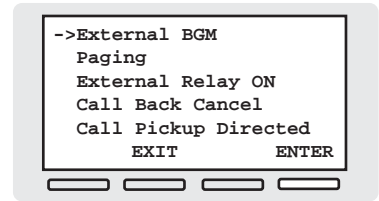

The BGM starts playing.

1.4.4 System Feature Access

● [Paging]

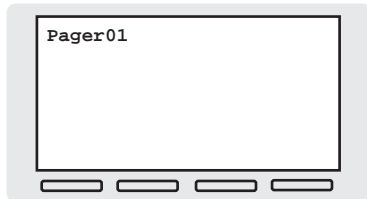
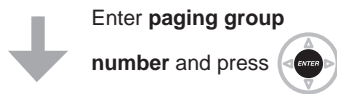
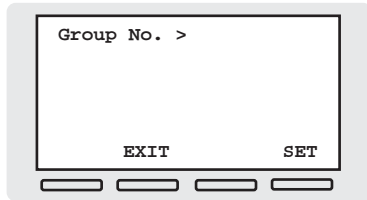
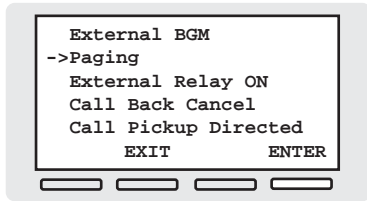

An alarm tone will be heard at the paged extensions, and you can start your page.

● [External Relay ON]

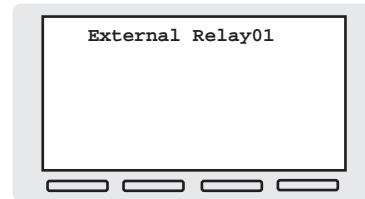
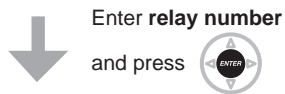
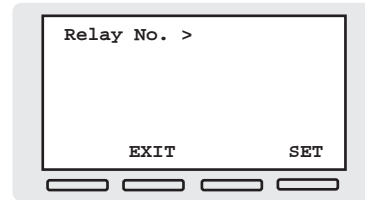
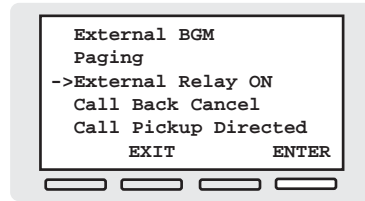

Section 2

Manager Operation

This chapter shows the manager how to control the other extensions or the PBX.

2.1 Manager Service Features

2.1.1 Dial Tone Transfer

The manager can change the restriction level, permitting an extension to make a call.

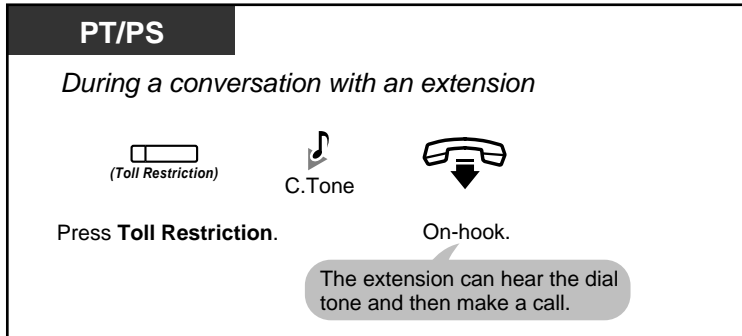

- The restriction level is changed to the preprogrammed level of Toll Restriction button.



Customizing Your Phone

- 3.1.4 Customizing the Buttons
Create or edit a Toll Restriction (TRS) button.

2.1.2 External BGM (Background Music)

The manager extension can select and broadcast background music in the office through external speakers.

To select and start/stop the background music

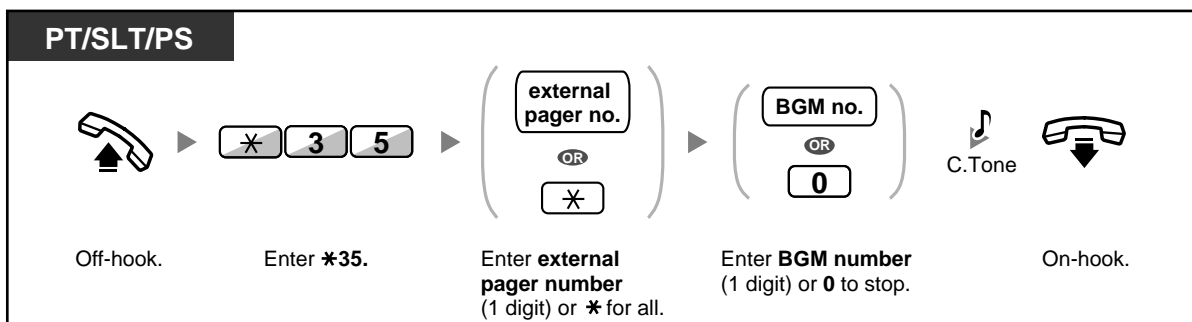

2.1.3 OGM (Outgoing Messages)

The manager extension can record three kinds of greeting messages (OGM) as follows:

1. **DISA message:** Used to greet and guide callers so that they access extension user group or outside party without operator assistance.
2. **Incoming Call Distribution Group message:** Used to greet and guide callers to an incoming call distribution group.
3. **Time Reminder message:** Used when the extension answers the Timed Reminder.



All messages have their own extension numbers. You can select the desired message. You have two methods for recording a message. One is recorded using the handset, and the other is recorded from an external BGM (MOH) port.

To record

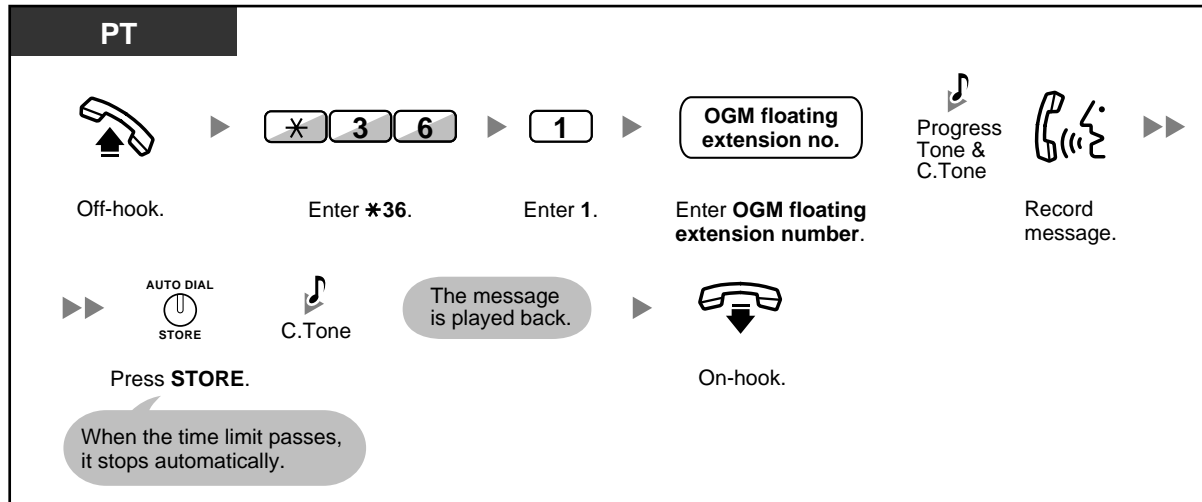

To play back

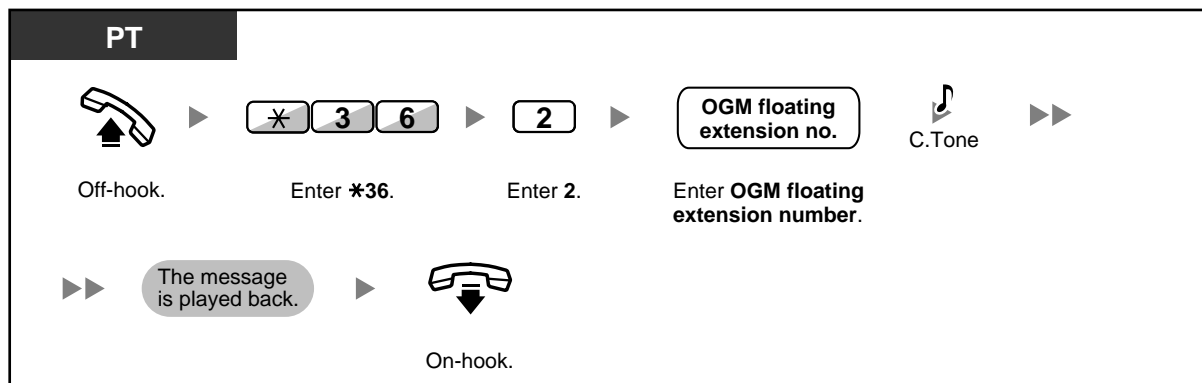

To record from an external BGM (MOH) port

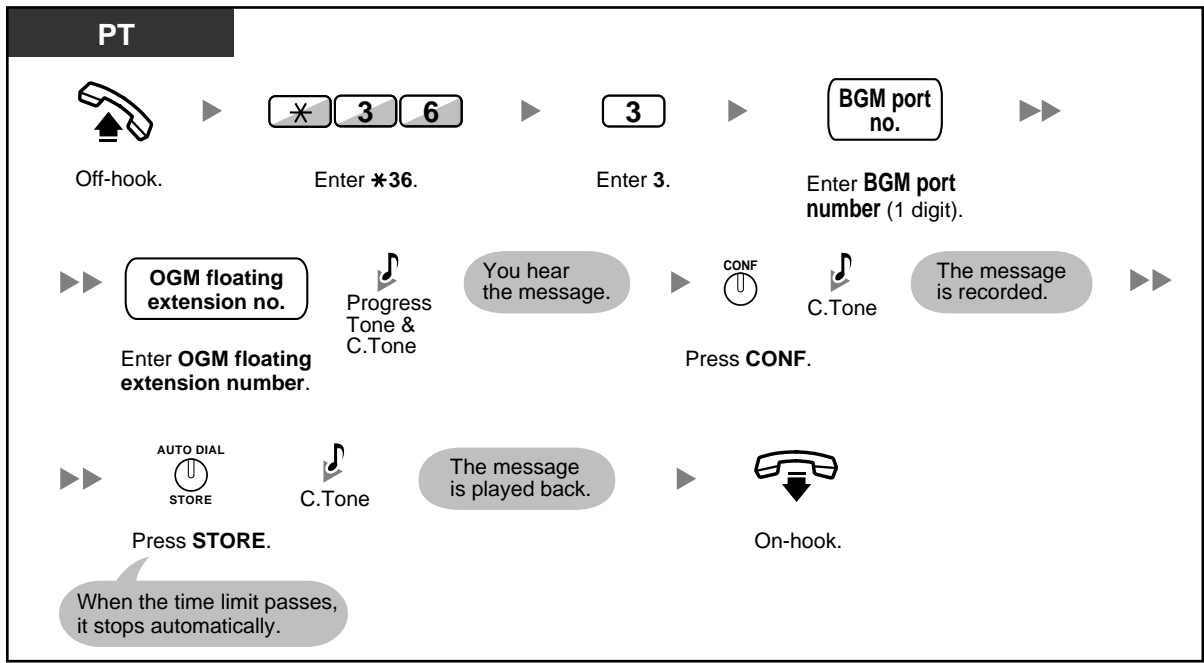

To clear the message

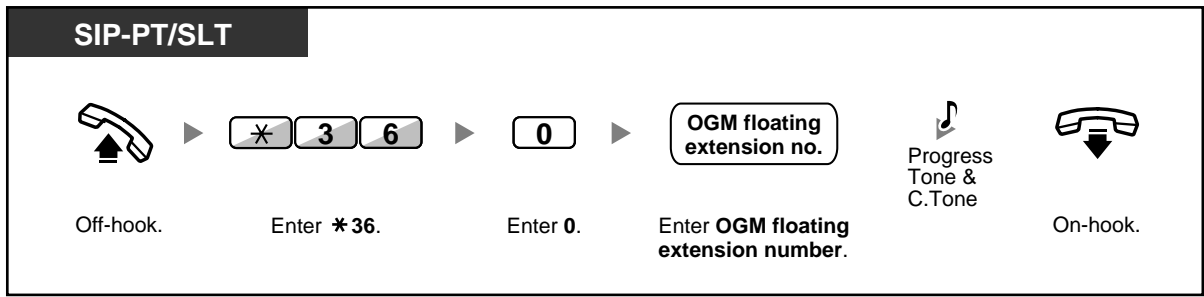

- The default of OGM floating extension numbers is 5xx (xx: two-digit number of message).

2.1.4 Private Network Features—NDSS (Network Direct Station Selection) Monitor Release

NDSS buttons can be customized on any extension connected to your PBX. An NDSS button allows an extension user to monitor another extension connected to another PBX in a private network. The NDSS button light shows the current status of the monitored extension. When it becomes unnecessary to monitor an extension connected to another PBX, the manager can stop the PBX from monitoring it. Any NDSS buttons set to monitor that extension will also stop monitoring.



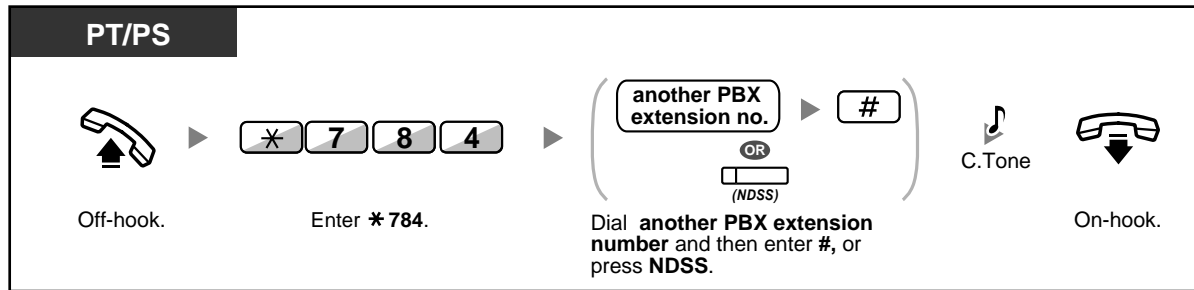

- To restart monitoring of an extension after performing this operation, go off-hook, press the corresponding NDSS button, and go on-hook.



Customizing Your Phone

- 3.1.4 Customizing the Buttons
Create or edit a Network Direct Station Selection (NDSS) button.

2.1.5 Remote Extension Dial Lock

This feature can override Extension Dial Lock (refer to 1.3.24 Extension Dial Lock) that has been set by an extension user. If the manager extension locks the extension, the extension user cannot unlock it. This feature is also known as Remote Station Lock Control.

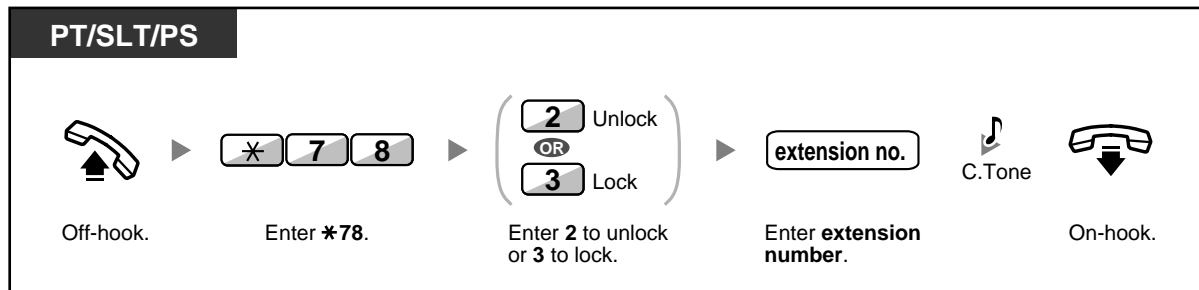

2.1.6 Time Service Mode Control

The manager extension or the preprogrammed extension can change the time mode (Day, Lunch, Break or Night).

There are two methods (Automatic or Manual) of changing the time modes.

Automatic: enables the time mode for each day of the week to change automatically. You may also change it manually.

Manual: enables to change a mode in manual as follows.

To change the time mode (Day/Night/Lunch/Break)

PT/PS

While on-hook

Press **Time Service (Day/Night/Lunch/Break)** until the desired mode appears.

PT/SLT/PS

Off-hook. Enter ***780**. Enter **0 to 3** as you desire. C.Tone On-hook.

To select the time service switching mode (Automatic/Manual)

PT/PS

While on-hook

Press **Time Service Switching Mode (Automatic/Manual)**.



- Besides the time mode, there is Holiday mode. It can change mode once on a specified date.
- The Time Service (Day/Night/Lunch/Break) button light shows the current status as follows:
 - Off:** Day mode
 - Green on:** Lunch mode
 - Flashing green:** Break mode
 - Red on:** Night mode
 - Flashing red:** Holiday mode
- The Time Service Switching Mode (Automatic/Manual) button light shows the current status as follows:
 - Off:** Automatic
 - Red on:** Manual



Customizing Your Phone

- 3.1.4 Customizing the Buttons
Create or edit a Time Service (Day/Night/Lunch/Break) button or a Time Service Switching Mode (Automatic/Manual) button.

Section 3

Customizing Your Phone & System

This chapter shows you how to customize your individual telephone or PBX according to your needs. Find the desired setting and program as necessary.

3.1 Personal Programming

3.1.1 Programming Information

You can customize your telephone features. For example, you can change the initial settings or button features according to your needs.

Available Extension

Any extension in the PBX

Required Telephone

A Panasonic Proprietary Telephone (PT), Portable Station (PS)

Conditions

Programming extensions must be idle, on-hook and holding no calls.

3.1.2 Personal Programming

You can program features using the programming mode.



- To exit at any time, lift the handset.
- To enter the programming mode when using a PS, refer to "Operating Instructions" for PS.





- If you change your desk and extension, refer to "1.3.75 Walking Extension".

◆◆ Setting Features

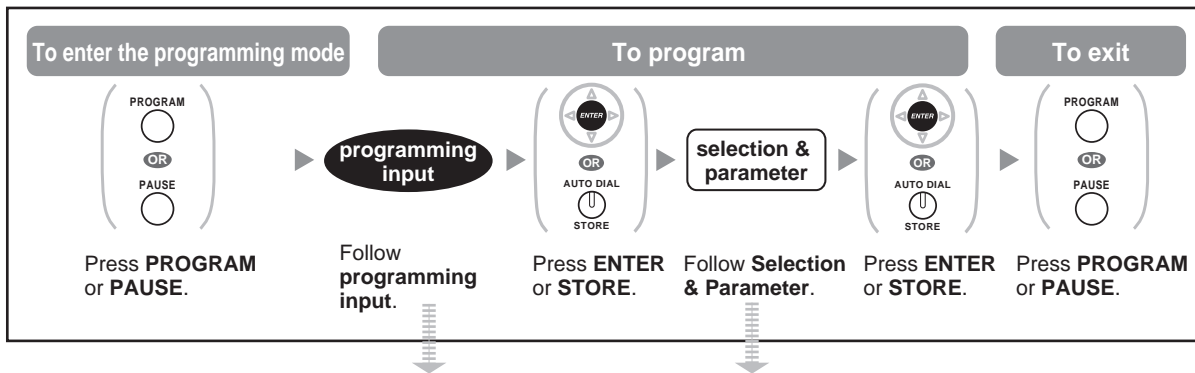
The default settings are shown in bold letters. For later reference, place a check mark in the boxes below to indicate your customized setting.



Item	Programming Input	Selection & Parameter	
Your extension information	<input type="text" value="0"/> <input type="text" value="0"/>	<p>PT: The display shows the PBX or shelf number, slot number and port number. (Some IP-PTs may not display the extension number.) <example for users of KX-TDE100/KX-TDE200></p> <p style="text-align: center;">EXT1050:10308 PBX no. <input type="text" value="1"/> <input type="text" value="1"/> <input type="text" value="1"/> Port no. Slot no.</p> <p><example for users of KX-TDE600></p> <p style="text-align: center;">EXT2100:20101 Shelf no. <input type="text" value="1"/> <input type="text" value="1"/> <input type="text" value="1"/> Port no. (1-4) Slot no.</p> <p>PS: The display shows the PS number. <example></p> <p style="text-align: center;">EXT3001:99001 PS no.</p>	
Display Contrast Selection¹ Preferred display contrast level from the 4 levels available	<input type="text" value="0"/> <input type="text" value="1"/>	<input type="text" value="1"/>	<input type="checkbox"/> Light
		<input type="text" value="2"/>	<input type="checkbox"/> Little Light
		<input type="text" value="3"/>	<input type="checkbox"/> Little Dark
		<input type="text" value="4"/>	<input type="checkbox"/> Dark
Display Language Selection Which display language do you prefer?	<input type="text" value="0"/> <input type="text" value="2"/> / 	<input type="text" value="1"/>	<input type="checkbox"/> English
		<input type="text" value="2"/>	<input type="checkbox"/> 2nd Language
		<input type="text" value="3"/>	<input type="checkbox"/> 3rd Language
		<input type="text" value="4"/>	<input type="checkbox"/> 4th Language
		<input type="text" value="5"/>	<input type="checkbox"/> 5th Language
Display Switching Mode Would you like the call duration to be shown automatically on the display when answering an outside call?	<input type="text" value="0"/> <input type="text" value="3"/>	<input type="text" value="0"/>	<input type="checkbox"/> No—Manual (The display keeps showing all of the outside caller's information unless you change it to the call duration manually.)
		<input type="text" value="1"/>	<input type="checkbox"/> Yes—Automatic (The first line of the display will change to the call duration automatically when you answer an outside call.)

Item	Programming Input	Selection & Parameter	
Display Backlight Selection ^{*1*2} Would you like to turn on the display backlight of the telephone?	<input type="checkbox"/> 0 <input type="checkbox"/> 4	<input type="checkbox"/> 0	<input type="checkbox"/> Yes—Automatic
		<input type="checkbox"/> 1	<input type="checkbox"/> Yes—always On
		<input type="checkbox"/> 2	<input type="checkbox"/> No—always Off
Self Labeling Display Contrast Preferred display contrast level from the 4 levels available for Self Labeling (KX-NT366 only)	<input type="checkbox"/> 0 <input type="checkbox"/> 5	<input type="checkbox"/> 1	<input type="checkbox"/> Light
		<input type="checkbox"/> 2	<input type="checkbox"/> Little Light
		<input type="checkbox"/> 3	<input type="checkbox"/> Little Dark
		<input type="checkbox"/> 4	<input type="checkbox"/> Dark
Hot Line Would you like to dial a preset number simply by going off-hook?	<input type="checkbox"/> 1 <input type="checkbox"/> 1	desired no. (max. 32 digits)	
	<input type="checkbox"/> 1 <input type="checkbox"/> 2	<input type="checkbox"/> 0	<input type="checkbox"/> Do not use
		<input type="checkbox"/> 1	<input type="checkbox"/> Use
Calling Line Identification Restriction (CLIR) Should you prevent your number being displayed on the called party's telephone?	<input type="checkbox"/> 1 <input type="checkbox"/> 3	<input type="checkbox"/> 0	<input type="checkbox"/> No—Allows your number to be displayed
		<input type="checkbox"/> 1	<input type="checkbox"/> Yes—Prevent your number being displayed
Calling/Connected Line Identification Presentation (CLIP/COLP) Which number should be displayed on the called party's telephone?	<input type="checkbox"/> 1 <input type="checkbox"/> 4	<input type="checkbox"/> 0	Caller ID assigned to your extension
		<input type="checkbox"/> 1	Caller ID assigned on the CO line being used
Preferred Line Assignment—Outgoing Which do you prefer to seize when you go off-hook to make calls?	<input type="checkbox"/> 1 <input type="checkbox"/> 9	<input type="checkbox"/> 0	<input type="checkbox"/> No line
		<input type="checkbox"/> 1	<input type="checkbox"/> An idle CO line
		<input type="checkbox"/> 2 + CO button no. (01-36) ^{*3} /(01-84) ^{*4} or <input type="checkbox"/> _____ (CO)	<input type="checkbox"/> A CO/ICD Group button
		<input type="checkbox"/> 3 or INTERCOM  /  (PDN)	<input type="checkbox"/> Intercom (On a PDN extension, an idle PDN button is selected when going off-hook.)

Item	Programming Input	Selection & Parameter	
Preferred Line Assignment—Incoming Which line do you prefer to answer when you go off-hook?	<input type="checkbox"/> 2 <input type="checkbox"/> 0	<input type="checkbox"/> 0	<input type="checkbox"/> No line
		<input type="checkbox"/> 1	<input type="checkbox"/> The longest ringing line (when multiple calls arrive)
		<input type="checkbox"/> 2 + CO button no. (01-36) ^{*3} /(01-84) ^{*4} or <input type="checkbox"/> (CO)	<input type="checkbox"/> A CO/ICD Group button
		<input type="checkbox"/> 3 / <input type="checkbox"/> (PDN)	<input type="checkbox"/> A PDN button
Alternate Receiving—Ring/Voice^{*1} How do you prefer to receive an intercom call?	<input type="checkbox"/> 2 <input type="checkbox"/> 1	<input type="checkbox"/> 0	<input type="checkbox"/> Ringing (Tone Call)
		<input type="checkbox"/> 1	<input type="checkbox"/> Directly—The party's voice is heard without ringing.
		<input type="checkbox"/> 2	<input type="checkbox"/> Ring only—Prohibiting the caller switching to the voice mode.
Paralleled Telephone^{*1} Should the single line telephone in parallel ring?	<input type="checkbox"/> 2 <input type="checkbox"/> 2	<input type="checkbox"/> 0	<input type="checkbox"/> No—The telephone will not ring.
		<input type="checkbox"/> 1	<input type="checkbox"/> Yes—The telephone will ring.
Forced Answerback Selection^{*1} Do you prefer to answer a call without going off-hook regardless of the AUTO ANS button status?	<input type="checkbox"/> 2 <input type="checkbox"/> 3	<input type="checkbox"/> 0	<input type="checkbox"/> No—Disable
		<input type="checkbox"/> 1	<input type="checkbox"/> Yes—Enable
Live Call Screening Mode Set^{*1} Which service do you prefer when a calling party is recording a message in your mailbox?	<input type="checkbox"/> 2 <input type="checkbox"/> 5	<input type="checkbox"/> 0	<input type="checkbox"/> You can monitor the message through the telephone speaker. (Hands-free mode)
		<input type="checkbox"/> 1	<input type="checkbox"/> Only an alarm tone is heard. (Private mode)
LCS Mode Set (After Answering) Would you like to keep recording after answering the call in the LCS mode?	<input type="checkbox"/> 2 <input type="checkbox"/> 6	<input type="checkbox"/> 0	<input type="checkbox"/> No—Stop recording
		<input type="checkbox"/> 1	<input type="checkbox"/> Yes—Keep recording
Automatic Call Waiting^{*5} Would you prefer to automatically hear a call waiting tone when you receive a call while already on the phone?	<input type="checkbox"/> 3 <input type="checkbox"/> 0	<input type="checkbox"/> 0	<input type="checkbox"/> No—OFF
		<input type="checkbox"/> 1	<input type="checkbox"/> Yes—ON

Item	Programming Input	Selection & Parameter	
Manual Call Waiting How would you prefer to receive call waiting notifications for intercom calls?	[3] [1]	[0]	<input type="checkbox"/> No call (OFF)
		[1]	<input type="checkbox"/> Tone (BSS)
		[2]	<input type="checkbox"/> Voice announcement through the built-in speaker (OHCA) ⁶
		[3]	<input type="checkbox"/> Voice announcement through the handset (Whisper OHCA) ⁶
Call Waiting Tone Type Selection Which type of call waiting tone do you prefer?	[3] [2]	[0]	<input type="checkbox"/> Tone 1
		[1]	<input type="checkbox"/> Tone 2
Absent Message Would you like to show a message on the caller's telephone display?	[4] [0]	[0]	<input type="checkbox"/> No—Off
		message no. (1–8)	<input type="checkbox"/> Yes—Shows the selected message.
		[9]	<input type="checkbox"/> Yes—Shows your personal message.
Personal Absent Message Creating your personal message	[4] [1]	message (max. 16 characters)	
Call Forwarding (FWD)/Do Not Disturb (DND) To forward or refuse some or all of your incoming calls	[5] [0] /  (for both calls) [5] [1] (for outside calls) [5] [2] (for intercom calls)	[0]	<input type="checkbox"/> Off
		[1]	<input type="checkbox"/> Do Not Disturb (DND)
		[2] + desired no. (max. 32 digits)	<input type="checkbox"/> All—Forward all calls
		[3] + desired no. (max. 32 digits)	<input type="checkbox"/> Busy—Forwarded when your extension is busy.
		[4] + desired no. (max. 32 digits)	<input type="checkbox"/> No Answer—Forwarded when you do not answer.
		[5] + desired no. (max. 32 digits)	<input type="checkbox"/> Busy/No Answer—Forwarded when you do not answer or when your extension is busy.
FWD N/A Timer To set the timer for "No Answer" and "Busy/No Answer"	[5] [3]	<input type="text"/> (0–120) seconds (Default: 15 seconds)	
Call Pickup Deny Should you prohibit other people from picking up your calls?	[6] [0]	[0]	<input type="checkbox"/> No—Allow
		[1]	<input type="checkbox"/> Yes—Deny

Item	Programming Input	Selection & Parameter	
Headset Operation^{*1} Do you use the headset?	<input type="text" value="6"/> <input type="text" value="1"/>	<input type="text" value="0"/>	<input type="checkbox"/> No—Headset off
		<input type="text" value="1"/>	<input type="checkbox"/> Yes—Headset on
Executive Busy Override Deny Do you prohibit other people from joining your conversation?	<input type="text" value="6"/> <input type="text" value="2"/>	<input type="text" value="0"/>	<input type="checkbox"/> No—Allow
		<input type="text" value="1"/>	<input type="checkbox"/> Yes—Deny
Paging Deny^{*1} Would you like to prohibit paging announcements?	<input type="text" value="6"/> <input type="text" value="3"/>	<input type="text" value="0"/>	<input type="checkbox"/> No—Allow
		<input type="text" value="1"/>	<input type="checkbox"/> Yes—Deny
Key Pad Tone Set^{*1} Do you prefer to hear the key pad tone?	<input type="text" value="6"/> <input type="text" value="4"/>	<input type="text" value="0"/>	<input type="checkbox"/> No—Off
		<input type="text" value="1"/>	<input type="checkbox"/> Yes—On
Background Music (BGM)^{*1} Do you want background music through your telephone speaker while on-hook?	<input type="text" value="6"/> <input type="text" value="5"/>	<input type="text" value="0"/>	<input type="checkbox"/> No—Off
		<input type="text" value="1"/> + BGM no. (1 digit)	<input type="checkbox"/> Yes—On
Bluetooth Registration^{*7} To register a Bluetooth wireless headset on your extension ^{*8}	<input type="text" value="6"/> <input type="text" value="6"/>	Pass key (max. 16 digits)	
Bluetooth Removal^{*7} To cancel the registration of a Bluetooth wireless headset on your extension ^{*8}	<input type="text" value="6"/> <input type="text" value="7"/>	Confirm that the ID of your Bluetooth wireless headset is displayed.	
Extension PIN (Personal Identification Number) To set your extension PIN or change the stored extension PIN	<input type="text" value="9"/> <input type="text" value="0"/>	extension PIN (max. 10 digits) + ENTER/STORE + same extension PIN	To set an extension PIN
		stored extension PIN + new extension PIN (max. 10 digits) + ENTER/STORE + same extension PIN	To change a stored extension PIN

Item	Programming Input	Selection & Parameter	
Extension Dial Lock To prevent other people from using your telephone	<input type="text" value="9"/> <input type="text" value="1"/>	extension PIN (max. 10 digits) + <input type="text" value="0"/>	<input type="checkbox"/> To unlock
		extension PIN (max. 10 digits) + <input type="text" value="1"/>	<input type="checkbox"/> To lock
Display Lock^{*1} To prevent other people from seeing your personal speed dialing directory, call log, SVM log	<input type="text" value="9"/> <input type="text" value="2"/>	extension PIN (max. 10 digits) + <input type="text" value="0"/>	<input type="checkbox"/> To unlock
		extension PIN (max. 10 digits) + <input type="text" value="1"/>	<input type="checkbox"/> To lock
One-touch Dialing Assignment Mode Selection Do you prefer to set the One-touch dialing only?	<input type="text" value="#"/> <input type="text" value="*"/>	<input type="text" value="0"/>	<input type="checkbox"/> No—Normal (Any Flexible buttons can be modified.)
		<input type="text" value="1"/>	<input type="checkbox"/> Yes—Only One-touch dialing buttons can be modified. However, to modify them, there is no need to enter "2" before the number.

^{*1} Not available for a PS

^{*2} Only available for the KX-T7633/KX-T7636/IP-PTs/KX-DT300 series (except KX-DT333) telephones.

^{*3} CO button numbers (25–36) are available only when the Add-on Key Module is set up to your telephone.

^{*4} CO button numbers (25–84) are available only when the Add-on 60 Key Module (KX-NT305) is set up on a KX-NT300 series telephone (not available for the KX-NT366).

^{*5} This setting applies to both outside and intercom calls. For intercom calls, this feature must be enabled through system programming.

^{*6} Only available for certain digital proprietary telephone users.

^{*7} Only available for KX-NT300 series (except KX-NT321)/KX-DT343/KX-DT346 telephones.

^{*8} Registering and canceling a Bluetooth wireless headset may take time. Please avoid any interruption during that time by, for example, going off-hook.



CAUTION

There is a risk that fraudulent telephone calls will be made if a third party discovers your password (extension PIN).

The cost of such calls will be billed to the owner/renter of the PBX.

To protect the PBX from this kind of fraudulent use, we strongly recommend:

- a. Keeping your PIN secret.
 - b. Selecting a complex, random PIN that cannot be easily guessed.
 - c. Changing your PIN regularly.
- After the program number is entered, the program title is displayed. The programming screen can be changed with the Navigator Key (Up or Down).
 - You can select the parameter with the Navigator Key (Up or Down) instead of entering a number.



To store the names and numbers in personal speed dialing

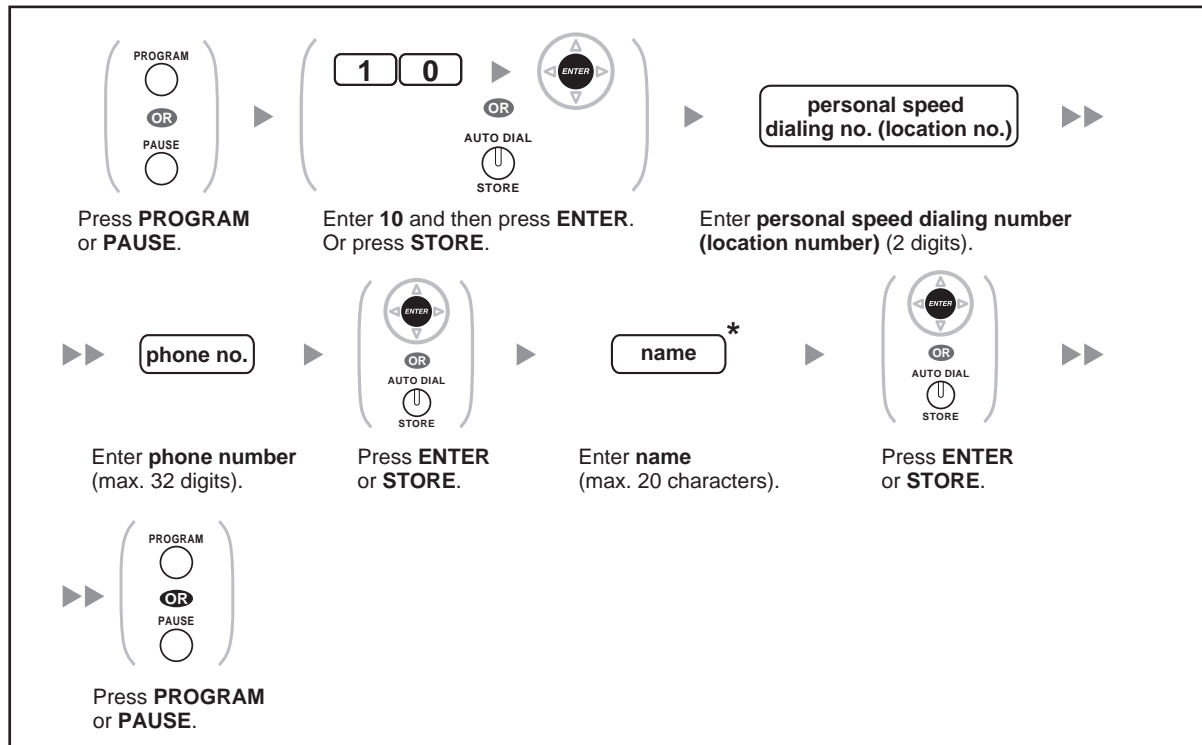

- * To enter characters, refer to "1.3.14 Character Entry".

To edit the names and numbers of personal speed dialing

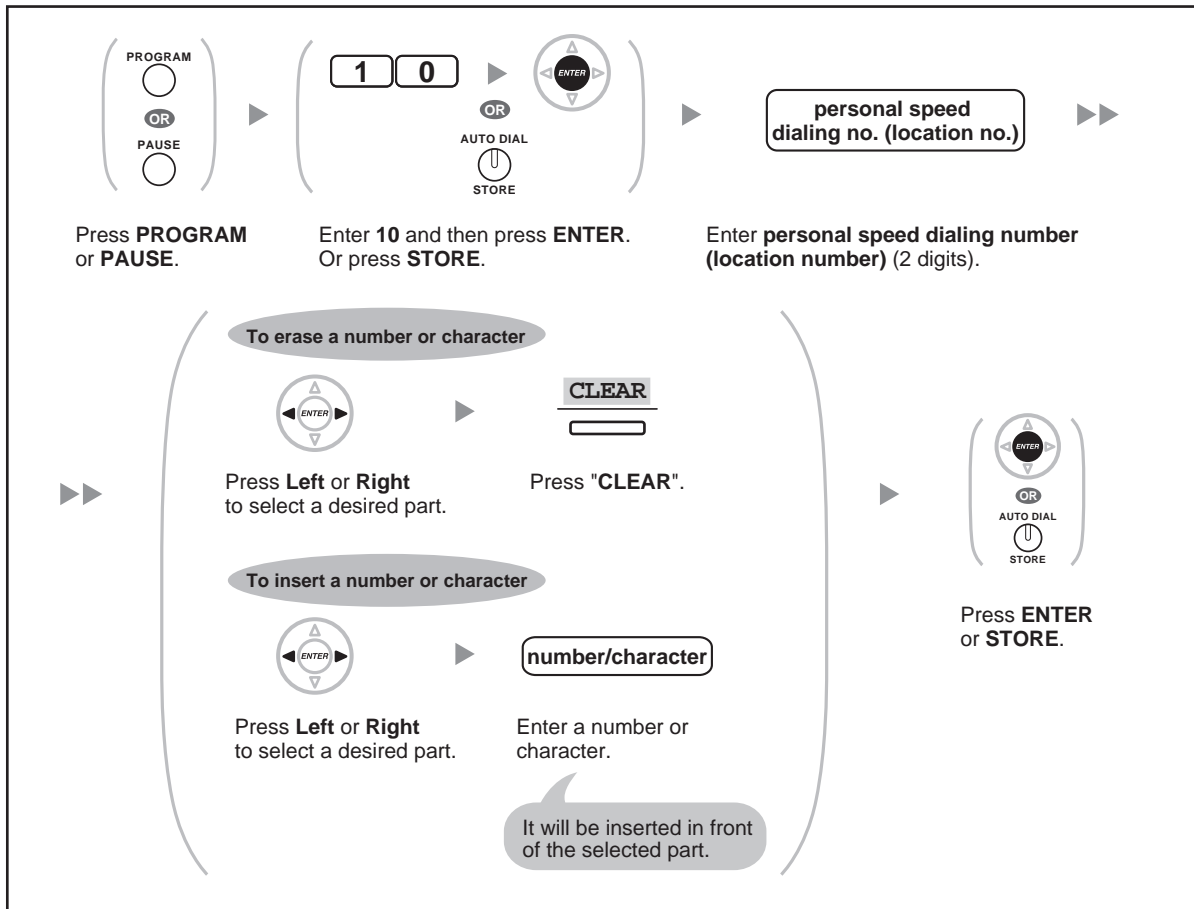

3.1.3 Programming Feature Clear

You can reset the settings of the following features on your extension to the default settings with one operation.

Features	Default Setting
Display Switching Mode	Automatic
Hot Line	Off
Calling Line Identification Restriction (CLIR)	Allow
Calling/Connected Line Identification Presentation (CLIP/COLP)	Caller ID assigned on your extension
Preferred Line Assignment—Outgoing	Intercom
Preferred Line Assignment—Incoming	The longest ringing line
Alternate Receiving—Ring/Voice	Ringing (Tone Call)
Paralleled Telephone	Paired SLT will ring
Forced Answerback Selection	Disable
Live Call Screening Mode Set	Hands-free mode

Features	Default Setting
LCS Mode Set (After Answering)	Stop recording
Automatic Call Waiting	On
Manual Call Waiting—Intercom Calls	On (Tone)
Call Waiting Tone Type Selection	Tone 1
Absent Message	Off
Personal Absent Message	Cleared
Call Forwarding (FWD)/Do Not Disturb (DND)—Intercom Calls/Outside Calls	Off
FWD N/A Timer	15 seconds
Call Pickup Deny	Allow
Headset Operation	Headset off
Executive Busy Override Deny	Allow
Paging Deny	Allow
Key Pad Tone Set	On
Background Music (BGM)	Off
Data Line Security	Off
Connected Line Identification Restriction (COLR)	Allow
Log-in/Log-out	Log-in
Message Waiting	Off
Timed Reminder	Cleared

To set

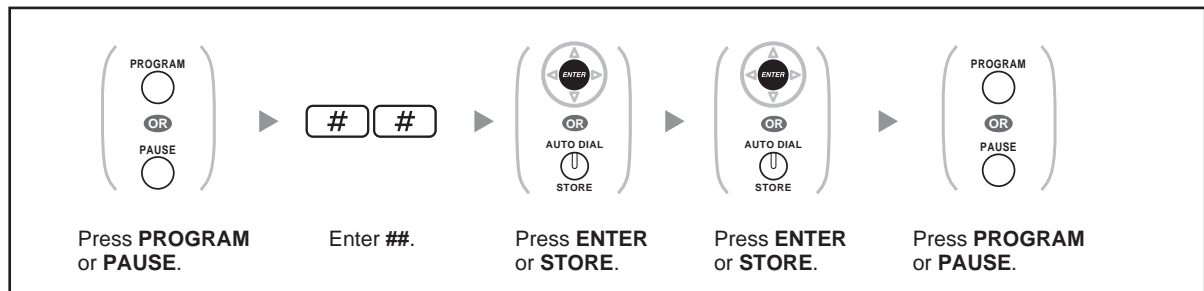

- The Call Waiting, FWD/DND and Hot Line features may not be cleared by this operation, depending on system programming.

3.1.4 Customizing the Buttons

You can customize the flexible buttons and/or programmable feature (PF) buttons on PTs, Add-on Key Modules, and PSs. They can then be used to make or receive outside calls or as feature buttons.



- To enter the programming mode when using a PS, refer to "Operating Instructions" for PS.
- The buttons in the table below can only be set on certain flexible buttons, as follows:
 - Flexible buttons on PTs/Add-on Key Modules/PSs: all buttons can be set.
 - Flexible buttons on DSS Consoles: all buttons except CTI and Primary Directory Number (PDN) buttons can be set.
 - Programmable feature (PF) buttons: only the One-touch Dialing button can be set.

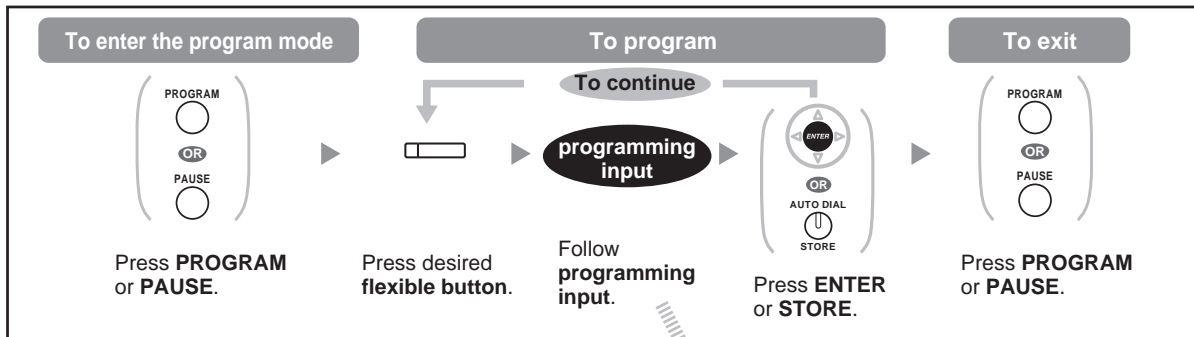

Button	Programming Input
Loop-CO (L-CO)	[*]
Group-CO (G-CO)	[#] + CO line group no. (2 digits)
Single-CO (S-CO)	[0] + CO line no. (3 digits)
Direct Station Selection (DSS)	[1] + Extension no.
One-touch Dialing ¹	[2] ^{*2} + Desired no. (max. 32 digits)
Incoming Call Distribution Group (ICD Group)	[3] [0] + Incoming call distribution group extension no. (+ [#] + delayed ringing time [0-7] ⁴)
Message	[4] [0]
Message for Another Extension	[4] [0] + Extension no./Incoming call distribution group extension no.
Call Forwarding (FWD)/Do Not Disturb (DND)—Both calls	[4] [1]
FWD/DND—Outside calls	[4] [2]
FWD/DND—Intercom calls	[4] [3]
Group FWD—Both calls	[4] [4] + Incoming call distribution group extension no.
Group FWD—Outside calls	[4] [5] + Incoming call distribution group extension no.

Button	Programming Input
Group FWD—Intercom calls	<input type="text" value="4"/> <input type="text" value="6"/> + Incoming call distribution group extension no.
Account	<input type="text" value="4"/> <input type="text" value="8"/>
Conference	<input type="text" value="4"/> <input type="text" value="9"/>
Terminate	<input type="text" value="5"/> <input type="text" value="0"/>
External Feature Access (EFA)	<input type="text" value="5"/> <input type="text" value="1"/>
Call Park	<input type="text" value="5"/> <input type="text" value="3"/> + Parking zone no. (2 digits)
Call Park (Automatic Park Zone)	<input type="text" value="5"/> <input type="text" value="3"/> <input type="text" value="✳"/>
Call Log ⁴	<input type="text" value="5"/> <input type="text" value="4"/>
Call Log for ICD Group ⁴	<input type="text" value="5"/> <input type="text" value="4"/> + Incoming call distribution group extension no.
Log-in/Log-out	<input type="text" value="5"/> <input type="text" value="5"/>
Log-in/Log-out of a specified group	<input type="text" value="5"/> <input type="text" value="5"/> + Incoming call distribution group extension no
Log-in/Log-out for all groups	<input type="text" value="5"/> <input type="text" value="5"/> <input type="text" value="✳"/>
Hurry-up	<input type="text" value="5"/> <input type="text" value="6"/> + Incoming call distribution group extension no.
Wrap-up	<input type="text" value="5"/> <input type="text" value="7"/>
System Alarm ⁴	<input type="text" value="5"/> <input type="text" value="8"/>
Time Service (Day/Night/Lunch/Break)	<input type="text" value="5"/> <input type="text" value="9"/> + 0/1/2/3 ⁵ (+ <input type="text" value="#"/> + Tenant no.)
Answer ⁴	<input type="text" value="6"/> <input type="text" value="0"/>
Release ⁴	<input type="text" value="6"/> <input type="text" value="1"/>
Toll Restriction (TRS)	<input type="text" value="6"/> <input type="text" value="2"/> + Toll Restriction (TRS) Level (1–7)
Calling Line Identification Restriction (CLIR)	<input type="text" value="6"/> <input type="text" value="4"/>
Connected Line Identification Restriction (COLR)	<input type="text" value="6"/> <input type="text" value="5"/>
Headset ⁴	<input type="text" value="6"/> <input type="text" value="7"/>
Time Service Switching Mode (Automatic/Manual)	<input type="text" value="6"/> <input type="text" value="8"/> (+ Tenant no.)
Network Direct Station Selection (NDSS) ⁶	<input type="text" value="6"/> <input type="text" value="9"/> + Another PBX extension no.
CTI	<input type="text" value="7"/> <input type="text" value="0"/>

Button	Programming Input
Primary Directory Number (PDN)	[7] [1]
Secondary Directory Number (SDN)	[7] [2] + Extension no. + [#] + delayed ringing time (0–7) ⁷
Check-in ⁴	[8] [0]
Check-out ⁴	[8] [1]
Cleaned-up ^{4,8}	[8] [2]
Two-way Record ⁹	[9] [0] + Voice mail floating extension no. ¹⁰
Two-way Transfer ⁹	[9] [1] + Voice mail floating extension no. ¹⁰
One-touch Two-way Transfer ⁹	[9] [1] + Voice mail floating extension no. ¹⁰ + [#] + Extension no./Incoming call distribution group extension no.
Live Call Screening (LCS) ⁹	[9] [2]
Voice Mail Transfer ⁹	[9] [4] + Voice mail floating extension no. ¹⁰



- ¹ "×", "#", FLASH/RECALL, PAUSE, Secret (INTERCOM) and TRANSFER can also be stored.
If you do not want to display the stored number when making a call, press the Secret (INTERCOM) button before and after the numbers you wish to conceal.
If you store an outside party's number, you should first store a line access number.
If you need to enter an account code, you can enter the specified account code before the line access number.
<Example>

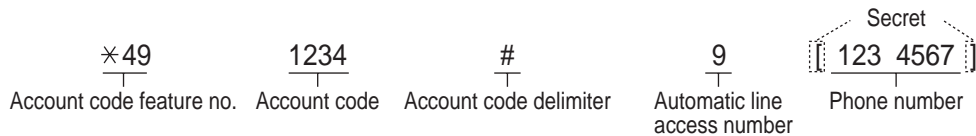

- ² For a PF button, "2" is not required to enter before the desired number.
- ³ Depending on the settings of your PBX, you may be required to enter delayed ringing time (0: Immediate, 1: 1 ring, 2: 2 rings, 3: 3 rings, 4: 4 rings, 5: 5 rings, 6: 6 rings, 7: No ring). In this case, you can automatically join a new ICD group by creating a button for that group.
- ⁴ This button is not available for a PS.
- ⁵ 0: Day/Night/Lunch/Break, 1: Day/Night/Break, 2: Day/Night/Lunch, 3: Day/Night
- ⁶ The button may not be available depending on the networking method in use or the settings of the PBX.
- ⁷ It is possible to set delayed ringing for each SDN button.
- ⁸ This button is only available for the KX-TDE600.
- ⁹ This button is used for the integrated voice mail features.
- ¹⁰ The default voice mail floating extension number is 500.
- **To exit at any time**, lift the handset.
- For KX-NT366 users: After customizing a flexible button, you can set the displayed text for Self Labeling. To enter characters, refer to "1.3.14 Character Entry".





- You can select the parameter with the Navigator key (Up or Down) instead of entering a number.

<Programming Example: Customizing a CO button as a One-touch Dialing button using Secret dialing>

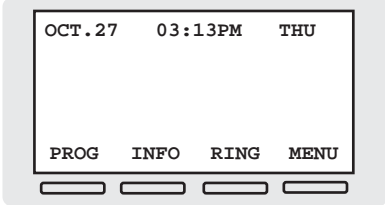
[Initial Display]



1 Press  or  or 

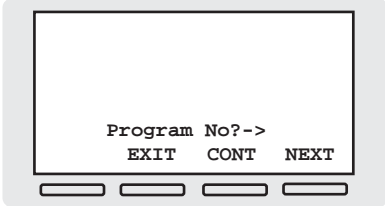

2 Press  (CO)

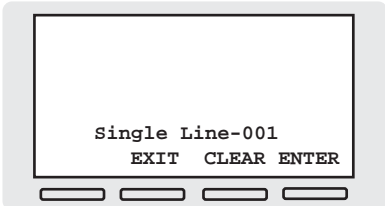

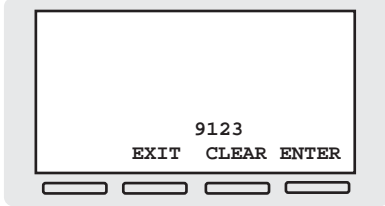

3 Enter the **programming input** () , and **desired phone number**.

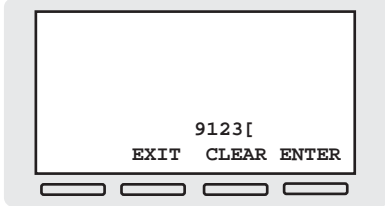

4 Press  in front of the number you want to keep secret.



5 Press  again after entering the number you want to keep secret.



6 Press  to store.

To distinguish the ringing tones for each CO, ICD Group, PDN, SDN, or INTERCOM button (Digital proprietary telephone only)

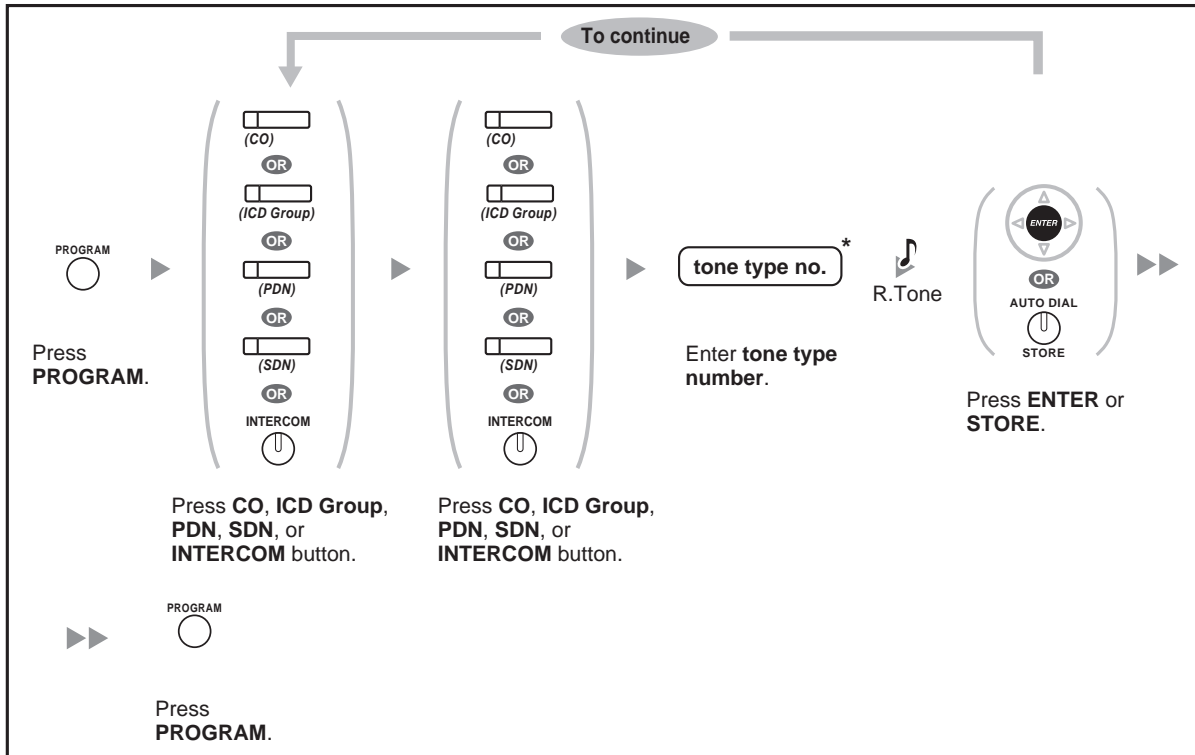

- * Available tone types vary depending on the telephone you are using:
 - KX-NT300 series (except KX-NT321)/KX-NT136/KX-DT300 series (except KX-DT321)/KX-T7600 series: Tone types "01" to "30" (01–20: tone, 21–30: melody) are available.
 - KX-NT265/KX-NT321/KX-DT321: Only tone types "01" to "08" are available. It is possible to enter a tone type number from "09" to "30", but you will hear tone type "01".
 - Other telephones: Only tone types "01" to "08" are available. It is possible to enter a tone type number from "09" to "30", but you will hear tone type "02".
- Only one ringing tone can be selected for all PDN buttons on your extension.

To clear the button

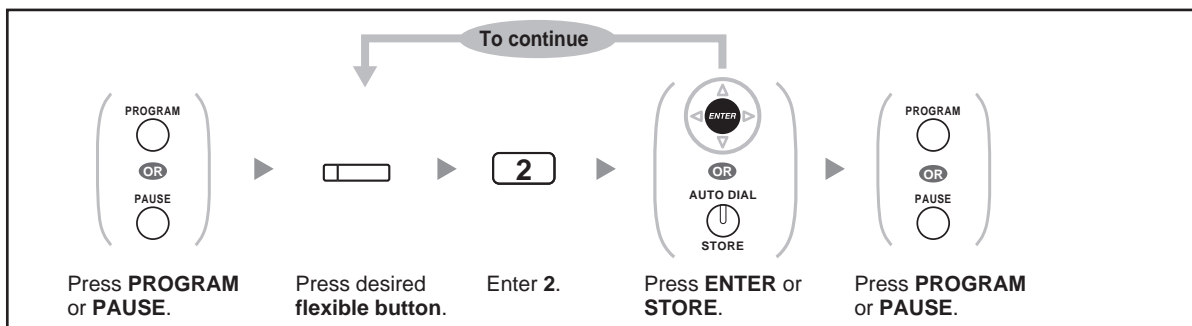

3.2 Manager Programming

3.2.1 Programming Information

The manager can program the following item.

- Other Extensions Control

Available Extension

The extension assigned as a manager

Required Telephone

A Panasonic Proprietary Telephone with display (over 2 lines)
(e.g., KX-NT343, KX-DT346, KX-T7636)

Manager Password

To enter programming mode, the manager password (max. 10 digits) is required. (Default: 1234)

CAUTION

- The PBX has a default password preset. For security, change the password the first time that you program the PBX.
- It is strongly recommended that a password of 10 numbers or characters be used for maximum protection against unauthorized access. For a list of numbers and characters that can be used in the password, refer to "1.3.14 Character Entry".
- To avoid unauthorized access to the PBX, keep the password secret. If it becomes known to others, the PBX may be misused.
- Change the password periodically.

Conditions

The programming extension must be idle, on-hook and holding no calls.

3.2.2 Manager Programming

◆◆ Changing the Settings and Extension Control

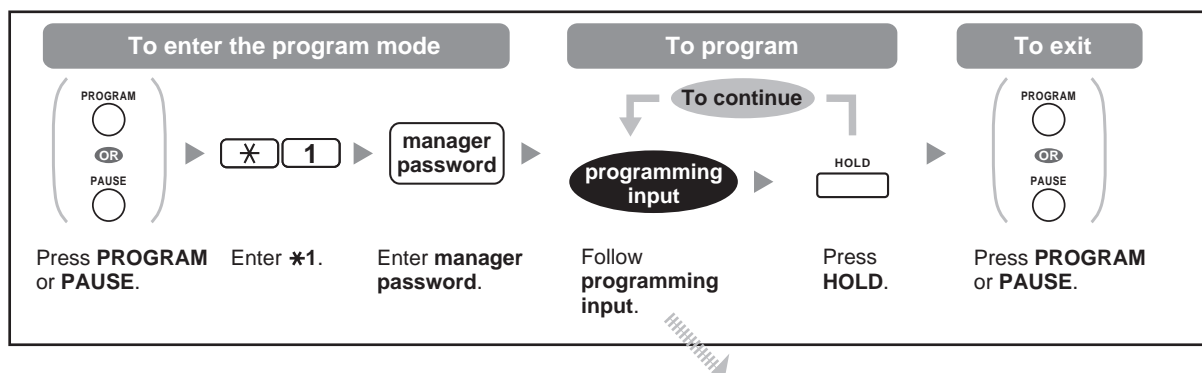

Item	Programming Input
Changing the manager password.	0 0 + + Password (max. 10 digits) +

Item	Programming Input
Locking/unlocking other extensions. (Remote Extension Dial Lock)	$\boxed{9} \boxed{0} + \text{[Navigation Icon]} + \text{Extension no.} + \boxed{1}$ (to lock)/ $\boxed{0}$ (to unlock) + [Navigation Icon]
Clearing the PIN and PIN lock for extensions.	$\boxed{9} \boxed{1} + \text{[Navigation Icon]} + \text{Extension no.} + \text{[Navigation Icon]}$
Clearing the PIN and PIN lock for verification codes.	$\boxed{9} \boxed{2} + \text{[Navigation Icon]} + \text{Verification code} + \text{[Navigation Icon]}$
Setting the verification code PIN.	$\boxed{9} \boxed{3} + \text{[Navigation Icon]} + \text{Verification code} + \text{PIN (max. 10 digits)}$ $+ \text{[Navigation Icon]}$



CAUTION

There is a risk that fraudulent telephone calls will be made if a third party discovers your password (verification code PIN).

The cost of such calls will be billed to the owner/renter of the PBX.



To protect the PBX from this kind of fraudulent use, we strongly recommend:

- a.** Keeping your PIN secret.
- b.** Selecting a complex, random PIN that cannot be easily guessed.
- c.** Changing your PIN regularly.

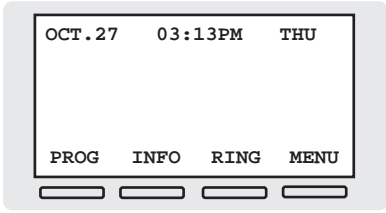

<Programming Example: Changing the manager password>

[Initial Display]

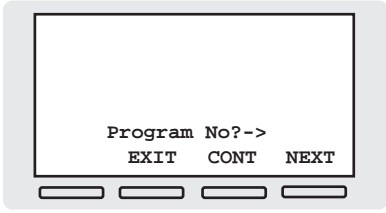

1 Press  or  or 



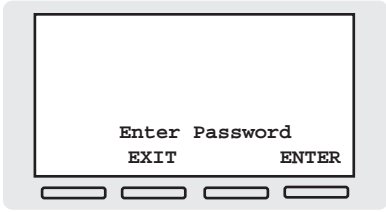

2 Enter  



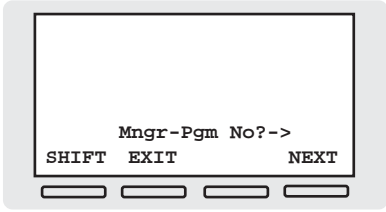

3 Enter the current **manager password**.

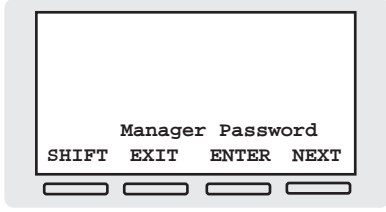

4 Enter the **programming input** ( ).



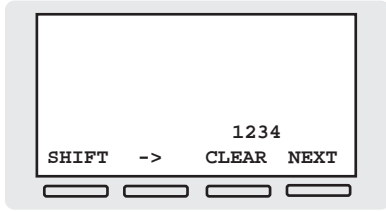

5 Press  or 

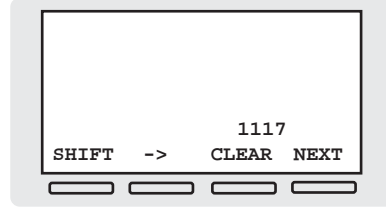

The current manager password appears.

6 Enter a new **manager password** (max. 10 digits).



7 Press  to store.

3.3 System Programming

3.3.1 Programming Information

You can customize your system according to your requirements.
[Your system already has default settings (factory installed).]

The programming is shown below. (Program number)

- The date and time [000]
- System speed dialing numbers and names [001]/[002]
- Extension number and name [003]/[004]

Available Extension

The extension allowed through COS programming

Required Telephone

A Panasonic Proprietary Telephone with display (over 2 lines)
(e.g., KX-NT343, KX-DT346, KX-T7636)

System Password

To enter programming mode, the system password (max. 10 digits) is required. (Default: 1234)

CAUTION

- The PBX has a default password preset. For security, change the password the first time that you program the PBX.
- It is strongly recommended that a password of 10 numbers or characters be used for maximum protection against unauthorized access. For a list of numbers and characters that can be used in the password, refer to "1.3.14 Character Entry".
- To avoid unauthorized access to the PBX, keep the password secret. If it becomes known to others, the PBX may be misused.
- Change the password periodically.







Conditions

































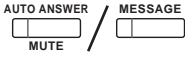

The programming extension must be idle, on-hook and holding no calls.

List

Before programming, decide the settings and write them down. Your notes will provide a useful record of the programming for future reference. Your dealer also has programming records which contain all of the system programming. You may ask for photocopies of these tables to be aware of the facilities and features available.

◆◆ Icon Descriptions

Fixed Buttons			Function
KX-NT300/KX-DT300	KX-NT136/KX-T7600	KX-T7200/KX-T7400 ¹	
			PREVIOUS (PREV)
			NEXT

Fixed Buttons			Function
KX-NT300/KX-DT300	KX-NT136/KX-T7600	KX-T7200/KX-T7400 ^{*1}	
			
			
			STORE (ENTER)
		None	Back to Previous Menu (CANCEL)
			SHIFT
			PROGRAM
			END
			SELECT
			FLASH
			CLEAR
			SECRET

^{*1} The buttons shown in this column are from KX-T7400 series PTs.

◆◆ Procedure

The basic steps are shown below.

1. Entering the programming mode

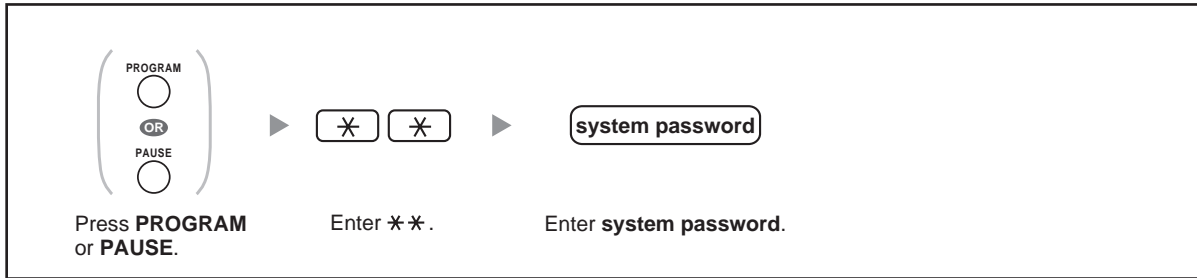

2. Programming

You can enter each program number (3 digits).



- To exit the programming mode at any time, lift the handset.

3. Exiting the mode

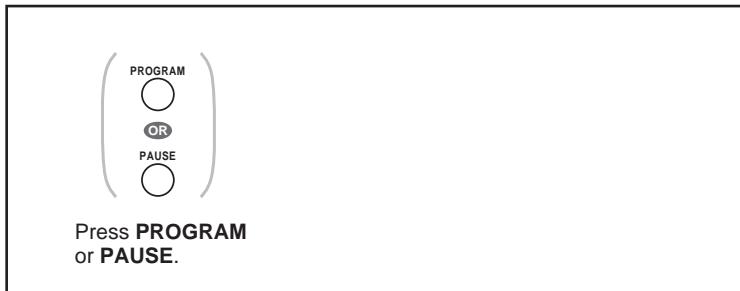

- To exit the programming mode at any time, lift the handset.

3.3.2 System Programming

◆◆ [000] Date & Time

The proprietary telephones display the current date and time while on-hook.

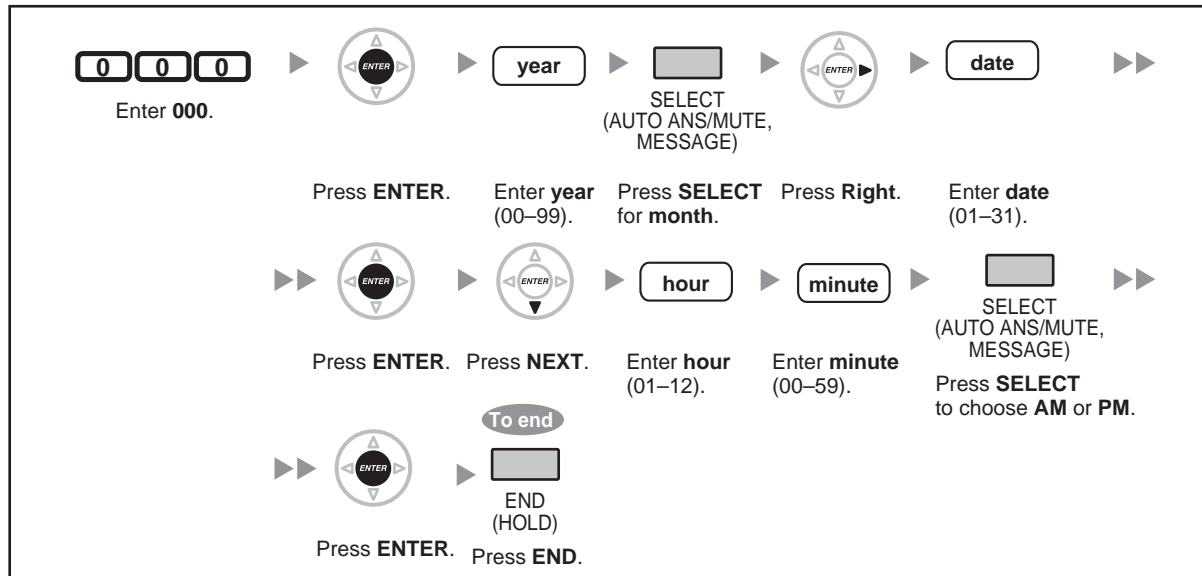

- **After changing the desired values**, you can press the ENTER button. You do not have to perform the rest of the steps.
- The clock starts immediately after the ENTER button is pressed.
- You cannot leave a value empty.
- You can clear the entry by pressing the CLEAR button.
- **To confirm your entry after storing data:**
 - The STORE button light: Lights red
 - Confirmation Tone:
 - One beep: Your entry is accepted.
 - Three beeps: Your entry is rejected.

◆◆ [001] System Speed Dialing Number

You can store the phone numbers of frequently dialed numbers.

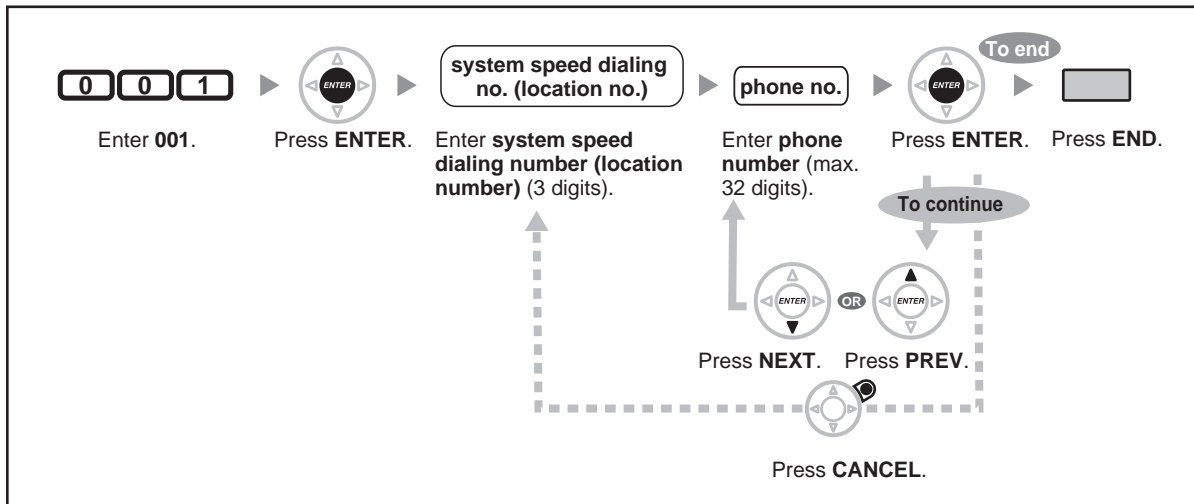

- If the desired number is more than 32 digits, divide the number and store it into more than one speed dialing number.
 - "×", "#", FLASH/RECALL, PAUSE, and Secret (INTERCOM) can also be stored. If you do not want to display the stored number when making a call, press the Secret (INTERCOM) button before and after the numbers you wish to conceal. If you store an outside party's number, you should first store a line access number. If you need to enter an account code, you can enter the specified account code before the line access number.
- <Example>

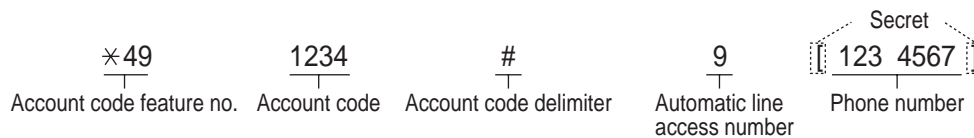

◆◆ [002] System Speed Dialing Name

You can store the name associated with the speed dialing number. These names are displayed when making calls using the display operation. To enter characters, refer to "1.3.14 Character Entry".

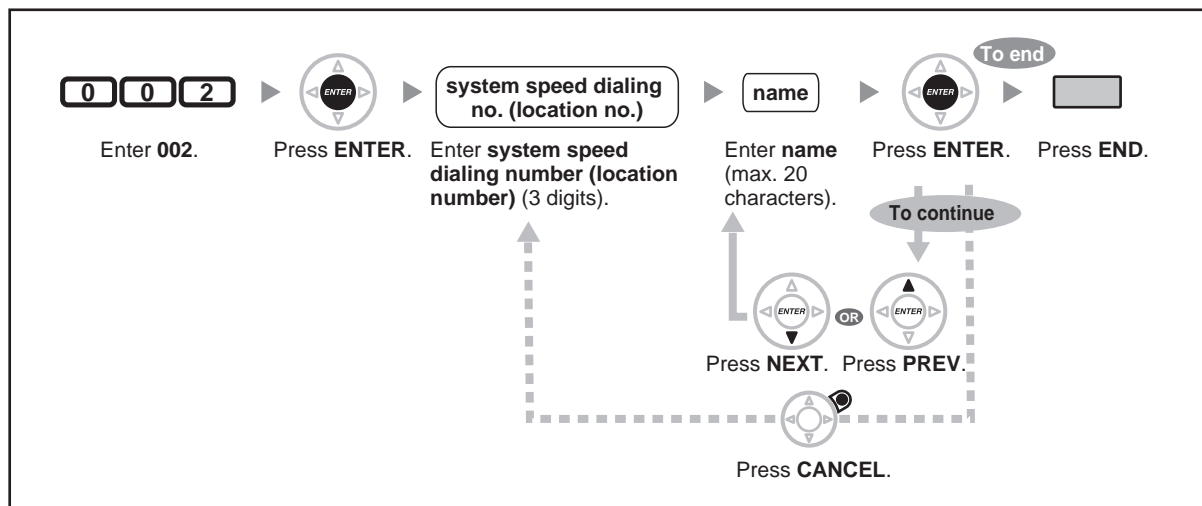

◆◆ [003] Extension Number

You can assign an extension number to each extension.

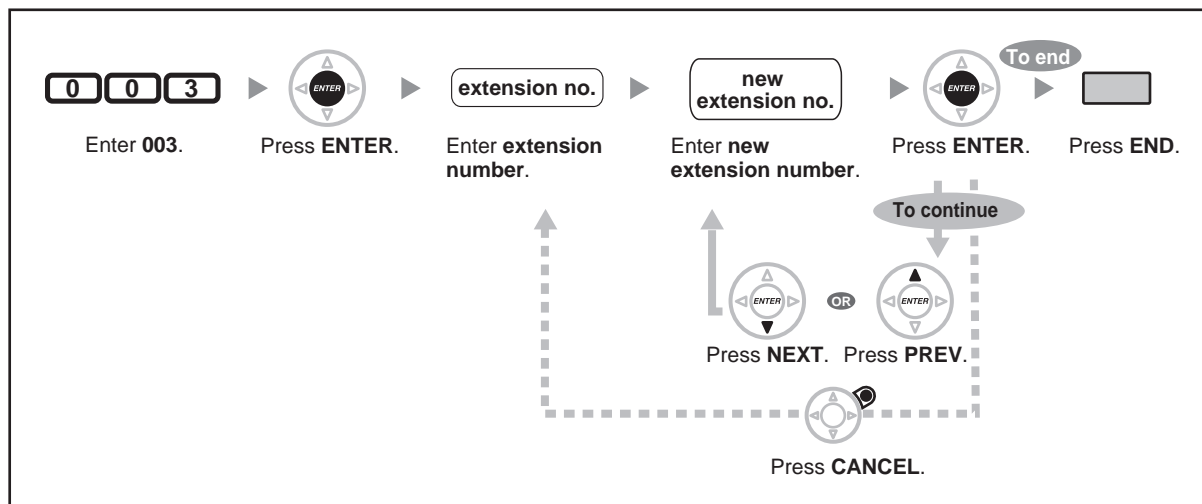

- The leading number(s) should be the same as the number(s) assigned for Flexible Numbering.
- A duplicate entry is invalid.

◆◆ [004] Extension Name

You can store the name of an extension user. This is useful if you want to know who is calling, or who you are calling when making an intercom call using the directory.

3.3.2 System Programming

To enter characters, refer to "1.3.14 Character Entry".

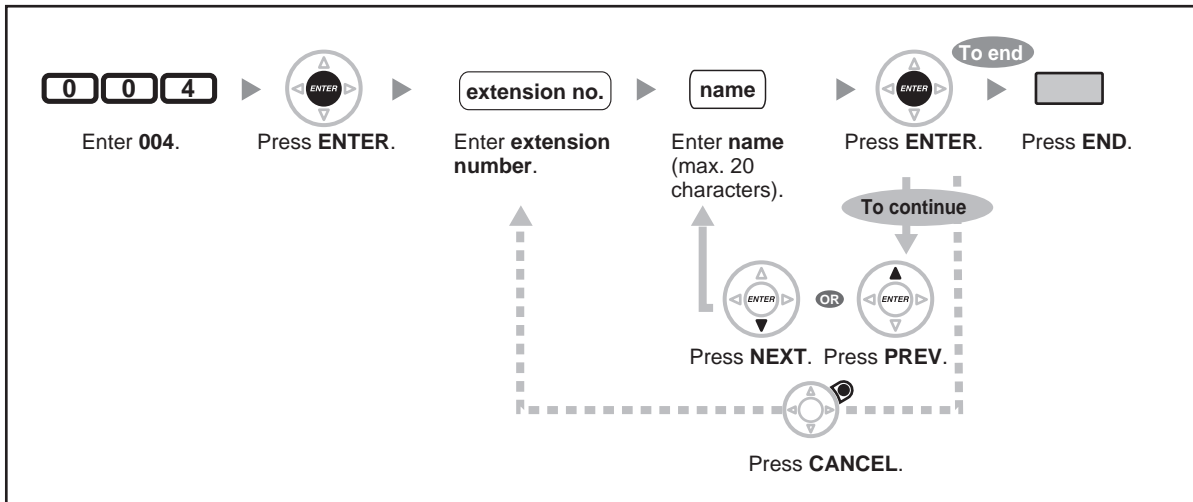

Section 4

Appendix

This chapter provides the Troubleshooting, the Feature Number Table and Tone List. Check the Troubleshooting section before consulting your dealer.

4.1 Troubleshooting

4.1.1 Troubleshooting

◆◆ Troubleshooting

Problem	Remedy
The telephone does not work properly.	<ul style="list-style-type: none"> ➡ Confirm with your manager that your settings are correct. ➡ If the problem persists, consult your dealer.
The telephone does not respond when buttons are pressed.	<ul style="list-style-type: none"> • The telephone is locked. ➡ Unlock your telephone. (👉 1.3.24 Extension Dial Lock, 2.1.5 Remote Extension Dial Lock) • Your telephone is connected to an eXtra Device Port. ➡ System programming is required. Consult your dealer.
Some features do not work.	<ul style="list-style-type: none"> • System management may restrict certain features. ➡ Consult your manager. • The feature numbers have changed. ➡ Confirm the revised number and try again.
Even though following the manual instructions, none of the operations work when using a proprietary telephone.	<ul style="list-style-type: none"> • The Intercom line was not seized. The seized line, when going off-hook, was changed by personal setting. (👉 3.1.2 Personal Programming) ➡ In the manual, going off-hook means an Intercom line is seized. If the setting has been changed, press the INTERCOM or PDN button after going off-hook and follow the instructions.
The paralleled single line telephones do not ring.	<ul style="list-style-type: none"> • "No ring" may be selected. Change the setting to ring. (👉 1.3.48 Paralleled Telephone)
The telephone does not work using the personal settings or with other settings. (One-touch dialing, forwarding destination, etc.)	<ul style="list-style-type: none"> • The extension line has been changed. The previous telephone's settings have not been cleared. ➡ Clear the settings and then program your desired settings again. (👉 1.3.25 Extension Feature Clear, 3.1.2 Personal Programming, 3.1.4 Customizing the Buttons)
My proprietary telephone does not have a feature button.	<ul style="list-style-type: none"> • Some models do not have the feature button. ➡ Change a flexible button to the desired button. (👉 3.1.4 Customizing the Buttons) ➡ Enter the specified feature number instead of the feature button. (👉 1.1.1 Before Operating the Telephones)

Problem	Remedy
A reorder tone is audible or "Restricted" is displayed.	<ul style="list-style-type: none"> • The telephone is locked. ➡ Unlock your telephone. (👉 1.3.24 Extension Dial Lock, 2.1.5 Remote Extension Dial Lock) • Toll restriction is activated. ➡ Consult your manager or dealer. • An account code is required. (👉 1.3.2 Account Code Entry, 1.3.68 Verification Code Entry, 1.3.74 Walking COS)
I cannot make an outside call using the One-touch Dialing button or speed dialing.	<ul style="list-style-type: none"> • A line access number was not stored. ➡ A line access number is required for outside calls. (👉 1.2.1 Making Calls, 3.1.4 Customizing the Buttons)
I cannot remember the feature numbers.	<ul style="list-style-type: none"> • ➡ If the feature numbers have been changed from the default values, write the new feature numbers in the table in "4.2.1 Feature Number Table". • ➡ Ask your dealer to change the feature numbers for easier use.
While talking to an outside party, the line is disconnected.	<ul style="list-style-type: none"> • The time limit has run out. (👉 1.3.11 Call Transfer, 1.3.16 Conference, Unattended) ➡ Consult your dealer to extend the time limit, if necessary.
Redialing does not function.	<ul style="list-style-type: none"> • The stored number was more than 32 digits or an extension number. (👉 1.3.59 Redial, Last Number)
I cannot have a conversation using the Bluetooth headset.	<ul style="list-style-type: none"> • ➡ Make sure that the headset is properly registered to the module. • ➡ Make sure that the headset is properly charged according to the manual of the headset. • ➡ Remove the wired headset from the headset jack. Priority is given to the wired headset when both are connected.
I cannot register, de-register, or confirm the ID of the Bluetooth headset.	<ul style="list-style-type: none"> • ➡ Make sure that the module is properly installed in the IP-PT/DPT.
The PC and fax machine communication failed.	<ul style="list-style-type: none"> • An indication tone may have interrupted communication. (👉 1.3.17 Data Line Security)
I do not want to show my telephone number to the calling or called party's telephone.	<ul style="list-style-type: none"> • (👉 1.3.53 Private Network Features—CLIR (Calling Line Identification Restriction), 1.3.55 Private Network Features—COLR (Connected Line Identification Restriction))
I want to show my telephone number to the calling or called party's telephone.	<ul style="list-style-type: none"> • (👉 1.3.52 Private Network Features—CLIP (Calling Line Identification Presentation), 1.3.54 Private Network Features—COLP (Connected Line Identification Presentation), 1.3.56 Private Network Features—Displaying Your Telephone Number on the Called Party's Telephone)

Problem	Remedy
I cannot send a call waiting tone to the dialed extension.	<ul style="list-style-type: none"> • The other party has not set the Call Waiting feature. (👉 1.3.13 Call Waiting Tone, 1.3.45 OHCA (Off-hook Call Announcement), 1.3.77 Whisper OHCA) • The other party has set Data Line Security. (👉 1.3.17 Data Line Security)
I forgot the password.	<ul style="list-style-type: none"> • Ask the manager to assist you. (👉 2.1.1 Dial Tone Transfer)
The background music started suddenly.	<ul style="list-style-type: none"> • ➡ Turn off the music. (👉 1.3.5 BGM (Background Music), 2.1.2 External BGM (Background Music))
I do not want to display a number which is stored in memory.	<ul style="list-style-type: none"> • ➡ Conceal the number. (👉 ◆◆ Storing New Names and Numbers, 3.1.4 Customizing the Buttons)
I want to confirm my extension number.	<ul style="list-style-type: none"> • (👉 Your Extension Number in 1.1.1 Before Operating the Telephones)
The date and time are not correct.	<ul style="list-style-type: none"> • Set the date and time by system programming. (👉 ◆◆ [000] Date & Time in 3.3.2 System Programming)
The display is not shown well.	<ul style="list-style-type: none"> • ➡ Change the Display contrast level. (👉 3.1.2 Personal Programming)
I want to distinguish the tones.	<ul style="list-style-type: none"> • (👉 To distinguish the ringing tones for each CO, ICD Group, PDN, SDN, or INTERCOM button (Digital proprietary telephone only), 3.1.4 Customizing the Buttons)
The MESSAGE button light lit.	<ul style="list-style-type: none"> • Another extension left you a message waiting indication while you were on the phone or away from your desk.
An SDN button on my extension does not work.	<ul style="list-style-type: none"> • A PDN button is not assigned on the extension corresponding to your SDN button. ➡ Create a PDN button on the desired extension. (👉 3.1.4 Customizing the Buttons)

4.2 Feature Number Table

4.2.1 Feature Number Table

Numbers listed below are the default settings. There are flexible feature numbers and fixed feature numbers. If you change the flexible feature numbers, fill in your assigned numbers (new) in the list for future reference.

Feature (While dial tone is heard)	Default (New)	Additional digits/buttons
1.2.1 Making Calls		
◆◆ Operator Call	0 ()	
Automatic Line Access	9 ()	outside phone no.
CO Line Group Access	8 ()	CO line group no. (2 digits) + outside phone no.
1.3.1 Absent Message	✖750 ()	
– To set		1–9 (+ parameter) + #
– To cancel		0
1.3.2 Account Code Entry	✖49 ()	account code + # + outside phone no.
1.3.4 Automatic Callback Busy (Camp-on)		
Automatic Callback Busy Cancel	✖46 ()	
1.3.5 BGM (Background Music)	✖751 ()	
– To select		BGM no. (1 digit)
– To cancel		0
1.3.6 Call Hold		
Call Hold/Call Hold Retrieve	✖50 ()	
Call Hold Retrieve		
– Specified with a held line number	✖53 ()	CO line no. which is held (3 digits)
– Specified with a holding extension number	✖51 ()	extension no. which has a held call
1.3.8 Call Park	✖52 ()	
– To set		parking zone no. (2 digits)/✖
– To retrieve		stored parking zone no. (2 digits)
1.3.9 Call Pickup		
◆◆ Call Pickup		

4.2.1 Feature Number Table

Feature (While dial tone is heard)	Default (New)	Additional digits/buttons
– Group	×40 ()	group no. (2 digits)
– Directed	×41 ()	extension no.
◆◆ Call Pickup Deny	×720 ()	
– To deny		1
– To allow		0
1.3.12 CALL WAITING FEATURES		
◆◆ Answering Call Waiting in the PBX	×50 ()	
◆◆ Answering Call Waiting from the Telephone Company	×60 ()	
1.3.13 Call Waiting Tone		
1.3.45 OHCA (Off-hook Call Announcement)		
1.3.77 Whisper OHCA		
– For intercom calls (No call/Tone/OHCA/Whisper OHCA)	×731 ()	0 (No call)/1 (Tone)/2 (OHCA)/3 (Whisper OHCA)
– For outside calls	×732 ()	0 (No tone)/1 (Tone)
1.3.17 Data Line Security		
– To set	×730 ()	1
– To cancel		0
1.3.18 DISA (Direct Inward System Access)		
◆◆ Calling through DISA		
– To an extension (In All Security Mode only)	×47 ()	your extension no./(× + verification code) + extension PIN/verification code PIN + extension no.
– To an outside party (In Trunk Security Mode/All Security Mode only)		your extension no./(× + verification code) + extension PIN/verification code PIN + outside phone no.
1.3.19 DND (Do Not Disturb)		
– Both Calls	×710 ()	0 (Cancel)/
– Outside Calls	×711 ()	1 (Set)
– Intercom Calls	×712 ()	
1.3.20 Door Open		
	×55 ()	doorphone no. (2 digits)

Feature (While dial tone is heard)	Default (New)	Additional digits/buttons
1.3.21 Doorphone Call	*31 ()	doorphone no. (2 digits)
1.3.22 EFA (External Feature Access)	*60 ()	service code
1.3.23 Executive Busy Override ◆◆ Executive Busy Override Deny		
– To prevent	*733 ()	1
– To allow		0
1.3.24 Extension Dial Lock		
– To lock	*77 ()	1
– To unlock		0 + extension PIN
– To make an outside call while your extension is locked	*47 ()	your extension no. + extension PIN + phone no.
1.3.25 Extension Feature Clear	*790 ()	
1.3.26 Extension PIN (Personal Identification Number)	*799 ()	
– To set		1 + extension PIN + # + same extension + #
– To cancel		0 + stored extension PIN
1.3.27 External Relay	*56 ()	relay no. (2 digits)
1.3.29 FWD (Call Forwarding)		
– Both Calls	*710 ()	0 (Cancel)/
– Outside Calls	*711 ()	2 (All calls) + phone no. + #/
– Intercom Calls	*712 ()	3 (Busy) + phone no. + #/ 4 (No Answer) + phone no. + #/ 5 (Busy/No Answer) + phone no. + #/ 7 (Follow Me) + your extension no./ 8 (Follow Me Cancel) + your extension no.
– To set the timer for "No Answer" and "Busy/No Answer"	*713 ()	00–99 (second)
Call Forwarding (FWD) for your Incoming Call Distribution Group		
– Both Calls	*714 ()	1 (Set) + ICD group extension no. + phone no. + #/0 (Cancel) + ICD group extension no.

4.2.1 Feature Number Table

Feature (While dial tone is heard)	Default (New)	Additional digits/buttons
– Outside Calls	*715 ()	
– Intercom Calls	*716 ()	
1.3.34 Hot Line	*740 ()	
– To store		2 + phone no. + #
– To set		1
– To cancel		0
1.3.37 ICD Group Features—Incoming Call Queue Monitor ¹	*739 ()	ICD group extension no.
1.3.38 ICD Group Features—Log-in/Log-out		
Log-in	*736 ()	1 + ICD group extension no./*
Log-out		0 + ICD group extension no./*
To enter/leave Not Ready mode	*735 ()	1 (Not Ready)/0 (Ready)
1.3.42 Message Waiting		
For a caller	*70 ()	
– To leave/cancel		1/0 + extension no.
For a called extension		
– To call back		2
– To clear		0 + your extension no.
1.3.47 Paging		
◆◆ Group Paging	*33 ()	paging group no. (2 digits)
– To answer	*43 ()	
– To deny	*721 ()	1
– To allow		0
1.3.48 Paralleled Telephone	*39 ()	
– Ring		1
– No Ring		0
1.3.50 Printing Message	*761 ()	message no. (+ parameter) + #
1.3.52 Private Network Features—CLIP (Calling Line Identification Presentation)	*7*2 ()	
– Public		1

Feature (While dial tone is heard)	Default (New)	Additional digits/buttons
– Your extension		2
1.3.53 Private Network Features—CLIR (Calling Line Identification Restriction)	*7*1 ()	
– To show		1
– To prevent		2
1.3.54 Private Network Features—COLP (Connected Line Identification Presentation)	*7*2 ()	
– Public		1
– Your extension		2
1.3.55 Private Network Features—COLR (Connected Line Identification Restriction)	*7*0 ()	
– To show		1
– To prevent		2
1.3.56 Private Network Features—Displaying Your Telephone Number on the Called Party's Telephone		
– To prevent	*67 ()	
– To show	*68 ()	
1.3.57 Private Network Features—TIE Line Access	7 ()	private phone no.
1.3.59 Redial, Last Number	# ()	
1.3.62 Speed Dialing, Personal		
– To store	*30 ()	personal speed dialing no. (2 digits) + outside phone no. + #
– To dial	* ()	* + personal speed dialing no. (2 digits)
1.3.63 Speed Dialing, System		
– To dial	* ()	system speed dialing no. (3 digits)
1.3.64 SVM (Simplified Voice Message)		
◆◆ Recording a Normal Greeting Message		
– To record	*38	1
– To play back	()	2
– To clear		0

4.2.1 Feature Number Table

Feature (While dial tone is heard)	Default (New)	Additional digits/buttons
<p>◆◆ Recording a Greeting Message for Each Time Mode</p> <ul style="list-style-type: none"> – To record – To play back – To clear <p>To leave a voice message directly to another extension's message box</p> <p>◆◆ Listening to Voice Messages Left by Callers</p> <p>◆◆ Redirecting Your Calls to Your Message Box</p> <ul style="list-style-type: none"> – Both Calls – Outside Calls – Intercom Calls 	<p></p> <p>×710 ()</p> <p>×711 ()</p> <p>×712 ()</p>	<p>8 + 0 (Day)/1 (Night)/2 (Lunch)/3 (Break) + 1</p> <p>8 + 0 (Day)/1 (Night)/2 (Lunch)/3 (Break) + 2</p> <p>8 + 0 (Day)/1 (Night)/2 (Lunch)/3 (Break) + 0</p> <p># + 6 + extension no.</p> <p>3</p> <p>0 (Cancel)/</p> <p>2 (All Calls) + floating extension no. for the SVM feature² + #/</p> <p>3 (Busy) + floating extension no. for the SVM feature² + #/</p> <p>4 (No Answer) + floating extension no. for the SVM feature² + #/</p> <p>5 (Busy/No Answer) + floating extension no. for the SVM feature² + #</p>
<p>1.3.65 TAFAS (Trunk Answer From Any Station)</p> <ul style="list-style-type: none"> – Calls through an external speaker 	<p>×42 ()</p>	<p>speaker no. (1 digit)</p>
<p>1.3.66 Timed Reminder</p> <ul style="list-style-type: none"> – To set – To cancel 	<p>×760 ()</p>	<p>12H: 1 + time (hour/minute) + 0 (AM)/1 (PM) + 0 (once)/1 (daily)</p> <p>24H: 1 + time (hour/minute) + 0 (once)/1 (daily)</p> <p>0</p>
<p>1.3.68 Verification Code Entry</p>	<p>×47 ()</p>	<p>* + verification code + verification code PIN + phone no.</p>
<p>1.3.72 Voice Mail Features—Voice Mail Integration</p> <ul style="list-style-type: none"> – Both Calls – Outside Calls 	<p>×710 ()</p> <p>×711 ()</p>	<p>0 (Cancel)/</p> <p>2 (All Calls)/</p>

Feature (While dial tone is heard)	Default (New)	Additional digits/buttons
– Intercom Calls	*712 ()	3 (Busy)/ 4 (No Answer)/ 5 (Busy/No Answer) + voice mail floating extension no. ³ + #
1.3.73 Wake-up Call ⁴ – To set – To cancel – To confirm	*76* ()	12H: 1 + extension no. + hour/minute + 0 (AM)/1 (PM) + 0 (once)/1 (daily) 24H: 1 + extension no. + hour/minute + 0 (once)/1 (daily) 0 + extension no. 2 + extension no.
1.3.74 Walking COS – To make a call or set features from another extension – To make a call or set features through DISA	*47 ()	your extension no. + extension PIN + phone no./feature no.
1.3.75 Walking Extension	*727 ()	your extension no. + extension PIN
1.3.76 Walking Extension, Enhanced – To set an extension status to Service-out – To set an extension status to Service-in	*727 ()	# * + your extension no. + extension PIN
1.3.78 Wireless XDP Parallel Mode – To set – To cancel	*48 ()	1 + paired wired extension 0
2.1.2 External BGM (Background Music) ⁵ – To start – To stop	*35 ()	external pager no. (1 digit)/* + BGM no. (1 digit) external pager no. (1 digit)/* + 0
2.1.3 OGM (Outgoing Messages) ⁵ – To record – To play back – To record from an external BGM (MOH) port – To clear	*36 ()	1 + OGM floating extension no. ⁶ 2 + OGM floating extension no. ⁶ 31 + OGM floating extension no. ⁶ 0 + OGM floating extension no. ⁶
2.1.4 Private Network Features—NDSS (Network Direct Station Selection) Monitor Release	*784 ()	another PBX extension no. + #

4.2.1 Feature Number Table

Feature (While dial tone is heard)	Default (New)	Additional digits/buttons
2.1.5 Remote Extension Dial Lock		
– To unlock	*782 ()	extension no.
– To lock	*783 ()	extension no.
2.1.6 Time Service Mode Control ^{*7}	*780 ()	
– Day/Night/Lunch/Break		0/1/2/3

*1 Supervisor only

*2 The default floating extension number for the SVM feature is 591.

*3 The default voice mail floating extension number is 500.

*4 Hotel operator only

*5 Manager only

*6 The default of OGM floating extension numbers is 5xx (xx: two-digit number of message).

*7 Manager and preprogrammed extension user only

Feature (While busy, DND or call tone is heard)	Default
◆◆ Call Waiting (BSS [Busy Station Signaling])	1
◆◆ DND Override	
1.3.3 Alternate Calling—Ring/Voice	*
1.3.4 Automatic Callback Busy (Camp-on)	6
1.3.7 Call Monitor	5
1.3.23 Executive Busy Override	3
1.3.42 Message Waiting	4

Feature (While dialing or talking)	Fixed Number
◆◆ Conference	3
1.3.20 Door Open	
From any extension while talking to the doorphone	5

4.3 Tone

4.3.1 Tone

While on-hook

Ring Tones

The following tones are programmable allowing recognition of call type (Outside, Intercom or Doorphone).

Tone 1

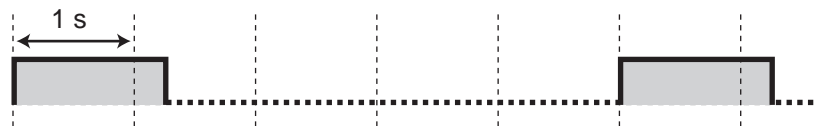

Tone 2



Tone 3



Tone 4

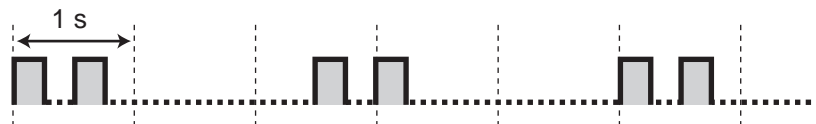

When going off-hook

Dial Tones

Tone 1

Normal



Tone 2

- When there are messages that have previously been listened to and no new messages recorded by the SVM feature
- When any of the following features are set:
 - Absent Message
 - Background Music
 - Call Forwarding
 - Call Pickup Deny
 - Call Waiting
 - Do Not Disturb
 - Extension Dial Lock
 - Executive Busy Override Deny
 - Hot Line
 - Timed Reminder



Tone 3

- After pressing TRANSFER or Recall/hookswitch to hold a call temporarily (e.g., Call Splitting)
- When the recording space of the Simplified Voice Message feature becomes almost full
- While a called PS is being searched
- When Account Code Entry is performed
- When answering a Timed Reminder call with no message
- When answering an external sensor call



Tone 4

Message waiting indication was received.



When you make calls

Busy Tone

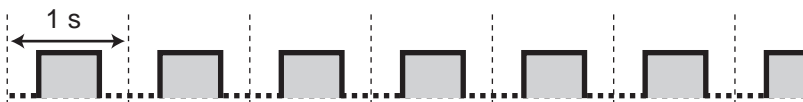

Reorder Tone

The CO line you tried to seize is not assigned or denied.



Ringback Tones

Tone 1



Tone 2



Do Not Disturb (DND) Tone
The dialed extension is refusing incoming calls.



While off-hook

Indication Tones

Tone 1

Call waiting tone

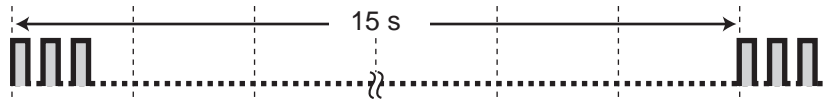

Tone 2

A call is on hold longer than the specified time

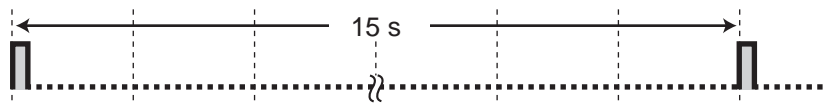

When talking to an outside party

Warning Tone

This tone is sent 15, 10 and 5 seconds before the specified time for disconnection.



When setting the features or programming

Confirmation Tones

Tone 1

- The feature setting was set successfully.
- A call is received in Voice-calling mode.



Tone 2

- Before receiving a page through an external speaker
- A call is received in Hands-free mode.



Tone 3

- Before the following features activate:
 - Retrieving a held call
 - Picking up another call
 - Paging/Answering a paging announcement
 - Answering the call through a speaker
- When a conversation is established with the extension in the following modes:
 - Hands-free Answerback mode
 - Voice-calling mode
- When making a call to or from a doorphone.

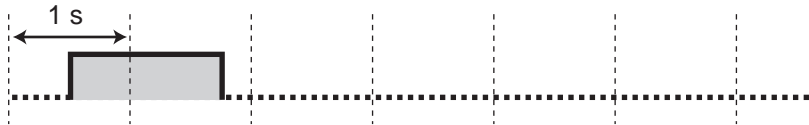

Tone 4

Establishing or leaving a conference



Tone 5

A call has been put on hold.



Index

Symbols

[000] Date & Time 185

[001] System Speed Dialing Number 186

[002] System Speed Dialing Name 187

[003] Extension Number 187

[004] Extension Name 187

A

Absent Message 34, 168, 193

Absent Message, Personal 34, 168

Account Button 26, 175

Account Code Entry 35, 193

Alternate Calling—Ring/Voice 36, 200

Alternate Receiving—Ring/Voice 167

Answer Button 24, 26, 87, 175

Answering Calls 32

AUTO ANS (Auto Answer)/MUTE Button 23

AUTO DIAL/STORE Button 23

Automatic Call Hold 41, 108

Automatic Call Waiting 167

Automatic Callback Busy 36, 200

Automatic Callback Busy Cancel 37, 193

Automatic Line Access 31, 193

B

Background Music (BGM) 38, 169, 193

Backlight, Display 166

Before Operating the Telephones 20

BGM → Background Music 38, 169, 193

BGM, External 158, 199

Bluetooth Wireless Headset Registration 169

Bluetooth Wireless Headset Removal 169

Boss & Secretary feature 78

Busy Station Signaling (BSS) → Call Waiting 48, 200

Busy Tone 202

Buttons on the PT 23

Buttons, Customizing 25, 174

Buttons, Flexible 25

Buttons, Proprietary Telephone 23

C

Call Forwarding (FWD) 77, 195

Call Forwarding (FWD) Button 24

Call Forwarding (FWD) for your Incoming Call Distribution Group 80

Call Forwarding (FWD)/Do Not Disturb (DND)—Both calls Button 26, 174

Call Hold 38, 193

Call Hold Retrieve 40, 193

Call Hold Retrieve, PDN/SDN Button 107

Call Log Button 26, 175

Call Log for ICD Group Button 26, 175

Call Log History for ICD Group 91

Call Log, Incoming 146

Call Log, Outgoing 148

Call Monitor 41, 200

Call Park 41, 193

Call Park (Automatic Park Zone) Button 26, 175

Call Park Button 26, 175

Call Park Retrieve 42

Call Pickup 43, 193

Call Pickup Deny 44, 194

Call Splitting 44

Call Transfer 45

Call Waiting 48, 200

CALL WAITING FEATURES 48

Call Waiting Tone 49, 53

Call Waiting Tone Type Selection 168

Call Waiting, Answering from PBX 49, 194

Call Waiting, Answering from Telephone Company 53, 194

Call Waiting, Automatic 167

Call Waiting, Manual 168

Call, To PDN Extension 106

Calling Line Identification Presentation

(CLIP) 110, 166, 196

Calling Line Identification Restriction (CLIR) 111, 166, 197

Calling Line Identification Restriction (CLIR)

Button 26, 175

Calling, Other Extension 30

Calling, Outside Party 31

Calling, Through DISA 63

Camp-on → Automatic Callback Busy 36, 200

CANCEL Button 25

Character Entry 54

Check-in Button 27, 176

Check-out Button 27, 176

Cleaned-up Button (KX-TDE600 only) 27, 176

CLIP → Calling Line Identification

Presentation 110, 166, 196

CLIR → Calling Line Identification

Restriction 111, 166, 197

CO Line Group Access 31, 193

COLP → Connected Line Identification

Presentation 111, 166, 197

COLR → Connected Line Identification

Restriction 112, 197

CONF (Conference) Button 24

Conference 57

Conference (Three-party), Leaving 60

Conference Button 26, 175

Conference, Unattended 61

Confirmation Tones 203

Connected Line Identification Presentation

(COLP) 111, 166, 197

Connected Line Identification Restriction (COLR) 112, 197

Connected Line Identification Restriction (COLR)

Button 26, 175

Connection Example 29

CTI Button 27, 175

Customized Buttons 25

D

Data Line Security 62, 194

Dial Tone Transfer 158

Dial Tones 201

Direct Inward System Access (DISA) 63, 194

Direct Station Selection (DSS) Button 25, 174

Directories 151

DISA → Direct Inward System Access 63, 194

Display 21

Display Backlight Selection 166

Display Features 146

Display Language Selection 165
 Display Lock 170
 Display Switching Mode 165
 DND → Do Not Disturb 66, 194
 DND Override 200
 Do Not Disturb (DND) 66, 194
 Do Not Disturb (DND) Button 24
 Do Not Disturb (DND) Tone 203
 Door Open 69, 194
 Doorphone Call 70, 195
 DSS → Direct Station Selection 25, 174

E

EFA → External Feature Access 71, 195
 Electronic Station Lockout → Extension Dial Lock 73, 170, 195
 Enhanced DSS Key Mode 106
 Enhanced Walking Extension 142, 199
 ENTER Button 25
 Exclusive Call Hold 38
 Executive Busy Override 71, 200
 Executive Busy Override Deny 73, 169, 195
 Extension Dial Lock 73, 170, 195
 Extension Feature Clear 74, 195
 Extension number, Confirming Your Own 21
 Extension PIN (Personal Identification Number) 75, 169, 195
 External BGM 158, 199
 External Feature Access (EFA) 71, 175, 195
 External Feature Access (EFA) Button 26, 175
 External Relay 76, 195
 External Sensor 77

F

Feature Highlights 2
 Feature Number Table 193
 Feature Numbers 20
 Fixed Buttons 23
 FLASH/RECALL Button 24
 Flexible Buttons 25
 Forced Answerback Selection 167
 FWD → Call Forwarding 78, 195
 FWD N/A Timer 168
 FWD—All Calls 78
 FWD—Busy 78
 FWD—Busy/No Answer 78
 FWD—Follow Me 78
 FWD—No Answer 78
 FWD/DND Cycle Switch Mode 67, 81
 FWD/DND Setting Mode 67, 81
 FWD/DND settings, FWD/DND fixed button 82
 FWD/DND status, switching with FWD/DND fixed button 68, 82
 FWD/DND—Intercom calls Button 26, 174
 FWD/DND—Outside calls Button 26, 174

G

G-CO → Group-CO 25, 174
 Greeting Message (SVM), Recording 121, 122
 Group FWD—Both calls Button 26, 174

Group FWD—Intercom calls Button 26, 175
 Group FWD—Outside calls Button 26, 174
 Group Paging 196
 Group-CO (G-CO) Button 25, 174

H

Hands-free Answerback 84
 Hands-free Operation 85
 Handset/Headset Selection → Headset Operation 85, 169
 Headset Button 26, 175
 Headset Operation 86, 169
 HOLD Button 24
 Hold, Call 38, 193
 HOSPITALITY FEATURES 89
 Hot Line 89, 166, 196
 Hurry-up Button 26, 175
 Hurry-up Transfer → Manual Queue Redirection 97

I

ICD Group → Incoming Call Distribution Group 25, 90
 ICD GROUP FEATURES 90
 Icon Description, Preparations 22
 Icon Description, System Programming 182
 Icon Descriptions 22
 Incoming Call Distribution Group (ICD Group) 25, 174
 Incoming Call Distribution Group (ICD Group) Button 25, 174
 Incoming Call Log 146
 Incoming Call Queue Monitor 92, 196
 Indication Tones 203
 INTERCOM Button 23
 Intercom Call 30

J

Jog Dial 21, 24

K

Key Pad Tone Set 169

L

L-CO → Loop-CO 25, 174
 LCS → Live Call Screening 134
 LCS Mode Set (After Answering) 167
 Live Call Screening (LCS) 134
 Live Call Screening (LCS) Button 27, 176
 Live Call Screening Mode Set 167
 Lock, Display 170
 Lock, Extension Dial 73, 170, 195
 Lock, Remote Extension Dial 161, 200
 Log-in/Log-out 93, 196
 Log-in/Log-out Button 26, 175
 Log-in/Log-out for all groups Button 26, 175
 Log-in/Log-out Monitor and Remote Control 95
 Log-in/Log-out of a specified group Button 26, 175
 Loop-CO (L-CO) Button 25, 174

M

Making Calls 30

Manager Password 179
 Manager Programming 179
 Manual Call Waiting 168
 Manual Queue Redirection 97
 Message Box, Accessing from Outside 129
 Message Box, Accessing Other Extension's 130
 Message Box, Redirecting to 124
 Message Button 23, 25, 174
 Message Display (Absent Message) 34
 Message for Another Extension Button 25, 174
 Message Waiting 99, 196, 200
 Message, Absent 34
 Message, OGM 158, 199
 Message, SVM 120, 197
 MODE Button 25
 MONITOR Button 23
 Mute 101

N

Navigator Key 21, 24
 NDSS → Network Direct Station Selection 160, 199
 NDSS Monitor Release 160, 199
 Network Direct Station Selection (NDSS) 160, 199
 Network Direct Station Selection (NDSS) Button 27, 175
 NEXT PAGE Key 25

O

Off-hook Call Announcement (OHCA) 49, 102
 Off-hook Monitor 101
 OGM → Outgoing Messages 158, 199
 OHCA → Off-hook Call Announcement 49, 102
 One-touch Dialing 102
 One-touch Dialing Assignment Mode Selection 170
 One-touch Dialing Button 25, 174
 One-touch Transfer 47
 One-touch Two-way Transfer 136
 One-touch Two-way Transfer Button 27, 176
 Operating Telephones, Preparations 20
 Operator Call 31, 193
 Outgoing Call Log 148
 Outgoing Messages (OGM) 158, 199

P

Paging 103, 196
 Paging Deny 104, 169, 196
 Paging, and Transferring 104
 Paging, Group 103, 196
 Paralleled Telephone 104, 167, 196
 Password, Manager 179
 Password, System 182
 PAUSE Button 23
 PDN → Primary Directory Number 105
 PDN Extension 105
 Personal Absent Message 34, 168
 Personal Programming 164
 Personal Speed Dialing 119, 197
 PF → Programmable Feature 25
 Pickup Dialing → Hot Line 89, 166, 196
 PIN → Extension Personal Identification Number 75, 169

PIN → Verification Code Personal Identification Number 133
 Portable Station (PS), Registration 20
 Predialing 32
 Preferred Line Assignment—Incoming 167
 Preferred Line Assignment—Outgoing 166
 Primary Directory Number (PDN) Button 27, 176
 Printing Message 108, 196
 Privacy Release 109
 PROGRAM Button 24
 Programmable Feature (PF) Button 25
 Programming Feature Clear 172
 Programming Information, Manager 179
 Programming Information, Personal 164
 Programming Information, System 182
 Programming, Manager 179
 Programming, Personal 164
 Programming, System 185
 PS, Registration 20

Q

Quick Dialing 114

R

Redial Button 23
 Redial, Last Number 114, 197
 Relay → External Relay 76, 195
 Release Button 24, 26, 87, 175
 Remote Extension Dial Lock 161, 200
 Remote Station Lock Control → Remote Extension Dial Lock 161, 200
 Remote Wake-up Call 131, 138, 199
 Reorder Tone 202
 Ring Tones 201
 Ringback Tones 202
 Ringing Method (Ring/Voice) 36
 Room Status Control 115

S

S-CO → Single-CO 25, 174
 S-CO Line Access 32
 SDN → Secondary Directory Number 105
 SDN Direct Dial 106
 SDN Extension 105
 SDN Walking COS 107
 Secondary Directory Number (SDN) Button 27, 176
 SELECT Button 25
 Self Labeling (KX-NT366 only) 118
 Self Labeling Display Contrast 166
 Sensor → External Sensor 77
 SHIFT Button 25
 Showing/Preventing Caller ID for Outgoing Calls 197
 Simplified Voice Message (SVM) 120, 197
 Single-CO (S-CO) Button 25, 174
 SIP → Session Initiation Protocol 5
 SIP Extension, Characteristics 5
 SIP Extension, Registration 20
 Soft Buttons 23
 SP-PHONE Button 23
 Speed Dialing, Personal 119, 197

Speed Dialing, System 120, 197
 Standard SDN Key Mode 106
 Station Program Clear → Extension Feature Clear 74, 195
 Station Speed Dialing → Personal Speed Dialing 119, 197
 Storing New Names and Numbers 151
 Supervisory Features—SUMMARY 97
 SVM → Simplified Voice Message 120, 197
 SVM Log 125
 System Alarm Button 26, 175
 System Feature Access 152
 System Password 182
 System Programming 182, 185
 System Speed Dialing 120, 197
 Walking Extension 141, 199
 Walking Extension, Enhanced 142
 Walking Station → Walking Extension 141, 199
 Warning Tone 203
 Whisper OHCA 49, 144
 Wireless XDP Parallel Mode 145, 199
 Wrap-up 93
 Wrap-up Button 26, 175

Y

Your Extension Number 21

T

TAFAS → Trunk Answer From Any Station 130, 198
 Telephone Number, Sending/Hiding 112
 Telephone Types 20
 Terminate Button 26, 175
 TIE Line Access 113, 197
 Time Service 132
 Time Service (Day/Night/Lunch/Break) Button 26, 175
 Time Service Mode Control 161, 200
 Time Service Switching Mode (Automatic/Manual) Button 27, 175
 Timed Reminder 130, 139, 198
 Toll Restriction (TRS) Button 26, 175
 Tone Types 201
 TRANSFER Button 24
 Transfer, SDN Button 108
 Transfer, To PDN Extension 108
 Transferring Calls, To Other Extension 46
 Transferring Calls, To Outside Party 47
 Troubleshooting 190
 Trunk Answer From Any Station (TAFAS) 130, 198
 Two-way Record 136
 Two-way Record Button 27, 176
 Two-way Transfer 136
 Two-way Transfer Button 27, 176

U

Unattended Conference 61

V

Verification Code Entry 133, 198
 Verification Code PIN (Personal Identification Number) 133
 Virtual PS 82
 VOICE CALL/MUTE Button 24
 VOICE MAIL FEATURES 133
 Voice Mail Integration 137, 198
 Voice Mail Transfer 137, 138
 Voice Mail Transfer Button 27, 176
 Voice Messages (SVM), Leaving 125
 Voice Messages (SVM), Listening to 125
 Volume Key 21, 24

W

Wake-up Call, Remote 131, 199
 Walking COS 140, 199

When you ship the product

Carefully pack and send it prepaid, adequately insured and preferably in the original carton. Attach a postagepaid letter, detailing the symptom, to the outside of the carton. DO NOT send the product to the Executive or Regional Sales offices. They are NOT equipped to make repairs.

Product Service

Panasonic Factory Service Centers for this product are listed in the service center directory. Consult your certified Panasonic dealer for detailed instructions.

For Future Reference

Please print, record, and retain the following information for future reference.

Note

The serial number of this product can be found on the label affixed to the unit. You should record the model number and the serial number of this unit as a permanent record of your purchase to aid in identification in the event of theft.

MODEL NO.	_____
SERIAL NO.	_____
DATE OF PURCHASE	_____
NAME OF DEALER	_____
DEALER'S ADDRESS	_____ _____ _____
DEALER'S TEL. NO.	_____

**Panasonic Consumer Electronics Company,
Division of Panasonic Corporation of North America**

One Panasonic Way, Secaucus, New Jersey 07094

<http://www.panasonic.com/csd>

Copyright:

This material is copyrighted by Panasonic Communications Co., Ltd., and may be reproduced for internal use only. All other reproduction, in whole or in part, is prohibited without the written consent of Panasonic Communications Co., Ltd.

© Panasonic Communications Co., Ltd. 2007