

1 YEAR
WARRANTY



**UK
CA**



Ω OMEGA™ **User's Guide**

*Shop online
at
omega.com*

*e-mail: info@omega.com
For latest product
manuals:
[www.omega.com/en-
us/pdf-manuals](http://www.omega.com/en-us/pdf-manuals)*

PLATINUM™ Series



CN32Pt, CN16Pt, CN16PtD, CN8Pt, CN8PtD, CN8Ept
Temperature & Process Controllers



omega.com info@omega.com

Omega Engineering, Inc:

800 Connecticut Ave. Suite 5N01, Norwalk, CT 06854, USA

Toll-Free: 1-800-826-6342 (USA & Canada only)

Customer Service: 1-800-622-2378 (USA & Canada only)

Engineering Service: 1-800-872-9436 (USA & Canada only)

Tel: (203) 359-1660

Fax: (203) 359-7700

e-mail: info@omega.com

**Omega Engineering,
Limited:**

1 Omega Drive, Northbank,
Irlam Manchester M44 5BD
United Kingdom

**Omega Engineering,
GmbH:**

Daimlerstrasse 26 75392
Deckenpfronn Germany

Table of Contents, Figures and Tables

- 1. Introduction 8
 - 1.1 Description 8
- 2. Safety Considerations 9
- 3. Wiring Instructions 10
 - 3.1 Back Panel Connections 10
 - 3.2 Connecting Power 11
 - 3.3 Connecting Inputs 12
 - 3.4 Connecting Outputs 14
- 4. PLATINUM™ Series Navigation 16
 - 4.1 Description of Button Actions 16
 - 4.2 Menu Structure 16
 - 4.3 Level 1 Menu 17
 - 4.4 Circular Flow of Menus 17
- 5. Complete Menu Structure 18
 - 5.1 Initialization Mode Menu (INIt) 18
 - 5.2 Programming Mode Menu (PRoG) 22
 - 5.3 Operating Mode Menu (oPER) 25
- 6. Reference Section: Initialization Mode (INIt) 27
 - 6.1 Input Configuration (INIt > INPt) 27
 - 6.1.1 Thermocouple Input Type (INIt > INPt > t.C.) 27
 - 6.1.2 Resistance Temperature Detector (RTD) Input Type (INIt > INPt > Rtd) 28
 - 6.1.3 Thermistor Input Type Configuration (INIt > INPt > tHRM) 28
 - 6.1.4 Process Input Type Configuration (INIt > INPt > PRoC) 29
 - 6.2 TARE (INIt > tARE) 34
 - 6.3 LINR (INIt > LINR) 34
 - 6.4 Display Reading Formats (INIt > RdG) 36
 - 6.4.1 Decimal Point Format (INIt > RdG > dEC.P) 36
 - 6.4.2 Temperature Units (INIt > RdG > °F°C) 36
 - 6.4.3 Display Rounding (INIt > RdG > d.RNd) 37
 - 6.4.4 Filter (INIt > RdG > FLtR) 37
 - 6.4.5 Annunciator Settings (INIt > RdG > ANN.1/ANN.2) 38
 - 6.4.6 Normal Color (INIt > RdG > NCLR) 38
 - 6.4.7 Brightness (INIt > RdG > bRGt) 38
 - 6.5 Excitation Voltage (INIt > ECtN) 39
 - 6.6 Communication (INIt > CoMM) 39
 - 6.6.1 Protocol (INIt > CoMM > USb, EtHN, SER > PRot) 39
 - 6.6.2 Address (INIt > CoMM > USb, EtHN, SER > AddR) 40
 - 6.6.3 Serial Communications Parameters (INIt > CoMM > SER > C.PAR) 41
 - 6.7 Safety Features (INIt > SFty) 42
 - 6.7.1 Power On Confirmation (INIt > SFty > PwoN) 42
 - 6.7.2 Operating Mode Confirmation (INIt > SFty > oPER) 42
 - 6.7.3 Setpoint Limits (INIt > SFty > SP.LM) 43
 - 6.7.4 Loop Break Timeout (INIt > SFty > SEN.M > LPbk) 43
 - 6.7.5 Open Circuit (INIt > SFty > SEN.M > o.CRk) 43
 - 6.7.6 Sensor Error Latch (INIt > SFty > SEN.M > E.LAT) 43
 - 6.7.7 Output Break detection (INIt > SFty > OUT.M > o.BRK) 44

- 6.7.8 Output Error Latch (INIt > SFTy > OUT.M > E.LAT) 44
- 6.8 Manual Temperature Calibration (INIt > t.CAL) 44
 - 6.8.1 No Manual Temperature Calibration Adjustment (INIt > t.CAL > NoNE)..... 45
 - 6.8.2 Manual Temperature Calibration Offset Adjustment (INIt > t.CAL > 1.PNt) 45
 - 6.8.3 Manual Temperature Calibration Offset and Slope Adjustment (INIt > t.CAL > 2.PNt)..... 45
 - 6.8.4 Temperature Ice Point Calibration (INIt > t.CAL > ICE.P) 46
- 6.9 Save Current Configuration for All Parameters to a File (INIt > SAVE) 46
- 6.10 Load a Configuration for All Parameters from a File (INIt > LoAd) 46
- 6.11 Display Firmware Revision Number (INIt > VER.N)..... 46
- 6.12 Update Firmware Revision (INIt > VER.U)..... 47
- 6.13 Reset to Factory Default Parameters (INIt > F.dFt)..... 47
- 6.14 Password-Protect Initialization Mode Access (INIt > I.Pwd)..... 47
- 6.15 Password-Protect Programming Mode Access (INIt > P.Pwd)..... 47
- 7. Reference Section: Programming Mode (PRoG) 48
 - 7.1 Setpoint 1 Configuration (PRoG > SP1) 48
 - 7.2 Setpoint 2 Configuration (PRoG > SP2) 48
 - 7.3 Alarm Mode Configuration (PRoG > ALM.1, ALM.2)..... 49
 - 7.3.1 Alarm Type (PRoG > ALM.1, ALM.2 > tyPE)..... 49
 - 7.3.2 Absolute or Deviation Alarm (PRoG > ALM.1, ALM.2 > tyPE > Ab.dV)..... 50
 - 7.3.3 Alarm High Reference (PRoG > ALM.1, ALM.2 > tyPE > ALR.H) 50
 - 7.3.4 Alarm Low Reference (PRoG > ALM.1, ALM.2 > tyPE > ALR.L)..... 51
 - 7.3.5 Alarm Color (PRoG > ALM.1, ALM.2 > A.CLR)..... 51
 - 7.3.6 Alarm High High / Low Low Offset Value (PRoG > ALM.1, ALM.2 > HI.HI) 51
 - 7.3.7 Alarm Latching (PRoG > ALM.1, ALM.2 > LtCH) 52
 - 7.3.8 Alarm Normally Closed, Normally Open (PRoG > ALM.1, ALM.2 > CtCL) 52
 - 7.3.9 Alarm Power-On Behavior (PRoG > ALM.1, ALM.2 > A.P.oN)..... 52
 - 7.3.10 Alarm on Delay (PRoG > ALM.1, ALM.2 > dE.oN)..... 52
 - 7.3.11 Alarm Off Delay (PRoG > ALM.1, ALM.2 > dE.oF) 53
 - 7.4 Output Channel 1–6 Configuration (PRoG > oUt.1–oUt.6)..... 53
 - 7.4.1 Output Channel Mode (PRoG > oUt1–oUt6 > Mode) 54
 - 7.4.2 Output Cycle Pulse Width (PRoG > oUt1–oUt6 > CyCL)..... 56
 - 7.4.3 Analog Output Range (PRoG > oUt1–oUt6 > RNgE) 57
 - 7.5 PID Configuration (PRoG > PId.S)..... 58
 - 7.5.1 Action Response (PRoG > PId > ACTN) 58
 - 7.5.2 Autotune Timeout (PRoG > PId > A.to) 58
 - 7.5.3 Autotune (PRoG > PId > TUNE) 58
 - 7.5.4 PID Gain Settings (PRoG > PId > GAIN)..... 59
 - 7.5.5 Relative Cool Gain (PRoG > PId > rCg)..... 60
 - 7.5.6 Control Offset (PRoG > PId > oFst)..... 60
 - 7.5.7 Deadband (PRoG > PId > dEAd)..... 60
 - 7.5.8 Low Output Clamping Limit (PRoG > PId > %Lo) 60
 - 7.5.9 High Output Clamping Limit (PRoG > PId > %HI) 61
 - 7.5.10 Adaptive Tuning (PRoG > PId > AdPt) 61
 - 7.6 PID.2 Configuration (PRoG > PId.2)..... 61
 - 7.7 Remote Setpoint Configuration (PRoG > RM.SP)..... 61
 - 7.7.1 Cascade Control using Remote Setpoint..... 63
 - 7.8 Multi-Ramp/Soak Mode Parameters (PRoG > M.RMP) 64
 - 7.8.1 Multi-Ramp/Soak Mode Control (PRoG > M.RMP > R.CtL)..... 64

- 7.8.2 Select Program (PRoG > M.RMP > S.PRG)..... 65
- 7.8.3 Multi-Ramp/Soak Tracking (PRoG > M.RMP > M.tRk) 65
- 7.8.4 Time Format (PRoG > M.RMP > tIM.F) 65
- 7.8.5 Program End Action (PRoG > M.RMP > E.ACT) 66
- 7.8.6 Number of Segments (PRoG > M.RMP > N.SEG)..... 66
- 7.8.7 Segment Number for Editing (PRoG > M.RMP > S.SEG) 66
- 7.8.8 More on Multi-Ramp/Soak Programming 67
- 8. Reference Section: Operating Mode (oPER)..... 69
 - 8.1 Normal Run Mode (oPER > RUN) 69
 - 8.2 Change Setpoint 1 (oPER > SP1)..... 69
 - 8.3 Change Setpoint 2 (oPER > SP2)..... 70
 - 8.4 Manual Mode (oPER > MANL) 70
 - 8.5 Pause Mode (oPER > PAUS) 71
 - 8.6 Stop Process (oPER > StoP) 71
 - 8.7 Clear Latched Alarms (oPER > L.RSt)..... 71
 - 8.8 Display Valley Reading (oPER > VALy)..... 71
 - 8.9 Display Peak Reading (oPER > PEAK)..... 72
 - 8.10 Standby Mode (oPER > Stby) 72
 - 8.11 Standby Mode (oPER > tARE)..... 72
- 9. Specifications 73
 - 9.1 Inputs 73
 - 9.2 Control 73
 - 9.3 Outputs 74
 - 9.4 Communications (USB Standard, Optional Serial and Ethernet) 74
 - 9.5 Isolation..... 74
 - 9.6 General..... 75
- 10. Approvals Information 78

- Figure 1 – CN8Pt, CN8DPt and CN8EPt Models: Back Panel Connections
(No Isolated Output Expansion Board Installed) 10
- Figure 2 – CN8Pt, CN8DPt and CN8EPt Models: Back Panel Connections
(With Isolated Output Expansion Board)..... 10
- Figure 3 – CN16Pt and CN32Pt Models: Back Panel Connections 11
- Figure 4 – Main Power Connections 11
- Figure 5 – RTD Wiring Diagram 13
- Figure 6 – Process Current Wiring Hookup with Internal and External Excitation..... 13
- Figure 7 – Process Voltage Wiring Hookup with optional Ratiometric Voltage connection. 13
- Figure 8 – PLATINUM Series Displays (CN8DPt and CN8EPt Shown)..... 16
- Figure 9 – Circular Flow of Menus. 17
- Figure 10 – Alarm Range Option Diagram 50
- Figure 11 – Alarm HI.HI parameter..... 51

Figure 12 – Generic Cascade Control Diagram 63
Figure 13 – Heat Exchanger with Cascade Control..... 63
Figure 14 – Ramp & Soak Process Variable Period of Time. 67
Figure 15 – Ramp & Soak Current Process Variable. 68

Table 1 – 10-Pin Input Connector Wiring Summary	12
Table 2 – Interfacing Sensors to the Input Connector	12
Table 3 – Output Type Designations for Base Output Connector.	14
Table 4 – 8 Pin Output/Power Connector Wiring Summary by Configuration.....	14
Table 5 – 6 Pin Output Expansion Board Connector Wiring Summary by Configuration.....	15
Table 6 – Definitions for Abbreviations in Table 4.....	15
Table 7 – Alarm Range Option Comparison.....	50
Table 8 – Ranges and Accuracies for Supported Inputs	76
Table 9 – Error Code Descriptions	76

Using This Manual

[Section 3](#) of the manual will cover the back panel connections and wiring instructions. A quick overview of how to navigate the PLATINUM™ Series menu structure follows in [Section 4](#). This is followed in [Section 5](#) by the complete PLATINUM™ Series meter menu tree. Remember, not all commands and parameters in that menu tree will show up on your unit, as those that are not available with your configuration are automatically hidden. Repetitive menu structures are highlighted in gray and only shown once but are used multiple times; examples include scaling process inputs for the different process input ranges, setting up the data communications protocol for each of the communications channels, configuration for multiple outputs, etc.

The Reference Section—encompassing Initialization Mode in [Section 6](#), Programming Mode in [Section 7](#), and Operating Mode in [Section 8](#)—will provide more detail on what parameter and command preferences; such as how they operate, and why to choose a specific value.

1. Introduction

1.1 Description

The PLATINUM™ Series Controller offers unparalleled flexibility in process measurement. While the controller is extremely powerful and versatile, great care has gone into designing a product that is easy to set up and use. Automatic hardware configuration recognition eliminates the need for jumpers. The PLATINUM™ Series Controller displays only the menu items associated with the system's custom configuration.

Each unit allows the user to select the input type from 9 thermocouple types (J, K, T, E, R, S, B, C, and N), Pt RTDs (100, 500, or 1000 Ω , with a 385, 392, or 3916 curve), thermistors (2250 Ω , 5K Ω , and 10K Ω), DC voltage, or DC current. The analog voltage inputs may be single ended bipolar, differential absolute or differential ratiometric, and both voltage, and current are fully scalable using a single point or 10-point linearization to virtually all engineering units with a selectable decimal point that is perfect for use with pressure, flow, or other process inputs.

Control is achieved using the PID, on/off, or heat/cool control strategy. PID control can be optimized with an Autotune feature; and in addition, a fuzzy logic Adaptive Tuning Mode allows the PID algorithm to be continuously optimized. The instrument offers up to 16 Ramp and Soak segments per Ramp and Soak program (eight each), with auxiliary event actions available with each segment. Up to 99 Ramp and Soak programs can be stored, and multiple Ramp and Soak programs can be chained, creating unmatched ramp and soak programming capability. Multiple Alarms can be configured for above, below, hi/lo, and band triggering using either absolute or deviation Alarm trigger points.

The PLATINUM™ Series controller features a large, three-color, programmable display with the capability to change color every time the Alarm is triggered. Various configurations of mechanical relay, SSR, DC pulse, and isolated or non-isolated analog voltage or current outputs are available. Every unit comes standard with USB communications for firmware updates, configuration management, and data transfer. Optional Ethernet and RS-232 / RS-485 Serial communications are also available. The Analog Output is fully scalable and may be configured as a proportional controller or retransmission to follow your input signal. The universal power supply accepts 90–240 Vac. The low-voltage power option accepts 24 Vac or 12–36 Vdc.

Additional features usually found only on more expensive controllers make these the most powerful products in their class. Some additional standard features are remote Setpoint for cascaded control setups, High-high/Low-low Alarm functionality, external latch reset, external Ramp and Soak program initiation, combination Heat/Cool Control Mode, configuration save and transfer, and configuration password protection.

2. Safety Considerations

This device is marked with the international caution symbol. It is important to read this manual before installing or commissioning this device as it contains important information relating to Safety and EMC (Electromagnetic Compatibility).

This instrument is a panel mount device protected in accordance with EN 61010-1:2010, electrical safety requirements for electrical equipment for measurement, control, and laboratory use. Installation of this instrument should be done by qualified personnel.

 **In order to ensure safe operation, the following instructions must be followed and warnings observed:**

This instrument has no power-on switch. An external switch or circuit-breaker must be included in the installation as a disconnecting device. It must be marked to indicate this function, and it must be in close proximity to the equipment within easy reach of the operator. The switch or circuit-breaker must comply with the relevant requirements of IEC 947-1 and IEC 947-3 (International Electro technical Commission). The switch must not be incorporated in the main supply cord.

Furthermore, to provide protection against excessive energy being drawn from the main supply in case of a fault in the equipment, an overcurrent protection device must be installed.

- Do not exceed the voltage rating on the label located on the top of the instrument housing.
- Always disconnect the power before changing the signal and power connections.
- Do not use this instrument on a work bench without its case for safety reasons.
- Do not operate this instrument in flammable or explosive atmospheres.
- Do not expose this instrument to rain or moisture.
- Unit mounting should allow for adequate ventilation to ensure that the instrument does not exceed the operating temperature rating.
- Use electrical wires with adequate size to handle mechanical strain and power requirements. Install this instrument without exposing the bare wire outside the connector to minimize electrical shock hazards.

 **EMC Considerations**

- Whenever EMC is an issue, always use shielded cables.
- Never run signal and power wires in the same conduit.
- Use signal wire connections with twisted-pair cables.
- Install Ferrite Beads on signal wires close to the instrument if EMC problems persist.

 **Failure to follow all instructions and warnings is at your own risk and may result in property damage, bodily injury and/or death. Omega Engineering is not responsible for any damages or loss arising or resulting from any failure to follow any and all instructions or observe any and all warnings.**

3. Wiring Instructions

3.1 Back Panel Connections

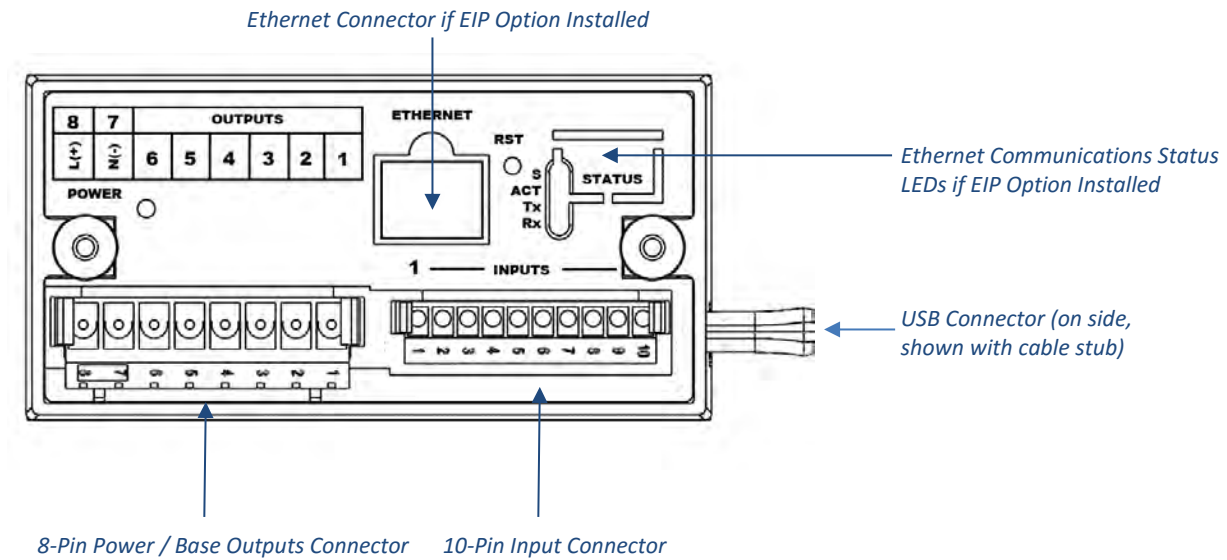

Figure 1 – CN8Pt, CN8Dpt and CN8Ept Models: Back Panel Connections (No Isolated Output Expansion Board Installed)

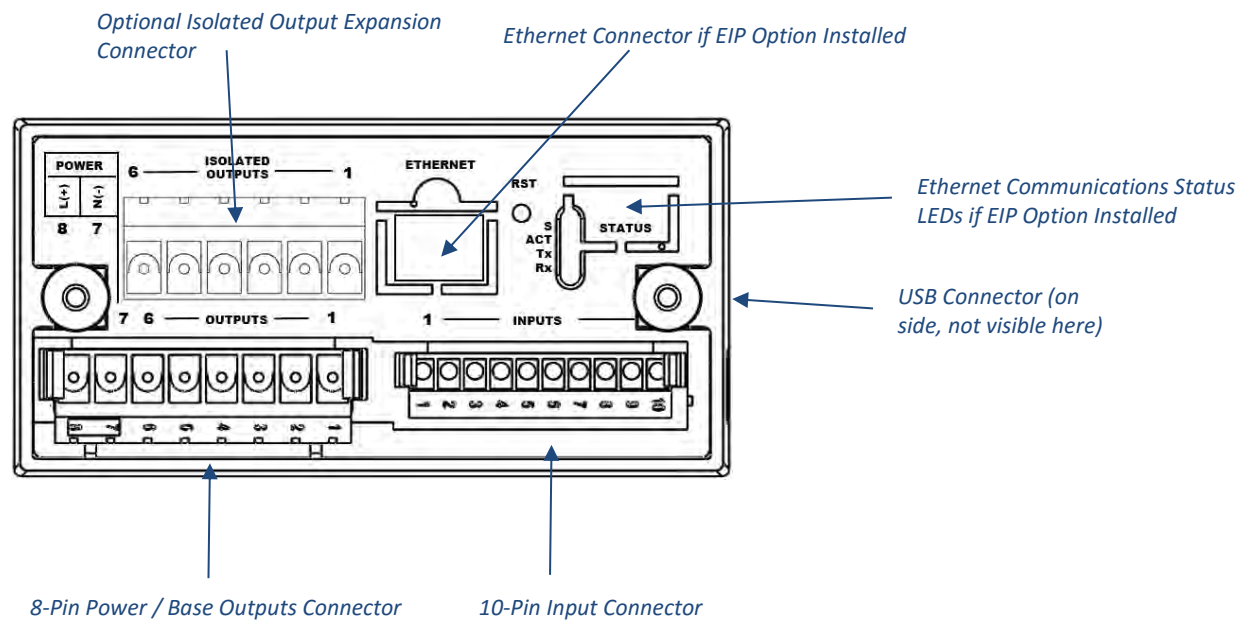

Figure 2 – CN8Pt, CN8Dpt and CN8Ept Models: Back Panel Connections (With Isolated Output Expansion Board)

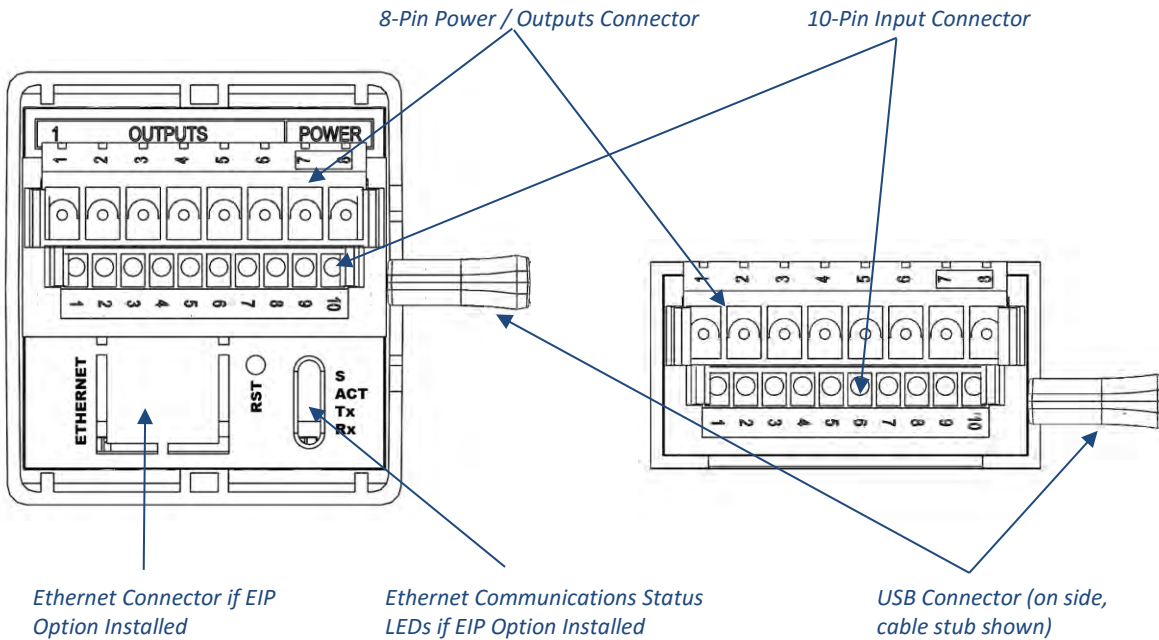
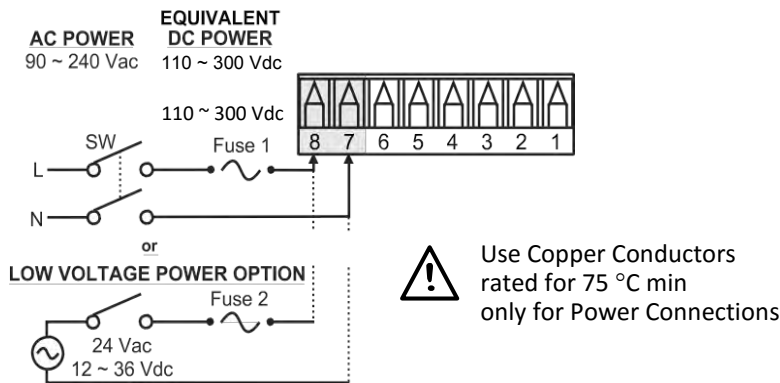

Figure 3 – CN16Pt and CN32Pt Models: Back Panel Connections

3.2 Connecting Power

Connect the main power connections to pins 7 and 8 of the 8-pin power / output connector as shown in Figure 4.



Caution: Do not connect power to your device until you have completed all input and output connections. Failure to do so may result in injury!

Figure 4 – Main Power Connections

For the low-voltage power option, maintain the same degree of protection as the standard high-voltage input power units (90–240 Vac) by using a Safety Agency Approved DC or AC source with the same Overvoltage Category and pollution degree as the standard AC unit (90–300 Vac).

The Safety European Standard EN61010-1 for measurement, control, and laboratory equipment requires that fuses must be specified based on IEC127. This standard specifies the letter code “T” for a Time-lag fuse.

3.3 Connecting Inputs

The 10-pin universal input connector assignments are summarized in **Table 1**. **Table 2** provides detail for the specific types of sensors supported. All sensor selections are firmware-controlled (see [4.1 Input Configuration \(INIT > INPt\)](#)) and no jumper settings are required when switching from one type of sensor to another. **Figure 5** provides more detail for connecting RTD sensors. **Figure 6** shows the connection scheme for process current input with either internal or external excitation. **Figure 7** shows the connections for Single Ended and Differential input voltages.

Table 1 – 10-Pin Input Connector Wiring Summary

Pin No.	Code	Description
1	ARTN	Analog return signal (analog ground) for sensors and remote Setpoint
2	AIN+	Analog positive input
3	AIN-	Analog negative input
4	APWR	Analog power currently only used for 4-wire RTDs
5	AUX	Auxiliary analog input for remote Setpoint
6	EXCT	Excitation voltage output referenced to ISO GND
7	DIN	Digital input signal (latch reset, etc.), Positive at > 2.5V, ref. to ISO GND
8	ISO GND	Isolated ground for serial communications, excitation, and digital input
9	RX/A	Serial communications receive
10	TX/B	Serial communications transmit

Table 2 – Interfacing Sensors to the Input Connector

Pin Number	Diff Voltage	Process Voltage	Process Current	Thermo-couple	2-Wire RTD	3-Wire RTD	4-Wire RTD	Thermistor	Remote Setpoint
1		Rtn			**	RTD2-	RTD2+		Rtn(*)
2	Vin +/-	Vin +/-	I+	T/C+	RTD1+	RTD1+	RTD1+	TH+	
3	Vd +/-		I-	T/C-			RTD2-	TH-	
4					RTD1-	RTD1-	RTD1-		
5									V/I In

*For Remote Setpoint with an RTD, Pin 1 on the Output Connector must be used for the Rtn instead of Pin 1 on the Input Connector. Remote Setpoint is not available if using an RTD sensor and have an SPDT (Type 3) Output installed.

** Requires external connection to pin 4

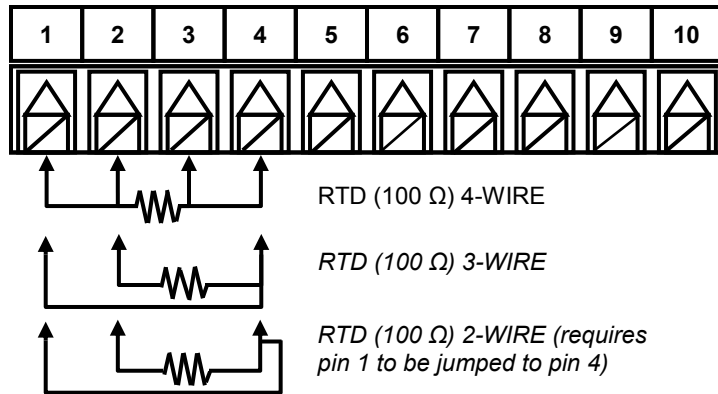

Figure 5 – RTD Wiring Diagram

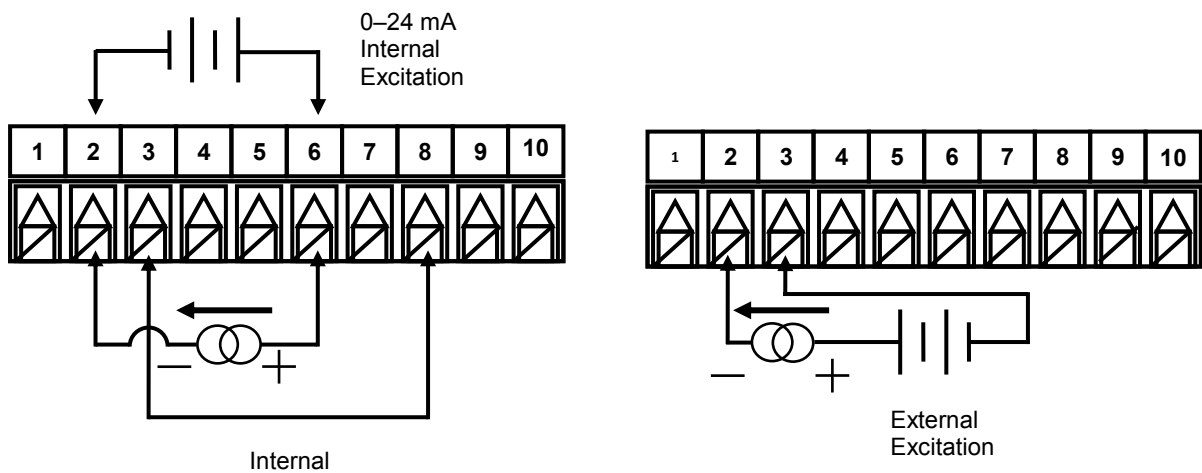

Figure 6 – Process Current Wiring Hookup with Internal and External Excitation

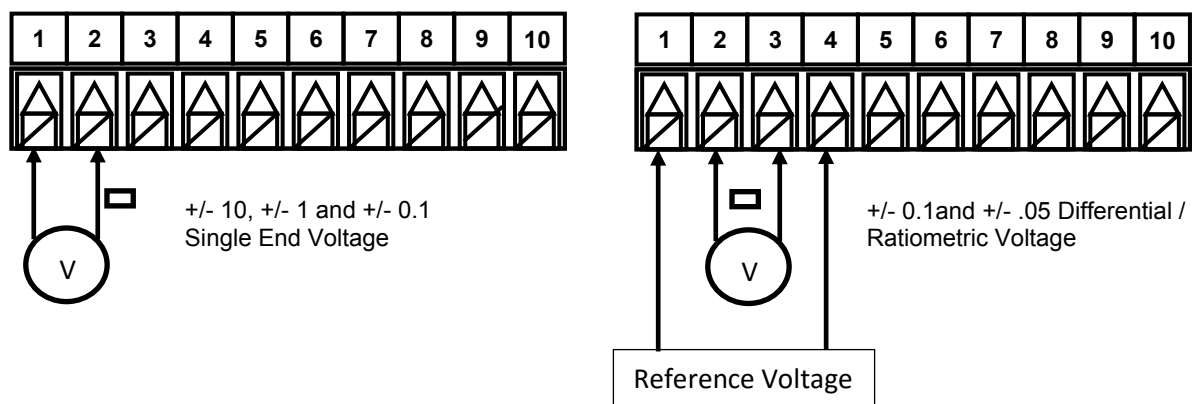

Figure 7 – Process Voltage Wiring Hookup with optional Ratiometric Voltage connection.

3.4 Connecting Outputs

The PLATINUM™ Series supports 7 different types of outputs with the model number numeric designations summarized in **Table 3**. The unit comes preconfigured with up to 3 outputs (up to 6 outputs with 1/8 DIN models). **Table 3** shows the base output connector connections for the different configurations offered. The base output configuration is the 3 numeric digits following the first dash in the model number. The optional isolated output expansion board offered on 1/8 DIN models can add 1 or 3 additional isolated outputs with the numeric codes and connection positions shown in **Table 3**. **Table 4** defines the abbreviated codes used in **Tables 5 and 6**. Please note that the SPST and SPDT mechanical relays have snubbers built in but only on the normally open contact side.

Table 3 – Output Type Designations for Base Output Connector.

Code	Output Type
1	3A Mechanical single pole, single throw (SPST) mechanical relay
2	1A Solid state relay (SSR)
3	3A Mechanical single pole, double throw (SPDT) mechanical relay
4	DC pulse for connecting to an external SSR
5	Analog current or voltage
6	Isolated Analog current or voltage (only on output expansion board for 1/8 DIN models)
7	Isolated DC pulse (“IDC” only on output expansion board for 1/8 DIN models)

Table 4 – 8 Pin Output/Power Connector Wiring Summary by Configuration.

Config.	Description	Power		Output Pin Number					
		8	7	6	5	4	3	2	1
330	SPDT, SPDT	AC+ or DC+	AC- or DC-	N.O	Com	N.C	N.O	Com	N.C
304	SPDT, DC pulse			N.O	Com	N.C		V+	Gnd
305	SPDT, analog			N.O	Com	N.C		V/C+	Gnd
144	SPST, DC pulse, DC pulse			N.O	Com	V+	Gnd	V+	Gnd
145	SPST, DC pulse, analog			N.O	Com	V+	Gnd	V/C+	Gnd
220	SSR, SSR			N.O	Com	N.O	Com		
224	SSR, SSR, DC pulse			N.O	Com	N.O	Com	V+	Gnd
225	SSR, SSR, analog			N.O	Com	N.O	Com	V/C+	Gnd
440	DC pulse, DC pulse			V+	Gnd	V+	Gnd		
444	DC pulse, DC pulse, DC pulse			V+	Gnd	V+	Gnd	V+	Gnd
445	DC pulse, DC pulse, analog	V+	Gnd	V+	Gnd	V/C+	Gnd		

Table 5 – 6 Pin Output Expansion Board Connector Wiring Summary by Configuration.

Config.	Description	Output Expansion Board Pin Number					
		6	5	4	3	2	1
006	Isolated Analog					V/C+	Gnd
776	IDC, IDC, Isolated Analog	V+	Gnd	V+	Gnd	V/C+	Gnd
116	SPST, SPST, Isolated Analog	N.O	Com	N.O	Com	V/C+	Gnd
226	SSR, SSR, Isolated Analog	N.O	Com	N.O	Com	V/C+	Gnd

Table 6 – Definitions for Abbreviations in Table 4.

Code	Definition	Code	Definition
N.O.	Normally open relay/SSR load	AC-	AC power neutral in pin
Com	Relay Common/SSR AC power	AC+	AC power hot in pin
N.C.	Normally closed relay load	DC-	Negative DC power in pin
Gnd	DC Ground	DC+	Positive DC power in pin
V+	Load for DC pulse		
V/C+	Load for analog		

4. PLATINUM™ Series Navigation

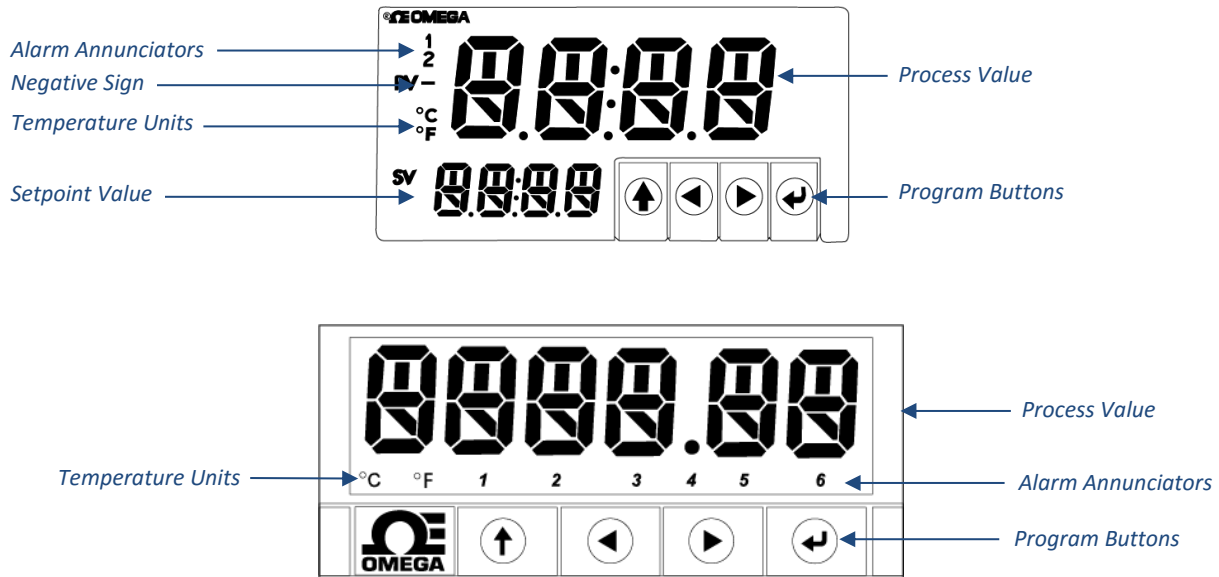

Figure 8 – PLATINUM Series Displays (CN8DPt and CN8EPt Shown)

4.1 Description of Button Actions



The UP button moves up a level in the menu structure. Pressing and holding the UP button navigates to the top level of any menu (oPER, PRoG, or INIt). This can useful if you get lost in the menu structure.



The LEFT button moves across a set of menu choices at a given level (up in the Section 4 menu structure tables). When changing numerical settings, press the LEFT button to make the next digit (one digit to the left) active.



The RIGHT button across a set of menu choices at a given level (down in the Section 4 menu structure tables). The RIGHT button also scrolls numerical values up with overflow to 0 for the flashing digit selected.



The ENTER button selects a menu item and goes down a level, or it enters a numerical value or parameter choice.

4.2 Menu Structure

The menu structure of the PLATINUM™ Series is divided into 3 main Level 1 groups, which are Initialization, Programming, and Operating. They are described in Section 4.3. The complete menu structure for levels 2 to 8 for each of the three Level 1 groups is detailed in Section 5.1, 5.2, and 5.3. Levels 2 through 8 represent sequentially deeper levels of navigation. Values with a dark box around them are default values or submenu entry points. Blank lines indicate user-provided information. Some menu items include links to reference information elsewhere in this user manual. The information in the Notes column defines each menu choice.

4.3 Level 1 Menu

- INI** Initialization Mode: These settings are rarely changed after initial setup. They include transducer types, calibration, etc. These settings can be password-protected.
- PRoG** Programming Mode: These settings are frequently changed. They include Set points, Control Modes, Alarms, etc. These settings can be password-protected.
- oPER** Operating Mode: This mode allows users to switch between Run Mode, Standby Mode, Manual Mode, etc.

4.4 Circular Flow of Menus

The following diagram shows how to use the LEFT and RIGHT buttons to navigate around a menu.

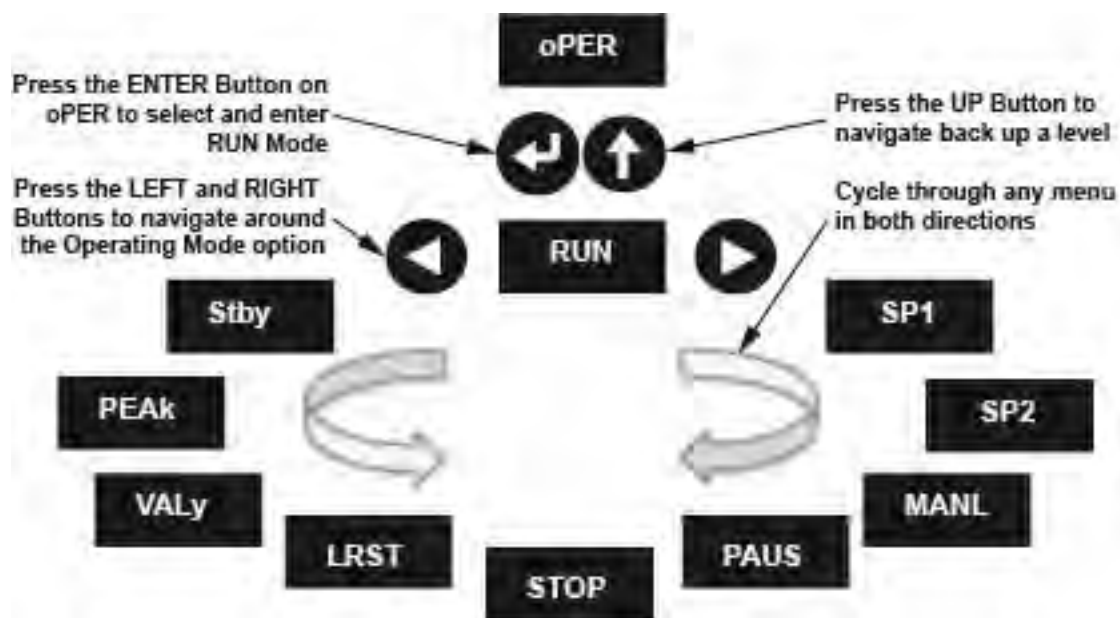

Figure 9 – Circular Flow of Menus.

5. Complete Menu Structure

5.1 Initialization Mode Menu (INIT)

The following table maps the Initialization Mode (INIT) navigation:

Level 2	Level 3	Level 4	Level 5	Level 6	Level 7	Level 8	Notes
INPt	t.C.	k					Type K thermocouple
		J					Type J thermocouple
		t					Type T thermocouple
		E					Type E thermocouple
		N					Type N thermocouple
		R					Type R thermocouple
		S					Type S thermocouple
		b					Type B thermocouple
		C					Type C thermocouple
	Rtd	N.wIR	3 wl				3-wire RTD
			4 wl				4-wire RTD
			2 wl				2-wire RTD
		A.CRV	385.1				385 calibration curve, 100 Ω
			385.5				385 calibration curve, 500 Ω
			385.t				385 calibration curve, 1000 Ω
			392				392 calibration curve, 100 Ω
			391.6				391.6 calibration curve, 100 Ω
	tHRM	2.25k					2250 Ω thermistor
		5k					5000 Ω thermistor
		10k					10,000 Ω thermistor
	PRoC	4-20					Process input range: 4 to 20 mA
<i>Note:</i> This Manual and Live Scaling submenu is the same for all PRoC ranges.							
			MANL	Rd.1	___		Low display reading
				IN.1	___		Manual input for Rd.1
				Rd.2	___		High display reading
				IN.2	___		Manual input for Rd.2
			LIVE	Rd.1	___		Low display reading
				IN.1	___		Live Rd.1 input, ENTER for current
				Rd.2	___		High display reading
				IN.2	___		Live Rd.2 input, ENTER for current
		0-24					Process input range: 0 to 24 mA
		+10					Process input range: -10 to +10 V
<i>Note:</i> +- 1.0 and +-0.1 support SNGL, dIFF and RtIO tYPE							
		+1	tYPE	SNGL			Process input range: -1 to +1 V

Level 2	Level 3	Level 4	Level 5	Level 6	Level 7	Level 8	Notes
				dIFF			Differential between AIN+ and AIN-
				RtLO			Ratiometric between AIN+ and AIN-
		+0.1					Process input range: -0.1 to +0.1 V
			<i>Note:</i> The +- 0.05 input supports dIFF and RtIO tYPE				
		+-.05	tYPE	dIFF			Differential between AIN+ and AIN-
				RtLO			Ratiometric between AIN+ and AIN-
							Process input range: -0.05 to +0.05 V
tARE	dSbL						Disable tARE feature
	ENbL						Enable tARE on oPER menu
	RMt						Enable tARE on oPER and Digital Input
LINR	N.Pnt	_____					Specifies the number of points to use
			<i>Note:</i> The Manual / Live inputs repeat from 1..10, represented by <i>n</i>				
	MANL	Rd. <i>n</i>	_____				Low display reading
		IN. <i>n</i>	_____				Manual input for Rd. <i>n</i>
	LIVE	Rd. <i>n</i>	_____				Low display reading
		IN. <i>n</i>	_____				Live Rd. <i>n</i> input, ENTER for current
RdG	dEC.P	FFF.F					Reading format -999.9 to +999.9
		FFFF					Reading format -9999 to +9999
		FF.FF					Reading format -99.99 to +99.99
		F.FFF					Reading format -9.999 to +9.999
	°F°C	°C					Degrees Celsius annunciator
		°F					Degrees Fahrenheit annunciator
		NoNE					Turns off for non-temperature units
	d.RNd	_____					Display Rounding
	FLtR	8					Readings per displayed value: 8
		16					16
		32					32
		64					64
		128					128
		1					2
		2					3
		4					4
			<i>Note:</i> Four digit displays offer 2 annunciators, Six digit displays offer 6				
	ANN. <i>n</i>	ALM.1					Alarm 1 status mapped to "1"
		ALM.2					Alarm 2 status mapped to "1"
		oUt#					Output state selections by name
	NCLR	GRN					Default display color: Green
		REd					Red

Level 2	Level 3	Level 4	Level 5	Level 6	Level 7	Level 8	Notes
		AMbR					Amber
	bRGt	HIGH					High display brightness
		MEd					Medium display brightness
		Low					Low display brightness
ECtN	5 V						Excitation voltage: 5 V
	10 V						10 V
	12 V						12 V
	24 V						24 V
	0 V						Excitation off
CoMM	USB						Configure the USB port
<i>Note:</i> This PRot submenu is the same for USB, Ethernet, and Serial ports.							
		PRot	oMEG	ModE	CMd		Waits for commands from other end
					CoNt	_____	Transmit continuously every ###.# sec
				dAt.F	StAt	No	
						yES	Includes Alarm status bytes
					RdNG	yES	Includes process reading
						No	
					PEAk	No	
						yES	Includes highest process reading
					VALy	No	
						yES	Includes lowest process reading
					UNIt	No	
						yES	Send unit with value (F, C, V, mV, mA)
				LF	No		
						yES	Appends line feed after each send
				ECHo	yES		Retransmits received commands
						No	
				SEPR	_CR_		Carriage Return separator in CoNt
					SPCE		Space separator in CoNt Mode
			M.bUS	RtU			Standard Modbus protocol
				ASCI			Omega ASCII protocol
		AddR	_____				USB requires Address
	EtHN	PRot					Ethernet port configuration
		AddR	_____				Ethernet "Telnet" requires Address
	SER	PRot					Serial port configuration
		C.PAR	bUS.F	232C			Single device Serial Comm Mode
				485			Multiple devices Serial Comm Mode
			bAUd	19.2			Baud rate: 19,200 Bd

Level 2	Level 3	Level 4	Level 5	Level 6	Level 7	Level 8	Notes
				9600			9,600 Bd
				4800			4,800 Bd
				2400			2,400 Bd
				1200			1,200 Bd
				57.6			57,600 Bd
				115.2			115,200 Bd
			PRty	odd			Odd parity check used
				EVEN			Even parity check used
				NoNE			No parity bit is used
				oFF			Parity bit is fixed as a zero
			dAtA	8bit			8 bit data format
				7bit			7 bit data format
			StoP	1bit			1 stop bit
				2bit			2 stop bits gives a "force 1" parity bit
		Addr	_____				Address for 485, placeholder for 232
SFty	PwoN	RSM					RUN on power up if not previously faulted
		wAlt					Power on: oPER Mode, ENTER to run
		RUN					RUN's automatically on power up
	RUN.M	dSbL					ENTER in Stby , PAUS , StoP runs
		ENbL					ENTER in modes above displays RUN
	SP.LM	SP.Lo	_____				Low Setpoint limit
		SP.HI	_____				High Setpoint limit
	SEN.M						Sensor Monitor
		LPbk	dSbL				Loop break timeout disabled
			ENbL				Loop break timeout value (MM.SS)
		o.CRk	ENbl				Open Input circuit detection enabled
			dSbL				Open Input circuit detection disabled
		E.LAt	ENbl				Latch sensor error enabled
			dSbL				Latch sensor error disabled
	OUT.M						Output Monitor
		oUt1					oUt1 is replaced by output type
			o.brk				Output break detection
				dSbL			Output break detection disabled
				ENbl	P.dEV	_____	Output break process deviation
					P.tME	_____	Output break time deviation
		oUt2					oUt2 is replaced by output type
		oUt3					oUt3 is replaced by output type
		E.LAt	ENbl				Latch output error enabled

Level 2	Level 3	Level 4	Level 5	Level 6	Level 7	Level 8	Notes
			dSbL				Latch output error disabled
t.CAL	NoNE						Manual temperature calibration
	1.PNt						Set offset, default = 0
	2.PNt	R.Lo					Set range low point, default = 0
		R.HI					Set range high point, default = 999.9
	ICE.P	ok?					Reset 32°F/0°C reference value
		dSbL					Clears the ICE.P offset value
SAVE	_____						Download current settings to USB
LoAd	_____						Upload settings from USB stick
VER.N	1.00.0						Displays firmware revision number
VER.U	ok?						ENTER downloads firmware update
F.dFt	ok?						ENTER resets to factory defaults
I.Pwd	No						No required password for INIt Mode
	yES	_____					Set password for INIt Mode
P.Pwd	No						No password for PRoG Mode
	yES	_____					Set password for PRoG Mode

5.2 Programming Mode Menu (PRoG)

The following table maps the Programming Mode (**PRoG**) navigation:

Level 2	Level 3	Level 4	Level 5	Level 6	Notes
SP1	_____				Process goal for PID, default goal for oN.oF
SP2	ASbo				Setpoint 2 value can track SP1 , SP2 is an absolute value
	dEVI				SP2 is a deviation value
ALM.1	<i>Note:</i> This submenu is the same for all other Alarm configurations.				
	tyPE	oFF			ALM.1 is not used for display or outputs
		AboV			Alarm: process value above Alarm trigger
		bELo			Alarm: process value below Alarm trigger
		HI.Lo.			Alarm: process value outside Alarm triggers
		bANd			Alarm: process value between Alarm triggers
	Ab.dV	AbSo			Absolute Mode; use ALR.H and ALR.L as triggers
		d.SP1			Deviation Mode; triggers are deviations from SP1
		d.SP2			Deviation Mode; triggers are deviations from SP2
		CN.SP			Tracks the Ramp & Soak instantaneous setpoint
	ALR.H	_____			Alarm high parameter for trigger calculations
	ALR.L	_____			Alarm low parameter for trigger calculations
	A.CLR	REd			Red display when Alarm is active

Level 2	Level 3	Level 4	Level 5	Level 6	Notes
		AMbR			Amber display when Alarm is active
		GRN			Green display when Alarm is active
		dEFt			Color does not change for Alarm
	HI.HI	oFF			High High / Low Low Alarm Mode turned off
		oN	_____		Offset value for active High High / Low Low Mode
	LtCH	No			Alarm does not latch
		yES			Alarm latches until cleared via front panel
		bothH			Alarm latches, cleared via front panel or digital input
		RMt			Alarm latches until cleared via digital input
	CtCL	N.o.			Output activated with Alarm
		N.C.			Output deactivated with Alarm
	A.P.oN	yES			Alarm active at power on
		No			Alarm inactive at power on
	dE.oN	_____			Delay turning off Alarm (sec), default = 1.0
	dE.oF	_____			Delay turning off Alarm (sec), default = 0.0
ALM.2					Alarm 2
oUt1					oUt1 is replaced by output type
	<i>Note:</i> This submenu is the same for all other outputs.				
	ModE	oFF			Output does nothing
		PId			PID Control Mode
			ACtN	RVRS	Reverse acting control (heating)
				dRCt	Direct acting control (cooling)
				RV.DR	Reverse/Direct acting control (heating/cooling)
		PId.2			PID 2 Control Mode
			ACtN	RVRS	Reverse acting control (heating)
				dRCt	Direct acting control (cooling)
				RV.DR	Reverse/Direct acting control (heating/cooling)
		oN.oF	ACtN	RVRS	Off when > SP1, on when < SP1
				dRCt	Off when < SP1, on when > SP1
			dEAd	_____	Deadband value, default = 5
			S.PNt	SP1	Either Setpoint can be used of on/off, default is SP1
				SP2	Specifying SP2 allows two outputs to be set for heat/cool
	ALM.1				Output is an Alarm using ALM.1 configuration
	ALM.2				Output is an Alarm using ALM.2 configuration
	RtRN	Rd1	_____		Process value for oUt1
		oUt1	_____		Output value for Rd1
		Rd2	_____		Process value for oUt2
		oUt2	_____		Output value for Rd2

Level 2	Level 3	Level 4	Level 5	Level 6	Notes
		RE.oN			Activate during Ramp events
		SE.oN			Activate during Soak events
		SEN.E			Activate if any sensor error is detected
		OPL.E			Activate if any output is open loop
	CyCL	_____			PWM pulse width in seconds
	RNGE	0-10			Analog Output Range: 0–10 Volts
		0-5			0–5 Volts
		0-20			0–20 mA
		4-20			4–20 mA
		0-24			0–24 mA
oUt2					oUt2 is replaced by output type
oUt3					oUt3 is replaced by output type (1/8 DIN can have up to 6)
PId	ACTN	RVRS			Increase to SP1 (i.e., heating)
		dRCt			Decrease to SP1 (i.e., cooling)
		RV.DR			Increase or Decrease to SP1 (i.e., heating/cooling)
	A.to	_____			Set timeout time for autotune
	tUNE	StRt			Initiates autotune after StRt confirmation
	GAIN	_P_	_____		Manual Proportional Band setting
		I	_____		Manual Integral Factor setting
		d	_____		Manual Derivative Factor setting
	rCg	_____			Relative Cool Gain (heating/cooling mode)
	oFst	_____			Control Offset
	dEAd	_____			Control Dead band/Overlap band (in process unit)
	%Lo	_____			Low clamping limit for Pulse, Analog Outputs
	%HI	_____			High clamping limit for Pulse, Analog Outputs
	AdPt	ENbL			Enable fuzzy logic adaptive tuning
		dSbL			Disable fuzzy logic adaptive tuning
PId.2	Note: This menu is the same for PID menu.				
RM.SP	oFF				Use SP1 , not remote Setpoint
	oN	4–20			Remote analog Input sets SP1 ; range: 4–20 mA
		Note: This submenu is the same for all RM.SP ranges.			
		RS.Lo	_____		Min Setpoint for scaled range
		IN.Lo	_____		Input value for RS.Lo
		RS.HI	_____		Max Setpoint for scaled range
		IN.HI	_____		Input value for RS.HI
		0–24			0–24 mA
		0–10			0–10 V
		0–1			0–1 V

Level 2	Level 3	Level 4	Level 5	Level 6	Notes
M.RMP	R.CtL	No			Multi-Ramp/Soak Mode off
		yES			Multi-Ramp/Soak Mode on
		RMT			M.RMP on, start with digital input
	S.PRg	___			Select program (number for M.RMP program), options 1–99
	M.tRk	RAMP			Guaranteed Ramp: soak SP must be reached in ramp time
		SoAk			Guaranteed Soak: soak time always preserved
		CYCL			Guaranteed Cycle: ramp can extend but cycle time can't
			Note: tIM.F does not appear for 6 digit display that use a HH:MM:SS format		
	tIM.F	MM:SS			"Minutes : Seconds" default time format for R/S programs
		HH:MM			"Hours : Minutes" default time format for R/S programs
	E.Act	StOP			Stop running at the end of the program
		HOLd			Continue to hold at the last soak setpoint at program end
		LiNk	___		Start the specified ramp & soak program at program end
	N.SEG	___			1 to 8 Ramp/Soak segments (8 each, 16 total)
	S.SEG	___			Select segment number to edit, entry replaces # below
			MRT.#	___	Time for Ramp number, default = 10
			MRE.#	oFF	Ramp events on for this segment
				oN	Ramp events off for this segment
			MSP.#	___	Setpoint value for Soak number
			MSt.#	___	Time for Soak number, default = 10
			MSE.#	oFF	Soak events off for this segment
				oN	Soak events on for this segment

5.3 Operating Mode Menu (oPER)

The following table maps the Operating Mode (oPER) navigation:

Level 2	Level 3	Level 4	Notes
RUN			Normal Run Mode, process value displayed, SP1 in optional secondary display
SP1	___		Shortcut to change Setpoint 1, current Setpoint 1 value in main display
SP2	___		Shortcut to change Setpoint 2, current Setpoint 2 value in main display
MANL	M.CNt	___	Manual Mode, the RIGHT and LEFT buttons control output, displays M###
	M.INP	___	Manual Mode, the RIGHT and LEFT buttons simulate the input for testing
PAUS			Pause and hold at current process value, display flashes
StoP			Stop controlling, turn off outputs, process value rotating flash, Alarms remain
L.RSt			Clears any latched Alarms; Alarms menu also allows digital input reset
VALy			Displays the lowest input reading since the VALy was last cleared
PEAk			Displays the highest input reading since the PEAk was last cleared



Level 2	Level 3	Level 4	Notes
Stby			Standby Mode, outputs, and Alarm conditions disabled, displays Stby
tARE			TARE option - only available if enabled in INPt

6. Reference Section: Initialization Mode (INIt)



Use Initialization Mode to set the following parameters and perform the following functions:

6.	Reference Section: Initialization Mode (INIt)	27
6.1	Input Configuration (INIt > INPt).....	27
6.2	TARE (INIt > tARE)	34
6.3	LINR (INIt > LINR).....	34
6.4	Display Reading Formats (INIt > RdG).....	36
6.5	Excitation Voltage (INIt > ECtN)	39
6.6	Communication (INIt > CoMM).....	39
6.7	Safety Features (INIt > SFty).....	42
6.8	Manual Temperature Calibration (INIt > t.CAL).....	44
6.9	Save Current Configuration for All Parameters to a File (INIt > SAVE)	46
6.10	Load a Configuration for All Parameters from a File (INIt > LoAd)	46
6.11	Display Firmware Revision Number (INIt > VER.N).....	46
6.12	Update Firmware Revision (INIt > VER.U).....	47
6.13	Reset to Factory Default Parameters (INIt > F.dFt).....	47
6.14	Password-Protect Initialization Mode Access (INIt > I.Pwd).....	47
6.15	Password-Protect Programming Mode Access (INIt > P.Pwd).....	47

6.1 Input Configuration (INIt > INPt)

	Select the Input parameter (INPt) to configure the input.
	Navigate to the correct setting. Settings include the following: <ul style="list-style-type: none"> • t.C. – Thermocouple Temperature Sensor (entry point) • Rtd – Resistance Temperature Detector (RTD) • tHRM – Thermistor Temperature Sensor • PRoC – Process Voltage or Current Input
	Select the indicated setting.

6.1.1 Thermocouple Input Type (INIt > INPt > t.C.)

	Select Thermocouple (t.C.) as the input type (factory default). Then specify a specific type of thermocouple or the last selected type will be used.
	Navigate to the installed thermocouple type. Supported types are as follows: <ul style="list-style-type: none"> • k – Type K (factory default) • J – Type J • t – Type T • E – Type E • N – Type N • R – Type R • S – Type S • b – Type B • C – Type C
	Select the indicated type.

6.1.2 Resistance Temperature Detector (RTD) Input Type (INIt > INPt > Rtd)

<input checked="" type="checkbox"/>	Select Rtd as the input type. Factory default configuration settings are three-wire, 100 Ω, using the European standard 385 curve. Note that the 392 and 3916 curves are only available for 100 Ω RTDs. If Rtd is selected and a specific configuration is not changed, the last saved configuration will be used.
<input checked="" type="checkbox"/>	Navigate to the desired configuration parameter: <ul style="list-style-type: none"> • N.wIR – Firmware selection of the number of wires for RTD connection (no jumpers needed) • A.CRV – Calibration curve covering both the international standard and the resistance of the RTD
<input checked="" type="checkbox"/>	Select the option.

6.1.2.1 Number of RTD Wires (INIt > INPt > Rtd > N.wIR)

<input checked="" type="checkbox"/>	Navigate to the desired setting. Settings include the following: <ul style="list-style-type: none"> • 3 wl – Three-wire RTD (factory default) • 4 wl – Four-wire RTD • 2 wl – Two-wire RTD
<input checked="" type="checkbox"/>	Select the indicated option.

6.1.2.2 Calibration Curve (INIt > INPt > Rtd > A.CRV)

<input checked="" type="checkbox"/>	Navigate to the desired setting. Settings include the following: <ul style="list-style-type: none"> • 385.1 – European and most common standard at the conventional resistance of 100 Ω (factory default) • 385.5 – European curve for 500 Ω • 385.t – European curve for 1000 Ω • 392 – Old US standard (rarely used), at 100 Ω only • 3916 – Japanese standard, at 100 Ω only
<input checked="" type="checkbox"/>	Select the indicated option.

6.1.3 Thermistor Input Type Configuration (INIt > INPt > tHRM)

<input checked="" type="checkbox"/>	Select Thermistor (tHRM) as the input type. This sets up the unit for thermistor-based temperature measurement and then the specific thermistor type can be specified. If no thermistor type is specified, the last selected type is used.
<input checked="" type="checkbox"/>	Navigate to the correct setting. Settings include the following: <ul style="list-style-type: none"> • 2.25k – 2,250 Ω thermistor (factory default) • 5k – 5,000 Ω thermistor • 10k – 10,000 Ω thermistor
<input checked="" type="checkbox"/>	Select the indicated option.

6.1.4 Process Input Type Configuration (INIt > INPt > PRoC)

☑	<p>Select Process (PRoC) as the input type. Then select the process input range and scale it. If stopped after selecting the PRoC input type, the last selected input range and scaling is used.</p>
◀▶	<p>Navigate to the voltage or current range of the process input. Any signal input outside of the specified hardware input range will result in an “out-of-range” error (code E009). Input range choices include the following:</p> <ul style="list-style-type: none"> • 4-20 – 4 mA to 20 mA (factory default) • 0-24 – 0 mA to 24 mA • +-10 – -10 V to +10 V • +-1 – -1 V to +1 V • +-.0.1 – -100 mV to +100 mV • +-.05 – -50 mV to +50 mV
☑	<p>Select the desired range.</p>
◀▶	<p><i>The (tYPE) option is only displayed for +- 1.0, +-0.1 and +- .05 inputs and allows selecting between Single Ended, Differential and Ratiometric inputs. The +- .05 input only supports DIFF and RtIo input types.</i></p> <ul style="list-style-type: none"> • SNGL – Bipolar Single Ended voltage between A+ and ARTN connections • DIFF – Differential voltage between A+ and A- connections • RTIo – Ratiometric reading between A+ and A- connections.
☑	<p>Select the desired type.</p>
◀▶	<p>Choose either manual or live scaling. The scaling functions translate process values to engineering units and are available for all process input ranges. The defaults for each input range are the hardware minimum and maximum. Scaling methods include the following:</p> <ul style="list-style-type: none"> • MANL – User manually enters all four scaling parameters • LIVE – User manually enters the low and high display values (RD.1 and RD.2) but reads the input signal directly to set the low and high input values (IN.1 and IN.2) <p>Using either MANL or LIVE to set up scaling, scaled values are then calculated as: Scaled Value = Input * Gain + Offset, where: $Gain = (RD.2 - RD.1) / (IN.2 - IN.1)$ $Offset = RD.1 - (Gain * IN.1)$</p> <p>Therefore scaling can be done over a subset of the applicable range as this scaling calculation linearly extrapolates in both directions.</p>
☑	<p>Select the scaling method to be used.</p>

<p>◀▶</p>	<p>Navigate to the desired scaling parameter. Options include the following:</p> <ul style="list-style-type: none"> • Rd.1 – Reading low value corresponding to IN.1 signal • IN.1 – Input signal corresponding to RD.1 • Rd.2 – Reading high value corresponding to IN.2 signal • IN.2 – Input signal corresponding to RD.2 <p>In Manual Mode, IN.1 and IN.2 are entered manually for scaling,; in Live Mode, IN.1 and IN.2 activate a read of the input signal for scaling.</p>
<p>☑</p>	<p>Select the scaling parameter to change.</p>
<p>◀▶</p>	<p>For manual inputs, set the selected scaling parameter to the desired value.</p>
<p>☑</p>	<p>Confirm the value for the selected scaling parameter in Manual Mode (MANL), or read and accept the input signal for either IN.1 or IN.2 in Live Mode (LIVE).</p>

6.1.4.1 Single Ended Inputs

Single Ended inputs measure the voltage on the Analog Input terminal (AI+) with respect to the analog ground (ARTN) terminal.

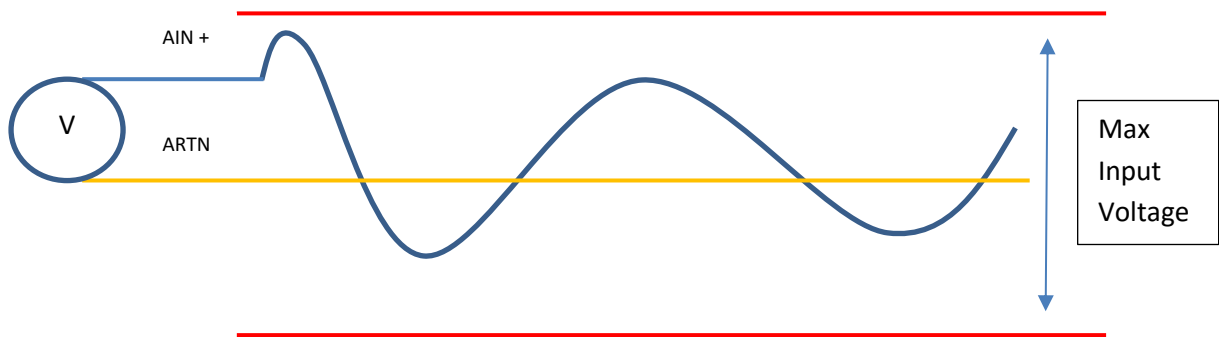

6.1.4.1 Differential Inputs

Differential inputs measure the voltage difference between the AIN+ and AIN- terminals. An internal 2.048 reference voltage (Vref) is used and determines the maximum voltage difference. The analog voltages must be within +/- 2.0 volts of the analog ground (ARTN) voltage level, referred to as the Common Mode Voltage.

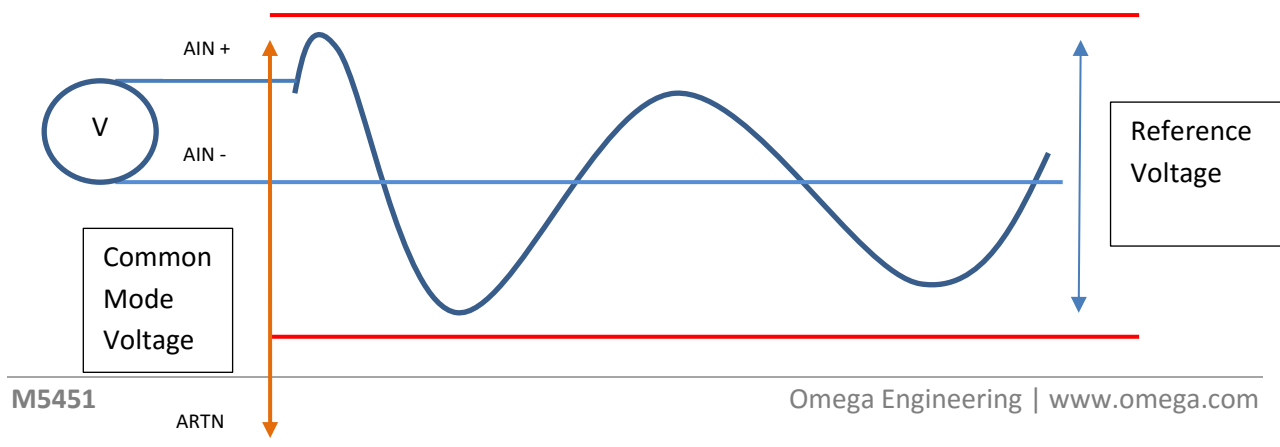

6.1.4.1 Ratiometric Inputs

Ratiometric inputs allow applying an external reference voltage (V_{ref}) used by the Analog / Digital converter and the measured signal level directly proportional to the reference voltage. The external reference voltage must be in the range of 1.5 – 2.5 Vdc and applied between APWR and ARTN. An internal 2.0 k ohm resistor is applied between the APWR and ARTN terminals.

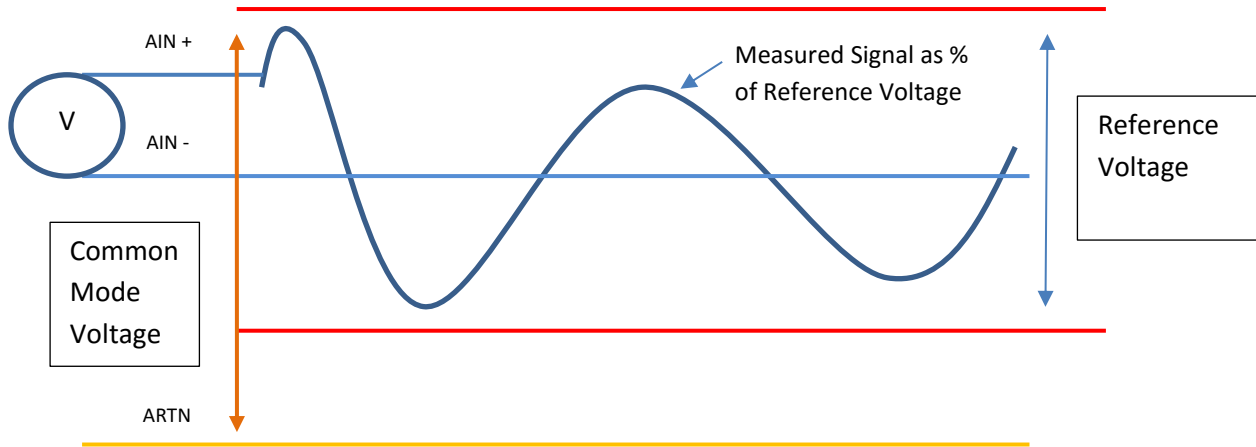

6.1.4.2 Bridge Inputs

Ratiometric inputs are widely used for bridge inputs as found in load cell and pressure sensors because any fluctuations in the excitation voltage are eliminated in the final reading.

The input is configured as a ratiometric input, where the voltage difference between terminals 2 (AIN+) and 3 (AIN-) is measured with respect to the externally applied voltage reference applied between terminal 1 (ARTN) and terminal 4 (APWR).

The Excitation voltage, set to 5 or 10 Vdc is used to power the external bridge sensor. Two external resistors provide a divider circuit to ensure that the differential inputs are biased at $\frac{1}{2}$ of the voltage generated by the on-board Excitation Voltage.

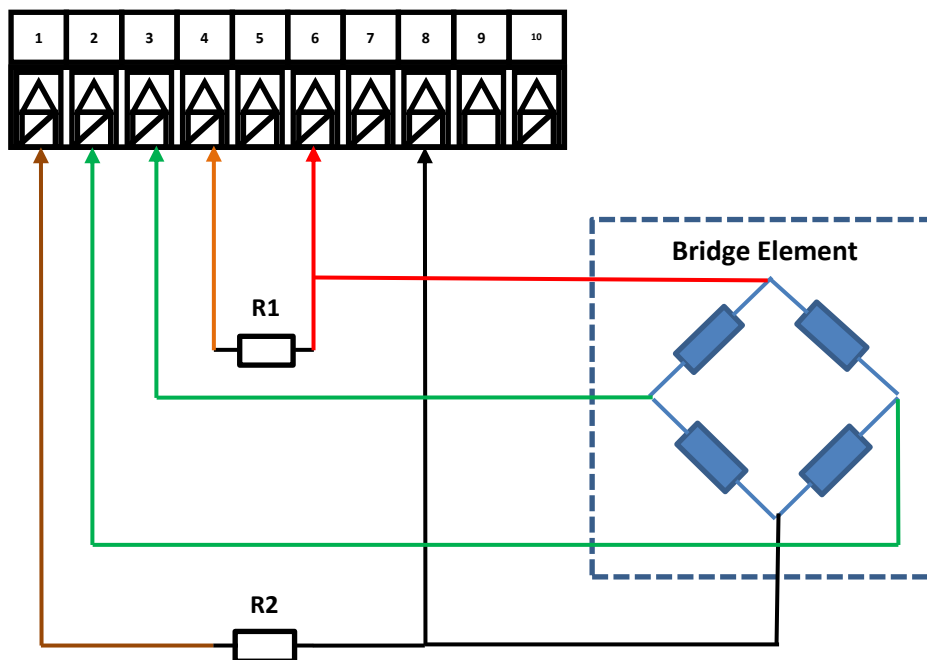

Resistors (R1, R2): ~ 4.7 k ohms.

NOTE: An **internal** 2.0 k ohms resistor is connected between terminal 1 (ARTN) and terminal 4 (APWR).

6.1.4.3 Bridge (Ratiometric) Input Scaling

To calibrate to a specific bridge device, the user must provide two known loads and enter the corresponding values. This allows the device to calculate a straight line correction:

$$\text{Weight} = \text{Input Reading} \times \text{Gain} + \text{Offset}$$

Scaling operations allow translating source (input) signals to scaled output signal using a linear translation defined by a SLOPE (or gain) and an OFFSET. As shown below, (X1, Y1) and (X2, Y2) define two points on a line that has a certain SLOPE and OFFSET. Knowing the SLOPE and OFFSET allows determining the OUTPUT value for any given INPUT value using the equation:

$$\text{Output} = \text{Input} \times \text{SLOPE} + \text{OFFSET}, \text{ where}$$

$$\text{GAIN} = (Y2 - Y1) / (X2 - X1)$$

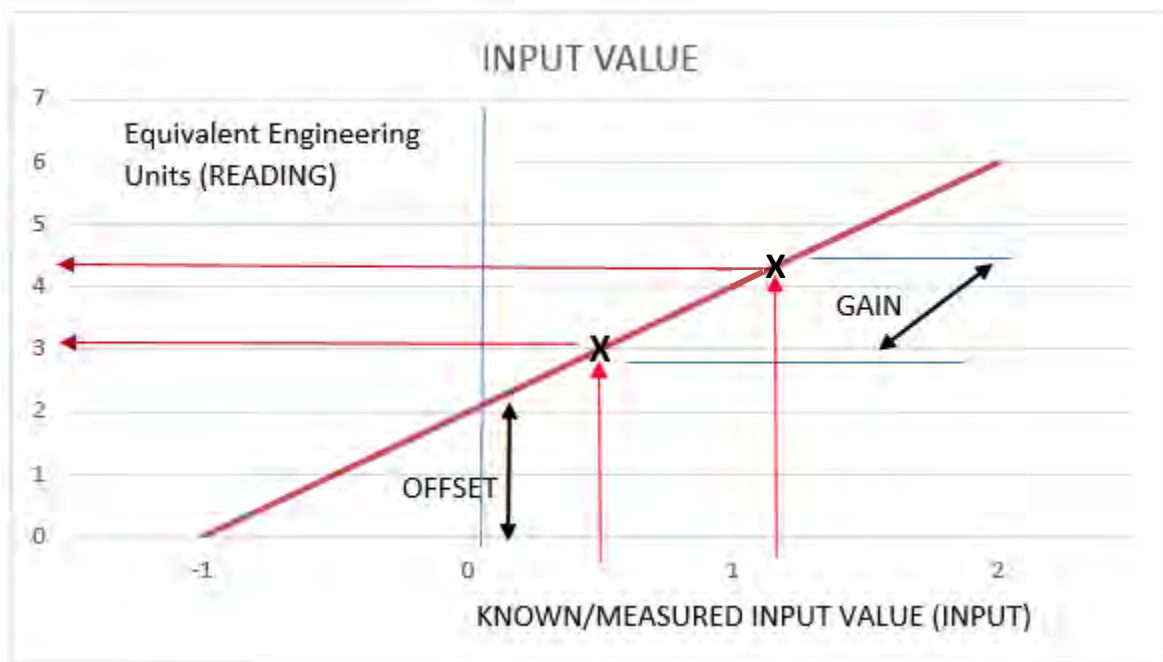

$$\text{OFFSET} = Y1 - (\text{GAIN} * X1).$$

The Input reading is expressed in terms of full scale, which is directly dependent on the applied reference voltage which is in turn derived from the excitation voltage. Due to the ratiometric design the absolute value of the Excitation voltage and exact resistor values do not enter into the weight calculation.









If $(X2 - X1) = 0$, the GAIN is set to 1 and the OFFSET is set to 0.

6.2 TARE (INIt > tARE)

	Select TARE (tARE) to configure the tare option.
	<p>Navigate to the desired setting. Settings include the following:</p> <ul style="list-style-type: none"> • dSbL – No TARE option is enabled • ENbL – TARE option may be activated from RUN menu • RMt – TARE option may be activated from RUN menu or by digital input <p>The Tare option is only available for process inputs. If enabled (ENbL or RMt) the OPERATING menu is expanded to include a TARE option that allows zeroing the reading value when the unit is in the RUN mode.</p> <p>If the remote option is selected the reading may be zeroed using either the panel button or the digital input while in the RUN mode.</p> <p>When activated, the TARE process applies an offset adjustment to the current reading such that the adjusted reading will be zero.</p>
	Select the indicated setting.

6.3 LINR (INIt > LINR)

	Select 10 Point Linearization option. The 10 point linearization allows entering up to 10 Reading/Input value pairs used to internally calculate 10 gain/offset parameters. The LINR option is only available on Process inputs.
	<p>Select the Number of Points (N.PNT)</p> <p>The N.Pts option determines how many of the Reading/Input pairs are processed. To disable the Linearization function set the Number of points to 0.</p>
	Select the indicated setting.
	<p>Choose either manual or live inputs. The defaults for each input pair 100.0 Reading and 100.0 Input Scaling methods include the following:</p> <ul style="list-style-type: none"> • MANL – User manually enters both parameters • LIVE – User manually enters the display values (RD.n) but the signal level is read from the input set the input values (IN.n) <p>Using either MANL or LIVE linearization Gain/Offset pairs are calculated as:</p> $\text{Gain} = (\text{RD.n} - \text{RD.n-1}) / (\text{IN.n} - \text{IN.n-1})$ $\text{Offset} = \text{RD.n-1} - (\text{Gain} * \text{IN.n-1})$ <p>During processing the input level is compared to the set of input levels stored to determine which gain/offset pair to apply.</p>
	Select the linearization method to be used.
	<p>Navigate to the desired scaling parameter. Options include the following:</p> <ul style="list-style-type: none"> • Rd.n – Reading low value corresponding to IN.1 signal • IN.n – Input signal corresponding to RD.1 <p>In Manual Mode, IN.n is entered manually. In Live Mode, the IN.n option displays the current input signal.</p>
	Select the scaling parameter to change.

In many applications a single Gain and Offset as provided by the Scaling adjustment on process inputs can be used that supports a direct linearization between the input signal and the required reading. For more complex applications, the relationship between the input value and the desired reading is not linear across the entire range of inputs. A common example is found when converting a measured weight of an irregular shaped hopper to the equivalent level.

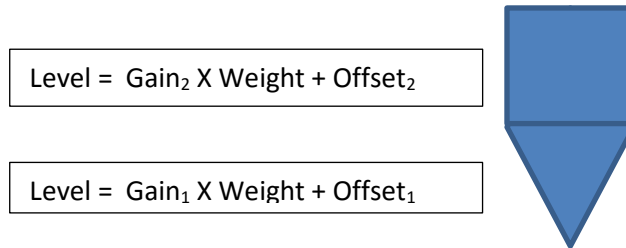

A 10-point linearization table is provided, allowing for piecewise linearization of complex profiles. This feature is often used to transform weight values into volume or to transform primary measurements into derived measurements such as rate of change in temperature to air flow.

The internal process sequentially checks each Point (IN.x) value against the raw input and uses the associated Gain (GN.x) value to calculate the transfer function.

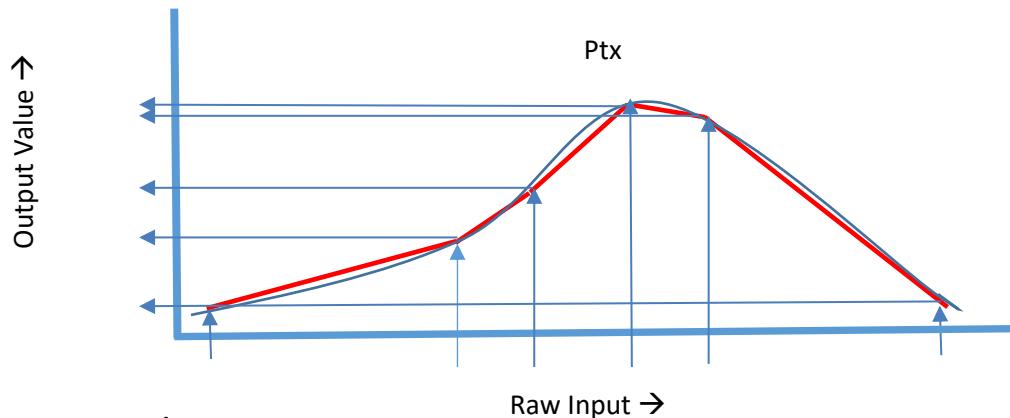



Combined Scaling/Linearization



The Scaling and 10-point Linearization may be combined. The output of the Scaling adjustment is applied as the input to the 10-point linearization.

The use of Live Scaling and Live Linearization is mutually exclusive. If Live scaling is selected the Live Linearization option is disabled and if Live Linearization is selected the Live Scaling option is disabled.



6.4 Display Reading Formats (INIt > RdG)

	Select Reading Formats (RdG) to configure the front panel display.
	Navigate to the desired setting. Settings include the following: <ul style="list-style-type: none"> • dEC.P – Decimal-point format (entry point) • °F°C – Temperature units • d.RNd – Display Rounding • FLtR – Filter (readings displayed per second) • ANN.n – Annunciator 1..n setting, number determined by 6 digit display type • NCLR – Normal color (default display color) • bRGt – Display brightness
	Select the indicated setting.

6.4.1 Decimal Point Format (INIt > RdG > dEC.P)

	Select Decimal Point (dEC.P) and then select the desired decimal-point format. Only the FFF.F and FFFF formats work for temperature inputs but all four can be used with process inputs. While this parameter sets the default format, the numeric display will auto range (automatically shift the decimal point) if necessary.
	Navigate to the desired setting. Settings include the following: <ul style="list-style-type: none"> • FFF.F – One decimal place (factory default) • FFFF – Zero decimal places • FF.FF – Two decimal places (not a choice with temperature inputs) • F.FFF – Three decimal places (not a choice with temperature inputs)
	Select the indicated format.

6.4.2 Temperature Units (INIt > RdG > °F°C)

	Select the Temperature Units (°F°C) parameter, and the current temperature unit selection is then displayed.
	Navigate to the desired setting. Settings include the following: <ul style="list-style-type: none"> • °C – Degrees Celsius (factory default), °C annunciator turned on • °F – Degrees Fahrenheit, °F annunciator turned on • NoNE – Default for INPt = PRoC, both temp unit annunciators turned off; if the process level input signal corresponds to a temperature (temperature transmitters for example), the appropriate temperature type annunciator can be chosen.
	Select the indicated option.



6.4.3 Display Rounding (INIt > RdG > d.RNd)

<input checked="" type="checkbox"/>	Select the Display Rounding (d.Rnd) option.
<input checked="" type="checkbox"/>	<p>The Display Rounding parameter determines the minimum change in value required to cause the display to update.</p> <p>For example, if the d.RNd value is set to 5.0, the displayed values will be 0, 5, 10....</p> <p>The D.RND value only affects the value being displayed. It does not affect the absolute value being read or the value(s) used for control functions.</p>
<input checked="" type="checkbox"/>	Select the indicated option.



6.4.4 Filter (INIt > RdG > FLtR)

<input checked="" type="checkbox"/>	Select the Filter (FLtR) parameter. Filtering averages multiple input analog to digital conversions, which can suppress noise in the input signal. This should be set to an appropriate value depending on the response time of the input.
<input checked="" type="checkbox"/>	<p>Navigate to the desired setting corresponding to the number of readings per displayed value. Settings include the following (calculated times between display value updates are shown for each setting as well):</p> <ul style="list-style-type: none"> • 8 – 0.4 s (factory default) • 16 – 0.8 s • 32 – 1.6 s • 64 – 3.2 s • 128 – 6.4 s • 1 – 0.05 s • 2 – 0.1 s • 4 – 0.2 s
<input checked="" type="checkbox"/>	Select the indicated option.



6.4.5 Annunciator Settings (INIt > RdG > ANN.1/ANN.2)

	<p>Select the Annunciator 1 (ANN.1) parameter. This controls which Alarm or output status activates the “1” annunciator on the front display. In general, the default values for both annunciators should be used (status for Alarm configuration 1 for annunciator 1 and status for Alarm configuration 2 for annunciator 2). However, it can be useful during troubleshooting to map the on/off status of one or two outputs to the annunciators.</p> <p>The ANN.1 and ANN.2 parameters work the same way except that they control the “1” and the “2” front display annunciators, respectively, and have different default values.</p>
	<p>Navigate to the desired setting. Settings include the following:</p> <ul style="list-style-type: none"> • ALM.1 – The configuration defined by PRoG > ALM.1 determines the state of the annunciator. The annunciator turns on when the Alarm condition exists (factory default for ANN.1). • ALM.2 – The configuration defined by PRoG > ALM.2 determines the state of the annunciator (factory default for ANN.2). • oUt# – “oUt#” is replaced by a list of the names of all outputs that are not analog outputs. For example, the output choices dtR.1 and dC.1 are listed for a “145” configuration, and ANG.1 is not listed.
	<p>Select the indicated option.</p>



6.4.6 Normal Color (INIt > RdG > NCLR)

	<p>Select the Normal Color (NCLR) parameter. This controls the default display color, which can then be overridden by Alarms.</p>
	<p>Navigate to the desired setting. Settings include the following:</p> <ul style="list-style-type: none"> • GRN – Green (factory default) • REd – Red • AMbR – Amber
	<p>Select the indicated option.</p>





6.4.7 Brightness (INIt > RdG > bRGt)

	<p>Select the Brightness (bRGt) parameter.</p>
	<p>Navigate to the desired setting. Settings include the following:</p> <ul style="list-style-type: none"> • HIGH – High display brightness (factory default) • MEd – Medium display brightness • Low – Low display brightness
	<p>Select the indicated option.</p>



6.5 Excitation Voltage (INIt > ECtN)

	Select the Excitation Voltage (ECtN) parameter.
	Navigate to the correct setting. Settings include the following: <ul style="list-style-type: none"> • 5 V – 5 Volt excitation voltage (factory default) • 10 V – 10 Volt excitation voltage • 12 V – 12 Volt excitation voltage • 24 V – 24 Volt excitation voltage • 0 V – Excitation turned off
	Select the indicated option.



6.6 Communication (INIt > CoMM)

	Select the Communication Type (CoMM) to configure. Only installed communications options show up for configuration (USB is always present). If more than one communications option is installed, any or all of them can be configured for simultaneous operation.
	Navigate to the correct option. Options include the following: <ul style="list-style-type: none"> • USb – Universal Serial Bus (USB) communications • EtHN – Ethernet communications configuration • SER – Serial (either RS232 or RS485) communications configuration
	Select the indicated option.
	Navigate to the desired parameter submenu. Options include the following: <ul style="list-style-type: none"> • PRot – Protocol • AddR – Address <p><i>Note:</i> The serial communications (SER) option above also includes the following parameter:</p> <ul style="list-style-type: none"> • C.PAR – Communications parameters only applicable to serial communications
	Select the indicated option.



6.6.1 Protocol (INIt > CoMM > USb, EtHN, SER > PRot)

	Select the Protocol (PRot) parameter.
	Navigate to the desired setting. Settings include the following: <ul style="list-style-type: none"> • oMEG – (factory default) Omega's Protocol, using standard ASCII encoding. Further detail on this format is covered in the Communications Manual. • M.bUS – Modbus protocol, available as Modbus RTU (RtU, default) or Modbus/ASCII (ASCI). The Ethernet option supports Modbus/TCP/IP. More detail on using this protocol can be found in the Communications Manual.
	Select the desired setting.



6.6.1.1 ASCII Parameters (INIt > CoMM > USb, EtHN, SER > PRot > oMEG)

	Select oMEG to configure Omega ASCII mode communications parameters. These configuration settings are the same for USB, Ethernet, and Serial communications.
	<p>Navigate to the desired parameter. Parameters and sub-parameters include the following:</p> <ul style="list-style-type: none"> • ModE – Choose the Mode for initiating ASCII data transfer: <ul style="list-style-type: none"> ○ CMd – Data is sent after receiving a prompt command from the connected device (factory default). ○ CoNt – Data is sent as it is collected; setting the seconds between data sends (###.#), default = 001.0. In Continuous Mode, sending a CTRL/Q to the unit suspends transmission and sending a CTRL/S restarts transmission. • dAt.F – Data Format; select yES or No for the following settings: <ul style="list-style-type: none"> ○ StAt – Alarm status bytes are sent with the data ○ RdNG – Sends the process reading ○ PEAk – Sends the highest process reading so far ○ VALy – Sends the lowest process reading so far ○ UNIt – Sends the unit with the value (F, C, V, mV, mA) • _LF_ – Select yES or No; yES sends a line feed between each data block to format the output in a more readable fashion. • ECHo – Select yES or No; yES echoes each received command to allow verification. • SEPR – Determines the separation character between each data block: <ul style="list-style-type: none"> ○ _CR_ – A carriage return sent between data blocks (factory default). ○ SPCE – A space character is sent between each data block.
	Select the indicated option, and manage submenus and parameters as required.



6.6.2 Address (INIt > CoMM > USb, EtHN, SER > Addr)

	Select the Address (Addr) parameter.
	Set the Address value. The Modbus protocol requires an address field to correctly identify the selected device. The Omega protocol supports an optional address field which is required for Serial channels configured for RS485.
	Accept the entered value.



6.6.3 Serial Communications Parameters (INIt > CoMM > SER > C.PAR)

	Select C.PAR . Then, select individual parameters to configure the serial communications.
	Navigate to the correct setting. Settings include the following: <ul style="list-style-type: none"> • bUS.F – Specify RS232 or RS485 serial communications • bAUd – Baud rate (transmission rate) • PRty – Parity (used for transmission error checking) • dAtA – Number of bits per data point • StoP – Number of stop bits between data points
	Select the desired setting.



6.6.3.1 Serial Bus Format (INIt > CoMM > SER > C.PAR > bUS.F)

	Select the Bus Format (bUS.F) parameter.
	Navigate to the desired setting. Settings include the following: <ul style="list-style-type: none"> • 232C – Allows one-to-one serial communications (factory default) • 485 – Allows multiple devices to operate on a single pair of wires
	Select the indicated option.



6.6.3.2 Baud Rate (INIt > CoMM > SER > C.PAR > bAUd)

	Select the Baud Rate (bAUd) parameter. The device being communicated to determines how fast to set the Baud Rate.
	Navigate to the desired setting for Baud rate (bits per second): <ul style="list-style-type: none"> • 19.2 – 19,200 Baud (factory default) • 9600 – 9,600 Baud • 4800 – 4,800 Baud • 2400 – 2,400 Baud • 1200 – 1,200 Baud • 57.6 – 57,600 Baud • 115.2 – 115,200 Baud
	Select the indicated option.



6.6.3.3 Parity (INIt > CoMM > SER > C.PAR > PRty)

	Select the Parity (PRty) parameter.
	Navigate to the desired setting. Settings include the following: <ul style="list-style-type: none"> • odd – Odd parity used to verify communications (factory default) • EVEN – Even parity used to verify communications • NoNE – Parity is not used to verify communications
	Select the indicated option.



6.6.3.4 Data Bits (INIt > CoMM > SER > C.PAR > dAtA)

	Select the number of Data Bits (dAtA).
	Navigate to the desired setting. Settings include the following: <ul style="list-style-type: none"> • 8bit – 8 bits used per data character (factory default) • 7bit – 7 bits used per data character
	Select the indicated option.



6.6.3.5 Stop Bits (INIt > CoMM > SER > C.PAR > StoP)

	Select the number of Stop Bits (StoP).
	Navigate to the desired setting. Settings include the following: <ul style="list-style-type: none"> • 1bit – 1 stop bit (factory default) • 2bit – 2 stop bits (provides a “force 1” parity bit)
	Select the indicated option.



6.7 Safety Features (INIt > SFty)

	Select Safety Features (SFty).
	Navigate to the desired parameter. Parameters include the following: <ul style="list-style-type: none"> • PwoN – Requires confirmation before running automatically at startup • oPER – User must select RUN when exiting from the Stby, PAUS, or StoP Modes • SP.LM – Setpoint limits can be set to limit the values that can be entered • LPbk – Loop break enable/disable and timeout value • o.CRk – Open circuit detection enable/disable
	Select the indicated option.

6.7.1 Power On Confirmation (INIt > SFty > PwoN)





	Select Power On Confirmation (PwoN).
	Navigate to the desired setting. Settings include the following: <ul style="list-style-type: none"> • RSM – Program runs automatically at startup if not previously in fault state (factory default) • wAlt – The unit powers on and then displays RUN; press the ENTER button to run the program • RUN – Program runs automatically at startup regardless of previous state
	Select the desired setting.

6.7.2 Operating Mode Confirmation (INIt > SFty > oPER)





	Select the Operating Mode Confirmation (oPER) parameter.
	Navigate to the desired setting. Settings include the following: <ul style="list-style-type: none"> • dSbL – Pressing the ENTER button in Stby, PAUS, or StoP Modes will start running the current program immediately (factory default) • ENbL – Pressing the ENTER button in any Operating Menu Mode will display RUN; pressing the ENTER button again will start running the current program

	Select the desired setting.
---	-----------------------------



6.7.3 Setpoint Limits (INIt > SFty > SP.LM)

	Select Setpoint Limits (SP.LM) to set limits on the values that can be used for the all Setpoints.
	Navigate to the desired setting. Settings include the following: <ul style="list-style-type: none"> • SP.Lo – Set the minimum possible Setpoint value • SP.HI – Set the maximum possible Setpoint value
	Select the desired setting.
	Set the Setpoint limit value.
	Confirm the value.

6.7.4 Loop Break Timeout (INIt > SFty > SEN.M > LPbk)

	Select the loop break (LPbk) parameter. When enabled, this parameter specifies the amount of time in Run Mode without a change in input value that would signify a sensor malfunction. For example, if there were a problem in a thermocouple, the input would not change over time.
	Navigate to the desired setting. Settings include the following: <ul style="list-style-type: none"> • dSbL – No loop break timeout protection (factory default) • ENbL – Set loop break timeout value
	Select the indicated setting.
	If ENbL , Set the loop break timeout value in minutes and seconds (MM.SS)
	Confirm the value.

6.7.5 Open Circuit (INIt > SFty > SEN.M > o.CRk)

	Select the open circuit (o.CRk) parameter. When o.CRk is enabled, the unit will monitor Thermocouples, RTD, and Thermistors for an open circuit condition.
	Navigate to the desired setting. Settings include the following: <ul style="list-style-type: none"> • ENbL – Open circuit conditions will stop the program and display oPEN (factory default) • dSbL – No open circuit protection (may be necessary when using high impedance infrared thermocouples or thermistors).
	Confirm the value.

6.7.6 Sensor Error Latch (INIt > SFty > SEN.M > E.LAT)

	Select the Error latch (E.LAT) parameter. When E.LAT is enabled, if any sensor error is detected (open circuit, out of range, loop break), the unit will be put in fault mode. Manual intervention is required to clear the error. When E.LAT is disabled, if the fault conditions no longer exist, the unit will resume its previous running state.
---	---

	Navigate to the desired setting. Settings include the following: <ul style="list-style-type: none"> • ENbL – Enable sensor error latch. Manual intervention is required to clear the error. • dSbL – Disable sensor error latch. Unit automatically resumes if sensor errors are cleared
	Confirm the value.

6.7.7 Output Break detection (INIT > SFty > OUT.M > o.brk)

	Select the Output Break Detection (o.brk) parameter. Output Break is detected when during output saturation (i.e: PID is at 100%), the process value does not move the specified amount of Process Deviation (P.dEV) in the specified amount of Time Deviation (T.dEV).
	Navigate to the desired setting. Settings include the following: <ul style="list-style-type: none"> • ENbL – Enable Output break detection. • dSbL – Disable Output break detection • P.dEV – Process Deviation condition (in process units) • T.dEV – Time Deviation condition (in minutes)
	Confirm the value.

6.7.8 Output Error Latch (INIT > SFty > OUT.M > E.LAT)

	Select the Error latch (E.LAT) parameter. When E.LAT is enabled, if any output error is detected (output break detection), the unit will be put in fault mode. Manual intervention is required to clear the error. When E.LAT is disabled, if the fault conditions no longer exist, the unit will resume its previous running state.
	Navigate to the desired setting. Settings include the following: <ul style="list-style-type: none"> • ENbL – Enable sensor error latch. Manual intervention is required to clear the error. • dSbL – Disable sensor error latch. Unit automatically resumes if sensor errors are cleared
	Confirm the value.

6.8 Manual Temperature Calibration (INIT > t.CAL)

	Select the Manual Temperature Calibration (t.CAL) submenu. This parameter allows manual adjustment to the thermocouple, RTD, or Thermistor calibration curves provided with the unit. Once a curve has been manually adjusted, this setting can be set to NoNE to disable the manual adjustment (resetting to factory defaults will remove any manually adjustment factors).
	Navigate to the desired setting. Settings include: <ul style="list-style-type: none"> • NoNE – No manual calibration (factory default) • 1.PNt – Manually create a 1-point calibration • 2.PNt – Manually create a 2-point calibration • ICE.P – Manually create a 1-point calibration at 0°C
	Select the indicated option.

6.8.1 No Manual Temperature Calibration Adjustment (INIT > t.CAL > NoNE)

<input checked="" type="checkbox"/>	Select NoNE to use the standard temperature sensor calibration curves. This mode will be used by most users.
-------------------------------------	---



6.8.2 Manual Temperature Calibration Offset Adjustment (INIT > t.CAL > 1.PNt)

<input checked="" type="checkbox"/>	Select 1.PNt to manually adjust the offset of the calibration curve base on the current reading.
<input type="checkbox"/>	Set the Manual Thermocouple Calibration Offset value in degrees.
<input checked="" type="checkbox"/>	Confirm the Offset value and pair it with the current input reading.



6.8.3 Manual Temperature Calibration Offset and Slope Adjustment (INIT > t.CAL > 2.PNt)

<input checked="" type="checkbox"/>	Select 2.PNt to use 2 points to manually adjust both the offset and slope of the calibration curve.
<input type="checkbox"/>	Navigate to the desired setting. Settings include the following: <ul style="list-style-type: none"> • R.Lo – Set low point in degrees, default = 0, and associate with input reading • R.HI – Set high point in degrees, default = 999.9, and associate with input reading
<input checked="" type="checkbox"/>	Select the indicated setting.
<input type="checkbox"/>	Set the Temperature for R.Lo or R.HI .
<input checked="" type="checkbox"/>	Confirm the value and pair it with the current input reading.



6.8.4 Temperature Ice Point Calibration (INIt > t.CAL > ICE.P)

	Select ICE.P to calibrate the zero point for the temperature sensor. This function basically operates the same as a 1.PNT offset adjustment restricted to a measurement at the freezing point of water.
	Navigate to the ok? To set the ICE POINT value or DSBL to clear the previous ICE POINT offset. <ul style="list-style-type: none"> • Ok? – Offset is calculated, using assumed value of °C. • dSbL– Clears the Ice Point offset value
	Confirm the Ice Point set or reset.

6.9 Save Current Configuration for All Parameters to a File (INIt > SAVE)

	Select Save Current Configuration Settings (SAVE) as the command to execute. If no thumb drive is present the failure code E010 is displayed. Otherwise, a numeric designation for the save file is then specified and confirmed before the SAVE command executes. Important Note: The configuration file is a tab separated text file with a “.TXT” extension. It can be loaded onto a PC, read into Excel then modified there. Once modified, save it back as a tab separated .TXT file and it can then be loaded back into the unit using the INIt > LoAd command. This capability can be especially useful for editing complex multi ramp and soak programs. For more information on the configuration file format, see the “ Load and Save File Format Manual ”.
	Select a numeric file name from the range 0–99.
	Confirm the SAVE command. This saves the configuration to the file number specified. If the SAVE operation fails, the failure code w004 is displayed. If the SAVE operation is successful, doNE is displayed.

6.10 Load a Configuration for All Parameters from a File (INIt > LoAd)

	Select the Load a Configuration (LoAd) command. If no thumb drive is present the failure code E010 is displayed. Otherwise, a numeric designation for the file to be loaded is then specified and confirmed before the LoAd command executes.
	Select a numeric file name from the range 0–99.
	Confirm the LoAd command. This loads the configuration from the file number specified. If the LoAd operation fails, the failure code w003 is displayed. If the LoAd operation is successful, doNE is displayed.

6.11 Display Firmware Revision Number (INIt > VER.N)

	Select the Display Firmware Revision Number (VER.N) function. The currently installed version number is displayed in the format 1.23.4 where “1” is the major revision number, “23” is the minor revision number, and “4” is the bug fix update number.
---	--

6.12 Update Firmware Revision (INIt > VER.U)

<input checked="" type="checkbox"/>	Select the Update Firmware Revision (VER.U) function. Note that updating the firmware will reset the unit to factory defaults. To keep all configuration settings, save them before installing new firmware.
<input checked="" type="checkbox"/>	The LED display shows ok? and requires confirmation. Confirm the firmware update. New firmware will then be read from a thumb drive connected to the USB port.

6.13 Reset to Factory Default Parameters (INIt > F.dFt)

<input checked="" type="checkbox"/>	Select the Reset to Factory Default Parameters (F.dFt) function. The LED display shows ok? and requires confirmation.
<input checked="" type="checkbox"/>	Confirm the parameter reset.

6.14 Password-Protect Initialization Mode Access (INIt > I.Pwd)

<input checked="" type="checkbox"/>	Select the Password Protect Initialization Mode Access (I.Pwd) function.
<input checked="" type="checkbox"/>	Navigate to the desired setting. Settings include the following: <ul style="list-style-type: none"> • No – Do not require a password for INIt Mode (factory default) • yES – Require a password for INIt Mode; users will be prompted for this password when selecting INIt
<input checked="" type="checkbox"/>	Select the indicated setting.
<input checked="" type="checkbox"/>	If yES , set the numeric password from the range 0000–9999.
<input checked="" type="checkbox"/>	Confirm the password.

6.15 Password-Protect Programming Mode Access (INIt > P.Pwd)



<input checked="" type="checkbox"/>	Select the Password Protect Programming Mode Access (P.Pwd) function.
<input checked="" type="checkbox"/>	Navigate to the desired setting. Settings include the following: <ul style="list-style-type: none"> • No – Do not require a password for PRoG Mode (factory default) • yES – Require a password for PRoG Mode; users will be prompted for this password when selecting PRoG
<input checked="" type="checkbox"/>	Select the indicated setting.
<input checked="" type="checkbox"/>	If yES , set the numeric password from the range 0000–9999.
<input checked="" type="checkbox"/>	Confirm the password.

7. Reference Section: Programming Mode (PRoG)





Use Programming Mode to set the following parameters and perform the following functions:

7.	Reference Section: Programming Mode (PRoG)	48
7.1	Setpoint 1 Configuration (PRoG > SP1)	48
7.2	Setpoint 2 Configuration (PRoG > SP2)	48
7.3	Alarm Mode Configuration (PRoG > ALM.1, ALM.2).....	49
7.4	Output Channel 1–6 Configuration (PRoG > oUt.1–oUt.6).....	53
7.5	PID Configuration (PRoG > PId.S)	58
7.6	Remote Setpoint Configuration (PRoG > RM.SP).....	61
7.7	Multi-Ramp/Soak Mode Parameters (PRoG > M.RMP)	64



7.1 Setpoint 1 Configuration (PRoG > SP1)

	Select the Setpoint 1 (SP1) parameter.
	Set the process goal value for PId or oN.oF control.
	Confirm the value.

7.2 Setpoint 2 Configuration (PRoG > SP2)

	Select the Setpoint 2 (SP2) parameter. SP2 is used with Alarm functions and with on/off control when setting up for Heat/Cool Control Mode.
	Navigate to the desired setting. Settings include the following: <ul style="list-style-type: none"> • ASbo – The value for SP2 is specified in Absolute Mode (factory default) • dEVI – The value specified for SP2 indicates an offset (positive or negative) from SP1; this allows SP2 to track any changes to SP1 automatically
	Select the indicated setting.
	Set the correct value.
	Confirm the value.

7.3 Alarm Mode Configuration (PRoG > ALM.1, ALM.2)

	Select Alarm Configuration 1 (ALM.1) or Alarm Configuration 2 (ALM.2) in order to set up, change, enable, or disable Alarms. Either or both Alarms can be assigned to trigger display color changes, annunciators, and / or outputs. Either or both Alarm configurations can be assigned to multiple outputs. The ALM.1 and ALM.2 configuration menus have all of the same settings and function in the same manner.
	<p>Navigate to the Alarm setting to change. Settings include the following:</p> <ul style="list-style-type: none"> • tyPE – Alarm type absolute or deviation • Ab.dV – Alarm references values (ALR.H and ALR.L) or deviation from SP1 or SP2 • ALR.H – Alarm high parameter, used for Alarm trigger calculations • ALR.L – Alarm low parameter, used for Alarm trigger calculations • A.CLR – Alarm color indication • HI.HI – High High / Low Low offset value • LtCH – Alarm latching • CtCL – Alarm action (normally open or normally closed) • A.P.oN – Alarm power-on behavior • dE.oN – Time delay for Alarm trigger unless the condition persists, default = 1.0 s • dE.oF – Time delay for cancelling Alarms after being triggered; prevents Alarm “chatter,” default = 0.0 s
	Select the indicated setting.

7.3.1 Alarm Type (PRoG > ALM.1, ALM.2 > tyPE)



	Select the Alarm Type (tyPE) parameter. This parameter will control the basic behavior of the selected alarm.
	<p>Navigate to the desired setting. Settings include the following:</p> <ul style="list-style-type: none"> • oFF – Alarm is off (factory default) • AboV – Alarm is triggered when the process value exceeds ALR.H (Absolute Mode) or the specified Setpoint plus ALR.H (Deviation Mode) • bELo – Alarm is triggered when the process value is less than ALR.L (Absolute Mode) or the specified Setpoint minus ALR.L (Deviation Mode) • HI.Lo. – Alarm is triggered when the process value is outside the ALR.L–ALR.H range (Absolute Mode) or the range defined by the band around the specified Setpoint as determined by ALR.L and ALR.H (Deviation Mode) • bANd – Alarm is triggered when the process value is within the ALR.L–ALR.H range (Absolute Mode) or within the band around the specified Setpoint as determined by ALR.L and ALR.H (Deviation Mode) <p><i>Note:</i> Table 5.1 compares the Alarm range options, and Figure 5.1 represents the Alarm range options graphically.</p>
	Select the indicated setting.

Table 7 – Alarm Range Option Comparison

Setting	Absolute (AbSo)	Deviation (d.SP1)	Deviation (d.SP2)
AboV	> ALR.H	> SP1 + ALR.H	> SP2 + ALR.H
bELo	< ALR.L	< SP1 - ALR.L	< SP2 - ALR.L
HI.Lo.	< ALR.L or > ALR.H	< SP1 - ALR.L or > SP1 + ALR.H	< SP2 - ALR.L or > SP2 + ALR.H
bANd	> ALR.L and < ALR.H	> SP1 - ALR.L and < SP1 + ALR.H	> SP2 - ALR.L and < SP2 + ALR.H

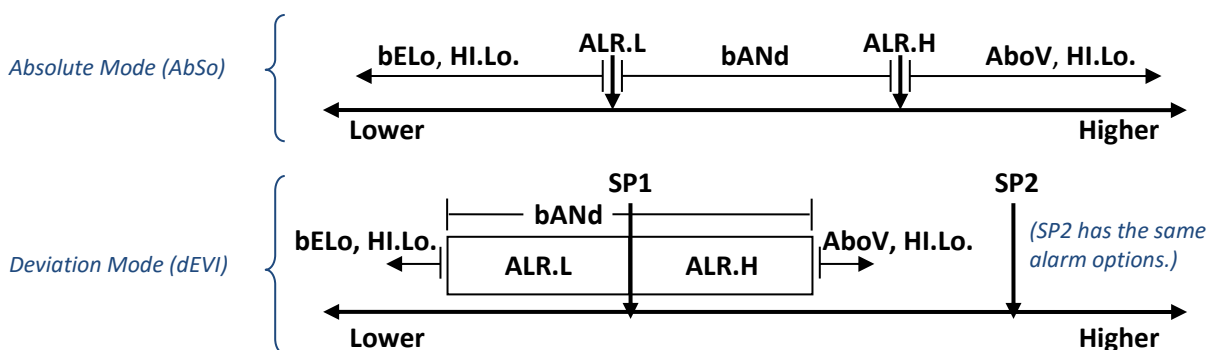

Figure 10 – Alarm Range Option Diagram

7.3.2 Absolute or Deviation Alarm (PRoG > ALM.1, ALM.2 > tyPE > Ab.dV)

<input checked="" type="checkbox"/>	Select the Absolute or Deviation Alarm (Ab.dV) parameter.
<input checked="" type="checkbox"/>	Navigate to the correct setting. Settings and sub settings include the following: <ul style="list-style-type: none"> • AbSo – Alarm is triggered using calculations based on the absolute values of ALR.H or ALR.L used as specified by the tyPE parameter • d.SP1 – Alarm is triggered using calculations based on values relative to SP1 as specified by the tyPE parameter • d.SP2 – Alarm is triggered using calculations based on values relative to SP2 as specified by the tyPE parameter. • CN.SP – Alarm is triggered using calculations based on values relative to instantaneous control setpoint generated by Ramp & Soak as specified by the tyPE parameter.
<input checked="" type="checkbox"/>	Select the desired setting.

7.3.3 Alarm High Reference (PRoG > ALM.1, ALM.2 > tyPE > ALR.H)

<input checked="" type="checkbox"/>	Select the Alarm High Reference (ALR.H) parameter.
<input checked="" type="checkbox"/>	Set the Alarm High Reference value.
<input checked="" type="checkbox"/>	Confirm the value.

7.3.4 Alarm Low Reference (PRoG > ALM.1, ALM.2 > tyPE > ALR.L)

<input checked="" type="checkbox"/>	Select the Alarm Low Reference (ALR.L) parameter.
<input checked="" type="checkbox"/>	Set the Alarm Low Reference value.
<input checked="" type="checkbox"/>	Confirm the value.

7.3.5 Alarm Color (PRoG > ALM.1, ALM.2 > A.CLR)

<input checked="" type="checkbox"/>	Select the Alarm Color (A.CLR) parameter.
<input checked="" type="checkbox"/>	Navigate to the desired option. Options include the following: <ul style="list-style-type: none"> • REd – Alarm conditions are displayed in red (factory default) • AMbR – Alarm conditions are displayed in amber • GRN – Alarms conditions are displayed in green • dEft – Alarms do not affect the default display color
<input checked="" type="checkbox"/>	Select the desired option.

7.3.6 Alarm High High / Low Low Offset Value (PRoG > ALM.1, ALM.2 > HI.HI)

<input checked="" type="checkbox"/>	Select the Alarm Offset Value (HI.HI) parameter. This parameter allows an offset to be added to the Alarm trigger point(s) which will flash the display when exceeded. Depending on the Alarm type the offset can apply above the trigger point, below it, or both. This is illustrated in Figure 5.2. HI.HI works with both absolute and deviation Alarms.
<input checked="" type="checkbox"/>	Navigate to the correct option. Options include the following: <ul style="list-style-type: none"> • oFF – High High / Low Low function disabled (factory default) • oN – Display will flash in the color determined by the A.CLR parameter when the Process Value is greater than the HI.HI offset value away from the Alarm condition settings (in either direction)
<input checked="" type="checkbox"/>	Select the indicated option.
<input checked="" type="checkbox"/>	For oN , set the offset value.
<input checked="" type="checkbox"/>	Confirm the value.

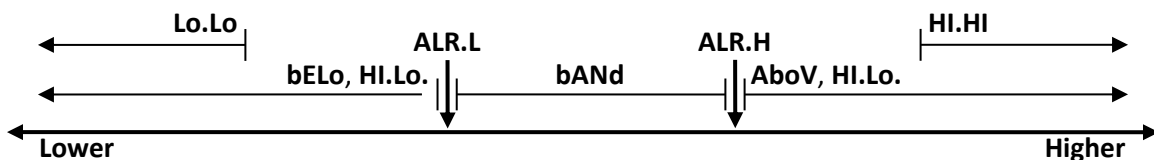







Figure 11 – Alarm HI.HI parameter.



7.3.7 Alarm Latching (PRoG > ALM.1, ALM.2 > LtCH)

	Select the Alarm Latching (LtCH) parameter.
	Navigate to the desired option. Options include the following: <ul style="list-style-type: none"> • No – Alarm does not latch (factory default); the Alarm turns off when the Process Value returns to a non-Alarm condition • yES – Alarm latches; even if the Process Value returns to a non-Alarm condition, the Alarm condition remains active and must be unlatched using oPER > L.RSt • boTH – Alarm latches and can be unlatched either by using oPER > L.RSt from the front panel or via the digital input • RMt – Alarm latches and can be unlatched only via the digital input
	Select the indicated option.



7.3.8 Alarm Normally Closed, Normally Open (PRoG > ALM.1, ALM.2 > CtCL)

	Select the Alarm Normally Open or Normally Closed (CtCL) parameter.
	Navigate to the desired option. Options include the following: <ul style="list-style-type: none"> • N.o. – Normally open: output is activated when the Alarm condition is met (factory default) • N.C. – Normally closed: output is activated in normal conditions, but turned off in the Alarm condition
	Select the indicated option.



7.3.9 Alarm Power-On Behavior (PRoG > ALM.1, ALM.2 > A.P.oN)

	Select the Alarm Power-On Behavior (A.P.oN) parameter.
	Navigate to the desired option. Option include: <ul style="list-style-type: none"> • yES – Alarms are active at power-on and do not require crossing the Setpoint (factory default) • No – Alarms are inactive at power-on; the process reading must cross the Alarm condition before being activated
	Select the indicated option.





7.3.10 Alarm on Delay (PRoG > ALM.1, ALM.2 > dE.oN)

	Select the Alarm On Delay (dE.oN) parameter.
	Set the number of seconds to delay triggering the Alarm. (The default is 0.) This setting can be used to prevent false Alarm triggering when the Process Value only briefly enters an Alarm condition.
	Confirm the value.



7.3.11 Alarm Off Delay (PProg > ALM.1, ALM.2 > dE.oF)

	Select the Alarm Off Delay (dE.oF) parameter.
	Set the number of seconds to delay cancelling the Alarm. (The default is 0.) This setting can be used to prevent Alarm chatter.
	Confirm the value.

7.4 Output Channel 1–6 Configuration (PProg > oUt.1–oUt.6)

	<p>Navigate to the desired output channel. The number and type of output channels on the PLATINUM™ Series are automatically recognized by the device. The following output names display, replacing the generic oUt.1 through oUt.6 references used in this document:</p> <ul style="list-style-type: none"> • StR1 – Single Throw Mechanical Relay number 1 • StR2 – Single Throw Mechanical Relay number 2 • StR3 – Single Throw Mechanical Relay number 3 • StR4 – Single Throw Mechanical Relay number 4 • dtR1 – Double Throw Mechanical Relay number 1 • dtR2 – Double Throw Mechanical Relay number 2 • SSR1 – Solid State Relay number 1 • SSR2 – Solid State Relay number 2 • SSR3 – Solid State Relay number 3 • SSR4 – Solid State Relay number 4 • dC1 – DC Pulse output number 1 • dC2 – DC Pulse output number 2 • dC3 – DC Pulse output number 3 • ANG1 – Analog output number 1 • IdC1 – Isolated DC Pulse output number 1 • IdC2 – Isolated DC Pulse output number 2 • IAN1 – Isolated Analog output number 1 <p><i>Note:</i> All output channels have the same menu structure. However, only those parameters that apply for the type of output being configured appear in that output's menu.</p>
	Select the indicated output channel.
	<p>Navigate to the desired submenu. Submenus include the following:</p> <ul style="list-style-type: none"> • ModE – Allows the output to be set up as a control, Alarm, retransmission, or Ramp/Soak event output; the output can also be turned off • CyCL – PWM pulse width setting for DC pulse, mechanical relay, and solid state relay outputs • RNGE – Sets the voltage or current range for analog outputs
	Select the indicated setting.

7.4.1 Output Channel Mode (PRoG > oUt1-oUt6 > ModeE)

	Select Output Channel Mode (ModeE) to configure the specified output.
	<p>Navigate to the desired setting. Settings include the following:</p> <ul style="list-style-type: none"> • oFF – Turn off the output channel (factory default) • PId – Set the output to Proportional-Integral-Derivative (PID) Control Mode • oN.oF – Set the output to On/Off Control Mode • ALM.1 – Set the output to be an Alarm using the ALM.1 configuration • ALM.2 – Set the output to be an Alarm using the ALM.2 configuration • RtRN – Set up the output for Retransmission • RE.oN – Turn on the output during Ramp events • SE.oN – Turn on the output during Soak events
	Select the indicated setting.

7.4.1.1 Turn Off Output Channel (PRoG > oUt1-oUt6 > ModeE > oFF)

	Turn off this output (oFF).
---	--------------------------------------

7.4.1.2 PID Control Mode (PRoG > oUt1-oUt6 > ModeE > PId)

	Select PID Control Mode (PId) for this output (factory default). PID parameters are set outside the specific output submenus, as more than one output can be used for PID control at a time. See 7.5 PID Configuration (PRoG > PID) .
--	---

7.4.1.3 PID 2 Control Mode (PRoG > oUt1-oUt6 > ModeE > PId.2)

	Select PID Control Mode (PId.2) for this output. PID.2 parameters are set outside the specific output submenus, as more than one output can be used for PID.2 control at a time. See 7.5 PID Configuration (PRoG > PID) .
---	---

7.4.1.4 On/Off Control Mode (PRoG > oUt1-oUt6 > ModeE > oN.oF)

	Select On/Off Control Mode (oN.oF) for this output. More than one output can be set up for oN.oF control. For Heat / Cool control set the output connected to the heater with ACtN equal to RVRS and the output connected to the cooling device with ACtN set to dRcT .
---	---

	<p>Navigate to the desired setting. Settings include the following:</p> <ul style="list-style-type: none"> • ACTN – Determines the action direction for control • dEAd – Sets the deadband value; the deadband value is applied in the same units as the process variable to one side of Setpoint as determined by the ActN direction • S.Pnt – Allows either Setpoint 1 or Setpoint 2 to be specified as the target value; Setpoint 2 can be set to track Setpoint 1 using the deviation (dEVI) option (7.2 Setpoint 2 (PRoG > SP2))—a useful feature when setting up for heat/cool operation
	<p>Select the indicated setting.</p>
	<p>For ACTN, select the correct setting. Settings include the following:</p> <ul style="list-style-type: none"> • RVRS – Off when Process Value is > Setpoint, and on when Process Value is < Setpoint (e.g., heating); deadband is applied below Setpoint (factory default) • dRCt – Off when Process Value is < Setpoint, and on when Process Value is > Setpoint (e.g., cooling); deadband is applied above Setpoint <p>For dEAd, set the desired value. (The default is 5.0.)</p>
	<p>Select the indicated ACTN setting, or confirm the dEAd value.</p>

7.4.1.5 Output as Alarm 1 (PRoG > oUt1–oUt6 > ModE > ALM.1)

	<p>Select this Output to be an Alarm using the Alarm 1 (ALM.1) configuration.</p>
--	--

7.4.1.6 Output as Alarm 2 (PRoG > oUt1–oUt6 > ModE > ALM.2)

	<p>Select this Output to be an Alarm using the Alarm 2 (ALM.2) configuration.</p>
--	--

7.4.1.7 Retransmission (PRoG > oUt1–oUt6 > ModE > RtRN)

	<p>Select Retransmission (RtRN) as the Operating Mode for the output. This option is only available for analog outputs. Scaling is performed using absolute values—not calculated counts. The retransmission signal type (voltage or current and range) is set for this output using the 7.4.3 Analog Output Range (PRoG > oUt1–oUt6 > RNgE) parameter. The retransmission signal is then scaled using the following 4 parameters. The unit will display the first scaling parameter, Rd1, after RtRN is selected.</p>
--	---

◀▶	Navigate to the desired setting. Settings include the following: <ul style="list-style-type: none"> • Rd1 – Process reading 1; the process reading that corresponds to the output signal oUt1 • oUt1 – The output signal that corresponds to the process value Rd1 • Rd2 – Process reading 2; the process reading that corresponds to the output signal oUt2 • oUt2 – The output signal that corresponds to the process value Rd2
☑	Select the indicated setting.
◀▶	Set the desired value.
☑	Confirm the value.

7.4.1.8 Set Output to Ramp Event Mode (PRoG > oUt1-oUt6 > ModE > RE.oN)

☑	Activate Output to Ramp Event Mode (RE.oN) during Ramp segments in Ramp and Soak programs when the Ramp Event flag is set for that Ramp segment. This can be used to turn on auxiliary devices such as fans or stirrers, secondary heaters, etc.
---	---

7.4.1.9 Set Output to Soak Event Mode (PRoG > oUt1-oUt6 > ModE > SE.oN)

☑	Activate Output to Soak Event Mode (SE.oN) during Soak segments in Ramp and Soak programs when the Soak Event flag is set for that Soak segment. This can be used to turn on auxiliary devices such as fans or stirrers.
---	---

7.4.1.10 Set Output to Sensor Error Event Mode (PRoG > oUt1-oUt6 > ModE > SEN.E)

☑	Activate Output to Sensor Error (SEN.E) Event Mode. The output will activate when any sensor error is detected (i.e: open sensor, out of range, loop break). This can be used to turn on an indicator or alarm to indicate the condition of sensor.
---	--

7.4.1.11 Set Output to Output Break Event Mode (PRoG > oUt1 - oUt6 > ModE > O)

☑	Activate Output to Open Loop Error (oPL.E) Event Mode. The output will activate when output break is detected. See INIT > SFty > OUT.M for output monitor setup. This can be used to turn on an indicator or alarm to indicate the condition of output actuator.
---	--

7.4.2 Output Cycle Pulse Width (PRoG > oUt1-oUt6 > CyCL)



☑	Select the Output Cycle Pulse Width (CyCL) parameter. This parameter is used to set the control signal pulse width in seconds for DC pulse, mechanical relay, and solid state relay (SSR) outputs.
---	---

◀▶	Set a value. <i>Note:</i> For DC pulse and SSR outputs, choose a value between 0.1 and 199.0. (The default is 0.1s.) For mechanical relays, choose a value between 1.0 and 199.0. (The default is 5.0s.)
☑	Confirm the value.



7.4.3 Analog Output Range (PRoG > oUt1-oUt6 > RNGE)

☑	Select the Output Range (RNGE) parameter. This menu choice is only available for analog outputs. The RNGE parameter is used for both Control and Retransmission Modes and generally must be matched to the input range for whatever device the analog output is driving.
◀▶	Navigate to the desired setting. Settings include the following: <ul style="list-style-type: none"> • 0-10 – 0 to 10 Volts (factory default) • 0-5 – 0 to 5 Volts • 0-20 – 0 to 20 mA • 4-20 – 4 to 20 mA • 0-24 – 0 to 24 mA
☑	Select the desired range setting.



7.5 PID Configuration (PRoG > PId.S)

	Select PId.S to configure the PID control settings. These settings apply to all outputs that have had their Control Mode set to PID (7.4.1.2 PID Control Mode (PRoG > oUt1-oUt6 > ModE > PId)). PID control can be optimized in a variety of ways. The suggested way is to initiate an Autotune command (7.5.3 Autotune (PRoG > PId > AUto)) and then enable adaptive tuning (7.5.7 Adaptive Tuning (PRoG > PId > AdPt)). The PID parameters may also be set manually or manually adjusted after an Autotune command has been executed.
	Navigate to the desired setting. Settings include the following: <ul style="list-style-type: none"> • ACtN – Action direction moves up or down to SP1 • A.to – Autotuning Timeout sets a maximum amount of time for Autotuning • AUto – Initiates Autotuning • GAIN – Select the proportional, integral, and derivative factors for manual tuning • %Lo – Low clamping limit for Pulse and Analog outputs • %HI – High clamping limit for Pulse and Analog outputs • AdPt – Fuzzy logic adaptive tuning
	Select the desired parameter.



7.5.1 Action Response (PRoG > PId > ACtN)

	Select the Direction (ACtN) parameter.
	Navigate to the desired setting. Settings include the following: <ul style="list-style-type: none"> • RVRS – “Reverse Action”: Increase to SP1, such as heating (factory default) • dRCt – “Direct Action”: Decrease to SP1, such as cooling • RVRS/dRCt – Increase or Decrease to SP1, such as heating/cooling
	Select the indicated setting.

7.5.2 Autotune Timeout (PRoG > PId > A.to)

	Select the Autotune Timeout (A.to) parameter.
	Set the amount of time before the Autotune process gives up and times out in Minutes and Seconds (MM.SS). Slowly responding systems should have a longer time-out setting.
	Select the indicated setting.





7.5.3 Autotune (PRoG > PId > TUNE)

	Select the Autotune (AUto) command. The unit displays StRt.
	Confirm Autotune activation. The unit attempts to optimize the P , I , and d settings by stimulating the system and measuring the response. If the A.to time out period expires before the Autotune operation can complete, the unit displays a failure message E007 . If the Autotune operation completes successfully, the unit displays the message “ doNE ” and the Run mode is switched to IDLE .

The Autotune function will select the tuning algorithm depending on the stability of current process and the error difference between current process and the Control Setpoint (**SP1**). If the process is relatively stable (i.e: at room temperature), a bump test will be performed to determine the plant characteristics.

If the process is hot, or if the process is within 10% of Control Setpoint, limit cycle oscillation will be performed with the tuning setpoint taken at the process value when the Autotune function is triggered. Autotuning may be performed as many times as needed or when the operating conditions (i.e: process load, or setpoint) have changed significantly. To obtain good tuning results, ensure the process is stable prior to triggering autotune function. The process is stable when it is at ambient temperature, or it is tracking Control Setpoint (**SP1**) in auto mode.

7.5.4 PID Gain Settings (PRoG > PId > GAIN)

	<p>Select Gain (GAIN) to manually adjust the PID factors. Setting I to zero sets the controller for “PD” control, setting d to zero sets the controller for “PI” control, and setting both I and d to zero sets the controller for “proportional” control. Most of the time use Autotune, and adaptive tuning, and letting the system optimize its own PID factors. The P, I, and d factors are used to calculate output power according to the following equation:</p> $\%On = P \cdot e + I \cdot \text{SUM}(e) + d \cdot (de/dt)$ <ul style="list-style-type: none"> • %On = %Power for Analog Outputs or %On Width for PWM Outputs • e = Error Function = Setpoint – Process Value • SUM(e) = A summation of the Error Function over time • de/dt = The rate of change of the Error Function over time <p>The P, I, and d factors can initially be set using the Autotune function and then fine-tuned. Time unit is in seconds.</p>
	<p>Navigate to the desired manual parameter. Parameters include the following:</p> <ul style="list-style-type: none"> • _P_ – Proportional Factor. The proportional factor amplifies the error function (process value minus Setpoint) to accelerate progress towards to the Setpoint. (The default value is 001.0.) • _I_ – Integral Factor. The integral term amplifies the integrated error function over time and can increase the acceleration towards the Setpoint faster than the Proportional factor (and potentially result in more “overshoot”). This factor is sometimes referred to by its reciprocal, “Reset.” • _d_ – Derivative Factor. The derivative term (sometimes referred to by its reciprocal, “Rate”) senses the rate of rise or fall of the input measurement and throttles the PID algorithm accordingly. A higher value for this factor can speed up or slow down the response of the system even faster than an increase in the Integral Factor will.
	<p>Select the indicated setting.</p>
	<p>Set the desired value.</p>
	<p>Confirm the value.</p>

7.5.5 Relative Cool Gain (PRoG > PId > rCg)

<input checked="" type="checkbox"/>	Select the Relative Cool Gain (rCg) parameter. The cooling output will be adjusted by this multiplier. Valid only for Reverse/Direct (RVRS/dRct) control mode. Relative Cool Gain is useful to restore heat/cool balance when heater and cooler of different power ratings are used.
<input type="checkbox"/>	Set the desired value.
<input checked="" type="checkbox"/>	Confirm the value.

7.5.6 Control Offset (PRoG > PId > oFst)

<input checked="" type="checkbox"/>	Select the Control Offset (oFst) parameter. Control Offset is a manual adjustment to the PID output power. The parameter is effective when the PID output power is non-zero. Control Offset is useful when the output power needs to start from a value other than zero (i.e: PWM delivery to a motor fan) %On = %PID + Offset
<input type="checkbox"/>	Set the desired value.
<input checked="" type="checkbox"/>	Confirm the value.

7.5.7 Deadband (PRoG > PId > dEAd)

<input checked="" type="checkbox"/>	Select the Dead band/Overlap band (dEAd) parameter. A positive value sets a deadband and a negative value sets an overlap band. Deadband parameter creates a band on both sides of control setpoint in which the same output power is maintained. Overlap band parameter creates a band on both sides of control setpoint in which both reverse and direct outputs that are controlled by the same PID channel are activated.
<input type="checkbox"/>	Set the desired value.
<input checked="" type="checkbox"/>	Confirm the value.

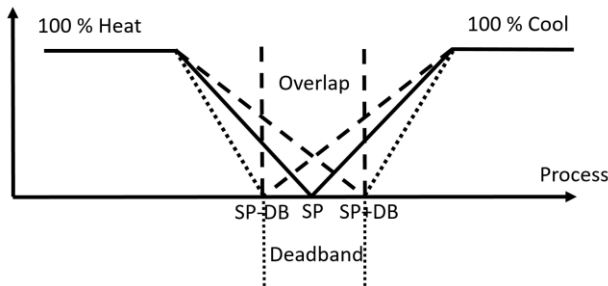

7.5.8 Low Output Clamping Limit (PRoG > PId > %Lo)

<input checked="" type="checkbox"/>	Select the Low Output Clamping Limit (%Lo) parameter. This parameter sets the lower limit of %Power applied to an analog output, or %On time for PWM (pulse width modulated) control used with the other output types. (The default setting is -100.0%.)
<input type="checkbox"/>	Set the desired value.
<input checked="" type="checkbox"/>	Confirm the value.

7.5.9 High Output Clamping Limit (PRoG > Pid > %HI)

<input checked="" type="checkbox"/>	Select the High Output Clamping Limit (%HI) parameter. This parameter sets the upper limit for %power to analog outputs or %on time for PWM control with the other output types. (The default setting is 100.0%.)
<input type="checkbox"/>	Set the desired value.
<input checked="" type="checkbox"/>	Confirm the value.

7.5.10 Adaptive Tuning (PRoG > Pid > AdPt)

<input checked="" type="checkbox"/>	Select the Adaptive Tuning (AdPt) parameter.
<input type="checkbox"/>	Navigate to the desired setting. When adaptive tuning is enabled, the PID parameters are continually optimized based on the process input changes caused by the current output control parameters. This is the easiest way to optimize the PID algorithm for a wide variety of systems. Adaptive tuning minimizes overshoot and decreases settling time. Autotune is recommended for setting up adaptive tuning feature. Settings include the following: <ul style="list-style-type: none"> • ENbL – Enables fuzzy logic adaptive tuning (factory default) • dSbL – Disables fuzzy logic adaptive tuning
<input checked="" type="checkbox"/>	Select the indicated setting.

7.6 PID.2 Configuration (PRoG > Pid.2)

	Note: PID.2 is an independent control channel with separate configuration parameters. Both PID and PID.2 channels drive toward the same Control Setpoint. PID.2 channel is useful when the process is being controlled by two actuators with completely different characteristics. To minimize interactions between the two loops, consider adding a process deadband .
--	--

7.7 Remote Setpoint Configuration (PRoG > RM.SP)

<input checked="" type="checkbox"/>	Select the Remote Setpoint Configuration (RM.SP) parameter.
<input type="checkbox"/>	Navigate to the desired setting. A remote signal can then be used to set and/or change the Setpoint value using an analog input. This function can be used for a variety of applications where direct access to the controller for Setpoint manipulation is a problem (hazardous environments, lack of proximity, etc.). It can also be used to configure the controller in a cascaded control scheme. Settings include the following: <ul style="list-style-type: none"> • oFF – Do not use a remote Setpoint (factory default) • oN – Remote Setpoint replaces Setpoint 1 Note: oFF has no sub-parameters, but oN requires scaling of the remote Setpoint input.
<input checked="" type="checkbox"/>	Select the indicated setting.

◀▶	<p>If oN, navigate to the desired input range. Options include the following:</p> <ul style="list-style-type: none"> • 4–20 – 4.00–20.00 mA input signal range • 0–24 – 0.00–24.00 mA input signal range • 0–10 – 0.00–10.00 V input signal range • 0–1 – 0.00–1.00 V input signal range
☑	<p>Select the desired input signal range to proceed to the scaling parameters starting with RS.Lo.</p>
◀▶	<p>Navigate to the desired setting. Settings include the following:</p> <ul style="list-style-type: none"> • RS.Lo – Minimum Setpoint value (entry point). Setpoint 1 is set to this value when the analog input signal is IN.Lo. • IN.Lo – Input value in mA or V for RS.Lo • RS.HI – Maximum Setpoint value. Setpoint 1 is set to this value when the analog input signal is IN.HI. • IN.HI – Input value in mA or V for RS.HI
☑	<p>Select the indicated setting.</p>
◀▶	<p>Set the desired value.</p>
☑	<p>Confirm the value.</p>

7.7.1 Cascade Control using Remote Setpoint

The remote Setpoint feature of the PLATINUM™ Series controllers can be used in a variety of applications where Setpoints can be sent to the controllers from remote devices such as a manual pots, transmitters, computers, etc. This feature can also be used to set up a “cascade control” system, where the remote Setpoint input is generated by another controller. **Figure 12** shows a generic diagram of a cascade control system and **Figure 13** shows a typical example, in this case a heat exchanger application.

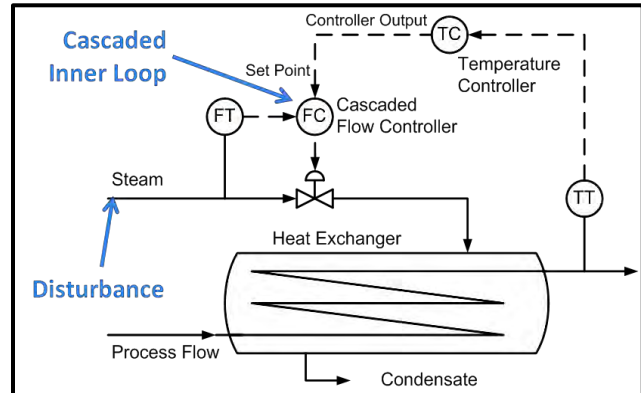
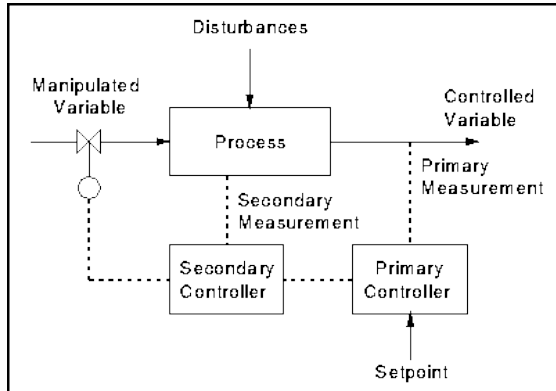





Figure 12 Generic Cascade Control Diagram **Figure 13** Heat Exchanger with Cascade Control

Cascade control schemes provide tighter control of a process when there are two linked variables, one of which has a much slower (typically 4X or more) response than the other. The slower responding variable is used as the input to the primary or master controller, and the faster responding variable is used as the input to the secondary or slave controller. The output of the primary controller is scaled to be used as the Setpoint for the secondary controller.



In the heat exchanger application in **Figure 13**, the primary goal of the application is to control the temperature of the effluent. Therefore, the desired effluent temperature becomes the Setpoint for the primary controller, which is a temperature controller (TC). The process input for the temperature controller is the measured temperature of the effluent (TT). The output of the temperature controller is the flow Setpoint for the secondary controller, which is a flow controller (FC). The process input for the secondary (flow) controller is the flow rate of the steam that is used to heat the process flow through the heat exchanger (FT). The output of the secondary (flow) controller is a control signal for the proportional™ valve controlling the flow of the steam.

By isolating the slowly changing effluent temperature control loop from the rapidly changing flow control loop, a more predictable, robust, and tighter control scheme results.



7.8 Multi-Ramp/Soak Mode Parameters (PRoG > M.RMP)

	<p>Select Multi-Ramp/Soak Mode (M.RMP) for activation and configuration to store, and load up to 99 Ramp/Soak programs. Each program can have up to 8 Ramps and 8 Soaks including the ability to activate auxiliary (non-control) outputs during any or all Ramp and Soak segments. Any segment soak setpoint can be an increase or a decrease from the previous soak setpoint and the unit will automatically determine the control direction (reverse or direct) for the associated ramp. The end action (E.Act) can be defined as StOP, HOLd, or LINK. By using LINK, one program can be specified to start at the end of the previous program, creating an absolute capability to set up a program with 8*99 or 792 ramps and 792 soaks. In addition, a program can be linked to itself to create a continuously cycling profile.</p> <p>Configuration settings files can be edited on a PC in Excel and this can be especially useful when creating / editing complex ramp and soak programs. See 6.9 INIt > SAVE for further information on this.</p> <p>For an overview of Ramp and Soak programming including examples see Section 7.7.8 More on Multi-Ramp/Soak Programming.</p> <p>Note: When setting up multidirectional ramp and soak programs, only one direction can use PID control as PID control is set to reverse (heating) or direct (cooling) action for any and all outputs assigned to MoDE > PID. PID Autotuning of the system under control will tune only for the PID action direction as the optimum PID parameters for the other action direction may be completely different. On/Off control must be used to set up any output(s) for the other action direction.</p>
	<p>Navigate to the desired setting. Settings include the following:</p> <ul style="list-style-type: none"> • R.CtL – Activate Multi-Ramp/Soak Mode • S.PRG – Program number • M.trk – Multi-Ramp/Soak tracking setting • tIM.F – Time format for Ramp/Soak programs • N.SEG – Number of segments • S.SEG – Segment number for editing • E.Act – Determines what happens at the end of a program
	<p>Select the indicated setting.</p>



7.8.1 Multi-Ramp/Soak Mode Control (PRoG > M.RMP > R.CtL)

	<p>Select the Multi-Ramp/Soak Mode Control (R.CtL) parameter.</p>
	<p>Navigate to the desired setting. Settings include the following:</p> <ul style="list-style-type: none"> • No – Multi-Ramp/Soak Mode off • yES – Multi-Ramp/Soak Mode on; must be started from front panel • RMt – Multi-Ramp/Soak Mode on; front panel or digital input to start
	<p>Select the indicated setting.</p>



7.8.2 Select Program (PRoG > M.RMP > S.PRG)

	Select the Select Program (S.PRG) parameter. The current profile for the selected program number will be loaded and can be used as is or modified.
	Set the number (1–99) corresponding to the Ramp/Soak profile to be loaded for use or editing. (The default is 1)
	Confirm the value.



7.8.3 Multi-Ramp/Soak Tracking (PRoG > M.RMP > M.tRk)

	Select the Multi-Ramp/Soak Tracking (M.tRk) parameter. This parameter has three settings that allow for different ways to manage ramp and soak program tracking.
	<p>Navigate to the desired setting. Settings include the following:</p> <ul style="list-style-type: none"> • RAMP – Guaranteed Ramp Mode. If the soak setpoint is not reached within the specified Ramp Time, the Ramp and Soak cycle will terminate, the outputs are disabled, and a failure message (E008) will be displayed. • SoAK – Guaranteed Soak Mode. If the soak setpoint is not reached within the specified Ramp Time the system will continue to Ramp and not transition to the Soak Mode until the Soak point is reached. The full specified Soak time is preserved. • CYCL – Guaranteed Cycle Mode. If the soak setpoint is not reached within the specified Ramp Time, the unit will continue to ramp until that setpoint is reached. The additional ramp time required is subtracted from the soak time so that the specified cycle time (ramp time + soak time) is preserved. If the soak setpoint is still not reached at the end of total cycle time, the ramp and soak program will terminate, the outputs are disabled, and the failure message (E0008) will be displayed.
	Select the indicated setting.



7.8.4 Time Format (PRoG > M.RMP > tIM.F)

	Select the default Ramp and Soak Time Format (tIM.F) parameter for the current program. The default format can be overridden to create mixed time mode Ramp and Soak programs. NOTE: The time format option does not appear in 6 digit display units, which always show time as HH:MM:SS
	<p>Navigate to the desired setting. Settings include the following:</p> <ul style="list-style-type: none"> • MM.SS – Time specified in minutes and seconds (factory default) • HH.MM – Time specified in hours and minutes. Indicated by turning on the negative sign to differentiate from MM.SS format when adjusting the MRT.# and MST.# parameters for a given segment.
	Select the indicated option. Note that the default time format can be overridden for any given segment time by pressing the left arrow with that time showing until it sequences through each digit and then the entire time flashes. Pressing the right arrow at that point will change the setting for that segment to the other time format.





7.8.5 Program End Action (PRoG > M.RMP > E.ACT)

	Select the End Action (E.ACT) parameter.
	Navigate to the desired setting. Settings include the following: <ul style="list-style-type: none"> • StOP – Enter standby mode displaying RUN at the completion of this program. • HOLd – Hold at the final soak setpoint at the completion of this program. • LINK – Link to another stored ramp & soak program at the completion of this program. <ul style="list-style-type: none"> ○ ## – Specify the Program Number to start at the completion of this program (1 to 99). Specifying 0 will repeat the program specified by S.PRg which can provide for cycling through a series of linked programs. Specifying 100 will restart the last program run in a sequence of linked programs.
	Select the indicated setting.

7.8.6 Number of Segments (PRoG > M.RMP > N.SEG)

	Select the Number of Segments (N.SEG) parameter.
	Set the number of segments (1–8). (The default is 1.)
	Confirm the value.

7.8.7 Segment Number for Editing (PRoG > M.RMP > S.SEG)

	Select the Segment Number for Editing (S.SEG).
	Set the segment number to edit for the Program Number. This segment number selection will replace the “#” digit in all of the ramp and soak control parameters for that segment listed below (MRT.# , MSt.# , etc.), as viewed on the unit’s display. This will help keep track when programming multiple ramp and soak segments from the front panel.
	Confirm the segment number.
	Navigate to the desired setting. Settings include the following: <ul style="list-style-type: none"> • MRT.# – Time for Ramp number # (the default is 10). Ramp and Soak times can be as long as either 99 minutes and 59 seconds or 99 hours and 59 minutes. The default format is controlled by the tIM.F parameter setting for this program. The default can be overridden for any segment time as described under tIM.F. • MRE.# – Determine whether to activate Ramp-event-enabled outputs: <ul style="list-style-type: none"> ○ oFF – Disable Ramp events for this segment (factory default) ○ oN – Enable Ramp events for this segment. At least one output must be set to MoDE = RE.oN for an enabled ramp event to actually do anything. • MSP.# – Setpoint value for Soak cycle # • MSt.# – Time for the Soak cycle (the default is 10). See MRT.# for more info. • MSE.# – Determine whether to activate Soak-event-enabled outputs: <ul style="list-style-type: none"> ○ oFF – Disable Soak events for this segment (factory default) ○ oN – Enable Soak events for this segment. At least one output must be set to MoDE = RE.oF for an enabled soak event to actually do anything.
	Select the indicated setting.

◀▶	Navigate to the correct setting, or set the desired value.
☑	Select the indicated setting, or confirm the value.

7.8.8 More on Multi-Ramp/Soak Programming

7.8.8.1 Overview

A key feature of the Ramp and Soak mechanism is provided by the ability to 'link' ramp/soak segments together to create a chain of sequences. This allows sequences of up to 792 Ramp/Soak pairs to be defined. A Ramp/Soak segment is defined as a specified increase or decrease (Ramp) of the process variable over a set period of time, followed by holding (Soak) the process variable at a fixed level for a fixed period of time.



Figure 14. Ramp & Soak Process Variable Period of Time.

These controllers provide a multi-segment/multi-profile Ramp and Soak mechanism with the additional ability to link multiple profiles together to implement extended sequences.

Although the term 'RAMP' is used to indicate the process variable change, there is no restrictions on the direction of change. The Target Setpoint may be above or below the Current process variable for each cycle within a sequence.

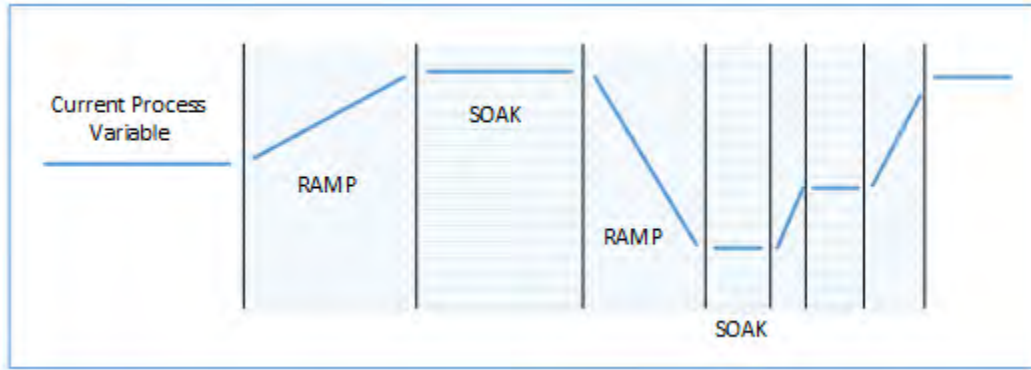

Figure 15. Ramp & Soak Current Process Variable.

The Ramp and Soak times are provided in 1-second increments and may span from 1 second to 99 hours, 59 minutes, 59 seconds. Internally, the time values are tracked within 0.1 second intervals.

The Ramp and Soak function attempts to provide a controlled increase to the process variable such that the target setpoint is reached within the specified time. Options are provided to track the specified RAMP time, the specified SOAK time or the overall CYCLE time.

7.8.8.2 Ramp / Soak Program Linking

LINK parameter		
N	Where N is the number of the current program	Allows continuous cycling of a single program
0	Reload the S.PRG program	Allows continuous process cycling using multiple linked programs
1..99	Load the specified program	Allows linking to a specified program
100	Reload the current program	Allows cycling of the last program in a linked chain of programs

8. Reference Section: Operating Mode (oPER)



Operating Mode is used to activate the unit's monitoring and controlling functions. It also allows shortcut access to the Setpoint parameters while still running. Use Operating Mode to set the following parameters and perform the following functions:

8.	Reference Section: Operating Mode (oPER).....	69
8.1	Normal Run Mode (oPER > RUN).....	69
8.2	Change Setpoint 1 (oPER > SP1).....	69
8.3	Change Setpoint 2 (oPER > SP2).....	70
8.4	Manual Mode (oPER > MANL)	70
8.5	Pause Mode (oPER > PAUS)	71
8.6	Stop Process (oPER > StoP)	71
8.7	Clear Latched Alarms (oPER > L.RSt).....	71
8.8	Display Valley Reading (oPER > VALy).....	71
8.9	Display Peak Reading (oPER > PEAK).....	72
8.10	Standby Mode (oPER > Stby)	72
8.11	Standby Mode (oPER > tARE).....	72



8.1 Normal Run Mode (oPER > RUN)

	Select Normal Run Mode (RUN). The ENTER button starts the unit operating according to the current input, output, and communications settings. Run Mode will automatically be entered and activated at unit power-on if the Power on Confirmation (6.7.1 Power On Confirmation (INIT > Sfty > PwoN)) parameter is set to dSbL . The process value is displayed in the main display, and if the unit uses dual displays, the current Setpoint value is displayed in the secondary display. With the unit remaining active, the oPER menu selections can be navigated to using the LEFT and RIGHT buttons.
---	--





8.2 Change Setpoint 1 (oPER > SP1)

	Select the Change Setpoint 1 (SP1) parameter. This function allows Setpoint 1 to be changed while remaining in Run Mode. Pressing the ENTER button after changing a Setpoint while in RUN Mode returns to RUN Mode with no interruption in monitoring, control, or communications operations. If remote Setpoint is enabled, Setpoint 1 cannot be changed here and the display will flash.
	Set the desired value for Setpoint 1. When changing the Setpoints from the operating mode menu, the left arrow decreases the value with acceleration and the right arrow increases the value with acceleration. This is different from the decimal place switching numeric change control in other places as changes made here are usually limited.
	Confirm the value.

8.3 Change Setpoint 2 (oPER > SP2)

	Select the Change Setpoint 2 (SP2) parameter. This function allows Setpoint 2 to be changed while remaining in RUN Mode. The current value for Setpoint 2 flashes in the main display. Setpoint 2 is only used for Alarms and as the cooling Setpoint in Heat/Cool Control Mode. See 7.1 Change Setpoint 1 (oPER > SP1) for additional information.
	Set the desired value for Setpoint 2.
	Confirm the value.

8.4 Manual Mode (oPER > MANL)

	Select the Manual Operating Mode (MANL). This mode allows for control output levels or the process input value to be manually changed.
	Navigate to the desired Manual Operating Mode. The choices are as follows: <ul style="list-style-type: none"> • M.Cnt – Manually vary the control output(s) • M.INP – Manually simulate change in the process input
	Select the desired Manual Operating Mode.
	Vary the Output or Input manually with the left and right arrows. For M.Cnt , the % On value is displayed instead of the process input value. With analog outputs, the % On value specifies the output current or voltage as a percentage of the total scaled range. With DC Pulse and Relay outputs, the % On value controls the width of the PWM (pulse-width modulated) signal. For M.INP , the process input value continues to be displayed but the value can be changed up or down using the RIGHT and LEFT buttons, respectively. This is a “simulated value” and it can be used to test out Alarm configurations, retransmission scaling, etc.
	Exit Manual Mode and return to Run Mode.

8.5 Pause Mode (oPER > PAUS)

<input checked="" type="checkbox"/>	Select the Pause Operating Mode (PAUS) to pause the controller and hold the process input at its current value. If in a Multi-Ramp/Soak program, the timer for the current Ramp or Soak segment is paused as well. The current process value display will flash while in pause mode.
<input checked="" type="checkbox"/>	Return to RUN Mode or to displaying “ RUN ” depending on the Operating Safety parameter setting (6.7.2 Operating Mode Confirmation (INIt > SFty > oPER)).

8.6 Stop Process (oPER > StoP)

<input checked="" type="checkbox"/>	Select the Stop Operating Mode (StoP) to turn off all control outputs. The current process value remains with flashing digits in this mode. Alarm conditions are maintained.
<input checked="" type="checkbox"/>	Return to RUN Mode or to displaying “ RUN ” depending on the Operating Safety parameter setting (6.7.2 Operating Mode Confirmation (INIt > SFty > oPER)).

8.7 Clear Latched Alarms (oPER > L.RSt)

<input checked="" type="checkbox"/>	Select the Clear Latched Alarms command (L.RSt) to clear currently latched Alarms. Alternatively, use digital input to activate the L.RSt command if configured in the PRoG menu as explained in 7.3.7 Alarm Latching (PRoG > ALM.1, ALM.2 > LtCH).
<input checked="" type="checkbox"/>	Return to RUN Mode or to displaying “ RUN ” depending on the Operating Safety parameter setting (6.7.2 Operating Mode Confirmation (INIt > SFty > oPER)).

8.8 Display Valley Reading (oPER > VALy)

<input checked="" type="checkbox"/>	Select Display Valley Reading (VALy) to change the process value displayed to the lowest reading since VALy was last cleared.
<input checked="" type="checkbox"/>	Clear the VALy reading buffer. Return to RUN Mode or to displaying “ RUN ” depending on the Operating Safety parameter setting (6.7.2 Operating Mode Confirmation (INIt > SFty > oPER)). <i>Note:</i> Using the other buttons to navigate away from VALy does not clear the VALy reading buffer.

8.9 Display Peak Reading (oPER > PEAK)

☑	Select Display Peak Reading (PEAK) to change the process value displayed to the highest reading since PEAK was last cleared.
☑	Clear the PEAK reading buffer. Return to RUN Mode or to displaying “ RUN ” depending on the Operating Safety parameter setting (6.7.2 Operating Mode Confirmation (INIt > SFty > oPER)). <i>Note:</i> Using the other buttons to navigate away from PEAK does not clear the PEAK reading buffer.

8.10 Standby Mode (oPER > Stby)

☑	Select Standby Mode (Stby) to disable outputs and Alarm conditions. Stby is displayed until navigating elsewhere. Navigate to any desired initialization or programming settings to change them or to adjust the process.
☑	Return to RUN Mode or to displaying “ RUN ” depending on the Operating Safety parameter setting (6.7.2 Operating Mode Confirmation (INIt > SFty > oPER)).

8.11 Standby Mode (oPER > tARE)

☑	Select Standby Mode (tARE) to allow zeroing the current input value. Available only if enabled in the INIt menu. The tARE will adjust the input offset to show zero.
☑	Return to RUN Mode or to displaying “ RUN ” depending on the Operating Safety parameter setting (6.7.2 Operating Mode Confirmation (INIt > SFty > oPER)).

9. Specifications

9.1 Inputs

Input Types	Thermocouple, RTD, Thermistor, Analog Voltage, Analog Current
Current Input	4 to 20 mA, 0 to 24 mA Scalable
Voltage Input	-50 to + 50 mV, -100 to 100 mV, -1 to 1 V, -10 to 10 Vdc Single Ended Scalable +/- 50 and +/- 100 mV differential and ratiometric inputs, scalable
Thermocouple Input (ITS 90)	K, J, T, E, R, S, B, C, N
RTD Input (ITS 90)	100/500/1000 Ω Pt sensor, 2-, 3- or 4-wire; 0.00385 (100 Ω only), 0.00392 (100 Ω only), or 0.003916 (100 Ω only) curves
Configuration	Differential
Polarity	Bipolar
Accuracy	Refer to Table 8
Resolution	0.1°F/°C temperature; 10 μV process
Input Impedances	Process Voltage: 10 MΩ for +/- 100 mV Process Voltage: 1 MΩ for other voltage ranges Process Current: 5 Ω Thermocouple: 10 KΩ max
Temperature Stability	<ul style="list-style-type: none"> • RTD: 0.04°C/°C • TC at 25°C (77°F): 0.05°C/°C (cold junction compensation) • Process: 50 ppm/°C
A/D Conversion	24 bit Sigma Delta
Reading Rate	20 samples per second
Digital Filter	Programmable from 0.05 seconds (filter = 1) to 6.4 seconds (filter = 128)
CMRR	120 dB
Excitation	Firmware selectable (no jumpers to set) to 5, 10, 12, and 24 Vdc @ 25 mA
Setpoint Adjustment	-9999 to +9999 counts
Warm Up to Rated Accuracy	30 min

9.2 Control

Action	Reverse (heat), direct (cool), or heat / cool
Autotune	Operator initiated from front panel
Adaptive Tune	User selectable; fuzzy logic continuous PID tuning optimization
Control Modes	On/off or the following time/amplitude Proportional Control Modes: selectable Manual or Auto PID, Proportional, Proportional with Integral, Proportional with Derivative
Cycle Time	0.1–199 seconds

Ramp and Soak	<ul style="list-style-type: none"> • Up to 99 Saved Ramp and Soak programs • Up to 8 Ramp and 8 Soak segments with individually selectable events per program • Definable End Actions include program linking • Ramp and Soak segment times: 00.00 to 99.59 (for HH:MM and MM:SS)
----------------------	---

9.3 Outputs

Analog	Non-Isolated, Proportional 0–10 Vdc or 0–20 mA; 500 Ω max. Programmable for control or retransmission. Accuracy is 0.1% of full scale.
DC Pulse	Non-Isolated; 10 Vdc at 20 mA
SPST Relay	Single pole, single throw mechanical relay, 250 Vac or 30 Vdc at 3 A (Resistive Load)
SPDT Relay	Single pole, double throw mechanical relay, 250 Vac or 30 Vdc at 3 A (Resistive Load)
SSR	20–265 Vac at 0.05–0.5 A (Resistive Load); continuous
Isolated DC Pulse	Isolated; 10 Vdc at 20 mA
Isolated Analog	Isolated, Proportional 0–10 Vdc or 0–20 mA; 500 Ω max. Programmable for control or retransmission. Accuracy is 0.1% of full scale.

9.4 Communications (USB Standard, Optional Serial and Ethernet)

Connection	USB: Female Micro-USB, Ethernet: Standard RJ45, Serial: Screw terminals
USB	USB 2.0 Host or Device
Ethernet	Standards Compliance IEEE 802.3 10/100 Base-T Auto-switching, TCP/IP, ARP, HTTPGET
Serial	Software Selectable RS/232 or RS/485. Programmable 1200 to 115.2 K baud.
Protocols	Omega ASCII, Modbus ASCII / RTU

9.5 Isolation

Approvals	UL, C-UL, CE, and UKCA (8. Approvals Information)
Power to Input/Output	<ul style="list-style-type: none"> • 2300 Vac per 1 min test • 1500 Vac per 1 min test (Low-Voltage/Power Option)
Power to Relays/SSR Outputs	2300 Vac per 1 min test
Relays/SSR to Relay/SSR Outputs	2300 Vac per 1 min test
RS-232/485 to Inputs/Outputs	500 Vac per 1 min test

9.6 General

Display	<p>4-digit, 9-segment LED; red, green, and amber programmable colors for process variable, Setpoint, and temperature units</p> <ul style="list-style-type: none"> • 10.2 mm (0.40"): 32Pt, 16Pt, 16DPt (Dual Display) • 21 mm (0.83"): 8Pt, 8EPt • 21 mm (0.83") and 10.2 mm (0.40"): 8DPt (Dual Display)
Dimensions	<ul style="list-style-type: none"> • 8Pt Series: 48 H x 96 W x 127 mm D, (1.89 x 3.78 x 5") • 16Pt Series: 48 H x 48 W x 127 mm D, (1.89 x 1.89 x 5") • 32Pt Series: 25.4 H x 48 W x 127 mm D, (1.0 x 1.89 x 5")
Panel Cutout	<ul style="list-style-type: none"> • 8Pt Series: 45 H x 92 mm W (1.772" x 3.622"), 1/8 DIN • 16Pt Series: 45 mm (1.772") square, 1/16 DIN • 32Pt Series: 22.5 H x 45 mm W (0.886" x 1.772"), 1/32 DIN
Environmental Conditions	All Models: 0–50°C (32–122°F), 90% RH non-condensing
External Fuse Required	<p>Time-Delay, UL 248-14 listed:</p> <ul style="list-style-type: none"> • 100 mA/250 V • 400 mA/250 V (Low-Voltage Option) <p>Time-Lag, IEC 127-3 recognized:</p> <ul style="list-style-type: none"> • 100 mA/250 V • 400 mA/250 V (Low-Voltage Option)
Line Voltage/Power	<ul style="list-style-type: none"> • 90–300 Vac +/-10%, 50-400 Hz¹ • 110–375 Vdc, equivalent voltage • 4 W: power for 8Pt, 16Pt, 32Pt Models • 5 W: power for 8DPt, 8EPt, 16DPt Models
Low-Voltage/Power Option	<p>External power source must meet Safety Agency Approvals. Units can be powered safely with 24 Vac power, but no certification for CE/UL is claimed.</p> <ul style="list-style-type: none"> • 12–36 Vdc: 3 W power for 8Pt, 16Pt, 32Pt • 20–36 Vdc: 4 W power for 8DPt, 8EPt, 16DPt
Protection	<ul style="list-style-type: none"> • NEMA-4x/Type 4x/IP65 front bezel: 32Pt, 16Pt, 16DPt • NEMA-1/Type 1 front bezel: 8Pt, 8DPt, 8EPt
Weight	<ul style="list-style-type: none"> • 8Pt Series: 295 g (0.65 lb) • 16Pt Series: 159 g (0.35 lb) • 32Pt Series: 127 g (0.28 lb)

¹ No CE compliance above 60 Hz

Table 8 – Ranges and Accuracies for Supported Inputs

Input Type	Description	Range	Accuracy
Process	Process Voltage	+/- 50 mV, +/-100 mV, +/-1, +/-10 Vdc	0.03% FS
Process	Process Current	Scalable within 0 to 24 mA	0.03% FS
J Type T/C	Iron-Constantan	-210 to 1200°C / -346 to 2192°F	0.4°C / 0.7°F
K Type T/C	CHROMEGA®-ALOMEGA®	-270 to -160°C / -454 to -256°F	1.0°C / 1.8°F
		-160 to -1372°C / -256 to 2502°F	0.4°C / 0.7°F
T Type T/C	Copper-Constantan	-270 to -190°C / -454 to -310°F	1.0°C / 1.8°F
		-190 to 400°C / -310 to 752°F	0.4°C / 0.7°F
E Type T/C	CHROMEGA®-Constantan	-270 to -220°C / -454 to -364°F	1.0°C / 1.8°F
		-220 to 1000°C / -364 to 1832°F	0.4°C / 0.7°F
R Type T/C	Pt/13%Rh-Pt	-50 to 40°C / -58 to 104°F	1.0°C / 1.8°F
		40 to 1788°C / 104 to 3250°F	0.5°C / 0.9°F
S Type T/C	Pt/10%Rh-Pt	-50 to 100°C / -58 to 212°F	1.0°C / 1.8°F
		100 to 1768°C / 212 to 3214°F	0.5°C / 0.9°F
B Type T/C	30%Rh-Pt/6%Rh-Pt	100 to 640°C / 212 to 1184°F	1.0°C / 1.8°F
		640 to 1820°C / 1184 to 3308°F	0.5°C / 0.9°F
C Type T/C	5%Re-W/26%Re-W	0 to 2320°C / 32 to 4208°F	0.4°C / 0.7°F
N Type T/C	Nicrosil-Nisil	-250 to -100°C / -418 to -148°F	1.0°C / 1.8°F
		-100 to 1300°C / -148 to 2372°F	0.4°C / 0.7°F
RTD	Pt, 0.00385, 100 Ω, 500 Ω, 1000 Ω	-200 to 850°C / -328 to 1562°F	0.3°C / 0.5°F
RTD	Pt, 0.003916, 100 Ω	-200 to 660°C / -328 to 1220°F	0.3°C / 0.5°F
RTD	Pt, 0.00392, 100 Ω	-200 to 660°C / -328 to 1220°F	0.3°C / 0.5°F
Thermistor	2252 Ω	-40 to 120C / -40 to 248F	0.2°C / 0.35°F
Thermistor	5K Ω	-30 to 140C / -22 to 284F	0.2°C / 0.35°F
Thermistor	10K Ω	-20 to 150C / -4 to 302F	0.2°C / 0.35°F

Table 9 – Error Code Descriptions

Code	Error Code Descriptions	Code	Error Code Descriptions
E001	File not found during load operation	E010	Communications device not ready (USB, Serial, etc.)
E002	Bad file format during load operation	E011	Communications install error
E003	File read error during load operation	E012	Failed attempt to open a communications device
E004	File write error during save operation	E013	Failed attempt to read from a communications device
E005	Device not found for read or write operation	E014	Failed attempt to write to a communications device
E006	Loop break timeout	E015	Bad reboot, attempt to reboot from an unknown source
E007	Autotune timeout	E016	Can't auto tune because input signal is on wrong side of setpoint
E008	Ramp and Soak program tracking error	E017	Signal too unstable to perform autotune
E009	Input signal out of range	E01D	Autotune measurement error

Table 10 – Fatal Error Code Descriptions

Code	Error Code Descriptions
F01A	Autotune is busy
F01B	Output break error
F01C	Sensor error
F01D	Autotune measurement error
F01E	Invalid control range
F01F	Bad reboot option
F019	Autotune cancelled
F7EC	Unit trying to send data but finds no USB
F714	Communication configuration error

10. Approvals Information



This product conforms to the **EMC: 2014/30/EU** (EMC Directive) and Electromagnetic Compatibility Regulations 2016.

Electrical Safety: 2014/35/EU (Low Voltage Directive) and Electrical Equipment (Safety) Regulations 2016

Safety requirements for electrical equipment for measurement, control, and laboratory

Double Insulation; Pollution Degree 2

Dielectric withstand Test per 1 min

- Power to Input/Output: 2300 Vac (3250 Vdc)
- Power to Input/Output²: 1500 Vac (2120 Vdc)
- Power to Relays/SSR Output: 2300 Vac (3250 Vdc)
- Ethernet to Inputs: 1500 Vac (2120 Vdc)
- Isolated RS232 to Inputs: 500 Vac (720 Vdc)
- Isolated Analog to Inputs: 500 Vac (720 Vdc)
- Analog/Pulse to Inputs: No Isolation

Measurement Category I

Category I includes measurements performed on circuits not directly connected to the Mains Supply (power). Maximum Line-to-Neutral working voltage is 50Vac/dc. This unit should not be used in Measurement Categories II, III, and IV.

Transients Overvoltage Surge (1.2 / 50uS pulse)

- Input Power: 2500 V
- Input Power³: 1500 V
- Ethernet: 1500 V
- Input/Output Signals: 500 V

ADDITIONAL INFORMATION:

FCC: This device complies with Part 15, Subpart B, Class B of the FCC rules, for option **–EIP** only.

RoHS II: The above product has been declared by the original supplier as Compliant. The manufacturer of this item declares that the product complies with the EEE RoHS II Directive 2011/65/EC.26

UL File Number: E209855

² Low-voltage DC power option: Units configured for external low power DC voltage, 12–36Vdc.

³ Ibid.

WARRANTY/DISCLAIMER

OMEGA ENGINEERING, INC. warrants this unit to be free of defects in materials and workmanship for a period of **61 months** from date of purchase. OMEGA's WARRANTY adds an additional one (1) month grace period to the normal **five (5) year product warranty** to cover handling and shipping time. This ensures that OMEGA's customers receive maximum coverage on each product.

If the unit malfunctions, it must be returned to the factory for evaluation. OMEGA's Customer Service Department will issue an Authorized Return (AR) number immediately upon phone or written request. Upon examination by OMEGA, if the unit is found to be defective, it will be repaired or replaced at no charge. OMEGA's WARRANTY does not apply to defects resulting from any action of the purchaser, including but not limited to mishandling, improper interfacing, operation outside of design limits, improper repair, or unauthorized modification. This WARRANTY is VOID if the unit shows evidence of having been tampered with or shows evidence of having been damaged as a result of excessive corrosion; or current, heat, moisture or vibration; improper specification; misapplication; misuse or other operating conditions outside of OMEGA's control. Components in which wear is not warranted, include but are not limited to contact points, fuses, and triacs.

OMEGA is pleased to offer suggestions on the use of its various products. However, OMEGA neither assumes responsibility for any omissions or errors nor assumes liability for any damages that result from the use of its products in accordance with information provided by OMEGA, either verbal or written. OMEGA warrants only that the parts manufactured by the company will be as specified and free of defects. OMEGA MAKES NO OTHER WARRANTIES OR REPRESENTATIONS OF ANY KIND WHATSOEVER, EXPRESSED OR IMPLIED, EXCEPT THAT OF TITLE, AND ALL IMPLIED WARRANTIES INCLUDING ANY WARRANTY OF MERCHANTABILITY AND FITNESS FOR A PARTICULAR PURPOSE ARE HEREBY DISCLAIMED. LIMITATION OF LIABILITY: The remedies of purchaser set forth herein are exclusive, and the total liability of OMEGA with respect to this order, whether based on contract, warranty, negligence, indemnification, strict liability or otherwise, shall not exceed the purchase price of the component upon which liability is based. In no event shall OMEGA be liable for consequential, incidental or special damages.

CONDITIONS: Equipment sold by OMEGA is not intended to be used, nor shall it be used: (1) as a "Basic Component" under 10 CFR 21 (NRC), used in or with any nuclear installation or activity; or (2) in medical applications or used on humans. Should any Product(s) be used in or with any nuclear installation or activity, medical application, used on humans, or misused in any way, OMEGA assumes no responsibility as set forth in our basic WARRANTY/DISCLAIMER language, and, additionally, purchaser will indemnify OMEGA and hold OMEGA harmless from any liability or damage whatsoever arising out of the use of the Product(s) in such a manner.

RETURN REQUESTS/INQUIRIES

Direct all warranty and repair requests/inquiries to the OMEGA Customer Service Department. BEFORE RETURNING ANY PRODUCT(S) TO OMEGA, PURCHASER MUST OBTAIN AN AUTHORIZED RETURN (AR) NUMBER FROM OMEGA'S CUSTOMER SERVICE DEPARTMENT (IN ORDER TO AVOID PROCESSING DELAYS). The assigned AR number should then be marked on the outside of the return package and on any correspondence.

The purchaser is responsible for shipping charges, freight, insurance and proper packaging to prevent breakage in transit.

FOR **WARRANTY** RETURNS, please have the following information available BEFORE contacting OMEGA:

1. Purchase Order number under which the product was PURCHASED,
2. Model and serial number of the product under warranty, and
3. Repair instructions and/or specific problems relative to the product.

FOR **NON-WARRANTY** REPAIRS, consult OMEGA for current repair charges. Have the following information available BEFORE contacting OMEGA:

1. Purchase Order number to cover the COST of the repair,
2. Model and serial number of the product, and
3. Repair instructions and/or specific problems relative to the product.

OMEGA's policy is to make running changes, not model changes, whenever an improvement is possible. This affords our customers the latest in technology and engineering.

OMEGA is a registered trademark of OMEGA ENGINEERING, INC.

© Copyright 2017 OMEGA ENGINEERING, INC. All rights reserved. This document may not be copied, photocopied, reproduced, translated, or reduced to any electronic medium or machine-readable form, in whole or in part, without the prior written consent of OMEGA ENGINEERING, INC.

Where Do I Find Everything I Need for Process Measurement and Control? **OMEGA...Of Course!** *Shop online at omega.comSM*

TEMPERATURE

- ☑ Thermocouple, RTD & Thermistor Probes, Connectors, Panels & Assemblies
- ☑ Wire: Thermocouple, RTD & Thermistor
- ☑ Calibrators & Ice Point References
- ☑ Recorders, Controllers & Process Monitors
- ☑ Infrared Pyrometers

PRESSURE, STRAIN AND FORCE

- ☑ Transducers & Strain Gages
- ☑ Load Cells & Pressure Gages
- ☑ Displacement Transducers
- ☑ Instrumentation & Accessories

FLOW/LEVEL

- ☑ Rotameters, Gas Mass Flowmeters & Flow Computers
- ☑ Air Velocity Indicators
- ☑ Turbine/Paddlewheel Systems
- ☑ Totalizers & Batch Controllers

pH/CONDUCTIVITY

- ☑ pH Electrodes, Testers & Accessories
- ☑ Benchtop/Laboratory Meters
- ☑ Controllers, Calibrators, Simulators & Pumps
- ☑ Industrial pH & Conductivity Equipment

DATA ACQUISITION

- ☑ Communications-Based Acquisition Systems
- ☑ Data Logging Systems
- ☑ Wireless Sensors, Transmitters, & Receivers
- ☑ Signal Conditioners
- ☑ Data Acquisition Software

HEATERS

- ☑ Heating Cable
- ☑ Cartridge & Strip Heaters
- ☑ Immersion & Band Heaters
- ☑ Flexible Heaters
- ☑ Laboratory Heaters

ENVIRONMENTAL MONITORING AND CONTROL

- ☑ Metering & Control Instrumentation
- ☑ Refractometers
- ☑ Pumps & Tubing
- ☑ Air, Soil & Water Monitors
- ☑ Industrial Water & Wastewater Treatment
- ☑ pH, Conductivity & Dissolved Oxygen Instruments