



ATTENTION: Please Read this cover letter BEFORE installing the Classic or Classic Lite

For help with the Classic, Classic Lite or Classic-SL please see our how to videos and extended documentation. Please visit this website: www.midnitesolar.com/classic Before calling tech support, we recommend visiting this website for some of the most common issues.

Warning: Arc Fault protection is not turned on by default. (Note neither the Classic Lite or Classic-SL have ArcFault built in)

The National Electrical Code article 690.11 requires Arc Fault Protection. The Classic has this built in as standard equipment. This will need to be enabled if so desired.

Please Note: The Arc Fault Protection has adjustable sensitivity and may require some tuning for your particular system to avoid nuisance tripping. Some house loads like Table saws and well pumps and other motor loads can actually be seen on the PV circuit in the Classic appearing similar to DC arcs. We have started with a general average we have found to work reliably but in some cases this sensitivity level is too high causing false Arc Fault Alarms. When the Classic goes into Arc Fault, it goes to Resting and will not charge the batteries. Please consult the manual that came with your Classic for enabling and or fine tuning of the Arc Fault system.

DANGER OF DEATH TO YOUR CLASSIC

Warning with Tigo modules Solar Mode must not be used or the Classic will not survive. MidNite does not recommend the use of Tigo Module Optimizers with the Classic. If Tigo modules must be installed Legacy P&O MUST be used.

When the Classic is used with Wind or Hydro a Clipper type device will most likely be needed to protect against over voltage. A battery based diversion load WILL NOT keep the Classic safe from over voltage. High input voltage is recorded and over voltage is not covered under warranty.

Never hook a Pump or other load to the Input side of the Classic. If a Load must be hooked to the input side of the classic the load and Classic need to have blocking diodes on them.

Never Parallel 2 Classics onto one PV array. If 2 Classic's have to be paralleled for wind or hydro (NOT SOLAR) there must be blocking diodes on each Classic.

For Larger systems with Large inverters and or multiple inverters (like the Radian or XW+ for example) it is important to use appropriate sized cables and bus bars or damage to the inverters or charge controllers can occur. Take a single XW+ E-Panel for example it has a positive bus bar for Charge controller battery side connections. This bus bar is sufficient for 2 charge controllers so if you needed 3 or more then you need to look at the best way to handle the amperage. Or a Dual Radian for example is actually 4 separate inverters. Proper size cables become very important as well as large enough battery banks. Most manufacturers of Battery based inverters recommend 100AH of battery per KW of solar modules. (Please consult the inverter manufacture for assistance with cable sizing etc)



Standard Classic

Classic Lite

This Manual covers models Classic 150, 200 & 250 as well as the Classic 150, 200 & 250 LITE

Este manual también está disponible en Español. La versión en Español puede encontrarse en nuestra pagina web en la ficha Documentos y haga clic en Manuales.

The MidNite Solar Classic charge controller conforms to *UL 1741, Safety for Inverters, Converters, Controllers and Interconnection System Equipment for Use With Distributed Energy Resources, Second Edition, May 7, 1999 with revisions through January 28, 2010 and CAN/CSA C22.2 No. 107.1: 2001/09/01 Ed: 3 (R2006)*

Notice of Copyright

MidNite Solar's Classic charge controller User's Manual

Copyright © 2010 all rights reserved.

MidNite Solar Inc. reserves the right to revise this document and to periodically make changes to the content hereof without obligation or organization of such revisions or changes unless required to do so by prior arrangement.

Disclaimer

Unless specifically agreed to in writing, MidNite Solar Inc.

(a) Makes no warranty as to the accuracy, sufficiency or suitability of any technical or other information provided in its manuals or other documentation.

(b) Assumes no responsibility or liability for loss or damage whether direct, indirect, consequential or incidental, which might arise out of use of such information. The use of any such information will be entirely at the user's risk.

Contact Information

Telephone: 360.403.7207

Fax: 360.691.6862

Email: customerservice@midnitesolar.com

Web: www.midnitesolar.com

Contents

Scope	7
Introduction	8
How to KILL Your Batteries	10
Classic Power Curves	11
Unpacking the Classic	12
Removing and installing the front cover on the Classic	13
Mounting the Classic	14
Alternative Mounting.....	16
Dimensions.....	16
Sealed or Vented	17
Battery Temperature Compensation	17
“Follow-ME” Charging coordination	17
Battery Temperature Sensor Installation	20
Chassis Grounding	22
DC System Grounding	22
DC GFP (Ground Fault Protection)	23
Disabling GFP.....	24
Wiring the Classic	24
DC Terminal Connector.....	27
Over Current Protection and Wire Size Requirements	27
Current Rating.....	27
Over Current Protection	28
Long Distance Wire Runs	28
Connecting the Classic to the Clipper.....	28
Maximum and Minimum Wire Size	30
Equalization Manual and Auto	30
Equalization with the Classic Lite.....	30
Equalization with the standard Classic	31
Manual EQ.....	31
Auto EQ	31
Standard Classic programming	32
Commissioning the Classic (Quick Start).....	32
Battery Charge Stages and Meanings	32
Resting	32

Mode is OFF	33
Adjusting Absorb, Equalize and Float Voltages	33
Current Limit.....	33
LED Modes and the “Blinking Red LED”	34
Calibrating Battery and PV Voltage	34
Configuring DC Input Source	35
Configuring the Classic for Wind Input Source.....	36
Setting the Date and Time.....	37
Configuring Auxiliary Input/Output	37
Aux 1 Function.....	42
Aux 2 Function. Output/Input	43
Aux 1 and Aux 2 Graphs/Jumpers	43
Aux 1 Voltage-Time Relation (Relay/12v).....	44
Aux 2 Voltage-Time Relation (PWM).....	45
Setting the MNGP features	46
Navigating the Menu.....	46
Viewing Other MidNite Products on the Display	47
Connecting the Classic to Two MNGPs/Network cable.....	47
Arc Fault	48
View Faults and Warnings	49
View Logged Data	49
Graphical Logging Display modes.....	52
Classic Lite Programming	54
LED explanations.....	54
Programming.....	55
Dip Switches	55
Section 1 Switch settings explained	57
Section 2 Switch settings explained	58
Battery voltage and time settings	61
Using MNGP Remote to Program a Classic Lite.....	62
Programming the Lite with a Networked Standard Classic	62
Programming the Lite with the Local App.....	62
Clearing Faults	62
Notes on the Lite	62
Explanations of Solar and Legacy.....	63

Uploading New Firmware to the Classic	63
Connecting the Classic to the Internet	66
Networking.....	66
Network Setup through the MNGP.....	68
Web Access.....	69
Local Network.....	70
Positive Ground systems	70
Troubleshooting	72
Electrical Specifications	80
Specifications Mechanical	81
Default Battery charge set points	82
Optional accessories	82
Regulatory Approval	82
Warranty	83
Appendix	83
Classic Breaker sizing.....	84
Label Set from Classic	89
RS232 Jack Pin Out	90

Scope

This Manual provides safety guidelines and installation information for the Classic charge controller. It does not provide brand specific information about photovoltaic panels, batteries etc. Contact the manufacturer of other components in the system for relevant technical data.

Introduction

The MidNite Classic charge controller is unique in its ability to be used for a great variety of DC input sources. The Classic is designed to regulate DC input from PV, and Approved Hydro and Wind turbines for other DC sources please contact MidNite Solar tech support. The Classic 150, 200 and 250 are designed to work with 12, 24, 36, 48, 60 and 72 volt battery banks.

The Classic can be installed stand alone or as a multi-unit networked installation.

Standard features of the Classic charge controller include:

- *3 input operating voltage ranges 150, 200 and 250 VDC
- *Multiple DC input options (example Solar, Wind or Hydro)
- *Graphical display
- *Previous 380 days of operational data logged
- *Internet ready

This Manual covers *Classic 150, Classic 200 and the Classic 250*. It covers the installation, wiring and use of the Classic charge controller.



WARNING Warnings signs identify conditions or practices that could result in personal injury or loss of life.



CAUTION Cautions identify conditions or practices that could result in damage to the unit or other equipment.

MIDNITE SOLAR CHARGE CONTROLLER INSTALLATION GUIDELINES AND SAFETY INSTRUCTIONS

This product is intended to be installed as part of a permanently grounded electrical system as shown in the system configuration sections. The following important restrictions apply *unless superseded by local or national codes*:

- To use the Classic's built in DC GFP the System's DC Negative conductor must not be bonded to earth ground. The Classic does this with its internal Ground Fault Protection circuitry. The battery negative and ground are not bonded together directly but are connected together by the Classic's internal GFP device. All negative conductor connections must be kept separate from the grounding conductor connections. The equipment ground terminal inside the Classic must be connected to Earth Ground for the internal DC-GFP to work.

- With the exception of certain telecom applications, the Charge Controller should *never* be positive grounded.



- The Charge Controller equipment ground is marked with this symbol:
- If damaged or malfunctioning, the Charge Controller should only be disassembled and repaired by a qualified service center. Please contact your renewable energy dealer/installer for assistance. Incorrect reassembly risks malfunction, electric shock or fire.
- The Charge Controller is designed for indoor installation or installation inside a weatherproof enclosure. It must not be exposed to rain and should be installed out of direct sunlight.

For routine, user-approved maintenance:

- Turn off all circuit breakers, including those to the solar modules, batteries and related electrical connections before performing any maintenance.

Standards and Requirements

All installations must comply with national and local electrical codes; professional installation is recommended. The NEC in the USA requires a DC ground fault interrupter for all residential PV installations. NEC requires an ARC FAULT detector on all charge controllers and inverters operating above 80VDC. Both of these devices are built into the Classic.

DC and Battery-Related Installation Requirements:

- ❖ All DC cables must meet local and national codes.
- ❖ Shut off all DC breakers before connecting any wiring.
- ❖ Torque all the Charge Controller's wire lugs and ground terminals to the specs found on page 21.
- ❖ Copper wiring must be rated at 75° C or higher.
- ❖ Keep cables close together (e.g., using a tie-wrap) as much as possible to reduce inductance.
- ❖ Ensure both cables pass through the same knockout and conduit to allow the inductive currents to cancel.
- ❖ DC battery over-current protection must be used as part of the installation on the input and output.
- ❖ Breakers between the battery and the Classic must meet UL489 standards.
- ❖ Breakers between the DC source and the Classic must meet UL1077 or UL489 standards.

Design the battery enclosure to prevent accumulation of hydrogen gas at the top of the enclosure. Vent the battery compartment from the highest point to the outside. A sloped lid can also be used to direct the flow of hydrogen to the vent opening. Sealed (AGM, Gel etc) batteries do not normally require ventilation. Consult your battery manufacturer for details.



WARNING: PERSONAL PRECAUTIONS DURING INSTALLATION **WARNING BATTERIES PRESENT RISK OF** **ELECTRICAL SHOCK, BURN FROM HIGH SHORT CIRCUIT CURRENT, FIRE OR** **EXPLOSION FROM VENTED GASES. FOLLOW PROPER PRECAUTIONS.**

- ❖ Someone should be within range of your voice to come to your aid if needed.
- ❖ Keep plenty of fresh water and soap nearby in case battery acid contacts skin, clothing, or eyes.
- ❖ Wear complete eye protection. Avoid touching eyes while working near batteries. Wash your hands with soap and warm water when done.
- ❖ If battery acid contacts skin or clothing, wash immediately with soap and water. If acid enters an eye, flood the eye with running cool water at once for at least 15 minutes and get medical attention immediately following.
- ❖ Baking soda neutralizes lead acid battery electrolyte. Keep a supply on hand in the area of the batteries.
- ❖ NEVER smoke or allow a spark or flame in vicinity of a battery or generator.
- ❖ Be cautious to reduce the risk of dropping a metal tool onto batteries. It could short the batteries or other electrical parts that can result in fire or explosion.

- ❖ Never wear metal items such as rings, bracelets, necklaces, and watches when working with a battery or other electrical circuits. A battery can produce a short circuit current high enough to weld a ring or the like to metal, causing severe burns.

How to KILL Your Batteries

Batteries are actually very delicate and require proper attention especially when off grid. Think of your batteries and solar equipment as a small Nuclear Power plant, Hydro damn or Natural gas fired power plant. Just like any of those your system needs DAILY attention to make sure it is doing what it should. Below is a short list of some of the most common ways we have seen people kill there battery bank. For Lithium battery banks we highly recommend using the Logic input on the Classic to let the BMS tell it to stop charging if it detects an issue brewing.

We also recommend the use of an independent battery monitor/alarm if you have very expensive battery banks.

- *Not watching the Charge voltages and verify you are charging to the voltage supplied by the battery manufacturer
- *Not verifying the temperature compensation neutral point (typically 25 degrees C) and the milli volts per degree C per cell (typically -5mv)
- *Not watching to verify the Absorb and or EQ time is set properly and that the equipment actually charges for that period of time (Some equipment will have settings like “End Amps” that can terminate Absorb early and if set up wrong can damage a battery)
- *Not having enough charge current (Solar Panels) to properly charge the size of the battery you have. (Consult the battery manufacturer for the minimum charge current)
- *Using tap water or other liquids instead of distilled water in a flooded battery (The Minerals in the tap water will destroy a battery)
- *Failing to keep all connections clean
- *Not using ALL EQUAL LENGTH interconnect cables on each string (It is important that ALL strings be wired EXACTY the same way. Any variance in resistance on one string vs another will cause in-balance and the batteries will be dead in less than 6 months)
- *Using more than 2-3 parallel strings and not using something like common bus bars (When you use more than 2 strings it is very hard to properly charge the middle strings. The only safe way to do this is wire each string with equal length cables to a common bus bar)
- *Not making sure your lead acid batteries get a full charge at least once a week
- *Routinely using more than 50% of the capacity of the lead acid battery (Using more than half the battery capacity drastically shortens the batteries life, once in a while is fine but on a daily basis will kill them in months)
- *Not leaving ample space between cells for cooling (We recommend at least 1 inch between the cells for cooling, Please ask the manufacturer what they recommend)
- *Trusting a State Of Charge meter, They can all get off over time and give you false readings, You need to verify specific gravity and or verify the charge voltage is being met. Never fully rely on the SOC % it is just a good quick reference

Classic Power Curves

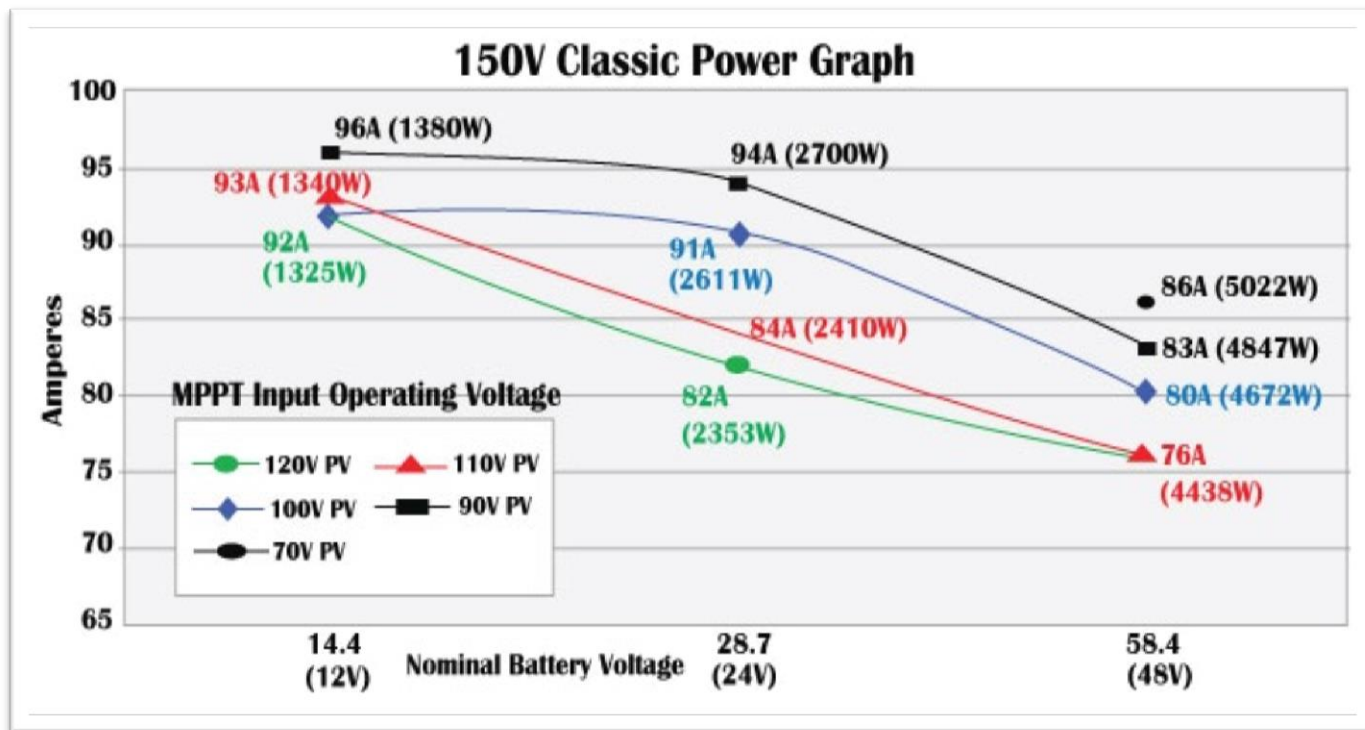

Table 1

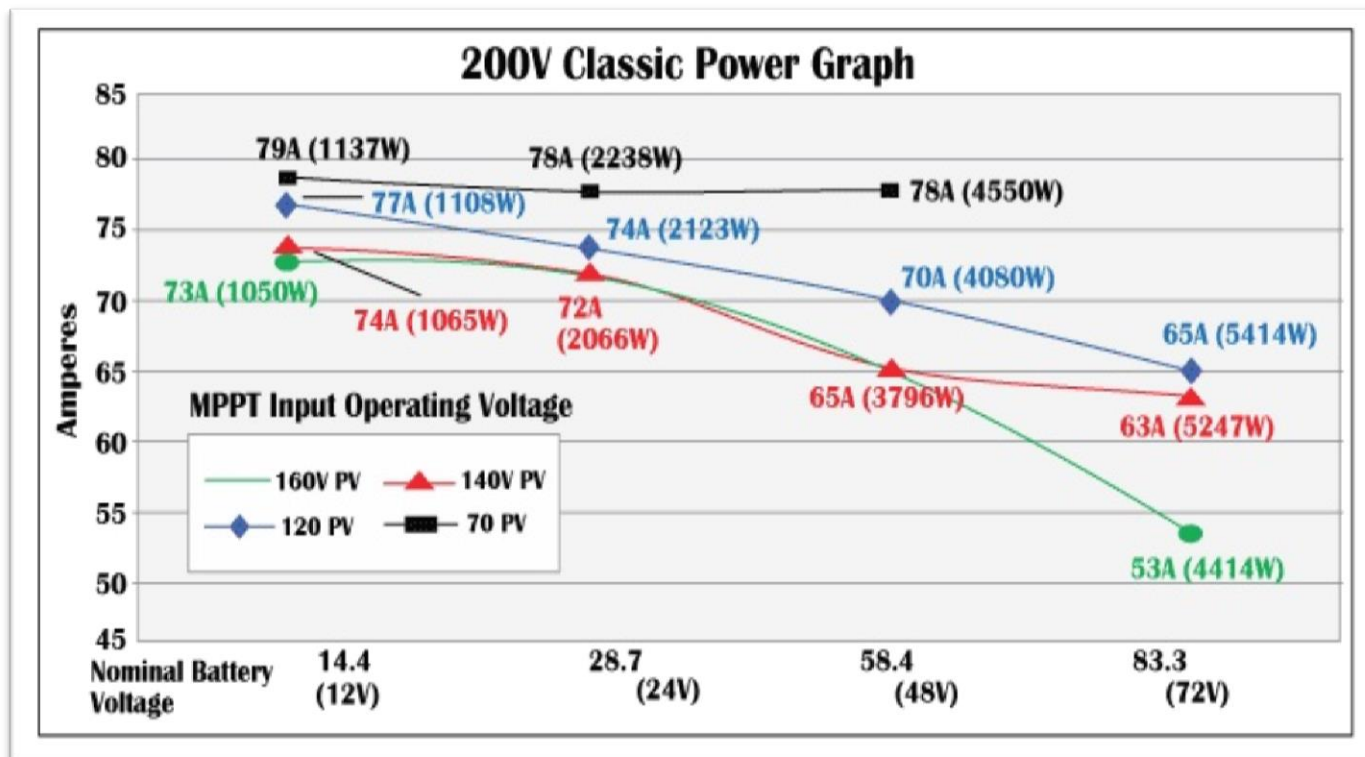

Table 2



Table 3

The graphs above represent the max power output for a given input for each Classic. Using and understanding these power graphs will help maximize Classic's output power and aid in selecting wire and breaker/disconnects. Notice that lower battery voltages and lower PV input voltages result in higher continuous output power. The PV voltages listed are for reference and are not intended to be the only PV voltages supported. The battery voltages listed show the most used battery bank configurations. Other voltages are also supported. The Classic battery voltage parameters are fully user adjustable.

For example: if you are using a Classic 250 and 48v battery bank, the maximum continuous output power based on 25 degree C ambient is 55 amps when using a PV array that yields a Maximum Power Voltage of 180 volts. The same set up using a bit higher voltage modules that result in a 200V Maximum Power voltage will result in only 53 amps. Although 55 to 53 amps is not a significant change, it does give you the idea that all things being equal, lower voltages are a bit more efficient, keeping in mind that an MPPT controller needs to have the open circuit voltage of the array about 30% higher than the highest battery voltage you plan to charge to.

NOTE: You can find the Classic string sizing tool on the web page www.midnitesolar.com

Unpacking the Classic

When you receive your Classic you will want to unpack it and make sure everything is there and in good shape. Refer to Figure 1 Included in the Classic package should be:

- *Classic charge controller
- *Battery temperature sensor
- *Knock out covers 3 screened
- *Parts bag with stickers, Terminal block cover and silicone grease
- *User's manual printed

- **Snap on upper vent cover
- **Knock out covers 4 solid

**Note. These items are optional and do not ship as standard equipment. Email customerservice@midnitesolar.com for more information or if anything is missing or damaged.



Figure 1

Removing and installing the front cover on the Classic

Removing the front art deco cover is required to gain access to the wiring compartment.

Be aware if this is not the first removal of this cover there is a cable connecting the cover to the electronics. Do not pull hard or fast as damage could occur.

To remove the front cover of the Classic in preparation for installation, remove the 4 Phillips head screws with a #2 Phillips screwdriver. Lift the front half of the Classic casting off. You will need to unplug the display cable. It works the same as any phone cable.

When installing the cover for the final time, squeeze a small amount of Silicone grease (Included in the parts bag) onto the metal pins of the male jacks on the Display cable before plugging them in.

To re-install the front cover of the Classic you will need to plug in the display cable and carefully route it around the components on the circuit board as you set the cover in place. See Figure 2 Do not force the cover if it does not seat into place easily stop and look for any cables or wires that may be interfering. With the cover seated in place install the four Phillips screws with a #2 Phillips screwdriver.

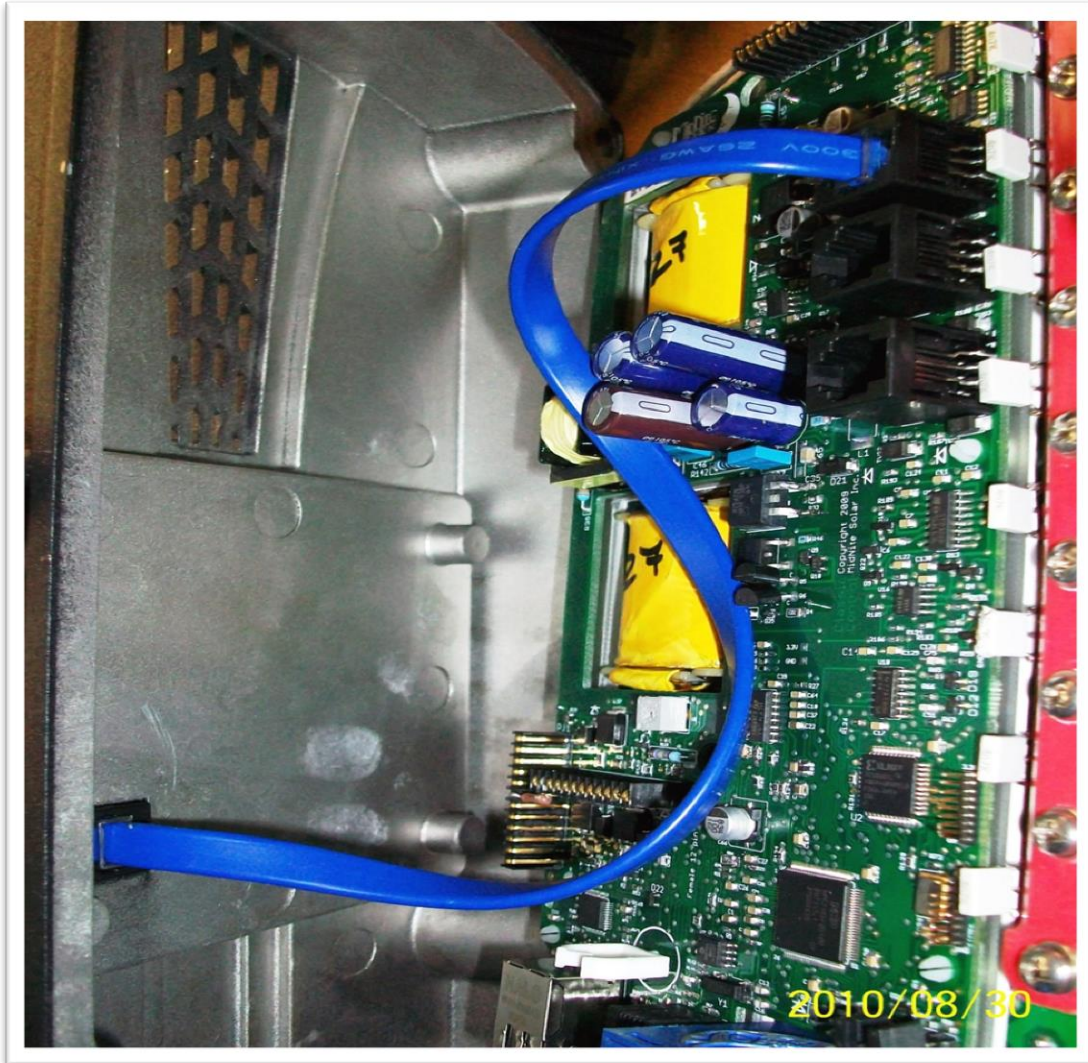

Figure 2

Mounting the Classic

The following section covers typical mounting arrangements. If you require additional details that are not covered here please contact our technical support team. The Classic is designed to be directly mounted onto the MidNite Solar E-Panel. The Classic can also accommodate other installation methods as well. Mount in an upright position out of direct sunlight when possible. For your convenience the Classic has four one inch knock outs that are pre cast. The Classic has mounting locations and conduit locations that are similar to other brands of charge controllers to facilitate ease of upgrading older technologies.

Mounting the Classic directly to the E Panel:

- *Remove the front cover of the Classic.
- *Install the mounting bracket on the E Panel and start the upper mounting screw into the bracket, leaving it about half way out so you can hang the Classic on this screw.
- *Install the 1 inch close nipple into the E Panel as shown in the E-Panel directions. The 1" close nipple, 3 locknuts and 2 plastic bushings are included with each E-Panel. One locknut acts as a spacer.
- *Carefully hang the Classic on the screw in the bracket and slide it over the close nipple (see figure 4).
- *Install the lock nut and bushing on the close nipple and tighten the screw in the mounting bracket.
- *Don't install the front cover until you complete the wiring of the Classic.

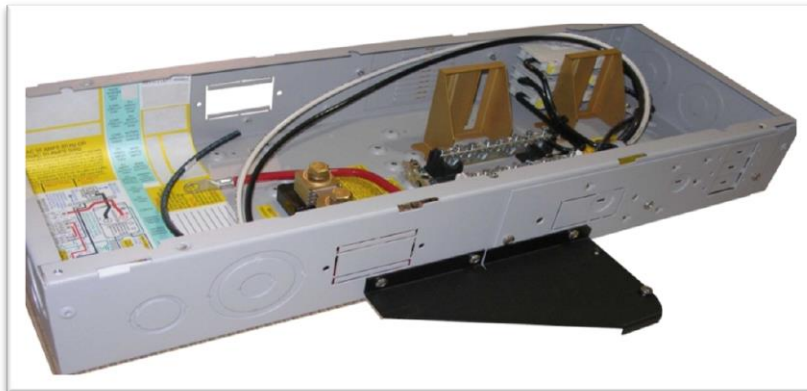

Figure 3 A Charge controller bracket mounted to the E-Panel. The bracket comes with every E-Panel

Figure 3

Classic Mounted to side of E-Panel



Figure 4

Nipple, locknuts and bushings that come with every E-Panel



Figure 5

Classic mounted to the side of a MidNite Solar E-Panel

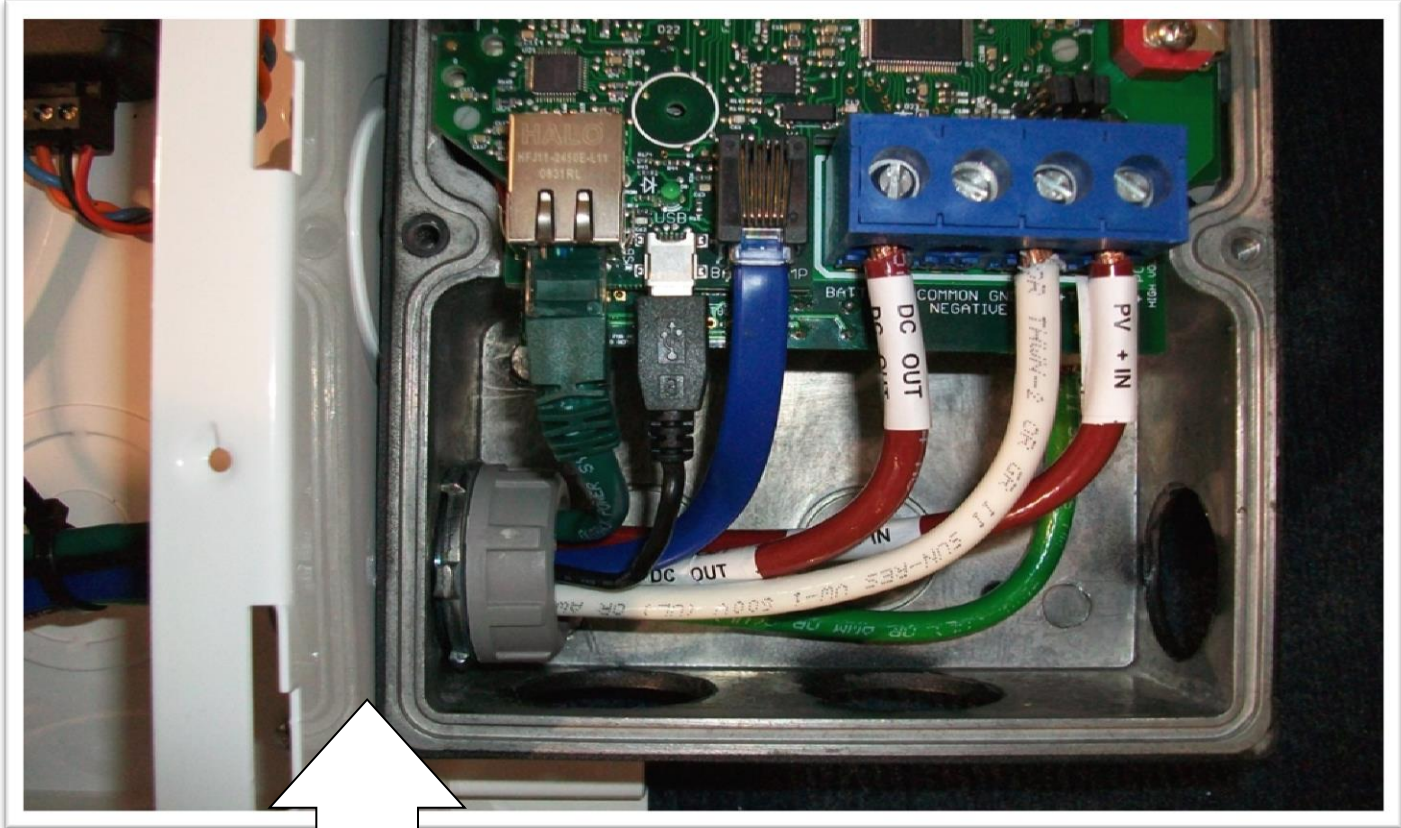
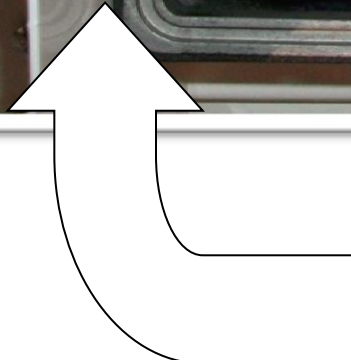

Figure 6



Install locknut here to act as a spacer.

Alternative Mounting

To mount the Classic to a plywood surface, use 1 1/2" wood screws in the top key hole slot hole and the holes in the wiring compartment. Taking care to make sure the Classic is Plumb and Level.

Dimensions

See page 81 for more details.

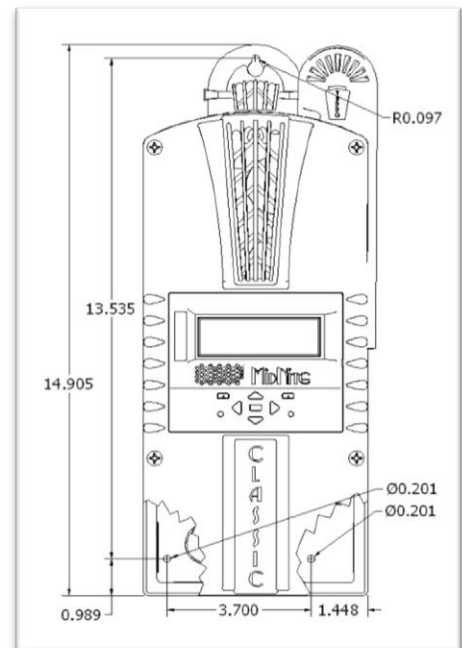

Figure 7

Sealed or Vented

The Classic has the ability to be sealed for protection from salt air or dust. It comes from the factory Vented. If you live in a dusty or salt air environment you may wish to seal the Classic. Sealing the Classic does not make the unit water resistant. To seal the Classic install the solid plastic knock out covers into any unused knock outs and snap the upper vent cover onto the Classic as seen in the photo below. Note that the Classic will be slightly de-rated (will put out less power) by sealing it. Refer to the specifications page of this manual for the ratings in the sealed mode. To obtain the parts necessary to seal the Classic please contact our Technical Support Team. Refer to Figure 8 and 9



Figure 8



Figure 9

Battery Temperature Compensation

The Classic comes with a battery temperature sensor (BTS). This sensor raises or lowers charge voltage based on temperature. Connect BTS to the BATT TEMP jack. ([Refer to Battery Temperature Sensor Installation 20](#)) The Battery temperature menu appears as **T-Comp** in the BATTERY MENU. In this menu you can change the voltage compensation as needed. If the BTS is disconnected or shorted the Classic will automatically default to 25C on the Battery temperature. Also the Classic has the ability to change the neutral temperature (typically 25C) this setting can be found in the WBjr set up.

“Follow-ME” Charging coordination

Follow-Me will allow Classics to share charge stages, as well as Battery temperature info and Ground fault coordination. Follow-Me also allows you to program a single Classic for Equalize charging and it will instruct all the others to Equalize as well. You do need to set the Equalize parameters in each Classic. For the Battery Temp sensor you will need one BTS only and it can be on any of the Classics.

WARNING: ALL FIRMWARE SHOULD MATCH ACROSS ALL CLASSICS

WARNING: REVERSED FOLLOW ME CABLES CAN DAMAGE THE CLASSIC IF LEDT IN PLACE FOR EXTENDED PERIODS OF TIME AND WILL NOT BE CONSIDERED UNDER WARRANTY. PLEASE VERIFY THE PROPER OPERATION OF FOLLOW ME ON THE INITIAL SET UP.

The Follow Me function basically is just what it is called. The Classic will simply ask the Classic to its right “What do I do now” and this propagates around the loop continually. Whoever goes to Float first for instance will simply tell everyone else it is time to go to float.

NOTE: Follow Me coordinates charge stage but the Classics will still vary in the amount of power processed, Follow Me was not intended to make them all produce the same amount of current just coordinate the stages

To enable Follow Me you need to wire the Classics network cables as shown below. You also need to enable Follow-ME. To do this, go to the Tweaks Menu. Press the “Main Menu” button repeatedly until “Charge” is highlighted. Scroll to the Right until “Tweaks” is highlighted and press “Enter”. Now press the right soft key (Upper right button) 4 times until you see the screen with “Follow-ME” and “BTSNET” on it. Here you need to highlight Follow-ME and turn it on using the up arrow. You will also need to highlight BTSNET and turn it on if you want to share battery temperature data. After enabling these press Enter to save this data.

Ground Fault sharing

To share Ground fault you need to remove all of the GFP Jumpers except one classic only. You then need to make sure Ground Fault is Enabled in the Tweaks menu for any of the networked Classics you want to shut down on detection of ground fault. For example say you have three solar Classics and one Wind Classic and you do not want the wind Classic to shut down for GFP. Make sure in the tweaks menu of that Classic GFP is Disabled.

Naming the Classic

The Local Application software (Available as a free download at www.midnitesolar.com) allows you to issue a name to the Classic with upper and lower case letters, as well as numbers. This name can be up to 8 characters. This name will show up on the Display of the Classic instead of the word CLASSIC. It will be shown in all upper case on the Classic's display. The Naming process can be helpful for networked Classics that use one MNGP (Display) to view multiple Classics.

Addressing the Classics

You can assign unique addresses to each networked Classic. This is not necessary for Follow Me to work but it is necessary if you want to view multiple Classics from a single MNGP. To address a Classic simply use the MNGP that is plugged into that Classic, or plug the MNGP into that classic and hold the Left arrow button down and tap the up or down button. The normal default address is 10 so going up will take you to 11 and down to 9. When you get to the unused address you want for that Classic hold the left and right arrows for a second until “Data Sent and Saved” shows up. Now this Classic has been re addressed to the new address. Do this for all the Classics or Classic Lites on the network.

To view other Classics on the network use the same button strokes. Hold the left arrow down and tap the up or down arrow depending on which number you are looking for. We suggest going from 10 up for clarity. So if you had four Classics they would be 10,11,12 and 13. You would scroll up from the normal position to find the other three.

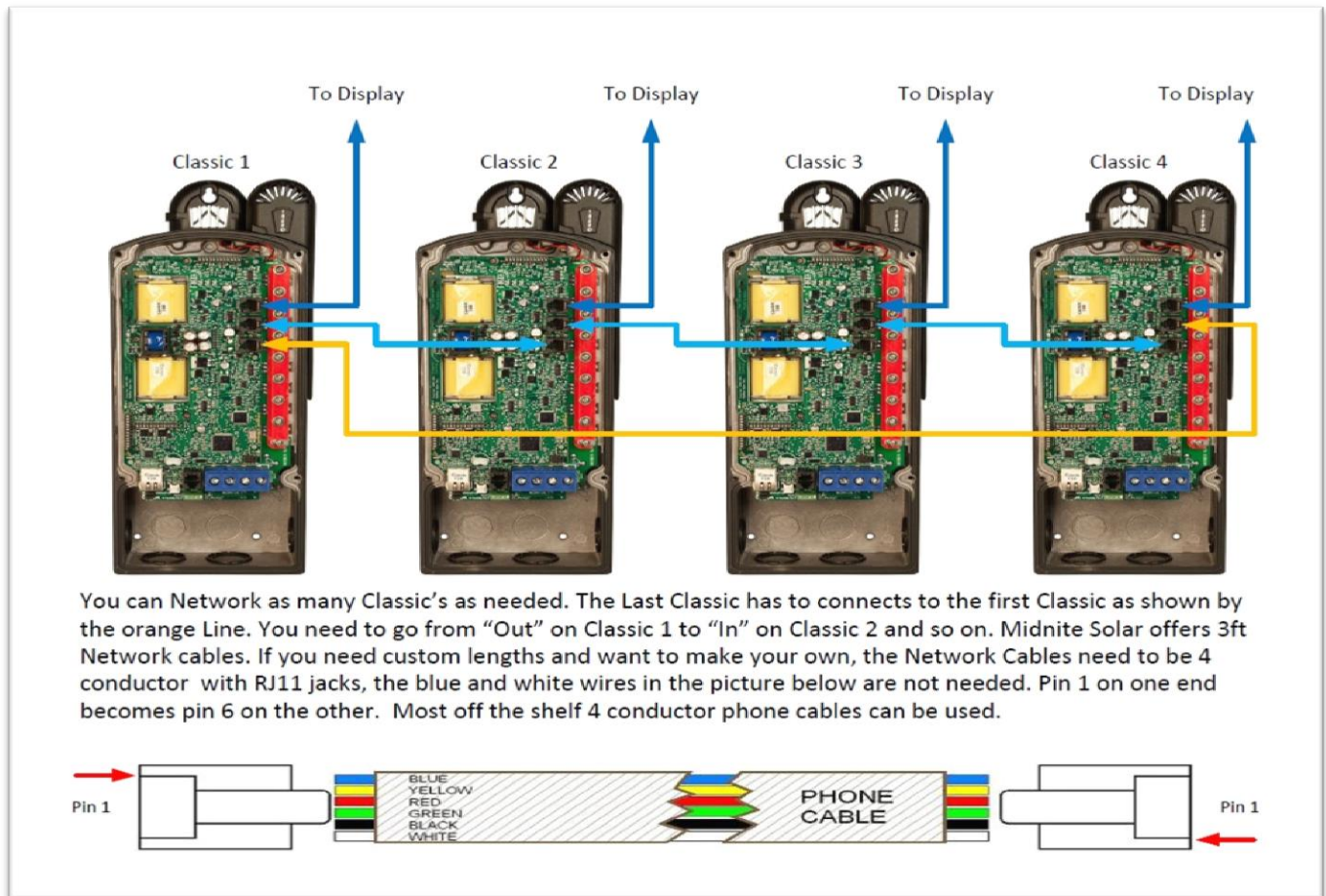

Figure 10 Follow-Me diagram

When installing the Follow Me cables for the last time it is recommended you add a bit of the included silicone grease on the metal contacts of the male ends of all the cables.

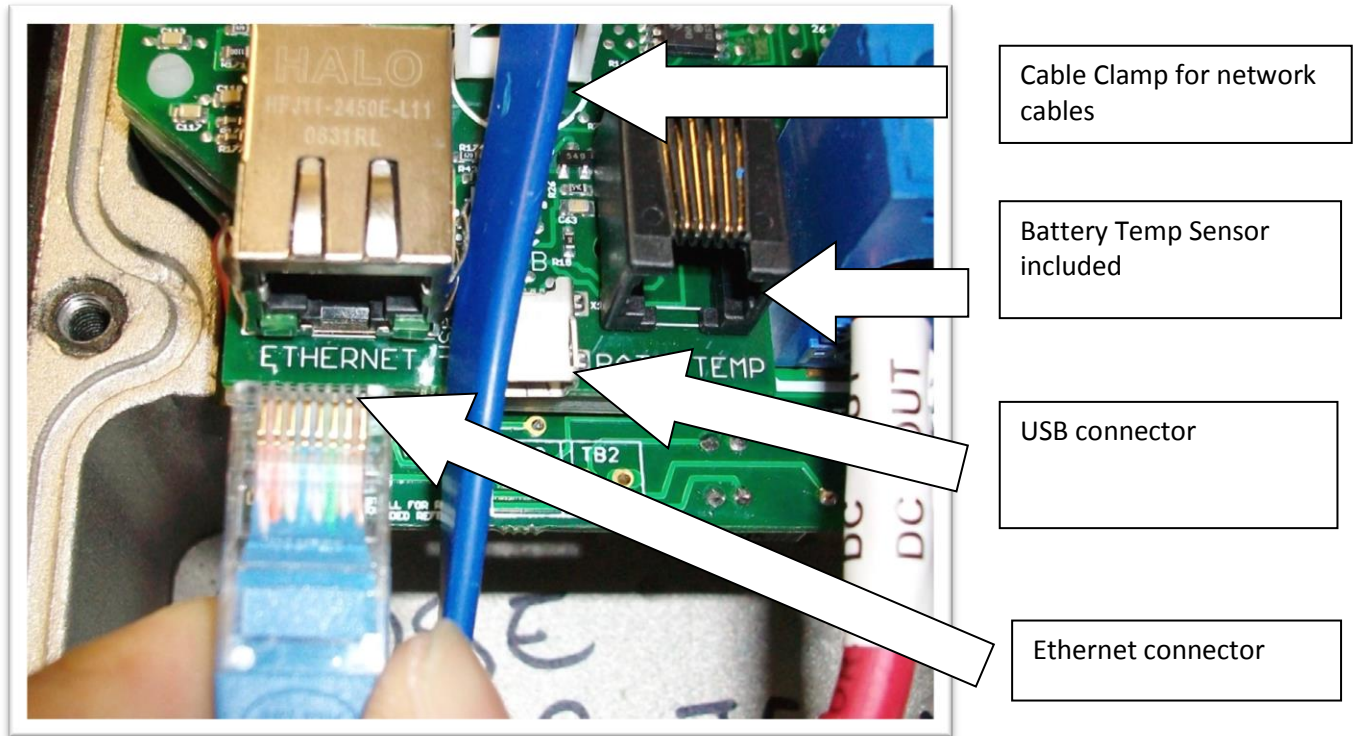

Figure 11

Battery Temperature Sensor Installation



CAUTION - To reduce risk of injury, charge only deep-cycle lead acid, lead antimony, lead calcium, gel cell or absorbed glass mat type rechargeable batteries. Other types of batteries may burst, causing personal injury and damage. Never charge a frozen battery.



WARNING: RISK OF INJURY. To reduce the risk of injury, charge only properly rated (such as 6 V 12 V and 24 V) lead-acid (GEL, AGM, Flooded, or Nickel Cadmium) rechargeable batteries. Other battery types may burst, causing personal injury and damage.



WARNING: Explosion hazard during equalization, the battery generates explosive gases. Follow all the battery safety precautions listed in this guide. Ventilate the area around the battery using ventilators with brushless motors thoroughly and ensure that there are no sources of flame or sparks in the vicinity.

The Classic comes with a Battery temperature sensor which plugs into the jack beside the DC Terminal connector labeled “Batt Temp”. Route the cable through the E-panel into the battery box. Pick a battery in the middle of the bank and about half way up the side of the battery thoroughly clean a spot off on the case. Then remove the protective tape from the sensor and adhere the temperature sensor to the battery. Some manufacturers use a double wall case on the battery. For mounting a temp sensor to a double wall battery case please refer to the battery manufacturer's recommended procedure.

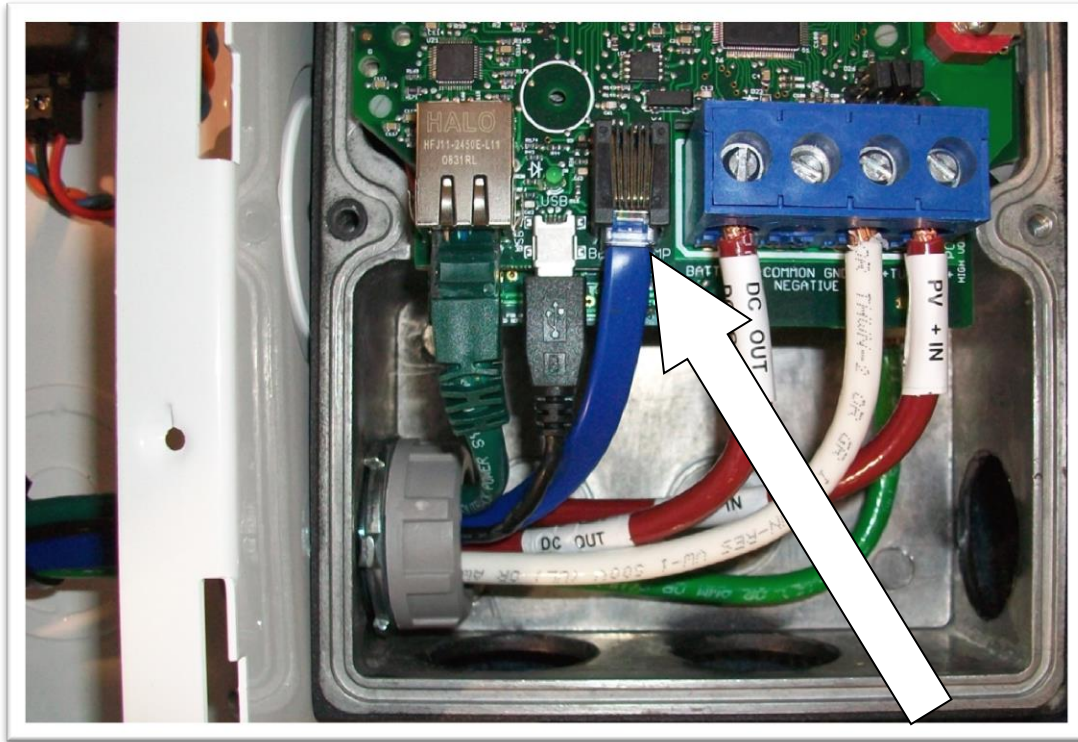

Figure 12

Insert BTS to the jack labeled BATTERY TEMP on the control board.

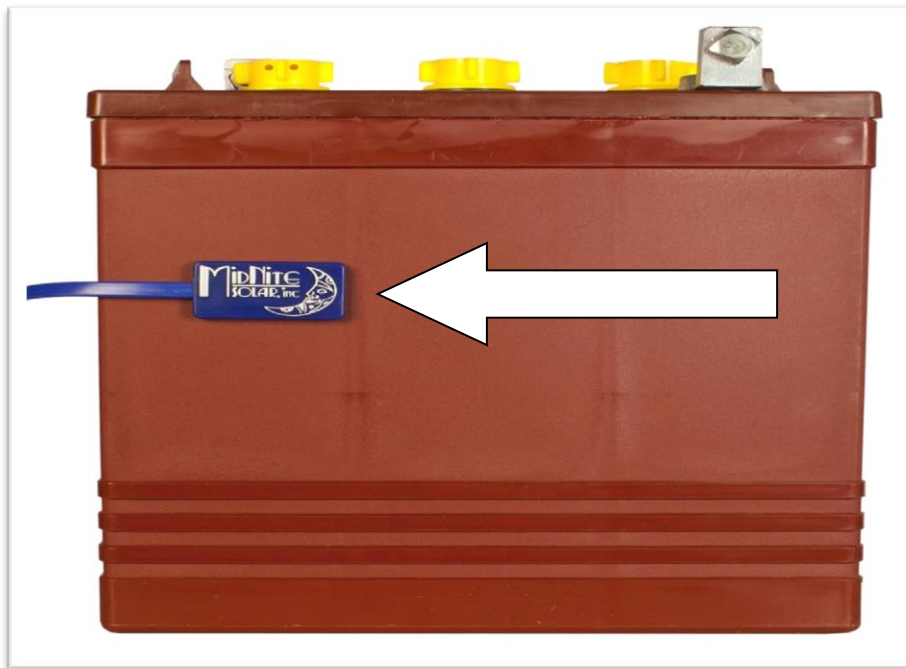

Figure 13

Chassis Grounding

In all installations the Classic chassis should be connected to ground. For systems with a battery breaker sized 60 amps and smaller, 10 AWG (6 mm²) copper is generally sufficient. For systems with a battery breaker sized 100 amps and smaller, 8 AWG (10 mm²) copper is required. For grounding conductor requirements on your specific installation please consult your local electrical code. **The chassis grounding terminal is in the upper right corner of the electrical connection compartment.**

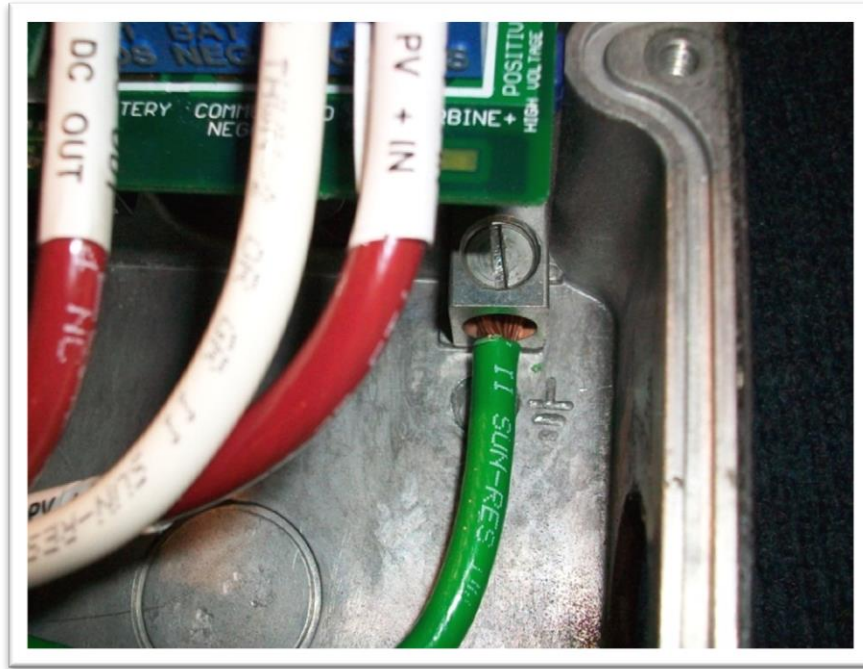

Figure 14

DC System Grounding

The Classic charge controller is designed to work with Negative Ground, Positive Ground or Ungrounded power systems. In grounded systems, dc negative may be connected to ground either externally or by using the Classic's internal grounding jumper, shown on figure 15 on Page 22. The internal grounding jumper should only be installed when the Classic's GFP is enabled.

In Positive ground or Ungrounded systems the GFP jumper must be removed. See Figure 15 Also note that with Positive ground there will be items still referenced to battery negative that can complete a short circuit of the battery bank. These items include, but are not limited to, the USB Cable and RS232 serial data lines.

Please contact Technical Support for assistance on Positive ground systems.

DC GFP (Ground Fault Protection)

The Classic has internal ground fault protection (GFP) built in. Since 2008, the NEC requires a DC-GFP on all PV systems in the USA. The built in DC-GFP eliminates the need to purchase and install an external DC-GFP. If the internal grounding jumper is installed in a Classic, the battery negative and DC source negative must not be connected to the system grounding conductor anywhere in the system. Grounding of these circuits will defeat the GFP function. In a network with multiple Classics connected in Follow Me, only one Classic should have its internal grounding jumper installed and all should have GFP enabled. The factory setting will make a DC negative to System Ground connection in the Classic charge controller. The GFP function will need to be disabled for Positive ground or an ungrounded DC system.

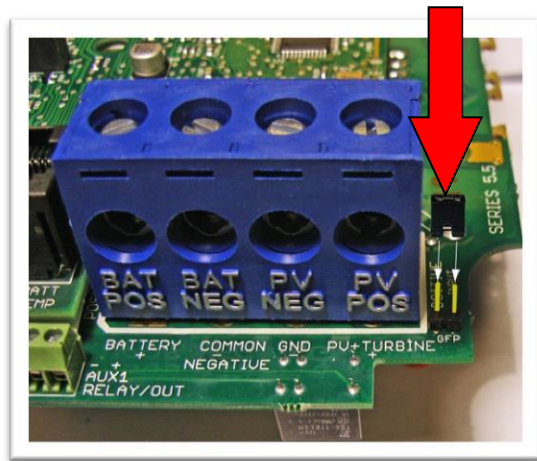

Figure 15



Figure 16

The Ground fault device is simple to understand and use. It detects a fault between battery/PV negative and earth ground just like the breaker DC-GFP system. The difference with the Classic is that it turns off the charge ability and sounds a loud warning when a ground fault is detected. The Classic's system consists of a PTC that is between the Negative and Ground internally in the Classic. A PTC is basically a self-healing fuse that will open when current exceeds its rating and reclose when current is dropped below its rating. The Classic will monitor this PTC and disable the charging when it senses it go open. When the fault is cleared the Classic will restore charging.

To disable the internal Ground Fault Protection function, the jumper labeled GFP needs to be removed and the GFP function needs to be disabled in the TWEAKS menu. See "Disabling GFP" for instructions.

To reset the internal GFP function after detection has occurred: fix the actual ground fault, then turn OFF the Classic and turn it back ON. Do this by turning the external battery breaker to OFF position and then to ON position.

Disabling GFP

The GFP feature should only be disabled to operate the Classic in an ungrounded power system or in systems where GFP is not required.

- Press Main Menu
- Scroll to the right or left until TWEAKS is highlighted and press ENTER
- In TWEAKS press the right soft key to get to the MORE menu
- In MORE scroll until GFP is highlighted
- Use the up and down arrow keys to toggle between on and off
- Press ENTER to save

Wiring the Classic



WARNING: Shock hazard. Disconnect the batteries and input power before opening the Classic front cover. ALWAYS use proper Over current and disconnects on the PV+ and Battery + at the Classic.

When two or more Classics are paralleled onto one SINGLE DC Source a blocking diode must be used between each Classic and the input source to isolate each Classic from the other ones. With Solar arrays you would have one array per Classic, this only applies to larger wind or hydro turbines.

The Classic should be wired by a qualified professional and needs to meet all applicable electrical codes. Always make sure all source and battery circuits are de energized and wait 5 minutes before working on the wiring in the Classic. The Classic has 2 common neutral (negative) terminals. Therefore, only one neutral conductor is required to run from the E-Panel and terminate on either (or both) common neutral terminal. This negative conductor should be sized to match the battery + cable. The Positive DC source wire goes to the PV+ Turbine+ screw. The Positive Battery DC wire goes to battery + terminal. Torque the terminal screws to the specs below.

To connect the wiring to the Classic:

- ❖ Ensure the DC source and Battery are disconnected
- ❖ Connect a grounding conductor between the Classic and system ground
- ❖ Ensure the breaker between the battery and Classic meets UL489 standards.
- ❖ Ensure the breaker between the DC source and Classic meets UL1077 standards.
- ❖ Connect the DC source and Battery wire to the Classic
- ❖ Connect any communications cables or auxiliary input/output wires
- ❖ Torque terminal connector screws to the following specs

The Torque specs on the DC terminal connector (big blue terminal connector) are:

- ❖ Up to #10 AWG torque to 25-35 inch pounds.
- ❖ #8 AWG torque to 30-40 inch pounds.
- ❖ #6 AWG or above. Torque to 40-50 inch pounds.

Diagram 1 Explanations

- 10 = Solar Modules (PV)
- 11 = DC Combiner (Like our MNPV6 or MNPV12 for example)
- 12 = MNSPD300-DC (Surge protection)
- 13 = MNSPD300-AC (Surge protection)
- 14 = MNSPD300-DC (Surge protection)
- 15 = DC breaker for the Inverter (Also serves as a disconnect for the Inverter)
- 16 = DC breaker for the PV into the Classic (Also serves as a disconnect for the Classic)
- 17 = DC breaker for the Battery into the Classic (Also serves as a disconnect for the Classic)
- 18 = AC L1 Input Bus Bar. (This is where the generator L1 input gets wired)
- 19 = AC Neutral Bus Bar. (This is where ALL AC Neutrals get wired)
- 20 = AC L1 Output Bus Bar. (This is where the L1 Output to the Load center for the building would connect)
- 21 = Battery Positive Bus Bar. (This is where we would wire the Battery positive side of the Classic, as well as where we would wire up DC loads. Do NOT wire the battery cable to this bus bar).
- 22 = Earth Ground Bus Bar. (This is the common Earth Ground bus bar where all the grounds get wired back to and it needs to be connected to the building's ground rod system)
- 23 = PV Positive Bus Bar. (This is where the Solar Panels positive lead connects.)
- 24 = Battery negative Bus Bar. This is where the solar panel negative lead would go as well as the Classics negative lead and any negatives from the loads. Do NOT connect the battery negative cable to this bus bar
- 25 = DC Shunt. (The Shunt measures the amperage in or out of the battery. You connect the battery to one side and everything else to the other side.)
- 26 = Earth Ground system of the building
- 27 = Classic Charge controller.
- 28 = AC Generator
- 29 = Batteries. (The Voltage must match the voltage of the inverter. Typically 2-3 strings of batteries would be considered the max.)
- 30 = Classic temperature sensor. (This is used to compensate for the temperature of the battery. If a battery is cold it has to be charged to a slightly higher voltage and when it is hot it will be charged to a slightly lower voltage.)
- 31 = DC Cables to Inverter

DC Terminal Connector

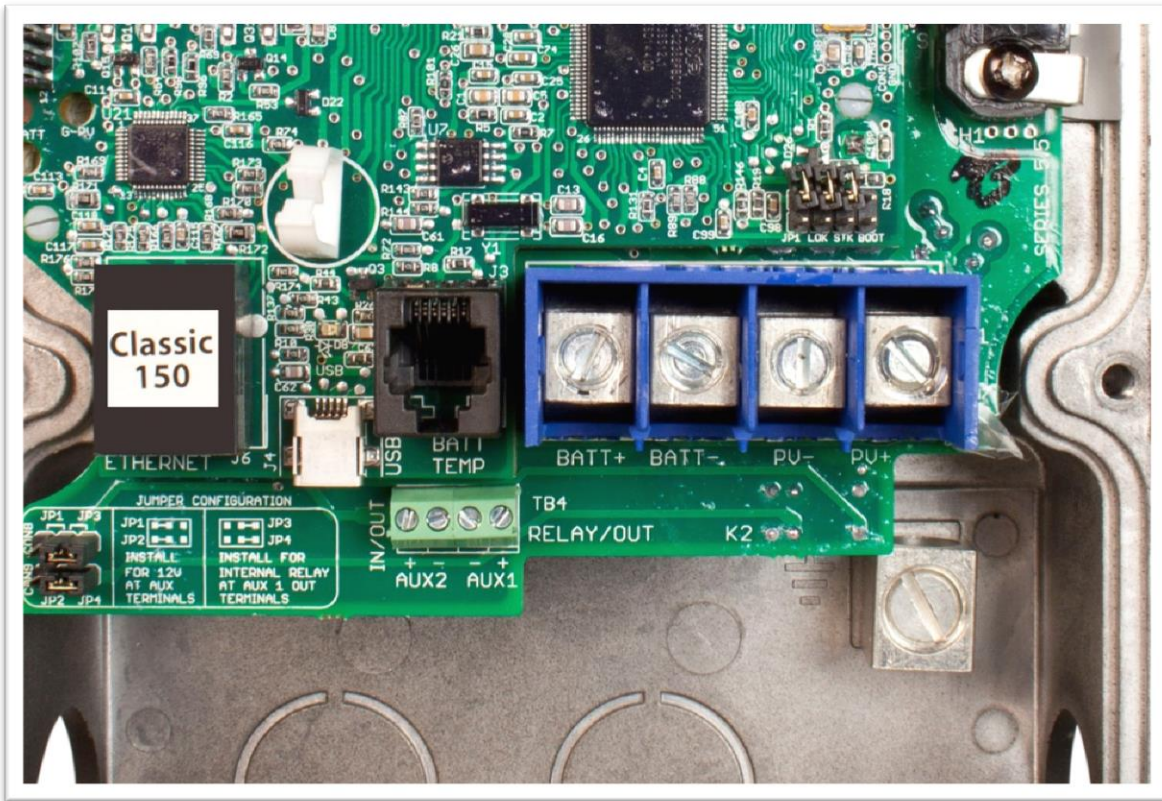

Figure 17

The Classic's DC terminal connector is located on the circuit board as shown in figure 17. The connector will take up to a #4 AWG. #4 AWG THHN when installed in the Classic and MidNite E-Panel is rated for over 100 amps and is therefore suitable for the highest power available from the Classic 150. After installing the wires for the last time snap in the blue cover that is included in the parts bag.

Over Current Protection and Wire Size Requirements

The over current devices, wiring, and installation methods used must conform to all electrical codes applicable to the location of installation. Wiring needs to be protected with proper strain relief clamps and or conduit. See page 76 for a breaker and wire size chart.

The network cables, USB cable, BTS cable and auxiliary input/output cables should run in a different conduit to preserve their signal. When installing the Classic in a MidNite E-Panel, it is acceptable to run all wiring through the same knockout hole. It is legal to run signal and power wires together as long as all wiring is listed for the highest voltage to be encountered. (Follow all local code)

Current Rating

The Classic limits the output current based on the model you have.

The Classic current ratings are:

Classic 150 + 150 Lite - 96 amps maximum

Classic 200 + 200 Lite - 79 amps maximum

Classic 250 + 250 Lite - 62 amps maximum

Over Current Protection

The Classic must have over current protection to protect wiring from over current events. A means of disconnect must be installed on the DC in and DC out of the Classic. Consult your local codes to determine over current ratings. The breaker between the battery bank and the Classic must conform to UL489. The breaker between the DC source and the Classic must conform to UL1077 or UL489. The NEC requires 1.56 times short circuit current for PV over current protection. This is reduced to 1.25 times when using a breaker rated for continuous duty. All MidNite Solar breakers are hydraulic/magnetic and are rated for continuous duty (100% rating). No de-rating is required for the output breaker when using MidNite Solar breakers.

PV in particular will be capable of producing more current than its name plate rating in extreme situations so the safe minimum wire size should be selected for the PV array maximum short circuit current. Please consult PV manufacturer for specifications. The US National Electrical Code requires 1.56 times the PV short circuit current for wire size on the PV input. Output wire size follows the NEC guidelines. Typical wire size for output is 6AWG for the Classic250 and 4AWG for the Classic200 and 150 but check all de-ratings for your wire type and installation method.

Long Distance Wire Runs

The Classic offers some unique opportunities if you are faced with longer than normal wire runs between the DC source and the Classic. The Classic comes in 3 input voltage ranges letting you design a DC source at a higher voltage if it is beneficial. For example let's say you have a 300 ft run from a PV array to the Classic. You could wire for an open circuit voltage close to 250vdc accounting for the coldest temperature you will encounter. This will allow you to run a smaller gauge wire than with a lower voltage charge controller. The efficiency of a high voltage Classic is less than the lower voltage versions, so you need to weigh the benefit. If this sounds too complicated use this rule of thumb in selecting the proper Classic. PV runs up to 100 feet, use the Classic 150, runs up to 180 feet, use the Classic 200, or above 180 feet use the Classic 250.

If the wire size between the DC source and the Classic is larger than the Classic's DC terminal connector you can use a splicer block or similar connector to reduce down to #4 AWG close to the Classic. The MidNite E-Panels are supplied with a PV input bus bar that accepts up to 2/0 wire.

Connecting the Classic to the Clipper

The connections between the Clipper and Classic are fairly basic. There is the DC – and + conductors from the Clipper to the PV input on the Classic. There is also a smaller set of – and + conductors connecting Auxiliary 2 to the PWM input on the Clipper. To program the Classic to work with the Clipper the Aux 2 needs to be programmed. Follow the steps below to program this. (Note: see our instructional videos at www.midnitesolar.com)

-Enter the Main menu and scroll to Aux and press Enter.

-Scroll to the right to highlight the text under Aux 2 and press the upper right soft key.

- Scroll up or down to find Clipper control and press the right soft key again
- On this screen we need to select AC or DC for the Clipper you have (AC is default)
- CAUTION! CONNECTING A DC CLIPPER WITH THIS SET TO AC CAN DAMAGE THE CLIPPER!**
- Press the right soft key again, here we need to set the absolute voltage we want the clipper to allow.
- Press Enter to save this data and press Main Menu until you get back to the Aux 1 and Aux 2 screen
- Set the Text under Aux 2 to say Clipper Control and press Enter.
- Press Status to return to the home screen.

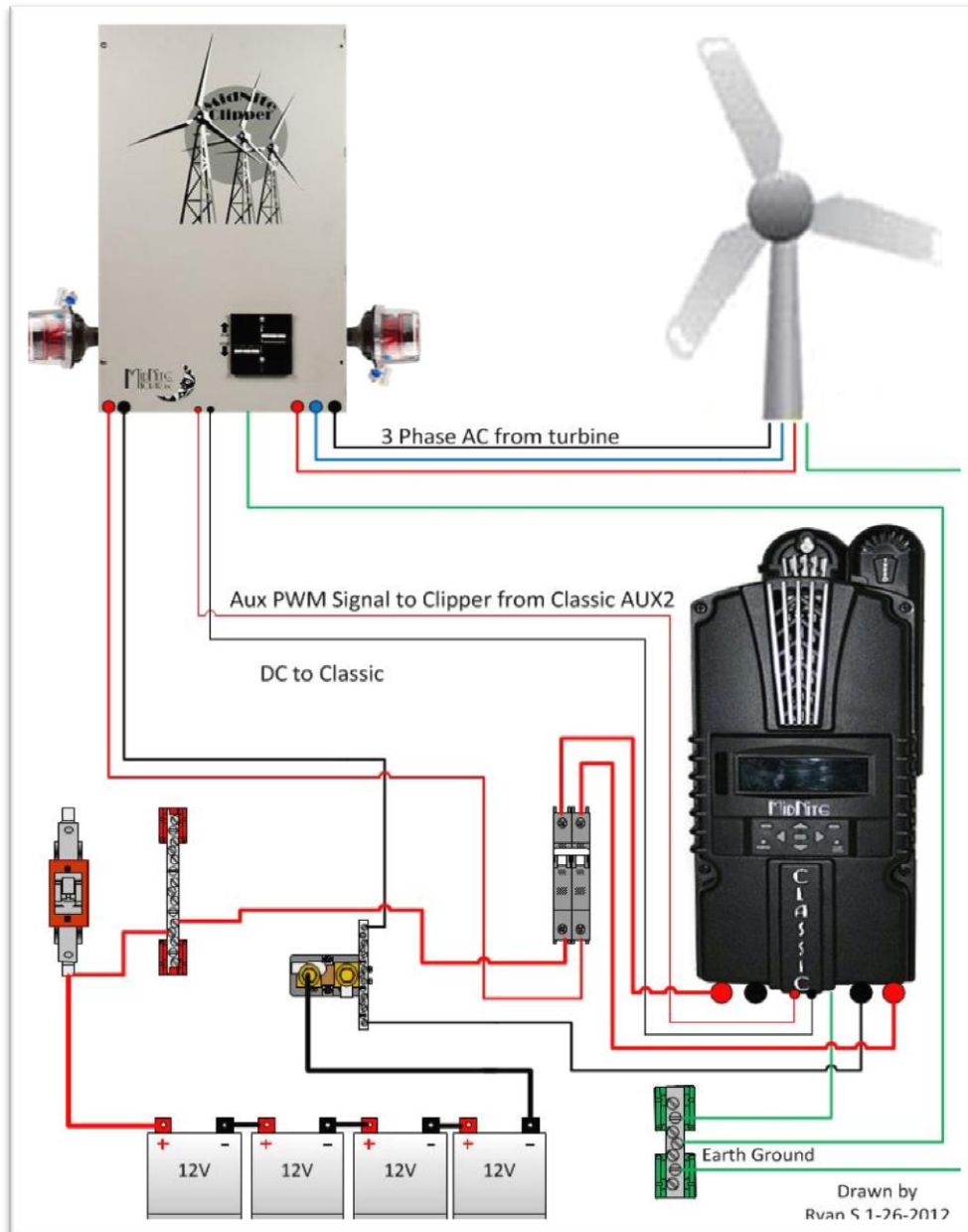

Diagram 1

Maximum and Minimum Wire Size

The Classic's Blue DC terminal connector will accept wire from #14-#4 AWG
 The Classic's Aux 1 and 2 terminal connector will accept wire up to #18 AWG

Equalization Manual and Auto

Equalization with the Classic Lite

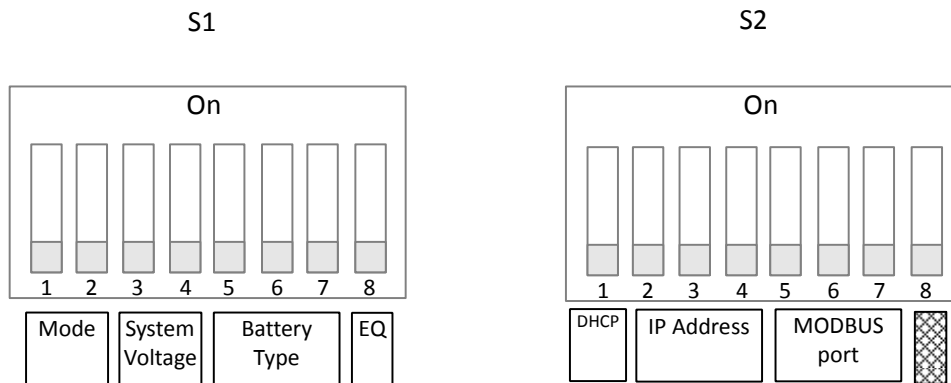

Auto Equalize Switch 8

Equalize

Manual	Off
Auto	On

By setting Auto Equalize to Manual, the Equalize intervals in the Battery Settings table are effectively disabled and Equalization stages will have to be started manually.

Please note that not all manufacturers recommend Equalizing AGM batteries. Check with your manufacturer and make sure to **DISABLE Auto Equalization on the Lite if your manufacturer does not recommend equalizing your AGM batteries**

Equalize Button

The Equalize button serves two purposes: the first is to begin an Equalize stage, the second is to clear faults.

Equalization:

An Equalize stage can be scheduled or started at any time by holding the Equalize button down for 2-3 seconds. Holding the EQ button down for 2-3 seconds at any point once equalization is activated will cancel the equalization stage and return back to the most appropriate battery stage.

When the equalize button is pressed, the EQ light will come on solid. Once Equalize proper starts the light will flash. If Equalization cannot begin immediately then the Lite will try to engage equalization for 18 hours and then stop if it can't.

Equalization with the standard Classic

Manual EQ

To do a manual Equalization charge, go into the Charge menu and highlight "EQ" and press "Enter". Now "EQ Stopped" will be highlighted. Scroll up to select "Eq Started". Press the "Status" button to return to the home screen. To stop a manual EQ in progress simply reverse the steps above. A manual EQ when started will last for that day unless the Classic is on Hydro or Wind and the controller never goes to Resting that night. In this case, it will stay in EQ until it completes or the controller goes to Resting.

Auto EQ

The Classic can be set up to automatically equalize your batteries periodically, programmed as days between Equalization and the number of days the Classic will try to finish the programmed equalization charge cycle. To set up Auto EQ go into the CHARGE menu and highlight "EQ" and press "Enter". Now press the SOFT RIGHT key labeled "AUTO EQ". Pressing the AUTO EQ soft key enters the Auto EQ setup menu screen. The left side of the EQ setup menu will show and select the number of days, or "interval" between auto EQ charge cycles. If set to zero (0), it will display MANUAL which is the same thing as DISABLED.

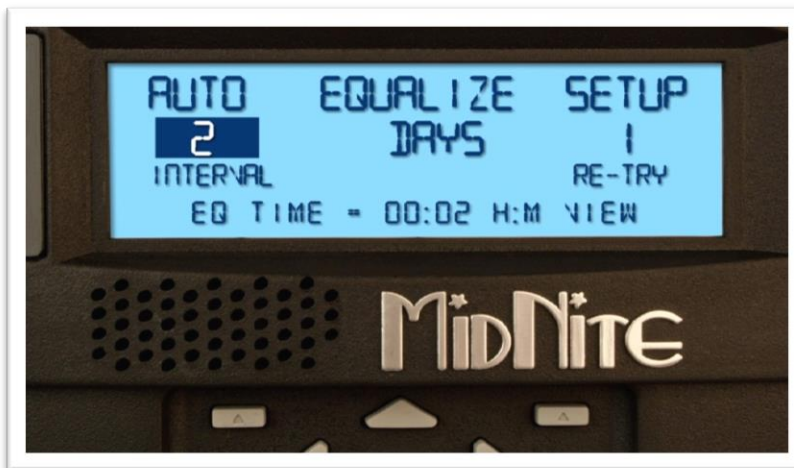

Figure 18

On the right side of the Auto EQ setup menu is the number of DAYS that the Auto EQ will retry if it does not finish the number of Hours and Minutes the Classic has been programmed to EQ for during the first day. For instance, you set the Auto EQ for an interval of every 30 days and the RE-TRY for 3 days. Then the first day it attempts an EQ, the Classic only accumulates 1 hour of a 2 hour EQ cycle, the next day the Classic will re attempt the EQ cycle. If the Classic still didn't finish the EQ cycle on the 2nd day of its 3 allotted re-try days, it will have one more day to try to finish the Equalize cycle. After this, if it did not complete the 2 hours of EQ time, it will not continue another day. The Classic will show "EQ DONE" on the status screen until either the start of the next day or until the user presses a button on the MNGP to stop it earlier.

At the bottom of the AUTO EQ screen shows the time, in hours and minutes, that the EQ is set for. Pressing the Soft Right key, labeled "VIEW", takes you to a screen where you can view the interval and re-try counters (timers).

Standard Classic programming

Commissioning the Classic (Quick Start)

The Classic will enter into the Quick Set screens upon initial power up. If the Classic does not enter into the quick set or you want to restore to Factory Default follow these steps to initiate a Quick Set.

- ❖ With the power off to the Classic Hold the left and right arrow buttons down.
- ❖ Turn the power on to the Classic and continue to hold the arrow buttons until the setup screen is displayed.
- ❖ Answer the questions on the next few screens to complete the Quick Set.

Battery Charge Stages and Meanings

Bulk MPPT

This stage of the Classic means that the Classic will be putting out as much current as it can to raise the battery voltage to the absorb voltage set point. This is also known as Constant Current Mode.

Absorb

This stage means that the Classic will maintain the Absorb set point voltage until the batteries are charged. This stage is terminated at the end of the Absorb time or the End Amps set point, whichever is reached first. At this stage the Classic is not putting out maximum current, as that would increase the battery voltage over the Absorb set point. This is also referred to as Constant Voltage Mode. The absorb time is proportional to the bulk time (i.e. the time bulk takes to reach the absorb voltage). The battery is considered “full” at the end of the absorb charge cycle.

Float

A *Float* cycle follows after the *Absorb* cycle is completed; *Float* is displayed on the screen. Battery voltage is held at the float voltage set point.

Equalize

The Equalization function can be manually initiated or can be set up to Auto Equalize. The intent of an Equalization charge is to bring all battery cells to an equal voltage by a controller deliberate overcharge. The goal is to return each battery cell to its optimum condition through a series of voltage controlled chemical reactions inside the batteries.

Resting

“Resting” will show on the display when the Classic is not charging the batteries, this is typically due to low light. If the Classic is resting and should not be, make sure Aux2 is **not** set to a logic input that is forcing it into resting.

Mode is OFF

The Classic is unique in that it has multiple charging algorithms for just about any DC input. Because we support such a wide variety of DC inputs we have also added a software “ON” and “OFF” feature. This software “Switch” basically turns the relay off, effectively disconnecting the input source so the Classic will not charge the battery. If you see “**Mode is Off**” in the bottom right corner of the display then the Mode may have been turned off. To turn the mode back “ON” push the Main Menu button several times until “Charge” is highlighted. Scroll to the right until “Mode” is highlighted and press “Enter”. On this screen “OFF” should be highlighted use the up or down arrow to change it to “ON” and press “Enter”. Press the Status button once to return to the main status screen.

Note: This is the same menu you would use to change between Charging algorithms IE Solar, Hydro, Wind etc

Adjusting Absorb, Equalize and Float Voltages

Absorb, Equalize and Float voltages are fully adjustable. You will need to get the actual voltages from the battery manufacturer. To adjust these voltages follow the steps below.

- ❖ Press Main Menu to enter the Main Menu
- ❖ Scroll right or left until Charge is highlighted and push the Enter button
- ❖ Highlight Volts and press the Enter button
- ❖ Use left and right arrow keys to highlight the set point voltage to adjust
- ❖ Use up and down arrow keys to lower or raise the voltage
- ❖ Press the Enter button to save the new voltages.

Current Limit

The Classic has a current limit component which interacts with the temperature of the charge controller. If the Classic is exposed to extremely hot ambient conditions the output current will be reduced automatically to keep the charge controller safe. If the orange LED comes on the MNGP, it means that the Classic is in current limit mode. If you believe the Classic is not hot and the orange LED is on, most likely the current limit set point is too low. To check this, follow steps below.

- Press Main Menu
- Highlight the CHARGE menu and press the Enter Button
- Scroll to LIMITS and press the Enter Button
- Press the right arrow key to highlight “Out Amps” or “In Amps” column
- Use the up and down arrow keys to change the current limit then press the Enter Button to save this data

LED Modes and the “Blinking Red LED”

Below we will explain the different LED Modes. To change the LED Mode press the “Main Menu” button repeatedly until “Charge” is highlighted. Scroll to the right until “Misc” is highlighted and press “Enter”. Now scroll to “LED-Mode” and press “Enter”. Here you can use the up and down arrows to select the mode you prefer. After selecting the appropriate LED Mode press “Enter” to save this data to the Classic. Pressing “Status” will now bring you back to the home screen.

OFF = No LED activity no matter what

Rick Mode = LED Activity for Errors and Warnings only. (Over current, Arc Fault Etc)

Blinky = basically cycles all the LEDs in a Disco fashion (Useful for Parties)

LED 1 = LED activity for Warnings and Errors as well as info. A green LED on the display indicates the Classic is in Float. A yellow LED on the display indicates a warning (Over Temp, over current etc). A red LED on the Display indicates an Error (Arc Fault etc).

There is also 3 LEDS inside the Classic that can be viewed through the upper vents. The red LED indicates Auxiliary 1 is active. The yellow LED indicates Auxiliary 2 is active.

The blue LED is for Follow –Me a short 1/10 of a second blip means it got a good packet a long blip ½ second means it got a bad packet or no packet at all. Consistent long blips generally indicate a bad cable.

Calibrating Battery and PV Voltage

To calibrate the Classic battery and PV voltage reading, you will need a Volt meter to check the actual battery bank voltage or input PV voltage. Using the volt meter measure the voltage on the DC terminal connector of the Classic (refer to Screenshot 1) compare this reading to the reading on the Status screen in the Classic (press Status if not in this screen). To adjust the reading of the Classic to the one in the volt meter follow these steps:

- ❖ Press Main Menu, scroll to TWEAKS and press Enter
- ❖ Highlight VBatt and use the up and down arrow keys to match both of the readings
- ❖ Press the Enter button to save

Note. Use the description below to help complete the calibration of the Classic voltages.

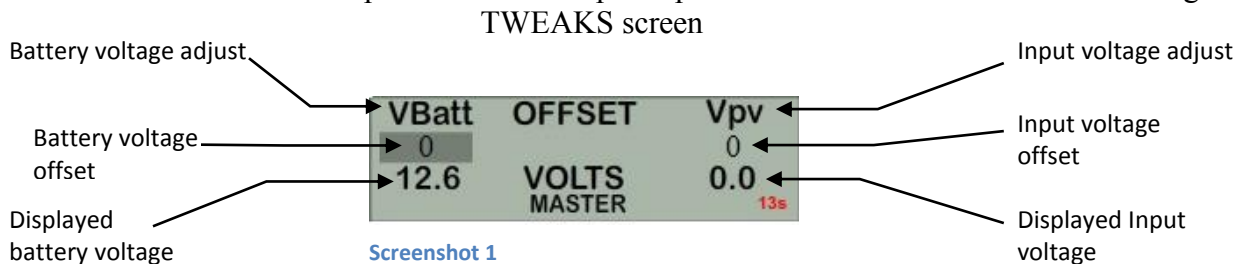

Configuring DC Input Source

To select the Mode the Classic will run in, follow the steps below.

- ❖ Push the Main Menu button.
- ❖ Scroll left or right until Mode is highlighted and then push the Enter button.
- ❖ Scroll to the right and highlight the current Mode than use the up and down arrows to set the mode you want.
- ❖ Take note of the Right soft key most modes have some set points that can be adjusted.
- ❖ Press the Main Menu button until you get back to the Mode Menu
- ❖ Set the ON/OFF to ON and press Enter

The following Modes will appear in this order in the MODE Menu.

Micro Hydro

This mode is intended for use with hydro systems, but can be used with other sources as well. When the Classic first turns on after the input voltage goes above battery voltage, it will sweep from that open circuit voltage down to battery voltage, finding the maximum power point voltage (MPP Voltage). Then it will return to that newly found voltage. After the original turn-on sweep, the Classic will do mini sweeps at user adjustable time intervals. If the time interval is set to 0, the Classic will not do any mini sweeps but will stay on this first found MPP V until the user goes to the mode menu and turns it off and back on again.

Micro Hydro mode sweeps slightly slower than Solar mode and has two user adjustable settings. Sweep Interval is the time between mini-sweeps, in minutes, and sweeps around the present (i.e. the last found), MPP Voltage. The range of this sweep is determined by the Sweep Depth user adjustment and is expressed as a percentage of Watts that the sweep started from. For example, if in Micro Hydro mode, the Classic was outputting 1000 Watts and the Sweep Depth percentage was set for 20%, (200 Watts), the sweep will bring the input voltage DOWN until the output power drops down to 800 Watts, then will sweep UP in voltage until the power drops again down to 800 Watts and then go back to the newly found MPP Voltage, waiting for the next sweep.

Solar

This is the default mode for PV systems and has a very fast sweep (typically 1/2 second or less) that will re-sweep at user adjustable sweep intervals, unless the Classic finds that it needs to do a sweep on its own because of changing conditions. The timed sweep interval is user adjustable and is in units of minutes. SOLAR mode is typically best for PV systems, especially if there is partial shading at times during the day. SOLAR mode is best suited for shaded or un-shaded PV arrays that are at least one nominal voltage above the battery voltage. For severe partial shading or PV arrays with nominal voltage equal to battery voltage, you may also want to try Legacy P&O (Perturb and Observe) MPPT mode.

Legacy P&O

Legacy P&O (Perturb and Observe) mode is a slow tracking mode similar to the Micro Hydro mode but with the difference that it is slightly faster and will shut off if the power source goes off.

It has two settings that are user adjustable. Sweep Interval is the time between mini-sweeps, in minutes, and sweeps around the present (i.e. the last found) MPP Voltage. The range of this sweep is determined by the Sweep Depth user adjustment and is expressed as a percentage of Watts that the sweep started from. For example, if in Legacy P&O mode, the Classic was outputting 500 Watts and the Sweep Depth percentage was set for 10% (50 Watts), the sweep will bring the input voltage DOWN until the output power drops down to 450 Watts, then will sweep UP in voltage until the power drops again down to 450 Watts and then go back to the newly found MPP Voltage, waiting for the next sweep.

Wind Track

This mode uses a power curve that is either built by the user or one of the pre-installed graphs. The power curve consists of 16 set points that consist of output amperage and input voltage, allowing the user to custom build a curve for their Wind turbine. Please refer to the Wind section of the manual for full details on programming the curve as well as our video that will help in understanding how to adjust these curves using the wind graph editor.

Dynamic

This is typically used for PV (solar) input sources and tries to follow, on a slow dynamic basis, the changing conditions of the input source. This mode has one user adjustment which is a forced sweep perturb trigger interval for times when the input condition changes do not trigger a dynamic sweep. The interval is in units of minutes.

U-Set VOC%

This is a fully manual mode based on a percentage of VOC. The Classic will sweep based on the user set time in minutes and then park at a user set percentage of the VOC the Classic found on that sweep. This mode is useful for testing or constant voltage sources.

Note: Mode must be manually turned ON after changing the mode. To turn the mode ON highlight the OFF under ON/OFF and switch it to ON. Press enter to save this change.

Configuring the Classic for Wind Input Source

Wind

If you selected "Wind" you will need to select a power curve from the list of pre-loaded curves or build your own. To access the list of power curves follow the steps below.

- ❖ Push the Main Menu button.
- ❖ Scroll left or right until "Mode" is highlighted and push the Enter button.
- ❖ Set the status to OFF and then use the right soft key to select "Graph".

Using the left soft key select "MEM". Now you can scroll up and down through the menu and select the curve that was designed for your turbine. Once you find the correct power curve use the right soft key to select "RECALL". Now push the Enter button to save this power curve to the Classic's memory.

There are also 9 memory spaces for you to save a custom power curve. To build custom power curves select a memory location between 1 and 9 and hit "RECALL". Use the right and left arrow buttons to scroll through the 16 steps in the custom curve. On each step you can set the amperage by using the up and down buttons. When you have the power curve the way you want it, select "MEM". Use the up and down buttons to select a location 1 through 9 to save it in and select "SAVE". Now push the Enter button to save it to the Classic's memory.

For more information consult the videos found at www.midnitesolar.com

Setting the Date and Time

To set the date and time manually on the Classic follow the steps below.

- ❖ Push the Main Menu button repeatedly until Charge is highlighted.
- ❖ Scroll left or right to highlight "MISC" and push the Enter button
- ❖ Scroll to "Time" and push Enter

Now scroll left or right to highlight the data you want to manually change. Use the up and down buttons to change the data. When you have all the data changed push the Enter button to save the changes.

The Classic includes a battery (CR1216) in the MNGP portion to keep the time running even when the power is disconnected. To replace the battery refer to the Installation Manual

Note: If you plan to use the Local App to set the time and not the Classics Display "Time Sync" in the "Tweaks" menu must be disabled to prevent the MNGP (display) from over writing what the Local App does.

Configuring Auxiliary Input/Output

The Classic includes two auxiliary ports which can be configured to become inputs or outputs. These aux ports can be used as a secondary power supply to be used for accessories such as vent-fan, Diversion loads, Logic inputs, WBjr or the Clipper for example. The Aux output is limited to 200ma or less per channel. Here is an explanation of how they work.

- An internal, re-settable Positive Temperature Co-efficient (PTC) fuse protects the AUX internal components from overcurrent or a short circuit.
- AUX 1 consists of either RELAY or LOGIC operation, depending on the user selection function.
- AUX 2 could be set to become an INPUT or OUTPUT. One at a time this port could be reading the state of a device connected and takes an action from there.



Screenshot 2

To configure the Classic's Aux ports:

- ❖ Push the Main Menu button
- ❖ Scroll left or right to highlight “AUX” and push the Enter button.
- ❖ Scroll left or right to highlight the relay you wish to change. Push the right soft key labeled “SETUP”.
- ❖ Scroll up or down to change the function of the relay. Select the right soft key to set the parameters of the function. When finished push the ENTER button to save the changes.

The Main Aux Screen shows both Aux1 and Aux2 functions

Off -	Places output to Low state (0 Volts)
Auto -	Selects the assigned function to the Aux output or input
On -	Sets output for Low state (12 Volts or Relay On)

Table 4

The Following is a list of the Aux 1 and 2 functions with brief descriptions of their function.

AUX 1 - Control Settings (12V @ 200Ma or Dry 1A Contact)

SOC % Low

This mode will set AUX1 to 0.0V according to the LOW % and HIGH % settings. HOLD (LOW) and DELAY (HIGH) activation TIMES can be set in seconds. SOC %=HIGH=0V SOC %=LOW=12V

SOC % High

This Mode will set AUX1 to +12V according to the LOW % and HIGH % settings. HOLD (LOW) and DELAY (HIGH) activation TIMES can be set in seconds. SOC %=HIGH=12V SOC %=LOW=0.0V

If the classic is set to do an auto-restart at 23:59 (midnight), the state of the AUX1 will be remembered so it will return to the last state (+12V or OFF) after it resets and comes alive again.

GFP Trip High

This mode sets AUX1 HIGH (+12V) for 0.1 second when a ground fault is detected.

Vent Fan Lo

This mode will turn AUX1 OFF above the voltage set point you program. It allows you to run a vent fan for a battery bank based on battery voltage. There is a voltage set point that you set and AUX 1 will turn off when the battery reaches that set point. The voltage has to fall 2 tenths of a volt below the set point for 30 seconds before AUX1 will turn back on.

Vent Fan High

This mode will turn Aux 1 on above the voltage set point you program. It allows you to run a vent fan for a battery bank based on battery voltage. There is a voltage set point that you set and Aux 1 will turn on when the battery reaches that set point. The voltage has to fall 2 tenths of a volt below the set point for 30 seconds before Aux 1 will turn off.

Float Low

This mode will turn Aux 1 off whenever the Classic is in Float. Aux 1 will stay off until the Classic falls 3 tenths of a volt below the float voltage set point.

Float High

This mode will turn Aux 1 on whenever the Classic is in Float. Aux 1 will stay on until the Classic falls 3 tenths of a volt below the float voltage set point.

Clipper Control

This mode was intended to control the MidNite Clipper. It will send out a PWM signal whenever the controller is unloading the turbine because the battery is full or close to it. There are no adjustment in this mode the Classic is preprogrammed with the best parameters to control turbine RPM.

Day Light

This mode will turn Aux 1 on at sunrise and turn it off at sunset based on the PV input voltage.

Nite Light

This mode will turn Aux 1 on at sunset and turn it off at sunrise based on the PV input voltage.

Toggle Test

This mode will cycle Aux 1 for 1 second off and 1 second on repeatedly. This mode is mostly for testing purposes.

Pv V on Low

This Mode will turn Aux 1 off above a user set voltage based on the input voltage to the Classic (V High) and turn Aux 1 on when it hits a low voltage set point (V Low). It also allows you to set a delay time in seconds the Classic will wait before turning Aux 1 off after reaching the V High set point. It also allows you to set a hold time in seconds the Classic will wait before turning Aux 1 on after reaching the V Low set point. This mode can be useful for controlling a failsafe stopping system for Hydro or Wind.

Pv V on High

This Mode will turn Aux 1 on above a user set voltage based on the input voltage to the Classic (V High) and turn Aux 1 off when it hits a low voltage set point (V Low). It also allows you to set a delay time in seconds the Classic will wait before turning Aux 1 on after reaching the V High set point. It also allows you to set a hold time in seconds the Classic will wait before turning Aux 1 off after reaching the V Low set point. This mode can be useful for controlling a failsafe stopping system for Hydro or Wind.

Waste Not Lo

This mode will turn Aux 1 off when the Classic gets within a certain range of the voltage set points for each charging stage (V High) and turn Aux 1 on when it gets to a low set point (V Low). These set points are user adjustable and will allow the Absorb, Float and EQ timers to continue to run. You will adjust these set points to negative numbers and the numbers are an offset from the voltage set point. For example a -0.2 would turn Aux 1 off 2 tenths of a volt below your set points. This mode will allow you maximum diversion while maintaining your 3 stage charging. It also allows you to set a delay time in seconds the Classic will wait before turning Aux 1 off after reaching the V High set point. It also allows you to set a hold time in seconds the Classic will wait before turning Aux 1 on after reaching the V Low set point.

Waste Not Hi

This mode will turn Aux 1 on when the Classic gets within a certain range of the voltage set points for each charging stage (V High) and turn Aux 1 off when it gets to a low set point (V Low). These set points are user adjustable and will allow the Absorb, Float and EQ timers to continue to run. You will adjust these set points to negative numbers and the numbers are an offset from the voltage set point. For example a -0.2 would turn Aux 1 on 2 tenths of a volt below your set points. This mode will allow you maximum diversion while maintaining your 3 stage charging. It also allows you to set a delay time in seconds the Classic will wait before turning Aux 1 on after reaching the V High set point. It also allows you to set a hold time in seconds the Classic will wait before turning Aux 1 off after reaching the V Low set point.

Low bat disc

This mode will turn Aux 1 off when it reaches a set point based on battery voltage (V High) and turn it on at another set point based on battery voltage (V Low). It also allows you to set a delay time in seconds the Classic will wait before turning Aux 1 off after reaching the V High set point. It also allows you to set a hold time in seconds the Classic will wait before turning Aux 1 on after reaching the V Low set point. This can be used with a NC relay, when the battery gets to the set point the Classic will send 12vdc to the relay holding it open and disconnecting the load.

Diversion

This mode will turn Aux 1 on when it reaches a set point based on battery voltage (V High) and turn it off at another set point based on battery voltage (V Low). It also allows you to set a delay time in seconds the Classic will wait before turning Aux 1 on after reaching the V High set point. It also allows you to set a hold time in seconds the Classic will wait before turning Aux 1 off after reaching the V Low set point.

Aux 2 – Control Settings

Float Low

This mode will turn Aux 2 off whenever the Classic is in Float. Aux 2 will stay off until the Classic falls 3 tenths of a volt below the float voltage set point.

Float High

This mode will turn Aux 2 on whenever the Classic is in Float. Aux 2 will stay on until the Classic falls 3 tenths of a volt below the float voltage set point.

Day Light

This mode will turn on Aux 2 at sunrise and turn it off at sunset based on the PV input voltage.

Nite Light

This mode will turn on Aux 2 at sunset and turn it off at sunrise based on the PV input voltage.

Clipper Control

This mode was intended to control the MidNite Clipper. It will send out a PWM signal on AUX 2 whenever the controller is unloading the turbine because the battery is full or close to it. There are several adjustment in this mode to optimize the Classic/Clipper combo; please see the Clipper manual for full details.

Pv V on Low

This mode is PWM based and is just reverse logic of Pv V High. It would be comparable to using the NC contacts of the relay used in Pv V High. It can be used that way with a solid state relay with NC contacts for a failsafe load.

Pv V on High

This mode is PWM based and will PWM Aux 2 above a user set voltage (V High) based on the input voltage to the Classic and stop when it hits a low voltage set point (V Low).

Toggle Test

This mode will cycle Aux 2 for 1 second off and 1 second on repeatedly. This mode is mostly for testing purposes.

Waste Not Lo

This mode is PWM based and is just reverse logic of Waste Not Hi. It would be comparable to using the NC contacts of the relay used in Waste Not Hi. It can be used that way with a solid state relay and NC contacts to do diversion above a set voltage.

Waste Not Hi

This mode is PWM based and will PWM Aux 2 when the Classic gets within a certain range of the voltage set points for each charging stage (V High) and stop when it gets to a low set point (V Low). These set points are user adjustable and will allow the Absorb, Float and EQ timers to continue to run. You will adjust these set points to negative numbers and the numbers are an offset from the voltage set point. For example a -0.2 would turn Aux 2 on 2 tenths of a volt below your set points. This mode will allow you maximum diversion while maintaining your 3 stage charging.

Diversion Lo

This mode is PWM based and is just reverse logic of Diversion Hi. It would be comparable to using the NC contacts of the relay used in Diversion Hi. It can be used that way with a solid state relay and NC contacts to do diversion above a set voltage.

Diversion Hi

This mode is PWM based and will PWM Aux 2 at a set point based on battery voltage (V High) and stop it at another set point based on battery voltage (V Low).

Aux 1 Function

OUTPUT = Relay or 12V/0V Signal jumper selectable, ON/OFF Function. (Dry Contact 1A max)
 Aux 1 has the relay so Diversion functions must operate slowly

SOC % LOW	Battery State of Charge Active LOW
SOC % HIGH	Battery State of Charge Active HIGH
GFP TRIP HIGH	Ground Fault sets AUX1 HIGH for 0.1 seconds repeatedly
VENT FAN LOW	Aux1 on below setpoint
VENT FAN HIGH	Aux1 on above setpoint
FLOAT LOW	Aux1 off when in Float
FLOAT HIGH	Aux1 on when in Float
CLIPPER CONTROL	PWM Control for Clipper
DAY LIGHT	Aux1 on at dawn off at dusk
NITE LIGHT	Aux1 on at dusk off at dawn
TOGGLE TEST	Aux1 cycled 1 sec interval
Pv V ON LOW	Aux1 on below Pv in setpoint
Pv V ON HIGH	Aux1 on above Pv in setpoint
WASTE NOT LO	Divert based on charge state lo
WASTE NOT HI	Divert based on charge state hi

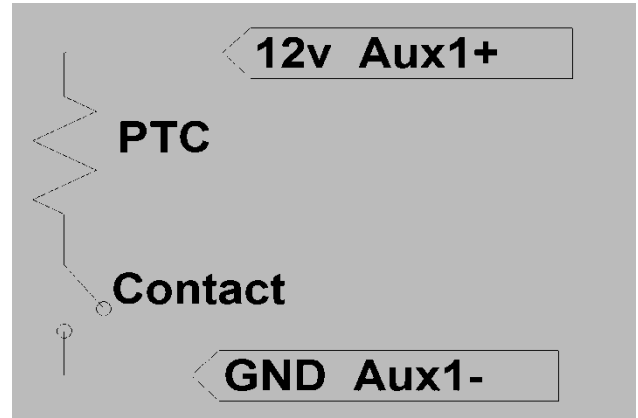
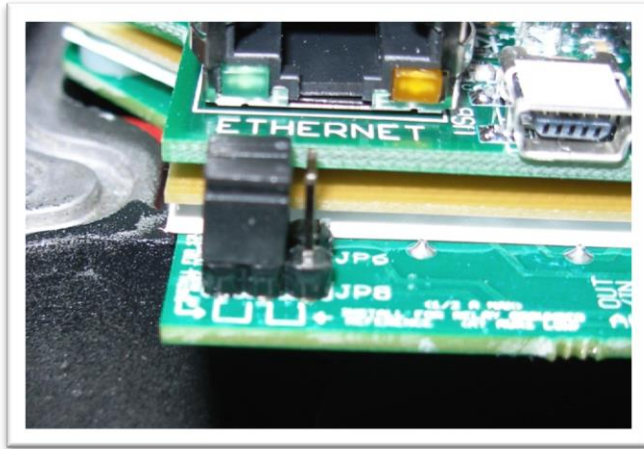

Diagram 2

When Aux 1 is used to supply 12v out, JP6 and JP8 have to be in the position shown in Diagram 2. The basic schematic of how this works is shown above. The 12v out is more like 14.5v. The maximum current from Aux 1 should not exceed 200mA. The Aux 1 output can be set to operate at either Active High (12V) or Active Low (0V) when the Aux 1 function condition is true. For more information see Configuring Auxiliary Input/Output on page 37.

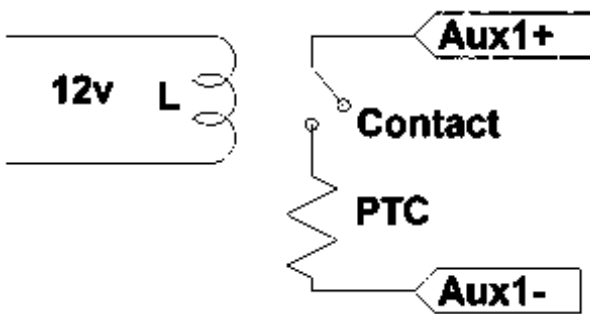

Diagram 3

To configure Aux 1 to use the internal relay, JP6 and JP8 have to be in the position shown in Diagram 3. This configuration is commonly known as “dry contact” because it does not provide 12v at the Aux1 terminals; it acts more like an isolated switch (to the ratings of the relay). The Aux 1 output can be set to operate at either normally open, (Active High) or normally closed (Active Low) when the Aux 1 function condition is true. For more information see Configuring Auxiliary Input/Output on page 36.

Aux 1 Voltage-Time Relation (Relay/12v)

Aux 1 Function Graph shows the relationship between voltage and time of AUX 1. (The axis labeled VOLTAGE could be battery, PV, wind input voltage, etc. depending on the function selected by the user) VHIGH is the upper voltage limit, as soon as the voltage reaches this limit the Delay time will then start; as soon as the Delay time expires AUX1 will change state and stay there until the voltage drops below VLOW set point, then another timer called Hold Time will start and when this expires the output will go back to the original state.

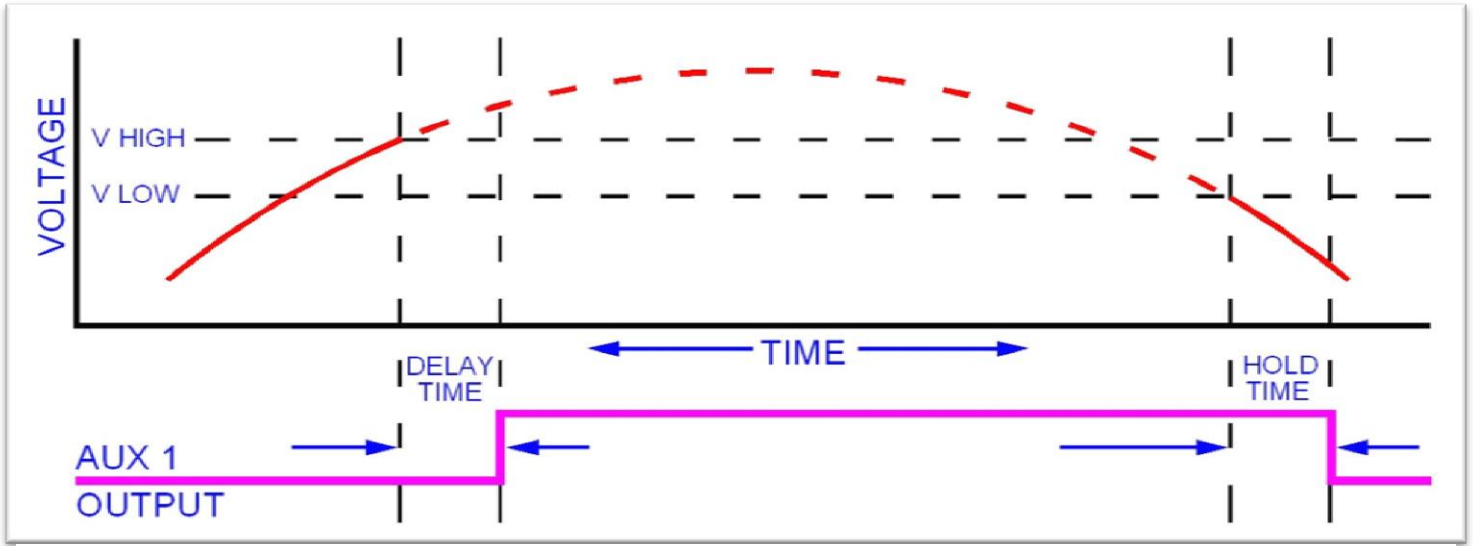

Diagram 4

Aux 2 Voltage-Time Relation (PWM)

The graph below describes the relation in Aux 2, between voltage and time. The difference in Aux 2 is the use of PWM running at a hundreds of Hz rate and is suitable for use with Solid State Relays (SSRs). The way this works is: user sets a desired threshold and a width voltage; this means that at the desired voltage (VOLTS), the aux will start to PWM and it has to go above or below the width to completely change states (from 0v to 12v, or from 12v to 0v depending on the user selection, active high or active low). This gives a much smoother transition. For more information see; Configuring Auxiliary Input/Output, page 36

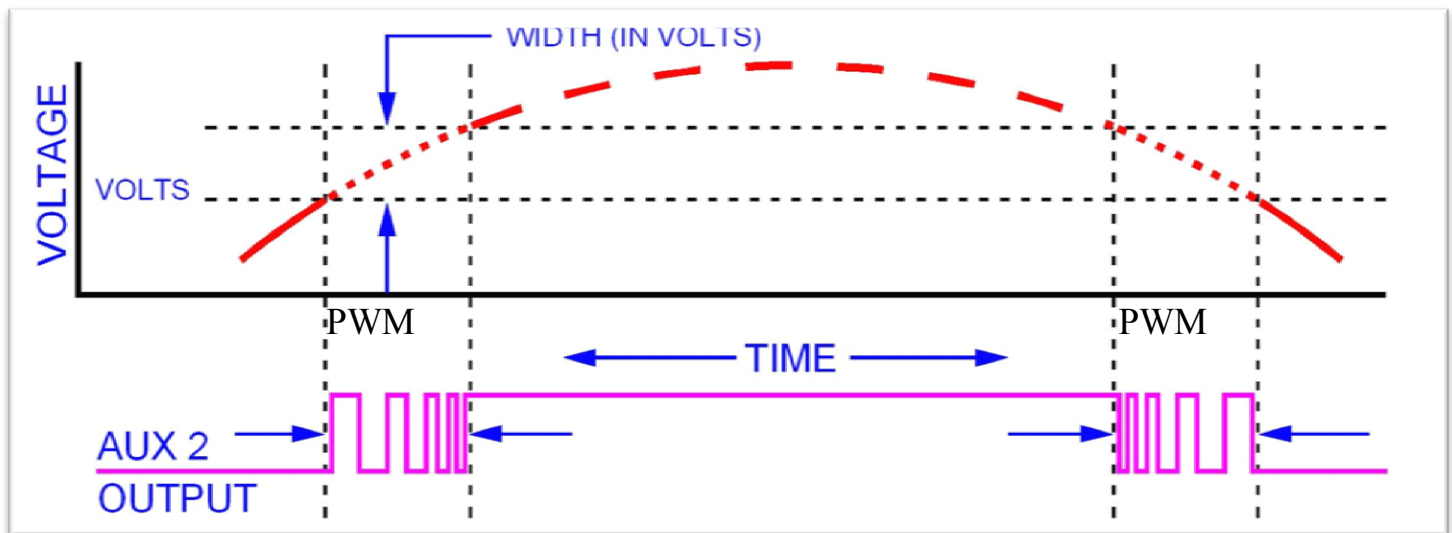

Diagram 5

Setting the MNGP features

The Classic comes with an integrated “MidNite Graphics Panel” (MNGP), which is the primary interface to the Classic. Setting up contrast, backlight and volume is simple; just follow the steps below.

- ❖ Push the Main Menu button.
- ❖ Scroll left or right to highlight “Misc” and push the Enter button.
- ❖ Use the left and right arrow keys to select the feature to set and press the Enter button
- ❖ Press the up and down buttons to adjust
- ❖ Press Enter to save

Use the diagram below for MNGP reference.

Figure 19

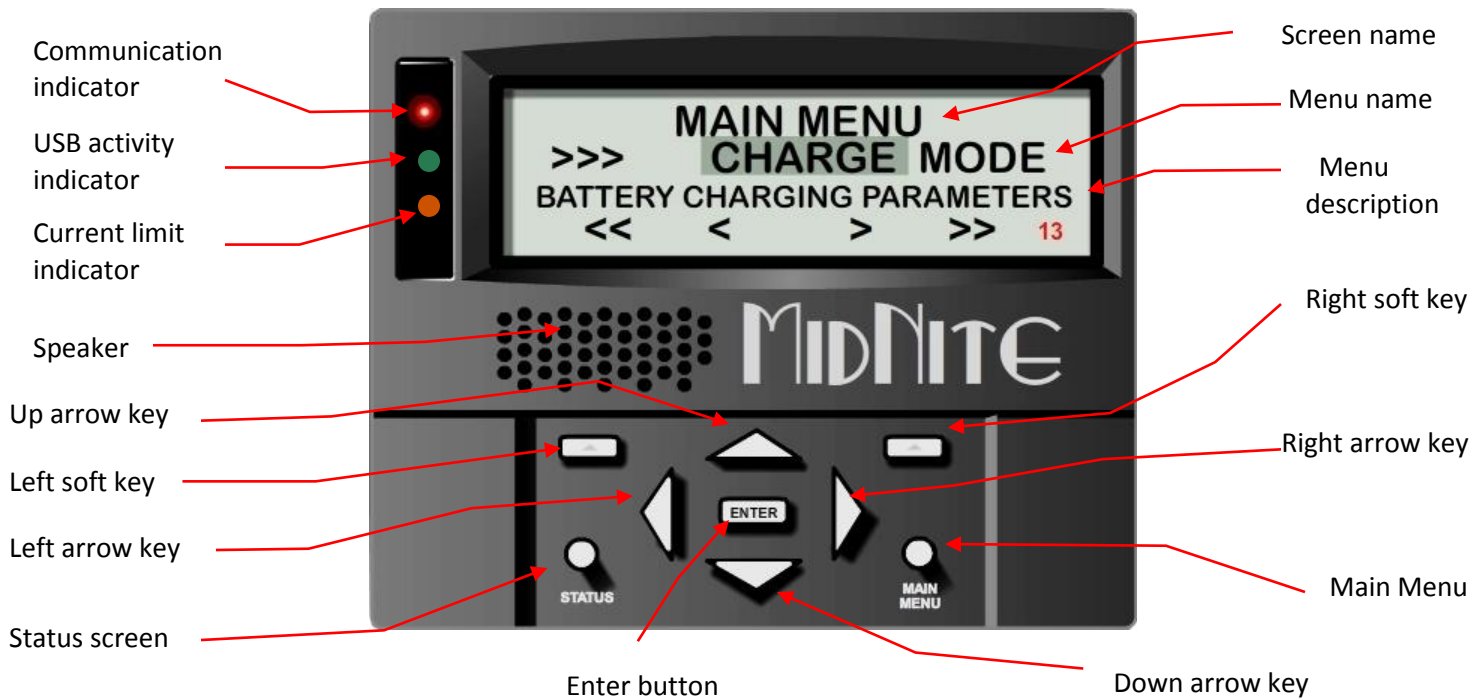

Navigating the Menu

- ❖ Push MAIN MENU
- ❖ Push right and left buttons to see the different menus
- ❖ To return to the status screen push STATUS button

* To navigate from one end of the main menus to the other end push the top right or left buttons. Below the name of the menu is a description of the menu. Pushing the left and right buttons will enable you to see all the main menus provided. Inside some of these main menus will be sub-menus to adjust the parameters of the selected feature.

Here is an overview of these menus:

<<CHARGE —MODE—AUX—MISC—LOGS—TWEAKS—TEMPS—NET>>

Below each of the menu names is a row with a description of the menu inside. To enter a menu, the name of the menu has to be highlighted. Pushing ENTER will show the submenus. The up and down arrow keys are enabled for easier navigation. Highlighting a sub menu and pushing ENTER will take you inside the submenu where you will be able to change the parameters of the unit. To get out of the submenus push MAIN MENU, this will take you out of the submenus one at a time every time you push it. See page 77 for entire Menu Map.

Viewing Other MidNite Products on the Display

Coming Soon.....

Connecting the Classic to Two MNGPs/Network cable

The Classic can be controlled with two MNGPs at the same time. This will help when the Classic is in a shop and there is a considerable distance between the Classic and the controlling point (office, inside house, garage etc.). Instead of going to the Classic to check status or to change a setting, the user can run a cable to the controlling point and see the Classic in a second MNGP. The cable is a six wire phone cable. Connect one side of the extension cable to the jack in the Classic labeled SLAVE/OUT and the other end to the second MNGP. Since the Classic transmits power and data signals through the phone cable to the MNGP the length of the cable is limited to 100ft.

MidNite Solar only offers a 3ft as an optional accessory. If you are making your own cable be sure to insert cable end all the way into the phone terminal to get a good contact. Use the phone crimping pliers to crimp both ends of the cable.



Figure 21



Figure 20

We recommend using flat phone cable for extension, just because it is easier to work with. Use the two pictures above as reference. Make sure the color and position of the wires are as shown in the diagram below. Use terminal connector tab as reference.

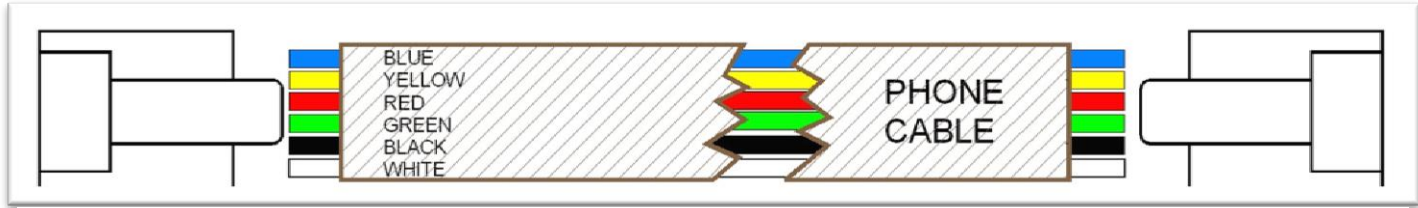

Diagram 6

Arc Fault

Because safety is not an option, the Arc Fault Detector is a unique safety component included in every Classic. The engineers at MidNite take action as the 2011 NEC code requires. The Classic is the first charge controller in the world to successfully stop a series arc. The Classic can detect an arc in less than 100mSec. From low power arcing to devastating high power arcing, the Classic will detect and shut down with an audible and visible alert to announce that there is a problem in the PV side of the system. When an arc is detected the Classic has to be manually cleared.

Resetting the Arc Fault Detector after detection has occurred: The first thing to do is find and fix the actual arcing wire, terminal, splice etc. The Classic needs to be powered down completely for 15 seconds and then powered back up. Do this by turning the DC source (PV, Wind or hydro etc.) breaker off. Then turn off the external battery breaker. Then simply turn the 2 breakers back on starting with the battery breaker.

The arc fault module has three adjustable parameters consisting of: MODE, TIME & SENSITVY

MODE: Is assigned as a 1 from factory default and it should stay that way unless instructed by MidNite Solar.

TIME: This sets the length of the arc the Classic has to monitor before tripping the Arc fault detection. This parameter is set to 4 from the factory.

SENSITIVITY: This parameter determines how sensitive the Arc fault detector will be 1 being the most sensitive and 15 the least. This parameter is set to 10 from the factory.

Figure 22

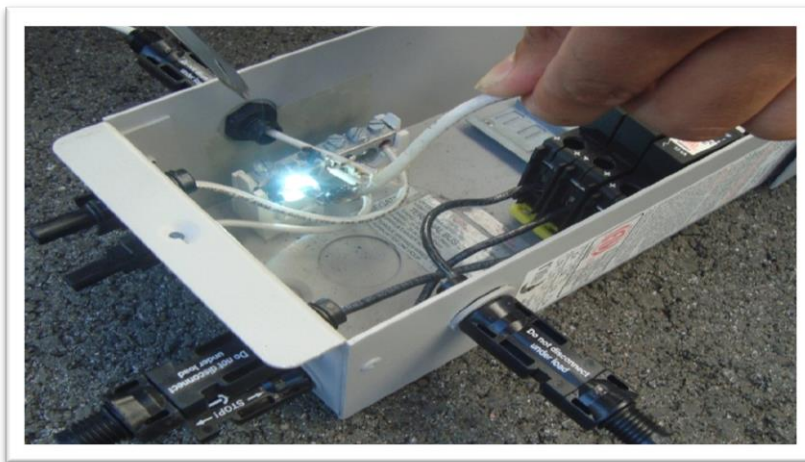

If you experience nuisance tripping you can raise the sensitivity one digit at a time. Follow the instructions below to make adjustments or disable Arc fault. As a last resort, you may disable Arc fault if your system cannot work with the arc fault detector.

To change the parameters of the Arc Fault, follow the steps below:

- ❖ Press Main Menu
- ❖ Scroll to the right or left until TWEAKS is highlighted and press ENTER
- ❖ In TWEAKS press the right soft key to get to the BITS menu
- ❖ In BITS press the right soft key to get to ARC ADJ
- ❖ In this menu use the left and right keys to select the feature to adjust
- ❖ Use the up and down arrow keys to change the parameters

In order for the Classic to read the new settings you must power cycle the Classic. Do this by turning the DC source (PV, Wind or hydro etc.) breaker off. Then turn off the external battery breaker. Than simply turn the 2 breakers back on starting with the battery breaker.

View Faults and Warnings

The Classic has some helpful safety features including the GFP (Ground Fault Protection) and AFD (Arc Fault Detector). When one or more faults are detected the Classic will stop outputting power and display a fault message in the bottom right corner of the home screen (STATUS).

View Logged Data

The Classic logs 380 days' worth of data in its memory. The data logging in the Classic has two modes and frequency of data capture.

DAILY HISTORY

Is captured once each day and is saved at night, after 2 hours of no activity when the PV input voltage is below battery voltage for solar, or in modes that do not necessarily rest at night, like wind or hydro, the capture will happen once every 24 hours. Data logged each day is kilowatt-hours, Float time in hours and minutes, the maximum power output for the day, maximum FET temperature inside the unit, maximum PV or input voltage and maximum battery voltage for the day.

HOURLY HISTORY

Also referred to as "Short term History" is captured once every five 5 minutes anytime the Classic is not resting (when it is charging). Data logged every 5 minutes is power, input voltage, battery voltage, Charging Stage, amps out and kW-Hours.

A time and date stamp is associated with each data entry in both Daily and Hourly history logs. The main time/date stamp for each data logging mode is Date for daily history and Time for recent history although both time and date are stored and displayed for each logging mode.



Screenshot 3

When entering the "LOGS" menu, you will see two items displayed there. The top line is lifetime kW-Hours for the Classic and below that is time spent in float today. (Note: Float, Absorb, Bulk and EQ time is also viewable in the "TIMER VU" sub-menu of the "ChgTime" menu in the main CHARGE menu) Pressing the SOFT LEFT key enters the DAILY history data viewing menu. Similarly, pressing the SOFT RIGHT key enters the HOURLY recent history data viewing menu.

In the DAILY menu, the LEFT side category of information displayed can be changed by pressing the UP or DOWN arrow keys. Switching over to the RIGHT side of the screen by pressing the RIGHT arrow key highlights the DAY change key. Pressing the UP key decrements the date (goes back 1 day) and displays that capture date above the word "DAY". There are 380 days of information stored in the Classic. After 380 days are captured and stored, the oldest data stored will be overwritten as new daily data fills in as the most recent data.

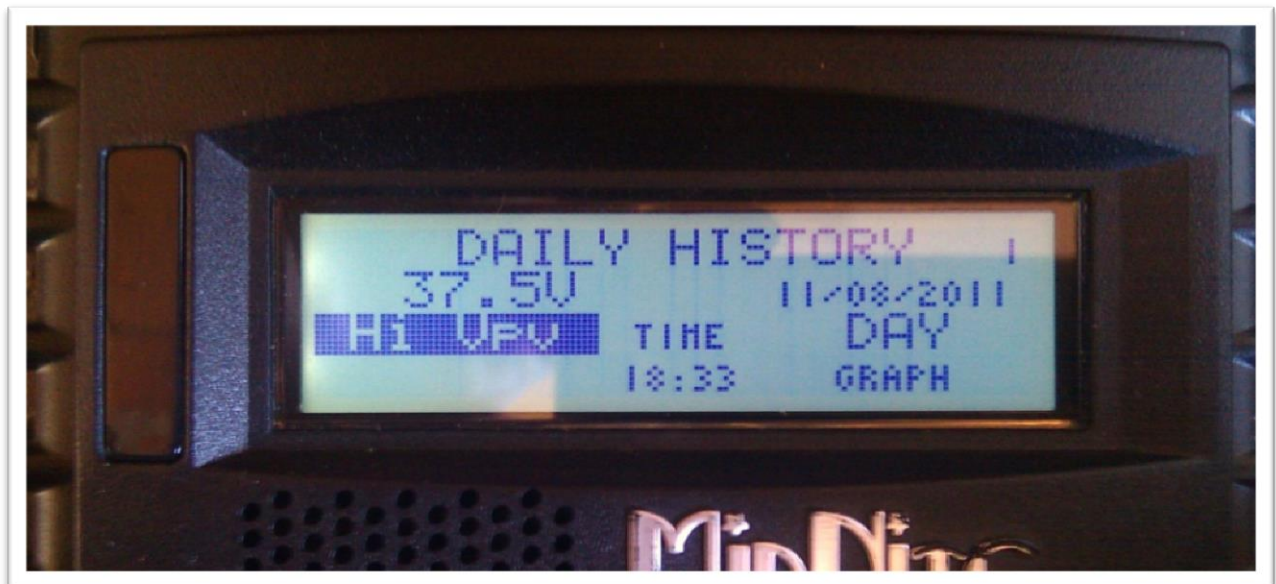

Screenshot 4

The HOURLY log menu (actually captured every 5 minutes), works very similar to the DAILY log menu, except that the time stamp above the word TIME is the time, shown in 24 hour format, that the data was captured that day. The category of data captured is of course more suited for minute by minute capture rather than the maximum data statistics captured on a day by day basis in the DAILY log screen. The left side of the recent history text log screen can be individually viewed by selecting the left side and pressing the UP/DOWN arrow keys to show the power, voltages, charge stage etc and various information captured at the time shown on the right side time selection.



Screenshot 5

At the bottom of the DAILY text log screen, the TIME the maximum statistics were stored is shown, whereas at the bottom of the HOURLY text log screen, the DATE of the capture is shown. Again, if for some reason the year of the time stamp was less than 2011, the time/date will alternate between INVALID and the time/date stamped along with that data and does not necessarily mean the data itself is not correct. If the data is all zeros and the year is shown as 2000, the data IS most likely invalid and not correct or the logging memory has not been filled yet. This is why the Classic powers up with the year 05/04/2003... It means that data was actually logged but the date was not set, whereas if it is showing 00/00/2000 it will normally mean that the data is just zero and therefore invalid data as well as invalid time and date.

The upper right corner of the text log screens displays a number from 1 to 380. This number shows the index or position of the data in the 380 data log time slots. The most recently stored data has an index of 1. Two data points ago shows an index of 2, etc. This index goes for either Daily History or Recent History text log viewing screen.

Graphical Logging Display modes

Both DAILY and HOURLY logging can also be viewed in a graphical manner. While in the text viewing log screen, pressing the Soft Right key labeled "GRAPH" will bring up this view screen. The HOURLY view is also available in the main status cycle of screens, changed by repeatedly pressing the STATUS key, just after STATUS TWO screen. This is labeled as "SHORT TERM HISTORY" in the STATUS screens.

A summary of the next Status screen will be shown while holding the status button before releasing it and entering that next status screen. This also goes for the Recent History graph screen in Status.

Each data point shown in the graphical view screen is shown as a dot. There are a maximum of 96 dots, appearing horizontally per screen with some information about each dot shown on the left side of the screen. An individual data point can be selected for investigation by moving a small, flashing once per second vertical cursor horizontally across the graphed data by using the Left and Right arrow keys. The most recent data is shown on the right most side of the first screen. The cursor first appears around 20 dots or data points from the right side of the first screen. (About 20 data points ago in history).

To scroll the data viewed one third of a screen to the left, hold the "Shift" key and the "Soft Left button", down and also tap the "Left arrow key". Each press of this combination of buttons will scroll the graphical view horizontally another 1/3 screen. Holding the Shift key and Right arrow key on the most recent data screen will push the cursor up against the right side and onto data point one.

Pressing the Up arrow button will change the data viewed to the next category. For instance, in the Recent history graph screen, the displayed data will change from Power to input voltage, battery voltage and kW-Hours. Pressing the Down arrow key will bring the category of data back down again. A very brief 5 or 6 character annunciator displayed in the upper left corner tells us what category of data the graph is showing us. The number just below this 5 or 6 character descriptions is the actual number in volts or watts or applicable unit of data displayed at that cursor position centered on the dot of the graph. The third line down on the left side of the recent data screen shows the time stamp of that data where the cursor is positioned on the graph. Finally, the bottom left of the graph screen alternates between two indicators. One is the charge stage at the cursor position and the other is the scaling of the vertical axis of the graph. Power for instance, can show a very wide range of values and power lends itself better to using a logarithmic vertical scale, shown as LOG. Voltage and other data shows up fine using a LINEAR vertical axis scale and is spelled out on the lower left of the graphic screen.



Screenshot 6

The Date of the particular selected cursor positioned data point is shown on the bottom middle of the graphic screen. Moving the cursor left or right using the Left and Right arrow keys, selects the next data points to the left or to the right of the present cursor position.

The flashing cursor is short and may be hard to detect at first so you may have to look for it. The cursor aligns and centers itself right on the dot itself that is selected.

The bottom date or time displayed may tend to obscure the data line graphed behind it. The time/date and the graph data will be mixed together about a second after the date/time is drawn on the bottom of that graph log screen. If, for some reason, the graphic log screen display shows bogus data or dots that look like they should not be shown, simply press the Enter button and the screen will be quickly erased and re-drawn without the extra lines or dots.

There may or may not be any valid data past a certain point to the left if the unit is fairly new. The data shown in unused spots may be zero, or it may be off the screen and not viewable. As time goes on and new data is acquired, those unused data points will start to appear and be valid. Of course, the Daily history will take many days to fill in, where the Recent hourly (minutes really) data will fill in after a few hours or maybe a day or two depending on how long the Classic is on and running for that day. Remember, the Classic does not normally log data while it is in "Resting" mode.

CAUTION: Attempting to download the Logs using the Local app while viewing the Logs on the Display will cause the Classic to reboot.

Classic Lite Programming

The Classic Lite is based on our Classic charge controller. It has all of the same features, Power and versatility minus only the Graphic Display, and arc fault detection.

It can be used in all of the same applications. For the advanced features to be accessed and programmed, you will need to use the Local Application software (available at www.midnitesolar.com) and a PC or a MidNite Solar MNGP Graphics Panel, or the Graphics panel of another Standard Classic in the system. If desired, the Classic Lite can be used with an MNGP instead of the supplied MNLP controller.

LED explanations

The Lite control panel (MNLP) has 6 status LEDs to indicate various modes of operation as well as faults. There are three behind the small window on the upper left.

The top Orange status LED will light solid to indicate that the controller is in Bulk Charge mode.

The center Yellow status LED will light solid to indicate that the controller is in the absorption stage.

The lower Green LED will light solid to indicate that the controller is in Float and blink slowly to indicate the controller is Resting due to low light.

All 3 of these status LED's will blink slowly to indicate "Wrong Code"; please see trouble shooting on page 71 for help with this.

There are also LED indicators for Current limit, Ground Fault and Equalize.

All LEDs blinking slowly indicate a loss of communication with the Classic. Check that the cable is plugged in to the top Jack on the Classic. If error persists try another cable or call Tech support for assistance.



Figure 23

Programming

There are four separate ways to program a Classic Lite.

1-The programming is done using Dip Switches under the front cover of the MNLP.

2-The Classic Lite can be programmed with an independent MNGP.

3-The Lite can be Networked with a standard Classic and programmed using the standard Classic's MNGP

4-The Classic Lite can be programmed using the Local App (Through the Ethernet connection) software available at www.midnitesolar.com

Dip Switches

Below you will find an Explanation of the Dip switches and the values associated with their settings. Up is on and down is off on the switches. To access the Dip switches you need to remove the front cover on the Lite display panel. Firmly grasp the left and right side of the cover and slide it off.



Figure 24

Now you will need to use the supplied tool (Toothpick) to place all 15 switches in the correct position. All the information on the switches can be found on the labels on the MNLP as well as in the tables below. Keep in mind if any of the switches are set to Custom the Lite display becomes a LED display only and you will need to use the included PC software or a MNGP to program the Classic.

Note: The Classic Lite will need to be programmed in “Custom Mode” for all applications other than Solar. Custom Mode is also required for programming the Lite with the Local App software.

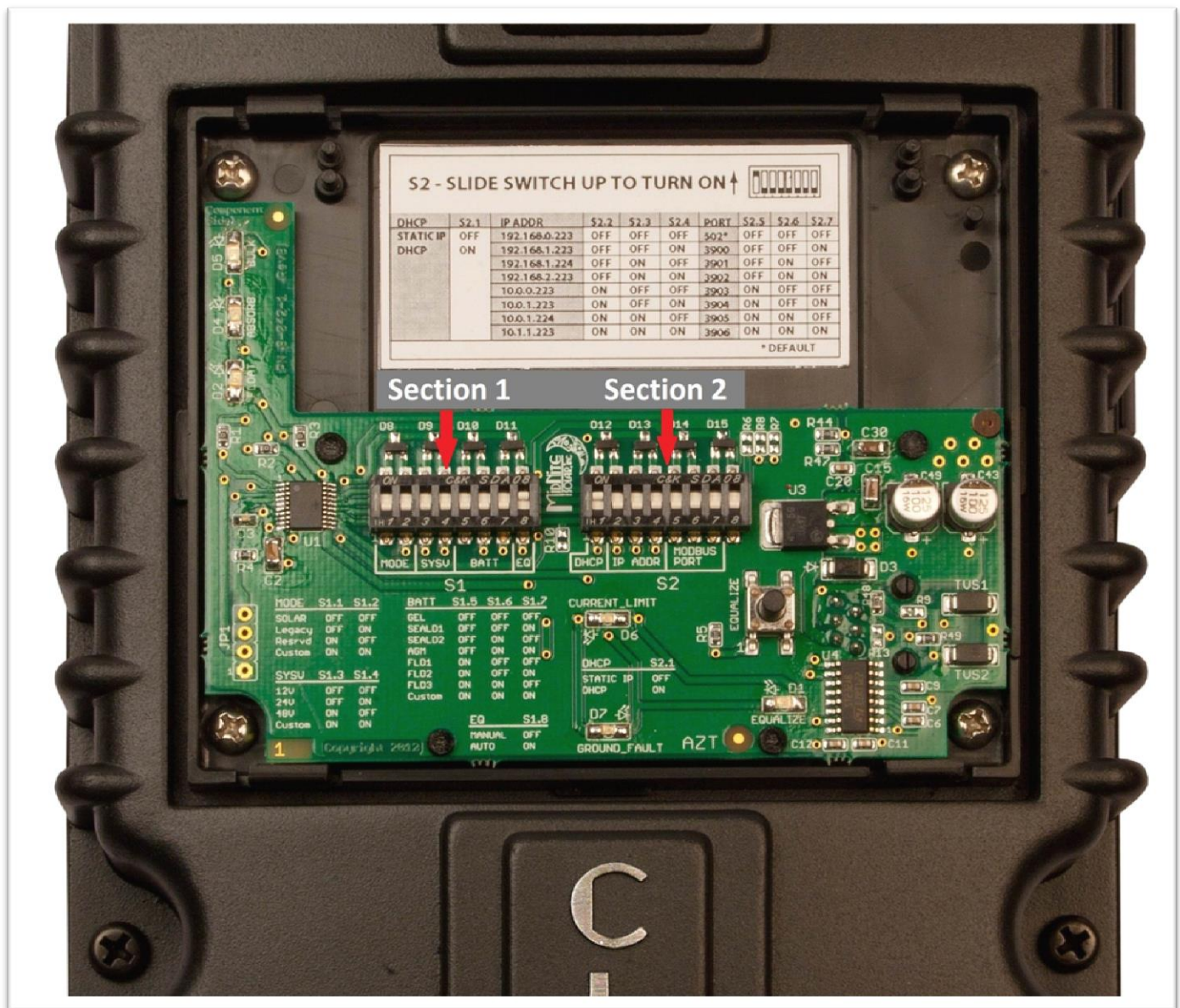

Figure 25

Section 1 Switch settings explained

Mode: Switches 1 and 2 (Section 1)

On Section 1, the first 2 Switches are used to select which Solar Mode will be used.

For “Solar” Mode: set switches 1 and 2 to OFF . This is the optimum setting for virtually all solar installations.

For “Legacy “ Mode: Set Switch 1 to OFF and Switch 2 to On.

Legacy Mode can be used in cases where the Open Circuit Voltage is close to the battery voltage. For example, a 22 volt open circuit array and a 12 volt battery. Or where there are mixed sizes of panels in an array. (Solar Salad)

When switch 1, 2, 3, and 4 are set to ON, the Lite is in “Custom Programming mode” and can be programmed using any of the other 3 methods.

Custom set up will be required for Wind, Hydro, Fuel Cell applications as well as setting up the Aux. output controls and for Battery voltages of 36, 60, and 72

System Voltage: Switches 3 and 4 (Section 1)

On Section 1, set Switches 3 and 4 to the appropriate positions (Found in the Chart) corresponding to your system's battery voltage. 12, 24, and 48 volt systems are included in this menu. 36 and 72 volt battery set up can be accomplished using the Custom set up method.

Battery Type: Switches 5, 6, 7 (Section 1)

Switches 5, 6, and 7 allow you to select from 7 different battery types and charging profiles. These profiles can be found in the 2 charts on the following pages. These should cover most common applications. If slightly different voltages are desired, this can be done using Custom Mode and programming methods 2, 3, or 4.

Auto Equalize: Switch 8 (Section 1)

Switch 8 is used to select Automatic equalization.

In the OFF position, a manual equalization cycle, if desired, is selected by pressing the “Equalize” button on the MNLP for 3 seconds. To Cancel Equalize, Press Equalize button for 3 seconds.

With Switch 8 in the ON position, the Lite will attempt to equalize the batteries automatically.

The equalize interval is dependent upon the battery type selected. Please refer to:

“Dip switch battery settings for 12, 24, or 48 volt batteries” for specific information on this function.

Section 2 Switch settings explained

DHCP or Static IP address Switch 1 (Section 2)

On Section 2, Switch 1 when on will enable DHCP. This will allow the Router on the network to assign the Classic Lite an IP address. When off it sets the Classic to a static IP address that will be determined by Switches 2, 3 and 4.

IP Address Switches 2, 3 and 4 (Section 2)

On Section 2, Switches 2, 3 and 4 will set the Static IP Address of the Classic Lite to the address shown in the table below if Switch 1 is set to Off for Static IP.

ModBus Port Switches 5, 6 and 7 (Section 2)

On Section 2, Switches 5, 6 and 7 set the ModBus port of the Classic Lite. The values that correspond to the switches are found in the table below.

The actual Labels that are on the inside of the MNLP.

S1 - SLIDE SWITCH UP TO TURN ON ↑ 

MODE	S1.1	S1.2	SYSV	S1.3	S1.4	BATT	S1.5	S1.6	S1.7	EQ	S1.8
SOLAR	OFF	OFF	12V	OFF	OFF	GEL	OFF	OFF	OFF	MANUAL	OFF
LEGACY	OFF	ON	24V	OFF	ON	SEALD1	OFF	OFF	ON	AUTO	ON
RESRVD	ON	OFF	48V	ON	OFF	SEALD2	OFF	ON	OFF		
CUSTOM	ON	ON	CUSTOM	ON	ON	AGM	OFF	ON	ON		
						FLD1	ON	OFF	OFF		
						FLD2	ON	OFF	ON		
						FLD3	ON	ON	OFF		
						CUSTOM	ON	ON	ON		

S2 - SLIDE SWITCH UP TO TURN ON ↑ 

DHCP	S2.1	IPADDR	S2.2	S2.3	S2.4	PORT	S2.5	S2.6	S2.7
STATIC IP	OFF	192.168.0.223	OFF	OFF	OFF	502*	OFF	OFF	OFF
DHCP	ON	192.168.1.223	OFF	OFF	ON	3900	OFF	OFF	ON
		192.168.1.224	OFF	ON	OFF	3901	OFF	ON	OFF
		192.168.2.223	OFF	ON	ON	3902	OFF	ON	ON
		10.0.0.223	ON	OFF	OFF	3903	ON	OFF	OFF
		10.0.1.223	ON	OFF	ON	3904	ON	OFF	ON
		10.0.1.224	ON	ON	OFF	3905	ON	ON	OFF
		10.1.1.223	ON	ON	ON	3906	ON	ON	ON

* DEFAULT

10-194-1 REV - DCA 4-06-12

Table 5

Section 1 Switches 1 through 8

Section 1

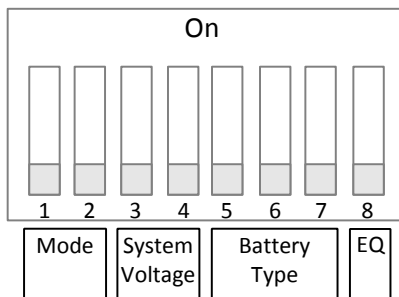

Section 2

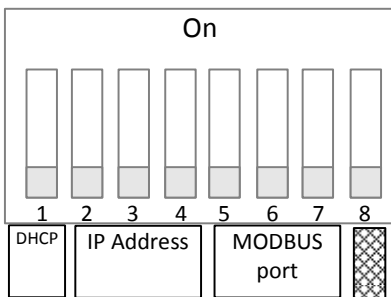

Section 1			
Mode			
Mode	Switch 1	Switch 2	
Solar	Off	Off	
Legacy	Off	On	
Reserved	On	Off	
Custom*	On	On	
System Voltage			
System Voltage	Switch 3	Switch 4	
12V	Off	Off	
24V	Off	On	
48V	On	Off	
Custom*	On	On	
Battery Type			
	Switch 5	Switch 6	Switch 7
Gel	Off	Off	Off
Sealed 1	Off	Off	On
Sealed 2	Off	On	Off
AGM/Flooded	Off	On	On
Flooded 1	On	Off	Off
Flooded 2	On	Off	On
Flooded 3	On	On	Off
Custom*	On	On	On
Auto Equalize			
	Switch 8		
Manual	Off		
Auto	On		

Table 6

Section 2 Switches 1 through 7

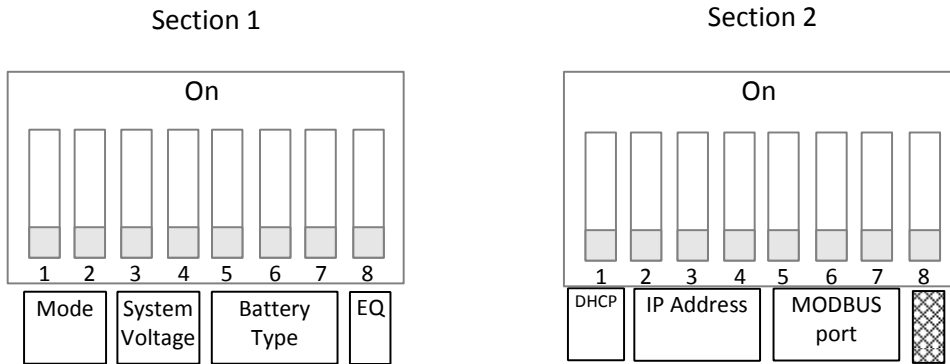

Section 2			
DHCP or Static IP address			
Switch 1			
Static IP	Off		
DHCP	On		
IP Address (only if DHCP is set to Static IP)			
	Switch 2	Switch 3	Switch 4
192.168.0.223	Off	Off	Off
192.168.1.223	Off	Off	On
192.168.1.224	Off	On	Off
192.168.2.223	Off	On	On
10.0.0.223	On	Off	Off
10.0.1.223	On	Off	On
10.0.1.224	On	On	Off
10.1.1.223	On	On	On
MODBUS Port			
	Switch 5	Switch 6	Switch 7
502 (default)	Off	Off	Off
3900	Off	Off	On
3901	Off	On	Off
3902	Off	On	On
3903	On	Off	Off
3904	On	Off	On
3905	On	On	Off
3906	On	On	On

* Setting any value to custom effectively disables the MNL Lite as a controller (LED's and Equalize button still work) and requires you to configure the Classic using a PC or MNGP.

Table 7

Battery voltage and time settings

Battery Type	Absorb Voltage	Float Voltage	Equalize Voltage	Absorb Minimum Time (minutes)	Absorb Maximum Time (minutes)	Equalize Time (minutes)	Equalize Interval (days) ⁽³⁾
12 Volt battery							
Gel	14.0	13.7	-	30	90	-	-
Sealed 1	14.2	13.7	14.4	30	90	60	28
Sealed 2	14.3	13.7	14.6	30	90	60	28
AGM	14.4	13.7	15.1	30	120	120	28
Flooded 1	14.6	13.5	15.3	30	120	120	28
Flooded 2	14.7	13.5	15.4	30	120	120	28
Flooded 3	15.4	13.4	16.0	30	180	180	14
Custom	-	-	-	-	-	-	-
24 Volt battery							
Gel	28	27.4	-	30	90	-	-
Sealed 1	28.4	27.4	28.8	30	90	60	28
Sealed 2	28.6	27.4	29.2	30	90	60	28
AGM	28.8	27.4	30.2	30	120	120	28
Flooded 1	29.2	27	30.6	30	120	120	28
Flooded 2	29.4	27	30.8	30	120	120	28
Flooded 3	30.8	26.8	32	30	180	180	14
Custom	-	-	-	-	-	-	-
48 Volt battery							
Gel	56	54.8	-	30	90	-	-
Sealed 1	56.8	54.8	57.6	30	90	60	28
Sealed 2	57.2	54.8	58.4	30	90	60	28
AGM	57.6	54.8	60.4	30	120	120	28
Flooded 1	58.4	54	61.2	30	120	120	28
Flooded 2	58.8	54	61.2	30	120	120	28
Flooded 3	61.6	53.6	64	30	180	180	14
Custom	-	-	-	-	-	-	-

⁽³⁾ If **Auto Eq** is set to **Auto** then the Equalize interval is in effect. If **Auto Eq** is set to **Manual** the Equalization stage will not occur unless started manually.

Table 8

Using MNGP Remote to Program a Classic Lite

The Classic Lite can be programmed using an MNGP remote. This is an easy way to get into and program not only the basic functions, but the advanced features as well. In Dip Switch Section 1 set DIP Switches 1, 2, 3, and 4 to ON. This will tell the Classic Lite's MNLP display to allow custom programming. Next, remove the plug from the back of the MNLP and plug it into the MNGP. Now, you basically have a Standard Classic. The programming for this is found in the Standard Classic Manual. Once programmed in this way, the MNGP can be removed, and the MNLP replaced. All functions, and voltages programmed into the Classic will now be retained in permanent memory.

NOTE: All Firmware versions need to match to mix MNGP's from one Classic to other Classics etc.

Programming the Lite with a Networked Standard Classic

The third method of programming is to use a Standard Classic in the system to program the Lite in a simple "Follow-Me" network. In Dip Switch Section 1 set DIP Switches 1, 2, 3, and 4 to ON. This will tell the Lite's MNLP display to allow custom programming. You will need to use the MNGP from the standard Classic to set the Address and Follow-Me parameters. See the Follow-Me section on page 15 for full details.

NOTE: All Firmware versions need to match to mix MNGPs from one Classic to other Classics etc.

Programming the Lite with the Local App

You can use the Local Application software available at www.midnitesolar.com to program it as well. You will need the serial number of the Classic to unlock the two way functionality of the Local App. Please see the Local App instructions for more details. You will also need to set the Dip Switches to Custom.

Clearing Faults

If either the Ground Fault or Current Limit fault light is lit, then the equalize button can be tapped to clear these faults. If the fault condition has not been removed, however, then the light will re-illuminate indicating that a fault condition is still present.

Notes on the Lite

If anything is set to Custom, then the MNLP lite will not send any programming data to the Classic. So a Custom setting effectively disables MNLP Lite Control over the Classic requiring the user to use a PC or MNGP to configure the Classic.

Note: The Custom setting still allows full function of the LED's and the EQ button

Explanations of Solar and Legacy

Solar

This is the default mode for PV systems and has a very fast sweep (typically a half of a second or less) that will re-sweep at user adjustable sweep intervals, unless the Classic finds that it needs to do a sweep on its own because of changing conditions. The timed sweep interval is user adjustable and is in units of minutes. SOLAR mode is typically best for PV systems, especially if there is partial shading at times during the day. SOLAR mode is best suited for shaded or un-shaded PV arrays that are at least one nominal voltage above the battery voltage. For severe partial shading or PV arrays with nominal voltage equal to battery voltage, you may also want to try Legacy P&O (Perturb and Observe) MPPT mode.

Legacy P&O

Legacy P&O (Perturb and Observe) mode is a slow tracking mode similar to the Micro Hydro mode but with the difference that it is slightly faster and optimized for Solar. Legacy mode can be very useful for arrays that experience heavy shading issues as well as PV arrays that have a low voltage. If the array has a VOC (Open Circuit Voltage) of less than 125% of the battery voltage, Solar mode will not work as well so Legacy will be a better choice.

Uploading New Firmware to the Classic

The Classic has the ability to have its firmware updated with a standard USB cable and a Windows based PC. The USB cable is Standard to Mini B. Please see www.midnitesolar.com and click on the Software tab for the firmware and instructions. Due to the various different Windows configurations we will not go into detail in the Classic Manual. The Firmware upgrade is fail safe so if the wrong code is installed the Classic simply says "Wrong code" prompting you to load the correct code. Also if the upload is interrupted for whatever reason simply start over.

WARNING ! The Classic's USB port is NOT isolated from battery negative. This is typically only an issue on positive ground systems or systems with a tripped ground fault protection device. Care must be taken that a computer connected to the Classic's USB port is either isolated from ground and the Classic's negative or that the computer's USB negative is common with the Classic's negative and ground.

WARNING ! You cannot turn a Classic 150 into a Classic 200 for example using new software the internal components are also different.

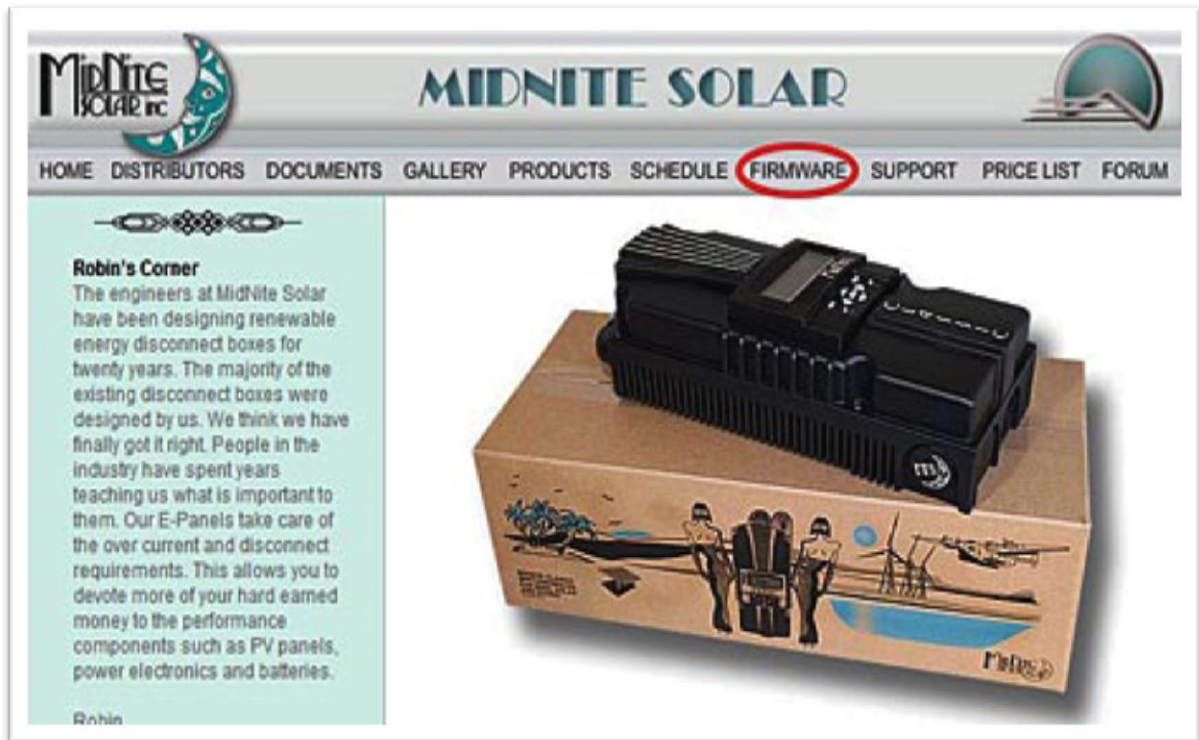

Figure 26

Prepare Classic charge controller for update.

1. Go to your electrical panel and identify the input and output breakers for the Classic. Turn them off. Wait 3 minutes for the Classic to de-energize.



Figure 27

2. Remove the four screws holding the front cover of the Classic charge controller. **Do not let the front cover hang by the cable.**



Figure 28

3. Holding the front cover with one hand, place a screw in the top left hole of the front cover and screw it into the top right hole of the back casting.

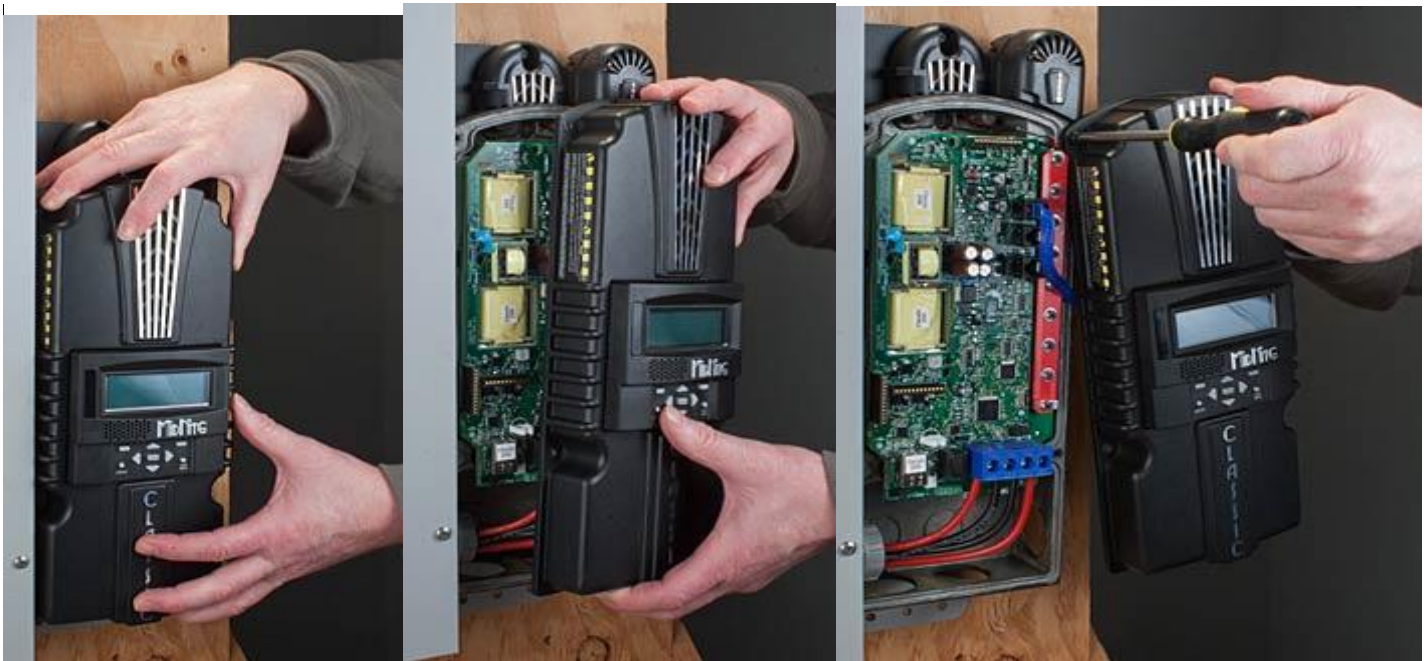

Figure 29

4. Use any Standard to Mini B USB cable to connect the Classic to the PC. The smaller terminal connects to the USB port on the Classic. The USB port is located on the right side of the Ethernet Jack in the lower part of the Classic.

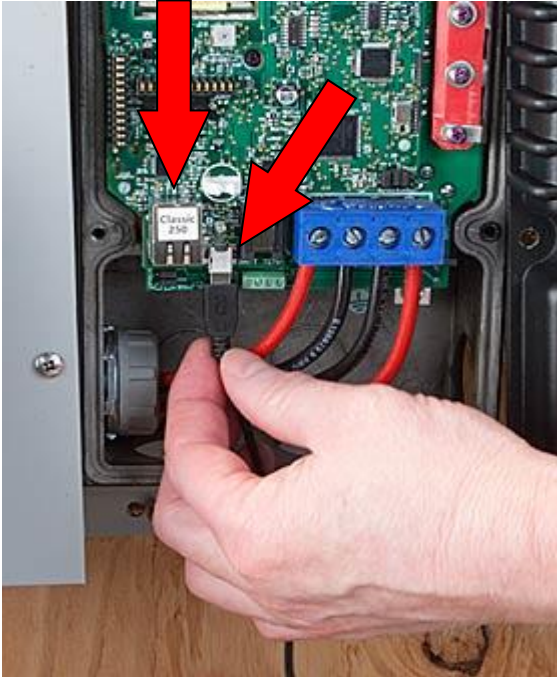

Figure 30

Connecting the Classic to the Internet

Networking

The Classic supports standard 10/100-base T Ethernet networks. For Gigabit networks you will need a common network switch that is capable of mixed mode operation. The Classic may also be placed on a, b, g, or n wireless networks by using a wireless network bridge device.

Depending on your network you may use one of the topographies detailed in Example 1 through 4 below. Note that the switch may be self-contained or, in many cases, may already be integrated into your cable or DSL modem. Refer to Figure 30 for Ethernet connector location in the Classic.

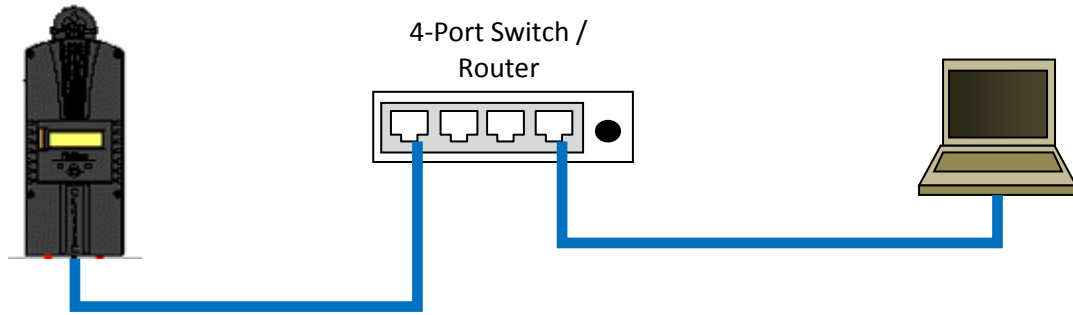

Example 1 Local network through switch. In some cases you may be able to connect Classic directly to your PC; however, this is not a recommended topography.

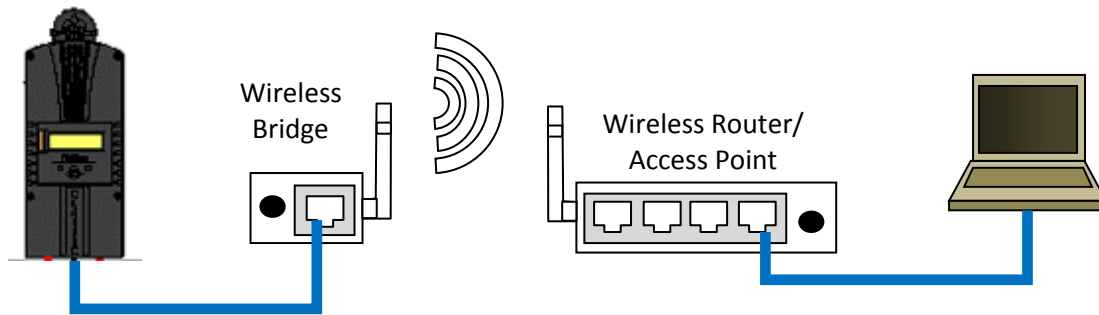

Example 2 Local network through wireless bridge.

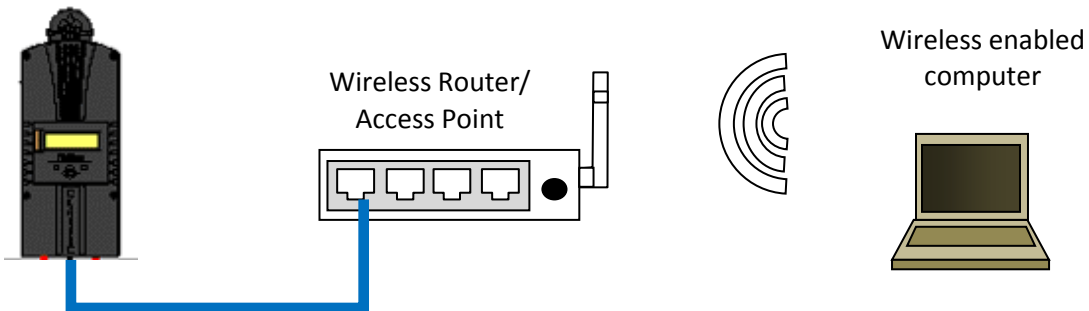

Example 3 Local wireless network

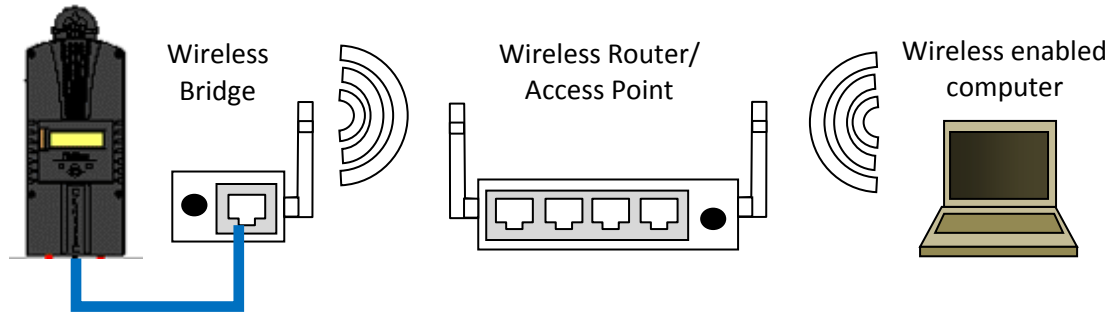

Example 4 Local wireless network through wireless bridge

There are many different configurations possible when it comes to networking that are beyond the scope of this manual. The basic ones in the above figures should help get you going.

Network Setup through the MNGP

The Classic's Ethernet capabilities may be configured using the Network menu on the MNGP. From the main menu select "NET".

There are three screens that configure network settings. Table 9 decodes the descriptions from the MNGP's small screen.

MNGP	Long-hand	Description
Mode	IP address configuration mode: DHCP/Static	The Classic supports both static and dynamically (DHCP) allocated IP addresses. If you are unsure which to choose try DHCP first. If you have trouble move to the troubleshooting section.
IP	IP Address	The Network address of the Classic
SN	Subnet	The Subnet or address class specifier
GW	Gateway Address	The address of the network's gateway device
D1	Primary DNS Address	Primary Address lookup device
D2	Secondary DNS Address	Secondary Address lookup device (optional)
Web Access	-	Enables or disables the Classic's online web service feature
MA	MAC Address	The hardware or Ethernet address of the Classic
DI	Device ID	The unique MidNite Solar address of the Classic

Table 9

DHCP

The Classic supports Dynamic Host Configuration Protocol (DHCP) in which all networking settings are derived from a DHCP-enabled router. This is the simplest configuration method and recommended unless you explicitly need a statically allocated IP address for your Classic. In this mode all other settings are automatically configured and are read only (informational) with the exception of the Web Access feature.

- Press Main Menu
- Scroll to NET menu and press the Enter button
- Highlight and select DCHP

Please note that the Classic's DHCP protocol implementation usually takes a few seconds up to a minute to update

the network settings. If the network settings do not update within a minute, please consult the troubleshooting section.

Static IP

The Classic supports static IP address allocation. In this mode you can assign the Classic a specific IP address. This lets you set up things like port forwarding from your router or for networks with static IP allocations.

- Press Main Menu
- Scroll to **NET** menu and press the Enter button
- Highlight and select **STATIC**
- Using the left and right keys, navigate to the settings to change and use the up and down arrows to adjust the desired fields.
- Press the ENTER button at any time to commit the settings to the Classic's Flash memory.

Please note that static settings span two menu screens. You may use the soft keys to navigate between the two menus. Pressing the ENTER key in either menu saves all settings to Flash memory.

For convenience when you manually set the device's IP address the Gateway and Primary DNS addresses follow the change. See the following sections for details on each of these fields.

IP Address

This is the local network address of your Classic. It usually takes the form "192.169.0/1.x" or "10.0.0.x" depending on your networking equipment. You must be careful when selecting this address. If it does not match your network subnet then the classic will not be able to communicate with the network. If it is the same as another device on the network then collisions will occur causing both devices to act erratically.

Check your router settings or ask your network administrator which local address to use. Also refer to the troubleshooting section for tips.

Subnet

This refers to the class of local network you are using. This depends on your network hardware but most users should use "255.255.255.0" for this field.

Gateway

This is the address of your router or modem – the device which is connected directly to the Internet proper. It will usually take the form 192.168.0/1.1 or 10.0.0.1 depending on your network configuration and hardware. Check your router settings or ask your network administrator which local address to use. Also refer to the troubleshooting section for tips.

DNS 1

The DNS is the means by which human-readable internet addresses are resolved to actual IP addresses on the network. These values can usually be set identically to the gateway address depending on your network hardware. If your ISP provides you with specific DNS servers then use those addresses in these fields instead.

Example 1: Your gateway is a DSL modem with address 192.168.1.1. If your ISP has not given you explicit DNS servers to use then set the **D1** field to 192.168.1.1

Example 2: Your gateway is a cable modem with address 10.0.0.1. Your ISP has specified primary and secondary DNS server addresses of 11.22.33.44 and 11.22.33.55, respectively. Set the **D1** address to 11.22.33.44 and the

Web Access

MidNite Solar will be offering a free web service with which you can access your Classic from a web page from anywhere in the world simply by pointing your favorite web browser to

<https://www.mymidnite.com>

Instructions on setting up your My MidNite account can be found on the above webpage.

All communications between the Classic and MidNite Solar's server are encrypted using a strong session-based algorithm. To respect your privacy, however, it is required that you manually enable this feature if you'd like to use it.

In order to enable the web access feature:

- Press **Main Menu**
- Scroll to **NET** menu and press the Enter button
- Using the soft keys, navigate to the **ADVANCED** menu (**NET**→**NEXT**→**ADVANCED**)
- The **Web Access** option should be highlighted.
- Use the up/down keys to enable or disable the feature.
- After saving the change you will need to reboot the Classic by removing PV power and Battery power with the 2 disconnects and waiting for the screen to go dark. Wait 30 seconds and re apply PV and Battery power.

Note that the **Web Access** selection indicates the current setting of the feature: i.e. **ENABLED** means the feature is currently in operation.

Note also that you will need the values **MA** and **DI** handy in order to create an account on the My MidNite web site. This unique number pair identifies your particular classic to our server and helps to prevent malicious users from trying to access your Classic. The **DI** or (Device Id) is different than your Unit's Serial Number.

Local Network

Note that your Classic identifies itself by name to DHCP-enabled routers as "Classic". There is facility to change the name of a given Classic via the local and web-based interfaces as well as using third-party MODBUS software packages.

Advanced

The Classic advertises it's address every 10 seconds using the UDP protocol. Advanced users and programmers may use this feature to identify Classics on their network.

Positive Ground systems

When installing the Classic in a positive ground systems there are a few extra steps that need to be taken. The Ground fault jumper needs to be removed, and ground fault needs to be disabled in the menu. Refer to page Disabling GFP on page 24 for instructions on doing this.

The overcurrent protection needs to be done a little different as well. The input and output breakers need to be double pole breakers. Battery negative and positive conductor both need to be protected. Refer to Classic Breaker Sizing on Page 84.

IMPORTANT: Do not connect both positive battery and positive PV input to ground. One or the other positive (normally battery +) but not both, otherwise, the Classic input and output will be shorted.

HyperVOC™

HyperVOC is a unique feature the Classic has built in. HyperVOC refers to when the DC Input Voltage raises above the maximum operating voltage (150V, 200V, 250V, depending on the Classic model). HyperVOC gives you the flexibility to go up to the maximum operating voltage PLUS the nominal battery voltage. For example, the Classic 150 has an input voltage rating of 150 operating volts, if the Classic 150 is connected to a 48 volt battery bank, the HyperVOC voltage limit will be: 150V + 48V a total of 198 Volts that the Classic can withstand without damage. When the Classic input voltage rises above 150 volts it will switch off (stop outputting power). As long as the Classic is in HyperVOC mode, the microprocessor and all other functions like AUX will continue running. When the input voltage comes back down below 150v (or the rated operating voltage of the Classic, depending on model) the Classic will wake up and start charging again automatically. This could happen in a really cold morning with a system that has a Voltage Open Circuit (VOC) close to the maximum operating input voltage.

*Note 1. A **HyperVOC** message will be displayed on the bottom right side of the Status screen.*

Note 2. Max nominal battery voltage to be added is 48v

HyperVOC can be useful in overcoming an industry shortcoming in charging 48 volt battery's with standard panels. For example let's take a sample system with Solar World 165's that have a VOC of 44.1vdc. The industry has limited us to 2 of these panels in series making it hard to charge a 48vdc battery on hot summer days. With the Classic we designed in Hyper VOC to allow you to run 3 of these in series. 3 panels at 44.1vdc will give you a total VOC of 132.3vdc. When temperature compensated for cold climates to 125% gives you 165vdc. This is above the maximum safe limits for most controllers but falls well into the Hyper VOC range of the Classic. We do have to use Hyper VOC wisely though; if we abuse it the Controller will never wake up in colder weather.

Graphics Panel (MNGP) Programming Menu Options Details

Most settings can be accessed and modified. Navigate using the LEFT & RIGHT Arrows. Pressing [ENTER] takes you into that menu. The MAIN MENU Button also backs you out of any submenu. Use the soft-keys for options & views. Be sure to press [ENTER] to save changes before backing out of any menu/submenu.

Troubleshooting / FAQs

<p>How do I do a software Factory Restore on my Classic or Classic SL?</p>	<p>*Note this only works on the Classics with Displays not a Classic Lite with the MNLP (LED Panel) *Warning this will erase ALL settings. *Turn the PV breaker and Battery breaker off (What you don't have a breaker? Get one asap) and make sure the display has gone dark *Hold the left and right arrow and turn on JUST the battery breaker, Continue to hold the arrow buttons until you see the Quick Start pop up *Follow the on screen prompts to set up your controller.</p> <p>WARNING: You must get the battery charging voltages from the battery manufacturer and it is VERY important you do this and do not just leave it as default settings as it is likely this will undercharge and slowly destroy your batteries</p> <p>WARNING: The Clock is a 24 hr clock. Setting it off by 12hrs will cause it to reset to a new day at Noon.</p>
<p>How do I do a HARDWARE factory restore?</p>	<p>*Warning this will erase ALL settings. *Turn the PV breaker and Battery breaker off (What you don't have a breaker? Get one asap) and make sure the display has gone dark</p> <p>Do a hardware factory restore. There are 4 sets of jumpers directly above the blue terminal block. For the purpose of this we will call the left most jumper JP1 and the right most JP4 (actually labeled "Boot")</p> <ul style="list-style-type: none"> • Step 1- Turn the PV and Battery power off to the Classic and remove the front cover • Step 2- Locate the 2 jumpers JP1 and BOOT (JP4). Take the actual jumpers and keep them in your hand • Step 3- Turn the Battery power on to the classic • Step 4- within 1 minute place jumper JP4 on its two pins and then place jumper JP1 on its two pins. at this point the 3 leds on the top of the circuit board should flash back and forth for about 60 seconds. • Step 5- After the flashing stops power down the classic and remove JP1 and JP4 and stow them back on a single pin like they were. • Step 6- Put the front cover on and power up the Classic Lite. If you have the MNLP set to Custom you will need to go to the local app and reset the battery voltage and setpoints etc.
<p>What is a "VMM"?</p>	<p>*It has become industry slang for our factory restore "Vulcan Mind Meld" from the 2 fingers needed to push the arrows</p>

Classic will not power on. No Fans or life on power up.	<ul style="list-style-type: none"> *Check for reverse polarity on the Battery positive and negative terminals on the blue terminal block *Check for voltage on the Battery positive and negative terminals on the blue terminal block, if less than 10v charge the battery or find the bad connection
Classic Display is blank but the Classic is on	<ul style="list-style-type: none"> *Check that the blue display cable is plugged into the top jack on the main circuit board and the display *Try the middle jack on the circuit board *Try a different 4 conductor phone cable
Classic says "Resting" but the sun is out	<ul style="list-style-type: none"> *Resting indicates a lack of power available to the Classic. Verify you have voltage on the display under the "IN" that is at least 130% of the actual battery voltage at that time *Verify the charging mode is correct for the source as well as the "Mode" is on
Classic switches between Resting and Bulk MPPT repeatedly but produces 0 watts	<ul style="list-style-type: none"> *This can be normal under low light conditions. *Watch the input voltage, if it drops down close to battery voltage and then the Classic goes to Resting this is usually a sign of a bad connection. If it is rock solid call customer service *Try doing a factory restore. (Warning all settings will be lost)
The Display shows 0 volts in (or real close) but shows battery voltage correctly	<ul style="list-style-type: none"> *If this is a new install check for reverse polarity on the PV positive and negative on the blue terminal block inside the Classic *If the system has been running all along and this just happened call customer service.
The Display is showing all 0s and or "Got Comm"	<ul style="list-style-type: none"> *Make sure you did not put a different display on the Classic, Firmware must match on the Classic and MNGP. *Do a HARDWARE Factory Restore (See manual)
The Display is showing "Mode is OFF"	<ul style="list-style-type: none"> *Enter the main menu and select "Mode". Turn the Mode "ON" ad press Enter to save this. Then press Status to return to the main screen. *If using the Classic for wind and you cannot turn the mode on this can also indicate the wind curve is not linear and the classic cannot work with it. Please make sure the wind curve continually goes up hill.
Stuck in the Quick Start or "VMM"	<ul style="list-style-type: none"> *Check that the blue display cable is plugged in and connections are sound. Try unplugging it and plugging it back in. Check for corrosion also. *Do a HARDWARE Factory Restore (See manual)
The MNGP (Display) is fuzzy or has odd characters	<ul style="list-style-type: none"> *Check to make sure the blue display cable is plugged in well and that it is not running down over the 2 big yellow inductors on the left hand side of the circuit board.
Multiple charge controllers and one or more is showing 0 watts and absorb or float	<ul style="list-style-type: none"> *This is normal as the battery is almost full and the extra power is not needed so the controller throttles back to prevent over charging of the battery
Multiple Classics in Follow Me and they are not all making the same amount of power?	<ul style="list-style-type: none"> *This is normal as Follow Me simply coordinates the charge stages, each Classic still works independently as far as regulating the PV array.

<p>How do I verify Follow Me is working properly?</p>	<p>*You should first go to the Main menu and then into the “Temps” menu and verify all controllers are seeing the Battery Temp from the one with the BTS plugged in. *You should also see a blue LED flashing inside the top vent. There are two types of blink, A short blink that is about one tenth of a second means it is getting good information. A long blink that is about half a second indicates it did not get any info. If the blinks are ALL long then you probably have a bad cable and all cables should be checked immediately</p>
<p>The Fans seem way to loud</p>	<p>*If it is the internal fans make sure no wires or anything have come in contact with them inside the wiring compartment *If it is the external fan you may want to remove the front half of the “Turbo” plastic housing and make sure the fan is still adhered into the back plastic housing. If the fan has come loose a dab of silicone on each side should solve the noise issue. Please make sure not to get any silicone on the fan blades</p>
<p>Updating the firmware and the Classic went well but the MNGP will not update</p>	<p>*Make sure the MNGP (Display) is actually plugged in using the blue display cable in the top jack of the main circuit board *Verify you have an MNGP and not an MNLP. The MNLP is an LED panel that comes with the Classic Lite and does not need to be updated *When the black box pops up telling you to power the Classic up, Count to 4 before turning the breaker on *If you do not have a breaker or disconnect and you are trying to connect a wire to a terminal block or a battery the connection will likely be to dirty for the boot loader. Install the proper breakers</p>
<p>Classic goes to absorb at too low of a voltage</p>	<p>*Verify this is not normal operation do to the battery being warmer than the neutral point. You can verify the battery temperature by going into the main menu and selecting the “Temps” menu. The Classic like all other chargers will adjust the actual charge voltage based on the temperature of the battery. It uses 2 variables you program in for this. 1-Temperature neutral point (Typically 25 degrees C) and this is found in the WBjr set up menus. 2-Milli volts per degree C per cell (typically -5Mv). So verify both of these are set per the battery manufacturers specs. So for an example if Absorb was set for 58.8 volts and the battery is at 35 degrees C and the temp comp is set for -5mv we have a 10 degree C difference: $10 \times 24 = 240 \times 5 = 1200\text{Mv}$ or 1.2v so the Classic would actually charge to 57.6v</p>
<p>Classic goes to absorb at too high of a voltage</p>	<p>*Verify this is not normal operation do to the battery being cooler than the Neutral point. You can verify the battery temperature by going into the main menu and selecting the “Temps” menu. The Classic like all other chargers will adjust the actual charge voltage based on the temperature of the battery. See above calculation's the same works for cold batteries as well you just end up with a negative number so a battery that is 15 degrees C would look like: $-10 \times 24 = -240 \times 5 = -1200\text{Mv}$ or -1.2v so the Classic would actually charge to 60v</p>

<p>Classic goes to Float to early</p>	<p>*Make sure End Amps is not set to high causing the Classic to go to Float (End Amps is in the Charge menu and the way it works is if the charge current falls below the End Amps setting AND the Classic is in Absorb the Classic will go to Float. Setting End Amps to 0 will disable it. End Amps setting is a value the battery manufacturer supplies *Make sure you have the Absorb time is set properly</p>
<p>Follow Me with my Classic Lite is not working</p>	<p>*Classic Lites older than serial # CL05435 did not work with Follow Me please call customer service for a new MNLP *Verify you are seeing the short blips of the blue LED internally as talked about above. If not please check all your cables.</p>
<p>My Classic says "OCP is OFF" on the display</p>	<p>*This can happen on older Classics that have had the firmware updated. This will have no effect on the operation of the classic but to make the message go away do a factory restore to fix this. (Warning all settings will be lost)</p>
<p>My Classic says "OCP" now and then on the display</p>	<p>*This can be normal if the battery bank is small or the inverter cables are too small. If this shows up just once in a great while that would be ok but if it is happening pretty regularly you may want to look at the size of the battery cables, Age of the battery bank or the size of the battery. Call customer service for assistance</p>
<p>My Classic has an orange LED on the display lit up and or says "Amp Limit"</p>	<p>*This indicates the Classic is current limiting. Either because it has reached the current limit you have set in the Charge menu under limits or because it is too hot and it is backing its current down to prevent overheating. Go into the Main menu and the Charge category, Look in the Limits sub menu and verify the amp limits for In and Out are set to what you desire.</p>
<p>My Classic says "Hyper VOC" on the display</p>	<p>*This is indicating that the input voltage has exceeded the operational voltage of the Classic. If this is happening now and then on rare occasions when it is really cold then this is normal. If this is happening all the time this indicates the PV array was wired for too high a voltage, Please consult your installer for assistance with that</p>
<p>My Classic says "Battery over V" on the display</p>	<p>*This is an indication the Classic thinks the battery voltage is too high and has stopped charging. *This can happen with multiple controllers that are not networked together if one of the classics goes to float it can show this and will go away as soon as the other controller goes to float. *If this is a new install the wrong nominal voltage may be selected and a factory restore will be needed. *if this is a running system then you may have another charging source that has malfunctioned and over charging the battery bank</p>
<p>My Classic says "GRND FLT" on the display and is making a loud beeping</p>	<p>*Generally this would be caused by the PV or Battery positive shorting to ground somewhere in the system. The first thing to do is verify it is a real fault by carefully measuring between Battery Negative and Earth ground. If you see any voltage here than the system has a fault. Call your installer for help finding and rectifying the fault. The Classic will automatically stop showing the fault when the issue is fixed</p>

<p>My Classic says “Set date and time” on the display</p>	<ul style="list-style-type: none"> *Verify you are not setting the date and time with the local app without time sync off in the tweaks menu *If not using the local app to set the time then verify that time sync is ON in the tweaks menu. *Verify the “Remove” paper was removed out of the coin battery in the display. *Check coin battery for voltage, if under 2.5v replace the battery *Check the coin battery for glue residue from the remove tag *With coin battery removed press in on the 2 tabs to bend them in a little tighter and add more spring pressure to the battery.
<p>I have a WBjr and the SOC% is not showing on the main status screen</p>	<ul style="list-style-type: none"> *Verify the WBjr is set up properly by looking at the WBjr status screen and verifying the values it is showing look proper *The SOC% will not show up until the Classic with the WBjr goes to float once so it can calibrate. *If there are multiple Classics in Follow me we need to make sure the one with the WBjr is the first one to go to float. We recommend setting the Classics that do not have WBjrs for about 15 minutes longer on the absorb time this will ensure the Classic with the WBjr goes to float first. *If you are using End Amps make sure you use the Classic with the WBjr to do the sensing of End Amps.
<p>I don't see a WBjr status screen or I don't see all the settings shown in the manual?</p>	<p>*If the WBjr status menu is not present or does not match the manual then you most likely have older firmware. We recommend updating the firmware and doing a factory restore. (Warning all settings will be lost) The firmware can be found on our website under the “software” tab. Or at the URL below.</p> <p>http://www.midnitesolar.com/firmware.php?firmwareProduct_ID=1</p>
<p>My State of Charge seems inaccurate?</p>	<ul style="list-style-type: none"> *Verify the neutral temperature for the temp comp is set per the battery manufacturers specs (typically 25C) *Verify the Amp Hours of the battery bank is set properly (Note batteries in a string do not add in amp hours, so if you have a single string of 8 golf cart batteries each having 220AH then you have 220AH of capacity) *Verify the efficiency of the battery is set properly according to the battery manufacturer's specs (typically 94%)
<p>Classic says “Arc Fault” on the display and is making a loud beeping noise</p>	<ul style="list-style-type: none"> * This is generally indicating you have a bad connection somewhere causing arcs, This can be anywhere in the system so generally finding it is easier if you can turn things off and see what causes the Fault to clear. *This also can be caused by loads etc and be a nuisance trip. Please see the manual for help with that
<p>My Classic Lite has ALL of its LEDs blinking slowly</p>	<ul style="list-style-type: none"> *This is indicating the LED panel “MNLP” is not talking to the Classic, Try making sure the blue cable is plugged in well. *Try plugging the Blue cable into the middle jack *If both of the above fail do a HARDWARE factory restore (See manual)

<p>My Classic Lite has the left hand 3 LEDs blinking on the LED panel</p>	<p>*This indicates wrong code, If you recently updated code you may have updated with the wrong model code. Look at the inductor stickers they will have the model of classic on them also so you can verify and re update with that model code</p>
<p>When I make changes to my Classic Lite with the Local App they do not appear to stay</p>	<p>*This is generally caused by failing to put the MNLP (LED panel) into Custom mode. To put this into custom mode set S1 Switches 1 and 2 to ON or UP this will allow the LED panel to read the classic but not make ANY changes to its programming so you can program the Lite with the Local App</p>
<p>My Time gets out of whack on the Local App when the Classic Lite is powered down and back up</p>	<p>*Unfortunately on the Lite there is no battery to back up the real time clock like there is on the regular Classics, You will need to use the Local App to reset the time after a power cycle, The Local App will turn yellow if the time is not in sync with the PC you are viewing it on. And the Local app has a time sync button on the Basic Configuration tab</p>
<p>I am having trouble getting my Classic Lite on the network</p>	<p>*We recommend setting the dip switches for normal operation and DHCP. Connect to it with the Local App and verify it has connected to the network. Now at this point we can go switch the S1 switch 1 and 2 to ON or UP to set the MNLP to custom. Do this with the Classic Lite powered on. Now you can change the network settings on the Local App if you want.</p> <p>(Note setting switches to custom first and then powering the Classic Lite can cause issues trying to connect as it assumes you are already connected, We anticipate setting to Custom AFTER connecting to the network)</p>
<p>My Classic or Classic lite keeps going back to address 10 after I readdress it to something else</p>	<p>*There was a bug in older firmware that would cause this. We recommend updating the firmware and doing a factory restore. (Warning all settings will be lost) The firmware can be found on our website under the “software” tab. Or at the URL below.</p> <p>http://www.midnitesolar.com/firmware.php?firmwareProduct_ID=1</p>
<p>I am having issues connecting my Classic or Classic Lite directly to my PC without a Router</p>	<p>*We advise against this as it is more complicated than most people feel comfortable with. We recommend a cheap router for this as it makes it much easier. The way to think about this is the Computer and Classic have NO address until the Router addresses them so if we must go direct we have to address both of them.</p> <p>*To do a direct connection we recommend a cross over Ethernet cable. Then you need to set the Classic to a static IP say 192.168.1.5 then you need to go into the IPV4 properties on the PC and set it for a static IP also of say 192.168.1.2</p> <p>Note the important part here is that the first 3 sets of numbers match 192.168.1.xxx for example and that the LAST sets of numbers do NOT match as this is the unique identifier of where each item is. You will not need to worry about Gateways or DNS IPs for this connection. For more help with this see our video on direct connection to Classic or consult your network guru</p>

<p>I cannot find an uninstaller for the Midnite firmware updater?</p>	<p>*Go to the C directory and find the folder labeled midnitesolar and open it. In here you will find an uninstaller, simply double left click it to run it. After it is complete you can delete the midnitesolar folder to completely remove any files left behind</p>
<p>What is the PASSWORD for the Classic?</p>	<p>*All Classics use 142 for the password</p>
<p>I hear a singing sound coming from my Classic, Sort of a high pitched whine that varies</p>	<p>*This is the inductors “Singing” when the Input voltage is really low. This is normal and is no cause for concern, however if it bothers you then you can disable it by going to the main menu and entering into tweaks. Look for LoMax and set it to off and press enter.</p> <p>Note: If the PV array is real low voltage and its max power point is close to the battery voltage disabling LoMax will cause a slight loss in power as the Classic will not be able to track all the way to the battery voltage looking for the MPPT voltage</p>
<p>I have a classic that came with a grey “Magnum” Battery temp sensor can I replace it with a Midnite blue one?</p>	<p>*No the Magnum sensor was a different resistance value so those classics where modified to use those sensors. Call customer service if you need help with a new sensor</p>
<p>How can I verify that all my fans work on My Classic?</p>	<p>*If you unplug the battery temp sensor and use a flat bladed screw driver to short out all 6 pins inside the jack (Carefully so as not to bend the pins) the fans should all start spinning</p>
<p>How do I find the “Wizard”?</p>	<p>*You won’t, we removed the wizard as it asked a lot of questions that did nothing and was confusing, We replaced it with the Quick Start that comes up when you first power the classic or do a factor restore</p>
<p>My fans run all the time no matter what the Classic is doing</p>	<p>*Check to make sure you did not pinch the Fan wire at the top in the casting</p>
<p>I remotely mounted my MNGP (display) and now it won’t power on or it blinks but won’t power up</p>	<p>*Check that you made the cable exactly the same as the blue one. Note that Pin one on one end becomes Pin 6 at the other end (Mirror image) *Try a heavier cable, We have found that off the shelf phone cables are good for about 25ft max before the voltage drop is to great. We have found that cable like Cat3 or Cat5E can go about 100ft no problem.</p>
<p>How many amps can my Classic handle on the input side? OR Can I put too much PV on my Classic?</p>	<p>*The Classic regulates very well so within reason there is no limit on the input amps or PV wattage. We recommend you not exceed 150% of the capacity. The Classic, just like a grid tie inverter, can be over driven on the pv side it simply produces the max amount it is rated for.</p>
<p>My Classic is not making the same amount of wattage as I have for Solar Panels?</p>	<p>*First it should be noted a solar panel is rated in a lab so in the real world we typically see about 80% of what it is labeled (So a 100 watt panel becomes an 80 watt panel) *Does the Classic say Absorb, Float or EQ? If so that means the battery is nearly full and the Classic is throttling back to prevent over charging the battery.</p>

My Label is gone or I mixed up my covers how do I know what model Classic I have?	*You can remove the cover and look at the stickers on the big yellow inductors on the left side of the circuit board *You can press the status button several times and the Classic will say "Connected to Classic xxx" on one of them, this is your model #
I can't read my serial # sticker how can I find my serial #	*Press the status button several times and a screen will come up saying "Connected to a Classic xxx" in the bottom right corner is the serial number, it will start with a CL.
How do I know what Nominal voltage my Classic is programmed for?	*Press the status button several times and a screen will come up saying "Connected to a Classic xxx" to the right of this it will say the battery voltage it is programmed to (Example 48v)
I have Aux1 programmed properly but I cannot get 12v out of it when I should?	*Most likely the Jumpers on the bottom left corner of the circuit board are set for a dry relay not for a 12v signal. See the Aux portion of the manual for help with that.
I was in the middle of a firmware update and the update got interrupted what do I do?	*No problem simply start over with the update, The Classic has a boot loader that will always look for new firmware on boot up so you can not damage the Classic.
Can I use wind and Solar on a single Classic?	*No they both require drastically different tracking algorithms so you will need two Classics
Can I have more than one Classic on a single battery?	*Yes as long as they have separate Solar Arrays
Do I have to shut off my Classic if I have a different charger charging?	*No the Classic will work just fine in conjunction with ANY other charger on the same battery

Electrical Specifications

Model	Classic150	Classic200	Classic250
Operating Volts in	150VDC	200VDC	250VDC
Max Hyper VOC	150+battery	200+battery	250+battery
*Battery Charge Volts	12-93 volts	12-93 volts	12-93 volts
**Absolute Current Output at 25°C	96a at 12v battery 94a at 24v battery 83a at 48v battery	74a at 12v battery 70a at 24v battery 65a at 48v battery	60a at 12v battery 62a at 24v battery 55a at 48v battery
De-rate current at 40°C+	80 amperes	66 amperes	52 amperes
Environment	-40c to 40c		
Dimensions of Classic	14.87"X 5.95"X 4.00" 378mm X 151mm X 102mm		
Dimensions of Box	19.00"X 8.50"X 5.70" 483mm X 216mm xX145mm		
Shipping Weight	11.5 lb 4.9 kg		
NOTE: Current output ratings were measured with 75% of the PV array's VOC (Open Circuit Voltage)			
*NOTE: Calculated by adding battery voltage to the maximum input operating voltage (48V battery max)			
**NOTE: Measurement Accuracies: +- 0.12v, offset calibration adjustment maybe necessary			

Table 10

Specifications Mechanical

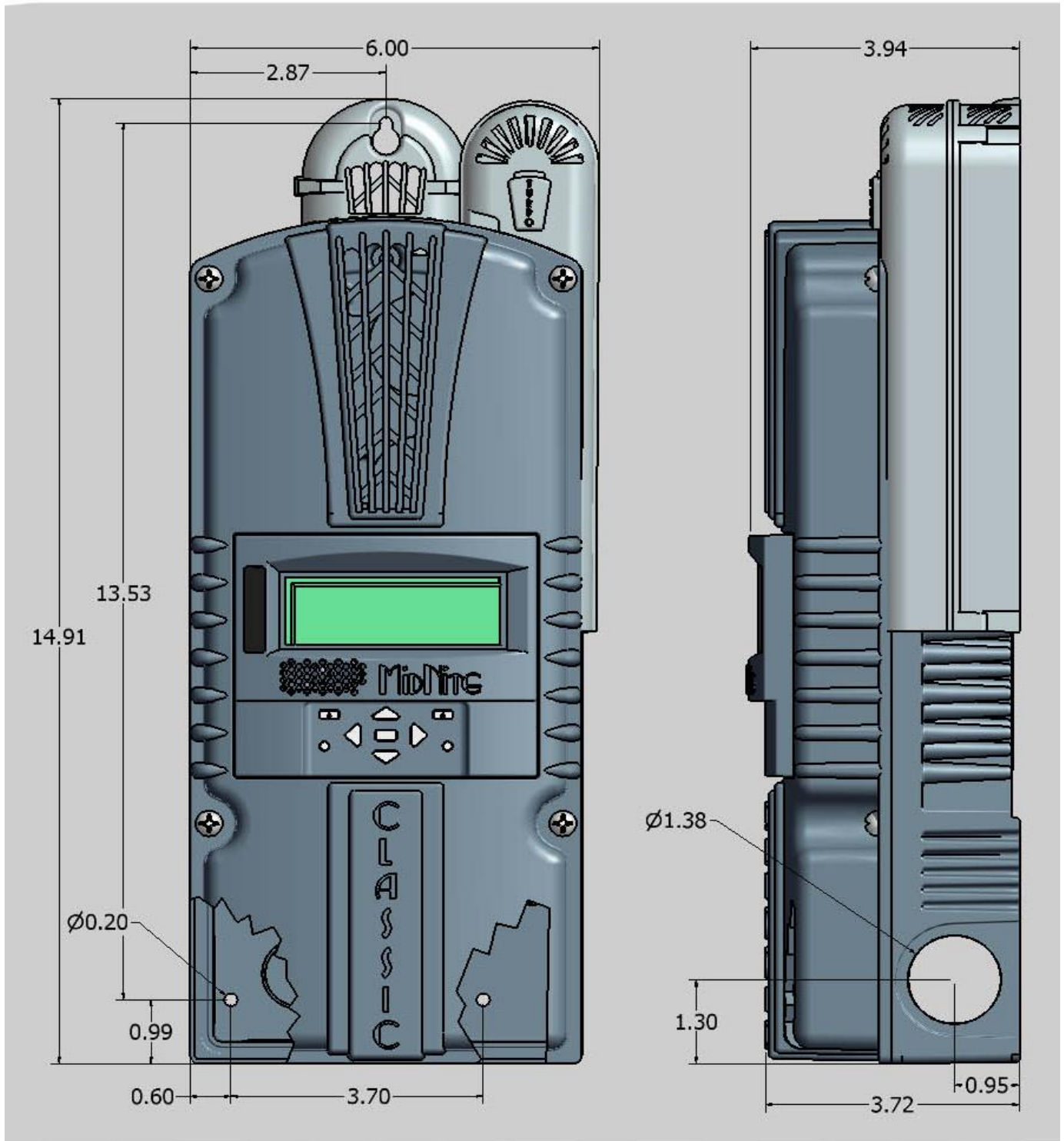

Figure 31

Default Battery charge set points

The table below describes the default preset voltages for the different nominal battery voltages. This means that if you set the Classic from the QUICK START (see page31) to a different battery voltage the Classic will take the default voltage set points. Note. If you manually adjust the absorb float or equalize voltage set points, and then nominal battery voltage is changed to a different nominal voltage, (e.g. from 24v to 12v or to 48v etc.), manual adjustments may be required.

Battery Voltage	12v	24v	36v	48v	60v	72v
Bulk MPPT	14.3v	28.6v	42.9v	57.2v	71.5v	85.8v
Float	13.6v	27.2v	40.8v	54.4v	68.0v	81.6v
Equalize	14.3	28.6v	42.9v	57.2v	71.5v	85.8v

Table 11

To adjust these voltage set point, see page 32 of this manual.

Optional accessories

Optional accessories for the Classic include:

- Blank display for multiple Classic installations
- MidNite network cable 3ft in Length.

Regulatory Approval

The MidNite Solar Classic charge controller conforms to ***UL 1741, Safety for Inverters, Converters, Controllers and Interconnection System Equipment for Use With Distributed Energy Resources, Second Edition, May 7, 1999 with revisions through January 28, 2010 and CAN/CSA C22.2 No. 107.1: 2001/09/01 Ed: 3 (R2006)***

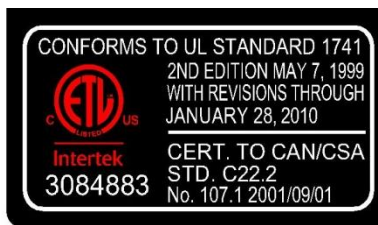

Warranty

MidNite Solar's Classic comes with a standard 5 year warranty. We will repair or replace the Classic at no charge to the consumer during this 5 year period

Appendix

Classic Breaker sizing

Classic Breaker sizing

Model	Bat V	MPPT V (not VOC)	In/Out ratio	Max output A	Output brkr	Wire size 310-17*	Max input A	Input breaker/wire with 125% factor**
Classic 150	12	70	5.83	96	100	4AWG	16.46	30A /10AWG - 63A /6AWG 150V
Classic 150	24	70	2.92	94	100	4AWG	32.19	50A/8AWG - 63A/ 6AWG 150V
Classic 150	48	70	1.45	86	90-100	4AWG	59.31	80A/4AWG 150V
Classic 150	12	90	7.5	96	100	4AWG	12.8	30A /10AWG - 63A /6AWG 150V
Classic 150	24	90	3.75	94	100	4AWG	25.06	50A/8AWG - 63A/ 6AWG 150V
Classic 150	48	90	1.87	83	90-100	4AWG	44.38	63A 150V
Classic 150	12	100	8.33	92	100	4AWG	11.04	30A /10AWG - 63A /6AWG 150V
Classic 150	24	100	4.16	91	100	4AWG	21.87	30A /10AWG - 63A /6AWG 150V
Classic 150	48	100	2.08	80	80-90	4AWG	38.46	50A/8AWG - 63A/ 6AWG 150V
Classic 150	12	110	9.16	93	100	4AWG	10.15	30A /10AWG - 63A /6AWG 150V
Classic 150	24	110	4.58	84	90-100	4AWG	18.34	30A /10AWG - 63A /6AWG 150V
Classic 150	48	110	2.29	76	80-90	4AWG	33.18	50A/8AWG - 63A/ 6AWG 150V
Classic 150	12	120	10	92	100	4AWG	9.2	30A /10AWG - 63A /6AWG 150V
Classic 150	24	120	5	82	90-100	4AWG	16.4	30A /10AWG - 63A /6AWG 150V
Classic 150	48	120	2.5	76	80-90	4AWG	30.4	50A/8AWG - 63A/ 6AWG 150V
Classic 200	12	70	5.83	79	80-90	4AWG	13.55	30A/10AWG - 50A/6AWG or 8AWG 300V
Classic 200	24	70	2.91	78	80-90	4AWG	26.8	50A/6AWG or 8AWG 300V
Classic 200	48	70	1.46	76	80-90	4AWG	52.05	80A/4AWG 300V
Classic 200	12	120	10	77	80-90	4AWG	7.7	30A/10AWG - 50A/6AWG or 8AWG 300V
Classic 200	24	120	5	74	80-90	4AWG	14.8	30A/10AWG - 50A/6AWG or 8AWG 300V
Classic 200	48	120	2.5	70	70-80	4AWG	28	50a/6AWG or 8AWG 300V
Classic 200	72	120	1.66	65	70-80	4AWG	39.15	50a/6AWG or 8AWG 300V
Classic 200	12	140	11.66	74	80-90	4AWG	6.34	30A/10AWG - 50A/6AWG or 8AWG 300V
Classic 200	24	140	5.83	72	80-90	4AWG	12.34	30A/10AWG - 50A/6AWG or 8AWG 300V
Classic 200	48	140	2.92	65	70-80	4AWG	22.26	50a/6AWG or 8AWG 300V
Classic 200	72	140	1.94	63	63-70	6AWG	32.47	50A/6AWG or 8AWG 300V
Classic 200	12	160	13.33	73	80-90	4AWG	5.47	30A/10AWG - 50A/6AWG or 8AWG 300V
Classic 200	24	160	6.66	72	80-90	4AWG	10.81	30A/10AWG - 50A/6AWG or 8AWG 300V
Classic 200	48	160	3.33	65	70-80	4AWG	19.52	30A/10AWG - 50A/6AWG or 8AWG 300V
Classic 200	72	160	2.22	53	60-63	6AWG	23.87	50A/6AWG or 8AWG 300V
Classic 250	12	180	15	61	63-70	6AWG	4.06	30A/10AWG - 50A/6AWG or 8AWG 300V
Classic 250	24	180	7.5	62	63-70	6AWG	8.26	30A/10AWG - 50A/6AWG or 8AWG 300V
Classic 250	48	180	3.75	55	60-83	6-4AWG	14.66	30A/10AWG - 50A/6AWG or 8AWG 300V
Classic 250	72	180	2.5	43	50-63	6AWG	17.2	30A/10AWG - 50A/6AWG or 8AWG 300V
Classic 250	12	200	16.6	58	60-70	6AWG	3.49	30A/10AWG - 50A/6AWG or 8AWG 300V
Classic 250	24	200	8.33	60	60-70	6AWG	7.2	30A/10AWG - 50A/6AWG or 8AWG 300V
Classic 250	48	200	4.16	53	60-63	6AWG	12.74	30A/10AWG - 50A/6AWG or 8AWG 300V
Classic 250	72	200	2.77	40	40-63	8-6AWG	14.44	30A/10AWG - 50A/6AWG or 8AWG 300V

*NEC310-17 is the chart for single conductors in free air. This chart is conservatively based on this chart, 75C wire inside a MidNite E-Panel
 ** MidNite Solar breakers are all rated for 100% duty cycle and do not require 156% safety factor. * above also applies to input breaker and wire.

Table 12

Classic Menu Items
Status, Charge, Mode, Aux, Misc, Logs, Tweaks, Temps and Net

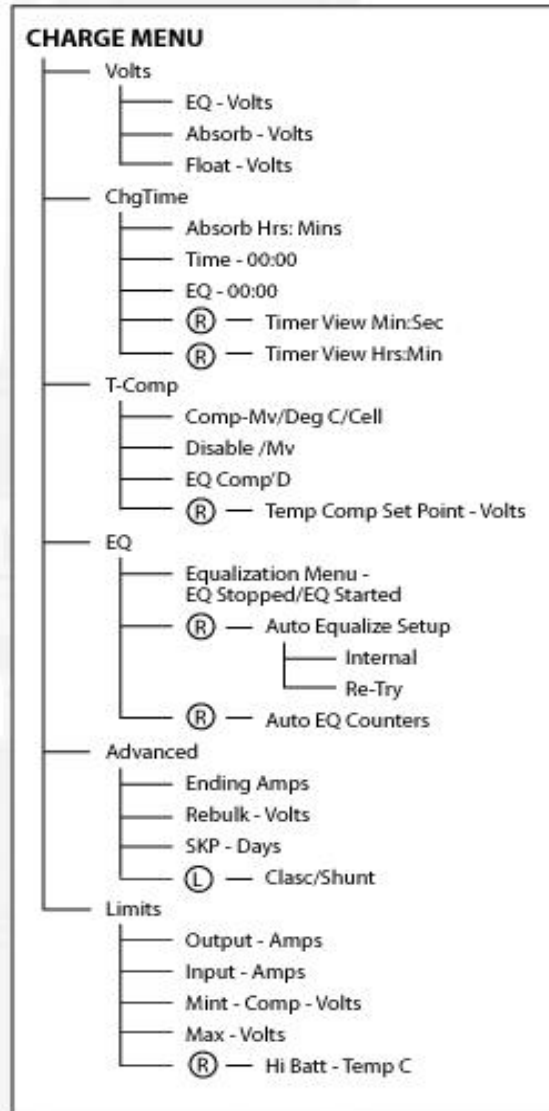
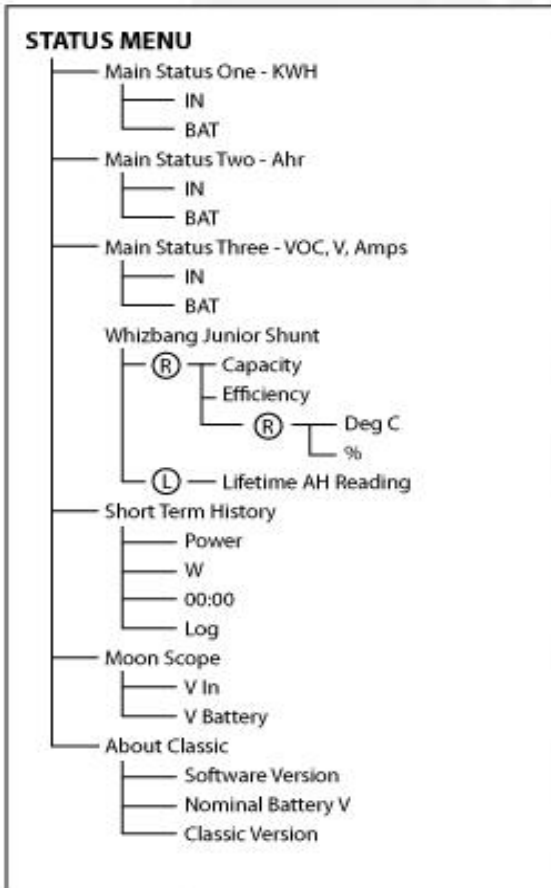

(R) Symbolizes pushing the Right Soft Key
 (L) Symbolizes pushing the Left Soft Key

WARNING! The Classic's USB port is NOT isolated from battery negative. This is typically only an issue on positive ground systems or systems with a tripped ground fault protection device. Care must be taken that a computer connected to the Classic's USB port is either isolated from ground and the Classic's negative or that the computer's USB negative is common with the Classic's negative and ground.

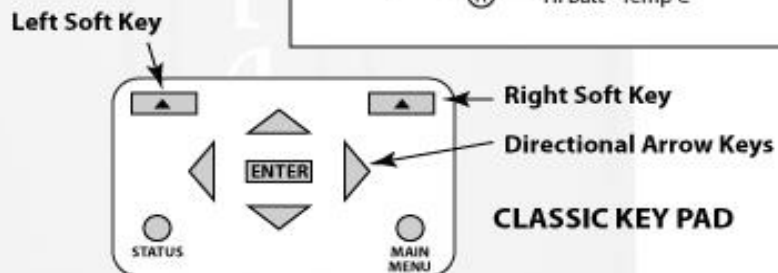

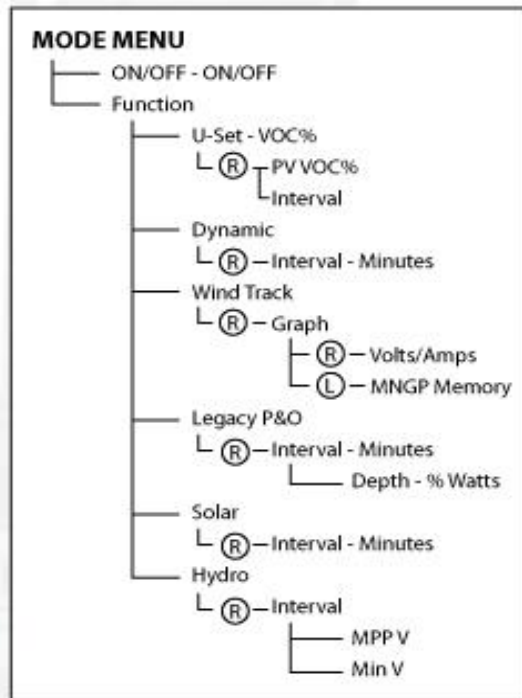
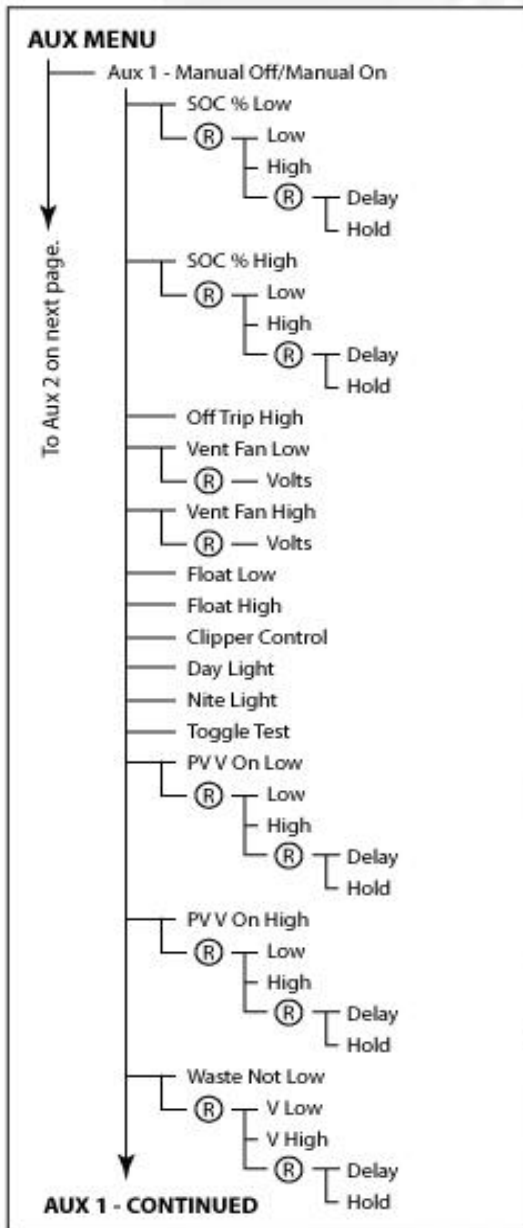

(R) Symbolizes pushing the Right Soft Key
 (L) Symbolizes pushing the Left Soft Key

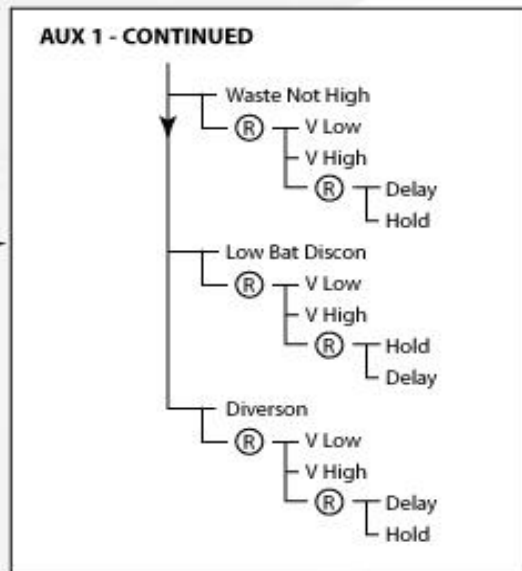

CLASSIC MENU MAP
MidNite Solar Inc.

Continued from previous page.

AUX MENU

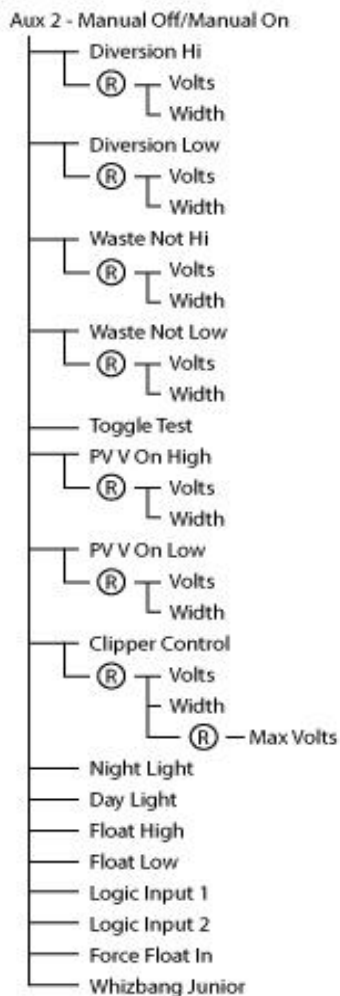

MISC MENU

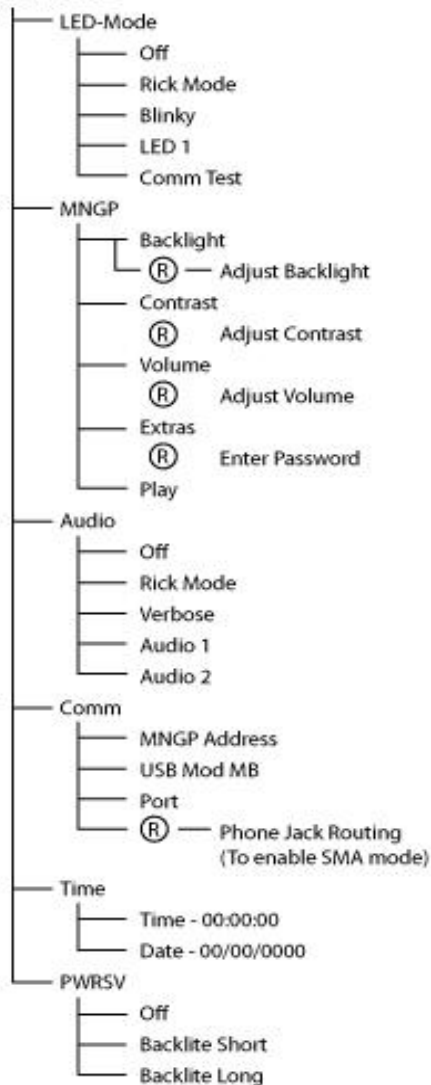

(R) Symbolizes pushing the Right Soft Key

CLASSIC MENU MAP
MidNite Solar Inc.

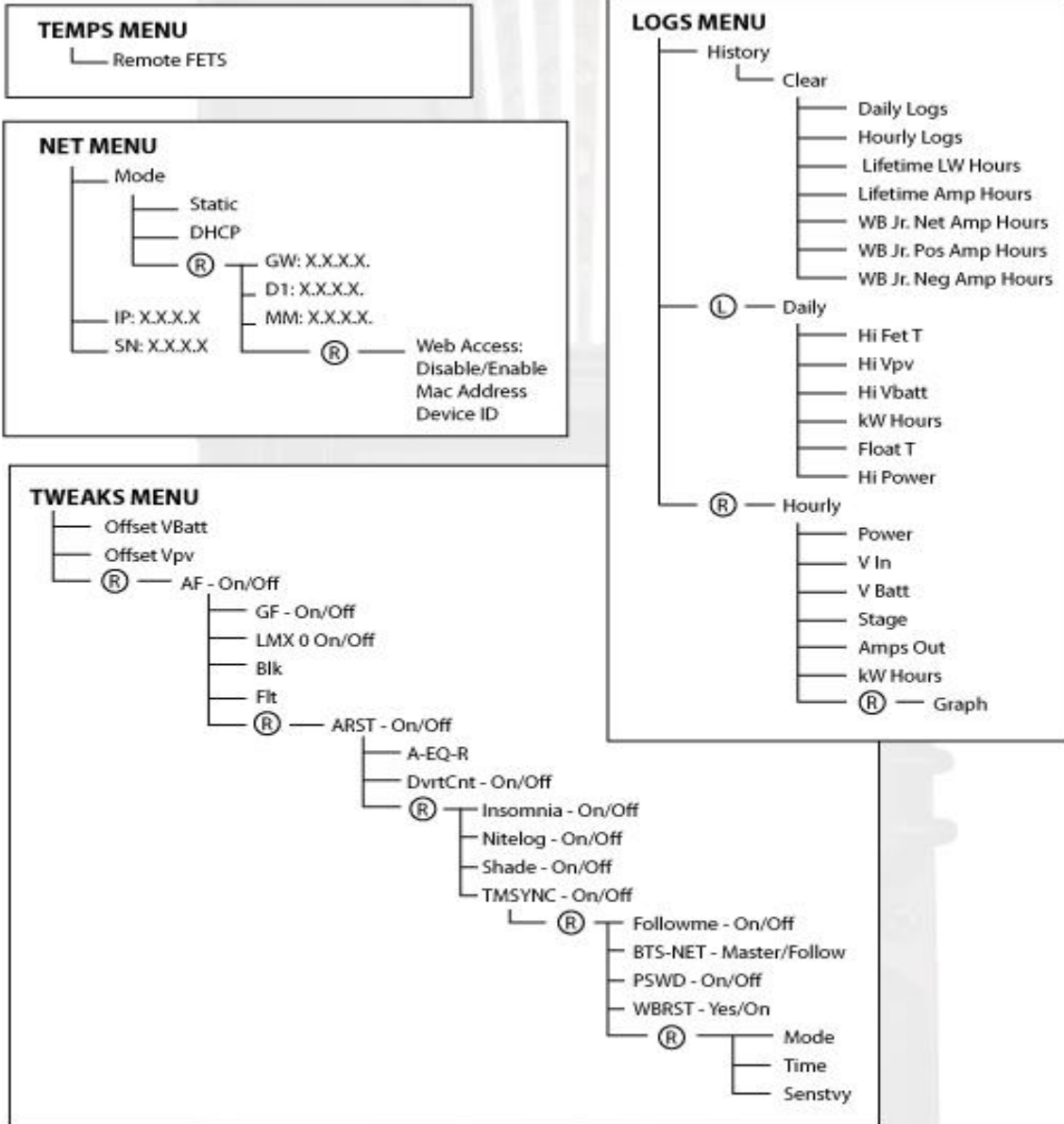

(R) Symbolizes pushing the Right Soft Key
(L) Symbolizes pushing the Left Soft Key

Table 13

Label Set from Classic

MIDNITE SOLAR CLASSIC 150
MPPT SOLAR, WIND, HYDRO, BUCK, BOOST CHARGE CONTROLLER
 NOMINAL OPERATING ENVIRONMENT 25°C (40°C DE-RATED SEE MANUAL)
 CONFORMS TO UL STANDARD 1741
 2ND EDITION MAY 7, 1999
 WITH REVISIONS THROUGH
 JANUARY 28, 2010
 CERT. TO CAN/CSA
 STD. C22.2
 No. 107.1 2001/09/01
 3084883
 MAX PV VOLTAGE (OPERATING) 150V
 MAX PV CURRENT (OPERATING) 96A
 MAX PV VOC 150V + BATTERY VOLTAGE
 MAX PV SHORT CIRCUIT CURRENT 96A
 MAX BATTERY CHARGE CURRENT 96A
 MAX BATTERY CHARGE VOLTAGE 93V
 NOMINAL BAT VOLTAGES 12-72V
 MAX OUTPUT FAULT CURRENT 436A





MIDNITE SOLAR CLASSIC 200
MPPT SOLAR, WIND, HYDRO, BUCK, BOOST CHARGE CONTROLLER
 NOMINAL OPERATING ENVIRONMENT 25°C (40° C DE-RATED SEE MANUAL)
 CONFORMS TO UL STANDARD 1741
 2ND EDITION MAY 7, 1999
 WITH REVISIONS THROUGH
 JANUARY 28, 2010
 CERT. TO CAN/CSA
 STD. C22.2
 No. 107.1 2001/09/01
 3084883
 MAX PV VOLTAGE (OPERATING) 200V
 MAX PV CURRENT (OPERATING) 79A
 MAX PV VOC 200V + BATTERY VOLTAGE
 MAX PV SHORT CIRCUIT CURRENT 79A
 MAX BATTERY CHARGE CURRENT 79A
 MAX BATTERY CHARGE VOLTAGE 93V
 NOMINAL BAT VOLTAGES 12-72V
 MAX OUTPUT FAULT CURRENT 436A











MIDNITE SOLAR CLASSIC 250
MPPT SOLAR, WIND, HYDRO, BUCK, BOOST CHARGE CONTROLLER
 NOMINAL OPERATING ENVIRONMENT 25°C (40° C DE-RATED SEE MANUAL)
 CONFORMS TO UL STANDARD 1741
 2ND EDITION MAY 7, 1999
 WITH REVISIONS THROUGH
 JANUARY 28, 2010
 CERT. TO CAN/CSA
 STD. C22.2
 No. 107.1 2001/09/01
 3084883
 MAX PV VOLTAGE (OPERATING) 250V
 MAX PV CURRENT (OPERATING) 62A
 MAX PV VOC 250V + BATTERY VOLTAGE
 MAX PV SHORT CIRCUIT CURRENT 62A
 MAX BATTERY CHARGE CURRENT 62A
 MAX BATTERY CHARGE VOLTAGE 93V
 NOMINAL BAT VOLTAGES 12-72V
 MAX OUTPUT FAULT CURRENT 436A



ATTENTION SURFACES CHAUDES  **CAUTION** HOT SURFACES **CL00001**
 MIDNITE SOLAR, INC.
 17722 87TH AVE NE UNIT C
 ARLINGTON, WA 98223 USA
 WWW.MIDNITESOLAR.COM

 **DANGER**
CAUTION
 ELECTRICAL SHOCK AND BURN HAZARD. SOLAR PANELS WILL CONTINUE TO PRODUCE VOLTAGE EVEN WHEN DISCONNECTED. ENSURE THAT PV MODULES ARE COVERED. TURN OFF PV ARRAY AND CHARGE CONTROLLER OUTPUT PRIOR TO SERVICE. RISK OF ELECTRIC SHOCK. DO NOT REMOVE COVER. NO USER SERVICEABLE PARTS INSIDE. REFER SERVING TO QUALIFIED SERVICE PERSONNEL.
ATTENTION  **CAUTION**
 DANGER DE CHOC ÉLECTRIQUE ET DE RISQUE DE BRÛLURE. LES PANNEAUX SOLAIRES CONTINUERONT DE PRODUIRE L'ÉLECTRICITÉ MÊME S'ils SONT DÉBRANCHÉS. S'ASSURER QUE LES PANNEAUX SOLAIRES SONT COUVERTS PENDANT L'ENTRETIEN. POUR TOUTE ACTION D'ENTRETIEN, LA SORTIE DES PANNEAUX SOLAIRES ET DU CONTRÔLEUR DE CHARGE DOIVENT ÊTRE DÉCONNECTÉES. RIEN À DÉPANNER À L'INTÉRIEUR DU E-PANNEAU. NE PAS OUVRI R LE COUVER. POUR TOUTE RÉPARATION OU SERVICE, D'ENTRETIEN, CONSULTER UN AGENT SPÉCIALISÉ.

 Q1  Q2  Q3  Q4  12  13  14  15  16
 AUX OUTPUT 1: 13VDC 200mA - RECONFIGURABLE AS 3.3VDC AUX **INPUT**
 AUX OUTPUT 2: 500mA RELAY DRY CONTACT- RECONFIGURABLE AS 13VDC 200mA OUTPUT
 MINIMUM INTERRUPT RATING: 4000 AMPS DC FOR OVERCURRENT PROTECTION DEVICE
 TORQUE TERMINAL BLOCK AND GND TERMINAL TO 35 IN-LBS (4Nm). SUITABLE FOR USE WITH 75°C MINIMUM RATED COPPER CONDUCTORS.

RS232 Jack Pin Out

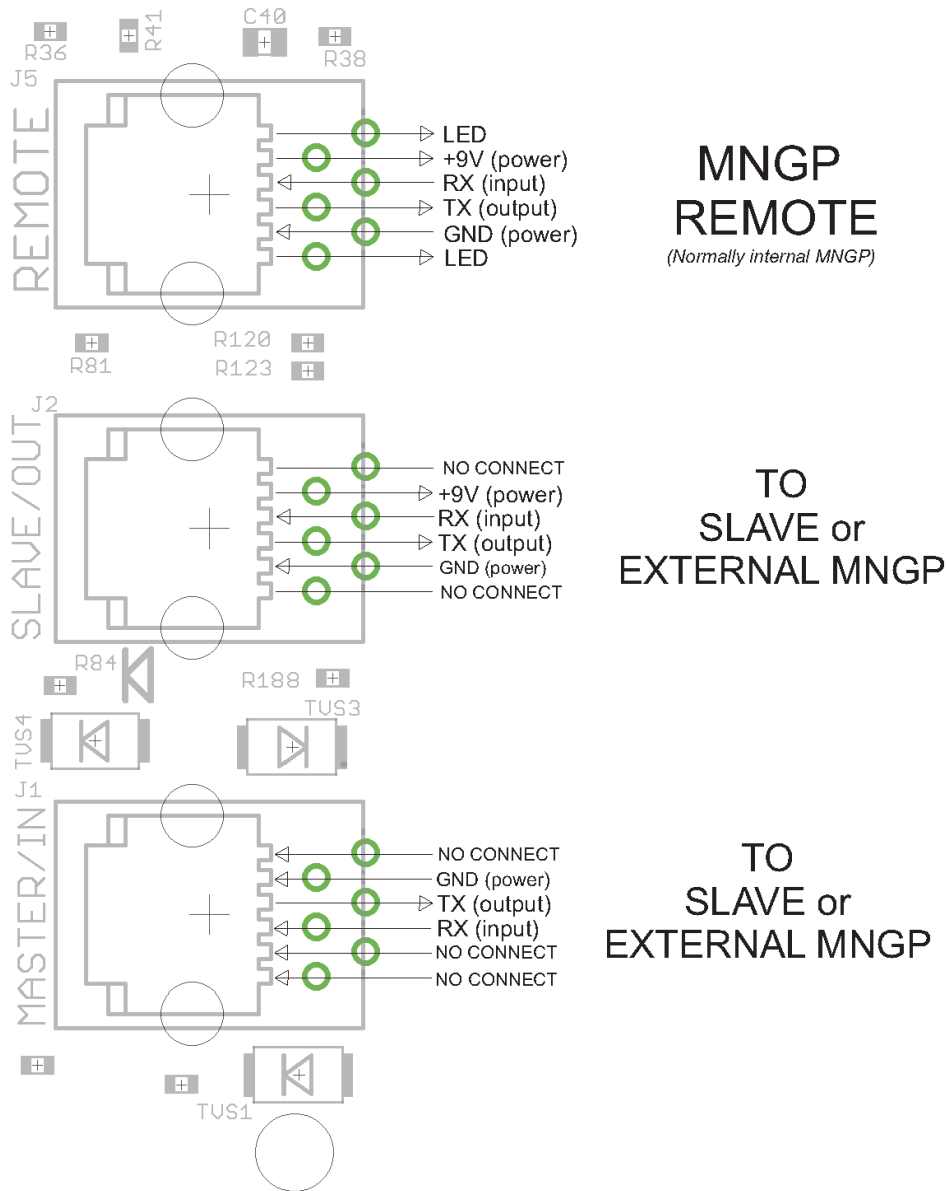

Figure 1. Classic RS-232 MODBUS RJ-11 PHONE JACK PINOUTS

Glossary of Terms

Absorb – Constant voltage charge stage to fill the batteries. The controller is regulating so maximum power will not be seen at this time. The Absorb timer is also counting down to the switch to Float.

A-EQ-R – This will reload the Auto Equalize counters, basically it will start the counters from day 1.

AF – Arc Fault, See page 48 for more info on arc fault protection.

Arc Adjust – This menu is where you adjust the Arc Fault sensitivity. For info on Arc Fault see page 48.

A-RST – Auto reset of the Classic controller. The Classic will reboot around Midnight every night when this is enabled. This is useful for very remote sites where a loss of Internet capability for example would be a hard ship.

Aux – Auxiliary relays. The Classic has 2 relays: Aux 1 can be configured as a 12 volt signal or a dry relay, Aux 2 can be used as a PWM signal output. Refer to page 37 for more Aux info.

BLK – Bulk MPPT Mode. By using the up arrow in Tweaks under BLK you can force the Classic into Bulk mode.

Bulk MPPT - Maximum current charge stage, the Classic is trying to bring the batteries to the Absorb voltage set point. We are basically putting all available power into the batteries.

Comm – This menu allows adjustment of things like Mod Bus port, USB Mode and MNGP address.

DvrtCnt – When enabled, allows the charge stage timers to continue to run when the diversion modes are holding the battery voltage just below the actual set point.

Equalize - Constant voltage charge stage to equalize the batteries. The controller is regulating so maximum power will not be seen at this time. The Equalize timer is also counting down to the switch to Float.

EQ MPPT - Maximum current charge stage. The Classic is trying to bring the batteries to the Equalize voltage set point. We are basically putting all available power into the batteries.

Float – Constant voltage charge stage with a lower voltage than the Absorb charge point. The controller is regulating so maximum power will not be seen at this time.

Float MPPT – Maximum current charge stage. The Classic is trying to bring the batteries to the Float voltage set point. We are basically putting all available power into the batteries.

FLT – Float mode. By using the up arrow in Tweaks under FLT you can force the Classic into Float mode.

GF – Ground Fault, See page 23 for more info on ground fault protection.

Got Comm – Indicates a lack of communication between the display and the Classic. Consult Troubleshooting for information page 72.

Insomnia – This, when enabled, will keep the Classic from going to Resting. This is intended for hydro mode only where you may need time to open water valves and do not want to wait for the Classic to wake up.

LED-MODE – This selection lets you pick the function of the 6 visible LEDs on a standard Classic.

LMX – LoMax. This enables the Classic to track the input voltage all the way down to Battery voltage. When disabled the Classic will stop tracking the input around 5 volts above the battery voltage. When the input voltage is within a couple volts of the battery voltage the inductors can “Sing” this is usually not very loud and will do no harm.

Local App – Monitoring software included with the Classic for monitoring over the Local Network or Internet.

MNGP – Midnite Graphical interface Panel. This is the graphical display included with the standard Classic controller.

MNLP – MidNite LED interface Panel. This is the LED display that comes standard with the Classic Lite.

Mode – This menu lets you turn the charging ability of the controller On / Off as well as lets you select the DC input source. See page 32 for info on the Mode menu.

Mod Bus – a standard protocol used for communications. We have published our protocol to allow users to interface with the Classic. See www.midnitesolar.com for our Mod Bus protocol.

My MidNite – Web based monitoring for the Classic. (Not available yet)

NiteLog – When enabled, allows the Classic to log data in the evening when the Classic is Resting.

PV Shading – This indicates the Maximum power point voltage is less than half the open circuit voltage.

Pwr Save – Allows you to adjust the time the Backlight stays on.

Resting – The Classic is not charging the battery due to low light. For certain reasons Resting will appear. Please see page 32.

Shade – When enabled the Classic will show PV Shading on the display when the Maximum power point voltage is less than half the open circuit voltage.

T-Comp – Temperature compensation using a temperature sensor to measure the ambient temperature of the battery bank and will adjust the voltage set points up or down accordingly to ensure a full battery. There are 3 parameters to set Minimum and Maximum adjusted voltage as well as volts per degree C per Cell. Typically this is -5 mV but please consult your battery manufacturer. See page 17 for Temperature compensation info.

Tweaks – This menu has all the advanced adjustments for the Classic. For example: Voltage off set adjustments etc.

VBatt – Battery voltage, measured at the battery terminals of the Classic.

VOC – Open Circuit Voltage, unloaded voltage measurement.

Vpv – Input voltage, measured at the input terminals of the Classic.

Web Access – When enabled, allows the Classic to send data over the Internet to My MidNite's Server for you to view when wanted.