

54

APR 23 1960

SERVICE  
MANUAL 2325



**marantz**

model 2325

*Stereophonic Receiver*

## TABLE OF CONTENTS

SECTION	PAGE
Introduction .....	1
Service Notes .....	1
AM Tuner .....	1
FM Tuner .....	2
Phono Amplifier .....	5
Buffer, Tone and Filter Amplifiers .....	5
Power Amplifier .....	5
Power Protection Circuit .....	6
Speaker Protector Relay Circuit .....	6
Dolby Unit .....	6
400Hz Tone .....	7
Dolby Switch .....	7
Record Level (L) and (R) Knobs .....	7
Play Cal. (L) and (R) Knobs .....	8
Dolby FM Preset Level Controls .....	8
400Hz Tone Switch .....	8
Suggestions for Troubleshooting Power Amplifier .....	8
Test Equipment Required for Servicing .....	9
AM Alignment Procedures .....	9
FM Alignment Procedures .....	10
Audio Adjustment .....	11
Dolby Alignment Procedure .....	11
Dolby FM Preset Level Control Alignment Procedures .....	12
Description of Dolby Processing Chart .....	13
Parts List .....	26~41
Technical Specifications .....	42~43
Servicing Informations for European Model .....	44~46,49

## LIST OF ILLUSTRATIONS

FIGURE	PAGE
1. Block Diagram of the HA1156 .....	4
2. Dial Stringing .....	8
3. Front Panel Adjustments and Component Locations .....	15
4. Main Chassis Component Locations (Top View) .....	15
5. Rear Panel Adjustments and Component Locations .....	16
6. Main Chassis Component Locations (Bottom View).....	16
7. FM Front End Assembly P100 Component Locations .....	17
8. AM Tuner Assembly P150 Component Locations .....	17
9. FM IF Amplifier Assembly P200 Component Locations .....	17
10. MPX Stereo Decoding Amplifier Assembly P300 Component Locations .....	18
11. Phono Amplifier Assembly P400 Component Locations .....	18
12. Dolby Unit Assembly P600 Component Locations .....	19
13. Power Amplifier Assembly P700 Component Locations .....	19
14. Power Supply and Protection Relay Circuit Assembly P800 Component Locations .....	20
15. FM Cal. and De-Emphasis Assembly PC01 Component Locations .....	20
16. Pre and Tone Amplifier Assembly PE01 Component Locations .....	20
17. Buffer Amplifier Assembly PH01 Component Locations .....	21
18. Dolby, Tone and Meter Assembly PL01 Component Locations .....	21
19. Dolby Tone, Tape Mon. Assembly PS01 Component Locations .....	21
20. Tape Monitor Assembly PT01 Component Locations .....	21
21. Multipath, Hi Blend, FM Muting, Low Filter, Hi Filter, Loudness, Main Speaker and Remote Speaker Assembly PU01 Component Locations .....	21
22. Antenna Terminal Assembly PV01 Component Locations .....	22
23. Function Lamp Assembly PY01 Component Locations .....	22
24. Dial Lamp Assembly PZ01 Component Locations .....	22
25. Exploded Mechanical Diagram .....	24~25
26. Rear Panel Adjustments and Component Locations .....	45
27. Main Chassis Component Locations (Top View) .....	45
28. Voltage Conversion Chart .....	46
29. Schematic Diagram for U.S.A. Model .....	48
30. Schematic Diagram for European Model .....	49

TABLE	PAGE
1. Test Equipment Required for Servicing .....	9
2. Dolby Processing Chart .....	14

**INTRODUCTION**

This service manual was prepared for use by Authorized Warranty Stations and contains service information for the Marantz Model 2325 Stereophonic Receiver.

Servicing information and voltage data included in this manual are intended for use by the knowledgeable and experienced technician only. All instructions should be read carefully. No attempt should be made to proceed without a good understanding of the operation of the receiver.

The parts list furnishes information by which replacement part may be ordered from the Marantz Company. A brief description is included for parts which can be usually be obtained through local suppliers.

**1. SERVICE NOTES**

As can be seen from the circuit diagram, the chassis of the Model 2325 consists of the following units. Each unit mounted on a printed circuit board is drawn within bold dotted-line block on the circuit diagram.

- |  |                            |
|--|----------------------------|
| 1. FM Front End .....  | Mounted on P.W. Board P100 |
| 2. AM Tuner Unit .....   | Mounted on P.W. Board P150 |
| 3. FM IF Amplifier .....   | Mounted on P.W. Board P200 |
| 4. MPX Stereo Decoding Amplifier .....   | Mounted on P.W. Board P300 |
| 5. Phono Amplifier .....   | Mounted on P.W. Board P400 |
| 6. Dolby Unit .....  | Mounted on P.W. Board P600 |
| 7. Power Amplifier .....   | Mounted on P.W. Board P700 |
| 8. Power Supply and Protection Relay Circuit .....   | Mounted on P.W. Board P800 |
| 9. FM Cal. ....  | Mounted on P.W. Board PC01 |
| 10. Pre and Tone Amplifier .....   | Mounted on P.W. Board PE01 |
| 11. Buffer Amplifier .....   | Mounted on P.W. Board PH01 |
| 12. 400Hz Tone .....   | Mounted on P.W. Board PL01 |
| 13. 400Hz Tone, Tape 1 and 2   |                            |
| Tape Monitor Switch .....  | Mounted on P.W. Board PS01 |
| 14. Tape Monitor Assembly .....  | Mounted on P.W. Board PT01 |
| 15. Multipath, Hi Blend, FM Muting, Low Filter,<br>Hi Filter, Loudness, Main Speaker and<br>Remote Speaker ..... | Mounted on P.W. Board PU01 |
| 16. Function Lamp .....  | Mounted on P.W. Board PY01 |
| 17. Dial Lamp .....  | Mounted on P.W. Board PZ01 |

**2. AM TUNER**

The AM Tuner section in the 2325 consists of one IC, including an RF amplifier, local oscillator, mixer, IF amplifier, and detector, and three transistors, one of which forms a signal strength indication amplifier and the other two form detected audio signal amplifier.

All components except the tuning capacitor and ferrite bar antenna are mounted on the printed circuit board P150.

The AM signal induced in the ferrite bar antenna is fed to the RF amplifier input (Pin ②) and amplified to the level required for overcoming conversion noises, thus giving good S/N performance. The tuned circuit inserted in each of the output and input circuits of the RF amplifier assures very high image and spurious rejection performance.

Thus the amplified and selected AM signal is then applied to one Mixer input (Pin ①). While the local oscillator voltage is injected to the other Mixer input (Pin ⑥) through a capacitor C157. Then both AM signal and local oscillator output voltage are mixed and converted into 455kHz intermediate frequency. The resulting IF signal is applied to the IF transformer L153 consisting of one ceramic filter and two tuned circuits.

The output of L153 is led to the IF amplifier input (Pin ⑨) through a coupling capacitor C162 and amplified to the sufficient level to drive the detector. The detected audio signal derived from pin ⑦ is filtered and amplified, and the final audio output is obtained from the collector of H153 and applied to the TAPE MONITOR OUT jacks through the function switch.

The DC component of the detected IF signal is used as an AGC voltage to control emitter current of RF amplifier through the AGC amplifier incorporated in the IC. A part of the DC component is also led to the signal strength indication amplifier H154. The output appearing at the collector of H154 is level adjusted by R178, indicated on the signal strength meter M002.

### 2.1 Suggestions for Troubleshooting AM Tuner

Check for broken AM bar antenna, next try to tune stations by rotating the fly-wheel tuning knob slowly and observe the AM signal strength meter whether it deflects or not. If the signal strength meter gives a deflection at several received frequencies, no failure may exist in the stages at least preceding the detector circuits. Next, connect an oscilloscope to the test point ⑥ or J161 and check for audio signals with the tuning meter deflected. If the signal strength meter does not deflect, check the local oscillator circuit. Normal local oscillator output voltage at the hot end of the oscillator tuning capacitor is about 1.5 or 3 volts, varying with the tuning capacitor position. When measuring the local oscillator output voltage use an RF VTVM, no circuit tester gives correct indication. If the local oscillator output voltage is normal, check all voltage distribution in the AM circuits by using a DC VTVM and compare the measured values with those given in the schematic diagram.

## 3. FM TUNER

The FM Tuner section in the Model 2325 consists of four functional blocks: FM Front End, IF Amplifier & Detector, Muting Control and MPX Stereo Decoding Circuit.

An FM signal induced by the FM antenna is led to FM antenna coil L101 through the balun coil. The signal is then applied to the FET RF amplifier which in turn feeds its output to the next FET Mixer H102 through the triple tuned high selective circuit. The FET Mixer converts its input signal into 10.7MHz IF signal and amplifies it at the same time. The H103 is a local oscillator, the output of which is injected into the source of the FET Mixer, the injection voltage being about 700mV. The 10.7MHz front end output is led to the next IF amplifier unit through the coaxial cable.

The IF amplifier unit consists of seven IF amplifier stages and one AGC amplifier stage. Eight pieces of ceramic filter are also used to obtain high selectivity, and four symmetrical diode limiter stages are also employed for the best limiting characteristics, improved capture ratio and good AM suppression.

A part of the FM Front End output is fed to and rectified by the AGC amplifier H209, and the rectified output is fed back to the gate of the FET RF amplifier to decrease the gain with increase of the signal strength.

The signals required for multipath indication are obtained from the five IF amplifier stages through the coupling capacitors C252, C211, C214, C223 and C228, respectively, and are rectified by five pairs of full-wave diode circuit. Thus these AM components of the FM signal are approximately mixed and amplified by the transistors HU01 and HU02 and the output is again rectified to obtain DC current required for actuating the Multipath Indication meter.

The IF signal sufficiently amplified through each IF amplifier stage is finally led to the Detector Amplifier H208. The detected audio output is led to the buffer amplifier H210 and its buffered output is led to: (a) the noise amplifier H310 through the resistor R378 and capacitor C333, (b) the QUADRADIAL OUTPUT Jack on the rear panel through the resistor R379, (c) the MPX stereo decoding IC (H321) through R301 and H301.

The DC current caused at the third windings of the discriminator transformer is directly led to the FM center tuning meter.

### 3.1 Audio Muting and Stereo mode auto-selecting circuit

The muting circuit consisting of all solid-state electrical switching is incorporated in the Model 2325. Three inputs control the muting function. The first is related to signal strength, the second to the noise condition at the detector, and the third is derived from the DC component of the detector output. These inputs are properly matrixed and gated to provide muting free from noise and transients.

The first input of DC voltage obtained by rectifying a part of the IF output signal from the H205 and H206 is fed to the base of H308 and turns it on, if the IF output is greater than a predetermined level (muting threshold level). When the H308 is turned on, the H309 is turned off, allowing the emitter-collector resistance to be increased and the collector voltage to be raised to about 9V. The raised collector voltage increases the gate bias voltage and turns the switching FET H301 on, decreasing the source-drain resistance to near zero ohm and allowing the audio signal applied to the source to flow to the decoding IC pin ② through the source-drain path.

When the input signal is lower than the predetermined level, the DC output obtained is small and can not turn on the H308, thus H308 keeps its off state. This turns H309 on, decreasing the collector voltage and turning H301 off. Thus no audio signals can pass through the FET. This is the fundamental principle of the muting operation but for more elaborate muting operation, the second and the third inputs are necessary.

The second input is used to protect the muting operation and MPX stereo beacon lamps from misoperation due to undesirable noises. The high frequency noises included in the detected audio signals are separated by a small capacitor C333 and are amplified by the noise amplifier transistor H310. Its output is rectified by the two diodes. The rectified DC output is proportional to the noise components in the audio signals.

When there are excessive noises in the audio signals such as obtained with a station incorrectly turned in, the rectified DC output turns the transistor H311 on, decreasing the emitter-collector resistance to zero. This means the collector of H309 is grounded, therefore the H301 is turned off and any audio signals having excessive, high-frequency noises can not go through the FET's source-drain path.

The transistor H317, also, turns off when the transistor H309 or H311 turns on, and turns on the transistor H303 connected to pin ⑧ on the MPX decoding IC. Pin ⑧ is therefore grounded equivalently to set the IC in the monaural mode of operation. This prevents misoperation due to undesirable noises when the FM tuner is out of tuning.

The third input is obtained from the FM discriminator circuit. The DC output, so called "S" curve, is applied to the gate of H312 through the resistor R281 and voltage divider network (R361, R362). The DC output is zero with a station correctly tuned in, but will vary from negative to positive value, or vice versa, when the tuning point is deviated toward either higher or lower frequency from the correct tuning point.

When the DC output is increased to greater level than the predetermined one, the increased source potential of H312 turns the transistor H315 on. (This means the collector of H309 is grounded, H301 turns off, H317 turns off, and H303 turns on.) This grounds pin ⑧ at the MPX stereo decoding IC, therefore the decoder is set in the monaural mode of operation and the stereo indicator lamp turns off. When the DC output is increased to the predetermined negative level, the decreased source potential turns the H313 off, which turns the H314 on. (This means the collector of H309 is grounded.) The subsequent changes are exactly the same as that just described above.

Thus when the tuning is shifted or deviated to certain frequencies at which undesirable noisy side-audio signals are produced, both muting and monaural/stereo switching transistors H303 are automatically operated and open the circuits.

With the station correctly tuned in, the bias current of the FET H312 is adjusted so that both transistor H314 and H315 are not turned on, giving no effect on the transistor H309.

### 3.2 MPX Stereo Decoding Circuit

The stereo composite signal from the buffer amplifier undergoes phase compensation by R301 and C201, is led through the muting switching FET H301 to the input terminal pin ② of the MPX stereo decoding IC H321 on PLL (Phase Locked Loop) basis, and is decoded into the left and right stereo signals, which become available at pins ④ and ⑤, respectively. These decoded left and right stereo audio signals are introduced through the low pass filter consisting of L301 to L304 and C311 to C320 for elimination of undesirable residual switching signal and through the de-emphasis network consisting of R325, R326, C321 and C322 to the npn-pnp direct coupled audio amplifier, where the signals are amplified to a required level for the output from J311 and J313. From these jacks, the audio signals are led through the function switch to the TAPE MONITOR OUT jacks. Figure 1 presents an internal block diagram showing the functions of the PLL basis MPX stereo decoding IC HA1156. The input stereo composite signal, amplified by the audio amplifier, is delivered to the phase detectors PD-1 and PD-2. A part of the stereo composite signal is also delivered to the stereo decoder section. The VCO (Voltage Control Oscillator) produces a free run oscillation in the neighborhood of 76kHz with the time constant determined by the capacitor C305 and resistors R311 and R312 set on the outside of pin ⑭. The VCO output has its frequency divided into 19kHz through the two frequency divider stages (DIV-1, DIV-2), and is reversed to the phase detector PD-1, which contains two input terminals designed to produce an output in proportion to the product of the two input signals. The signal led to one PD-1 input is a 19kHz square wave formed through frequency division of the 76kHz VCO output signal by the two frequency divider stages DIV-1 and DIV-2, and the 19kHz pilot signal included in the stereo composite signal as a reference signal is led to the other PD-1 input. Therefore, the output of the PD-1 which has passed through the low pass filter LPF-1 provides DC output voltage in proportion to the phase variance between the two inputs. This DC output voltage is amplified by the DC amplifier, and is supplied to the 76kHz VCO as a control voltage. This means that the output frequency and phase of the VCO have been phaselocked to the input pilot signal. The 38kHz sub-carrier reproduced by the PLL, as stated above, is delivered through the stereo switch to the stereo decoder section as switching signal, thus driving the decoder stage. One PD-2 input is given the 19kHz resulting from the frequency division completed by the DIV-1 and DIV-3, whereas the other input gets the 19kHz output contained in the composite signal, and the output is provided with a DC output in proportion to the amplitude of the pilot signal.

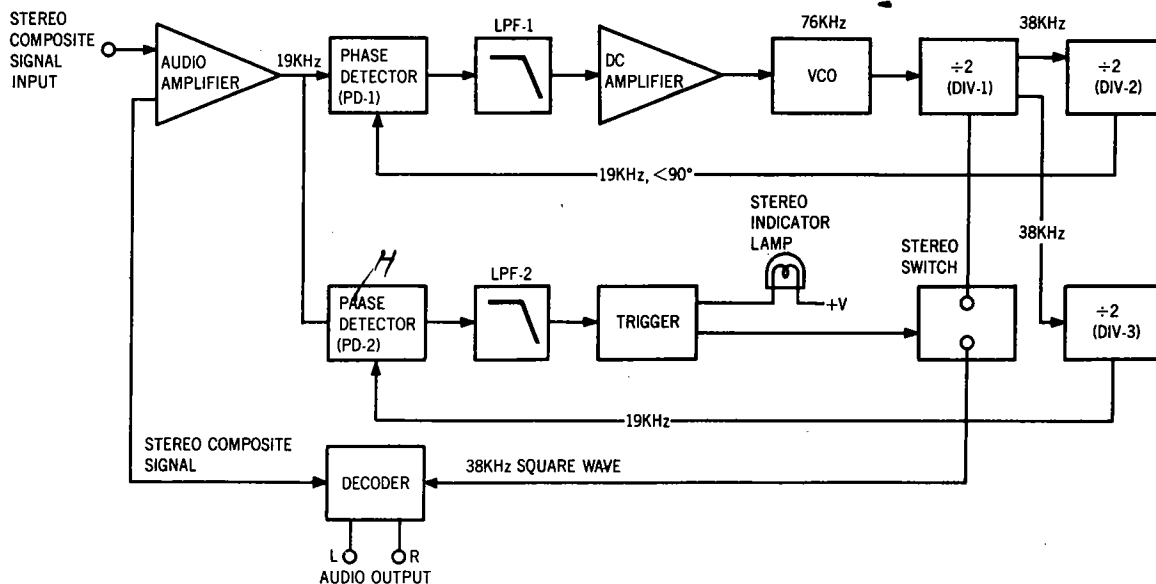

Figure 1. Block Diagram of the HA1156

This DC output is furnished through LPF-2 to the trigger amplifier which drives the stereo indicator lamp and stereo switch. Therefore, insufficient supply of the pilot signal results in failure to light the stereo indicator and to turn on the stereo switch located in the path of the 38kHz switching signal, thereby avoiding a wrong stereo operation.

H303 fitted on the outside of pin ⑧ is a switching transistor for automatic monaural-stereo switchover. When the intensity of an incoming signal from an FM station is weaker than a predetermined level, this H303 is turned on and pin ⑧ is grounded, thereby developing a condition for monaural reception. For a forced monaural operation, switch the MODE switch to "MONO", and H303 comes into the "On" state with the positive bias voltage applied to the base, and pin ⑧ is grounded, thereby establishing monaural operation. The transistor H302 connected externally to pin ⑭ is intended to stop the 76kHz oscillation of the VCO which interferes an AM signal during the reception of an AM station. When the function switch is set to "AM" position, a positive bias is charged on the base of H302, H302 is turned on, and pin ⑭ is grounded. Thus, the oscillation of the VCO is stopped, ending the interference with AM reception.

### 3.3 Suggestion for Troubleshooting FM Tuner

#### 3.3.1 Symptom: No FM Reception

First turn the POWER switch on and try to tune FM stations. Rotate the fly-wheel tuning knob slowly and observe the FM signal strength meter. If the signal strength meter deflects at several frequencies received, the tuner circuits preceding the discriminator circuit may have no failure. When no reading is obtained in the meter, check the FM local oscillator circuit, using an RF VTVM. The normal local oscillator voltage is one or two volts (rms) at the tuning capacitor, depending on the tuning capacitor position. If the local oscillator voltage is normal, then check all voltage distribution in the FM Front End and IF amplifier unit and compare them with those shown in the circuit diagram. When the signal strength meter deflects but no sound is obtained, check the audio circuit, using a high sensitive oscilloscope.

#### 3.3.2 Symptom: No Stereo Separation

First check that the "MODE" switch is in normal 2 CH position. Connect an FM RF signal generator output modulated by a stereo modulator to the rear FM antenna terminals, and check whether the stereo beacon is turned on or not. If not turned on, check for 19kHz VCO output signal (J310), using an oscilloscope and frequency counter.

## 4. PHONO AMPLIFIER

Program source signals from the PHONO jacks on the rear panel are fed to the input circuit of the Phono Amplifier through the selector switch, and the output of the Phono Amplifier is led to another section of the selector switch. This amplifier provides a gain of 40dB.

## 5. BUFFER, TONE AND FILTER AMPLIFIERS

After passing through the FUNCTION switch (S001-2R, -4R) or TAPE MONITOR switch, all signals are converted to low output impedance by the buffer amplifier. The signals, then, are passed through the dolby circuit, MODE switch and HI-BLEND switches and BALANCE and VOLUME controls.

Signals properly attenuated by the VOLUME control are led to the tone amplifier and are subjected to tone control by the BASS, MID and TREBLE controls, and high- and low-cut filter amplifier circuits.

Thus controlled audio signals are then led to the PRE OUT jacks on the rear panel.

## 6. POWER AMPLIFIER

The signal from the tone filter amplifier is applied to the differential amplifier (base of H701)



through the coupling capacitor C701. The differential amplifier provides very high input impedance, and its collector output (H702) is led to the base of H705 which in turn feeds its output to the next stages: H706 through the network of R721, C710 and R728, and H707 through the network of R721, C711 and R729. The outputs of H706 and H707 are led to the H708 and H709, respectively. H001, H002, H003 and H004 are power transistors used in complementary symmetry configuration and mounted on the heat sink.

To maintain overall amplifier stability and linearity, a degenerative feed back is utilized throughout the amplifier. This feedback is also necessary to reduce distortion to within a specified limit. The RC network of R728 and C710 conditions the feedback signal for the audio signals. R729 and C711 also form a feed back loop provided to obtain a stable zero DC offset voltage at the speaker output terminals. The R713 is a trimming resistor to adjust the DC offset voltage.

A dynamic bias is applied to the bases of driver transistors H708 and H709. This dynamic bias circuit comprises H714, H715 and R740. This provides a variable base bias for driver transistors that automatically maintains the proper base voltage to temperature change. The temperature sensitive biasing components of the dynamic circuit are thermally coupled through the heat sink with the power amplifier transistors.

## **7. POWER PROTECTION CIRCUIT**

A protection circuit for the amplifier is provided by sensing resistor networks and two switching transistors. When the output transistors are over-driven, the current increase through the power output transistor causes increase of the current flowing through R746. This increased voltage potential is applied to the base of H710 through the resistor R732 and turns H712 on. This means that the base of H708 is by-passed through the emitter-collector path of H712 to the ground, since the emitter of H712 is connected through R730 to the base of H708. Thus, the input signal to H708 is restricted to the value which maintains the operation of power transistor within the safety area. A resistor network of R736, R738 and H720 also works as a sensing network. If the center voltage (collector voltage of the power transistors) is excessively increased to a positive value by some troubles, the voltage applied to the base of H710 turns the H712 on, making bypass circuit to protect the power transistors. For the other half cycle of the drive signal, the same operating principle is applied as described above.

## **8. SPEAKER PROTECTOR RELAY CIRCUIT**

The speaker protection circuit consisting of H805, H806, H807, and associated parts protects the speaker system against any loud "pop" sound developed. This circuit is so designed that no sound is heard for the first three or five seconds after the power switch is turned on by the time constant circuit consisting of C813 and R816. This circuit also protects the speaker system against some troubles due to DC unbalance between the speaker system terminals by instantly operating the relay and cutting off the speaker system from the circuit. If the DC unbalance voltage (positive) is developed between speaker terminals by possible defects such as broken power transistor, short-circuits, or broken potentiometer R713, as the base of H808 is connected to the speaker terminal, the transistor H805 is turned on by the offset voltage developed. This turns the transistors H806 and H807 off, thus cutting off the relay and disconnecting the speaker from the output circuit. If a negative offset voltage is developed, this voltage directly turns the H806 and H807 off, which disconnect the speaker from the circuit and protected.

The circuit also protects the speaker system from possible damage if the amplifier is over-driven by very low frequency such as 7 or lower cycles per second.

## **9. DOLBY UNIT**

The Dolby unit built in the Model 2325, which is a switchable processor, is inserted in each of both R and L channels. The attached "DOLBY PROCESSING CHART" will facilitate you to well understand the operation of the Dolby circuit.

An input signal coming to J601 is amplified by H601, and its output signal is led to the filter which cuts off the tape bias. The signal passed through the filter is further amplified and comes to the mixing circuit of the resistors R623 and R625 and to the phase inverting circuit of H607 and H609. The output signal is fed out of J607.

In the recording mode of operation, the signal is fed out of J605 preceding the mixing circuit and is led to J611. The signal is then discriminated in the frequency and level by the dynamic filter consisting of H611, H613, H615 and H617, and is fed back to the mixing circuit.

In the playback mode of operation, a part of the output signal (at J607) is led to J611 and discriminated in the frequency and level by the dynamic filter consisting of H611, H613, H615 and H617 and fed back to the mixing circuit.

#### **10. 400Hz TONE**

The 400Hz tone signal which is a 580mV, 400Hz sine wave is available at the TAPE MONITOR OUT terminal at any position of the DOLBY switch (with the exception of the RECORD II position) and SELECTOR switch

The output signal of the 400Hz oscillator consisting of HL01 and HL02 is delivered through the emitter follower HL03 to JL02 and JL03. The output levels at JL02 and JL03 are adjusted to 580mV and approximately 50mV, respectively.

The signal fed from the Dolby Unit P.W. Board (P600) comes to JL04 and is rectified through HL06. The rectified output at JL06 is led to the meter M002.

#### **11. DOLBY SWITCH**

This switch sets the Dolby noise-reduction circuit for record or playback and also switches the meter from the AM or FM SIGNAL STRENGTH mode to the DOLBY CAL LEVEL mode, or vice-versa. With the DOLBY switch placed in "OFF" position, the meter will be used as a SIGNAL-STRENGTH meter; in all other positions as a DOLBY CAL LEVEL meter.

##### **11.1 DOLBY FM**

This position is used to listen to Dolbyized FM broadcasts. The Dolby FM level has been pre-adjusted at the factory.

##### **11.2 PLAY**

This position is used to play back a Dolbyized source (except ~~FM~~).

##### **11.3 OFF**

With this position, the Dolby circuit is by-passed and the input signals are directly fed to both TAPE MONITOR OUT jacks and amplifiers.

##### **11.4 RECORD I**

For making a Dolbyized recording from an in-coming "flat" (non-Dolbyized) signal. When the MONITOR switch is in the SOURCE (out) position, the "flat" signal will be heard. When the MONITOR switch is in the TAPE (in) position, the Dolbyized signal from the tape will be heard.

##### **11.5 RECORD II**

For making a "flat" (non-Dolbyized) recording from an in-coming Dolbyized signal. Regardless of the position of the MONITOR switch, a "flat" signal will be heard.

#### **12. RECORD LEVEL (L) AND (R) KNOBS**

These knobs control the record level of the signals to be recorded through the Dolby Unit. Adjust the knobs so that the Level Meter pointers on the tape recorder do not exceed the 0VU level.

### 13. PLAY CAL. (L) AND (R) KNOBS

These knobs adjust the playback outputs from a tape deck to the proper Dolby level.

### 14. DOLBY FM PRESET LEVEL CONTROLS

These factory-adjusted controls govern the FM output level to the Dolby circuit. These controls are for the use of a qualified technician only.

### 15. 400Hz TONE SWITCH

This is used for calibration of the record input level of the tape deck. When the switch is depressed, the built-in oscillator operates and a 580mV sine wave signal output will be fed to the four TAPE MONITOR OUT jacks.

### 16. SUGGESTIONS FOR TROUBLESHOOTING POWER AMPLIFIER

#### 16.1 Excessive Line Consumption

- Check for shorted rectifiers H009 and H010; also check C008 and C009.
- Check for shorted transistors H708 and H709. H001, H002, H003, H004, H005, H006, H007 and H008, or check H715. Check for bias transistor H714. Check L004 for short.

**CAUTION: BECAUSE THE DRIVER AND OUTPUT STAGES ARE DIRECT COUPLED, COMPONENTS MAY FAIL AS A DIRECT RESULT OF INITIAL COMPONENT FAILURE. IF A SHORTED TRANSISTOR OR ZENER DIODE IS FOUND, OR CONTROL OR BIAS DIODE, BE SURE TO CHECK THE REMAINING DRIVER AND OUTPUT COMPONENTS FOR SHORT OR OPEN CIRCUIT BEFORE REENERGIZING THE AMPLIFIER.**

#### 16.2 No Line Consumption of Zero Bias

- Check the line cord, fuse, transistors H715, H001, H002, H003, H004, H005, H006, H007 and H008, and bias transistor H714.
- Check for open rectifiers H009 and H010 or open L004.

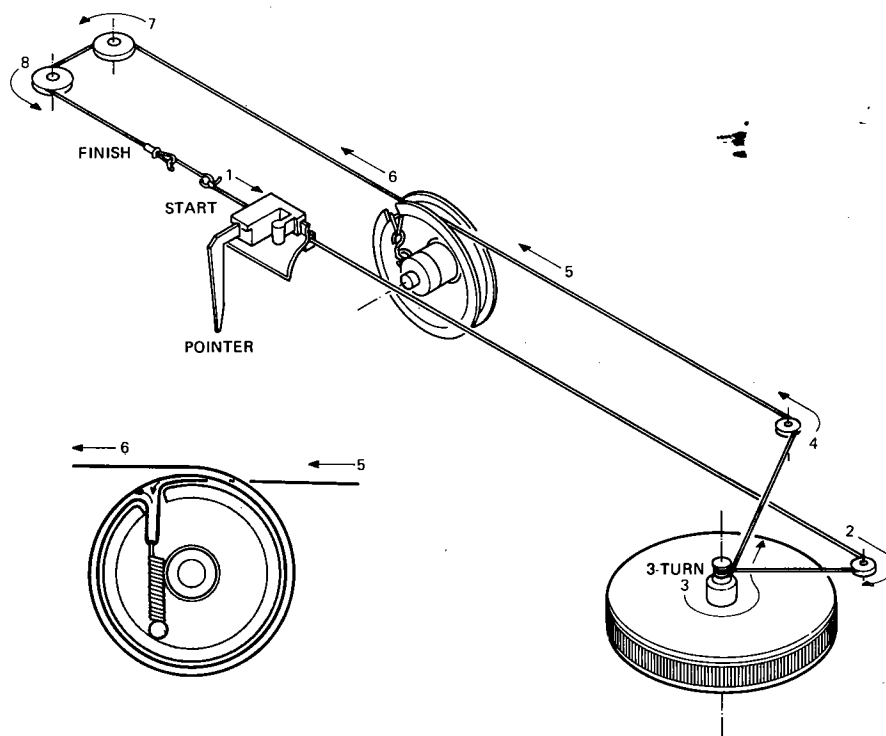

Figure 2. Dial Stringing

**17. TEST EQUIPMENT REQUIRED FOR SERVICING**

Table 1 lists the test equipment required for servicing the Model 2325 Stereophonic Receiver.

Item	Manufacturer and Model No.	Use
AM Signal Generator		Signal source for AM alignment.
Test Loop		Used with AM Signal generator.
FM Signal Generator	Less than 0.3% distortion	Signal source for FM alignment.
Stereo Modulator	Less than 0.3% distortion	Stereo separation alignment and trouble shooting.
Frequency Counter		MPX Oscillator adjustment (VCO).
Audio Oscillator	Weston Model CVO-100P, less than 0.02% residual distortion is required.	Sinewave and squarewave signal source.
Oscilloscope	High sensitivity with DC horizontal and vertical amplifiers.	Waveform analysis and trouble shooting and ASO alignment.
VTVM	With AC, DC, RF range	Voltage measurements.
Circuit Tester		Trouble shooting.
AC Wattmeter	Simpson, Model 380	Monitors primary power to Amplifier.
AC Ammeter	Commercial Grade (1-10A)	Monitors amplifier output under short circuit condition.
Line Voltmeter	Commercial Grade (0-150V AC)	Monitors potential of primary power to amplifier.
Variable Autotransformer (0-140V AC, 10 amps)	Powerstat, Model 116B	Adjusts level of primary power to amplifier.
Shorting Plug	Use phono plug with 600 ohm across center pin and shell.	Shorts amplifier input to eliminate noise pickup.
Output Load (8 ohms, ±1% 100W)	Commercial Grade	Provides 8-ohm load for amplifier output termination.
Output Load (4 ohms, ±1% 100W)	Commercial Grade	Provides 4-ohm load for amplifier output termination.

**Table 1. Test Equipment Required for Servicing**

**18. AM ALIGNMENT PROCEDURES**

**18.1 AM IF ALIGNMENT**

1. Connect a sweep generator to J153 and an alignment scope to the test point ⑥.
2. Turn each core of IF transformer L153 for maximum height and flat top symmetrical response.

**18.2 AM Frequency Range and Tracking Alignment**

1. Set an AM signal generator to 515kHz. Turn the tuning capacitor fully closed (with the tuning pointer placed at the low end.) and adjust the oscillator coil L152 for maximum audio output.

2. Set the signal generator to 1650kHz. Place the tuning pointer in the high frequency end and adjust the oscillator trimmer on the oscillator tuning capacitor for maximum audio output.
3. Repeat Steps 1 and 2 above until no further adjustment is necessary.
4. Set the signal generator to 600kHz and tune the receiver to the same frequency and adjust the slug core of the AM ferrite rod antenna and RF coil L151 for maximum output.
5. Set the signal generator to 1400kHz and tune the receiver to the same frequency and adjust both trimming capacitors of the antenna and RF tuned circuit for maximum output.
6. Repeat Steps 4 and 5 above until no further adjustment is necessary.

Note: During tracking alignment reduce the signal generator output as necessary to avoid AGC action.

### 18.3 AM Signal Strength Meter Adjustment

Set the AM Signal generator to 1000kHz with  $5\text{K}\mu\text{V}$  output level, and adjust R178 until the signal strength meter may read 80%.

## 19. FM ALIGNMENT PROCEDURES

1. Connect an FM signal generator to the FM ANTENNA terminals and an oscilloscope and an audio distortion analyzer to the TAPE MONITOR OUT jacks on the rear panel.
2. Set the signal generator to 87.0MHz and provide about 3 to  $5\mu\text{V}$ . Place the tuning pointer at the low frequency end by turning the tuning knob and adjust the core of the oscillator coil L105 for maximum audio output.
3. Set the signal generator to 109.0MHz and provide about 3 to  $5\mu\text{V}$  output. Turn the tuning knob to place the tuning pointer to the high frequency end and adjust the trimming capacitor C106 for maximum output.
4. Repeat Steps 2 and 3 above until no further adjustment is necessary.
5. Set the signal generator to 90MHz and tune the receiver to the same frequency. Decrease the signal generator output until the audio output level decreases with decrease of the signal generator output. Adjust the antenna coil L101, RF coils L102, L103, and L104, and IF transformer L106 for minimum audio distortion.
6. Set the signal generator to 106MHz and tune the receiver to the same frequency. Adjust the trimming capacitors (C102, C103, C104, C105) of the antenna and RF tuning circuits for minimum distortion.
7. Repeat Steps 5 and 6 above until no further adjustment is necessary.
8. Adjust the secondary core (upper) of the discriminator transformer L201 until the center tuning meter pointer indicates its center with no signal applied. Set the signal generator to 98MHz and increase its output level to  $1\text{k}\mu\text{V}$  and tune the receiver to the same frequency so that the center tuning meter pointer indicates its center. Adjust the primary core (lower) of L201 for minimum distortion.
9. Set the signal generator to 98MHz with  $100\text{k}\mu\text{V}$ , and adjust R374 until signal strength meter may read 90%.

### 19.1 Stereo Separation Alignment

1. Set an FM signal generator to provide  $1\text{K}\mu\text{V}$  at 98MHz. Tune the receiver to the same frequency so that the center tuning meter pointer indicates its center. Then turn off the modulation of the signal generator, connect a frequency counter to the test point J310 (point ©) and adjust R311 until the frequency counter may precisely read 19kHz.
2. Modulate the signal generator with the stereo composite signal composed of either L or R channel (of course, the pilot signal must be included).
3. Adjust the trimming resistor R301 for maximum and same separation in both channels.

## 19.2 Muting Circuit Alignment

1. Connect a VTVM to the tap of the resistor R363 and adjust the resistor R363 until the meter reads 0.75V DC at no signal.
2. Set an FM signal generator to provide 1K $\mu$ V at 98MHz and tune the receiver to the same frequency correctly.
3. Turn the MUTING pushswitch on. Shift the FM signal generator frequency higher and lower and note both higher and lower shifted frequencies at which undesirable audio side responses are muted out. Adjust R363 so that the same shifted frequencies mute the undesirable audio side responses.
4. Adjust R362 for preferred frequency shift at which the muting circuit operates.

## 20. AUDIO ADJUSTMENT

### 20.1 Automatic Voltage Regulator Adjustment

Connect a DC voltmeter between pins J804 and J805, and adjust the trimming resistor R809 for 35V DC.

### 20.2 Main Amplifier DC Offset Alignment

Connect a DC voltmeter with 0.5 or 1V range between the speaker terminals and adjust the trimming resistor R713 for "zero" DC output on the meter.

Repeat the same procedure for the other channel.

Note: During this alignment no load should be connected to the speaker terminals.

### 20.3 Idle-Current Adjustment

Connect a VTVM between pins J702 and J708. Next, rotate the trimming resistor R740 fully counterclockwise, then rotate it clockwise until the VTVM reads 15mV DC (75mA).

Repeat the same procedure for the other channel.

Note: During this alignment no load should be connected to the speaker terminals.

### 20.4 Main Amplifier DC Offset Re-Alignment

Check the DC offset voltage aligned in the Sec. 20.2 above. If any DC output is observed on the DC voltmeter, adjust R713 again for "zero" output.

### 20.5 Phono-Amplifier Adjustment

Connect an oscilloscope to the TAPE MONITOR OUT jacks and an audio signal generator to the PHONO jacks. Place the selector switch in the PHONO position. Increase the 1kHz audio signal level gradually until a slight clipping on top of the sine wave is observed on the oscilloscope. Adjust the trimming resistor R408 for equal clipping level.

For the other channel, adjust R409.

## 21. DOLBY ALIGNMENT PROCEDURE

Prior to the adjustment, turn the PLAY CAL and REC LEVEL controls all the way to the right and the SELECTOR switch to the CD-4/AUX position. Use the CD-4/AUX and TAPE MONITOR OUT jacks for the signal input and output.

### 21.1

- (1) Set the DOLBY switch to the RECORD I position.
- (2) Adjust the semi-fixed resistor R653 for maximum source voltage of the field-effect transistor H611.

- (3) Connect J620 and J613 to the ground.
- (4) Apply a 5kHz sine wave so as to obtain 17.5mV at J605.
- (5) Record the output level at the TAPE MONITOR OUT jack with the above signal applied.
- (6) Adjust the semi-fixed resistor R659 until the output level at the TAPE MONITOR OUT jack may increase  $10 \pm 0.25$ dB with J620 disconnected from the ground.
- (7) Record the above output level.
- (8) Adjust the semi-fixed resistor R653 until the output level may decrease  $2 \pm 0.25$ dB with J613 disconnected from the ground.
- (9) Connect J613 to the ground again, and assure the level increase in Step (6) above. Disconnect J613.

### 21.2

- (1) Set the DOLBY switch to the RECORD II position.
- (2) Connect J620 and J613 to the ground.
- (3) Apply a 5kHz sine wave so as to obtain a 44mV at J605.
- (4) Check to insure that the level at the TAPE MONITOR OUT jack decreases  $10 \pm 0.5$ dB with J620 disconnected from the ground.
- (5) Disconnect J620 and J613 from the ground.
- (6) Check to insure that the output voltage at the TAPE MONITOR OUT jack is 17.5mV( $\pm 0.5$ dB).

### 21.3

For the level adjustment, set the DOLBY switch and SELECTOR switch to the RECORD I and CD-4/AUX positions, respectively, and use the TAPE MONITOR OUT jack for the signal output. By setting the 400Hz TONE pushswitch "in", the 400Hz sine wave is fed out. Adjust the semifixed resistor RL11 for 580mV sine wave output voltage in both R and L channels. Then, set the DOLBY switch to the RECORD II position, and apply the 400Hz signal for 580mV output voltage. Adjust the semi-fixed resistors RL28 and RL29 until the DOLBY LEVEL meter may point the Dolby level. Change over the METER switch, and perform this adjustment for both R and L channels.

Next, adjust the semi-fixed resistor RL12 for 580mV output level with the DOLBY switch set to the OFF position. Check the 400Hz output signal level after the level setting of semi-fixed resistors RL11 and RL12. The output level must be precisely 580mV since it is the reference level of the Dolby circuit.

## 22. DOLBY FM PRESET LEVEL CONTROL ALIGNMENT PROCEDURES

Connect an FM signal generator to the FM antenna. Set the signal generator for 400Hz and 50% modulation.

Set the FM signal generator to 98MHz and the DOLBY switch to the OFF position. Turn the Tuning knob on Model 2325 until it tunes the 98MHz signal from the FM signal generator.

Then, set the DOLBY switch to the DOLBY FM position, and adjust the FM preset level controls RC05 and RC06 until the DOLBY LEVEL meter may point the Dolby level. Change over the METER switch, and perform this adjustment for both R and L channels.

**23. DESCRIPTION OF DOLBY PROCESSING CHART**

This chart shows the condition of the signals available at the speakers (SPKRS) and at the TAPE MONITOR OUT terminals as a function of different control settings.

To understand the chart refer to the symbols below:

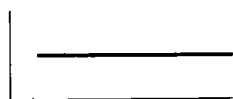

— Represents a signal which has not been applied to either Record or Playback Dolby circuits. The relative amplitudes at all audio frequencies remain unaltered at all levels.

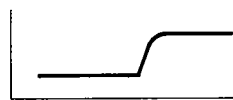

— Represents a signal which has been processed by the Dolby Record circuit. The relative amplitudes at high frequencies are increased at low signal levels.

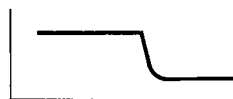

— Represents a signal which has been processed by the Dolby Playback circuit. The relative amplitudes at the high frequencies are decreased at low signal levels.

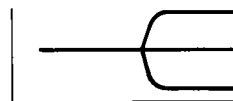

— Represents a signal which has been processed by both the Record and the Playback Dolby circuits.

The Dolby Record and Playback circuits are complementary. Therefore, relative amplitudes at all audio frequencies are restored to their original levels.



SIGNAL	DOLBY SW		DOLBY FM		PLAY		OFF		RECORD					
	↑								I		II			
	TAPE MON	SIGNAL AT	SOURCE	TAPE	SOURCE	TAPE	SOURCE	TAPE	SPKRS	TAPE OUT	SPKRS	TAPE OUT	SPKRS	TAPE OUT
FM TRANSMISSION														
NORMAL FM														
DOLBY FM (25 μS W/DOLBY)														
OTHER SOURCE														

NOTE: \*\* DE-EMPHASIS SWITCH IN THE 25 μS POSITION.

Table 2. Dolby Processing Chart

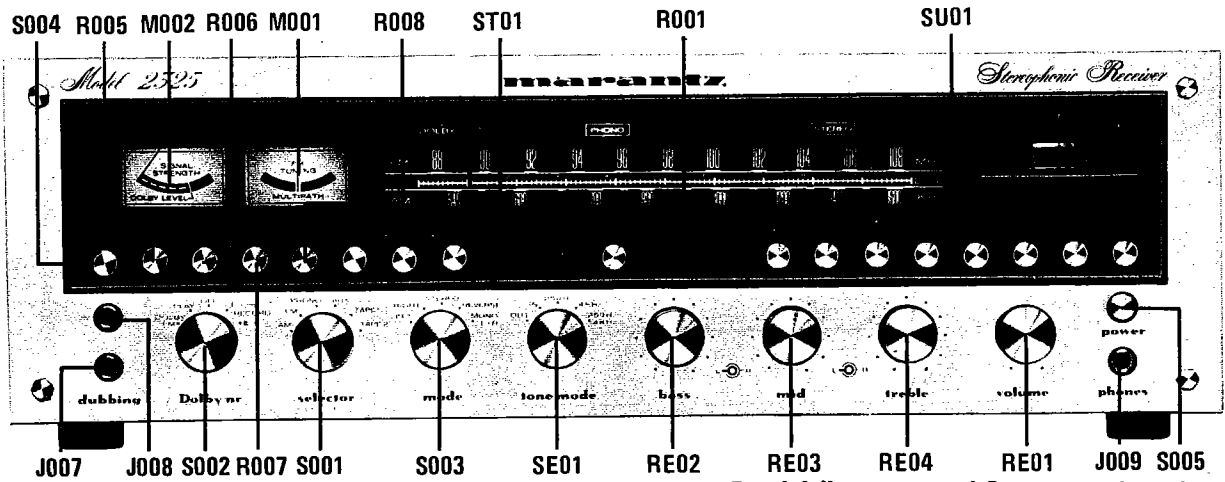

Figure 3. Front Panel Adjustments and Component Locations

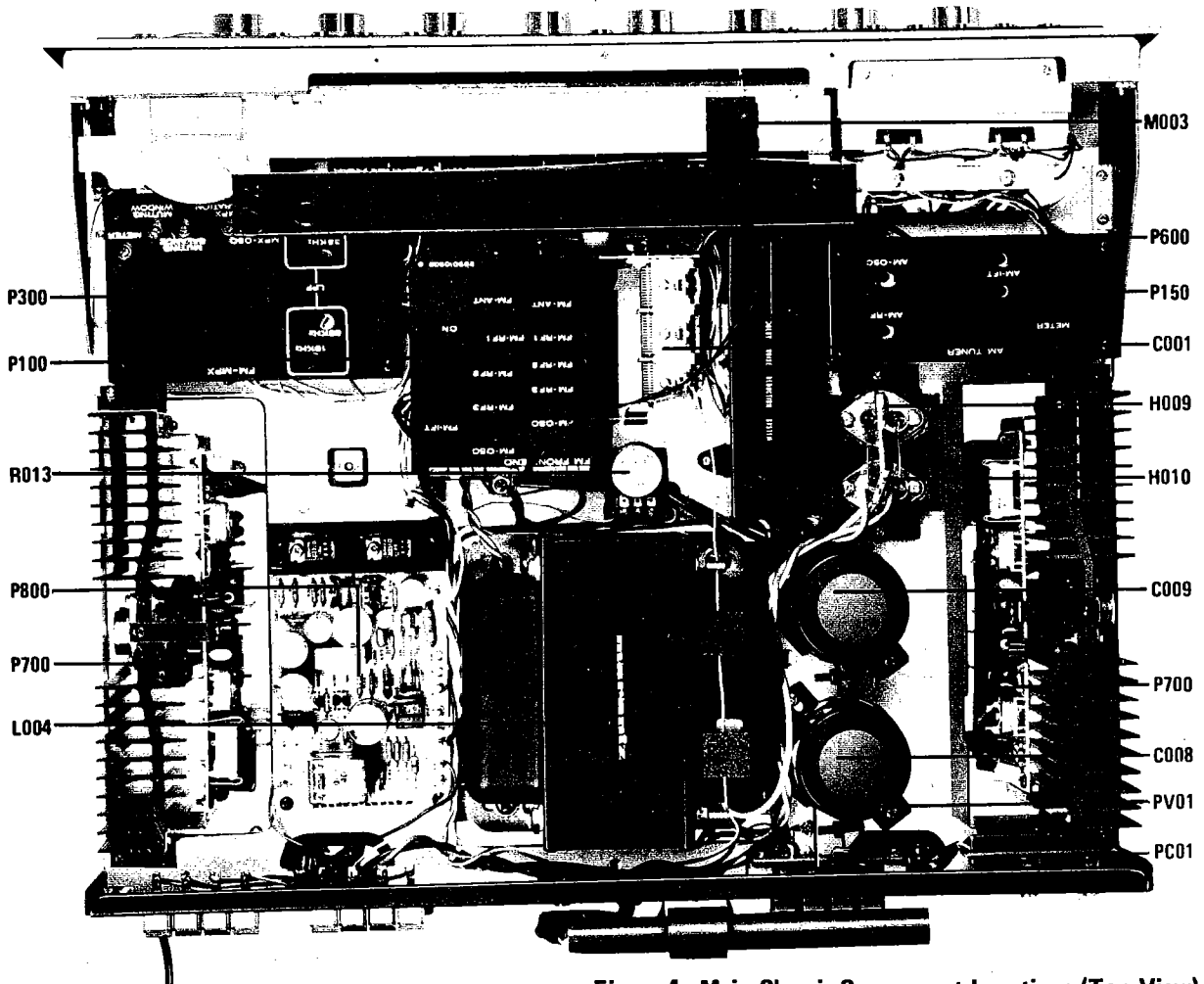

Figure 4. Main Chassis Component Locations (Top View)

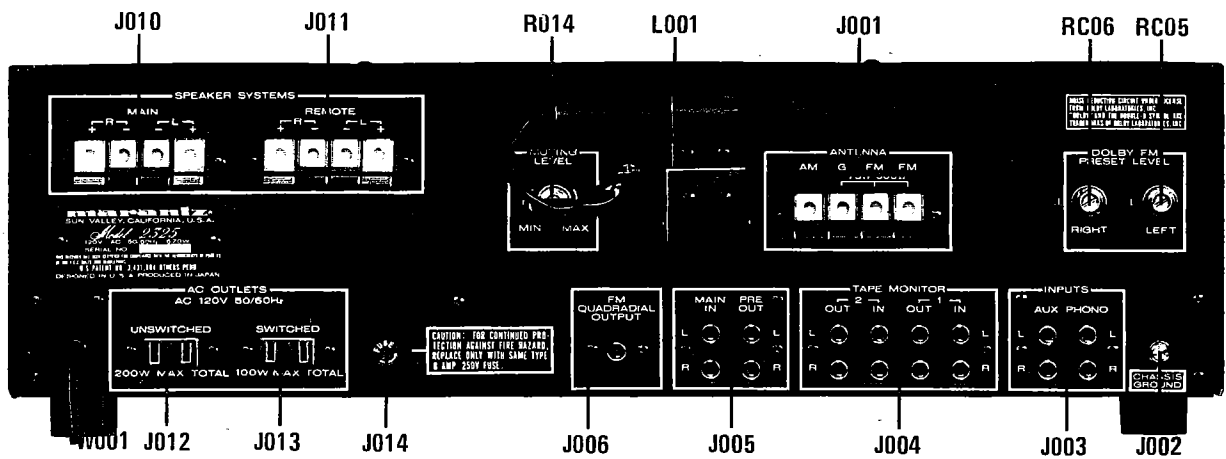

Figure 5. Rear Panel Adjustments and Component Locations

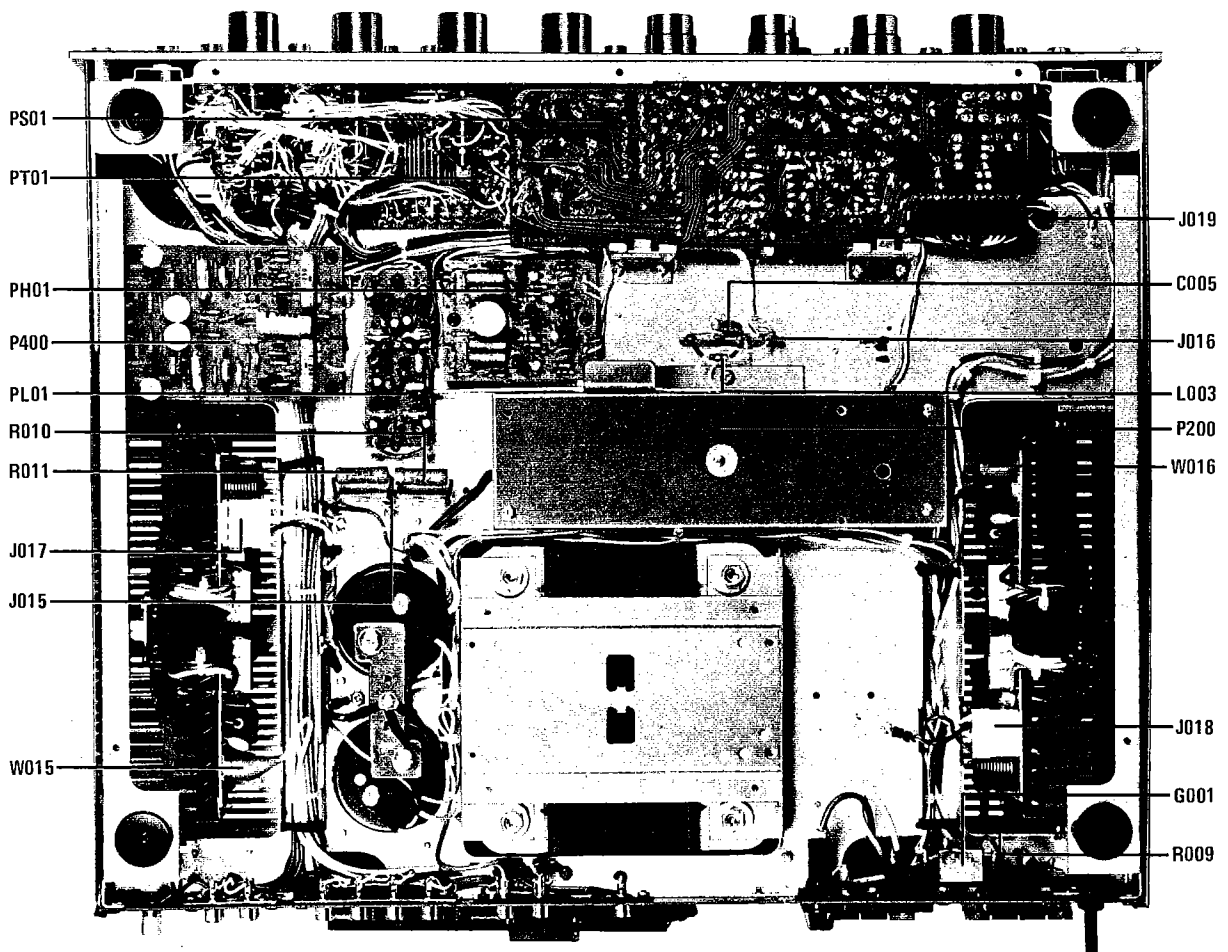

Figure 6. Main Chassis Component Locations (Bottom View)

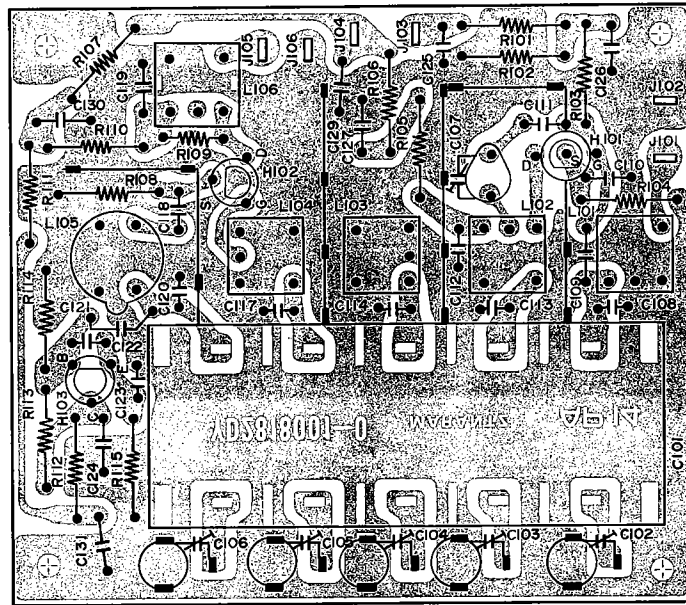

Figure 7. FM Front End Assembly P100 Component Locations

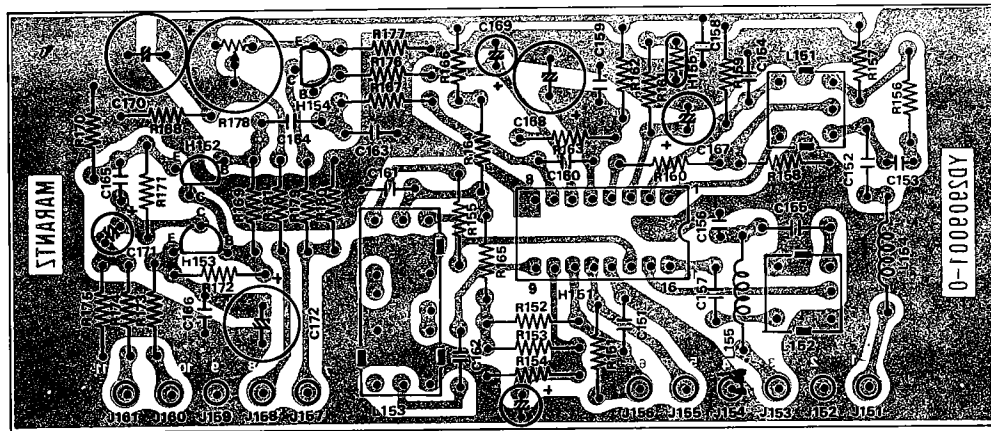

Figure 8. AM Tuner Assembly P150 Component Locations

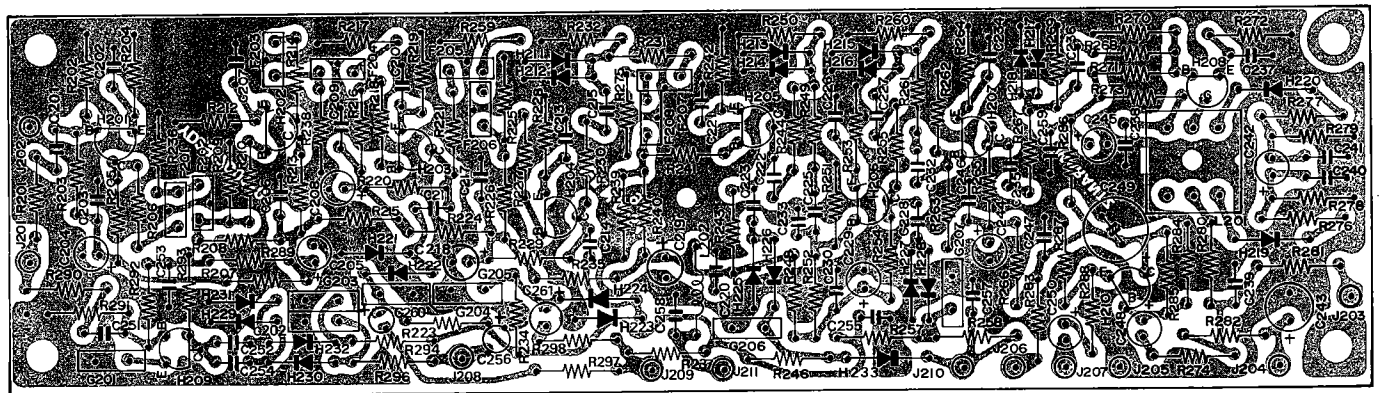

Figure 9. FM IF Amplifier Assembly P200 Component Locations

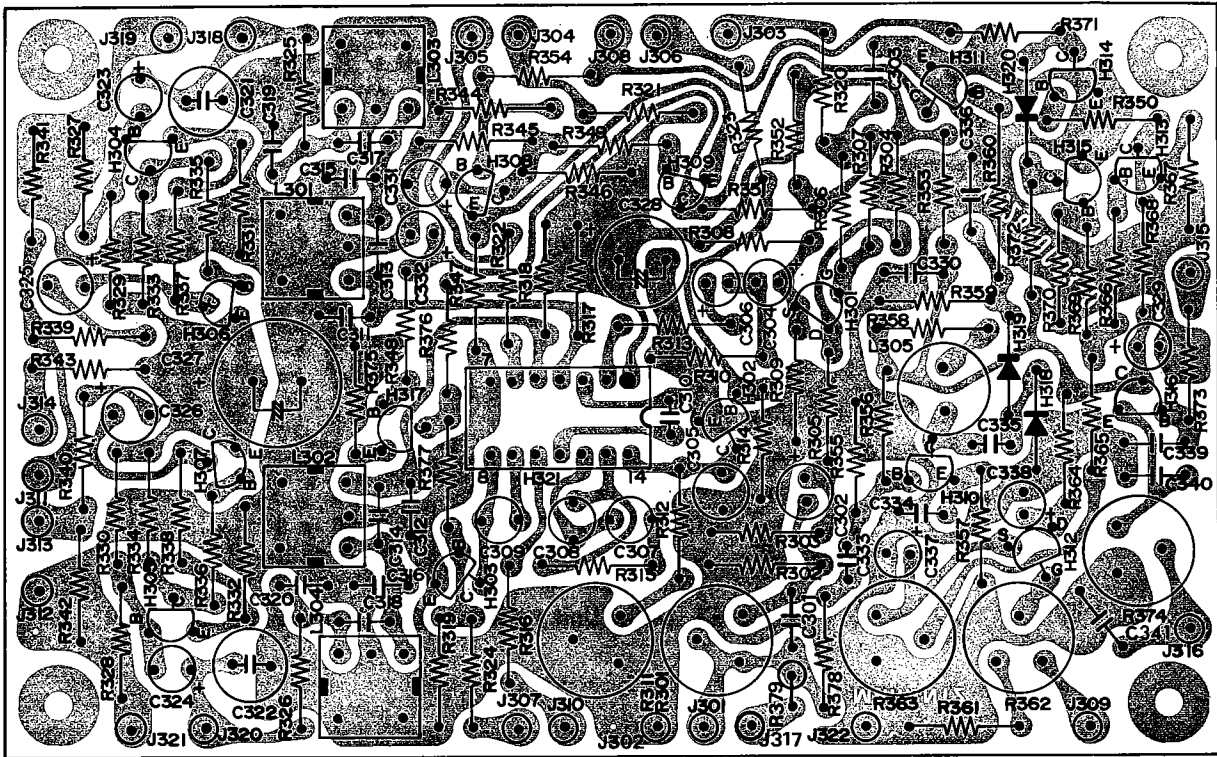

Figure 10. MPX Stereo Decoding Amplifier Assembly P300 Component Locations

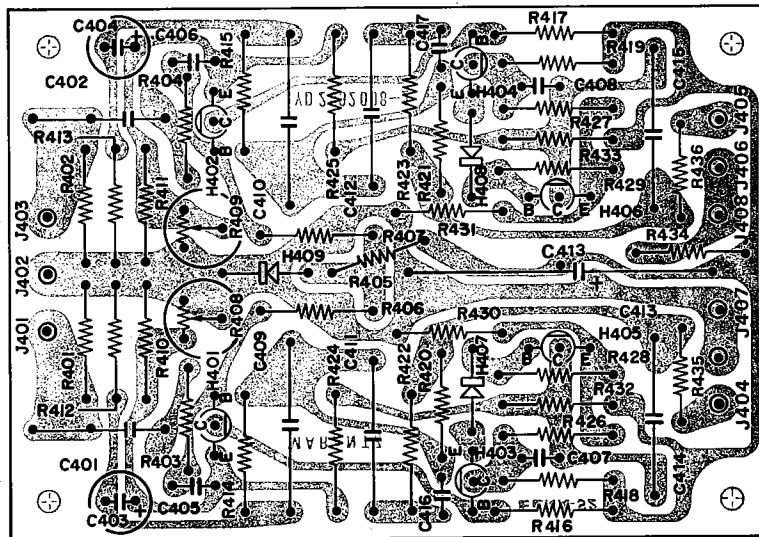

Figure 11. Phono Amplifier Assembly P400 Component Locations

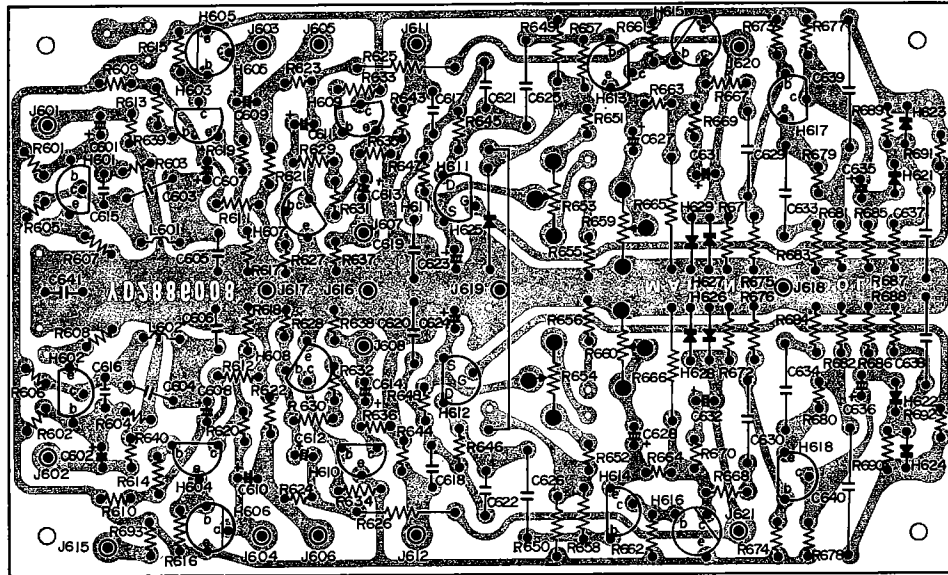

Figure 12. Dolby Unit Assembly P600 Component Locations

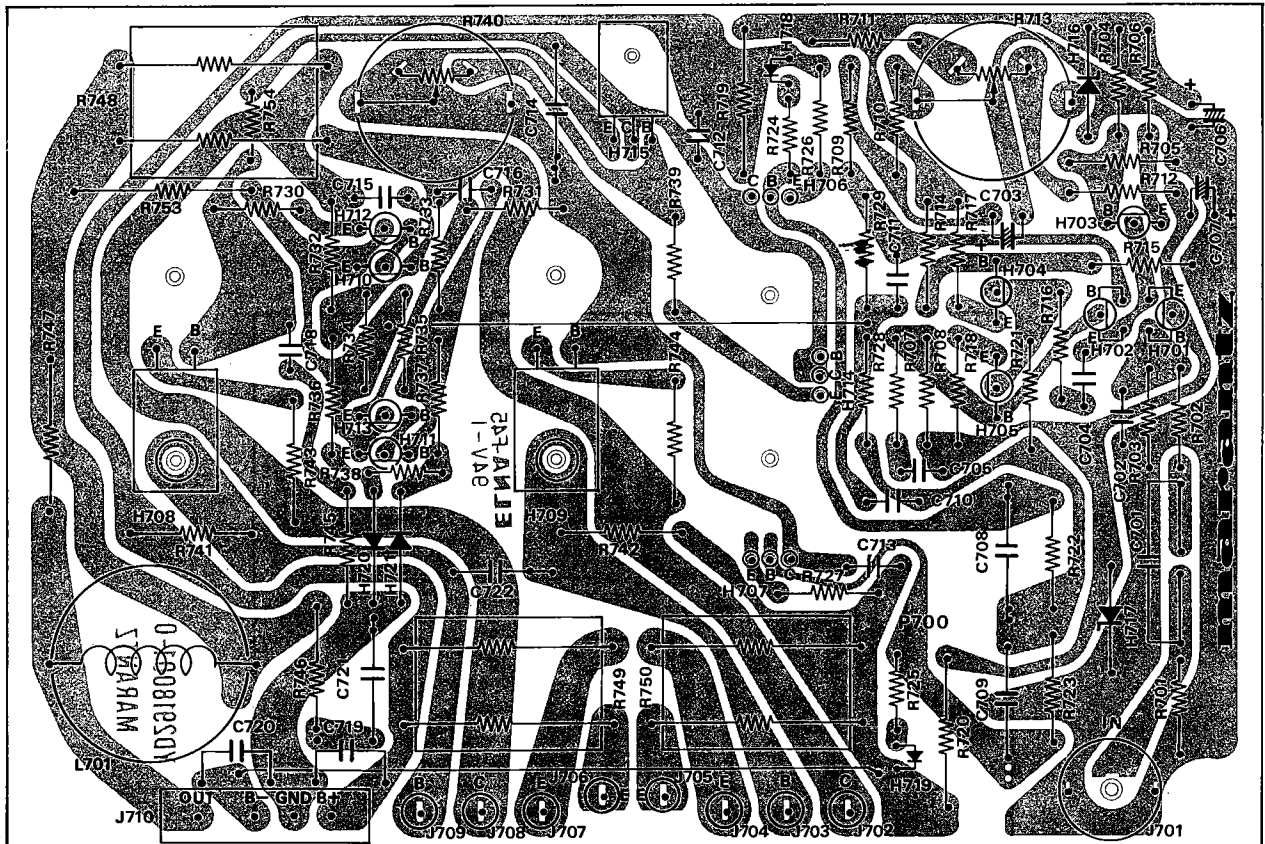

Figure 13. Power Amplifier Assembly P700 Component Locations

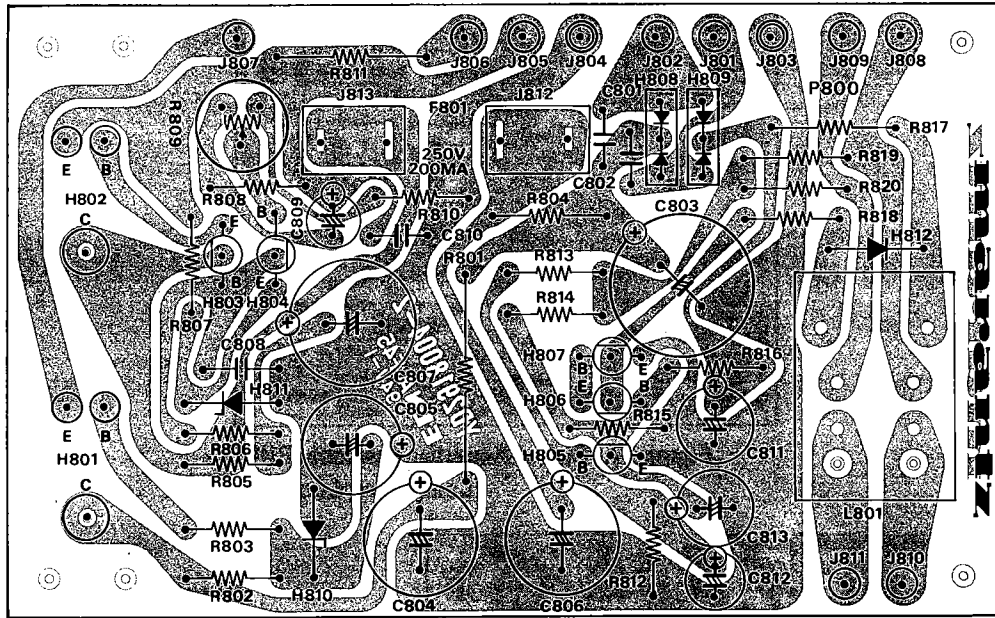

Figure 14. Power Supply and Protection Relay Circuit Assembly P800 Component Locations

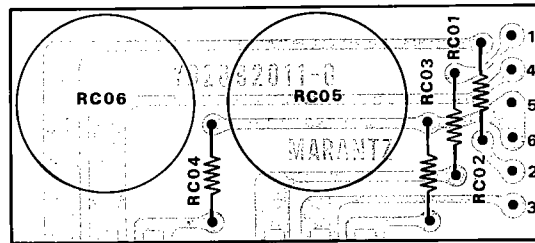

Figure 15. FM Cal. and De-Emphasis Assembly PC01 Component Locations

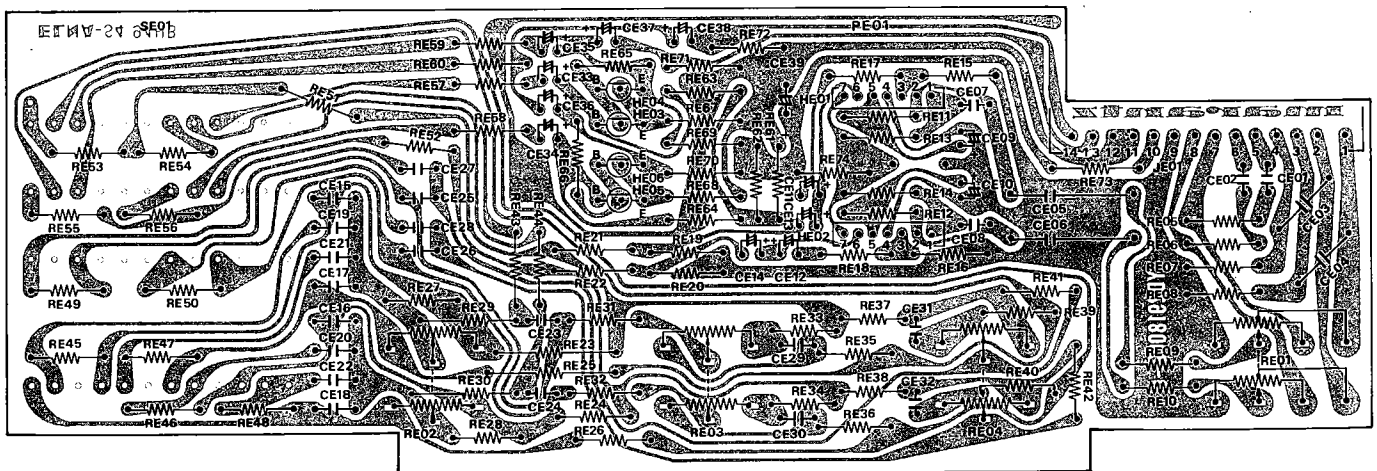

Figure 16. Pre and Tone Amplifier Assembly PE01 Component Locations



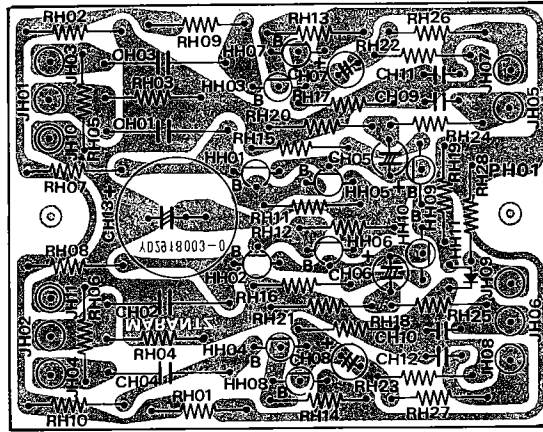

Figure 17. Buffer Amplifier Assembly PH01 Component Locations

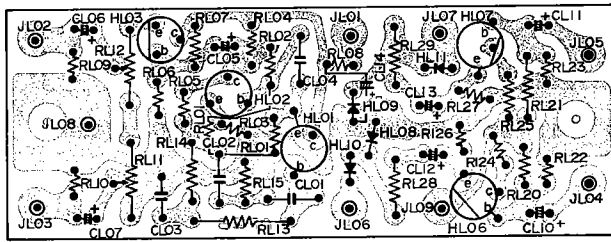

Figure 18. Dolby, Tone and Meter Assembly PL01 Component Locations

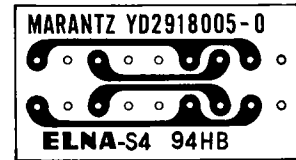

Figure 19. Dolby Tone, Tape Mon. Assembly PS01 Component Locations

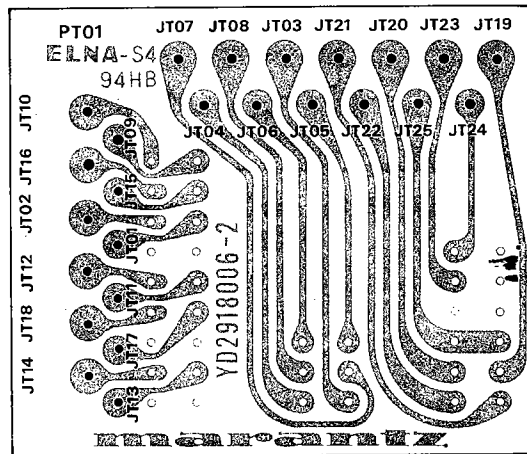

Figure 20. Tape Monitor Assembly PT01 Component Locations

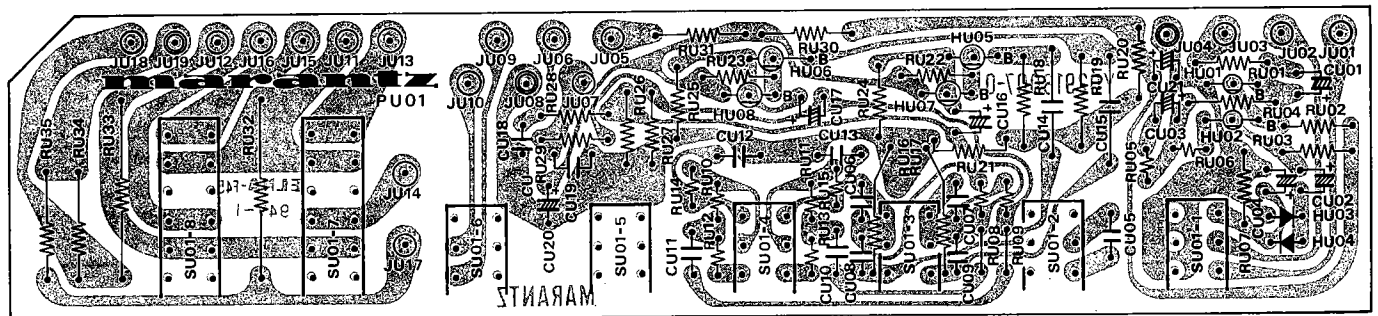

Figure 21. Multipath, Hi Blend, FM Muting, Low Filter, Hi Filter, Loudness, Main Speaker and Remote Speaker Assembly PU01 Component Locations



NOTE

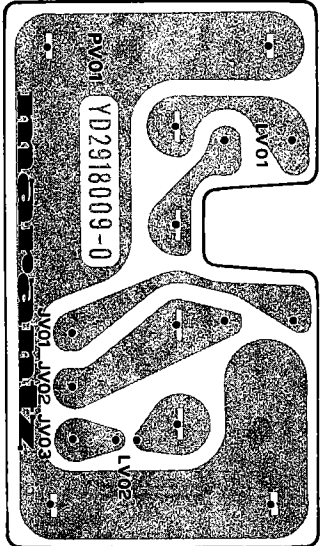

Figure 22. Antenna Terminal Assembly  
PY01 Component Locations



Figure 23. Function Lamp Assembly PY01 Component Locations

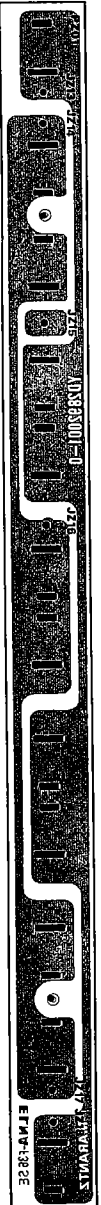

Figure 24. Dial Lamp Assembly PZ01 Component Locations

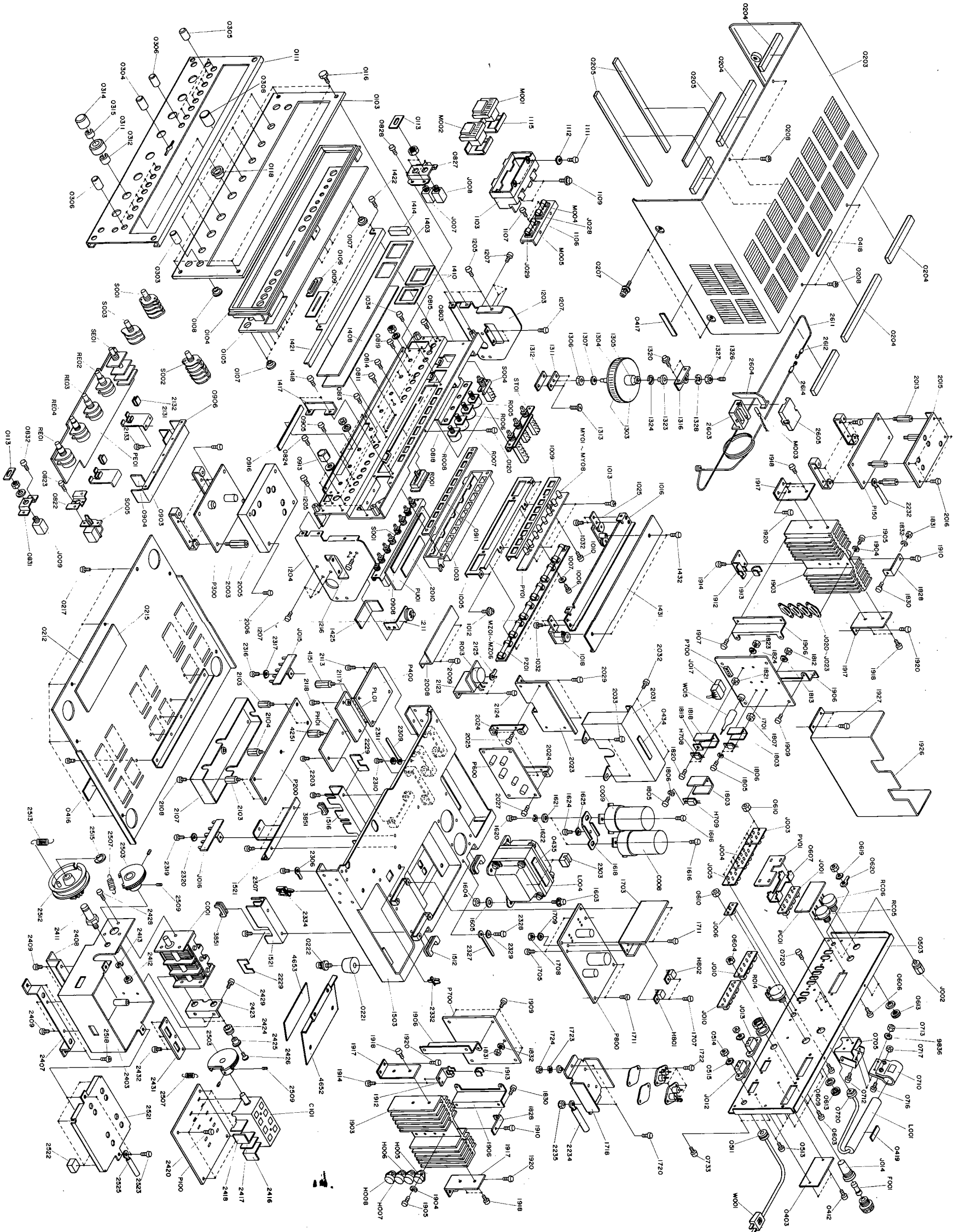

Figure 25. Exploded Mechanical Diagram

**PARTS LIST**

U ..... U.S.A.  
E ..... Europe

REF. DESIG.	U	E	PART NO.	DESCRIPTION
A	1	1	291806340	Front Panel Assembly
0103	1	1	291806301	Escutcheon
0104	1	1	289240101	Frame
0105	1	1	291815801	Window
0106	1	1	285425901	Bush
0107	12	12	288625901	Bush
0108	1	1	288625901	Bush
0109	1	1	291510701	Sheet
0111	1	1	291805301	Cover
B	1	1	289225742	Top Lid Assembly
0203	1	1	289225701	Lid
0204	4	4	257711807	Spacer
0205	3	3	289205602	Buffer
0417	1	1	257886102	Label Do Not Remove .....
0418	1	1	257886103	Label See Marking .....
4651	2	2	291805601	Buffer
C	1	1	291825740	Bottom Lid Assembly
0212	1	1	291825750	Lid K
0215	1	1	291512001	Insulator
D	3	3	281815440	Knob Assembly, Bottom
0311	3	3	281815404	Knob
0312	3	3	71400149Q	Spring
E	3	3	281815441	Knob Assembly, Top
0314	3	3	281815405	Knob
0315	3	3	71400159Q	Spring
F	1	1	291510342	Pointer Assembly
2603	1	1	291510301	Pointer
2604	1	1	285010301	Pointer
2605	1	1	291510302	Cover
M003	1	1	IN1008030	Lamp
G	1	1	120200640	Hook Assembly
2611	1	1	72080802A	String
2612	1	1	120225801	Hook
H	1	1	285327340	Fly Wheel Assembly
1303	2	2	257706302	Escutcheon
1304	1	1	257727301	Fly Wheel
1305	1	1	285311201	Shaft
1306	1	1	53110603E	Hexagon Nut
1307	1	1	54020601E	Flat Washer P
<b>GENERAL MISCELLANEOUS</b>				
2420	4	4	51100306S	B. H. M. Screw B 3x6
2507	2	2	71101669Q	Spring
2515	1	1	64000400R	RG Ring E
<b>FM FRONT END CIRCUIT BOARD-P100</b>				
P100	1	1	YD2818001	P. W. Board, FM RF (Print Only)
	1	1	ZZ2818001	P. W. Board Assembly
<b>P100-RESISTORS</b>				
All resistors are ±5% and ¼W				
R101	1	1	RT0556314	56KΩ
R102	1	1	RT0510514	1MΩ
R103	1	1	RT0510414	100KΩ
R104	1	1	RT0510114	100Ω
R105	1	1	RT0522114	220Ω
R106	1	1	RT0510114	100Ω
R107	1	1	RT0510114	100Ω
R108	1	1	RT0547214	4.7KΩ
R109	1	1	RT0522314	22KΩ
R110	1	1	RT0510214	1KΩ

REF. DESIG.	U	E	PART NO.	DESCRIPTION
R111	1	1	RT0510114	100Ω
R112	1	1	RT0510114	100Ω
R113	1	1	RT0522314	22KΩ
R114	1	1	RT0522314	22KΩ
R115	1	1	RT0512214	1.2KΩ
<b>P100-CAPACITORS</b>				
C101	1	1	CA5000001	Variable, FM 5 Gang
C102	1	1	CT1100001	Trimming, 1.5~11.5PF
C103	1	1	CT1100001	Trimming, 1.5~11.5PF
C104	1	1	CT1100001	Trimming, 1.5~11.5PF
C105	1	1	CT1100001	Trimming, 1.5~11.5PF
C106	1	1	CT1100001	Trimming, 1.5~11.5PF
C107	1	1	CT1100002	Trimming, 1.5~11.5PF
C108	1	1	DD1615001	Ceramic, 15PF±10%, 50V
C109	1	1	DK1710201	Ceramic, 1000PF±10%, 50V
C110	1	1	DK1810301	Ceramic, 0.1μF+100%,-0%, 50V
C111	1	1	DD1105001	Ceramic, 5PF±0.5PF
C112	1	1	DK1710201	Ceramic, 1000PF±2%
C113	1	1	DD1615001	Ceramic, 15PF±10%
C114	1	1	DD1620001	Ceramic, 20PF±10%
C115	1	1	DD1001002	Ceramic, 10PF±0.25PF
C116	1	1	DD1600601	Ceramic, 0.6PF±10%
C117	1	1	DD1620001	Ceramic, 20PF±10%
C118	1	1	DK1710201	Ceramic, 1000PF±20%
C119	1	1	DK1710301	Ceramic, 0.1μF±20%
C120	1	1	DD1620003	Ceramic, 20PF±10%
C121	1	1	DD1210006	Ceramic, 10PF±10%
C122	1	1	DD1615003	Ceramic, 15PF±10%
C123	1	1	DD1615003	Ceramic, 15PF±10%
C124	1	1	DK1710301	Ceramic, 0.01μF±20%
C125	1	1	DK1810301	Ceramic, 0.01μF+100%,-0%
C126	1	1	DK1810301	Ceramic, 0.01μF+100%,-0%
C127	1	1	DK1710301	Ceramic, 0.01μF±20%
C129	1	1	DK1710301	Ceramic, 0.01μF±20%
C130	1	1	DK1710301	Ceramic, 0.01μF±20%
C131	1	1	DK1710301	Ceramic, 0.01μF±20%
<b>P100-MISCELLANEOUS</b>				
L101	1	1	LA1027801	Ant. Coil
L102	1	1	LA1027802	RF Coil
L103	1	1	LA1027803	RF Coil
L104	1	1	LA1027804	RF Coil
L105	1	1	LO1202604	OSC Coil
L106	1	1	LI1001601	IFT
H101	1	1	HF200191A	Transistor, 2SK19Y
H102	1	1	HF200191A	Transistor, 2SK19Y
H103	1	1	HT305351B	Transistor, 2SC535B
J101	1	1	YP1000094	Plug
J102	1	1	YP1000094	Plug
J103	1	1	YP1000094	Plug
J104	1	1	YP1000094	Plug
J105	1	1	YP1000094	Plug
J106	1	1	YP1000094	Plug
<b>GENERAL MISCELLANEOUS</b>				
2416	1	1	281810903	Shield
2417	2	2	281810904	Shield
2418	1	1	281810905	Shield
2403	1	1	281810950	Shield K
2407	1	1	289016006	Bracket
2408	1	1	281816008	Bracket
2409	4	4	51570306B	P.H. Tapt Screw P3 x 6ST
2411	1	1	281811201	Shaft

REF. DESIG.	U	E	PART NO.	DESCRIPTION
2412	1	1	53110403E	Hexagon Nut
2413	1	1	54040402N	Spring Washer
2423	1	1	281810908	Shield
2424	2	2	114325901	Bush
2425	2	2	114325902	Bush
2426	2	2	51040308A	F. H. M. Screw F 3x8
2428	3	3	51100304E	B. H. M. Screw B 3x4
2429	2	2	51100304E	B. H. M. Screw B 3x4
2431	1	1	281805102	Guide
2432	3	3	51060306A	P. H. M. Screw P 3x6
C001	1	1	CA0330002	Variable Cap.
2512	1	1	289215901	Drum
2513	1	1	71101569M	Spring
2503	2	2	281805850	Gear K
2509	4	4	51064019A	Screw
P150	1	1	YD2909001	AM TUNER CIRCUIT BOARD-P150
	1	1	ZZ2918101	P. W. Board, AM Tuner (Print Only) P. W. Board Assembly
				<b>P150-RESISTORS</b> All resistors are ±5% and ¼W, unless otherwise indicated.
R151	1	1	RT0510314	10KΩ
R152	1	1	RT0530314	30KΩ
R153	1	1	RT0582314	82KΩ
R154	1	1	RT0522314	22KΩ
R156	1	1	RT0515414	150KΩ
R157	1	1	RC0000014	0Ω
R158	1	1	RT0539314	39KΩ
R159	1	1	RT0539214	3.9KΩ
R160	1	1	RC0000012	0Ω
R161	1	1	RT0543214	4.3KΩ
R162	1	1	RT0510114	100Ω
R163	1	1	RT0515214	1.5KΩ
R164	1	1	RT0533114	330Ω
R165	1	1	RC0000014	0Ω
R166	1	1	RC0000014	0Ω
R167	1	1	RT0522214	2.2KΩ
R168	1	1	RT0582314	82KΩ
R169	1	1	RT0562414	620KΩ
R170	1	1	RT0551114	510Ω
R171	1	1	RT0520214	2KΩ
R172	1	1	RT0556214	5.6KΩ
R173	1	1	RT0510114	100Ω
R174	1	1	RT0510114	100Ω
R175	1	1	RT0510414	100KΩ
R176	1	1	RT0510314	10KΩ
R177	1	1	RT0512314	12KΩ
R178	1	1	RA0103025	Trimming, 10KΩ (B)
R179	1	1	RT0512314	12KΩ
R180	1	1	RT0515214	1.5KΩ
R181	1	1	RT0510114	100Ω
R182	1	1	RT0515214	1.5KΩ
				<b>P150-CAPACITORS</b>
C151	1	1	DK1710301	Ceramic, 0.01μF ±20%
C152	1	1	DF1747305	Film, 0.047μF ±20%
C153	1	1	DD1620001	Ceramic, 20PF ±10%
C154	1	1	DK1710301	Ceramic, 0.01μF ±20%
C155	1	1	DF6545101	Film, 450PF ±5%

REF. DESIG.	U	E	PART NO.	DESCRIPTION
C156	1	1	DD1615001	Ceramic, 15PF ±10%
C157	1	1	DK1710301	Ceramic, 0.01μF ±20%
C158	1	1	DK1840302	Ceramic, 0.04μF +80%,-20%
C159	1	1	DK1840302	Ceramic, 0.04μF +80%,-20%
C160	1	1	DK1710301	Ceramic, 0.01μF ±20%
C161	1	1	DK1710301	Ceramic, 0.01μF ±20%
C162	1	1	DK1710301	Ceramic, 0.01μF ±20%
C163	1	1	DF1615305	Film, 0.015μF ±10%
C164	1	1	DF1633305	Film, 0.033μF ±10%
C165	1	1	DF1756205	Film, 5600PF ±20%
C166	1	1	DK1840302	Film, 0.04μF +80%,-20%
C167	1	1	EA2260169	Electroly, 22μF, 16V
C168	1	1	EA1070169	Electroly, 100μF, 16V
C169	1	1	EA4750359	Electroly, 4.7μF, 35V
C170	1	1	EA1070169	Electroly, 100μF, 16V
C171	1	1	EA1050509	Electroly, 1μF, 50V
C172	1	1	EA1070169	Electroly, 100μF, 16V
C173	1	1	EA4750359	Electroly, 4.7μF, 35V
				<b>P150-MISCELLANEOUS</b>
H151	1	1	HC1000506	IC μPC30C
H152	1	1	HT313272A	Tranistor, 2SC1327
H153	1	1	HT104942A	Transistor, 2SA494
H154	1	1	HT104942A	Transistor, 2SA494
H155	1	1	HH0000212	Thermistor, 31D27
L151	1	1	LA1001019	RF Coil, AM
L152	1	1	LO1001050	OSC Coil, AM
L153	1	1	LI1028003	IFT, AM Ceramic Filter
L154	1	1	LC1332002	Choke Coil, 3.3μH
L155	1	1	LC1332002	Choke Coil, 3.3μH
J151	1	1	YP1000113	Plug
J152	1	1	YP1000113	Plug
J153	1	1	YP1000113	Plug
J155	1	1	YP1000113	Plug
J156	1	1	YP1000113	Plug
J157	1	1	YP1000113	Plug
J158	1	1	YP1000113	Plug
J159	1	1	YP1000113	Plug
J160	1	1	YP1000113	Plug
J161	1	1	YP1000113	Plug
P200	1	1	YD2917001	FM IF CIRCUIT BOARD-P200
	1	1	ZZ2918114	P. W. Board, FM IF (Print Only) P. W. Board Assembly
				<b>P200-RESISTORS</b> All resistors are ±5% and ¼W, unless otherwise indicated.
R201	1	1	RT0515114	150Ω
R202	1	1	RT0582214	8.2KΩ
R203	1	1	RT0518314	18KΩ
R204	1	1	RT0510214	1KΩ
R205	1	1	RT0533114	330Ω
R206	1	1	RC0000014	0Ω, ¼W
R207	1	1	RT0547014	47Ω
R208	1	1	RT0533214	3.3KΩ
R209	1	1	RT0515214	1.5KΩ
R210	1	1	RT0515114	150Ω
R212	1	1	RT0510214	1KΩ
R213	1	1	RT0533114	330Ω
R214	1	1	RC0000014	0Ω, ¼W

REF. DESIG.	U	E	PART NO.	DESCRIPTION	REF. DESIG.	U	E	PART NO.	DESCRIPTION
R215	1	1	RT0547014	47Ω	R282	1	1	RT0522314	22KΩ
R216	1	1	RT0533214	3.3KΩ	R283	1	1	RT0510114	100Ω
R217	1	1	RT0515214	1.5KΩ	R284	1	1	RT0510414	100KΩ
R218	1	1	RT0515114	150Ω	R285	1	1	RT0518414	180KΩ
R219	1	1	RT0510214	1KΩ	R286	1	1	RT0510114	100Ω
R220	1	1	RT0533114	330Ω	R287	1	1	RT0522214	2.2KΩ
R221	1	1	RC0000014	0Ω, ¼W	R288	1	1	RT0510114	100Ω
R223	1	1	RT0547314	47KΩ	R289	1	1	RT0510114	100Ω
R224	1	1	RT0547014	47Ω	R290	1	1	RT0512114	120Ω
R225	1	1	RT0515214	1.5KΩ	R291	1	1	RT0582214	8.2KΩ
R226	1	1	RT0533214	3.3KΩ	R292	1	1	RT0518314	18KΩ
R227	1	1	RT0515114	150Ω	R293	1	1	RT0522214	2.2KΩ
R228	1	1	RT0556114	560Ω	R294	1	1	RT0527314	27KΩ
R229	1	1	RT0575014	75Ω	R296	1	1	RT0533314	33KΩ
R230	1	1	RC0000014	0Ω, ¼W	R297	1	1	RT0522314	22KΩ
R231	1	1	RT0575014	75Ω	R298	1	1	RT0515314	15KΩ
R232	1	1	RT0510414	100KΩ					<b>P200-CAPACITORS</b>
R234	1	1	RT0568314	68KΩ	C201	1	1	DK1810301	Ceramic, 0.01μF +80%,-20%
R235	1	1	RT0547014	47Ω	C202	1	1	DK1810301	Ceramic, 0.01μF +80%,-20%
R236	1	1	RT0582114	820Ω	C203	1	1	DK1840302	Ceramic, 0.04μF +80%,-20%
R237	1	1	RT0510214	1KΩ	C204	1	1	EA1060169	Electroly, 10μF, 16V
R238	1	1	RT0582114	820Ω	C205	1	1	EA1060169	Electroly, 10μF, 16V
R239	1	1	RT0515214	1.5KΩ	C206	1	1	DK1840302	Ceramic, 0.04μF +80%,-20%
R240	1	1	RT0533214	3.3KΩ	C207	1	1	DK1810301	Ceramic, 0.01μF +80%,-20%
R241	1	1	RT0515114	150Ω	C208	1	1	EA1060169	Electroly, 10μF, 16V
R242	1	1	RT0510214	1KΩ	C209	1	1	DK1840302	Ceramic, 0.04μF +80%,-20%
R243	1	1	RT0510214	1KΩ	C210	1	1	DK1810301	Ceramic, 0.01μF +80%,-20%
R244	1	1	RT0515114	150Ω	C211	1	1	DD1540001	Ceramic, 40PF ±5%
R246	1	1	RT0568314	68KΩ	C213	1	1	DK1810301	Ceramic, 0.01μF +80%,-20%
R248	1	1	RT0547014	47Ω	C214	1	1	DD1540001	Ceramic, 40PF ±5%
R249	1	1	RT0515114	150Ω	C215	1	1	DK1810301	Ceramic, 0.01μF +80%,-20%
R250	1	1	RT0510414	100KΩ	C217	1	1	DK1840302	Ceramic, 0.04μF +80%,-20%
R251	1	1	RT0582214	8.2KΩ	C218	1	1	EA1060169	Electroly, 10μF, 16V
R252	1	1	RT0515314	15KΩ	C219	1	1	EA1060169	Electroly, 10μF, 16V
R253	1	1	RT0510214	1KΩ	C220	1	1	DK1840302	Ceramic, 0.04μF +80%,-20%
R254	1	1	RT0510214	1KΩ	C221	1	1	DK1810301	Ceramic, 0.01μF +80%,-20%
R255	1	1	RT0515114	150Ω	C222	1	1	DK1810301	Ceramic, 0.01μF +80%,-20%
R257	1	1	RT0539314	39KΩ	C223	1	1	DD1540001	Ceramic, 40PF ±5%
R258	1	1	RT0522314	22KΩ	C225	1	1	DK1810301	Ceramic, 0.01μF +80%,-20%
R259	1	1	RT0582114	820Ω	C226	1	1	DK1810301	Ceramic, 0.01μF +80%,-20%
R260	1	1	RT0510414	100KΩ	C227	1	1	DK1810301	Ceramic, 0.01μF +80%,-20%
R261	1	1	RT0515114	150Ω	C228	1	1	DD1540001	Ceramic, 40PF ±5%
R262	1	1	RT0582214	8.2KΩ	C229	1	1	EA1060169	Electroly, 10μF, 16V
R263	1	1	RT0515314	15KΩ	C230	1	1	DK1840302	Ceramic, 0.04μF +80%,-20%
R264	1	1	RT0510214	1KΩ	C232	1	1	DK1810301	Ceramic, 0.01μF +80%,-20%
R265	1	1	RT0510214	1KΩ	C233	1	1	DD1540001	Ceramic, 40PF ±5%
R266	1	1	RT0510114	100Ω	C234	1	1	DK1810301	Ceramic, 0.01μF +80%,-20%
R267	1	1	RT0515114	150Ω	C235	1	1	DK1810301	Ceramic, 0.01μF +80%,-20%
R268	1	1	RT0515114	150Ω	C236	1	1	DK1810301	Ceramic, 0.01μF +80%,-20%
R269	1	1	RT0510414	100KΩ	C237	1	1	DK1810301	Ceramic, 0.01μF +80%,-20%
R270	1	1	RT0582214	8.2KΩ	C238	1	1	DK1840302	Ceramic, 0.04μF +80%,-20%
R271	1	1	RT0515314	15KΩ	C239	1	1	DD1620101	Ceramic, 200PF ±10%
R272	1	1	RT0510214	1KΩ	C240	1	1	DD1620101	Ceramic, 200PF ±10%
R273	1	1	RT0510114	100Ω	C241	1	1	DD1620101	Ceramic, 200PF ±10%
R274	1	1	RT0527214	2.7KΩ	C242	1	1	EA1060169	Electroly, 10μF, 16V
R275	1	1	RT0582114	820Ω	C243	1	1	EA1070109	Electroly, 100μF, 10V
R276	1	1	RT0582114	820Ω	C244	1	1	EA1060169	Electroly, 100μF, 10V
R277	1	1	RT0582114	820Ω	C245	1	1	EA1060169	Electroly, 100μF, 10V
R278	1	1	RT0568214	6.8KΩ	C246	1	1	DK1840302	Ceramic, 0.04μF +80%,-20%
R279	1	1	RT0568214	6.8KΩ	C247	1	1	DK1840302	Ceramic, 0.04μF +80%,-20%
R280	1	1	RT0510114	100Ω	C148	1	1	EA1060169	Electroly, 10μF, 16V
R281	1	1	RT0556314	56KΩ					

REF. DESIG.	U	E	PART NO.	DESCRIPTION
C249	1	1	EA1070169	Electroly, 100 $\mu$ F, 16V
C250	1	1	EA2260169	Electroly, 22 $\mu$ F, 16V
C251	1	1	DK1810301	Ceramic, 0.01 $\mu$ F +80%,-20%
C252	1	1	DD1540001	Ceramic, 40PF $\pm$ 5%
C253	1	1	DK1840302	Ceramic, 0.04 $\mu$ F +80%,-20%
C254	1	1	DD1540001	Ceramic, 40PF $\pm$ 5%
C255	1	1	DD1620101	Ceramic, 200PF $\pm$ 10%
C256	1	1	EV1050352	Electroly, 1 $\mu$ F $\pm$ 20%, 35V
C257	1	1	DD1620101	Ceramic, 200PF $\pm$ 10%
C258	1	1	DK1810301	Ceramic, 0.01 $\mu$ F +80%,-20%
C259	1	1	DK1840302	Ceramic, 0.04 $\mu$ F +80%,-20%
C260	1	1	EV1050352	Electroly, 1 $\mu$ F, 35V
C261	1	1	EA1050509	Electroly, 1 $\mu$ F, 50V
C262	1	1	DK1810402	Ceramic, 0.1 $\mu$ F +80%,-20%
C263	1	1	DK1810402	Ceramic, 0.1 $\mu$ F +80%,-20%
<b>P200-SEMICONDUCTORS</b>				
H201	1	1	HT308291C	Transistor, 2SC829C
H202	1	1	HT308291C	Transistor, 2SC829C
H203	1	1	HT308291C	Transistor, 2SC829C
H204	1	1	HT308291C	Transistor, 2SC829C
H205	1	1	HT308291C	Transistor, 2SC829C
H206	1	1	HT308291C	Transistor, 2SC829C
H207	1	1	HT308291C	Transistor, 2SC829C
H208	1	1	HT308291C	Transistor, 2SC829C
H209	1	1	HT308291C	Transistor, 2SC829C
H210	1	1	HT306441B	Transistor, 2SC644S
H211	1	1	HD2000121	Diode, 1S2413
H212	1	1	HD2000121	Diode, 1S2413
H213	1	1	HD2000121	Diode, 1S2413
H214	1	1	HD2000121	Diode, 1S2413
H215	1	1	HD2000121	Diode, 1S2413
H216	1	1	HD2000121	Diode, 1S2413
H217	1	1	HD2000121	Diode, 1S2413
H218	1	1	HD2000121	Diode, 1S2413
H219	1	1	HD1000302	Diode, 20A90M
H220	1	1	HD1000302	Diode, 20A90M
H221	1	1	HD1000105	Diode, 1N60
H222	1	1	HD1000105	Diode, 1N60
H223	1	1	HD1000105	Diode, 1N60
H224	1	1	HD1000105	Diode, 1N60
H225	1	1	HD1000105	Diode, 1N60
H226	1	1	HD1000105	Diode, 1N60
H227	1	1	HD1000105	Diode, 1N60
H228	1	1	HD1000105	Diode, 1N60
H229	1	1	HD1000105	Diode, 1N60
H230	1	1	HD1000105	Diode, 1N60
H231	1	1	HD1000105	Diode, 1N60
H232	1	1	HD1000105	Diode, 1N60
H233	1	1	HD1000302	Diode, 20A90M
<b>P200-MISCELLANEOUS</b>				
F201	1	1	FP1107001	Ceramic Filter, SFA107MC
F202	1	1	FP1107001	Ceramic Filter, SFA107MC
F203	1	1	FP1107001	Ceramic Filter, SFA107MC
F204	1	1	FP1107001	Ceramic Filter, SFA107MC
F205	1	1	FP1107001	Ceramic Filter, SFA107MC
F206	1	1	FP1107001	Ceramic Filter, SFA107MC
F207	1	1	FP1107001	Ceramic Filter, SFA107MC
F208	1	1	FP1107001	Ceramic Filter, SFA107MC
L201	1	1	LI1401623	IFT, FM Detector
L202	1	1	LC1332002	Choke Coil, 3.3 $\mu$ H

REF. DESIG.	U	E	PART NO.	DESCRIPTION
J201	1	1	YP1000113	Plug
J202	1	1	YP1000113	Plug
J203	1	1	YP1000113	Plug
J204	1	1	YP1000113	Plug
J205	1	1	YP1000113	Plug
J206	1	1	YP1000113	Plug
J207	1	1	YP1000113	Plug
J208	1	1	YP1000113	Plug
J209	1	1	YP1000113	Plug
J210	1	1	YP1000113	Plug
J211	1	1	YP1000113	Plug
G201	1	1	BF2230006	Printed Compo. 1K $\Omega$ +0.022 $\mu$ F
G202	1	1	BF1020002	Printed Compo. 100K $\Omega$ +1000PF
G203	1	1	BF1020001	Printed Compo. 27K $\Omega$ +1000PF
G204	1	1	BF2010004	Printed Compo. 27K $\Omega$ +200PF
G205	1	1	BF2010004	Printed Compo. 27K $\Omega$ +200PF
G206	1	1	BF2010004	Printed Compo. 27K $\Omega$ +200PF
G207	1	1	BF2010004	Printed Compo. 27K $\Omega$ +200PF
<b>FM MPX CIRCUIT BOARD-P300</b>				
P300	1	1	YD2890003	P.W. Board, FM Multiplex (Print Only)
			ZZ2918103	P. W. Board Assembly
<b>P300-RESISTORS</b>				
All resistors are $\pm$ 5% and $\frac{1}{4}$ W, unless otherwise indicated.				
R301	1	1	RA0202011	Trimming, 2K $\Omega$ (B)
R302	1	1	RT0522414	220K $\Omega$
R303	1	1	RT0556314	56K $\Omega$
R304	1	1	RT0568314	68K $\Omega$
R305	1	1	RT0510114	100 $\Omega$
R306	1	1	RT0518414	180K $\Omega$
R307	1	1	RT0522414	220K $\Omega$
R308	1	1	RT0512414	120K $\Omega$
R309	1	1	RT0510414	100K $\Omega$
R310	1	1	RT0568214	6.8K $\Omega$
R311	1	1	RA0502020	Trimming, 5K $\Omega$ (B)
R312	1	1	RT0516314	16K $\Omega$
R313	1	1	RT0510214	1K $\Omega$
R314	1	1	RT0522414	220K $\Omega$
R315	1	1	RT0510214	1K $\Omega$
R316	1	1	RT0510214	1K $\Omega$
R317	1	1	RT0539214	3.9K $\Omega$
R318	1	1	RT0539214	3.9K $\Omega$
R319	1	1	RT0522414	220K $\Omega$
R320	1	1	RT0522314	22K $\Omega$
R321	1	1	RT0510114	100 $\Omega$
R322	1	1	RT0510014	10 $\Omega$
R323	1	1	RT0522414	220K $\Omega$
R324	1	1	RT0522414	220K $\Omega$
R325	1	1	RT0530314	30K $\Omega$
R326	1	1	RT0530314	30K $\Omega$
R327	1	1	RT0510414	100K $\Omega$
R328	1	1	RT0510414	100K $\Omega$
R329	1	1	RT0515514	1.5M $\Omega$
R330	1	1	RT0515514	1.5M $\Omega$
R331	1	1	RT0551114	510 $\Omega$
R332	1	1	RT0551114	510 $\Omega$
R332	1	1	RT0551114	510 $\Omega$
R333	1	1	RT0522314	22K $\Omega$
R334	1	1	RT0522314	22K $\Omega$
R335	1	1	RT0510114	100 $\Omega$
R336	1	1	RT0510114	100 $\Omega$

U ..... U.S.A.  
E ..... Europe

REF. DESIG.	U	E	PART NO.	DESCRIPTION	REF. DESIG.	U	E	PART NO.	DESCRIPTION
R337	1	1	RT0582214	8.2K $\Omega$	C320	1	1	DF1522205	Film, 2200PF $\pm$ 5%
R338	1	1	RT0582214	8.2K $\Omega$	C321	1	1	DF1510205	Film, 1000PF $\pm$ 5%
R339	1	1	RT0547114	470 $\Omega$	C322	1	1	DF1510205	Film, 1000PF $\pm$ 5%
R340	1	1	RT0547114	470 $\Omega$	C323	1	1	EV2240351	Electroly, 0.22 $\mu$ F $\pm$ 20%, 35V
R341	1	1	RT0522414	220K $\Omega$	C324	1	1	EV2240351	Electroly, 0.22 $\mu$ F $\pm$ 20%, 35V
R342	1	1	RT0522414	220K $\Omega$	C325	1	1	EV1050352	Electroly, 1 $\mu$ F $\pm$ 20%, 35V
R343	1	1	RT0539214	3.9K $\Omega$	C326	1	1	EV1050352	Electroly, 1 $\mu$ F $\pm$ 20%, 35V
R344	1	1	RT0556414	560K $\Omega$	C327	1	1	EA2270259	Electroly, 220 $\mu$ F, 25V
R345	1	1	RT0515314	15K $\Omega$	C328	1	1	EA2270169	Electroly, 220 $\mu$ F, 16V
R346	1	1	RT0512414	120K $\Omega$	C329	1	1	EA1060169	Electroly, 10 $\mu$ F, 16V
R347	1	1	RT0510114	100 $\Omega$	C330	1	1	DK1840302	Ceramic, 0.04 $\mu$ F +80%, -20%
R348	1	1	RT0522414	220K $\Omega$	C331	1	1	EA1050509	Electroly, 1 $\mu$ F, 50V
R349	1	1	RT0556214	5.6K $\Omega$	C332	1	1	EA1060169	Electroly, 10 $\mu$ F, 16V
R350	1	1	RT0510314	10K $\Omega$	C333	1	1	DD1210001	Ceramic, 10PF $\pm$ 10%
R351	1	1	RT0510114	100 $\Omega$	C334	1	1	DF1668301	Film, 0.068 $\mu$ F $\pm$ 10%
R352	1	1	RT0533314	33K $\Omega$	C335	1	1	DF1740301	Film, 0.04 $\mu$ F $\pm$ 20%
R353	1	1	RT0510114	100 $\Omega$	C336	1	1	DK1810402	Ceramic, 0.1 $\mu$ F +80%, -20%
R354	1	1	RT0510414	100K $\Omega$	C337	1	1	EA4750359	Electroly, 4.7 $\mu$ F, 35V
R355	1	1	RT0527314	27K $\Omega$	C338	1	1	EA1050509	Electroly, 1 $\mu$ F, 50V
R356	1	1	RT0510414	100K $\Omega$	C339	1	1	DK1840302	Ceramic, 0.04 $\mu$ F +80%, -20%
R357	1	1	RT0510214	1K $\Omega$	C340	1	1	DK1840302	Ceramic, 0.04 $\mu$ F +80%, -20%
R358	1	1	RT0510114	100 $\Omega$	C341	1	1	DK1840302	Ceramic, 0.04 $\mu$ F +80%, -20%
R359	1	1	RT0527314	27K $\Omega$	C343	1	1	DF1710402	Film, 0.1 $\mu$ F $\pm$ 20%
R360	1	1	RT0533314	33K $\Omega$	C344	1	1	DK1820302	Ceramic, 0.02 $\mu$ F +80%, -20%
R361	1	1	RT0510414	100K $\Omega$	<b>P300-COILS &amp; PLUGS</b>				
R362	1	1	RA0104018	Trimming, 100K $\Omega$ (B)	L301	1	1	LS1029004	MPX Coil, 56mH
R363	1	1	RA0103025	Trimming, 10K $\Omega$ (B)	L302	1	1	LS1029004	MPX Coil, 56mH
R364	1	1	RT0522214	2.2K $\Omega$	L303	1	1	LS1029005	MPX Coil, 56mH
R365	1	1	RT0510114	100 $\Omega$	L304	1	1	LS1029005	MPX Coil, 56mH
R366	1	1	RT0510314	10K $\Omega$	L305	1	1	LC2105001	Choke Coil, 1mH
R367	1	1	RT0510114	100 $\Omega$	J301	1	1	YP1000113	Plug
R368	1	1	RT0527414	270K $\Omega$	J322	1	1		
R369	1	1	RT0510314	10K $\Omega$	<b>P300-SEMICONDUCTORS</b>				
R370	1	1	RT0512314	12K $\Omega$	H301	1	1	HF200301C	FET, 2SK 30Y
R371	1	1	RT0522114	220 $\Omega$	H302	1	1	HT308281D	Transistor, 2SC 828S
R373	1	1	RT0582314	82K $\Omega$	H303	1	1	HT308281D	Transistor, 2SC 828S
R374	1	1	RA0103025	Trimming, 10K $\Omega$ (B)	H304	1	1	HT307322A	Transistor, 2SC 732 B or G
R375	1	1	RT0510114	100 $\Omega$	H305	1	1	HT307322A	Transistor, 2SC 732 B or G
R376	1	1	RT0510414	100K $\Omega$	H306	1	1	HT104942A	Transistor, 2SA 494 G or Y
R377	1	1	RT0510414	100K $\Omega$	H307	1	1	HT104942A	Transistor, 2SA 494 G or Y
R378	1	1	RT0556214	5.6K $\Omega$	H308	1	1	HT308281D	Transistor, 2SC 828 S
R379	1	1	RT0533214	3.3K $\Omega$	H309	1	1	HT308281D	Transistor, 2SC 828 S
<b>P300-CAPACITORS</b>					H310	1	1	HT308281D	Transistor, 2SC 828 S
C301	1	1	DF1633205	Film, 3300PF $\pm$ 10%	H311	1	1	HT308281D	Transistor, 2SC 828 S
C302	1	1	EA3360109	Electroly, 33 $\mu$ F, 10V	H312	1	1	HF200300A	FET, 2SK30Y
C303	1	1	DF1722305	Film, 0.022 $\mu$ F $\pm$ 20%	H313	1	1	HT308281D	Transistor, 2SC828S
C304	1	1	EA2260169	Electroly, 22 $\mu$ F, 16V	H314	1	1	HT308281D	Transistor, 2SC828S
C305	1	1	DF5547101	Film, 470PF $\pm$ 5%	H315	1	1	HT308281D	Transistor, 2SC828S
C306	1	1	EA2260169	Electroly, 22 $\mu$ F, 16V	H316	1	1	HT308281D	Transistor, 2SC828S
C307	1	1	EQ4740501	Electroly, 0.47 $\mu$ F $\pm$ 20%, 50V	H317	1	1	HT308281D	Transistor, 2SC828S
C308	1	1	EQ2240501	Electroly, 0.22 $\mu$ F $\pm$ 20%, 50V	H318	1	1	HD1000105	Diode, IN60
C309	1	1	EQ2240501	Electroly, 0.22 $\mu$ F $\pm$ 20%, 50V	H319	1	1	HD1000105	Diode, IN60
C310	1	1	DF1747301	Film, 0.047 $\mu$ F $\pm$ 20%	H321	1	1	HC1000401	IC, HA1156
C311	1	1	DF1515205	Film, 1500PF $\pm$ 5%	<b>PHONO AMP. CIRCUIT BOARD-P400</b>				
C312	1	1	DF1515205	Film, 1500PF $\pm$ 5%	P400	1	1	YD2892008	P. W. Board, Phono Amp.(Print Only)
C313	1	1	DD1536101	Ceramic, 360PF $\pm$ 5%		1	1	ZZ2892008	P. W. Board Assembly
C314	1	1	DD1536101	Ceramic, 360PF $\pm$ 5%					
C315	1	1	DF1533205	Film, 3300PF $\pm$ 5%					
C316	1	1	DF1533205	Film, 3300PF $\pm$ 5%					
C317	1	1	DF1515205	Film, 1500PF $\pm$ 5%					
C318	1	1	DF1515205	Film, 1500PF $\pm$ 5%					
C319	1	1	DF1522205	Film, 2200PF $\pm$ 5%					

REF. DESIG.	U	E	PART NO.	DESCRIPTION
<b>P400-RESISTORS</b>				
All resistors are ±5% and ¼W, unless otherwise indicated				
R401	1	1	RT0556314	56KΩ
R402	1	1	RT0556314	56KΩ
R403	1	1	RT0547114	470Ω
R404	1	1	RT0547114	470Ω
R405	1	1	RN0533314	33KΩ
R406	1	1	RN0510514	1MΩ
R407	1	1	RN0510514	1MΩ
R408	1	1	RA0104018	Trimming, 100KΩ ±30%(B)
R409	1	1	RA0104018	Trimming, 100KΩ ±30%(B)
R410	1	1	RN0527314	27KΩ
R411	1	1	RN0527314	27KΩ
R412	1	1	RT0562114	620Ω
R413	1	1	RT0562114	620Ω
R414	1	1	RT0522514	2.2MΩ
R415	1	1	RT0522514	2.2MΩ
R416	1	1	RN0522514	2.2MΩ
R417	1	1	RN0522514	2.2MΩ
R418	1	1	RN0527414	270KΩ
R419	1	1	RN0527414	270KΩ
R420	1	1	RT0547314	47KΩ
R421	1	1	RT0547314	47KΩ
R422	1	1	RT0522214	2.2KΩ
R423	1	1	RT0522214	2.2KΩ
R424	1	1	RN0568414	680KΩ
R425	1	1	RN0568414	680KΩ
R426	1	1	RN0510414	100KΩ
R427	1	1	RN0510414	100KΩ
R428	1	1	RN0547314	47KΩ
R429	1	1	RN0547314	47KΩ
R430	1	1	RT0547014	47Ω
R431	1	1	RT0547014	47Ω
R432	1	1	RN0533214	3.3KΩ
R433	1	1	RN0533214	3.3KΩ
R434	1	1	RT0510114	100 Ω
R435	1	1	RT0547014	47Ω
R436	1	1	RT0547014	47Ω
<b>P400-CAPACITORS</b>				
C401	1	1	EV1050256	Electroly, 1μF ±20%, 25V
C402	1	1	EV1050256	Electroly, 1μF ±20%, 25V
C403	1	1	EE4760163	Electroly, 47μF ±20%, 16V
C404	1	1	EE4760163	Electroly, 47μF ±20%, 16V
C405	1	1	DD1540004	Ceramic, 40PF ±5%, 50V
C406	1	1	DD1540004	Ceramic, 40PF ±5%, 50V
C407	1	1	DD1104001	Ceramic, 4PF ±0.5PF, 50V
C408	1	1	DD1104001	Ceramic, 4PF ±0.5PF, 50V
C409	1	1	DF6556201	Film, 5600PF±5%, 50V
C410	1	1	DF6556201	Film, 5600PF±5%, 50V
C411	1	1	DF6516201	Film, 1600PF±5%, 50V
C412	1	1	DF6516201	Film, 1600PF±5%, 50V
C413	1	1	ED1070351	Electroly, 100μF, 35V
C414	1	1	DF1710552	Film, 1μF ±20%, 250V
C415	1	1	DF1710552	Film, 1μF ±20%, 250V
C416	1	1	DD1650001	Ceramic, 50PF ±10%, 250V
C417	1	1	DD1650001	Ceramic, 50PF ±10%, 250V
<b>P400-SEMICONDUCTORS &amp; PLUGS</b>				
H401	1	1	HT313441E	Transistor, 2SC1344E
H402	1	1	HT313441E	Transistor, 2SC1344E
H403	1	1	HT313442A	Transistor, 2SC1344D,E
H404	1	1	HT313442A	Transistor, 2SC1344D, E
H405	1	1	HT304580R	Transistor, 2SC458L, B
H406	1	1	HT304580R	Transistor, 2SC458L, B

REF. DESIG.	U	E	PART NO.	DESCRIPTION
H407	1	1	HD2000121	Diode, IS-2473CYe
H408	1	1	HD2000121	Diode, IS-2473CYe
H409	1	1	HV0000206	Varistor, VD1212
J401	1	1	YP1000113	Plug
J402	1	1	YP1000113	Plug
J403	1	1	YP1000113	Plug
J404	1	1	YP1000113	Plug
J405	1	1	YP1000113	Plug
J406	1	1	YP1000113	Plug
J407	1	1	YP1000113	Plug
J408	1	1	YP1000113	Plug
<b>DOLBY CIRCUIT BOARD-P600</b>				
P600	1	1	YD2886008	P. W. Board, Dolby (Print Only)
			ZZ2918108	P. W. Board Assembly
<b>P600-RESISTORS</b>				
All resistors are ±5% and W¼, unless otherwise indicated.				
R601	1	1	RT0547414	470KΩ
R602	1	1	RT0547414	470KΩ
R603	1	1	RT0510414	100KΩ
R604	1	1	RT0510414	100KΩ
R605	1	1	RT0533214	3.3KΩ
R606	1	1	RT0533214	3.3KΩ
R607	1	1	RT0510214	1KΩ
R608	1	1	RT0510214	1KΩ
R609	1	1	RT0539314	39KΩ
R610	1	1	RT0539314	39KΩ
R611	1	1	RT0568214	6.8KΩ
R612	1	1	RT0568214	6.8KΩ
R613	1	1	RT0510114	100Ω
R614	1	1	RT0510114	100Ω
R615	1	1	RT0522214	2.2KΩ
R616	1	1	RT0522214	2.2KΩ
R617	1	1	RT0512114	120Ω
R618	1	1	RT0512114	120Ω
R619	1	1	RT0556114	560Ω
R620	1	1	RT0556114	250Ω
R621	1	1	RT0533314	33KΩ
R622	1	1	RT0533314	33KΩ
R623	1	1	RT0215414	150KΩ ±2%, ¼W
R624	1	1	RT0215414	150KΩ ±2%, ¼W
R625	1	1	RT0218414	180KΩ ±2%, ¼W
R626	1	1	RT0218414	180KΩ ±2%, ¼W
R627	1	1	RT0527314	27KΩ
R628	1	1	RT0527314	27KΩ
R629	1	1	RT0582214	8.2KΩ
R630	1	1	RT0582214	8.2KΩ
R631	1	1	RT0215414	150KΩ ±2%, ¼W
R632	1	1	RT0215414	150KΩ ±2%, ¼W
R633	1	1	RT0522314	22KΩ
R634	1	1	RT0522314	22KΩ
R635	1	1	RT0227214	2.7KΩ ±2%, ¼W
R636	1	1	RT0227214	2.7KΩ ±2%, ¼W
R637	1	1	RT0533314	33KΩ
R638	1	1	RT0533314	33KΩ
R639	1	1	RT0547314	47KΩ
R640	1	1	RT0547314	47KΩ
R643	1	1	RT0527414	270KΩ
R644	1	1	RT0527414	270KΩ



U ..... U.S.A.  
E ..... Europe

REF. DESIG.	U	E	PART NO.	DESCRIPTION	REF. DESIG.	U	E	PART NO.	DESCRIPTION
R645	1	1	RT0547314	47KΩ	C613	1	1	EA1060169	Electroly, 10μF, 16V
R646	1	1	RT0547314	47KΩ	C614	1	1	EA1060169	Electroly, 10μF, 16V
R647	1	1	RT0533214	3.3KΩ	C617	1	1	DF1556205	Film, 5600PF ±5%
R648	1	1	RT0533214	3.3KΩ	C618	1	1	DF1556205	Film, 5600PF ±5%
R649	1	1	RT0515214	1.5KΩ	C619	1	1	DF1527305	Film, 0.027μF ±5%
R650	1	1	RT0515214	1.5KΩ	C620	1	1	DF1527305	Film, 0.027μF ±5%
R651	1	1	RT0518314	18KΩ	C621	1	1	DF1547205	Film, 4700PF ±5%
R652	1	1	RT0518314	18KΩ	C622	1	1	DF1547205	Film, 4700PF ±5%
R653	1	1	RA0103022	Variable, 10KΩ (B)	C623	1	1	EA1060169	Electroly, 10μF, 16V
R654	1	1	RA0103022	Variable, 10KΩ (B)	C624	1	1	EA1060169	Electroly, 10μF, 16V
R655	1	1	RT0527214	2.7KΩ	C625	1	1	DF1610405	Film, 0.1μF ±10%
R656	1	1	RT0527214	2.7KΩ	C626	1	1	DF1610405	Film, 0.1μF ±10%
R657	1	1	RT0568414	680KΩ	C627	1	1	EA4760109	Electroly, 47μF, 10V
R658	1	1	RT0568414	680KΩ	C628	1	1	EA4760109	Electroly, 47μF, 10V
R659	1	1	RA0102020	Variable, 1KΩ (B)	C629	1	1	DF1610405	Film, 0.1μF ±10%
R660	1	1	RA0102020	Variable, 1KΩ (B)	C630	1	1	DF1610405	Film, 0.1μF ±10%
R661	1	1	RT0515314	15KΩ	C631	1	1	EA1060169	Electroly, 10μF, 16V
R662	1	1	RT0515314	15KΩ	C632	1	1	EA1060169	Electroly, 10μF, 16V
R663	1	1	RT0582214	8.2KΩ	C633	1	1	DF1610405	Film, 0.1μF ±10%
R664	1	1	RT0582214	8.2KΩ	C634	1	1	DF1610405	Film, 0.1μF ±10%
R665	1	1	RT0510314	10KΩ	C635	1	1	EA1060169	Electroly, 10μF, 16V
R666	1	1	RT0510314	10KΩ	C636	1	1	EA1060169	Electroly, 10μF, 16V
R667	1	1	RT0582214	8.2KΩ	C637	1	1	DF1610405	Film, 0.1μF ±10%
R668	1	1	RT0582214	8.2KΩ	C638	1	1	DF1610405	Film, 0.1μF ±10%
R669	1	1	RT0582214	8.2KΩ	C639	1	1	DF1633405	Film, 0.33μF ±10%
R670	1	1	RT0582214	8.2KΩ	C640	1	1	DF1633405	Film, 0.33μF ±10%
R671	1	1	RT0533314	33KΩ	C641	1	1	EA2270259	Electroly, 220μF, 25V
R672	1	1	RT0533314	33KΩ					
R673	1	1	RT0512414	120KΩ	L601	1	1	LC2226004	<b>P600-COILS &amp; PLUGS</b> Choke Coil, 22mH
R674	1	1	RT0512414	120KΩ	L602	1	1	LC2226004	Choke Coil, 22mH
R675	1	1	RT0547314	47KΩ	J601				
R676	1	1	RT0547314	47KΩ	J608	1	1	YP1000109	Plug
R677	1	1	RT0527214	2.7KΩ	J611	1	1	YP1000109	Plug
R678	1	1	RT0527214	2.7KΩ	J612	1	1	YP1000109	Plug
R679	1	1	RT0510214	1KΩ	J615				
R680	1	1	RT0510214	1KΩ	J621	1	1	YP1000109	Plug
R681	1	1	RT0533014	33Ω					
R682	1	1	RT0533014	33Ω					
R683	1	1	RT0547014	47Ω					
R684	1	1	RT0547014	47Ω					
R685	1	1	RT0515314	15KΩ					
R686	1	1	RT0515314	15KΩ					
R687	1	1	RT0527414	270KΩ					
R688	1	1	RT0527414	270KΩ					
R689	1	1	RT0527414	270KΩ					
R690	1	1	RT0527414	270KΩ					
R691	1	1	RT0522414	220KΩ					
R692	1	1	RT0522414	220KΩ					
R693	1	1	RC1010112	100Ω ±10%, ½W					
				<b>P600-CAPACITORS</b>					
C601	1	1	EE3350251	Electroly, 3.3μF, 25V	H601	1	1	HT313271T	Transistor, 2SC1327 T,U
C602	1	1	EE3350251	Electroly, 3.3μF, 25V	H602	1	1	HT313271T	Transistor, 2SC1327 T,U
C603	1	1	DF6610101	Film, 100PF ±10%	H603	1	1	HT306441B	Transistor, 2SC644S
C604	1	1	DF6610101	Film, 100PF ±10%	H604	1	1	HT306441B	Transistor, 2SC644S
C605	1	1	DF1510205	Film, 1000PF ±5%	H605	1	1	HT104941C	Transistor, 2SA494Y
C606	1	1	DF1510205	Film, 1000PF ±5%	H606	1	1	HT104941C	Transistor, 2SA494Y
C607	1	1	EA1060169	Electroly, 10μF, 16V	H607	1	1	HT306441B	Transistor, 2SC644S
C608	1	1	EA1060169	Electroly, 10μF, 16V	H608	1	1	HT306441B	Transistor, 2SC644S
C609	1	1	EA1060169	Electroly, 10μF, 16V	H609	1	1	HT306441B	Transistor, 2SC644S
C610	1	1	EA1060169	Electroly, 10μF, 16V	H610	1	1	HT306441B	Transistor, 2SC644S
C611	1	1	EA1060169	Electroly, 10μF, 16V	H611	1	1	HF200301E	Transistor, 2SK30D
C612	1	1	EA1060169	Electroly, 10μF, 16V	H612	1	1	HF200301E	Transistor, 2SK30D
					H613	1	1	HT306441B	Transistor, 2SC644S
					H614	1	1	HT306441B	Transistor, 2SC644S
					H615	1	1	HT104941C	Transistor, 2SA494Y
					H616	1	1	HT104941C	Transistor, 2SA494Y
					H617	1	1	HT306441B	Transistor, 2SC644S
					H618	1	1	HT306441B	Transistor, 2SC644S
					H621	1	1	HD1000105	Diode, IN60
					H622	1	1	HD1000105	Diode, IN60
					H623	1	1	HD2000121	Diode, IS2473
					H624	1	1	HD2000121	Diode, IS2473
					H625	1	1	HD3003109	Diode, WZ-081

REF. DESIG.	U	E	PART NO.	DESCRIPTION
H626	1	1	HD2000121	IS2473
H627	1	1	HD2000121	IS2473
H628	1	1	HD2000121	IS2473
H629	1	1	HD2000121	IS2473
<b>P600-MISCELLANEOUS</b>				
2023	1	1	288616003	Bracket
2024	2	2	288616004	Bracket
2025	4	4	515703058	P. H. Tapt Screw P 3 x 5ST
2026	2	2	54050300R	T. L. Washer OR
2027	4	4	51100304S	B. H. M. Screw B 3 x 4
<b>GENERAL MISCELLANEOUS</b>				
1909	8	8	51100306S	B. H. M. Screw B 3x6
1910	2	2	51102605S	B. H. M. Screw B 2.6x5
1912	2	2	291810402	Retainer
1913	2	2	291812003	Insulator
1914	4	4	51102605S	B. H. M. Screw B 2.6x5
H001	1	1	HT107470A	Transistor, 2SA747A R or O
H002	1	1	HT107470A	Transistor, 2SA747A R or O
H003	1	1	HT311160A	Transistor, 2SC116A R or O
H004	1	1	HT311160A	Transistor, 2SC116A R or O
H005	1	1	HT107470A	Transistor, 2SA747A R or O
H006	1	1	HT107470A	Transistor, 2SA747A R or O
H007	1	1	HT311160A	Transistor, 2SC116A R or O
H008	1	1	HT311160A	Transistor, 2SC116A R or O
J020	1	1	YJ0500019	Socket, Transistor
J021	1	1	YJ0500019	Socket, Transistor
J022	1	1	YJ0500019	Socket, Transistor
J023	1	1	YJ0500019	Socket, Transistor
J024	1	1	YJ0500019	Socket, Transistor
J025	1	1	YJ0500019	Socket, Transistor
J026	1	1	YJ0500019	Socket, Transistor
J027	1	1	YJ0500019	Socket, Transistor
1903	2	2	291826701	Heat Sink
1904	16	16	54040302N	Spring Washer
1905	16	16	51100316B	B. H. M. Screw B 3 x 16
1906	4	4	291816003	Bracket
1907	8	8	51380306T	P. H. Tap Screw P 3 x 6 ST
1917	4	4	291810401	Retainer
1918	8	8	51380306T	P. H. Tap Screw P 3 x 6 ST
<b>POWER AMP. CIRCUIT BOARD-P700</b>				
P700	2	2	YD2918001	P. W. Board, Power Amp.(Print Only)
	2	2	ZZ2918001	P. W. Board Assembly
<b>P700-RESISTORS</b>				
All resistors are ±5% and ¼W, unless otherwise indicated.				
R701	2	2	RT0547414	470KΩ
R702	2	2	RT0510214	1KΩ
R703	2	2	RT0510414	100KΩ
R704	2	2	RT0510314	10KΩ
R705	2	2	RT0591314	91KΩ
R706	2	2	RT0547114	470Ω
R707	2	2	RT0515114	150Ω
R708	2	2	RT0575214	7.5KΩ
R709	2	2	RT0233214	3.3KΩ ±2%, ¼W
R710	2	2	RT0522414	220KΩ
R711	2	2	GM0282212	8.2KΩ ±2%, ¼W
R712	2	2	GU0510312	10KΩ ±5%, ¼W
R713	2	2	RA0102023	Trimming, 1KΩ (B)

REF. DESIG.	U	E	PART NO.	DESCRIPTION
R714	2	2	RT0520214	2KΩ
R715	2	2	RT0582214	8.2KΩ
R716	2	2	RT0568114	680Ω
R717	2	2	RT0522114	220Ω
R718	2	2	RT0527014	27Ω
R719	2	2	GJ0512202	1.2KΩ ±5%, 2W
R720	2	2	GJ0512202	1.2KΩ ±5%, 2W
R721	2	2	RT0527114	270Ω
R722	2	2	RT0527314	27KΩ
R723	2	2	RT0527314	27KΩ
R724	2	2	GD0556114	560Ω
R725	2	2	GD0556114	560Ω
R726	2	2	RT0510114	100Ω
R727	2	2	RT0510114	100Ω
R728	2	2	RT0547314	47KΩ
R729	2	2	RT0210414	100KΩ ±2%, ¼W
R730	2	2	RC0000012	0Ω, ¼W
R731	2	2	RC0000012	0Ω, ¼W
R732	2	2	GF0562014	62Ω
R733	2	2	GF0562014	62Ω
R734	2	2	HH0000703	SDT-100 1KΩ/25°C
R735	2	2	HH0000703	SDT-100 1KΩ/25°C
R736	2	2	GF0547214	4.7KΩ
R737	2	2	GF0547214	4.7KΩ
R738	2	2	GD0524214	2.4KΩ
R739	2	2	RT0504714	4.7Ω
R740	2	2	RA0102023	Trimming, 1KΩ (B)
R741	2	2	GJ0547001	47Ω ±5%, 1W
R742	2	2	GJ0547001	47Ω ±5%, 1W
R743	2	2	GJ0501501	1.5Ω ±5%, 1W
R744	2	2	GJ0501501	1.5Ω ±5%, 1W
R745	2	2	RT0504714	4.7Ω
R746	2	2	GJ0522003	22Ω ±5%, 3W
R747	2	2	GJ0502202	2.2Ω ±5%, 2W
R748	2	2	BX1010201	(0.1Ω+0.1Ω)±10%, 5W
R749	2	2	BX1020201	(0.2Ω+0.2Ω)±10%, 5W
R750	2	2	BX1020201	(0.2Ω+0.2Ω)±10%, 5W
R753	2	2	RC0000012	0Ω, ¼W
R754	2	2	RC0000012	0Ω, ¼W
<b>P700-CAPACITORS &amp; COIL</b>				
C701	2	2	DF1710552	Film, 1μF ±20% 250V
C702	2	2	DD1510101	Ceramic, 100PF ±5%, 50V
C703	2	2	EV3360066	Electroly, 33μF ±20%, 6.3V
C704	2	2	DK1610251	Ceramic, 1000PF ±10%, 500V
C705	2	2	DK1610251	Ceramic, 1000PF ±10%, 500V
C706	2	2	EA1060259	Electroly, 10μF+50%,-10%, 25V
C707	2	2	EA1060259	Electroly, 10μF+50%,-10%, 25V
C708	2	2	DF1710453	Film, 0.1μF ±20%, 250V
C709	2	2	DF1710453	Film, 0.1μF ±20%, 250V
C710	2	2	DK1610150	Ceramic, 100PF ±10%, 500V
C711	2	2	DD1008050	Ceramic, 8PF ±0.25PF, 500V
C712	2	2	DK1610150	Ceramic, 100PF ±10%, 500V
C713	2	2	DK1610150	Ceramic, 100PF ±10%, 500V
C714	2	2	DF1710453	Film, 0.1μF ±20%, 250V
C715	2	2	DF1747301	Film, 0.047μF±20%, 50V
C716	2	2	DF1747301	Film, 0.047μF±20%, 50V
C718	2	2	DK1610251	Ceramic, 1000PF ±10%, 500V
C719	2	2	DF1733350	Film, 0.033μF±20%, 250V
C721	2	2	DF1710453	Film, 0.1μF ±20%, 250V
C722	2	2	DF1710351	Film, 0.01μF ±20%, 200V
L701	2	2	LC2222001	Choke Coil, 2.2μH ±10%

U ..... U.S.A.  
E ..... Europe

REF. DESIG.	U	E	PART NO.	DESCRIPTION
<b>P700-SEMICONDUCTORS, JACK &amp; PLUGS</b>				
H701	1	1	HT107221S	Transistor, 2SA722 S, T
H702	1	1	HT107221S	Transistor, 2SA722 S, T
H703	2	2	HT107223A	Transistor, 2SA722 S,T,U
H704	2	2	HT107202A	Transistor, 2SA720 R,S
H705	2	2	HT313182R	Transistor, 2SC1318 R,S
H706	1	1	HT108181D	Transistor, 2SA818
H707	1	1	HT316281D	Transistor, 2SC1628
H708	1	1	HT316691B	Transistor, 2SC1669
H709	1	1	HT108391B	Transistor, 2SA839
H710	2	2	HT309452A	Transistor, 2SC945 Q, R
H711	2	2	HT107332A	Transistor, 2SA733 P, Q
H712	2	2	HT107332A	Transistor, 2SA733 P, Q
H713	2	2	HT309452A	Transistor, 2SC945 Q, R
H714	2	2	HT304961B	Transistor, 2SC496 O
H715	2	2	HT304961B	Transistor, 2SC496 O
H716	2	2	HD3004409	Diode, CZ-205
H717	2	2	HD3004409	Diode, CZ-205
H718	2	2	HV0000506	Varistor, VD1122
H719	2	2	HV0000506	Varistor, VD1122
H720	2	2	HD2000321	Diode, IS2471 (Black)
H721	2	2	HD2000321	Diode IS2471 (Black)
J701	2	2	YJ0600029	Jack
J702	2	2	YP1000099	Plug
J703	2	2	YP1000099	Plug
J704	2	2	YP1000099	Plug
J705	2	2	YP1000099	Plug
J706	2	2	YP1000099	Plug
J707	2	2	YP1000099	Plug
J708	2	2	YP1000099	Plug
J709	2	2	YP1000099	Plug
J710	2	2	YP0600045	Plug
<b>GENERAL MISCELLANEOUS</b>				
1803	4	4	291826703	Heat Sink
1805	8	8	51100310E	B. H. M. Screw B 3 x 10
1806	8	8	54040302N	Spring Washer
1807	8	8	53110302E	Hexagon Nut
1812	8	8	53110303E	Hexagon Nut
1813	8	8	54050300R	T. L. Washer OR
1818	2	2	291826706	Heat Sink
1819	4	4	291811801	Spacer
1820	4	4	51100310E	B. H. M. Screw B 3 x 10
1821	4	4	53110303E	Hexagon Nut
1823	4	4	53110303E	Hexagon Nut
1824	4	4	54050300R	T. L. Washer OR
1828	2	2	291826705	Heat Sink
1830	2	2	51102610E	B. H. M. Screw B 2.6 x 10
1831	2	2	53112603E	Hexagon Nut
1832	2	2	54042602N	Spring Washer
1703	1	1	291826702	Heat Sink
1705	2	2	51100306S	B. H. M. Screw B 3 x 6
1707	2	2	51100310E	B. H. M. Screw B 3 x 10
1708	2	2	53110303E	Hexagon Nut
1709	2	2	54050300R	T. L. Washer OR
<b>POWER SUPPLY CIRCUIT BOARD-P800</b>				
P800	1	1	YD2918004	P. W. Board, Power Supply (Print Only)
	1	1	ZZ2918004	P. W. Board Assembly
<b>P800-RESISTORS</b>				
R801	1	1	GQ1015105	150Ω ±10%, 5W
R802	1	1	GF0533214	3.3KΩ ±5%, ¼W
R803	1	1	GF0510014	10Ω ±5%, ¼W
R804	1	1	GF0510012	10Ω ±5%, ½W
R805	1	1	RT0547214	4.7KΩ ±5%, ¼W
R806	1	1	RT0547214	4.7KΩ ±5%, ¼W
R807	1	1	GF0539214	3.9KΩ ±5%, ¼W
R808	1	1	RT0522314	22KΩ ±5%, ¼W
R809	1	1	RA0502020	Trimming, 5K Ω (B)
R810	1	1	RT0556214	5.6KΩ ±5%, ¼W
R811	1	1	GJ0527102	270Ω ±5%, 2W
R812	1	1	RT0547214	4.7KΩ ±5%, ¼W
R813	1	1	RT0527314	27KΩ ±5%, ¼W
R814	1	1	RT0539314	39KΩ ±5%, ¼W
R815	1	1	RT0539314	39KΩ ±5%, ¼W
R816	1	1	RT0539414	390KΩ ±5%, ¼W
R817	1	1	GJ0547101	470Ω ±5%, 1W
R818	1	1	RC0000012	0Ω, ¼W
R819	1	1	GU0556212	5.6KΩ ±5%, ¼W
R820	1	1	GU0556212	5.6KΩ ±5%, ¼W
<b>P800-CAPACITORS</b>				
C801	1	1	DK1810351	Ceramic, 0.01μ F+100%,-0%, 500V
C802	1	1	DK1810351	Ceramic, 0.01μ F+100%,-0%, 500V
C803	1	1	EA4770631	Electroly, 470μF, 63V
C804	1	1	EA2270631	Electroly, 220μF, 63V
C805	1	1	EA4770169	Electroly, 470μF, 16V
C806	1	1	EA2270631	Electroly, 220μF, 63V
C807	1	1	EA3370509	Electroly, 330μF, 50V
C808	1	1	DF1747305	Film, 0.047μF, 50V
C809	1	1	EA1060509	Electroly, 10μF, 50V
C810	1	1	DF1710305	Film, 0.01μF, 50V
C811	1	1	EA1060639	Electroly, 10μF, 63V
C812	1	1	EA4760169	Electroly, 47μF, 16V
C813	1	1	EA2270109	Electroly, 220μF, 10V
<b>P800-SEMICONDUCTORS</b>				
H801	1	1	HT403314A	Transistor, 2SD331 C.D.E.F
H802	1	1	HT403314A	Transistor, 2SD331 C.D.E.F.
H803	1	1	HT307343A	Transistor, 2SC734 R.O.Y
H804	1	1	HT309452A	Transistor, 2SC945 Q.R
H805	1	1	HT309452A	Transistor, 2SC945 Q.R
H806	1	1	HT313183A	Transistor, 2SC1318 P.Q.R
H807	1	1	HT313183A	Transistor, 2SC1318 P.Q.R
H808	1	1	HD2001103	Rectifier DS-131B
H809	1	1	HD2001103	Rectifier, DS-131B
H810	1	1	HD3002709	Diode, WZ-140
H811	1	1	HD3002309	Diode, WZ-071
H812	1	1	HD2000321	Diode, 1S2471 (Black)
<b>P800-MISCELLANEOUS</b>				
L801	1	1	LY2024007	Relay, 24V, 10A
F801	1	1	FS1002006	Fuse, 0.2A
J801	1	1	YP1000113	Plug
J811	1	1	YJ0800021	Socket
J812	1	1	YJ0800021	Socket
J813	1	1	YJ0800021	Socket
<b>PRE-TONE AMP. CIRCUIT BOARD PE01</b>				
PE01	1	1	YD2918002	P.W.Board, Pre-Tone Amp. (Print Only)
	1	1	ZZ2918002	P.W.Board Assembly

REF. DESIG.	U	E	PART NO.	DESCRIPTION
<b>PE01-RESISTORS</b> All resistors are $\pm 5\%$ and $\frac{1}{4}W$ , unless otherwise indicated.				
RE01	1	1	RM0503061	Variable, $50K\Omega$ (B)
RE02	1	1	RD0204001	Variable, $200K\Omega$ (B)
RE03	1	1	RD0204001	Variable, $200K\Omega$ (B)
RE04	1	1	RD0204001	Variable, $200K\Omega$ (B)
RE05	1	1	RT0522314	$22K\Omega$
RE06	1	1	RT0522314	$22K\Omega$
RE07	1	1	RT0539214	$3.9K\Omega$
RE08	1	1	RT0539214	$3.9K\Omega$
RE09	1	1	RT0539114	$390\Omega$
RE10	1	1	RT0539114	$390\Omega$
RE11	1	1	RN0515414	$150K\Omega$
RE12	1	1	RN0515414	$150K\Omega$
RE13	1	1	RN0547414	$470K\Omega$
RE14	1	1	RN0547414	$470K\Omega$
RE15	1	1	RT0291114	$910\Omega \pm 2\%, \frac{1}{4}W$
RE16	1	1	RT0291114	$910\Omega \pm 2\%, \frac{1}{4}W$
RE17	1	1	RT0251214	$5.1K\Omega \pm 2\%, \frac{1}{4}W$
RE18	1	1	RT0251214	$5.1K\Omega \pm 2\%, \frac{1}{4}W$
RE19	1	1	RT0522414	$220K\Omega$
RE20	1	1	RT0522414	$220K\Omega$
RE21	1	1	RC0000012	$0\Omega, \frac{1}{4}W$
RE22	1	1	RC0000012	$0\Omega, \frac{1}{4}W$
RE23	1	1	RT0527314	$27K\Omega$
RE24	1	1	RT0527314	$27K\Omega$
RE25	1	1	RT0527314	$27K\Omega$
RE26	1	1	RT0527314	$27K\Omega$
RE29	1	1	RT0527314	$27K\Omega$
RE30	1	1	RT0527314	$27K\Omega$
RE31	1	1	RT0520314	$20K\Omega$
RE32	1	1	RT0520314	$20K\Omega$
RE33	1	1	RT0510314	$10K\Omega$
RE34	1	1	RT0510314	$10K\Omega$
RE35	1	1	RT0510314	$10K\Omega$
RE36	1	1	RT0510314	$10K\Omega$
RE37	1	1	RT0510314	$10K\Omega$
RE38	1	1	RT0510314	$10K\Omega$
RE39	1	1	RT0510314	$10K\Omega$
RE40	1	1	RT0510314	$10K\Omega$
RE41	1	1	RT0568414	$680K\Omega$
RE42	1	1	RT0568414	$680K\Omega$
RE43	1	1	RC0000012	$0\Omega, \frac{1}{4}W$
RE44	1	1	RC0000012	$0\Omega, \frac{1}{4}W$
RE45	1	1	RT0522514	$2.2M\Omega$
RE46	1	1	RT0522514	$2.2M\Omega$
RE47	1	1	RT0522514	$2.2M\Omega$
RE48	1	1	RT0522514	$2.2M\Omega$
RE49	1	1	RT0522514	$2.2M\Omega$
RE50	1	1	RT0522514	$2.2M\Omega$
RE51	1	1	RT0210314	$10K\Omega \pm 2\%, \frac{1}{4}W$
RE52	1	1	RT0210314	$10K\Omega \pm 2\%, \frac{1}{4}W$
RE53	1	1	RT0210314	$10K\Omega \pm 2\%, \frac{1}{4}W$
RE54	1	1	RT0210314	$10K\Omega \pm 2\%, \frac{1}{4}W$
RE55	1	1	RT0210314	$10K\Omega \pm 2\%, \frac{1}{4}W$
RE56	1	1	RT0210314	$10K\Omega \pm 2\%, \frac{1}{4}W$
RE57	1	1	RC0000012	$0\Omega, \frac{1}{4}W$
RE58	1	1	RC0000012	$0\Omega, \frac{1}{4}W$
RE59	1	1	RC0000012	$0\Omega, \frac{1}{4}W$
RE60	1	1	RC0000012	$0\Omega, \frac{1}{4}W$
RE61	1	1	RT0527214	$2.7K\Omega$

REF. DESIG.	U	E	PART NO.	DESCRIPTION
RE62	1	1	RT0510414	$100K\Omega$
RE63	1	1	RT0547414	$470K\Omega$
RE64	1	1	RT0547414	$470K\Omega$
RE65	1	1	RT0547314	$47K\Omega$
RE66	1	1	RT0547314	$47K\Omega$
RE67	1	1	RT0522114	$220\Omega$
RE68	1	1	RT0522114	$220\Omega$
RE69	1	1	RT0510314	$10K\Omega$
RE70	1	1	RT0510314	$10K\Omega$
RE71	1	1	RT0522414	$220K\Omega$
RE72	1	1	RT0522414	$220K\Omega$
RE73	1	1	RT0510114	$100\Omega$
RE74	1	1	RC0000012	$0\Omega, \frac{1}{4}W$
<b>PE01-CAPACITORS</b>				
CE01	1	1	DK1668101	Ceramic, $680\mu F \pm 10\%$ , 50V
CE02	1	1	DK1668101	Ceramic, $680\mu F \pm 10\%$ , 50V
CE03	1	1	DF1610405	Film, $0.1PF \pm 10\%$ , 50V
CE04	1	1	DF1610405	Film, $0.1PF \pm 10\%$ , 50V
CE05	1	1	DF1710552	Film, $1\mu F \pm 20\%$ , 250V
CE06	1	1	DF1710552	Film, $1\mu F \pm 20\%$ , 250V
CE07	1	1	DD1530001	Ceramic, $30PF \pm 5\%$ , 50V
CE08	1	1	DD1530001	Ceramic, $30PF \pm 5\%$ , 50V
CE09	1	1	EA1070109	Electroly, $100\mu F \pm 50\%$ , -10%, 10V
CE10	1	1	EA1070109	Electroly, $100\mu F \pm 50\%$ , -10%, 10V
CE11	1	1	EA1060359	Electroly, $10\mu F \pm 50\%$ , -10%, 35V
CE12	1	1	EA1060359	Electroly, $10\mu F \pm 50\%$ , -10%, 35V
CE13	1	1	EV3350356	Electroly, $3.3\mu F \pm 20\%$ , 35V
CE14	1	1	EV3350356	Electroly, $3.3\mu F \pm 20\%$ , 35V
CE15	1	1	DF1510305	Film, $0.01\mu F \pm 5\%$ , 50V
CE16	1	1	DF1510305	Film, $0.01\mu F \pm 5\%$ , 50V
CE17	1	1	DF1510305	Film, $0.01\mu F \pm 5\%$ , 50V
CE18	1	1	DF1510305	Film, $0.01\mu F \pm 5\%$ , 50V
CE19	1	1	DF1510305	Film, $0.01\mu F \pm 5\%$ , 50V
CE20	1	1	DF1510305	Film, $0.01\mu F \pm 5\%$ , 50V
CE21	1	1	DF1510305	Film, $0.01\mu F \pm 5\%$ , 50V
CE22	1	1	DF1510305	Film, $0.01\mu F \pm 5\%$ , 50V
CE23	1	1	DF1669205	Film, $0.068\mu F \pm 5\%$ , 50V
CE24	1	1	DF1669205	Film, $0.068\mu F \pm 5\%$ , 50V
CE25	1	1	DK1668101	Ceramic, $680PF \pm 10\%$ , 50V
CE26	1	1	DK1668101	Ceramic, $680PF \pm 10\%$ , 50V
CE27	1	1	DK1668101	Ceramic, $680PF \pm 10\%$ , 50V
CE28	1	1	DK1668101	Ceramic, $680PF \pm 10\%$ , 50V
CE29	1	1	DE1633205	Film, $0.0033\mu F \pm 10\%$ , 50V
CE30	1	1	DF1633205	Film, $0.0033\mu F \pm 10\%$ , 50V
CE31	1	1	DD1650001	Ceramic, $50PF \pm 10\%$ , 50V
CE32	1	1	DD1650001	Ceramic, $50PF \pm 10\%$ , 50V
CE33	1	1	EV1050256	Electroly, $1\mu F \pm 20\%$ , 25V
CE34	1	1	EV1050256	Electroly, $1\mu F \pm 20\%$ , 25V
CE35	1	1	EV3350356	Electroly, $3.3\mu F \pm 20\%$ , 25V
CE36	1	1	EV3350356	Electroly, $3.3\mu F \pm 20\%$ , 25V
CE37	1	1	EQ4750161	Electroly, $4.7\mu F \pm 30\%$ , 16V
CE38	1	1	EQ4750161	Electroly, $4.7\mu F \pm 30\%$ , 16V
CE39	1	1	EA2270359	Electroly, $220\mu F \pm 50\%$ , -10%, 35V
<b>PE01-MISCELLANEOUS</b>				
HE01	1	1	HC1000121	IC, BA312
HE02	1	1	HC1000121	IC, BA312
HE03	1	1	HT313272A	Transistor, 2SC1327 S. T
HE04	1	1	HT107212A	Transistor, 2SA721 S. T
HE05	1	1	HT313272A	Transistor, 2SC1327 S. T
HE06	1	1	HT107212A	Transistor, 2SA721 S. T

U ..... U.S.A.  
E ..... Europe

REF. DESIG.	U	E	PART NO.	DESCRIPTION
JE01	1	1	YP0600026	Plug, 14P
SE01	1	1	SR1005007	Rotary Switch, Tone Mode
<b>BUFFER AMP. CIRCUIT BOARD-PH01</b>				
PH01	1	1	YD2918003	P. W. Board, Buffer Amp. (Print Only)
	1	1	ZZ2918003	P. W. Board Assembly
<b>PH01-RESISTORS</b>				
All resistors are $\pm 5\%$ and $\frac{1}{4}W$ .				
RH01	1	1	RT0562214	6.2K $\Omega$
RH02	1	1	RT0568214	6.8K $\Omega$
RH03	1	1	RT0512414	120K $\Omega$
RH04	1	1	RT0512414	120K $\Omega$
RH05	1	1	RT0512414	120K $\Omega$
RH06	1	1	RT0512414	120K $\Omega$
RH07	1	1	RN0518514	1.8M $\Omega$
RH08	1	1	RN0518514	1.8M $\Omega$
RH09	1	1	RN0518514	1.8M $\Omega$
RH10	1	1	RN0518514	1.8M $\Omega$
RH11	1	1	RN0515314	15K $\Omega$
RH12	1	1	RN0515314	15K $\Omega$
RH13	1	1	RN0515314	15K $\Omega$
RH14	1	1	RN0515314	15K $\Omega$
RH15	1	1	RT0575014	75 $\Omega$
RH16	1	1	RT0575014	75 $\Omega$
RH17	1	1	RT0547214	4.7K $\Omega$
RH18	1	1	RT0547214	4.7K $\Omega$
RH19	1	1	RT0536314	36K $\Omega$
RH20	1	1	RT0522414	220K $\Omega$
RH21	1	1	RT0522414	220K $\Omega$
RH22	1	1	RT0522414	220K $\Omega$
RH23	1	1	RT0522414	220K $\Omega$
RH24	1	1	RT0575014	75 $\Omega$
RH25	1	1	RT0575014	75 $\Omega$
RH26	1	1	RT0575014	75 $\Omega$
RH27	1	1	RT0575014	75 $\Omega$
RH28	1	1	RT0510114	100 $\Omega$
<b>PF01-CAPACITORS</b>				
CH01	1	1	DF1722405	Film, 0.22 $\mu F \pm 20\%$ , 50V
CH02	1	1	DF1722405	Film, 0.22 $\mu F \pm 20\%$ , 50V
CH03	1	1	DF1722405	Film, 0.22 $\mu F \pm 20\%$ , 50V
CH04	1	1	DF1722405	Film, 0.22 $\mu F \pm 20\%$ , 50V
CH05	1	1	EV4750356	Electroly, 4.7 $\mu F \pm 20\%$ , 35V
CH06	1	1	EV4750356	Electroly, 4.7 $\mu F \pm 20\%$ , 35V
CH07	1	1	EV4750356	Electroly, 4.7 $\mu F \pm 20\%$ , 35V
CH08	1	1	EV4750356	Electroly, 4.7 $\mu F \pm 20\%$ , 35V
CH09	1	1	DK1750201	Ceramic, 5000PF $\pm 20\%$ , 50V
CH10	1	1	DK1750201	Ceramic, 5000PF $\pm 20\%$ , 50V
CH11	1	1	DK1750201	Ceramic, 5000PF $\pm 20\%$ , 50V
CH12	1	1	DK1750201	Ceramic, 5000PF $\pm 20\%$ , 50V
CH13	1	1	EA2270359	Electroly, 220 $\mu F$ , 35V
<b>PE01-SEMICONDUCTORS &amp; PLUGS</b>				
HH01	1	1	HT313452A	Transistor, 2SC1345 D, E
HH02	1	1	HT313452A	Transistor, 2SC1345 D, E
HH03	1	1	HT313452A	Transistor, 2SC1345 D, E
HH04	1	1	HT313452A	Transistor, 2SC1345 D, E
HH05	1	1	HT107202A	Transistor, 2SC720 R, S
HH06	1	1	HT107202A	Transistor, 2SC720 R, S
HH07	1	1	HT107202A	Transistor, 2SC720 R, S
HH08	1	1	HT107202A	Transistor, 2SC720 R, S

REF. DESIG.	U	E	PART NO.	DESCRIPTION
HH09	1	1	HT313182Q	Transistor, 2SC1318 Q, R
HH10	1	1	HT313182Q	Transistor, 2SC1318 Q, R
HH11	1	1	HV0000606	Varistor, VD1222
JH01	1	1	YP1000113	Plug
JH10	1	1		
<b>DOLBY, TONE &amp; METER CIRCUIT BOARD - PL01</b>				
PL01	1	1	YD2886009	P. W. Board, Dolby, Tone & Meter (Print Only)
	1	1	ZZ2918109	P. W. Board Assembly
<b>PL01-RESISTORS</b>				
All resistors are $\pm 5\%$ and $\frac{1}{4}W$ , unless otherwise indicated.				
RL01	1	1	RT0533214	3.3K $\Omega$
RL02	1	1	RT0547314	47K $\Omega$
RL03	1	1	RT0510114	100 $\Omega$
RL04	1	1	RT0533214	3.3K $\Omega$
RL05	1	1	RT0510214	1K $\Omega$
RL06	1	1	RT0512314	12K $\Omega$
RL07	1	1	RT0547314	47K $\Omega$
RL08	1	1	RC1010212	1K $\Omega \pm 10\%$ , $\frac{1}{2}W$
RL09	1	1	RT0547214	4.7K $\Omega$
RL10	1	1	RT0510214	1K $\Omega$
RL11	1	1	RA0501012	Trimming, 500 $\Omega$ (B)
RL12	1	1	RA0502019	Trimming, 5K $\Omega$ (B)
RL13	1	1	RT0556314	56K $\Omega$
RL14	1	1	RT0556314	56K $\Omega$
RL15	1	1	RT0547214	4.7K $\Omega$
RL16	1	1	RT0533314	33K $\Omega$
RL20	1	1	RT0568414	680K $\Omega$
RL21	1	1	RT0568414	680K $\Omega$
RL22	1	1	RT0533414	330K $\Omega$
RL23	1	1	RT0533414	330K $\Omega$
RL24	1	1	RT0533214	3.3K $\Omega$
RL25	1	1	RT0533214	3.3K $\Omega$
RL26	1	1	RT0515214	1.5K $\Omega$
RL27	1	1	RT0515214	1.5K $\Omega$
RL28	1	1	RA0152004	Trimming, 1.5K $\Omega$ (B)
RL29	1	1	RA0152004	Trimming, 1.5K $\Omega$ (B)
<b>PL01-CAPACITORS</b>				
CL01	1	1	DF1515305	Film, 0.015 $\mu F \pm 5\%$
CL02	1	1	DF1515305	Film, 0.015 $\mu F \pm 5\%$
CL03	1	1	DF1668301	Film, 0.068 $\mu F \pm 10\%$
CL04	1	1	DF1610401	Film, 0.1 $\mu F \pm 10\%$
CL05	1	1	EA1060169	Electroly, 10 $\mu F$ , 16V
CL06	1	1	EA1060169	Electroly, 10 $\mu F$ , 16V
CL07	1	1	EA1060169	Electroly, 10 $\mu F$ , 16V
CL10	1	1	EA1060169	Electroly, 10 $\mu F$ , 16V
CL11	1	1	EA1060169	Electroly, 10 $\mu F$ , 16V
CL12	1	1	EA1060169	Electroly, 10 $\mu F$ , 16V
CL13	1	1	EA1060169	Electroly, 10 $\mu F$ , 16V
CL14	1	1	EA3360359	Electroly, 33 $\mu F$ , 35V
<b>PL01-SEMICONDUCTORS &amp; PLUGS</b>				
HL01	1	1	HT307331C	Transistor, 2SC733 GR
HL02	1	1	HT307331C	Transistor, 2SC733 GR
HL03	1	1	HT307331C	Transistor, 2SC733 GR
HL06	1	1	HT307331C	Transistor, 2SC733 GR
HL07	1	1	HT307331C	Transistor, 2SC733 GR
HL08	1	1	HD1000105	Diode, IN60

REF. DESIG.	U	E	PART NO.	DESCRIPTION
HL09	1	1	HD1000105	Diode, IN60
HL10	1	1	HD1000105	Diode, IN60
HL11	1	1	HD1000105	Diode, IN60
PL01 ? PL09	1	1	YP1000113	Plug
<b>GENERAL MISCELLANEOUS</b>				
0803	1	1	291816050	Bracket K
0811	2	2	51100306A	B. H. M. Screw B3 x 6
0813	2	2	51100306A	B. H. M. Screw B3 x 6
0814	2	2	51100306A	B. H. M. Screw B3 x 6
0815	2	2	51100306A	B. H. M. Screw B3 x 6
0819	2	2	51100306A	B. H. M. Screw B3 x 6
0824	2	2	51100306A	B. H. M. Screw B3 x 6
0828	3	3	51570305B	P. H. Tapt Screw P3 x 5 ST
0832	2	2	51570305B	P. H. Tapt Screw P3 x 5 ST
0908	2	2	291612001	Insulator
0911	1	1	289212201	Sticker
0916	1	1	291812002	Insulator
1034	2	2	51042608A	F. H. M. Screw F2.6 x 8
1111	2	2	51570306B	P. H. Tapt Screw P3 x 6 ST
1112	2	2	54050300R	T. L. Washer OR
1115	2	2	288610701	Sheet
1203	1	1	290416007	Bracket
1204	1	1	290416008	Bracket
1205	6	6	51100406A	B. H. M. Screw B4 x 6
1211	1	1	289226251	Pulley K
1216	2	2	51100306A	B. H. M. Screw B3 x 6
1311	1	1	257710602	Bearing
1312	1	1	141511801	Spacer
1313	2	2	51040306A	F. H. M. Screw F3 x 6
1320	2	2	51470306A	B. H. M. Screw S
1410	2	2	287105302	Cover
M001	1	1	IM1104213	DC Meter, Multipath, FM Tuning
M002	1	1	IM1104209	DC Meter, Dolby Level, Signal
C010	1	1	EA3360109	Electroly Cap., 33μF, 10V
C011	1	1	EA3360109	Electroly Cap., 33μF, 10V
J019	1	1	YJ0600061	Jack, 14P
1003	1	1	289227401	Reflector
1005	1	1	289227101	Holder
1006	2	2	51570306B	P. H. Tapt Screw P3 x 6 ST
1007	2	2	59030805P	Washer
1009	1	1	289227102	Holder
1010	2	2	51570306B	P. H. Tapt Screw P3 x 6 ST
1012	2	2	51480306A	B. H. M. Screw F
1013	2	2	51100304A	B. H. M. Screw B3 x 4
<b>FUNCTION LAMP BOARD-PY01</b>				
PY01	1	1	YD2918008	P. W. Board, Function Lamp (Print Only)
	1	1	ZZ2918008	P. W. Board Assembly
<b>PY01-MISCELLANEOUS</b>				
MY01 ? MY08	1	1	IN1008037	Lamp, 8V, 40mA

REF. DESIG.	U	E	PART NO.	DESCRIPTION
JY01 ? JY12	1	1	YP1000113	Plug
<b>DIAL LAMP BOARD-PZ01</b>				
PZ01	1	1	YD2892001	P. W. Board, Dial Lamp (Print Only)
	1	1	ZZ2918201	P. W. Board Assembly
<b>PZ01-MISCELLANEOUS</b>				
MZ01 ? MZ06	1	1	IN1008007	Lamp
JZ01 ? JZ10 JZ11 ? JZ15 JZ17 ? JZ19	1	1	YJ0800017	Socket
	1	1	YP1000113	Plug
	1	1	YP1000113	Plug
M004	1	1	IN1008007	Lamp, Meter Lamp
M005	1	1	IN1008007	Lamp, Meter Lamp
J028	1	1	YJ0800019	Socket Meter Lamp
J029	1	1	YJ0800019	Socket Meter Lamp
1103	1	1	288627401	Reflector
1106	1	1	288627102	Holder
1107	2	2	51570306B	P. H. Tapt Screw P3 x 6 ST
1109	2	2	51480306A	B. H. M. Screw F.
S004	1	1	SP0201009	Plushswitch, Meter L/R
J007	1	1	YJ0100098	Jack, Dubbing Out
J008	1	1	YJ0100081	Jack, Dubbing In
0827	1	1	291816005	Bracket
R005	1	1	RK0504010	Variable Resist., 500KΩ (B)
R006	1	1	RK0504010	Variable Resist., 500KΩ (B)
R007	1	1	RK0504010	Variable Resist., 500KΩ (B)
R008	1	1	RK0504010	Variable Resist., 500KΩ (B)
0818	1	1	289216003	Bracket
<b>DOLBY TONE, TAPE MON. BOARD-PS01</b>				
PS01	1	1	YD2918005	P. W. Board, Dolby Tone/Tape Mon. (Print Only)
	1	1	ZZ2918005	P. W. Board Assembly
<b>SWITCH BOARD-PT01</b>				
PT01	1	1	YD2918006	P. W. Board, Switch (Print Only)
	1	1	ZZ2918006	P. W. Board Assembly
<b>PT01-MISCELLANEOUS</b>				
ST01	1	1	SP0603011	Pushswitch
JT01 ? JT25	1	1	YP1000113	Plug

U ..... U.S.A.  
E ..... Europe

REF. DESIG.	U	E	PART NO.	DESCRIPTION
R001	1	1	RS0503020	Variable Resist., 50KΩ (MN) <i>GM</i>
PU01	1	1	YD2918007	<b>MULTIPATH, HI BLEND CIRCUIT BOARD-PU01</b> P. W. Board, Multipath/Hi Blend (Print Only)
	1	1	ZZ2918007	P. W. Board Assembly
SU01	1	1	SP0408001	<b>PU01-SWITCH</b> Pushswitch
				<b>PU01-RESISTORS</b> All resistors are ±5% and ¼W, unless otherwise indicated.
RU01	1	1	GD0520314	20KΩ
RU02	1	1	GD0522214	2.2KΩ
RU03	1	1	GD0522214	2.2KΩ
RU04	1	1	GD0510314	10KΩ
RU05	1	1	RT0556214	5.6KΩ
RU06	1	1	RT0510214	1KΩ
RU07	1	1	GD0510414	100KΩ
RU08	1	1	RT0547414	470KΩ
RU09	1	1	RT0547414	470KΩ
RU10	1	1	RT0512314	12KΩ
RU11	1	1	RT0512314	12KΩ
RU12	1	1	RT0512314	12KΩ
RU13	1	1	RT0512314	12KΩ
RU14	1	1	RT0522514	2.2MΩ
RU15	1	1	RT0522514	2.2MΩ
RU16	1	1	RT0518514	1.8MΩ
RU17	1	1	RT0518514	1.8MΩ
RU18	1	1	RN0518514	1.8MΩ
RU19	1	1	RN0518514	1.8MΩ
RU20	1	1	GD0543314	43KΩ
RU21	1	1	GD0510414	100KΩ
RU22	1	1	GD0522314	22KΩ
RU23	1	1	GD0522314	22KΩ
RU24	1	1	GD0547214	4.7KΩ
RU25	1	1	GD0547214	4.7KΩ
RU26	1	1	GD0522414	220KΩ
RU27	1	1	GD0522414	220KΩ
RU28	1	1	GD0522114	220Ω
RU29	1	1	GD0522114	220Ω
RU30	1	1	RT0516214	1.6KΩ
RU31	1	1	RT0513214	1.3KΩ
RU32	1	1	GQ1033103	330Ω ± 10%, 3W
RU33	1	1	GQ1033103	330Ω ± 10%, 3W
RU34	1	1	GJ0515101	150Ω ± 5%, 1W
RU35	1	1	GJ0515101	150Ω ± 5%, 1W
				<b>PU01-CAPACITORS</b>
CU01	1	1	EA4750359	Electroly, 4.7μF, 35V
CU02	1	1	EA4750359	Electroly, 4.7μF, 35V
CU03	1	1	EA1060169	Electroly, 10μF, 16V
CU04	1	1	EA4750359	Electroly, 4.7μF, 35V
CU05	1	1	DF1622305	Film, 2200PF±5%, 50V
CU06	1	1	DF1547205	Film, 4700PF±5%, 50V
CU07	1	1	DF1547205	Film, 4700PF±5%, 50V
CU08	1	1	DF1547205	Film, 4700PF±5%, 50V
CU09	1	1	DF1547205	Film, 4700PF±5%, 50V
CU10	1	1	DF1522205	Film, 2200PF±5%, 50V
CU11	1	1	DF1522205	Film, 2200PF±5%, 50V
CU12	1	1	DF1510205	Film, 1000PF±5%, 50V

REF. DESIG.	U	E	PART NO.	DESCRIPTION
CU13	1	1	DF1510205	Film, 1000PF ± 5%, 50V
CU14	1	1	DF1722405	Film, 0.22μF ± 20%, 50V
CU15	1	1	DF1722405	Film, 0.22μF ± 20%, 50V
CU16	1	1	EV4750356	Electroly, 4.7μF, 35V
CU17	1	1	EV4750356	Electroly, 4.7μF, 35V
CU18	1	1	DK1750201	Ceramic, 5000PF, 50V
CU19	1	1	DK1750201	Ceramic, 5000PF, 50V
CU20	1	1	EA4760359	Electroly, 47μF, 35V
CU21	1	1	EA1060169	Electroly, 10μF, 16V
				<b>PU01-SEMICONDUCTORS &amp; PLUGS</b>
HU01	1	1	HT308282A	Transistor, 2SC828R,S
HU02	1	1	HT308282A	Transistor, 2SC828R,S
HU03	1	1	HD1000105	Diode, IN60
HU04	1	1	HD1000105	Diode, IN60
HU05	1	1	HT313272A	Transistor, 2SC1327S,T
HU06	1	1	HT313272A	Transistor, 2SC1327S,T
HU07	1	1	HT107223A	Transistor, 2SA722S,T,U
HU08	1	1	HT107223A	Transistor, 2SA722S,T,U
JU01	?	1	YP1000113	Plug
JU21				
				<b>GENERAL MISCELLANEOUS</b>
S005	1	1	SP0101017	Pushswitch, Power Supply
0822	1	1	290416006	Bracket
0823	2	2	51100306A	B. H. M. Screw B3 x 6
J009	1	1	YJ0100098	Jack, Phone
0831	1	1	291816006	Bracket
2306	1	1	62030039W	Lug
1016	1	1	289205101	Guide
1018	1	1	289226252	Pulley K
1025	1	1	289226253	Pulley K
1032	4	4	51570305B	P. H. Tapt Screw P3 x 6ST
1316	1	1	285310650	Bearing K
1326	1	1	51640412D	Set Screw C.P.
1327	1	1	54040402N	Spring Washer
1328	1	1	53110403E	Hexagon Nut
0503	1		291816001	Bracket
0505		1	291816022	Bracket
0511	1		145525903	Bush
0513	4	4	51100308S	B. H. M. Screw B3 x 8
0514	4	4	53110303A	Hexagon Nut
0515	4	4	54050300R	T. L. Washer OR
0526	1		282125901	Bush
0527	2		53110303A	Hexagon Nut
0528	2		54050300R	T. L. Washer OR
0529	2		51060316A	P. H. M. Screw P3 x 16
0530	2		55060305S	T. R. Rivet
0532	1		284906702	Cap
0603	4	4	51100306S	B. H. M. Screw B3 x 6
0604	4	4	53110303A	Hexagon Nut
0606	2	2	51100306S	B. H. M. Screw B3 x 6
0609	8	8	51100306S	B. H. M. Screw B3 x 6
0610	8	8	53110303A	Hexagon Nut
0613	3	3	53228059E	Nut
0619	1	1	54050400R	T. L. Washer OR
0720	3	3	51100306S	B. H. M. Screw B3 x 6
0722	1	1	145525903	Bush

REF. DESIG.	U	E	PART NO.	DESCRIPTION
J002	1	1	YT0101003	Terminal, Ground
J003	1	1	YT0204008	Terminal, Phono/Aux, 4P
J004	1	1	YT0208006	Terminal, Tape In, Out, 8P
J006	1	1	YT0201009	Terminal, Quadradial, 1P
J010	1	1	YT0304008	Terminal, Main Spk
J011	1	1	YT0304008	Terminal, Remote Spk
J012	1	1	YJ0400048	Plug, AC Outlet
J013	1	1	YJ0400048	Plug, AC Outlet
J014	1	1	YJ0800012	Socket, Fuse Holder
W002	1	1	YC0240010	AC Cord
F001	1	1	FS1080004	Fuse, 8A UL
G001	1	1	BF1040003	Printed Compo.
R014	1	1	RA0203007	Variable Resist., 20KΩ (B)
L001	1	1	LF1120038	Ant. Coil, AM
0705	1	1	257816052	Bracket K
0710	1	1	281927103	Holder
0712	2	2	51100308S	B. H. M. Screw B3 x 8
0713	2	2	53110303E	Hexagon Nut
0716	2	2	51100310S	B. H. M. Screw B3 x 10
0717	2	2	53110303E	Hexagon Nut
PV01	1	1	YD2918009	<b>ANTENNA TERMINAL BOARD-PV01</b> P. W. Board, Antenna Terminal (Print Only)
	1	1	ZZ2918009	P. W. Board Assembly
LV01	1	1	LB3007526	<b>PV01-MISCELLANEOUS</b> Balun Coil 300Ω-75Ω
LV02	1	1	LC1154002	Choke Coil
JV01	1	1	YP1000113	Plug
JV02	1	1	YP1000113	Plug
JV03	1	1	YP1000113	Plug
J001	1	1	YT0304007	Terminal, AM/FM Ant.
0607	1	1	291616005	Bracket
PC01	1	1	YD2892011	<b>FM CAL.&amp; DE-EMPHASIS CIRCUIT BOARD-PC01</b> P. W. Board, FM Cal.& FM De-Emphasis (Print Only)
	1	1	ZZ2918111	P. W. Board Assembly
RC01	1	1	RT0515414	<b>PC01-RESISTORS &amp; PLUGS</b> Resistor, 150KΩ ± 5%, ¼W
RC02	1	1	RT0515414	Resistor, 150KΩ ± 5%, ¼W
RC03	1	1	RT0582214	Resistor, 8.2KΩ ± 5%, ¼W
RC04	1	1	RT0582214	Resistor, 8.2KΩ ± 5%, ¼W
RC05	1	1	RK0203030	Variable Resist., 20KΩ(B)
RC06	1	1	RK0203030	Variable Resist., 20KΩ(B)
JC01	1	1	YP1000113	Plug
JC02	1	1	YP1000113	Plug
JC03	1	1	YP1000113	Plug
JC04	1	1	YP1000113	Plug
JC05	1	1	YP1000113	Plug
JC06	1	1	YP1000113	Plug

REF. DESIG.	U	E	PART NO.	DESCRIPTION
C002	1	1	DK1710301	<b>GENERAL MISCELLANEOUS</b> Ceramic Cap., 0.01μF ± 20%, 50V
C003	1	1	DK1710301	Ceramic Cap., 0.01μF ± 20%, 50V
C004	1	1	DK1710301	Ceramic Cap., 0.01μF ± 20%, 50V
0620	1	1	62041760W	Lug
R009	1	1	RC1022512	Resistor, 2.2MΩ ± 10%, ¼W
2322	1	1	62030039W	Lug
C015	1	1	DK1710301	Ceramic Cap., 0.01μF ± 20%, 50V
J005	1	1	YT0204009	Terminal, Pre Out/Main In
2325	1	1	62030039W	Lug
1403	1	1	291830201	Dial
1408	1	1	289210701	Sheet
S001	1	1	SR1006015	Rotary Switch, Selector
S002	1	1	SR2505002	Rotary Switch, Dolby
R012	1	1	RT0539214	Resistor, 3.9KΩ ± 5%, ¼W
C013	1	1	DF1522205	Film Cap., 2200PF ± 5%, 50V
C013	1	1	DF1510205	Film Cap., 1000PF ± 5%, 50V
S003	1	1	SR0405007	Rotary Switch, Mode
R002	1	1	RT0510214	Resistor, 1KΩ ± 5%, ¼W
R003	1	1	RT0510214	Resistor, 1KΩ ± 5%, ¼W
R004	1	1	RT0515114	Resistor, 150Ω ± 5%, ¼W
C014	1	1	DF1522205	Film Cap., 2200PF ± 5%, 50V
C014	1	1	DF1510205	Film Cap., 1000PF ± 5%, 50V
1718	1	1	291726703	Heat Sink
1722	4	4	51100310B	B. H. M. Screw B3 x 10
1723	4	4	54040302N	Spring Washer
1724	4	4	53110301E	Hexagon Nut
H009	1	1	HD20Q1608	Rectifier, SG-5TS
H010	1	1	HD20Q1708	Rectifier, SG-5TR
C006	1	1	DF1710453	Film Cap., 0.1μF ± 20%, 250V
C007	1	1	DF1710453	Film Cap., 0.1μF ± 20%, 250V
L003	1	1	LC1332002	Choke Coil, 3.3μH
C005	1	1	DK1710301	Ceramic Cap., 0.01μF ± 20%, 50V
J016	1	1	YL0105011	Plug, 5P (UL)
R010	1	1	GJ0522203	Resistor, 2.2KΩ ± 5%, 3W
R011	1	1	GJ0522203	Resistor, 2.2KΩ ± 5%, 3W
J015	1	1	YL0105011	Plug, 5P (UL)
2008	1	1	291810905	Shield
2010	1	1	291812001	Insulator
2123	1	1	289216012	Bracket
2125	1	1	62030039W	Lug
R013	1	1	RA0503014	Variable Resist., 50KΩ (B)
W012	1	1	YB0007001	Connective Cord
W013	1	1	YB0007001	Connective Cord
J031	1	1	YL0106004	Terminal, Voltage Conversion



U ..... U.S.A.  
E ..... Europe

REF. DESIG.	U	E	PART NO.	DESCRIPTION
2210		1	289216006	Bracket
2211		1	285412001	Insulator
2212		2	51100310E	B. H. M. Screw B3 x 10
2213		5	54060300R	T. L. Washer IR
<b>FUSE BOARD-PR01</b>				
PR01		1	YD2892010	P. W. Board, Fuse (Print Only)
		1	ZZ2892810	P. W. Board Assembly
<b>PR01-MISCELLANEOUS</b>				
FR01		1	FS1060002	Fuse, 6A
FR02		1	FS1015003	Fuse, 1.5A
FR03		1	FS1015003	Fuse, 1.5A
FR03		1	FS1020005	Fuse, 2A
JR01		1	YJ0800020	Jack
JR02		1	YJ0800020	Jack
JR03		1	YJ0800020	Jack
JR04		1	YJ0800020	Jack
JR05		1	YJ0800020	Jack
JR06		1	YJ0800020	Jack
JR07		1	YJ0800020	Jack
JR08		1	YJ0800020	Jack
JR09		1	YP1000099	Plug
JR10		1	YP1000099	Plug
JR11		1	YP1000099	Plug
JR12		1	YP1000099	Plug
JR13		1	YP1000099	Plug
JR14		1	YP1000099	Plug
JR15		1	YP1000099	Plug
JR16		1	YP1000099	Plug
<b>GENERAL MISCELLANEOUS</b>				
2525		1 1	138200503	Clamper
2234		1 1	138200503	Clamper
2232		1 1	138200503	Clamper
0903		1 1	291810907	Shield
0904		1 1	288912005	Insulator
0906		2 2	291812004	Insulator
0221		4 4	275905701	Leg
0222		4 4	51490410S	B. H. M. Screw F. S.
0733		8 8	51100306S	B. H. M. Screw B3 x 6
0905		4 4	51100304A	B. H. M. Screw B3 x 4
0913		1 1	261105501	Collor
1207		14 14	51570306B	P. H. Tapt Screw P3 x 6
1503		1 1	291810550	Chassis K
1512		2 2	289225901	Bush
1603		4 4	51490614A	B. H. M. Screw F. S.
1604		4 4	53110601A	Hexagon Nut
1605		4 4	54020801A	Flat Washer P
1616		4 4	515704088	P. H. Tapt Screw P4 x 8 ST
1618		1 1	291816004	Bracket
1620		2 2	51100508E	B. H. M. Screw B5 x 8
1621		2 2	54020501E	Flat Washer P
1622		2 2	54040502N	Spring Washer
1624		2 2	51570408B	P. H. Tapt Screw P4 x 8 ST
1625		2 2	54050400R	T. L. Washer OR
1631		2 2	51100508E	B. H. M. Screw B5 x 8
1632		2 2	54040502N	Spring Washer
1711		4 4	51100306S	B. H. M. Screw B3 x 6
1720		2 2	51570308B	P. H. Tapt Screw P3 x 8 ST
1920		8 8	51570306B	P. H. Tapt Screw P3 x 6 ST
1926		1 1	291810901	Shield

REF. DESIG.	U	E	PART NO.	DESCRIPTION
1927		4 4	51570306B	P. H. Tapt Screw P3 x 6 ST
2003		4 4	288810102	Support
2009		2 2	51570306B	P. H. Tapt Screw P3 x 6 ST
2013		4 4	288810102	Support
2029		2 2	51570306B	P. H. Tapt Screw P3 x 6 ST
2103		4 4	285610102	Support
2104		1 1	281810107	Support
2107		1 1	285610902	Shield
2108		5 5	51100304E	B. H. M. Screw B3 x 4
2113		4 4	51100306S	B. H. M. Screw B3 x 6
2117		2 2	288605501	Collor
2118		2 2	51100310S	B. H. M. Screw B3 x 10
2124		2 2	51570305B	P. H. Tapt Screw P3 x 5 ST
2131		2 2	288616011	Bracket
2132		2 2	288612009	Insulator
2133		4 4	51570306B	P. H. Tapt Screw P3 x 6 ST
2203		2 2	51100306S	B. H. M. Screw B3 x 6
2214		2	53110503A	Hexagon Nut
2215		2	54040502N	Spring Washer
2216		1	289212006	Insulator
2217		2	51100312S	B. H. M. Screw B3 x 12
2221		1	285416003	Bracket
2222		2	51570306B	P. H. Tapt Screw P3 x 6 ST
2223		2	51100306S	B. H. M. Screw
2229		2 2	291811802	Spacer
2235		1 1	53110503A	Hexagon Nut
2327		1 1	138200503	Clamper
2328		1 1	51570306B	P. H. Tapt Screw P3 x 6 ST
2329		1 1	54050300R	T. L. Washer OR
2303		2 2	281805603	Buffer
2307		1 1	51570306B	P. H. Tapt Screw P3 x 6 ST
2309		1 1	138200503	Clamper
2310		1 1	51570306B	P. H. Tapt Screw P3 x 6 ST
2311		1 1	54050300R	T. L. Washer OR
2313		2 2	51570306B	P. H. Tapt Screw P3 x 6 ST
2314		2 2	54050300R	T. L. Washer OR
2316		1 1	51570306B	P. H. Tapt Screw P3 x 6 ST
2317		1 1	54050300R	T. L. Washer OR
2319		1 1	51570306B	P. H. Tapt Screw P3 x 6 ST
2320		1 1	54050300R	T. L. Washer OR
2323		1 1	51570306B	P. H. Tapt Screw P3 x 6 ST
2326		1 1	51570306B	P. H. Tapt Screw P3 x 6 ST
2331		1 1	288600505	Clamper
2332		2 2	288600506	Clamper
2334		2 2	288600505	Clamper
2518		4 4	51570306B	P. H. Tapt Screw P3 x 6 ST
L004		1	TS6330207	Transformer
L004		1	TS6330208	Transformer
C008		1 1	EC1590701	Electroly Cap., 15μF + 50%, -10%, 70V
C009		1 1	EC1590701	Electroly Cap., 15μF + 50%, -10%, 70V
J017		1 1	YJ0600062	Jack
J018		1 1	YJ0600063	Jack
0113		3 3	289610701	Sheet
0116		4 4	52017039J	Bolt
0118		1 1	291605501	Collor
0119		1 1	289205502	Collor
0120		1 1	51340308P	F. H. Tap Screw
0207		4 4	51480406S	B. H. M. Screw F
0208		4 4	51122605S	T. H. M. Screw T2.6 x 5
0217		12 12	51100406S	B. H. M. Screw B4 x 6
0303		1 1	290415404	Knob, Power Switch

U ..... U.S.A.  
E ..... Europe

REF. DESIG.	U	E	PART NO.	DESCRIPTION
0304	1	1	285015401	Knob, Slide Volume
0305	4	4	288615401	Knob, Dolby Level
0306	12	12	288615403	Knob, Pushswitch
0308	5	5	281815403	Knob, 24φ
0403	1		291826501	Indicator
0405	1	1	291826503	Indicator
0412	2	2	51100305S	B. H. M. Screw B3 x 5
0416	1	1	257886101	Label, UL Caution
0417	1	1	257886102	Label, Do not remove cover.
0418	1	1	257886103	Label, See marking on bottom.
0419	1	1	250626506	Indicator, Do not use as handle.
0423	1		951110102	Label, UL
0424	1		951091102	Label, UL Factory Cord No.
0434	1	1	288686102	Label, Dolby
0435	1	1	288686101	Label, Marantz
1323	1	1	285011202	Shaft
1324	1	1	54040402N	Spring Washer
1414	1	1	287311802	Spacer
1417	1	1	289226902	Protector
1418	2	2	51570306B	P. H. Tapt Screw P3 x 6 ST
1421	1	1	291826901	Protector
1422	2	2	51570306B	P. H. Tapt Screw P3 x 6 ST
1425	1	1	281912005	Insulator
1431	1	1	289226901	Protector
1432	2	2	51100304S	B. H. M. Screw B3 x 4
2005	1	1	288910904	Shield
2006	4	4	51100304S	B. H. M. Screw B3 x 4
2015	1	1	291810906	Shield
2016	4	4	51100306S	B. H. M. Screw B3 x 6
2031	1	1	288610902	Shield
2032	2	2	51100304S	B. H. M. Screw B3 x 4
2033	2	2	51570306B	P. H. Tapt Screw P3 x 6 ST
2521	1	1	289010903	Shield
2522	4	4	289205601	Buffer
2523	2	2	51100304S	B. H. M. Screw B3 x 4
2614	1	1	56382540G	Eyelet
2903	1	1	257785401	Guarantee Card
2906	1	1	257785102	Instructions
2908	1		257781301	Envelope
2909	1		281881301	Envelope
2926	1	1	ZA0200007	Ext. Antenna, FM
3003	1	1	291880101	Packing Case, Inner
3004	1	1	291880111	Packing Case, Outer
3012	1	1	289280301	Partitioner, Upper
3013	1	1	289280302	Partitioner, Lower
3018	1	1	901534543	Polyethylen Bag, Set
3020	1	1	901302501	Polyethylen Bag, Printed Matter
3021	1	1	901302501	Polyethylen Bag, Accessories
3023	1	1	102980401	Sleeve
3024	1	1	281905601	Buffer
3025	2	2	273182101	Silicagel
3026	1		956000004	Hang Tag
3029	4		952281501	Serial NO Card
3031	4		952301511	Serial NO Card
2803	1		291885101	Instructions, Set
2804	1		291885122	Instructions, Set
2811	1		291885601	Schematic Diagram
2813	1		291885603	Schematic Diagram
2817	1		281885108	Instructions, Accessories
2821	1	1	281885110	Instructions, 4-CH
2823	1	1	281885104	Instructions, Packing

## TECHNICAL SPECIFICATIONS

### PREAMPLIFIER SECTION

Dynamic Range	Phono input: 100dB above 1.5 $\mu$ V equivalent noise input
Note: Dynamic Range is the ratio in dB of phono overload (110mV) to equivalent input noise (1.5 $\mu$ V).	
Input Sensitivity and Impedance	Phono: 1.8 mV, 47K ohms High Level: 180 mV, 100K ohms
Output Level and Impedance	Tape Recorder: 1V into 47K ohms
Pre-Out Output Impedance	1V, 900 ohms
Phono Frequency Response	30Hz to 15kHz $\pm$ 1dB (RIAA)
Noise-Aux	-80dB
Tone Controls	Treble: $\pm$ 10dB at 15kHz Bass: $\pm$ 10dB at 50Hz Mid-Range: $\pm$ 5dB at 700Hz
Filters	Hi Filter: 9kHz, 12dB per octave Low Filter: 50Hz, 12dB per octave
Loudness Compensation	7dB at 100Hz 4dB at 10kHz

### AMPLIFIER SECTION

Headphones Output	0.7V into 8 ohms at rated distortion
Input Sensitivity for MAIN IN	1V
Rated Power Output (Continuous average power per channel, all channels driven)	
Power Output	125 Watts, 4 ohms 125 Watts, 8 ohms 75 Watts, 16 ohms
Power Band	20Hz to 20kHz
THD	0.15%
Frequency Response	$\pm$ 2dB, 5Hz to 70kHz $\pm$ 1dB, 10Hz to 30kHz
Damping Factor	40 at 1kHz

### FM SECTION

Quieting Slope	1.9 $\mu$ V for 30dB, 5 $\mu$ V for 55dB 10 $\mu$ V for 60dB, 50 $\mu$ V for 70dB
Ultimate Quieting	50 $\mu$ V for 70dB
Selectivity	Alternate channel, better than 75dB
Capture Ratio	1.5dB
Muting Threshold	Muting threshold variable from 8 $\mu$ V to 40 $\mu$ V
Stereo Separation	42dB at 1kHz, 27dB at 15kHz
Total Harmonic Distortion	Stereo: Less than 0.3% Mono: Less than 0.2%
Frequency Response	$\pm$ 1dB, 30Hz to 15kHz
Total Spurious Rejection	Better than 90dB
Image Rejection	Better than 90dB
AM Suppression	Better than 60dB
IF Rejection	Better than 100dB
Antenna Impedance	300 ohm Balanced, 75 ohm unbalanced
Quadrantal Output	300 mV, 15K ohms for $\pm$ 75kHz Deviation

### AM SECTION

AM Sensitivity	Better than 40 $\mu$ V
----------------	------------------------

Selectivity ..... Adjacent channel, 1000kHz, better than 30dB  
AM Bandwidth ..... (-6dB) 7kHz  
Image Rejection ..... 1400kHz, better than 70dB

**GENERAL**

Power Requirements ..... 220V~50/60Hz  
(This unit can be converted by a qualified technician to operate 110/120/240V~50/60Hz)  
Unit Dimensions ..... Height: 5-3/8" (without feet)  
Dimensions — Panel Width ..... 19-5/16"-490mm  
                  — Panel Height ..... 5-3/4"-146mm  
                  — Depth ..... 15-3/16"-386mm  
Weight — Unit alone ..... 49.5lbs-22.5Kg  
          — Packed for Shipment ..... 57.2lbs-26.0Kg

\* These specifications and exterior designs may be changed for improvement without advance notice.

## SERVICE INFORMATION FOR EUROPEAN MODEL

The information contained here in included the rear panel and main chassis component locations, voltage conversion, FTZ regulation and schematic diagram.  
For the circuit description, alignment method and repairing hints, refer to the original service manual.

### TABLE OF CONTENTS

Main Chassis Component Locations (Top View) .....	45
Voltage Conversion .....	46
Voltage Conversion Chart .....	46
FTZ Regulation .....	46
Schematic Diagram .....	49

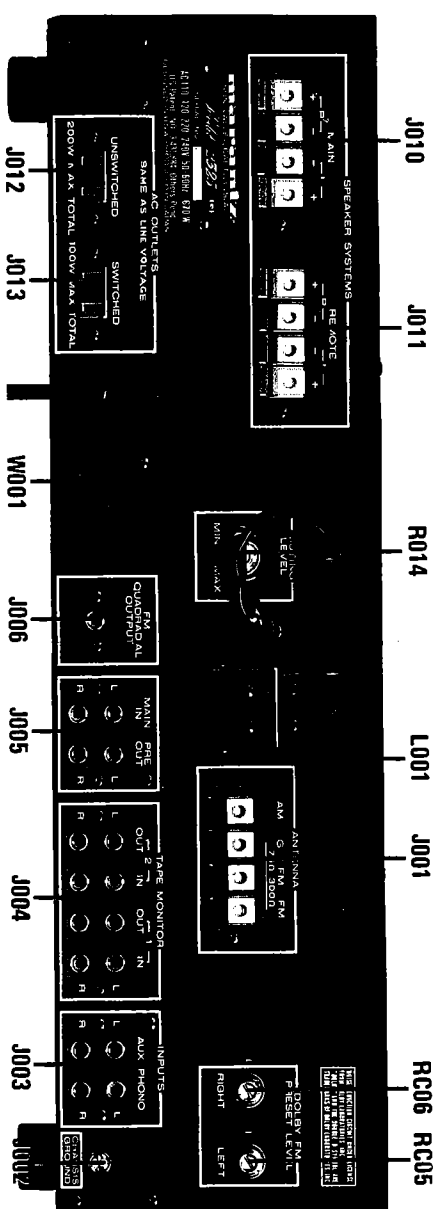

Figure 26. Rear Panel Adjustments and Component Locations

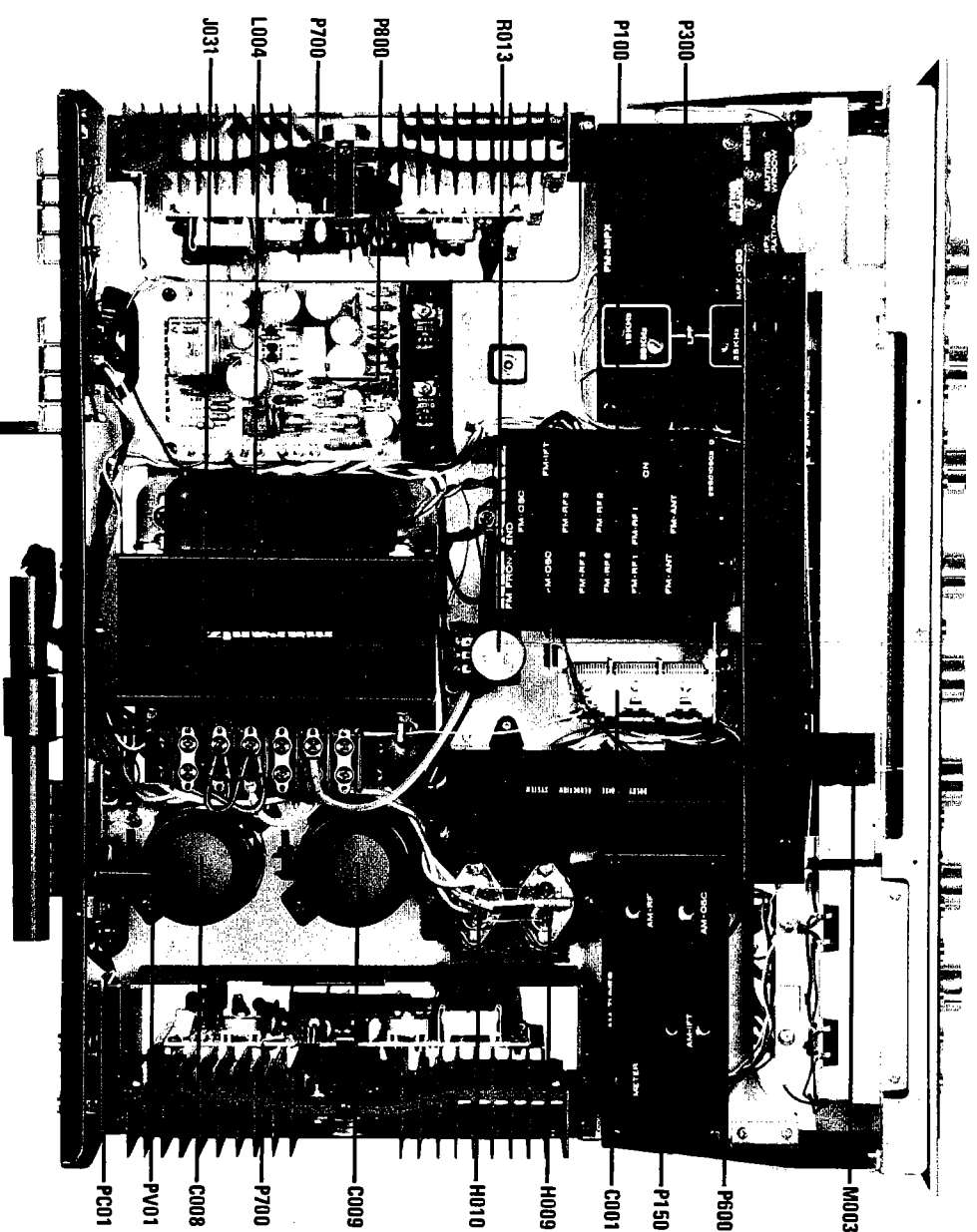

Figure 27. Main Chassis Component Locations (Top View)

**VOLTAGE CONVERSION**

This model is equipped with a universal power transformer to permit operation at 110, 120, 220 and 240 V AC 50 to 60 Hz.

To convert the unit to the required voltage perform the following steps:

- (1) Remove the lid (top).
- (2) Change the jumper wires as illustrated below for the required AC voltage.

**NOTE**

**CAUTION: DISCONNECT POWER SUPPLY CORD FROM AC OUTLET BEFORE CONVERTING VOLTAGE.**

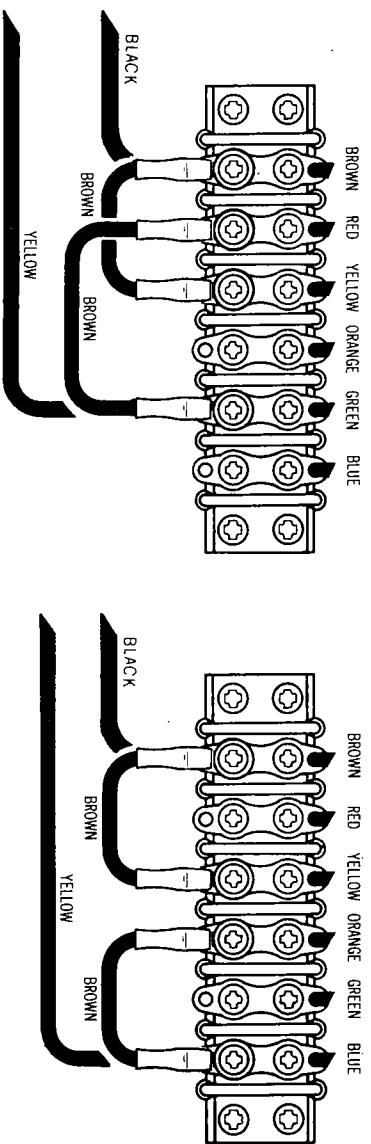

For 110V Operation

For 120V Operation

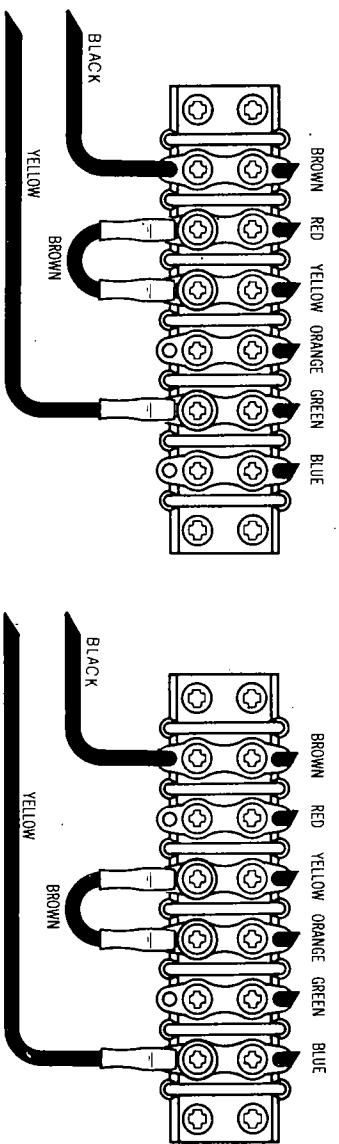

For 220V Operation

For 240V Operation

Figure 28. Voltage Conversion Chart

**FTZ REGULATION**

Instruction for the use in the range other than specified in FTZ codes

Achtung für die Leute, die in dem Gebiet wohnen, wo die FTZ-Bestimmungen vorherrschend sind.

Sollte das Gerät auch für Frequenzen ausserhalb des in den FTZ-Bestimmungen angegebene. Bereiches empfangebereit sein, bitten wir, den Bereich durch Nachstellen des Kernes in der Oszillatorspule (in der Abbildung mit "FTZ" gekennzeichnet) so zu korrigieren, dass er den Bestimmungen entspricht.

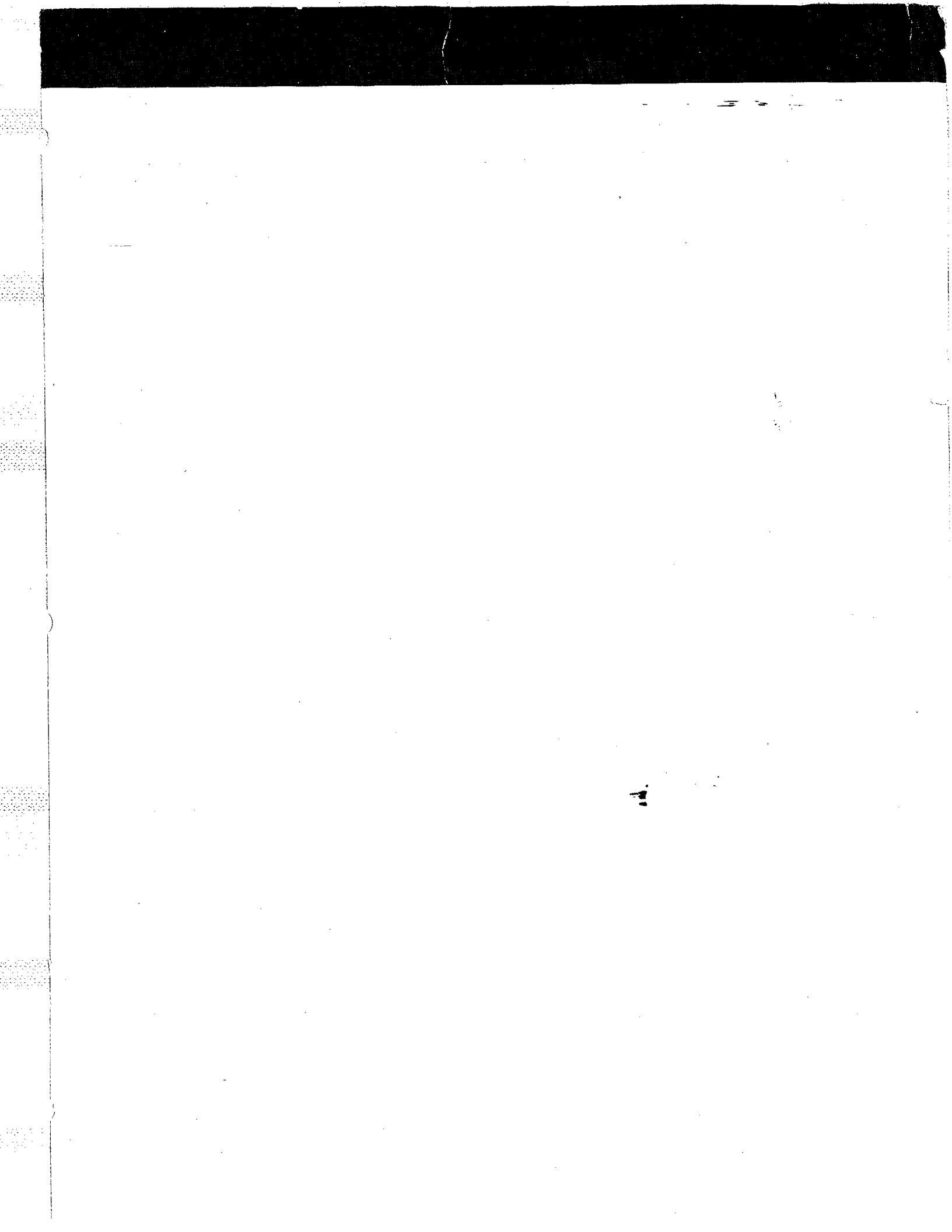



**marantz**

**MARANTZ CO., INC. • P.O. BOX 99 • SUN VALLEY, CALIFORNIA • 91352**



A WHOLLY-OWNED SUBSIDIARY OF SUPERSCOPE INC., SUN VALLEY, CALIFORNIA 91352

SQ is a trademark of CBS INC.  
Noise reduction circuit under license from Dolby Laboratories, Inc.  
"DOLBY" and the Double-D symbol are trademarks of Dolby Laboratories, Inc.