

SERVICE
MANUAL 110

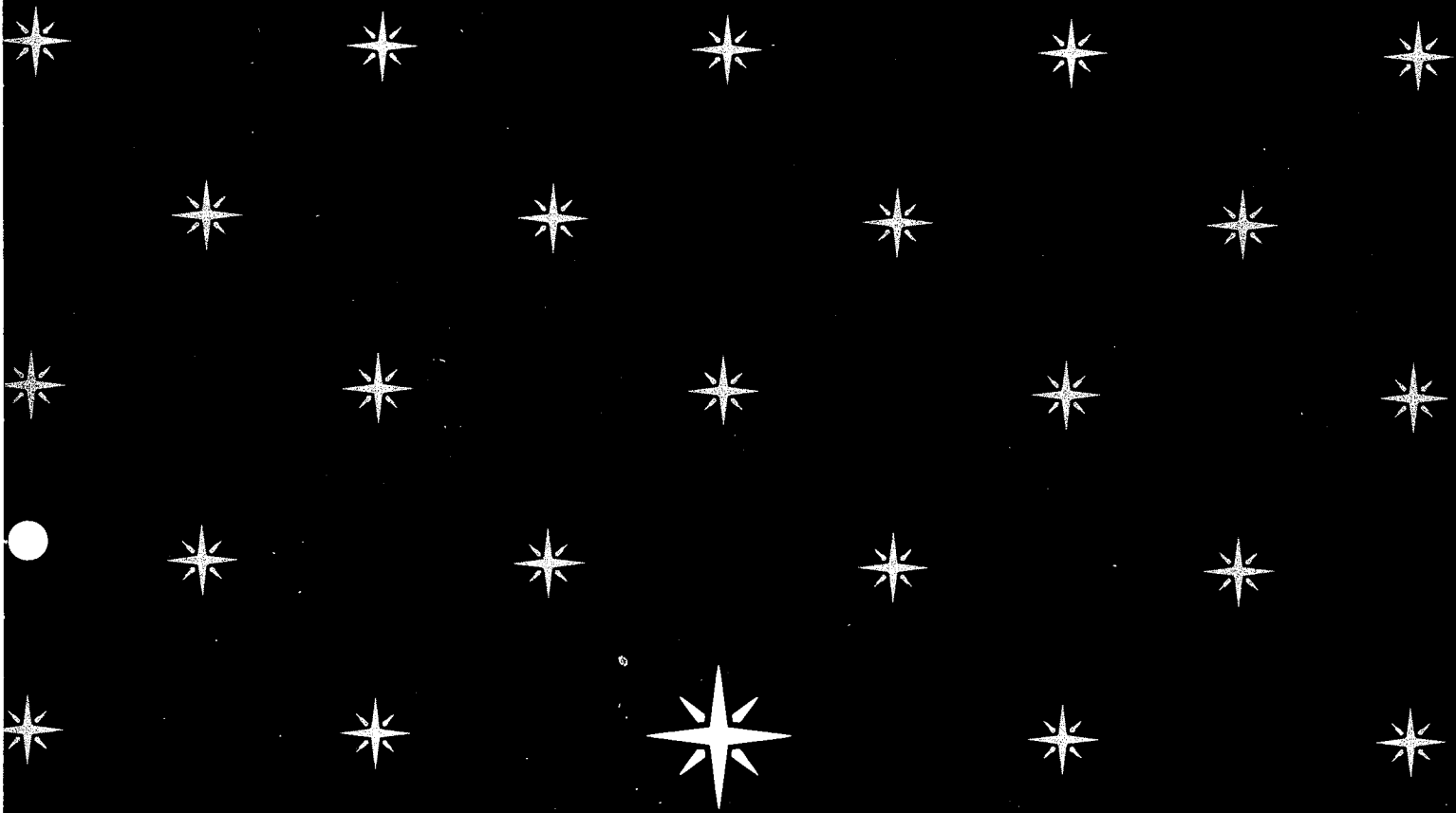

marantz

model 110

Fm / Am
Stereophonic Tuner

TABLE OF CONTENTS

SECTION	PAGE
Introduction	1
AM Tuner	1
FM Tuner	2
AM Alignment Procedure	3
FM Alignment Procedure	4
Test Equipment Required for Servicing	5
Voltage Conversion	5
Parts List	15
Specifications	21

LIST OF ILLUSTRATIONS

FIGURE	PAGE
1. Remove the Terminal Cover	5
2. Voltage Conversion Chart	6
3. Dial Stringing	7
4. Front Panel Adjustment and Component Locations	7
5. Main Chassis Component Locations (Top View)	8
6. Rear Panel Adjustment and Component Locations	8
7. Main Chassis Component Locations (Bottom View)	9
8. FM Front End Assembly P100 Component Locations	10
9. FM IF Amplifier Assembly P200 Component Locations	10
10. FM Detector P500 Component Locations	11
11. MPX Stereo Decoding Amplifier P300 Component Locations	11
12. Muting Control Amplifier Assembly P550 Component Locations	12
13. AM Tuner Unit Assembly P150 Component Locations	12
14. Mode Selection Switch Unit Assembly P700 Component Locations	13
15. Pre-Amplifier and Power Supply Assembly P400 Component Locations	13
16. Schematic Diagram	14

the crowning touch of perfection



marantz

MODEL 110 SERVICE MANUAL

This Service Manual is the first revised edition for model 110 (Applied to production serial No. from 1001 to 1550).

Included in this service manual are schematic diagram, individual parts list and P.C. Board-Component Assembly Diagram.

On the circuit description alignment method and repairing hints, refer to the original service manual.

TABLE OF CONTENTS

Parts List	1
Schematic Diagram	3
P.C. Board-Component Assembly Diagram	5

REF. DESIG.	MARANTZ PART NO.	DESCRIPTION
P200	YD2819003 (ZZ2819003)	P. C. Board P. C. Board Assembly
RESISTORS		
R201	RT1015114	Carbon, 150Ω, ±10%, 1/4W
R202	RT1015214	Carbon, 1.5KΩ, ±10%, 1/4W
R203	RT1033214	Carbon, 3.3KΩ, ±10%, 1/4W
R204-R205	RT1010214	Carbon, 1KΩ, ±10%, 1/4W
R206	RT1082114	Carbon, 820Ω, ±10%, 1/4W
R207	RT1015114	Carbon, 150Ω, ±10%, 1/4W
R208	RT1015214	Carbon, 1.5KΩ, ±10%, 1/4W
R209	RT1033214	Carbon, 3.3KΩ, ±10%, 1/4W
R210-R211	RT1010214	Carbon, 1KΩ, ±10%, 1/4W
R212	RT1010414	Carbon, 100KΩ, ±10%, 1/4W
R213-R214	RT1015114	Carbon, 150Ω, ±10%, 1/4W
R215	RT1082114	Carbon, 820Ω, ±10%, 1/4W
R216	RT1015114	Carbon, 150Ω, ±10%, 1/4W
R217	RT1015214	Carbon, 1.5KΩ, ±10%, 1/4W
R218	RT1033214	Carbon, 3.3KΩ, ±10%, 1/4W
R219-R220	RT1010214	Carbon, 1KΩ, ±10%, 1/4W
R221	RT1010414	Carbon, 100KΩ, ±10%, 1/4W
R222	RT1015114	Carbon, 150Ω, ±10%, 1/4W
R223	RT1022114	Carbon, 220Ω, ±10%, 1/4W
R224	RT1082114	Carbon, 820Ω, ±10%, 1/4W
R225	RT1015114	Carbon, 150Ω, ±10%, 1/4W
R226	RT1082214	Carbon, 8.2KΩ, ±10%, 1/4W
R227	RT1015314	Carbon, 15KΩ, ±10%, 1/4W
R228-R229	RT1010214	Carbon, 1KΩ, ±10%, 1/4W
R230	RT1027114	Carbon, 270Ω, ±10%, 1/4W
R231	RT1010414	Carbon, 100KΩ, ±10%, 1/4W
R232	RT1082214	Carbon, 8.2KΩ, ±10%, 1/4W
R233	RT1015314	Carbon, 15KΩ, ±10%, 1/4W
R234	RT1015114	Carbon, 150Ω, ±10%, 1/4W
R235-R236	RT1010214	Carbon, 1KΩ, ±10%, 1/4W
R237	RT1015114	Carbon, 150Ω, ±10%, 1/4W
R238	RT1010414	Carbon, 100KΩ, ±10%, 1/4W
R239	RT1015114	Carbon, 150Ω, ±10%, 1/4W
R240	RT1047114	Carbon, 470Ω, ±10%, 1/4W
R241	RT1010114	Carbon, 100Ω, ±10%, 1/4W
R242	RT1047214	Carbon, 4.7KΩ, ±10%, 1/4W
R243	RT1012314	Carbon, 12KΩ, ±10%, 1/4W
R244	RT1010214	Carbon, 1KΩ, ±10%, 1/4W
R245	RT1022214	Carbon, 2.2KΩ, ±10%, 1/4W
R246	RT1033314	Carbon, 33KΩ, ±10%, 1/4W
R247	RT1056314	Carbon, 56KΩ, ±10%, 1/4W
R248	RT1027314	Carbon, 27KΩ, ±10%, 1/4W
R249-R252	RT1010114	Carbon, 100Ω, ±10%, 1/4W
R253	RT1022014	Carbon, 22Ω, ±10%, 1/4W
CAPACITORS		
C201-C207	DK1710301	Ceramic, 0.01μF, ±20%
C208	DK1710201	Ceramic, 0.001μF, ±20%

REF. DESIG.	MARANTZ PART NO.	DESCRIPTION
C209-C212	DK1710301	Ceramic, 0.01μF, ±20%
C213	DK1810402	Ceramic, 0.1μF, +80%, -20%
C214-C217	DK1710301	Ceramic, 0.01μF, ±20%
C218	DK1810402	Ceramic, 0.1μF, +80%, -20%
C219-C225	DK1840302	Ceramic, 0.04μF, +80%, -20%
C226	DD1540001	Ceramic, 40pF, ±5%
SEMICONDUCTORS		
H201-H206	HT308291C	Transistor, 2SC829C
H207-H214	HD2001105	Diode, 1S1555
H215-H228	HD1000105	Diode, 1N60
MISCELLANEOUS		
L201	LC1682002	Choke Coil, 6.8μH±20% 100mA
F201-F206	FF1107003	Ceramic Filter, SFA 10.7MHz
J201-J208	YP1000094	Plug
P500	YD2819005 (ZZ2819005)	P. C. Board P. C. Board Assembly
RESISTORS		
R501	RT1015114	Carbon, 150Ω, ±10%, 1/4W
R502	RT1010214	Carbon, 1KΩ, ±10%, 1/4W
R503	RT1010114	Carbon, 100Ω, ±10%, 1/4W
R504	RT1022314	Carbon, 22KΩ, ±10%, 1/4W
R505	RT1022114	Carbon, 220Ω, ±10%, 1/4W
R506-R507	RT0582114	Carbon, 820Ω, ±5%, 1/4W
R508-R509	RT0568214	Carbon, 6.8KΩ, ±5%, 1/4W
R510	RT1010114	Carbon, 100Ω, ±10%, 1/4W
R511	RT1056214	Carbon, 5.6KΩ, ±10%, 1/4W
R512	RT1015314	Carbon, 15KΩ, ±10%, 1/4W
R513	RN1018414	Carbon, 180KΩ, ±10%, 1/4W
R514	RN1022214	Carbon, 2.2KΩ, ±10%, 1/4W
R515	RN1010414	Carbon, 100KΩ, ±10%, 1/4W
R516	RT1010114	Carbon, 100Ω, ±10%, 1/4W
R517	RT1010114	Carbon, 100Ω, ±10%, 1/4W
R518	RT1039214	Carbon, 3.9KΩ, ±10%, 1/4W
CAPACITORS		
C501-C502	DK1710301	Ceramic, 0.01μF, ±20%, YY
C503	EA1060169	Elect., 10μF, 16V
C504	DK1710301	Ceramic, 0.01μF, ±20%, YY
C505	DK1840302	Ceramic, 0.04μF, +100%, -0%
C506-C507	DD1620101	Elect., 200pF, ±10%, SL
C508	EA1060169	Elect., 10μF, 16V
C509	EA1070061	Elect., 100μF, 6.3V
C510	ED1050501	Elect., 1μF, 50V
C511	EA1060169	Elect., 10μF, 16V
C512	DK1840302	Ceramic, 0.04μF, +100%, -0%
C513	DD1620101	Ceramic, 200pF, ±10%
C514	EA1070161	Elect., 100μF, 16V

REF. DESIG.	MARANTZ PART NO.	DESCRIPTION
H501	HC1000105	SEMICONDUCTORS
H502	HT306441B	IC TA7060P
H503-H504	HD1000105	Transistor, 2SC644S Diode 1N60
J501-J506	YP1000094	MISCELLANEOUS
J508-J509	YP1000094	Plug
L501	LI1018801	IFT FM Det.
P550	YD2820006 (ZZ2818006)	P. C. Board P. C. Board Assembly
R551	RT1056214	RESISTORS
R552	RT1010114	Carbon, 5.6K Ω , $\pm 10\%$, 1/4W
R553	RT1027314	Carbon, 100 Ω , $\pm 10\%$, 1/4W
R554	RT1027314	Carbon, 27K Ω , $\pm 10\%$, 1/4W
R555	RT1010414	Carbon, 100K Ω , $\pm 10\%$, 1/4W
R556-R557	RT1010214	Carbon, 1K Ω , $\pm 10\%$, 1/4W
R559	RT1033314	Carbon, 33K Ω , $\pm 10\%$, 1/4W
R560	RT1033314	Carbon, 33K Ω , $\pm 10\%$, 1/4W
R561	RT1033214	Carbon, 3.3K Ω , $\pm 10\%$, 1/4W
R562	RT1056214	Carbon, 5.6K Ω , $\pm 10\%$, 1/4W
R563-R564	RT1018414	Carbon, 180K Ω , $\pm 10\%$, 1/4W
R578	RT1010114	Carbon, 100 Ω , $\pm 10\%$, 1/4W
R578	RT1010114	Carbon, 100 Ω , $\pm 10\%$, 1/4W
C551	DD1615001	CAPACITORS
C552	DF1668301	Ceramic, 15pF, $\pm 10\%$, SL
C553	DF1740301	Mylar, 0.068 μ F, $\pm 10\%$
C554	EA1060162	Mylar, 0.04 μ F, $\pm 20\%$
C555	EA1060162	Elect., 10 μ F, 16V
C556	DK1840302	Ceramic, 0.04 μ F, +100%, -0%
C558	DK1810402	Ceramic, 0.1 μ F, +80%, -20%
C559	DK1810402	Ceramic, 0.1 μ F, +80%, -20%
C560-C561	EA1060162	Elect., 10 μ F, 16V
C562	DK1710301	Ceramic, 0.01 μ F, $\pm 20\%$
C562	DK1840302	Ceramic, 0.04 μ F, +80%, -20%
H551	HT307331C	SEMICONDUCTORS
H552-H553	HT3037210	Transistor, 2SC733 Gr
H554-H555	HD1000105	Transistor, 2SC372 Diode, 1N60
L551	LC2105001	MISCELLANEOUS
J551-J561	YP1000094	Choke Coil, 1mH Plug

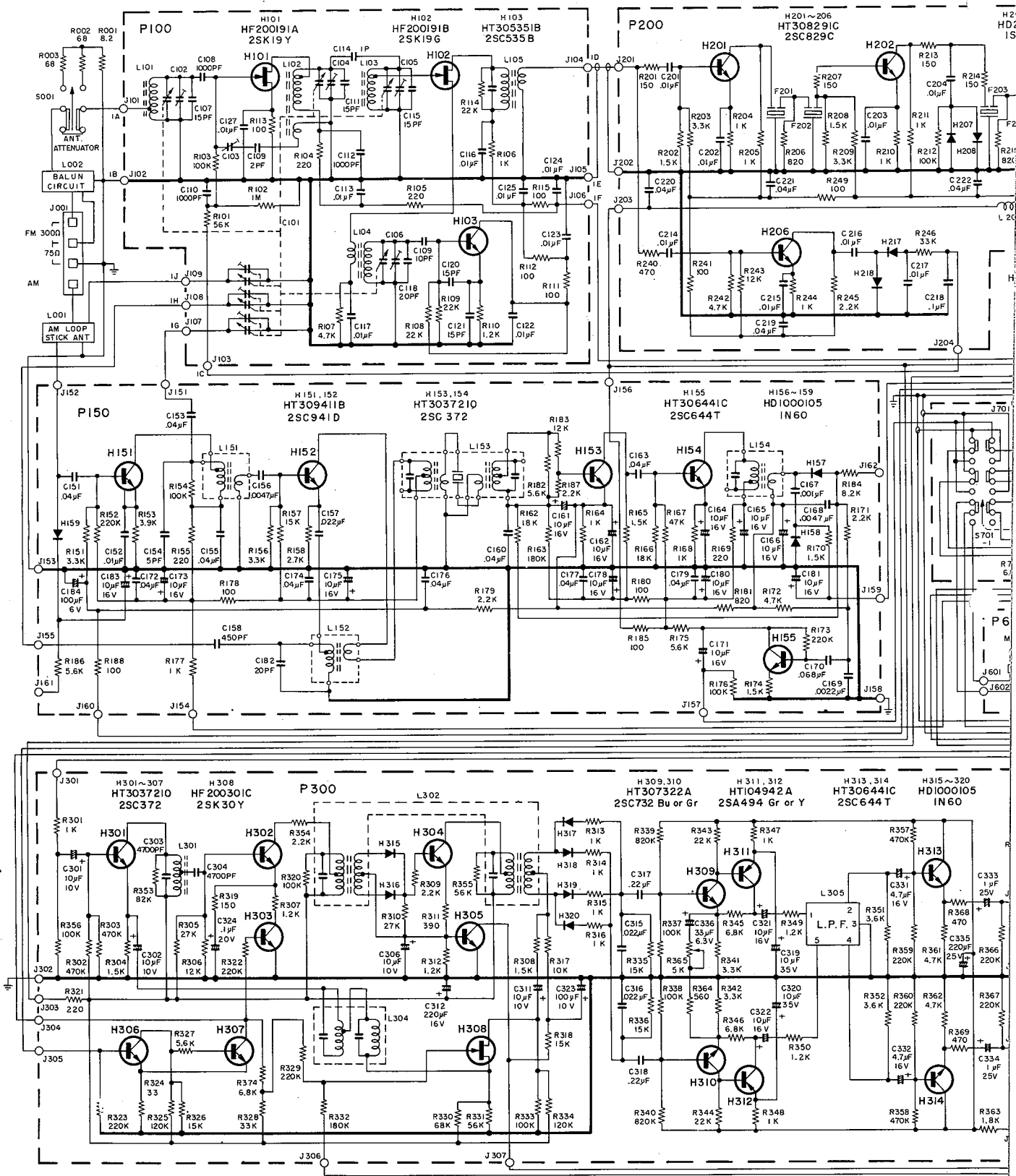

Applied to production Serial No. from 1001 to 1550.

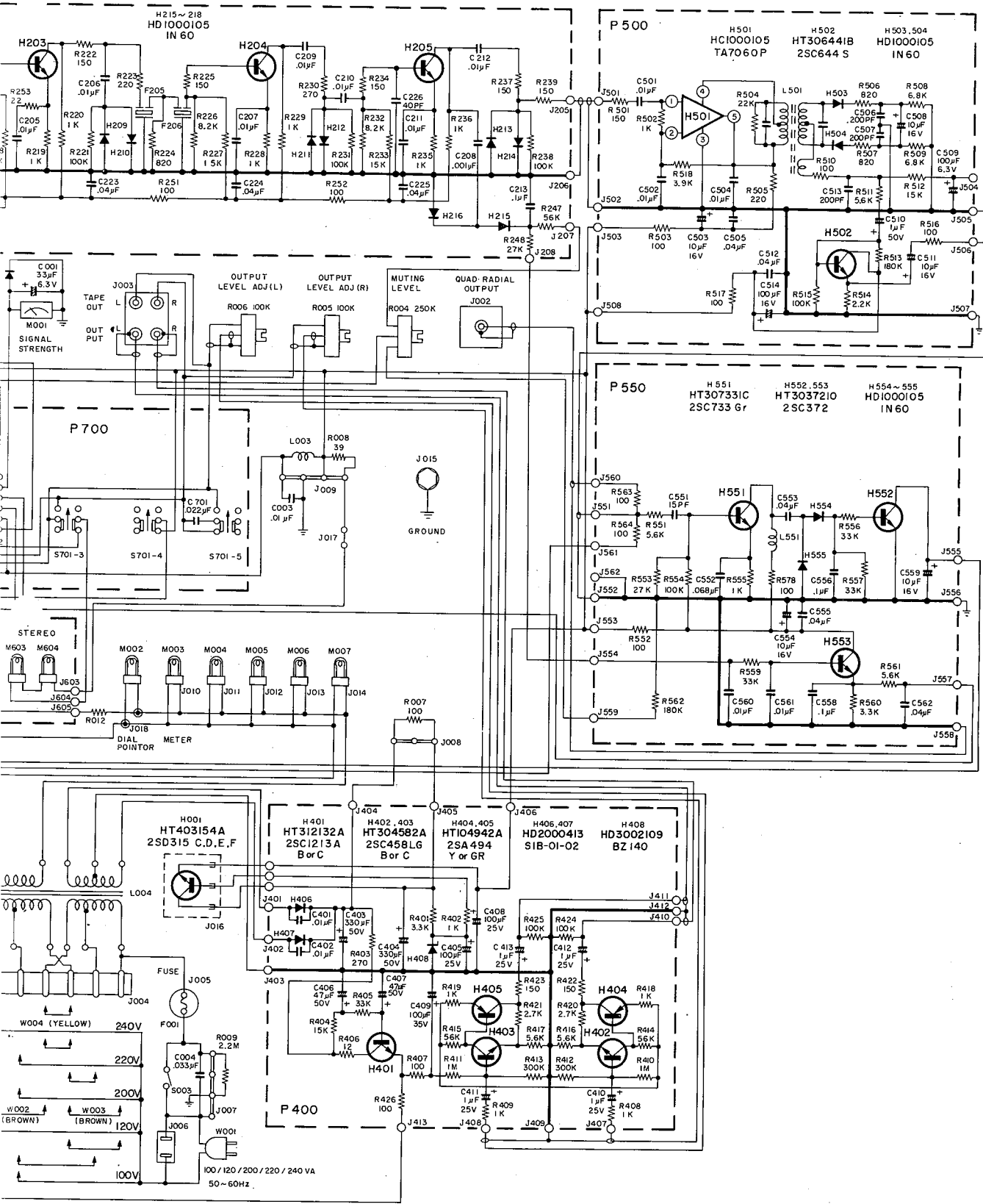

Figure 1. Schematic Diagram

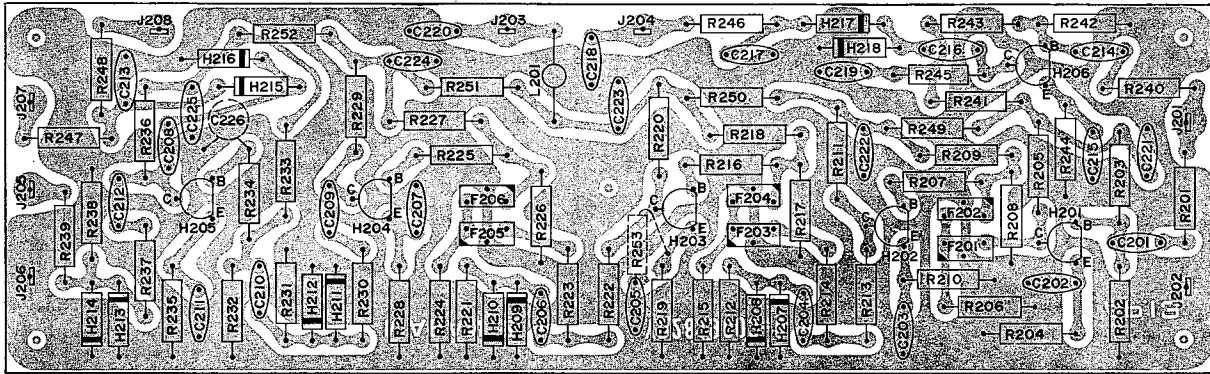

Figure 2. FM IF Amplifier Assembly P200 Component Locations

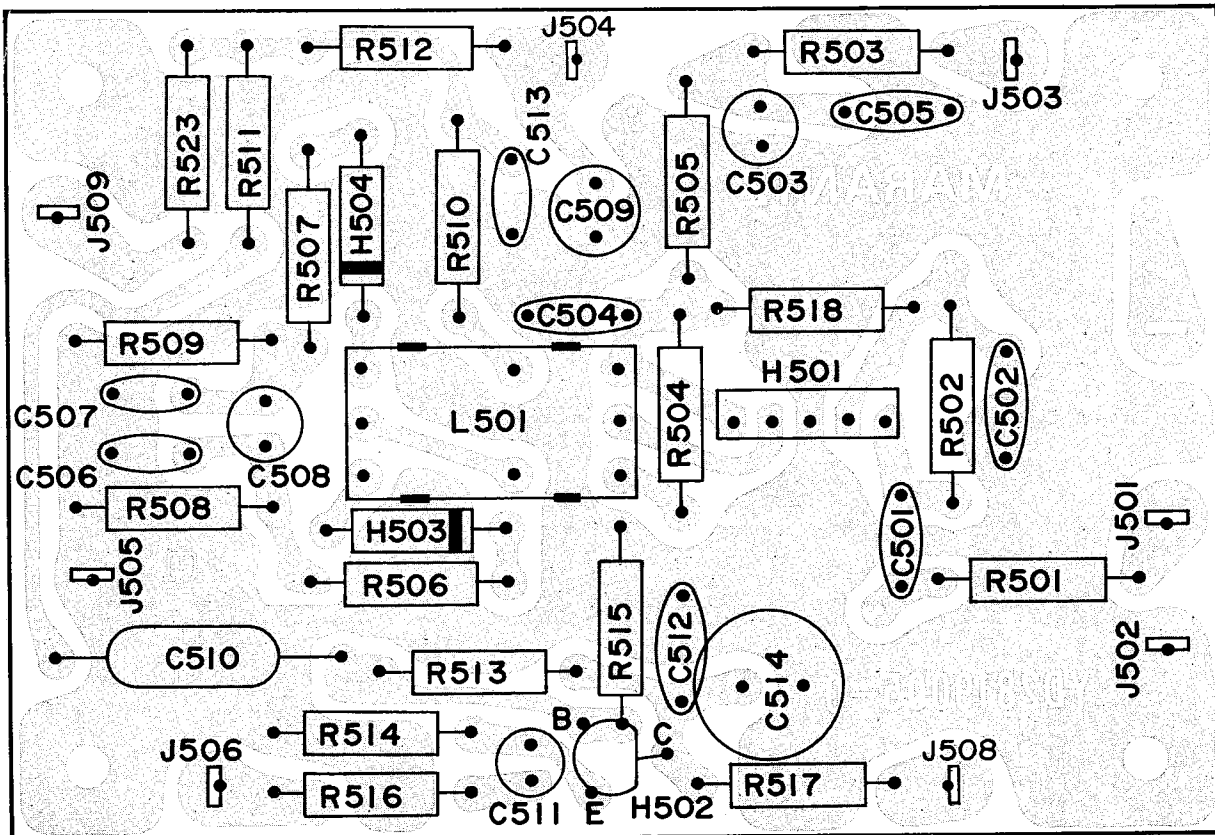

Figure 3. FM Detector Assembly P500 Component Locations

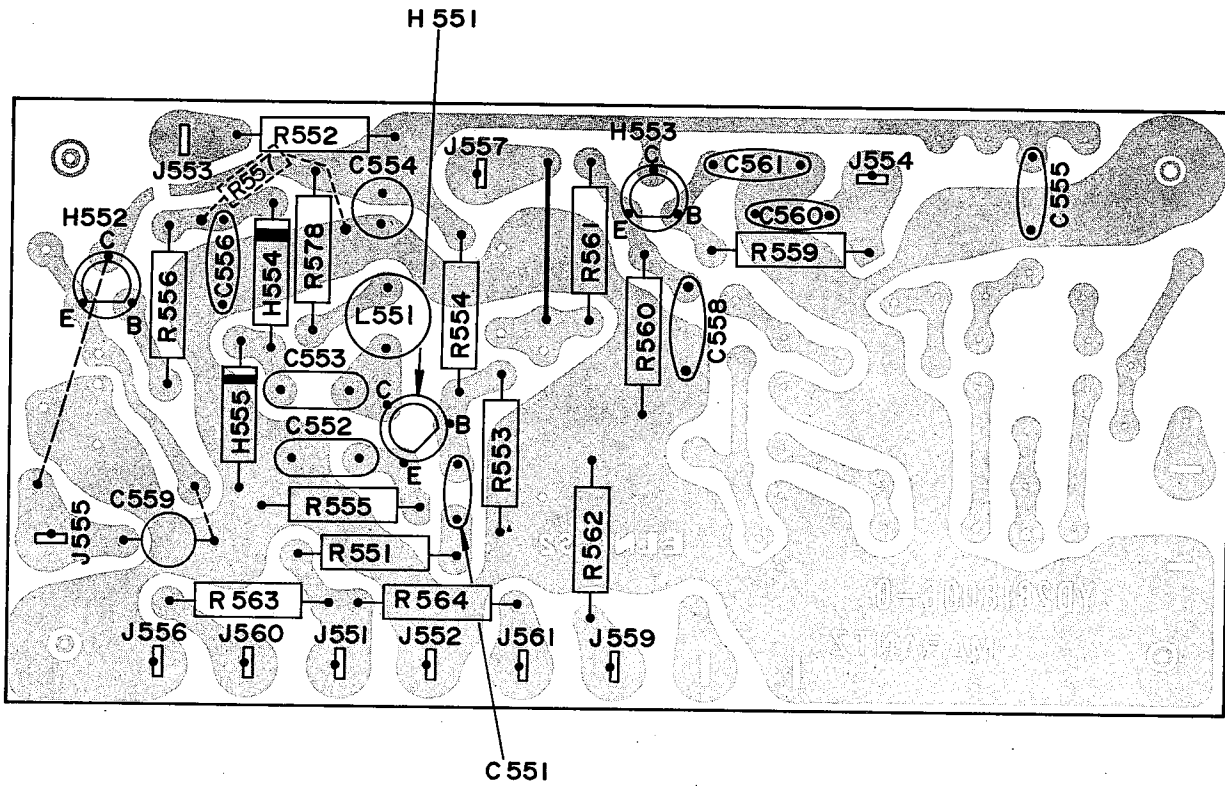

Figure 4. Muting Control Amplifier Assembly P550 Component Locations

1. INTRODUCTION

This service manual was prepared for use by Authorized Warranty Stations and contains service information for Marantz Model 110 Stereophonic Tuner.

Service information and voltage data included in this manual are intended for use by the knowledgeable and experienced technician only. All instruction should be read carefully. No attempt should be made to proceed without a good understanding of the operation in the receiver.

The part lists furnish information by which replacement part may be ordered from the Marantz Company. A simple description is included for parts which can be usually be obtained through local suppliers.

The Model 110 is a tuner version of the Marantz's Model 2245 Tuner/Amplifier and almost the same circuitry as used in the Model 2245 is employed except the audio Amplifier, and power supply circuit.

2. AM Tuner

All components except Tuning capacitor and ferrite bar antenna are mounted on a printed circuit board P150.

The AM signals induced in a ferrite bar antenna are applied to the base of RF amplifier transistor H151 through a capacitor of C151 and amplified to the level required for overcoming the conversion noises, thus giving good S/N performance. The tuned circuits inserted in both out-and in-put circuit of the RF amplifier assure very high image and spurious rejection performance. Thus amplified and selected AM signals are then applied to the base of converter transistor H152 through a coupling capacitor C156. While the local oscillator voltage is injected to the emitter of H152 through a capacitor C157. Both AM signals and oscillating voltage are mixed at the base-emitter junction and converted into 455KHz intermediate frequency. The resulting IF signal is applied to the first IF transformer L153 consisting of one ceramic filter and two tuned circuits.

The output of L153 is led to the transistor H153 which in turn apply its output to the transistor of next stage H154. The fully amplified IF output is then applied to the diode H157 to detect audible signal through the detector transformer L154. The detected audio signal is filtered and amplified and the final audio output is obtained from the collector of H155 and applied: to the tape out jacks and the function switch.

The DC component of the detected IF signal is used as a AGC voltage to control emitter current of H153 which in turn control the bias current of the RF amplifier through the resistor R179 and R151. A part of IF signal output is also applied to the diode H158 through a capacitor C167 and rectified to obtain DC current for energizing the AM signal strength meter M001.

2.1 Suggestions for AM Tuner trouble shooting

Check for broken AM bar antenna, next try to tune station by rotating fly-wheel tuning knob slowly and observe the AM signal strength meter whether it deflects or not. If the signal strength meter gives a deflection at several frequencies received, no failure may exist in the stages at least preceding final IF transformer L154. Next connect a oscilloscope to the pin terminal J162 or J157 and check for audio signals with the tuning meter deflected. If the signal strength meter does not deflect, check the local oscillator circuit. Normal oscillating voltage at the hot end of the oscillator tuning capacitor is about 2 or 3 volts, varying with tuning capacitor position. When measuring oscillating voltage use a RF VTVM, no circuit tester gives correct indication. If the local oscillator voltage is normal, check all voltage distribution in the AM circuits by using a DC VTVM and compare the measured values with those given in the schematic diagram.

3. FM Tuner

The FM Tuner section of Model 110 is divided into five functional blocks: FM Front End, IF Amplifier, Detector, Muting Control and MPX Stereo Decoding Circuit.

FM signals induced by a FM antenna are led to FM antenna coil L101 through an attenuator switch and a Balun coil. These signals are then applied to the FET RF amplifier which in turn applies its output to the next FET Mixer H102 through the double tuned high selective circuits. The FET Mixer convert its input signal into 10.7 MHz intermediate frequency and amplifies it at the same time. The H103 is a local oscillator and its output is injected into the source of the FET Mixer, the injection voltage is about 700mV. The 10.7 MHz front end output is led to the next IF amplifier unit through a coaxial cable.

The IF amplifier unit consists of five stages of IF amplifier and one stage of AGC amplifier. Six pieces of ceramic filters are also used to obtain high selectivity, four stages of symmetrical diode limiters are also employed for the best limiting characteristics, improved capture ratio and good AM suppression.

A part of FM Front End output is applied to the AGC amplifier H206 and rectified its output is fed back to the gate of FET RF amplifier to decrease the gain with increased signal strength.

The IF signal sufficiently amplified through every stage of IF amplifier is finally applied to the IC limiter on the Detector Unit. The detected audio output is led to the buffer amplifier H502 and its buffered output is led to; (a) noise amplifier H551 through resistor R551 and capacitor C551, (b) Quad Radial Jack on the rear panel through resistor R564, (c) MPX stereo decoding circuit through R563.

3.1 Audio Muting and Stereo mode auto-selecting circuit

The muting circuit consisting of all solid-state electrical switching has been incorporated in the Model 110. Two inputs control the muting function. The first is related to signal strength, the second to the noise condition at the detector. These inputs are properly matrixed and gated to provide muting free from noise and transients.

The first input of DC voltage obtained by rectifying a part of IF output signal from the H205 is applied to the base of H306 and turns on it, if the IF output is greater than predetermined level (muting threshold level). When the H306 is turned on the H307 is turned off, allowing the emitter-collector resistance increasing and the collector voltage rises about 9.0V. The increased collector voltage increases the gate bias voltage and turns on the switching FET H308, decreasing the source-drain resistance to near zero ohm and allowing the audio signal applied to the source to flow to the center of 38 KHz switching transformer through the source-drain path.

When the input signal is lower than predetermined level, the DC output obtained is small and can not turn on the H306, thus the H306 keeps its turn-off state and this makes H307 turn on, decreasing the collector voltage and turning off H308. Thus no audio signals can pass through the FET. This is the fundamental principle of the muting operation but for more elaborate muting operation the second input is necessary.

The second input is used to protect the muting operation and MPX stereo beacon lamps from misoperation due to undesirable noises. The high frequency noises included in the detected audio signals are separated by a small capacitor C551 and amplified by the noise amplifier transistor H551 and its output is rectified by the two diodes. The rectified DC output is proportional to the noise components in the audio signals.

When there are excessive noises in the audio signals such as obtained with a station incorrectly tuned in, the rectified DC output turns on the transistor H522, decreasing the emitter-collector resistance to zero. This means the collector of H307 is short-circuited to the ground, therefore the H308 is turned off and any audio signals having excessive high frequency noises can not go through the FET's source-drain path.

The transistor H303 connected in series with the 19 KHz pilot signal amplifier transistor H302 is also turned off and no current flows in the H302, resulting in turning off the stereo beacon lamps. Thus misoperation due to undesirable noises is also avoided.

3.2 MPX Stereo Decoding Circuit

The buffered and non-equalized audio signals are applied to the first amplifier H301 which serve as a tuned amplifier for the pilot signal in the composite signals and as a buffer amplifier for the audio signals. The amplified 19 KHz pilot signal is led to the second 19 KHz amplifier H302 and further amplified if switching transistor H303 is turned on by the controlling DC signal as described in the preceding chapter. The final 19KHz pilot signal is rectified by the doubler circuit consisting of the H315 and H316 to obtain synchronized 38 KHz amplifier driving signal.

The H304 is the 38 KHz tuned amplifier and supplies its output to the switching matrix circuit consisting of four diodes. While the composite signals are applied to the center tap of switching transformer 1/2 L302. The right and left stereo signals decoded by the switching circuit are led to the crosstalk cancelling amplifier which utilizes complementary configuration with NPN and PNP transistors through de-emphasis network consisting of C315 and 335, and C316 and R336. L305 is a low-pass filter networks having very sharp cut off characteristics and eliminates undesirable residual switching signals. Transistors H313 and H314 are buffer amplifiers and their outputs are led to the function switch.

3.3 Suggestion for Trouble Shooting of FM Tuner

3.3.1 Symptom: No. FM Reception

First turn on the Power switch and try to tune FM stations. Rotate the fly-wheel tuning knob slowly and observe the FM signal strength meter. If the signal strength meter deflect at several frequencies received, the tuner circuits preceding the discriminator circuit may have no failure. When no reading is obtained in the meter, check FM local oscillator circuit, using a RF VTVM. The normal local oscillator voltage is one or two volts (rms) at the tuning capacitor, depending on the tuning capacitor position. If the local oscillator voltage is normal, next check all voltage distribution in the FM Front End and IF amplifier unit and compare them with those shown in the circuit diagram. When signal strength meter deflects but no sound is obtained, check audio circuits, using high sensitive oscilloscope.

3.3.2 Symptom: No Stereo Separation

First check the "MONO" switch is in normal out position. Connect a FM RF signal generator output modulated by a stereo modulator to the rear FM antenna terminals, and check the stereo beacon is turned on or not. If not turned on, check for 19 KHz pilot signal and 38 KHz switching signal, using an oscilloscope.

4. AM Alignment Procedure

4.1 AM IF Alignment

1. Connect a sweep generator to the J151 and an alignment scope to the J162.
2. Rotate each core of IF transformer L153 and L154 for maximum height and flat top symmetrical response.

4.2 AM Frequency Range and Tracking Alignment

1. Set AM signal generator to 525 KHz. Turn the tuning capacitor fully closed (place the tuning pointer at the low end.) and adjust the oscillator coil L152 for maximum audio output.
2. Set the signal generator to 1650 KHz. Place the tuning pointer in the high frequency end and adjust the oscillator trimmer on the oscillator tuning capacitor for maximum audio output.
3. Repeat the step 1 and 2 until no further adjustment is necessary.
4. Set the generator to 600 KHz and tune the receiver to the same frequency and adjust a slug core of AM ferrite rod antenna and RF coil L151 for maximum output.
5. Set the generator to 1400 KHz and tune the receiver to the same frequency and adjust both trimming capacitors of Antenna and RF tuned circuit for maximum output.
6. Repeat the step 4 and 5 until no further adjustment is necessary.

Note: During tracking alignment reduce the signal generator output as necessary to avoid AGC action.

5. FM Alignment Procedure

1. Connect a FM signal generator to the FM antenna terminals and a oscilloscope and an audio distortion analyzer to the tape output jacks on the rear panel.
2. Set the FM SG to 87.5 MHz and provide about 3 to 5 μV . Place the tuning pointer at the low frequency end by rotating the tuning knob and adjust the core of oscillator coil L104 to obtain maximum audio output.
3. Set the FM SG to 108.5 MHz and provide about 3 to 5 μV output. Rotate the tuning knob and place the tuning pointer at the high frequency end and adjust the trimming capacitor C106 for Maximum output.
4. Repeat the step 2 and 3 until no further adjustment is necessary.
5. Set the FM SG to 90 MHz and tune the receiver to the same frequency. Decrease signal generator output until the audio output level decreases with the decreasing generator output. Adjust the antenna coil L101, RF coil L102 and L103 and IF transformer L105 for minimum audio distortion.
6. Set the FM SG to 106 MHz and tune the receiver to the same frequency. Adjust the trimming capacitor C102, C104 and C105 for minimum distortion.
7. Adjust the secondary core (black) of discriminator transformer L501 so that the center tuning meter pointer indicates its center at no signal applied. Set the FM SG to 98 MHz and increase its output level to 1 $\text{K}\mu\text{V}$ and tune the receiver to the same frequency so that the center tuning meter pointer indicates its center. Adjust the primary core (pink) of L501 for minimum distortion.

5.1 STEREO Separation Alignment

1. Set the FM SG to provide 1 $\text{K}\mu\text{V}$ at 98 MHz. Tune the receiver to the same frequency so that the center tuning meter pointer indicates its center.
2. Modulate the FM SG with stereo composite signal consisting of only subchannel signal (of course a pilot signal must be included). Adjust the core of L301 for maximum audio output, then, modulate the signal generator with a stereo composite signal consisting of only L channel signal and again adjust the core of L301 for maximum audio output.
3. Adjust the trimming resistor R365 for maximum and same separation in both channels.

5.2 Muting Circuit Alignment

1. Connect a VTVM across the resistor R002 and adjust the resistor R022 until the meter reads 0.75V DC at no signal.
2. Set the FM SG to provide 1 $\text{K}\mu\text{V}$ at 98 MHz and tune the receiver to the same frequency correctly.
3. Turn on MUTING push-switch. Shift the FM signal generator frequency to plus and minus and note both plus and minus shifted frequencies at which undesirable audio side responses are muted out. Adjust the R022 so that the same shifted frequencies mute the undesirable side response.

6. Test Equipment Required for Servicing

Table 1 lists the test equipment required for servicing the Model 110 Tuner.

Item	Manufacturer and Model No.	Use
AM Signal Generator		Signal source for AM alignment
Test Loop		Used with AM Signal generator
FM Signal Generator	Less than 0.3% distortion	Signal source for FM alignment
Stereo Modulator	Less than 0.3% distortion	Stereo separation alignment and trouble shooting
Audio Oscillator	Weston Model CVO-100P, less than 0.02% residual distortion is required.	Sinewave and squarewaves signal source.
Oscilloscope	High sensitivity with DC horizontal and vertical amplifiers.	Waveform analysis and Trouble Shooting, and ASO alignment.
VTVM	With AC, DC, RF range	Voltage measurements.
Circuit Tester		Trouble Shooting

7. Voltage Conversion

This model is equipped with a universal power transformer to permit operation at 100, 120, 200, 220 and 240 V AC 50 to 60 Hz.

To convert the the Model 110 to the required voltage perform the following steps:

- (1) Remove the top cover.
- (2) Remove the Transformer Wire Connection Terminal Cover, loosen two Cover mounting screws on the rear panel, see Fig. 1.
- (3) Change the jumper wires as illustrated in Fig. 2. for the required AC voltage and replace the fuse as instructed.

CAUTION: DISCONNECT POWER SUPPLY CORD FROM AC OUTLET BEFORE CONVERTING VOLTAGE.

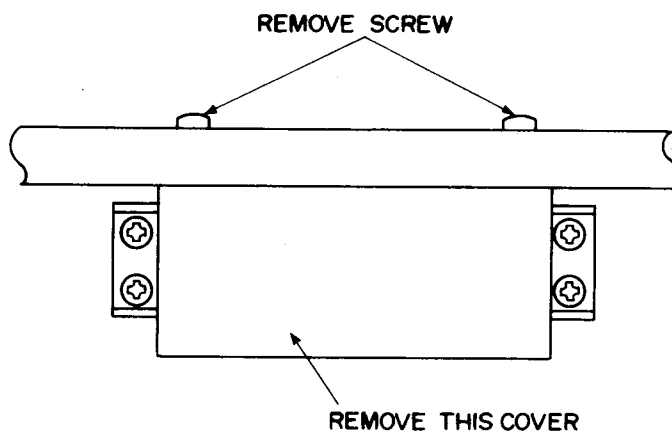
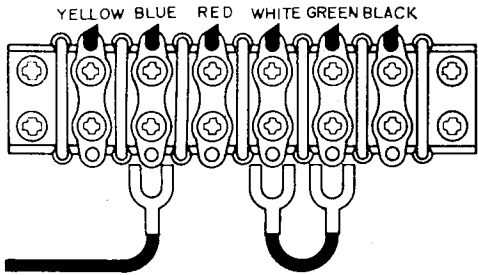
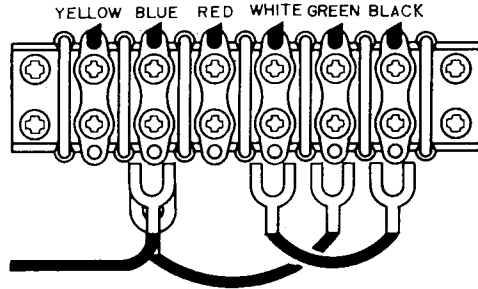

Figure 1. Remove the Terminal Cover

For 200V Operation
(Use 3/10A Fuse)



For 100 V Operation
(Use 0.5A Fuse)



For 220 V Operation
(Use 3/10A Fuse)

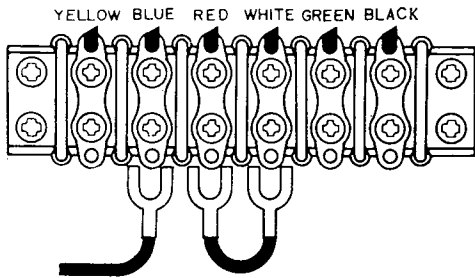

For 120 V Operation
(Use 0.5A Fuse)

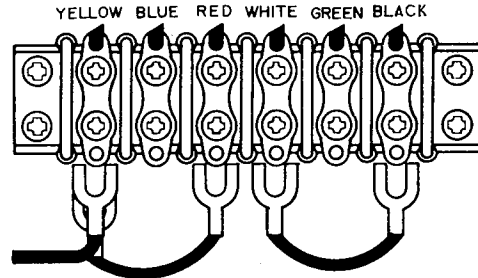

For 240V Operation
(Use 3/10A Fuse)

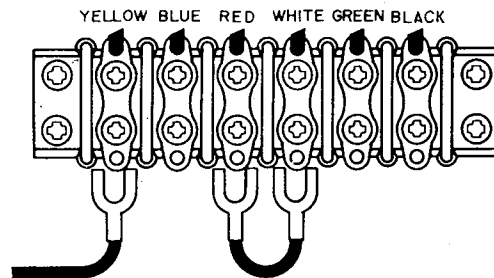

Figure 2. Voltage Conversion Chart

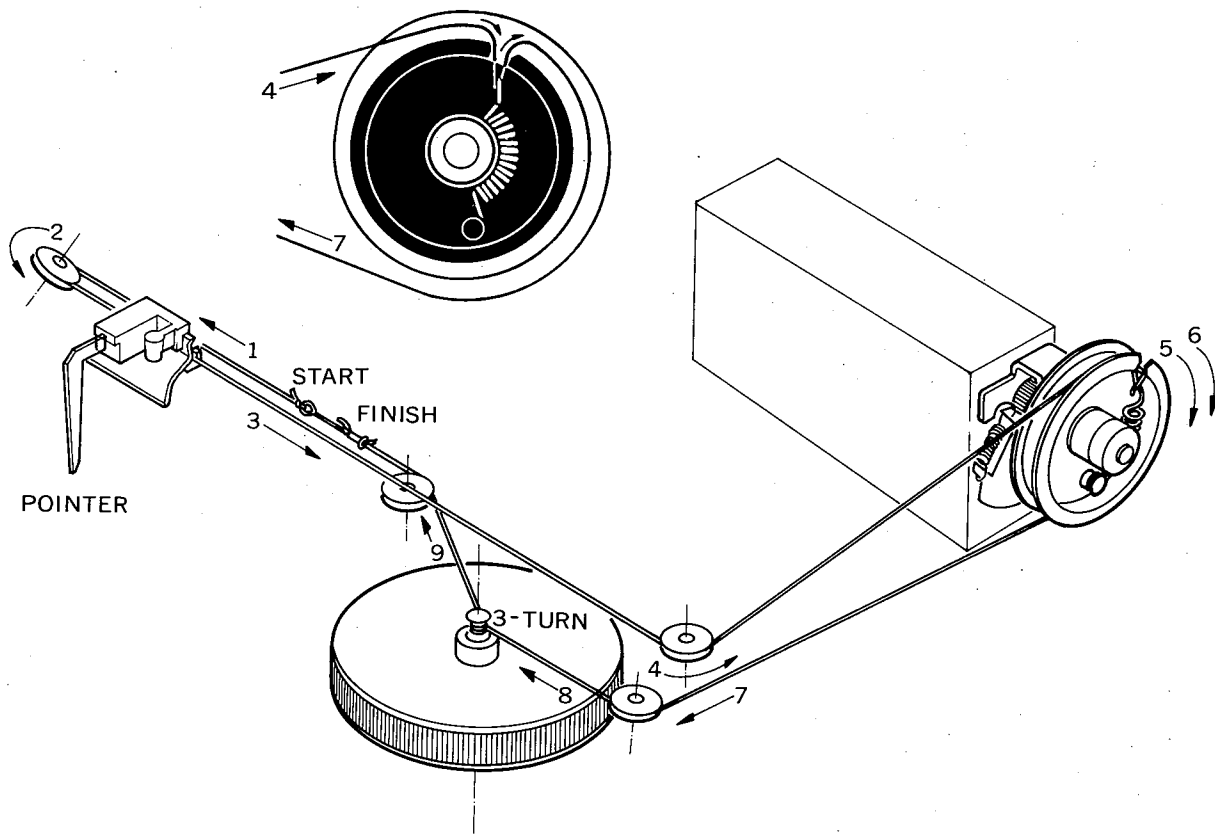

Figure 3. Dial Stringing

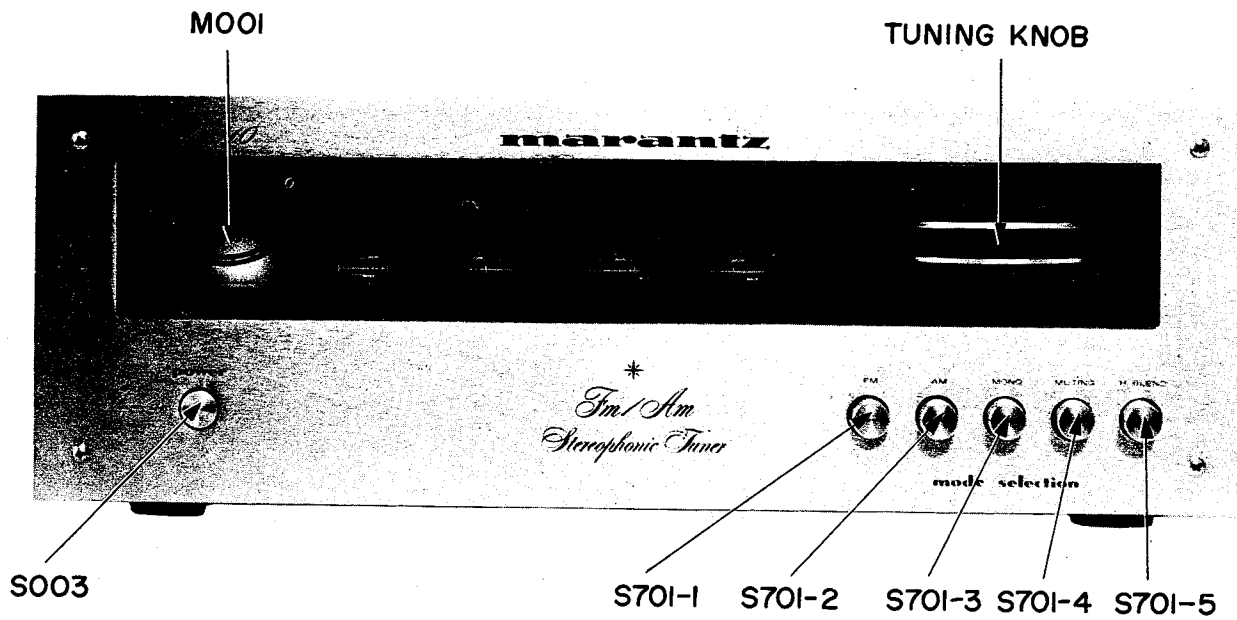

Figure 4. Front Panel Adjustment and Component Locations

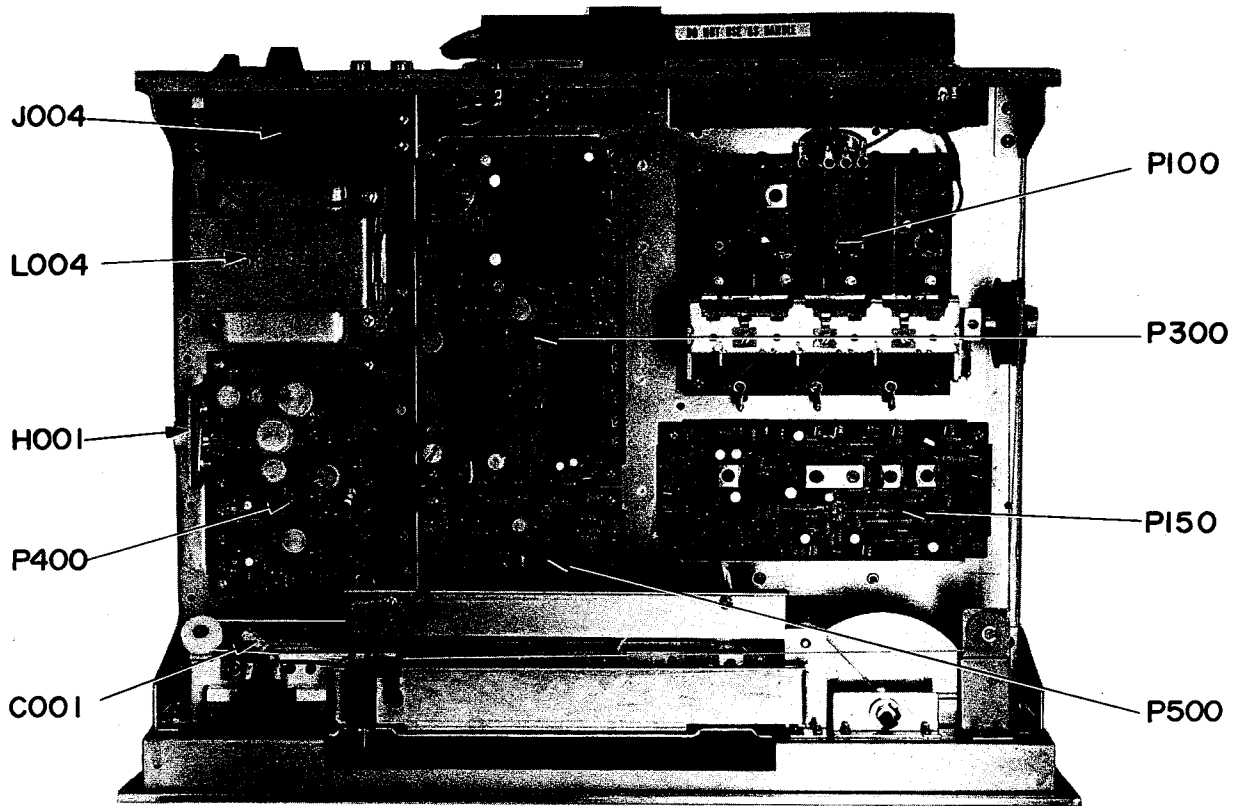

Figure 5. Main Chassis Component Locations (Top View)

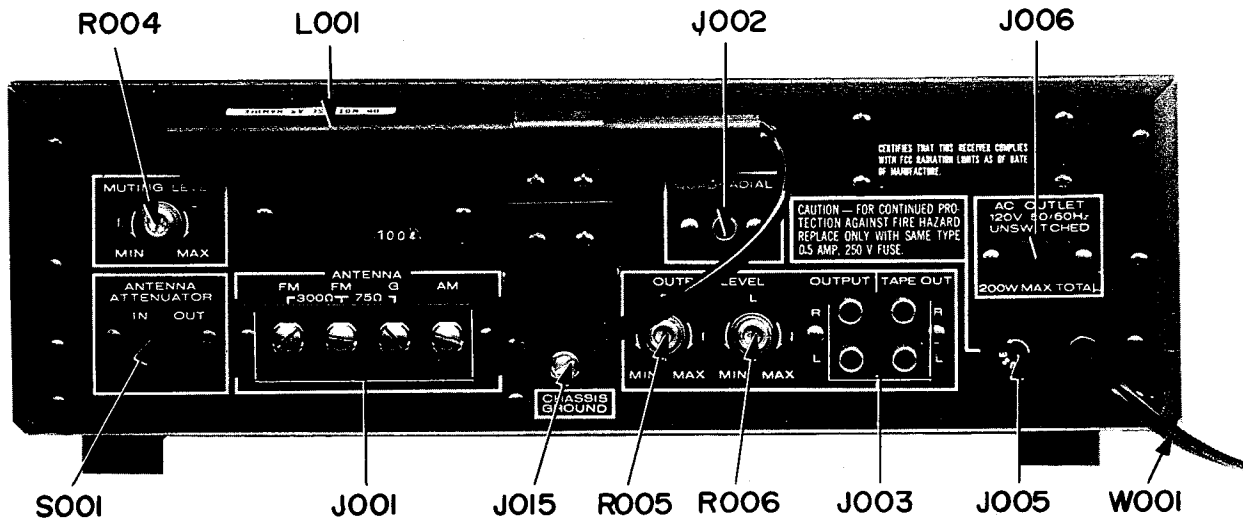

Figure 6. Rear Panel Adjustment and Component Locations

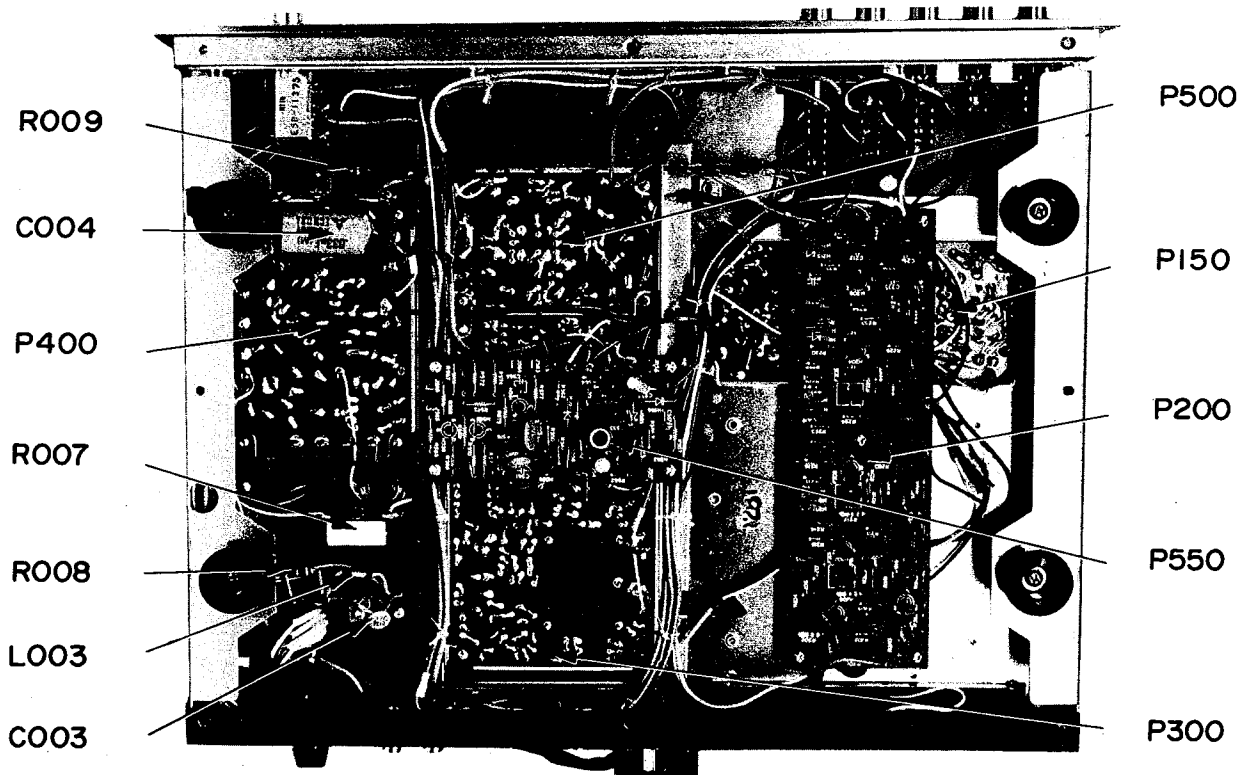

Figure 7. Main Chassis Component Locations (Bottom View)

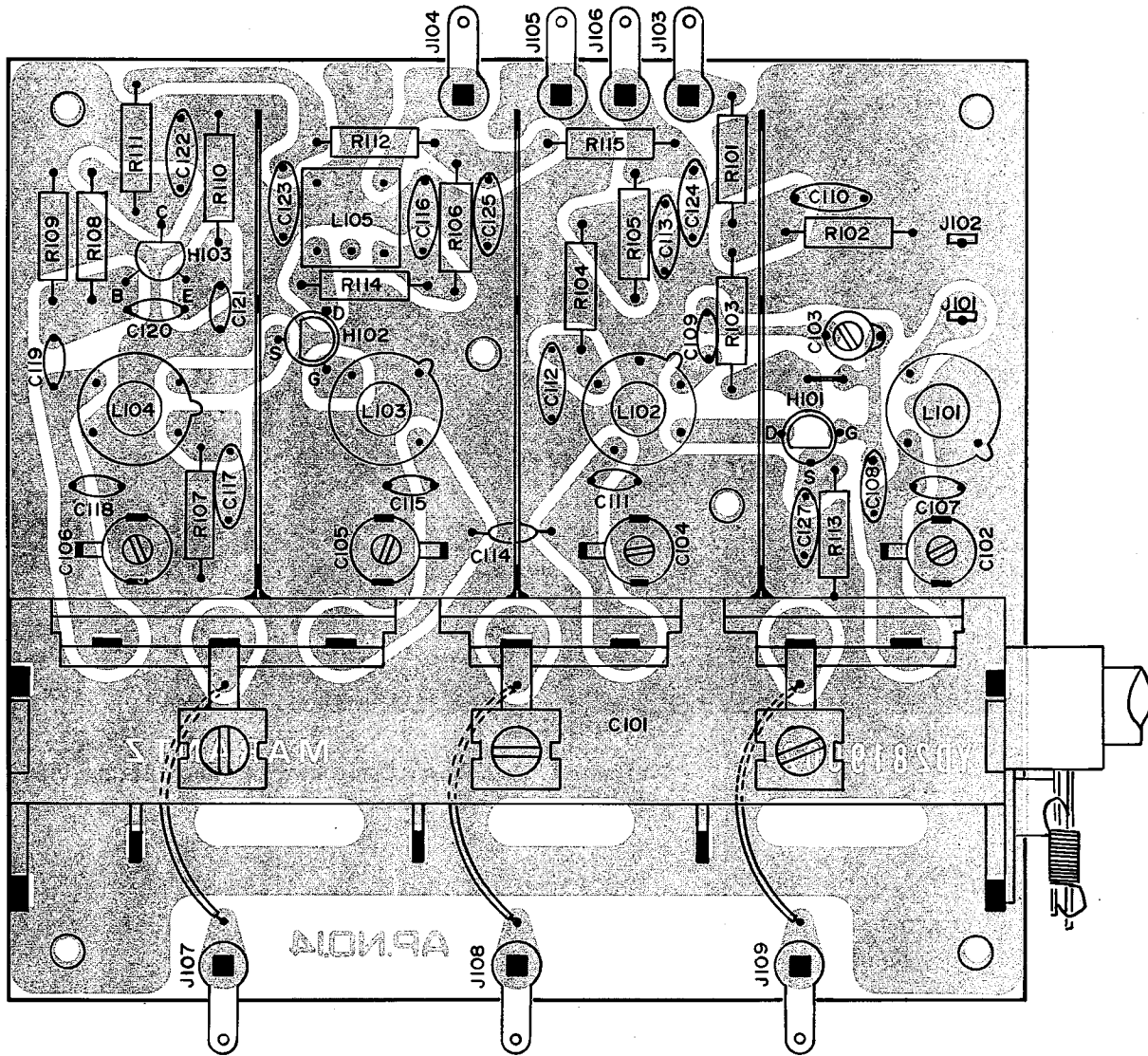

Figure 8. FM Front End Assembly P100 Component Locations

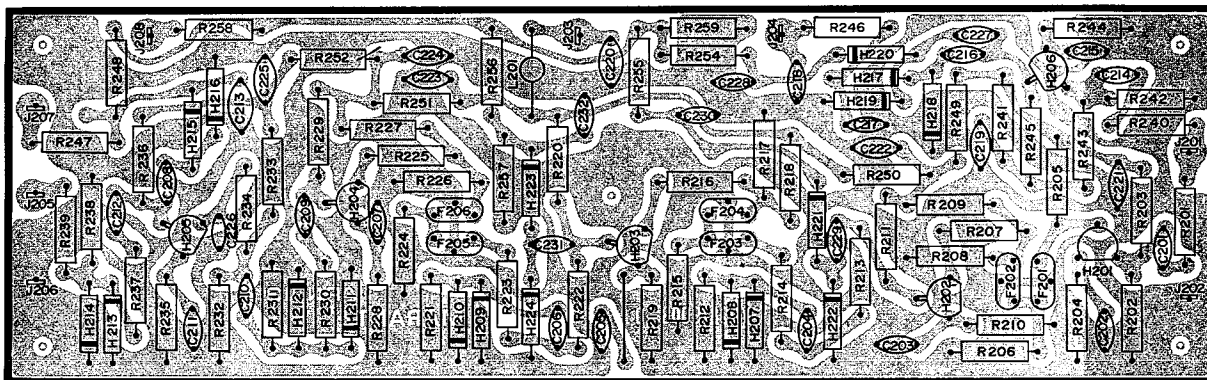

Figure 9. FM IF Amplifier Assembly P200 Component Locations

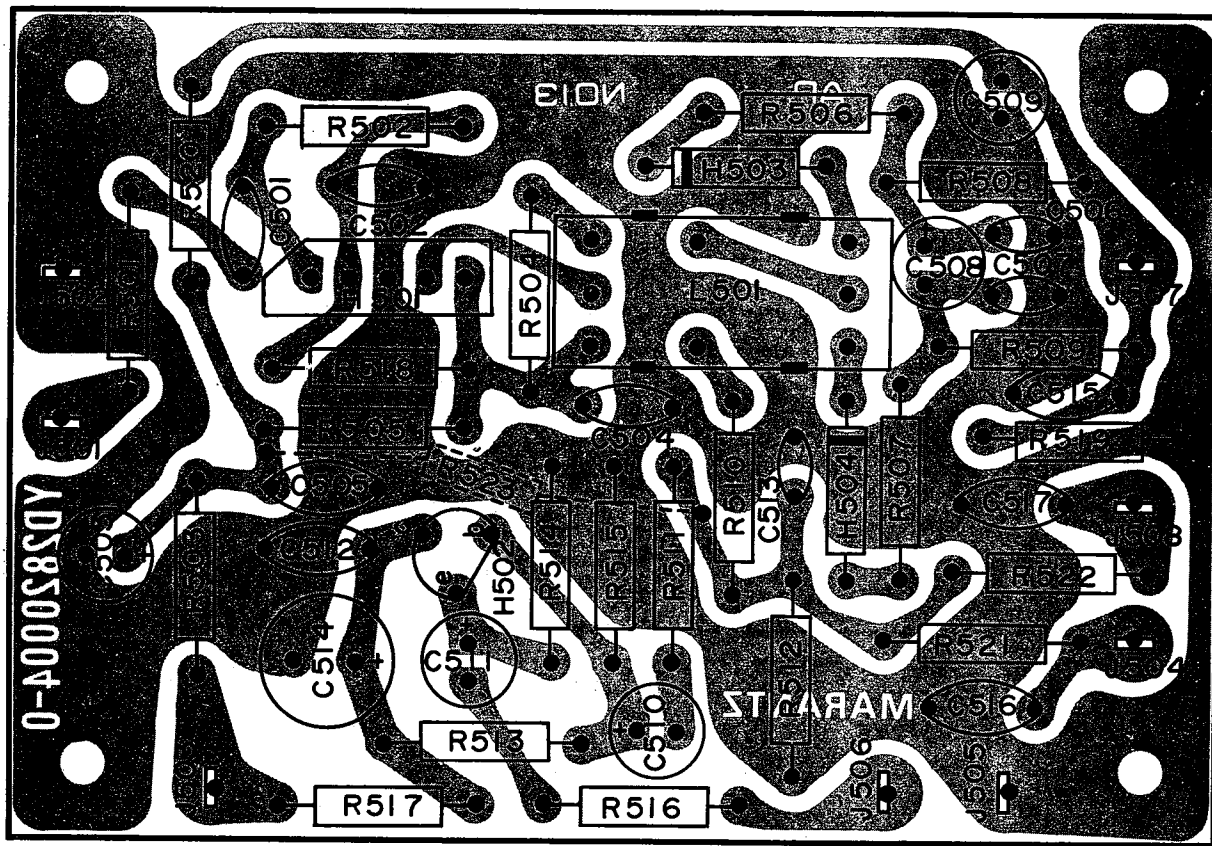

Figure 10. FM Detector P500 Component Locations

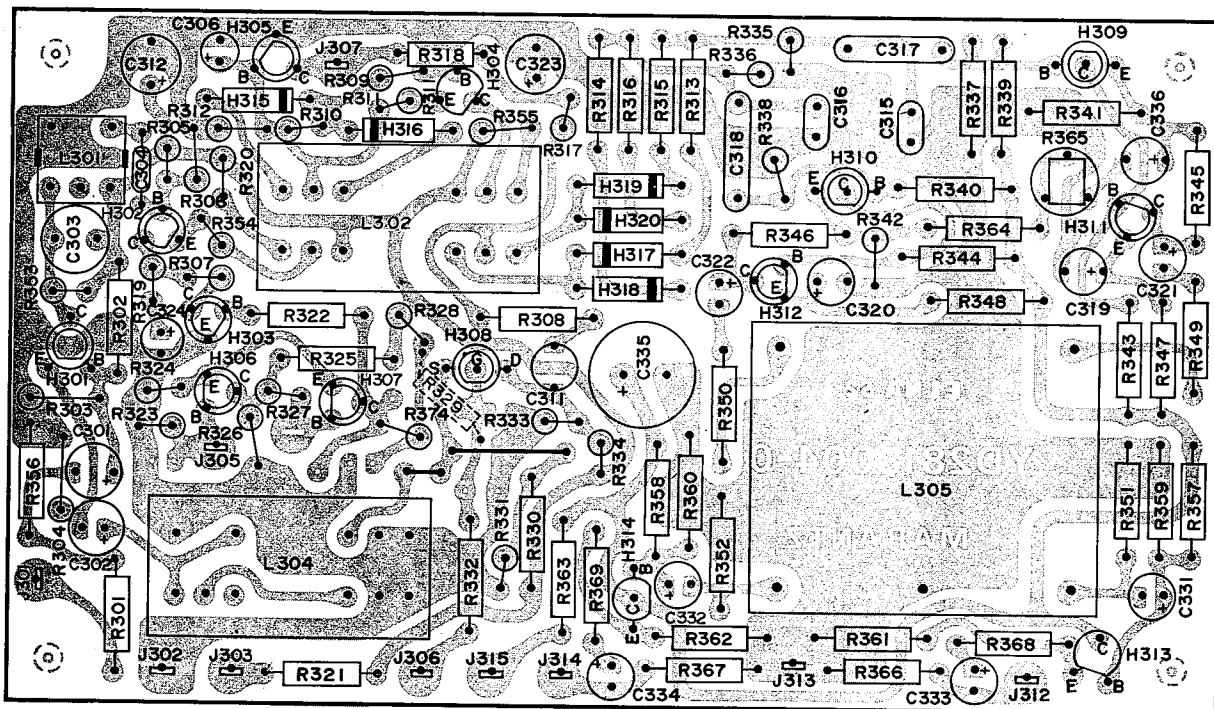

Figure 11. MPX Stereo Decoding Amplifier P300 Component Locations

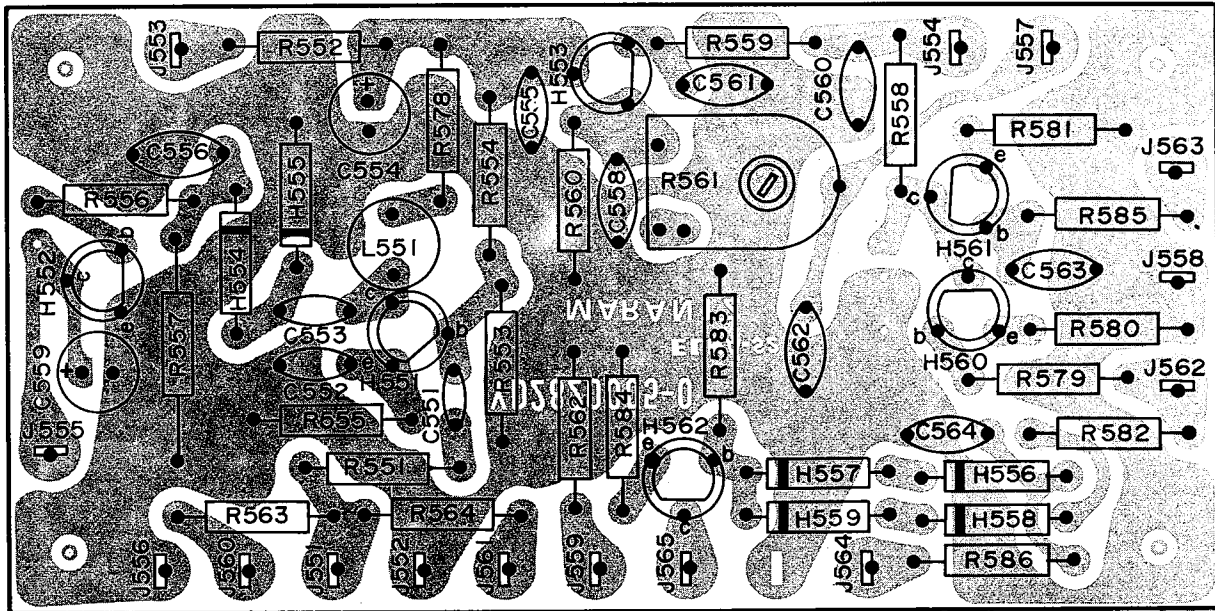

Figure 12. Muting Control Amplifier Assembly P550 Component Locations

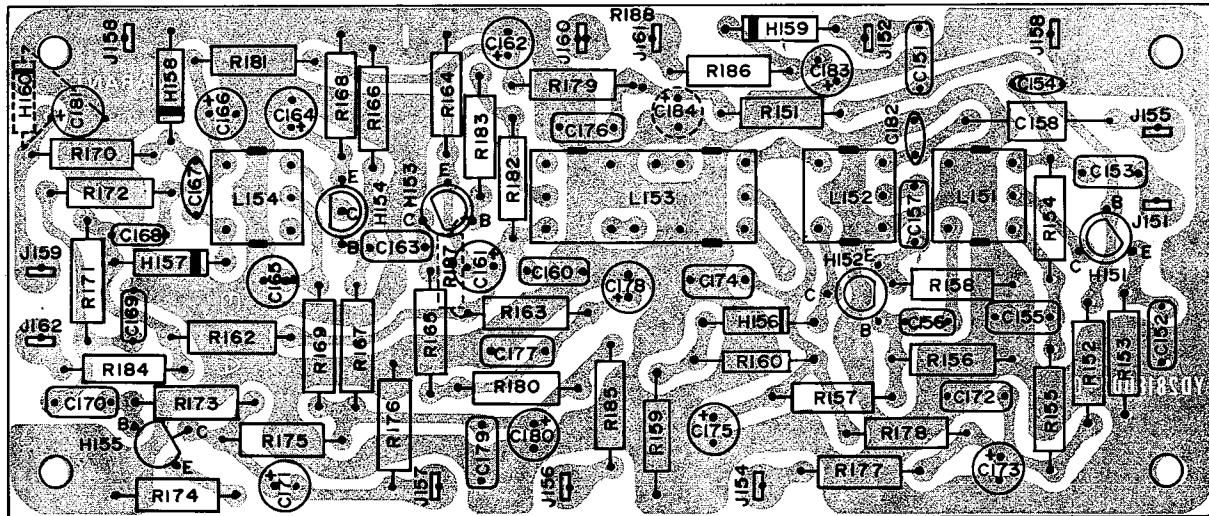

Figure 13. AM Tuner Unit Assembly P150 Component Locations

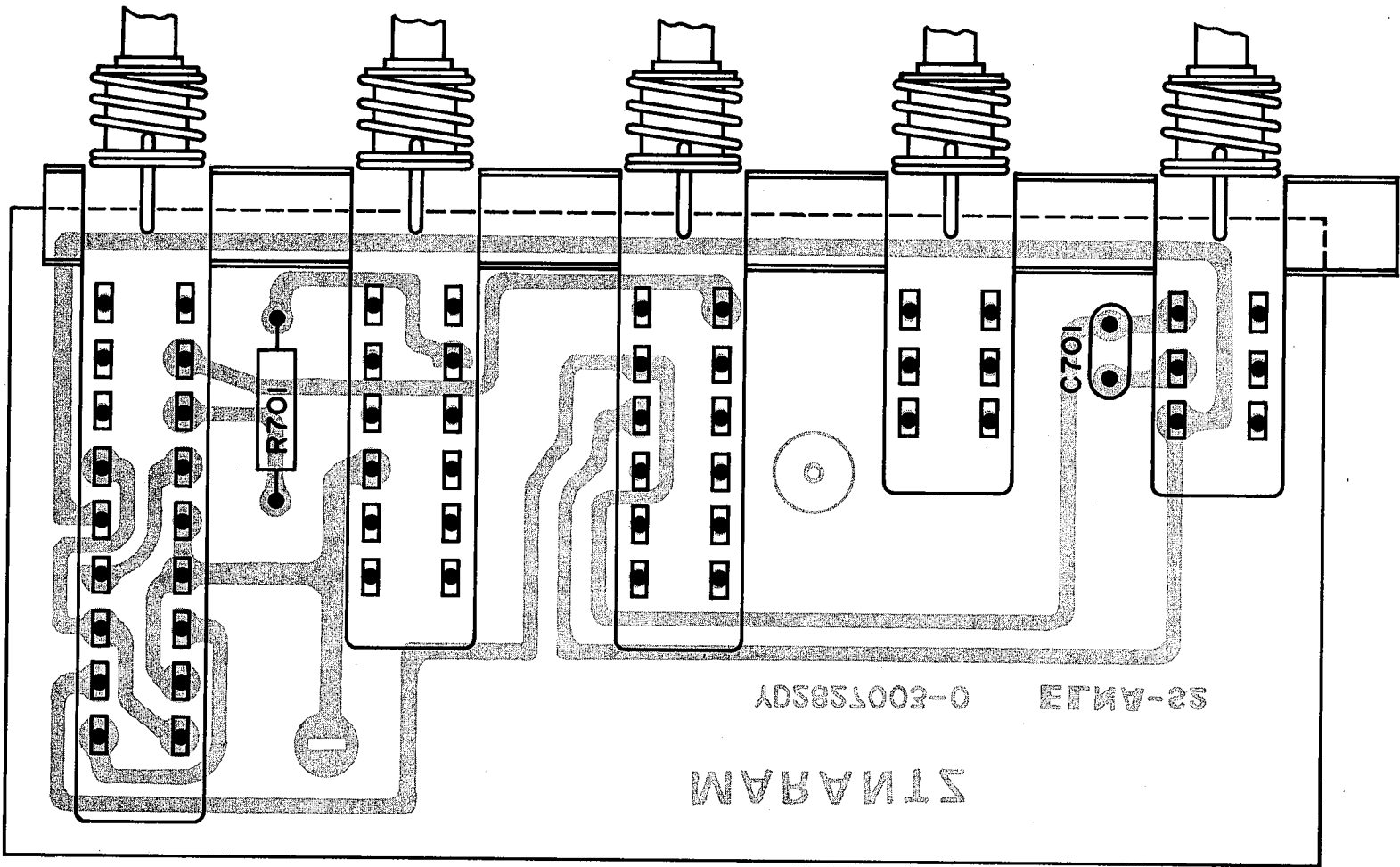

Figure 14. Mode Selection Switch Unit Assembly P700 Component Locations

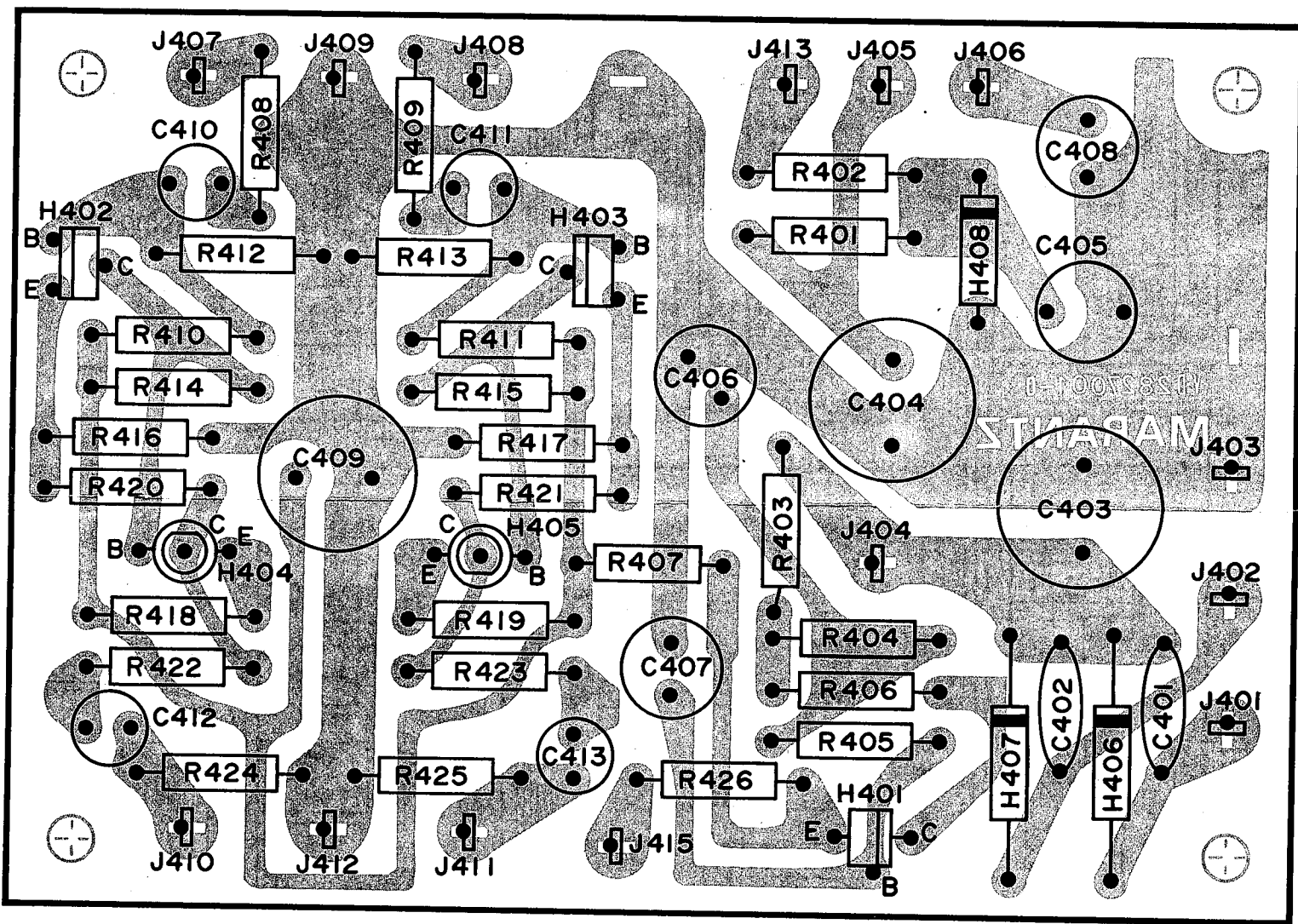

Figure 15. Pre-Amplifier and Power Supply Assembly P400 Component Locations

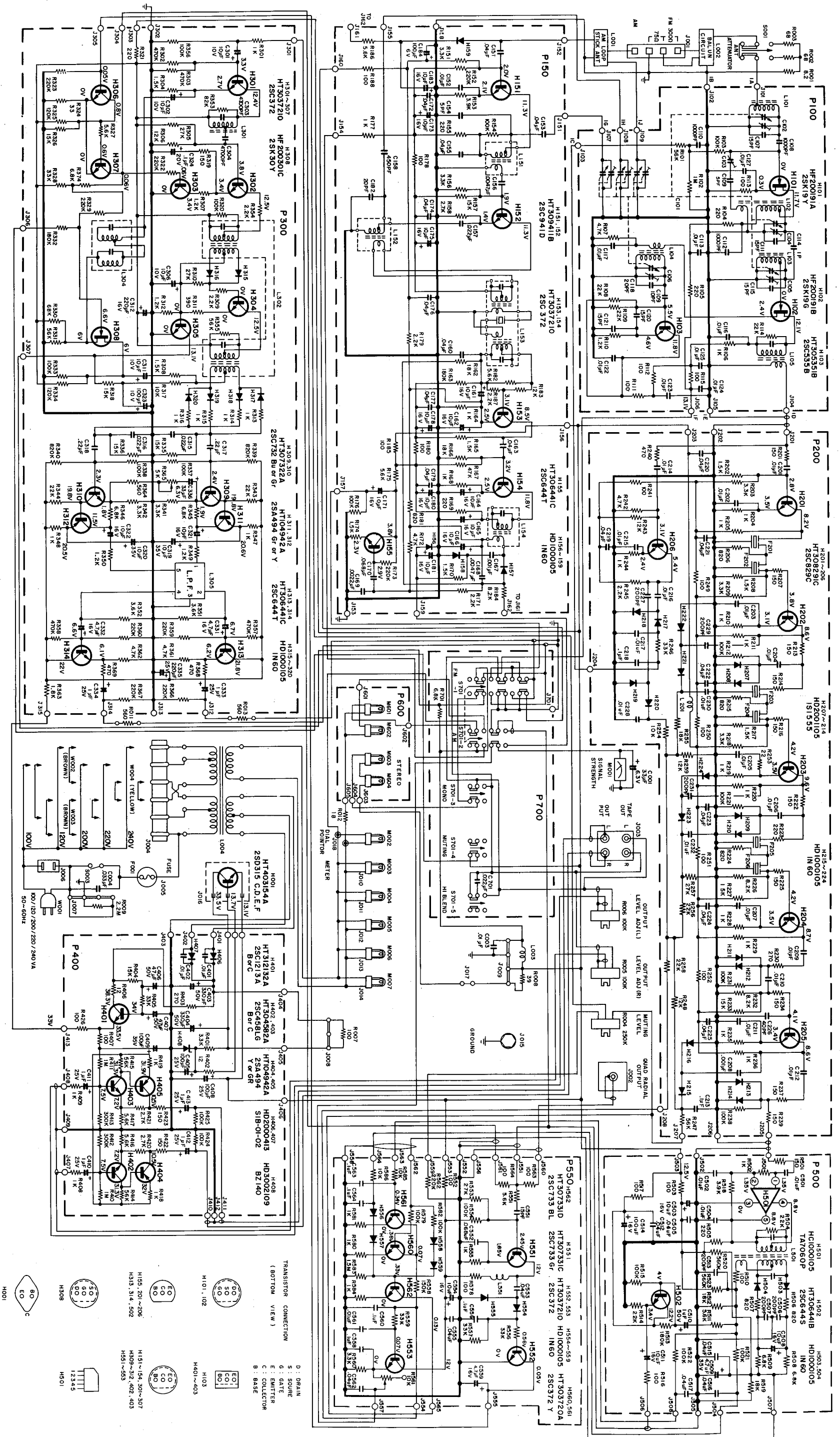

Figure 16. Schematic Diagram

REF. DESIG.	MARANTZ PART NO.	DESCRIPTION
A	282740140	Frame assembly
0101	282706301	Escutcheon
0102	282740101	Frame
0103	282715801	Window
0105	282705301	Cover
0621	51122608E	T H M screw x 4
B	282716040	Rear bracket assembly
0124	282716002	Bracket x 2
0531	51100308S	B H M screw x 2
0532	51100308S	B H M screw x 2
0533	55060307F	T R rivet x 2
0534	54050300R	T L washer OR x 2
J002	YT0201006	Terminal, 1P
J003	YT0204003	Terminal, 4P
J006	YJ0400018	Jack, AC outlet
C	282727340	Fly wheel assembly
0117	257706302	Escutcheon
0118	257706303	Escutcheon
0119	257727301	Fly wheel
0313	282711201	Shaft
0415	53110603A	Hexagon nut
0416	54040602A	Spring washer
D	282710340	Pointer assembly
0113	281810301	Pointer
0114	281810302	Pointer
0115	281805301	Cover
M002	IN1008018	Lamp, 8V
E	282700640	Dial string assembly
0328	120225801	Hook
0329	72081602A	String 160
0435	56382040G	Eyelet
0104	281825905	Bush
0107	281815401	Knob x 5
0109	281815402	Knob
0111	282730201	Dial
0112	282705302	Cover
0121	282725701	Lid
0122	282825702	Lid
0129	282726501	Indicator
0130	257816052	Bracket K
0134	281927103	Holder
0135	53228059E	Nut x 3
0201	145525901	Bush
0202	275905701	Leg x 4
0203	282706302	Escutcheon
0210	280312001	Insulator
0211	282710550	Chassis K x 2
0216	282716004	Bracket x 2
0217	282716005	Bracket x 2
0219	282726901	Protector
0220	282710101	Support x 2

REF. DESIG.	MARANTZ PART NO.	DESCRIPTION
0221	282715901	Drum
0222	71101679M	Spring
0223	281905102	Guide
0225	273010903	Shield x 3
0226	273025901	Bush x 3
0227	138200503	Glamper x 5
0228	257700502	Glamper x 10
0229	281816006	Bracket
0230	282126902	Protector
0231	282716050	Bracket K
0235	282112001	Insulator
0301	282716003	Bracket
0304	282705101	Guide
0306	257710602	Bearing
0307	141511801	Spacer
0309	281810650	Bearing K
0315	282727401	Reflector
0316	281827101	Holder
0318	282716006	Bracket
0319	282716007	Bracket
0320	263711203	Shaft x 2
0322	282716051	Bracket K
0326	257726201	Pulley x 4
0330	257711803	Spacer x 2
0332	282725901	Bush
0333	282711801	Spacer x 4
0334	282710701	Sheet
0335	282710702	Sheet x 2
0401	51570306B	P H tapt screw x 8
0402	51570306B	P H tapt screw x 5
0403	51570306B	P H tapt screw x 8
0404	51570306B	P H tapt screw x 2
0405	51570306B	P H tapt screw x 3
0406	51570306B	P H tapt screw x 2
0407	51570306B	P H tapt screw x 2
0408	51570306B	P H tapt screw x 2
0409	51570306B	P H tapt screw x 2
0410	51570306B	P H tapt screw x 2
0411	51570306B	P H tapt screw x 2
0412	51040306A	F H M screw x 2
0413	51570306B	P H tapt screw x 2
0414	51040306A	F H M screw x 2
0417	51640412D	Set screw CP
0418	54040402A	Spring washer
0419	53110403E	Hexagon nut
0420	54020601A	Flat washer P
0421	51570306B	P H tapt screw x 2
0422	51570306B	P H tapt screw x 4
0423	51570306B	P H tapt screw x 4
0424	51570306B	P H tapt screw x 4
0425	51570306B	P H tapt screw x 4
0426	51570306B	P H tapt screw x 4

REF. DESIG.	MARANTZ PART NO.	DESCRIPTION	REF. DESIG.	MARANTZ PART NO.	DESCRIPTION
0427	51570306B	P H tapt screw x 4	R106	RT1010214	Carbon, 1K Ω , $\pm 10\%$, 1/4W
0428	51570306B	P H tapt screw x 5	R107	RT1047214	Carbon, 4.7K Ω , $\pm 10\%$, 1/4W
0429	51570306B	P H tapt screw x 5	R108-R109	RT1022314	Carbon, 22K Ω , $\pm 10\%$, 1/4W
0430	51570306B	P H tapt screw x 2	R110	RT1012214	Carbon, 1.2K Ω , $\pm 10\%$, 1/4W
0431	51570308B	P H tapt screw x 2	R111-R113	RT1010114	Carbon, 100 Ω , $\pm 10\%$, 1/4W
0432	51060305E	P H M screw x 3	R114	RT1022314	Carbon, 22K Ω , $\pm 10\%$, 1/4W
0433	51650304D	Set screw HP x 2	R115	RT1010114	Carbon, 100 Ω , $\pm 10\%$, 1/4W
0501	51570306B	P H tapt screw x 4			CAPACITORS
0502	51570312B	P H tapt screw x 4	C101	CA4330001	Variable FM4, AM3 Grang
0503	54040402A	Spring washer x 4	C102	CT1100001	Trimmer, 1.5pF~10pF, NPO
			C103	CT1100002	Trimmer, 1.5pF~10pF, NPO
0504	51570408B	P H tapt screw x 4	C104-C106	CT1100001	Trimmer, 1.5pF~10pF, NPO
0506	51100306S	B H M screw x 4	C107	DD1615001	Ceramic, 15pF, $\pm 10\%$, SL
0507	51100306S	B H M screw x 2	C108	DK1710201	Ceramic, 1000pF, $\pm 20\%$, YY
0508	51100306S	B H M screw x 2	C109	DD1105001	Ceramic, 5pF, $\pm 0.5pF$, SL
0509	51100306S	B H M screw x 2	C110	DK1710201	Ceramic, 1000pF, $\pm 20\%$, YY
0510	51100306S	B H M screw x 2	C111	DD1715001	Ceramic, 15pF, $\pm 10\%$, SL
0511	51100306S	B H M screw x 3	C112	DK1710201	Ceramic, 1000pF, $\pm 20\%$, YY
0515	51100304S	B H M screw x 2			
0517	51100308S	B H M screw x 2	C113	DK1710301	Ceramic, 0.01 μF , $\pm 20\%$, YY
0518	54050300R	T L washer OR x 2	C114	DD1001001	Ceramic, 1.0pF, $\pm 0.25pF$, SL
			C115	DD1615001	Ceramic, 15pF, $\pm 10\%$, SL
0519	53110303E	Hexagon nut x 2	C116-C117	DK1710301	Ceramic, 0.01 μF , $\pm 20\%$, YY
0521	53110403E	Hexagon nut	C118	DD1620004	Ceramic, 20pF, $\pm 10\%$, PH
0522	54020401E	Flat washer P	C119	DD1210006	Ceramic, 10pF, $\pm 1pF$, CH
0523	54050400R	T L washer OR	C120	DD1615003	Ceramic, 15pF, $\pm 10\%$, CH
0524	62041760W	Lug	C121	DD1615003	Ceramic, 15pF, $\pm 10\%$, CH
0525	51100310S	B H M screw x 2	C122-C125	DK1710301	Ceramic, 0.01 μF , $\pm 20\%$, YY
0526	53110303E	Hexagon nut x 2	C127	DK1710301	Ceramic, 0.01 μF , $\pm 20\%$, YY
0527	54060300R	T L washer IR x 5			TRANSFORMERS
0535	53110303E	Hexagon nut x 4	L101	LA1202603	Ant. Coil
0612	64002500R	RG Ring E x 2	L102	LA1202604	RF Coil
			L103	LA1202605	RF Coil
0613	51570308B	P H tapt screw	L104	LO1202603	OSC Coil
0614	53110303A	Hexagon nut	L105	LI1001601	IFT
0615	54050300R	T L washer OR x 5			SEMICONDUCTORS
0616	51570306B	P H tapt screw x 3	H101	HF200191A	Transistor 2SK19 Y
0617	51100306S	B H M screw x 2	H102	HF200191B	Transistor 2SK19 G
0618	59030805P	Washer x 4	H103	HT305351B	Transistor 2SC535 B
0619	54040302A	Spring washer x 5			MISCELLANEOUS
0620	59030805P	Washer	J101-J102	YP1000094	Plug
0622	51100406S	B H M screw x 8	J103-J109	57271240W	Lug Eyelet
0624	51100406S	B H M screw x 4			
			P150	YD2818002 (ZZ2818002)	P. C. Board P. C. Board Assembly
0625	54020401S	Flat washer P x 4			RESISTORS
0627	51570410B	P H tapt screw x 4	R151	RT1033214	Carbon, 3.3K Ω , $\pm 10\%$, 1/4W
0628	54020401E	Flat washer P x 4	R152	RT1022414	Carbon, 220K Ω , $\pm 10\%$, 1/4W
0629	54040402N	Spring washer x 4	R153	RT1039214	Carbon, 3.9K Ω , $\pm 10\%$, 1/4W
P100	YD2819002 (ZZ2819002)	P. C. Board P. C. Board Assembly	R154	RT1010414	Carbon, 100K Ω , $\pm 10\%$, 1/4W
		RESISTORS	R155	RT1022114	Carbon, 220 Ω , $\pm 10\%$, 1/4W
R101	RT1056314	Carbon, 56K Ω , $\pm 10\%$, 1/4W	R156	RT1033214	Carbon, 3.3K Ω , $\pm 10\%$, 1/4W
R102	RT1010514	Carbon, 1M Ω , $\pm 10\%$, 1/4W			
R103	RT1010414	Carbon, 100K Ω , $\pm 10\%$, 1/4W			
R104-R105	RT1022114	Carbon, 220 Ω , $\pm 10\%$, 1/4W			

REF. DESIG.	MARANTZ PART NO.	DESCRIPTION			REF. DESIG.	MARANTZ PART NO.	DESCRIPTION		
R157	RT1015314	Carbon, 15K Ω ,	$\pm 10\%$,	1/4W	C175	EA1060169	Elect.,	10 μ F,	16V
R158	RT1027214	Carbon, 2.7K Ω ,	$\pm 10\%$,	1/4W	C176-C177	DF1740301	Mylar,	0.04 μ F,	$\pm 20\%$
R159	RT1082314	Carbon, 82K Ω ,	$\pm 10\%$,	1/4W	C178	EA1060169	Elect.,	10 μ F,	16V
R160	RT1015214	Carbon, 1.5K Ω ,	$\pm 10\%$,	1/4W	C179	DF1740301	Mylar.,	0.04 μ F,	$\pm 20\%$
R162	RT1018314	Carbon, 18K Ω ,	$\pm 10\%$,	1/4W	C180	EA1060169	Elect.,	10 μ F,	16V
R163	RT1018414	Carbon, 180K Ω ,	$\pm 10\%$,	1/4W	C181	EA1060169	Elect.,	10 μ F,	16V
R164	RT1010214	Carbon, 1K Ω ,	$\pm 10\%$,	1/4W	C182	DD1620001	Ceramic,	20pF,	$\pm 10\%$
R165	RT1015214	Carbon, 1.5K Ω ,	$\pm 10\%$,	1/4W	C183	EA1060169	Elect.,	10 μ F,	16V
R166	RT1018314	Carbon, 18K Ω ,	$\pm 10\%$,	1/4W	C184	EA1070109	Elect.,	100 μ F,	10V
R167	RT1047314	Carbon, 47K Ω ,	$\pm 10\%$,	1/4W					
							TRANSFORMERS		
R168	RT1010214	Carbon, 1K Ω ,	$\pm 10\%$,	1/4W	L151	LA1001017	RF Coil,	200 μ H	
R169	RT1022114	Carbon, 220 Ω ,	$\pm 10\%$,	1/4W	L152	LO1001042	OSC Coil,	120 μ H	
R170	RT1015214	Carbon, 1.5K Ω ,	$\pm 10\%$,	1/4W	L153	LI1028002	IFT		
R171	RT1022214	Carbon, 2.2K Ω ,	$\pm 10\%$,	1/4W	L154	LI1001048	IFT		
R172	RT1047214	Carbon, 4.7K Ω ,	$\pm 10\%$,	1/4W	L153	LI1028003	IFT		
R173	RT1022414	Carbon, 220K Ω ,	$\pm 10\%$,	1/4W			MISCELLANEOUS		
R174	RT1015214	Carbon, 1.5K Ω ,	$\pm 10\%$,	1/4W	J151-J162	YP1000094	Plug		
R175	RT1056214	Carbon, 5.6K Ω ,	$\pm 10\%$,	1/4W			SEMICONDUCTORS		
R176	RT1010414	Carbon, 100K Ω ,	$\pm 10\%$,	1/4W	H151-H152	HT309411B	Transistor 2SC941 (O)		
R177	RT1010214	Carbon, 1K Ω ,	$\pm 10\%$,	1/4W	H153-H154	HT3037210	Transistor 2SC372		
					H155	HT306441C	Transistor 2SC644 (T)		
R178	RT1010114	Carbon, 100 Ω ,	$\pm 10\%$,	1/4W	H156-H160	HD1000105	Diode 1N60		
R179	RT1022214	Carbon, 2.2K Ω ,	$\pm 10\%$,	1/4W	P200	YD2819008	P. C. Board		
R180	RT1010114	Carbon, 100 Ω ,	$\pm 10\%$,	1/4W		(ZZ2819008)	P. C. Board Assembly		
R181	RT1082114	Carbon, 820 Ω ,	$\pm 10\%$,	1/4W			RESISTORS		
R182	RT1056214	Carbon, 56K Ω ,	$\pm 10\%$,	1/4W	R201	RT1015114	Carbon, 150 Ω ,	$\pm 10\%$,	1/4W
R183	RT1012314	Carbon, 12K Ω ,	$\pm 10\%$,	1/4W	R202	RT1015214	Carbon, 1.5K Ω ,	$\pm 10\%$,	1/4W
R184	RT1082214	Carbon, 8.2K Ω ,	$\pm 10\%$,	1/4W	R203	RT1033214	Carbon, 3.3K Ω ,	$\pm 10\%$,	1/4W
R185	RT1010114	Carbon, 100 Ω ,	$\pm 10\%$,	1/4W	R204-R205	RT1010214	Carbon, 1K Ω ,	$\pm 10\%$,	1/4W
R186	RT1056214	Carbon, 5.6K Ω ,	$\pm 10\%$,	1/4W	R206	RT1082114	Carbon, 820 Ω ,	$\pm 10\%$,	1/4W
R187	RT1022214	Carbon, 2.2K Ω ,	$\pm 10\%$,	1/4W	R207	RT1015114	Carbon, 150 Ω ,	$\pm 10\%$,	1/4W
					R208	RT1051214	Carbon, 1.5K Ω ,	$\pm 10\%$,	1/4W
R188	RT1010114	Carbon, 100 Ω ,	$\pm 10\%$,	1/4W	R209	RT1033214	Carbon, 3.3K Ω ,	$\pm 10\%$,	1/4W
		CAPACITORS			R210-R211	RT1010214	Carbon, 1K Ω ,	$\pm 10\%$,	1/4W
C151	DF1740301	Mylar, 0.04 μ F,	$\pm 20\%$		R212	RT1010414	Carbon, 100K Ω ,	$\pm 10\%$,	1/4W
C152	DF1710301	Mylar, 0.01 μ F,	$\pm 20\%$						
C153	DF1740301	Mylar, 0.04 μ F,	$\pm 20\%$		R213-R214	RT1015114	Carbon, 150 Ω ,	$\pm 10\%$,	1/4W
C154	DD1105001	Ceramic, 5pF,	± 0.5 pF,		R215	RT1082114	Carbon, 820 Ω ,	$\pm 10\%$,	1/4W
C155	DF1740301	Mylar, 0.04 μ F,	$\pm 20\%$		R216	RT1015114	Carbon, 150 Ω ,	$\pm 10\%$,	1/4W
C156	DF1747201	Mylar, 0.0047 μ F,	$\pm 20\%$		R217	RT1015214	Carbon, 1.5K Ω ,	$\pm 10\%$,	1/4W
C157	DF1722301	Mylar, 0.022 μ F,	$\pm 20\%$		R218	RT1033214	Carbon, 3.3K Ω ,	$\pm 10\%$,	1/4W
C158	DF6545101	Mylar, 450pF,	$\pm 5\%$		R219-R220	RT1010214	Carbon, 1K Ω ,	$\pm 10\%$,	1/4W
C160	DF1740301	Mylar, 0.04 μ F,	$\pm 20\%$		R221	RT1010414	Carbon, 100K Ω ,	$\pm 10\%$,	1/4W
C161-C162	EA1060169	Elect., 10 μ F,	16V		R222	RT1015114	Carbon, 150 Ω ,	$\pm 10\%$,	1/4W
					R223	RT1022114	Carbon, 220 Ω ,	$\pm 10\%$,	1/4W
C163	DF1740301	Mylar, 0.04 μ F,	$\pm 20\%$		R224	RT1082114	Carbon, 820 Ω ,	$\pm 10\%$,	1/4W
C164-C166	EA1060169	Elect., 10 μ F,	16V						
C167	DK1710201	Ceramic, 0.001 μ F,	$\pm 20\%$		R225	RT1015114	Carbon, 150 Ω ,	$\pm 10\%$,	1/4W
C168	DF1747201	Mylar, 0.0047 μ F,	$\pm 20\%$		R226	RT1082214	Carbon, 8.2K Ω ,	$\pm 10\%$,	1/4W
C169	DF1722201	Mylar, 0.0022 μ F,	$\pm 20\%$		R227	RT1015314	Carbon, 15K Ω ,	$\pm 10\%$,	1/4W
C170	DF1668301	Mylar, 0.068 μ F,	$\pm 10\%$		R228-R229	RT1010214	Carbon, 1K Ω ,	$\pm 10\%$,	1/4W
C171	EA1060169	Elect., 10 μ F,	16V		R230	RT1027114	Carbon, 270 Ω ,	$\pm 10\%$,	1/4W
C172	DF1740301	Mylar, 0.04 μ F,	$\pm 20\%$						
C173	EA1060169	Elect., 10 μ F,	16V						
C174	DF1740301	Mylar, 0.04 μ F,	$\pm 20\%$						

REF. DESIG.	MARANTZ PART NO.	DESCRIPTION	REF. DESIG.	MARANTZ PART NO.	DESCRIPTION
R231	RT1010414	Carbon, 100KΩ, ±10%, 1/4W	R301	RT1010214	RESISTORS
R232	RT1082214	Carbon, 8.2KΩ, ±10%, 1/4W	R302-R303	RN1047414	Carbon, 470KΩ, ±10%, 1/4W
R233	RT1015314	Carbon, 15KΩ, ±10%, 1/4W	R304	RT1015214	Carbon, 1.5KΩ, ±10%, 1/4W
R234	RT1015114	Carbon, 150Ω, ±10%, 1/4W	R305	RT1027314	Carbon, 2.7KΩ, ±10%, 1/4W
R236	RT1010214	Carbon, 1KΩ, ±10%, 1/4W	R306	RT1012314	Carbon, 12KΩ, ±10%, 1/4W
R237	RT1015114	Carbon, 150Ω, ±10%, 1/4W	R307	RT1012214	Carbon, 1.2KΩ, ±10%, 1/4W
R238	RT1010414	Carbon, 100KΩ, ±10%, 1/4W	R308	RT1015214	Carbon, 1.5KΩ, ±10%, 1/4W
R239	RT1015114	Carbon, 150Ω, ±10%, 1/4W	R309	RT1022214	Carbon, 2.2KΩ, ±10%, 1/4W
R240	RT1047114	Carbon, 470Ω, ±10%, 1/4W	R310	RT1027314	Carbon, 27KΩ, ±10%, 1/4W
R241	RT1010114	Carbon, 100Ω, ±10%, 1/4W	R311	RT1039114	Carbon, 390Ω, ±10%, 1/4W
R242	RT1047214	Carbon, 4.7KΩ, ±10%, 1/4W	R312	RT1012214	Carbon, 1.2KΩ, ±10%, 1/4W
R243	RT1012314	Carbon, 12KΩ, ±10%, 1/4W	R313-R316	RT0510214	Carbon, 1KΩ, ±5%, 1/4W
R244	RT1010214	Carbon, 1KΩ, ±10%, 1/4W	R317	RT1010314	Carbon, 10KΩ, ±10%, 1/4W
R245	RT1022214	Carbon, 2.2KΩ, ±10%, 1/4W	R318	RT1015314	Carbon, 15KΩ, ±10%, 1/4W
R246	RT1033314	Carbon, 33KΩ, ±10%, 1/4W	R319	RT1015114	Carbon, 150KΩ, ±10%, 1/4W
R247	RT1056314	Carbon, 56KΩ, ±10%, 1/4W	R320	RT1010414	Carbon, 100KΩ, ±10%, 1/4W
R248	RT1012314	Carbon, 12KΩ, ±10%, 1/4W	R321	RT1022114	Carbon, 220Ω, ±10%, 1/4W
R249-R252	RT1010114	Carbon, 100Ω, ±10%, 1/4W	R322-R323	RT1022414	Carbon, 220KΩ, ±10%, 1/4W
R254	RT1010314	Carbon, 10KΩ, ±10%, 1/4W	R324	RT1033014	Carbon, 33Ω, ±10%, 1/4W
R255	RT1018314	Carbon, 18KΩ, ±10%, 1/4W	R325	RT1012414	Carbon, 120KΩ, ±10%, 1/4W
R256	RT1022314	Carbon, 22KΩ, ±10%, 1/4W	R326	RT1015314	Carbon, 15KΩ, ±10%, 1/4W
R257	RT1027314	Carbon, 27KΩ, ±10%, 1/4W	R327	RT1056214	Carbon, 5.6KΩ, ±10%, 1/4W
R258	RT1022314	Carbon, 22KΩ, ±10%, 1/4W	R328	RT1033314	Carbon, 33KΩ, ±10%, 1/4W
R259	RT1012314	Carbon, 12KΩ, ±10%, 1/4W	R329	RT1022414	Carbon, 220KΩ, ±10%, 1/4W
CAPACITORS			R330	RT1068314	Carbon, 68KΩ, ±10%, 1/4W
C201-C207	DK1710301	Ceramic, 0.01μF, ±20%	R331	RT1056314	Carbon, 56KΩ, ±10%, 1/4W
C208	DK1710201	Ceramic, 0.001μF, ±20%	R332	RT0518414	Carbon, 180KΩ, ±5%, 1/4W
C209-C212	DK1710301	Ceramic, 0.01μF, ±20%	R333	RT1010414	Carbon, 100KΩ, ±10%, 1/4W
C213	DK1810402	Ceramic, 0.1μF, +80%, -20%	R334	RT1012414	Carbon, 120KΩ, ±10%, 1/4W
C214-C217	DK1710301	Ceramic, 0.01μF, ±20%	R335-R336	RT0515314	Carbon, 15KΩ, ±5%, 1/4W
C218	DK1810402	Ceramic, 0.1μF, +80%, -20%	R337-R338	RT0510414	Carbon, 100KΩ, ±5%, 1/4W
C219-C225	DK1840302	Ceramic, 0.04μF, ±20%	R339-R340	RN0582414	Carbon, 820KΩ, ±5%, 1/4W
C226	DD1540001	Ceramic, 40pF, ±5%	R341-R342	RT0512214	Carbon, 3.3KΩ, ±5%, 1/4W
C227	DD1620101	Ceramic, 200pF, ±10%	R343-R344	RN0522314	Carbon, 22KΩ, ±5%, 1/4W
C228	DK1710301	Ceramic, 0.01μF, ±20%	R345-R346	RT0568214	Carbon, 6.8KΩ, ±5%, 1/4W
C229	DD1620101	Ceramic, 200pF, ±10%	R347-R348	RT0510214	Carbon, 1KΩ, ±5%, 1/4W
C230	DK1710301	Ceramic, 0.01μF, ±20%	R349-R350	RT0512214	Carbon, 1.2KΩ, ±5%, 1/4W
C231	DD1620101	Ceramic, 200pF, ±10%	R351-R352	RT0536214	Carbon, 3.6KΩ, ±5%, 1/4W
C232	DK1710301	Ceramic, 0.01μF, ±20%	R353	RT1082314	Carbon, 82KΩ, ±10%, 1/4W
SEMICONDUCTORS			R354	RT1022214	Carbon, 2.2KΩ, ±10%, 1/4W
H201-H206	HT308291C	Transistor, 2SC829C	R355	RT1056314	Carbon, 56KΩ, ±10%, 1/4W
H207-H214	HD2001105	Transistor, 1S1555	R356	RT1010414	Carbon, 100KΩ, ±10%, 1/4W
H215-H224	HD1000105	Diode, 1N60	R357-R358	RN1047414	Carbon, 470KΩ, ±10%, 1/4W
MISCELLANEOUS			R359-R360	RN1022414	Carbon, 220KΩ, ±10%, 1/4W
L201	LC1682002	Choke Coil	R361-R362	RT1047214	Carbon, 4.7KΩ, ±10%, 1/4W
F201-F206	FF1107003	Ceramic Filter SFA 10.7MHz	R363	RT1018214	Carbon, 1.8KΩ, ±10%, 1/4W
J201-J208	YP1000094	Plug	R364	RT1056114	Carbon, 560KΩ, ±10%, 1/4W
P300	YD2818004 (ZZ2818004)	P. C. Board P. C. Board Assembly	R365	RA0502013	Trimmer, 5KΩ, B
			R366-R367	RT1022414	Carbon, 220KΩ, ±10%, 1/4W
			R368-R369	RT1047114	Carbon, 470Ω, ±10%, 1/4W
			R374	RT1068214	Carbon, 6.8KΩ, ±10%, 1/4W

REF. DESIG.	MARANTZ PART NO.	DESCRIPTION	REF. DESIG.	MARANTZ PART NO.	DESCRIPTION
C301	EA1060169	CAPACITORS Elect., 10 μ F, 16V	R516	RT1010114	Carbon, 100 Ω , \pm 10%, 1/4W
C302	EA1060169	Elect., 10 μ F, 16V	R517	RT1010114	Carbon, 100 Ω , \pm 10%, 1/4W
C303	DF5547203	Mylar, 4700pF, \pm 5%, 1/4W	R518	RT1039214	Carbon, 3.9K Ω , \pm 10%, 1/4W
C304	DF1647201	Mylar, 4700pF, \pm 10%, 1/4W	R519	RT1018314	Carbon, 18K Ω , \pm 10%, 1/4W
C306	EA1060169	Elect., 10 μ F, 16V	R520	RT1056414	Carbon, 560K Ω , \pm 10%, 1/4W
C311	EA1060169	Elect., 10 μ F, 16V	R521	RT1010414	Carbon, 100K Ω , \pm 10%, 1/4W
C312	EA2270169	Elect., 220 μ F, 16V	R522	RT1010414	Carbon, 100K Ω , \pm 10%, 1/4W
C315-C316	DF1522301	Mylar, 0.022 μ F, \pm 5%, 1/4W	R523	GT0556412	Carbon, 560K Ω , \pm 10%, 1/4W
C317-C318	DF1722401	Mylar, 0.22 μ F, \pm 20%, 1/4W	C501-C502	DK1710301	CAPACITORS Ceramic, 0.01 μ F, \pm 20%, YY
C319-C320	EA1060359	Elect., 10 μ F, 35V	C503	EA1060169	Elect., 10 μ F, 16V
C321-C322	EA1060169	Elect., 10 μ F, 16V	C504	DK1710301	Ceramic, 0.01 μ F, \pm 20%, YY
C323	EA1070109	Elect., 100 μ F, 10V	C505	DK1840302	Ceramic, 0.04 μ F, \pm 100,-0% SL
C324	EM1040251	Elect., 0.1 μ F, 25V	C506-C507	DD1620101	Elect., 10 μ F, 16V
C331-C332	EA4750359	Elect., 4.7 μ F, 35V	C508	EA1060169	Elect., 4.7 μ F, 35V
C333-C334	EV1050251	Elect., 1 μ F, 25V	C509	EA4750359	Elect., 4.7 μ F, 35V
C335	EA2270259	Elect., 220 μ F, 25V	C510	EA1050509	Elect., 1 μ F, 50V
C336	EA3360109	Elect., 33 μ F, 10V	C511	EA1060169	Elect., 10 μ F, 16V
L301	LS1001007	TRANSFORMERS MPX Coil, 19KHz, Amp.	C512	DK1840302	Ceramic, 0.04 μ F, \pm 100%,-0%
L302	LS1503002	MPX Coil, 19KHz, 38KHz Block	C513	DD1620101	Ceramic, 200pF, \pm 10%
L304	LS1503001	MPX Coil, 19KHz, 67KHz, Trap.	C514	EA1070169	Elect., 100 μ F, 16V
L305	LS501002	MPX Coil, L. P. Filter	C515-C517	DK1840302	Ceramic, 0.04 μ F, \pm 100%,-0%
H301-H307	HT3037210	SEMICONDUCTORS Transistor, 2SC372	H501	HC1000105	SEMICONDUCTORS IC, TA7060 P
H308	HF200301C	Transistor, 2SK30 Y	H502	HT306441B	Transistor, 2SC644 S
H309-H310	HT307322A	Transistor, 2SC732 Bn or Gr	H504	HD1000105	Diode, 1N60
H311-H312	HT104942A	Transistor, 2SA494 Gr or Y	J501-J508	YP1000094	MISCELLANEOUS IFT FM Det.
H313-H314	HT3064410	Transistor, 2SC644T	L501	LI1018801	
H315-H320	HD1000105	Diode 1N60	P550	YD2820005 (ZZ2820005)	MISCELLANEOUS P. C. Board Assembly
J301-J303	YP1000094	MISCELLANEOUS Plug	R551	RT1056214	RESISTORS Carbon, 5.6K Ω , \pm 10%, 1/4W
J305-J307	YP1000094	Plug	R552	RT1010114	Carbon, 100 Ω , \pm 10%, 1/4W
J312-J315	YP1000094	Plug	R553	RT1027314	Carbon, 27K Ω , \pm 10%, 1/4W
P500	YD2820004 (ZZ2820004)	P. C. Board P. C. Board Assembly	R554	RT1010414	Carbon, 100K Ω , \pm 10%, 1/4W
R501	RT1015114	RESISTORS Carbon, 150 Ω , \pm 10%, 1/4W	R555	RT1010214	Carbon, 1K Ω , \pm 10%, 1/4W
R502	RT1010214	Carbon, 1K Ω , \pm 10%, 1/4W	R556-R557	RT1033314	Carbon, 33K Ω , \pm 10%, 1/4W
R503	RT1010114	Carbon, 100 Ω , \pm 10%, 1/4W	R558	RT1015414	Carbon, 150K Ω , \pm 10%, 1/4W
R504	RT1022314	Carbon, 22K Ω , \pm 10%, 1/4W	R559	RT1033314	Carbon, 33K Ω , \pm 10%, 1/4W
R505	RT1022114	Carbon, 220 Ω , \pm 10%, 1/4W	R560	RT1033214	Carbon, 3.3K Ω , \pm 10%, 1/4W
R506-R507	RT0582114	Carbon, 820 Ω , \pm 5%, 1/4W	R561	RA0103018	Trimmer, 10K Ω , B
R508-R509	RT0568214	Carbon, 6.8K Ω , \pm 5%, 1/4W	R562	RT1018414	Carbon, 180K Ω , \pm 10%, 1/4W
R510	RT1010114	Carbon, 100 Ω , \pm 10%, 1/4W	R563-R564	RT1010114	Carbon, 100 Ω , \pm 10%, 1/4W
R511	RT1056214	Carbon, 5.6K Ω , \pm 10%, 1/4W	R579	RT1010414	Carbon, 100K Ω , \pm 10%, 1/4W
R512	RT1018314	Carbon, 18K Ω , \pm 10%, 1/4W	R580	RT1010214	Carbon, 1K Ω , \pm 10%, 1/4W
R513	RN1018414	Carbon, 180K Ω , \pm 10%, 1/4W	R578	RT1010114	Carbon, 100 Ω , \pm 10%, 1/4W
R514	RT1022214	Carbon, 2.2K Ω , \pm 10%, 1/4W	R581	RT1010214	Carbon, 1K Ω , \pm 10%, 1/4W
R515	RN1010414	Carbon, 100K Ω , \pm 10%, 1/4W	R586	RT1010314	Carbon, 10K Ω , \pm 10%, 1/4W
			R582	RT1010414	Carbon, 100K Ω , \pm 10%, 1/4W
			R583	RT1015514	Carbon, 1.5M Ω , \pm 10%, 1/4W
			R584	RT1010214	Carbon, 1K Ω , \pm 10%, 1/4W
			R585	RT1010314	Carbon, 10K Ω , \pm 10%, 1/4W
			C401-C402	DK1810351	CAPACITORS Ceramic, 0.01 μ F, \pm 100% 50V
			C403-C404	EA3370509	Elect., 330 μ F, 25V
			C405	EA1070259	Elect., 100 μ F, 25V
			R401	RC1033212	RESISTORS Solid, 3.3K Ω , \pm 10%, 1/2W
			R402	RC1012012	Solid, 12 Ω , \pm 10%, 1/2W
			R403	RC1027112	Solid, 270 Ω , \pm 10%, 1/2W
			R404	RC1015312	Solid, 15K Ω , \pm 10%, 1/2W
			R405	RC1033312	Solid, 33K Ω , \pm 10%, 1/2W
			R406	RC1012012	Solid, 12 Ω , \pm 10%, 1/2W
			R407	RC1010112	Solid, 100 Ω , \pm 10%, 1/2W
			R408-R409	RT1010214	Carbon, 1K Ω , \pm 10%, 1/4W
			R410-R411	GT0510512	Carbon, 1M Ω , \pm 5%, 1/2W
			R412-R413	GT0530412	Carbon, 300K Ω , \pm 5%, 1/2W
			R414-R415	RT0556314	Carbon, 56K Ω , \pm 5%, 1/4W
			R416-R417	RT0566214	Carbon, 5.6K Ω , \pm 5%, 1/4W
			R418-R419	RT1010214	Carbon, 1K Ω , \pm 10%, 1/4W
			R420-R421	RT0527214	Carbon, 2.7K Ω , \pm 5%, 1/4W
			R422-R423	RT1015114	Carbon, 150 Ω , \pm 10%, 1/4W
			R424-R425	RT1010414	Carbon, 100K Ω , \pm 10%, 1/4W
			R426	RC1010112	Solid, 100 Ω , \pm 10%, 1/2W
			P400	YD2827001 (ZZ2827001)	P. C. Board P. C. Board Assembly
			L551	LC2105001	MISCELLANEOUS Choke Coil, 1mH Plug
			J551-J565	YP1000094	Plug
			H551	HT307331C	SEMICONDUCTORS Transistor, 2SC733 Gr
			H552-H553	HT3036210	Transistor, 2SC372
			H554-H555	HD1000105	Diode 1N60
			H560-H561	HT303720A	Transistor, 2SC372 Y
			H562	HT307331D	Transistor, 2SC733 BL
			C563	DF1710402	Mylar, 0.1 μ F, \pm 20%
			C564	DF1710402	Mylar, 0.1 μ F, \pm 20%
			C562	DK1710301	Ceramic, 0.01 μ F, \pm 20%, +80%,-20%
			C565	DK1840302	Ceramic, 0.04 μ F, \pm 100%,-0%
			C566	DK1810402	Ceramic, 0.1 μ F, \pm 80%,-20%
			C568	DK1810402	Ceramic, 0.1 μ F, \pm 80%,-20%
			C569	EA4750359	Elect., 4.7 μ F, 35V
			C560-C561	DK1710301	Ceramic, 0.01 μ F, \pm 20%, +80%,-20%
			C562	DK1840301	Ceramic, 0.04 μ F, \pm 80%,-20%
			C551	DD1615001	Elect., 10 μ F, 16V
			C552	DF1668301	Ceramic, 15pF, \pm 10%, SL
			C553	DF1740301	Mylar, 0.068 μ F, \pm 20%
			C554	EA1060169	Mylar, 0.04 μ F, \pm 20%
			C555	DK1840302	Elect., 10 μ F, 16V
			C556	DK1810402	Ceramic, 0.04 μ F, \pm 100%,-0%
			C558	DK1810402	Ceramic, 0.1 μ F, \pm 80%,-20%
			C559	EA4750359	Elect., 4.7 μ F, 35V
			C551	DK1710301	Ceramic, 0.01 μ F, \pm 20%, +80%,-20%
			C552	DK1840302	Ceramic, 0.04 μ F, \pm 100%,-0%
			C553	DK1810402	Ceramic, 0.1 μ F, \pm 80%,-20%
			C554	EA1060169	Elect., 10 μ F, 16V
			C555	DK1840302	Ceramic, 0.04 μ F, \pm 100%,-0%
			C556	DK1810402	Ceramic, 0.1 μ F, \pm 80%,-20%
			C558	DK1810402	Ceramic, 0.1 μ F, \pm 80%,-20%
			C559	EA4750359	Elect., 4.7 μ F, 35V
			C560-C561	DK1710301	Ceramic, 0.01 μ F, \pm 20%, +80%,-20%
			C562	DK1840301	Ceramic, 0.04 μ F, \pm 80%,-20%
			C563	DF1710402	Mylar, 0.1 μ F, \pm 20%
			C564	DF1710402	Mylar, 0.1 μ F, \pm 20%
			C562	DK1710301	Ceramic, 0.01 μ F, \pm 20%, +80%,-20%
			C565	DK1840302	Ceramic, 0.04 μ F, \pm 100%,-0%
			C566	DK1810402	Ceramic, 0.1 μ F, \pm 80%,-20%
			C568	DK1810402	Ceramic, 0.1 μ F, \pm 80%,-20%
			C569	EA4750359	Elect., 4.7 μ F, 35V
			C560-C561	DK1710301	Ceramic, 0.01 μ F, \pm 20%, +80%,-20%
			C562	DK1840301	Ceramic, 0.04 μ F, \pm 80%,-20%
			C551	DD1615001	Elect., 10 μ F, 16V
			C552	DF1668301	Ceramic, 15pF, \pm 10%, SL
			C553	DF1740301	Mylar, 0.068 μ F, \pm 20%
			C554	EA1060169	Mylar, 0.04 μ F, \pm 20%
			C555	DK1840302	Elect., 10 μ F, 16V
			C556	DK1810402	Ceramic, 0.04 μ F, \pm 100%,-0%
			C558	DK1810402	Ceramic, 0.1 μ F, \pm 80%,-20%
			C559	EA4750359	Elect., 4.7 μ F, 35V
			C560-C561	DK1710301	Ceramic, 0.01 μ F, \pm 20%, +80%,-20%
			C562	DK1840301	Ceramic, 0.04 μ F, \pm 80%,-20%
			C563	DF1710402	Mylar, 0.1 μ F, \pm 20%
			C564	DF1710402	Mylar, 0.1 μ F, \pm 20%
			C562	DK1710301	Ceramic, 0.01 μ F, \pm 20%, +80%,-20%
			C565	DK1840302	Ceramic, 0.04 μ F, \pm 100%,-0%
			C566	DK1810402	Ceramic, 0.1 μ F, \pm 80%,-20%
			C568	DK1810402	Ceramic, 0.1 μ F, \pm 80%,-20%
			C569	EA4750359	Elect., 4.7 μ F, 35V
			C560-C561	DK1710301	Ceramic, 0.01 μ F, \pm 20%, +80%,-20%
			C562	DK1840301	Ceramic, 0.04 μ F, \pm 80%,-20%
			C563	DF1710402	Mylar, 0.1 μ F, \pm 20%
			C564	DF1710402	Mylar, 0.1 μ F, \pm 20%
			C562	DK1710301	Ceramic, 0.01 μ F, \pm 20%, +80%,-20%
			C565	DK1840302	Ceramic,

REF. DESIG.	MARANTZ PART NO.	DESCRIPTION	REF. DESIG.	MARANTZ PART NO.	DESCRIPTION
C406-C407	EA4760509	Elect., 47 μ F, 50V	J016	YJ0500017	Transistor Socket
C408	EA1070259	Elect., 100 μ F, 25V	J017	YL0103001	Terminal
C409	EA1070359	Elect., 100 μ F, 35V	J018	YL0103001	Terminal
C410-C413	EV1050251	Elect., 1 μ F, 25V	F001	FS1005007	Fuse
J401-J416	YP1000099	MISCELLANEOUS	W001	YC0240010	AC Cord
H401	HT312132A	SEMICONDUCTORS	W002-W003	YB00007001	Connective Cord
H402-H403	HT304582A	Transistor, 2SC1213A B or C	W004	YB0027001	Connective Cord
H404-H405	HT104942A	Transistor, 2SC458 LG (D) or (C)	W005	YW2827001	Wire Material
H406-H407	HD2000413	Diode, S1B-01-02 (200PIV, 1A)	W006	YX2827001	Wire Material
H408	HD3002109	Diode, BZ140	R001	RC1008212	RESISTORS
P600	YD2827002	P. C. Board	R002-R003	RC1068012	Solid, 8.2 Ω , \pm 10%, 1/2W
	(ZZ2826002)	P. C. Board Assembly	R004	RK0254002	Solid, 68 Ω , \pm 10%, 1/2W
M601-M604	IN1006301	MISCELLANEOUS	R005-R006	RK0104003	Variable, 250K Ω , (B)
J601-J605	YP1000094	Lamp 6.3V, 0.04A Plug	R007	GS1010105	Variable, 100K Ω , (B)
P700	YD2827003	P. C. Board	R008	RC1039012	Carbon, 100 Ω , \pm 10%, 5W
	(ZZ2827003)	P. C. Board Assembly	R009	GT0522501	Solid, 39 Ω , \pm 5%, 1W
S701	SP0605002	MISCELLANEOUS	R011	RT1056114	Carbon, 2.2M Ω , \pm 10%, 1K
		Push Switch	R012	RC1018012	Carbon, 560 Ω , \pm 10%, 1/4W
R701	RT1082214	RESISTOR	R013	RT1056114	Solid, 18 Ω , \pm 10%, 1/4W
		Carbon, 8.2K Ω , \pm 10%, 1/4W	R014	RT1082414	Carbon, 560 Ω , \pm 10%, 1/4W
C701	DF1622301	CAPACITOR	C001	EA3360109	CAPACITORS
		Mylar, 0.022 μ F, \pm 10%	C003	DK1710301	Elect., 33 μ F, 10V
L001	LF1120023	TRANSFORMERS	C004	DO0733380	Ceramic, 0.01 μ F, 50V, YY
L002	LB3007526	AM Ant. Coil			Oil Paper, 0.033 μ F, 80VAC \pm 20%
L003	LC1302001	Balun Coil			
L004	TS1660803	Choke Coil			
L005	LC1302001	Power Transf. Choke Coil, 3 μ H			
H001	HT403154A	MISCELLANEOUS			
M001	IM1104204	Transistor, 2SD315 (C, D, E, F)			
M003-M007	IN1008007	Signal DC Mete Lamp 8V 0.06A			
S001	SS0202017	Slide Switch			
S003	SP0201010	Power Switch			
J001	YT0104011	Terminal for Ant. Terminal			
J004	YL0106004	Terminal			
J005	YJ0800012	Fuse Holder			
J007	YL0105001	5P Terminal			
J009	YL0104001	4P Terminal			
J010	YJ0800013	Meter Socket			
J011-J014	YJ0800013	Dial Illumination Socket			
J015	YL0301021	Ground Terminal			

SPECIFICATIONS

FM Sections:

Tuning Frequency Range	88-108 MHz
IHF M Usable Sensitivity	2.3 μ V
IHF M Selectivity	60dB
Capture Ratio	1.6dB
Image Rejection Ratio at 106MHz	70dB
Signal to Noise Ratio (Mono)	70dB
Signal to Noise Ratio (Stereo)	60dB
Total Harmonic Distortion (Mono)	0.15%
Total Harmonic Distortion (Stereo)	0.3%
Frequency Response (ref. 75 μ sec. de-emphasis)	\pm 1dB, 50 Hz-15KHz
Stereo Separation at 1KHz	42dB

AM Sections:

Tuning Frequency Range	540-1600KHz
Usable Sensitivity	20 μ V
Selectivity	26dB
Image Rejection Ratio	70dB
Signal to Noise Ratio	46dB
Frequency Response, -3dB down	50Hz-4KHz
Total Harmonic Distortion	1%

General:

Power Requirements	100/120/200/220/240 V AC
	50 to 60 Hz
Power Consumption	25 Watts
Dimensions Panel Width	14-11/64
Panel Height	4-23/32
Depth	11-1/32
Weight Unit alone	15,4 lbs
Packed for Shipment	22,4 lbs

*These specifications and exterior designs may be changed for improvement without advance notice.



marantz

MARANTZ CO., INC. • P.O. BOX 99 • SUN VALLEY, CALIFORNIA • 91352



A WHOLLY-OWNED SUBSIDIARY OF SUPERSCOPE INC., SUN VALLEY, CALIFORNIA 91352