



# Platinum Series™ Shade Systems Owner's Manual

**PLEASE READ ALL INSTRUCTIONS PRIOR TO INSTALLATION. THIS MANUAL INCLUDES IMPORTANT INFORMATION ABOUT YOUR MCD PLATINUM SERIES SHADES.**

## Table of Contents

Design Features / General Information.....1

Installation Instructions.....4

Platinum Series Manual Shade Operation.....2

Platinum Series Power Shades - Switch Controlled.....7

Platinum Series Power Shades - Remote Controlled.....10

    2-Channel Remote.....11

    14-Channel Remote.....12

Care and Cleaning.....14

Troubleshooting.....15

Limited Warranty and Getting Service.....17

MCD Contact Information.....20



## Design Features / General information

The **Platinum Series™** Shade Systems are advanced, patent-pending window shade innovations designed to provide Solar Protection and/or 100% Light Blocking capabilities. The **Platinum Series™** Duo models provide both, and the **Platinum Series™** Solo models provide one or the other. Both are attractive, compact, durable, and user-friendly systems. Features/Benefits Include:

- Exceptional Heat/UV Reduction
- Complete Night-time Privacy
- Improved Interior Décor
- Easy to Operate
- Excellent Daytime Privacy
- Superior Outward Visibility
- High-Tech, Reflective Window Appearance
- Easy to Clean

This unique system is easy to operate, easy to clean and eliminates the maintenance and durability problems associated with conventional pleated shades.

MCD shades take the place of curtains, expensive Venetian blinds, conventional roller shades and other dated shade applications.

With the **Platinum Series™** Shade System, your coach will benefit from superior heat/UV blocking on EVERY window, and have a cleaner, less cluttered outside appearance with improved outward visibility.

The **Platinum Series™** Duo Shade System assembly is comprised of two roller shades; one with the exclusive MCD ClearView™ Solar Screen material and the other with a 100% light blocking material. The 100% light blocking shade material also serves as the interior window covering and is available in a variety of colors and patterns in our attractive and durable vinyl material. The **Platinum Series™** Duo Shade System is available in a choice of manual, switch electric, and remote electric models as well as combinations thereof, such as a manual solar day shade combined with an electric, remote-controlled light blocking night shade.

The **Platinum Series™** Solo Shade System is available as described above, but with only one roller shade as a day shade utilizing the MCD ClearView™ Solar Screen material OR as a night shade with one of our 100% light blocking materials.

The manual shade utilizes a high-quality spring roller encased in an aluminum tube. The shade can simply be lowered by hand to virtually any position, then easily retracted with a touch-n-release movement. MCD's unique GlideRise IV™ technology allows for a controlled ascent speed and MCD's Auto Stop™ will stop the shade at a predetermined set point every time it's raised. This predetermined set point can easily be changed if desired.

The electric powered versions of the shades utilize MCD's state of the art 12v DC tubular motors which fit inside MCD's aluminum roller tube. You can choose either switch control or the advanced remote control system of operation. The upper and lower set-limits are set quickly and precisely utilizing MCD's exclusive built-in electronic set-limit capability on both the switch controlled and remote controlled motors for unparalleled shade fit in each particular coach.

The remote controlled power motors have integrated receivers and can be easily programmed to operate not only independently, but in multiple groupings as well, such as in a passenger-side-only mode or in an all-together mode. The remote controlled motors also have the added flexibility of allowing one shade to be controlled by multiple remote controllers as well as one remote controller being able to control many different shades.

MCD's switch controlled power motors are also available in a Safety Leading dual-range model for windshields. The dual-range motors feature two sets of upper and lower set-limits; one set of limits with the vehicle ignition on and one set of limits with the vehicle ignition off. A typical example of ignition-on limits would be from 0" down from the top to around 15" down from the top. This allows the user to safely lower the shade to any position within this range, while the ignition is on, and provides for a full-width sun visor. The ignition-off limits would be from 0" down from the top, to flush with the dash. When the ignition is on, the user can operate the windshield shade anywhere within the full range of motion

for the shade. This safety feature prevents the shade from being lowered into the driver's line of sight while operating the vehicle.

Generally, the windshield shade system should be dual-range, switch motor powered and be operated by switch controls installed in the cockpit area. The solar day shade should be wired to be operated by both the driver and the passenger, but the light-blocking night shade should only be able to be operated by the driver. Using our dual-range switch motors, either shade could be utilized as a visor in a partially-down position while

driving. The solar screen could be used to reduce glare while the light-blocking shade could be used as a full side-to-side visor for total glare blockage.

All shades throughout the coach can be ordered as manual, switch electric power, remote electric power, or even a combination (i.e. manual/powering). If remote electric power operation is specified, those shades can be operated by remote controllers located in the applicable window area, as well as being able to be controlled by one or more master remote controller units located throughout the coach for convenience.



3303 N. MCDonald St.  
McKinney, TX 75071

972.548.1850

800.804.1757

[www.mcdinnovations.com](http://www.mcdinnovations.com)

## Installation Instructions

The Platinum Series™ Day/Night Shade System has been designed with ease of installation in mind. The assembly is mounted on special dual brackets and held together as an assembly with the use of a mounting track across the top. After installing the appropriate number of mounting clips into the valance, wall, or ceiling, the entire assembly simply snaps into place. *All shade assemblies (manual, powered, or combination) use the same physical mounting procedures.*



Before you begin the installation, please verify the following:

1. The valance and/or side boards, if applicable, are at least 2" deep.
2. The width of the shade is greater than the window and less than the window valance/side board.
3. You have the correct number of mounting clips and screws to complete the installation.

- Finished shade assembly size:
- 29" or smaller = 2 clips
- 30" to 60" = 3 clips
- 61" and bigger = 4+ clips
- Full width windshield shades require 6 clips.

**NOTE:** Installation screws are not provided due to variations in requirements. MCD recommends using #8 pan head sheet metal screws. The most common length is 1" but may vary due to the needs of your particular installation.

4. If the shades are motorized, an adequate 12-volt DC power source is available and can be safely routed to the motor wires. If a source of power is not readily available, you may choose to install a small 12-volt DC sealed battery and charger to operate the shades, or a 120 VAC to 12 VDC converter can be utilized.

### Installation Procedures

1. If the shade assembly is powered, refer to the proper section of this manual for wiring procedures prior to continuing. Once the 12-volt power wires are available, continue the installation starting with Step #2.

**NOTE:** For best results, all clips should be solidly mounted. When mounting to an uneven or padded surface, it may be necessary to utilize solid spacers to ensure a firm, dependable and level mounting.

2. For full width windshield shade installations, install two clips at each end of the shade assembly separated by no more than 1". This ensures that if an end clip should somehow fail due to improper installation, then the second clip will help prevent the windshield shade from falling. The remaining two clips should be evenly spaced across the middle. Mounting clip tabs should be located toward the outside of the coach.

3. For window shade installations, begin installation by mounting the clips to the top of the valance, cupboard bottom, or headliner. For best results, the shade should be located as close to the glass as possible (usually 3/8" away from the window frame) while still allowing for unobstructed operation of the shade throughout its entire range of travel. (Example: the shade should be mounted close to the glass, but not so close that it hangs up on the screen door window frame latches when lowered.)

**NOTE:** In most Platinum Duo installations, the ClearView™ solar material should be located closest to the glass. The night material should be closest to the inside of the coach.

The outermost clips should be mounted within 2” from the end of the shade assembly. Mounting clip tabs should be located toward the inside of the coach.

4. Center the shade assembly, check for proper orientation, and attach to the mounting clips. The shade assembly is mounted to the clips by placing the outside edge of the assembly rail into the clips and rotating the shade toward the clip tabs to firmly and solidly snap the mounting rail into place.

5. Check the following to ensure proper operation of the shade:

a. The shade must be level. Solid spacers of the appropriate thickness and placed under the mounting clips may be necessary. See the Note next to #1 above for additional suggestions.

b. Proper operation requires clearance around all sides of the shade in the upper position. It should not be rubbing on anything when it is in the upper position.

c. The shade should not bind on anything throughout its entire range of travel.

d. The shade assembly should be evenly spaced left to right, and/or mounted so that it covers as much of the glass as possible when lowered.

## Operating Instructions for Platinum Series™ Adjustable Speed and AutoStop™ Features



Speed (black) and  
AutoStop™ (gray)  
Adjustment Slots

MCD's new GlideRise™ technology is a major advancement in manual, spring roller operated window shades. They utilize a very high quality spring roller system and auto-stopping mechanism encased in an aluminum tube. GlideRise™ represents a major step forward in quality and innovation. Shades are easily lowered by hand to virtually any position and retracted with a pull-to-release movement. MCD's unique technology allows for a controlled and user-adjustable ascent speed and MCD's AutoStop™ will stop the shade at a predetermined – and also user-adjustable – set point every time it's raised. The shade ascent speed and stop point can both be easily changed if desired.

If necessary, the shade spring tension (Speed) and shade stop position are adjusted very easily before installation by simply turning the appropriate adjustment screw at the ends of each shade with a flat bladed screwdriver. The shade spring tension adjustment is always black in color and the AutoStop™ stop position is always white.

Every shade is delivered already tensioned (Speed) and set to stop at the appropriate upper position (AutoStop).

**Note: It should not be necessary to adjust your Platinum Series™ shade. The following adjustment instructions are provided for you to fine tune your shade if needed. Please note that the stop point adjustment and speed adjustment below must be made with your shade assembly removed from the mounted position. We suggest you make any needed adjustments before you install your shade into the mounting clips since you will have to use a flat-blade screwdriver in the adjustment slots located at each end of the bracket which will NOT be accessible when the shade is installed.**

## Platinum Series™ AutoStop™ Adjustment



Platinum Series AutoStop™ Adjustment

To adjust the point at which your shade will stop when raised, first identify the AutoStop™ slot – it may be on either end of the shade you want to adjust, depending upon shade configuration. It will be white in color.

Measure the drop of the top of your valance and then measure from the top of the shade track to the bottom of the hem rail and adjust your AutoStop accordingly.

With a flat-blade screwdriver, push in to the adjuster slot to release the lock mechanism, then turn the screw head the direction you want the shade to go. With the AutoStop™ on the left bracket side, turn the screw head clockwise to lower the set point, and turn the screw head counter-clockwise to raise the set point. Reverse this procedure if your shade's AutoStop™ is on the opposite bracket side.

## Platinum Series™ Speed Adjustment



Platinum Series Speed Adjustment

To adjust the speed at which your shade rises, locate the black adjuster. Use a flat-blade screwdriver and push in the adjuster slot to release the lock mechanism, then turn the screw head clockwise (looking at the end of the bracket) to increase the spring tension and ascent speed. Push in and turn it counter-clockwise to decrease the speed.

Test your shade after each 1-2 adjuster revolutions by lowering and raising the shade as normal. Be sure to hold assembly as close to the bracket ends as possible. The shade will not operate correctly if held in the center.

Your shades were already set to the ideal speed at the factory, so they shouldn't require any adjustment. But, fine increases or decreases are easily made before mounting your shade.

Caution: Over tensioning may cause the shade to “stick” at its upper limit. If you have to “break loose” the shade to lower it, the tension is too high. Release tension until the shade can be easily lowered without having to break it loose, yet allowing it to fully retract.

# Platinum Series™ Powered Shades - Switch Controlled

## Operating Instructions for Dual-Range Switch Motor

To use the Dual-Range switch operated shade, simply press the Up or Down button for the appropriate shade. The switch-operated shades require the switch to be held until the shade either reaches its limit or the desired intermediate position. (The shade can be stopped at any point by simply releasing the switch).

If the Ignition is On, the shade can only operate within the Ignition On range of set-limits. With the Ignition Off, the shade can operate within the entire range of set-limits.

If you turn the ignition on prior to raising the shade from the lowest full range limit, the shade will still move in the up direction, but cannot be lowered below the Ignition On upper set-limit once it has been raised above this point.

### Shade Motor Description and Wiring Requirements:

#### Technical Parameters:

Power Supply: 12 VDC, 800mA

Lift Capacity: 11 lb / 5 kg

The switch-controlled motors have built-in electronics to memorize the upper and lower set-limits for the shades after the initial setting in "ignition on" mode and "ignition off" mode. The connections to the motor are shown below:

Switch Control Motor: The motor connections determine motor running direction. Utilize a DPDT momentary On - Off-On switch.

NOTE: The MCD Dual-Range Motor is designed for Windshield use. If using for any other window where the Dual-Range safety function is not necessary, simply disregard the brown ignition wire and coil it up out of the way.

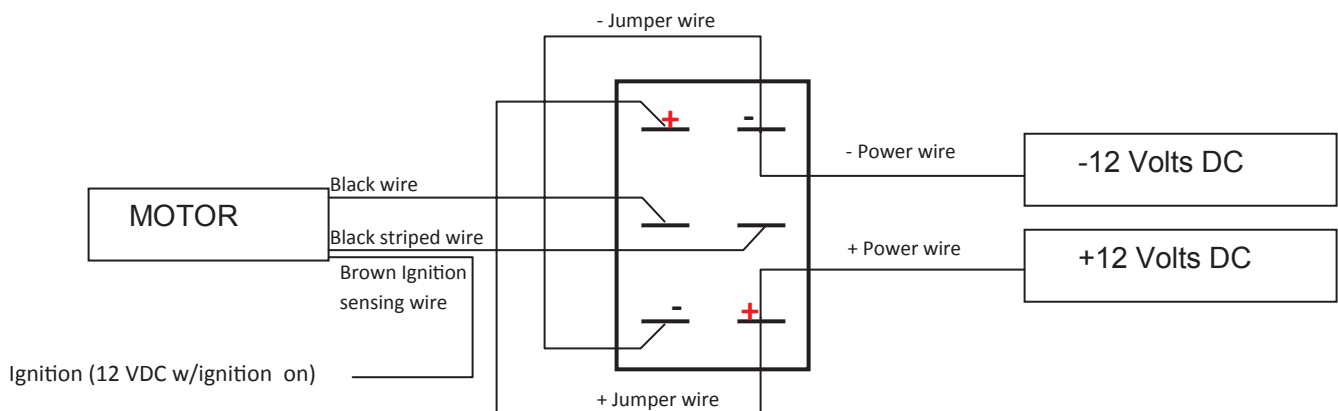

## Setting Limits for Dual-Range Switch Motor

Please read all steps first before beginning!

1. Locate the learning wires coming from the motor for which you are setting the limits. These two wires are approximately five inches long and hang from the bottom of the motor. The wires are usually grey in color and should not be connected to any other wires (power source, etc.)

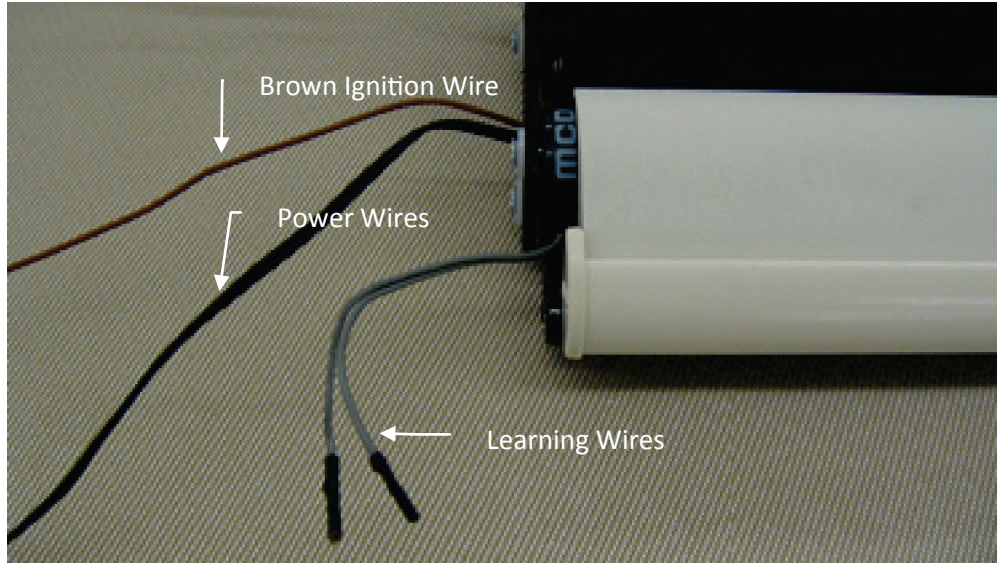

2. Plug the Learning Key into the learning wires. (There is no positive or negative direction to the learning wires; just hook it up to the supplied Learning Key, or if no Learning Key is available, the 2 learning wires can be shorted together momentarily, instead of each Learning Key button press.)

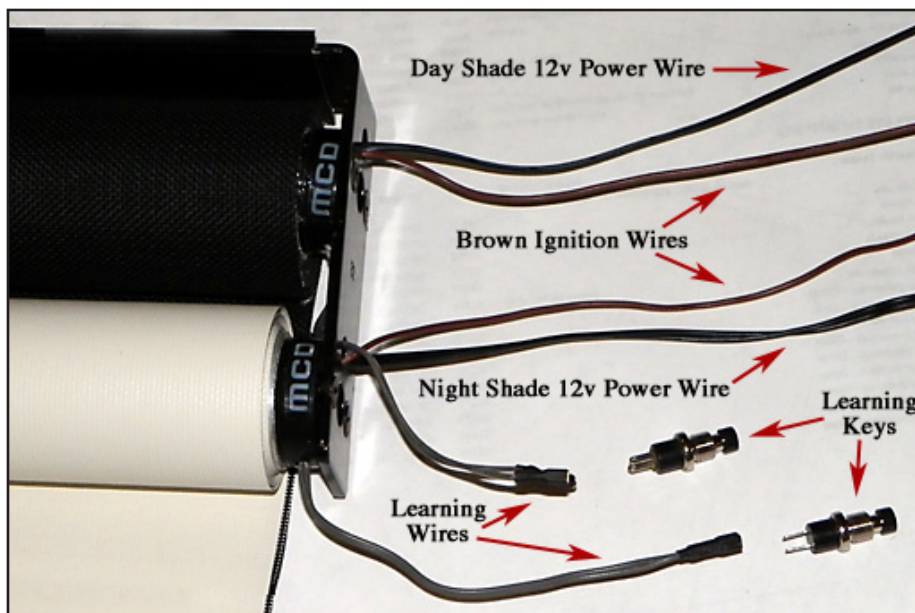

**3. YOU MUST SET THE LIMITS IN THE FOLLOWING ORDER:**

- "Ignition ON" LOWER Set-Limit
- "Ignition ON" UPPER Set-Limit
- "Ignition OFF" LOWER Set-Limit
- "Ignition OFF" UPPER Set-Limit



## Setting Limits for Dual-Range Switch Motor (cont.)

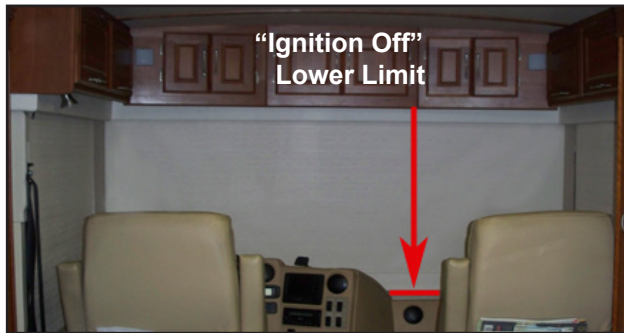

4. Turn the ignition on. Press and hold the Learning Key button. While holding the button, press and hold the Down switch. The motor will move in the down direction; continue holding both the button and the switch until the motor chirps and the shade stops. Once the motor chirps and the shade stops, release both buttons. The motor is now in the Set-Limit Learning Mode.
5. Press and hold the switch in the down direction. Release the switch once the shade reaches the approximate desired "Ignition On" lower limit. This set-limit should be set at a height that allows the shade to be used as a sun visor, but still safely allows a clear view of the road. (You can fine tune the set-limit by following the NOTE to the right.) Once you are satisfied with the "Ignition On" lower limit, reverse the direction of the switch to the up direction. The motor will chirp, locking the lower "Ignition On" set-limit into the motor's memory, and will then begin moving in the up direction.
6. Continue holding the switch in the up direction. Release the switch once the shade reaches the approximate desired upper limit. Once you are satisfied with the upper limit, reverse the direction of the switch to the down position. The motor will chirp, locking in the upper limit.

NOTE: If the shade is already at its lower set-limit, the shade will not move and the motor should 'chirp' within about 5 seconds. Once the motor chirps, release both buttons and it is now in Set-Limit Learning Mode.

NOTE: Fine tune the set-limit by "bumping" the shade lower. Each quick press of the Down switch will move the shade down about 1/16".

Once you release the down switch the first time, it is no longer possible to move down continuously while in the Set-Limit Learning Mode without restarting the procedure. You can only bump adjust the shade down.

7. Both the upper and the lower "Ignition On" set-limits are now set. You **MUST** now set the "Ignition Off" set-limits next. *You cannot only set one set of limits; both the "Ignition On" and the "Ignition Off" set-limits must be set once you enter into the Set-Limit Learning Mode.*
8. Turn the Ignition Off.
9. Press and hold the Learning Key button again. While holding the button, press and hold the Down switch. The motor will move in the down direction; continue holding both the button and the switch until the motor chirps and the shade stops. Once the motor chirps and the shade stops, release both buttons. The motor is now in the Set-Limit Learning Mode.
10. Repeat Steps 5. and 6. above to set lower and upper limits. ***Remember:*** Once you enter the set-limit learning mode, you **MUST** set and lock-in all four limits; 1) Ignition On lower limit, 2) Ignition On upper limit, 3) Ignition Off lower limit, 4) Ignition Off upper limit. ***Failure to lock in all four set-limits will result in a shade that does not operate as you intended.***

## Platinum Series™ Powered Shades - Remote Controlled

### Operating Instructions for Remote Controlled Motor

The remote-controlled motors have integrated electronics to memorize the upper and lower set-limits for the shades after the initial setting. The remote control motors also have integrated receivers and can be easily programmed to operate independent of other shades and in multiple shade groupings as well, such as in a passenger-side-only mode or in an all-together mode.

#### Technical Parameters

Power Supply: 12 VDC  
 Amperage: 800mA  
 Lift Capacity: 11 lb / 5 kg

#### Wiring:

Connect the black wire with the white stripe to the positive power source. Connect the solid black wire to the negative power source. The learning wires should never be connected to any power source.

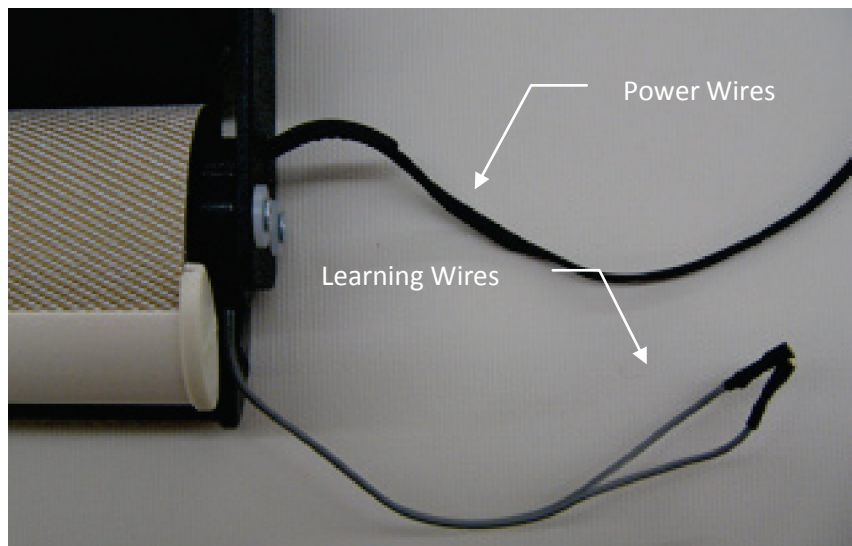

*If each shade motor and controller are already programmed and you only need to adjust the set-limits, you can skip down to the "Process to Adjust the Set Limits using 2-Channel Remote Controller" section of these Instructions.*

## 2-Channel Remote

### Linking Shade Motor to 2-Channel Remote Controller

Please read all steps first before beginning!

1. Remove the trim cover off of the remote to expose the programming keys.

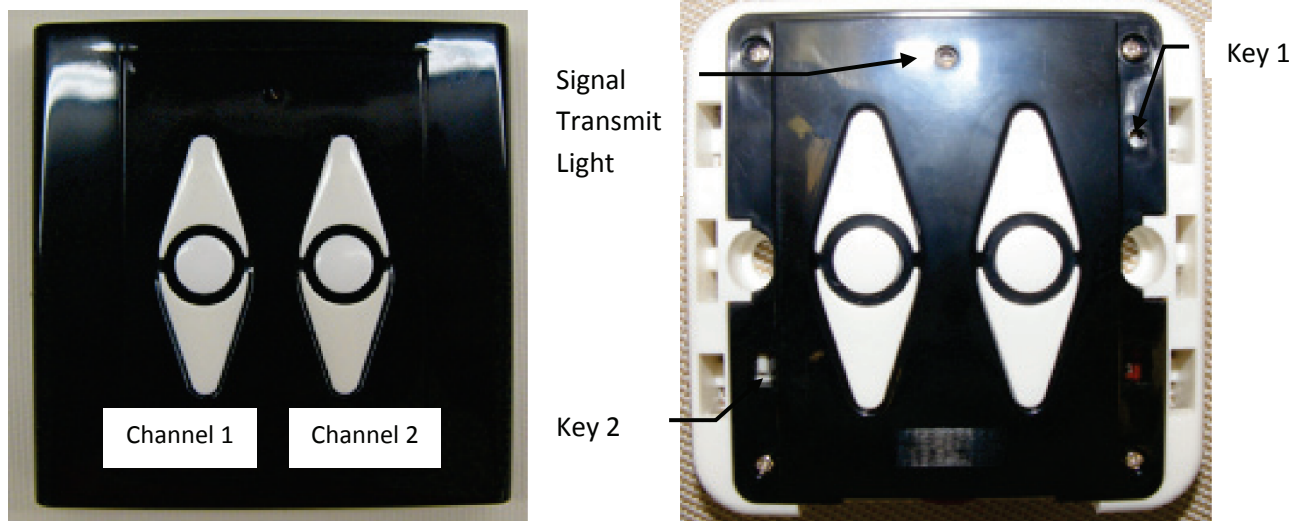

2. For each shade motor, start by clearing the memory of the motor by shorting the two learning wires on the motor together; either with the Learning Key, a paperclip, or by touching and holding the terminals together. The motor will emit a "Diiii—Diiii—Diiii" sound, will then give a quick, short "D-D-D" sound. After a short pause, the motor will start to beep again; you should now un-short the learning wires.
3. After un-shortening the learning wires, the motor will continue to give the "Diiii—Diiii—Diiii" sound (this sound means that the motor is searching for a controller signal). While the motor is still emitting this sound, press and release any button (Up, Stop, Down) on the remote controller channel (button) that you want to use. Then press and hold Key 1. When the motor successfully recognizes the controller, it will give a quick "D-D-D" sound.
4. Press Up or Down on the remote to test that the motor is going in the correct direction. If you need to change the direction of the motor, press and hold both Key 2 and the Stop button on the corresponding channel. The motor should give a quick "D-D-D" confirming the change of direction command.

NOTE: Clearing the motor's memory only erases the controllers to which it is programmed. It does not erase Set Limits or motor direction.

### Process to Adjust the Set Limits using 2-Channel Remote Controller

Please read all steps first before beginning!

1. To enter the set-limit mode, press and release "Stop" on the channel (shade) that you want to adjust. Then press and hold Key 2 until you hear the short "D-D-D" sound. The motor is now in the set-limit mode.

NOTE: Once the motor is put into Set-Limit Mode, you must set and confirm both the Lower and Upper limits.

NOTE: The remote is powered by "watch" batteries that can be purchased at most discount or hardware stores.

2. To set the lower set-limit, operate the shade in the down direction until it reaches the desired set point. Press Stop to stop the shade. You can "fine tune" the set point by pressing the Up or Down button. This will cause the shade to move approximately 1/16" at a time.

NOTE: Clearing the motor's memory only erases the controllers to which it is programmed. It does not erase Set Limits or motor direction.

3. Once you are satisfied with the limit, press and hold Key 1. The motor should emit a short "D-D-D" sound confirming that the lower set-limit has been locked into memory.

4. To set the upper set-limit, operate the shade in the up direction until it reaches the desired set point. Press Stop to stop the shade. You can "fine tune" the set point by pressing the Up or Down button. This will cause the shade to move approximately 1/16" at a time. Once you are satisfied with the limit, press and hold Key 1. The motor should emit a short "D-D-D" sound confirming that the upper set-limit has been locked into memory.

## 14-Channel Remote

If your motor and controller are already programmed and you only need to adjust the set-limits, you can skip down to the "Process to Adjust the Set Limits Using 14-Channel Remote Controller" section of the Instructions.

### Linking Shade Motor to 14-Channel Remote Controller

Please read all steps first **before** beginning!

1. For each shade motor, start by clearing the memory of the motor by shorting the two learning wires on the motor together; either with the Learning Key, a paperclip, or by touching and holding the terminals together. The motor will emit a "Diiii—Diiii—Diiii" sound, and will then give a quick, short "D-D-D" sound. After a short pause, the motor will start to beep again; you should now un-short the learning wires.
2. After un-shorting the learning wires, the motor will continue to give the "Diiii—Diiii—Diiii" sound (this sound means that the motor is searching for a controller signal). While the motor is still emitting this sound, press and release the desired channel (button) on the remote controller and then press and hold Key 2. When the motor successfully recognizes the remote controller, it will give a quick "D-D-D" sound.
3. Press Up or Down on the remote controller to test that the motor is going in the correct direction. If you need to change the direction of the motor, press and hold both Key 1 and the Stop button. The motor should give a quick "D-D-D" confirming the change of direction command.

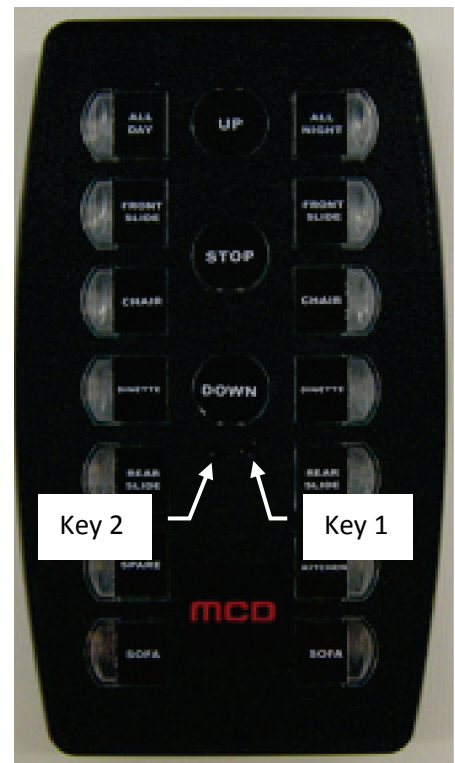

## Process to Adjust the Set Limits using 14-Channel Remote Controller

Please read all steps first before beginning!

1. To enter the set-limit mode, press and release the appropriate channel (button) to select the shade.
2. Now press and hold Key 1 until you hear a short "D-D-D" sound. The motor is now in the set-limit mode.
3. To set the lower set-limit, operate the shade in the down direction until it reaches the desired set point. Press Stop to stop the shade. You can "fine tune" the set point by pressing the Up or Down button. This will cause the shade to move approximately 1/16" at a time. Once you are satisfied with the limit, press and hold Key 2. The motor should emit a short "D-D-D" sound confirming that the lower set-limit has been locked into memory.
4. To set the upper set-limit, operate the shade in the up direction until it reaches the desired set point. Press Stop to stop the shade. You can "fine tune" the set point by pressing the Up or Down button. This will cause the shade to move approximately 1/16" at a time. Once you are satisfied with the limit, press and hold Key 2. The motor should emit a short "D-D-D" sound confirming that the upper set-limit has been locked into memory.

NOTE: Once the motor is put into Set-Limit Mode, you must set and confirm both the Lower and Upper limits.

NOTE: The remote is powered by "Watch" batteries that can be purchased at most discount or hardware stores.

## Process to Add Shades to the "All" Button on 14-Channel Remote Controller

Please read all steps first before beginning!

1. As above and utilizing the learning wires, use either the Learning Key, a paper clip, or short them together until the motor begins to beep. As soon as the motor begins beeping, release the learning wires.
2. Press and Release the "All" button for which you are adding the shade.
3. Press and hold Key #2. The motor should emit a short "D-D-D" sound confirming that it has been added into memory.
4. It is not necessary to reset the up and down set-limits as they will automatically transfer.

## Care and Cleaning

### Day Shade

ClearView™ Solar Screens should be vacuumed periodically to remove accumulated dust, particularly when traveling in dry, dusty climates. We recommend using your vacuum cleaner's soft upholstery brush and gently vacuuming each shade.

To clean your ClearView™ Solar Screens, you can use a sponge or a soft brush and water to remove stuck-on dust and most stains. A mild cleaning solution can be used to remove tougher stains. Rinse after cleaning by soaking a clean cloth in fresh water, ringing out any excess and wiping the areas where any cleaner was used – repeat as necessary. Use a towel behind the screen as you clean with a sponge or brush to keep splatter down.

### Night Shade

Vinyl material will clean up nicely with any mild cleaning solution using a sponge or non-colored paper towel. Wipe down with water after cleaning and dry thoroughly before raising the shade.

Suede or woven materials have been Teflon treated and should be cleaned with a damp sponge. For stubborn stains, Woolite-brand upholstery cleaner may be used carefully and as directed. After using upholstery cleaner, you should consider reapplying the Teflon treatment by using a ScotchGuard-brand upholstery protecting spray and following the directions for application on a "lightweight" fabric.

## Troubleshooting

### Troubleshooting Procedure for Manual Shades

1. If the shade is rising too quickly, please refer to the Speed Adjustment section on Page 5.
2. If the shade stops too high or too low, please refer to the AutoStop Adjustment section on Page 5.
3. For any other Manual Shade issues, please contact MCD Technical Support (info at end of section).

### Troubleshooting Procedure for Switch Controlled Motors

NOTE: *The most typical problem for ALL powered shades is the loss of Set Limits. The shade motors will retain their Set-Limit memory when the coach's power supply is kept within a normal range of 11.0 to 13.6 volts. They will also retain their Set Limits if the power supply is cut off completely from the shade motor (0 volts). However, if power is gradually drained and falls below the lower limit of 11 volts, the motors could lose their electronic Set Limits and will require reprogramming once normal power has been restored.*

1. Verify power is applied to the motor by depressing the rocker switch in the up or down position. (Voltage should be between 11.0 and 13.6 volts DC.) If the voltage is low, charge the chassis/coach batteries and retry shade operation. Voltage can be verified at the rocker switch or in the disconnect/butt splices in the motor wiring leads. Verify positive and negative voltage (both up and down directions) from the switch.
2. If the motor fails to move, short the learning wires together (see above), and apply power to the motor with the rocker switch. The motor should move approximately six inches, stop and beep. Release the rocker switch and release the learning wires. Depress rocker switch in down direction. If the shade moves, proceed with the directions above —“Setting Limits for Dual-Range Switch Motors”.
3. If the motor has power but still fails to move in either direction after following Step 2, please contact MCD for assistance. Contact information can be found on the last page of this Manual.

### Troubleshooting Procedure for Remote Controlled Motor

NOTE: *The most typical problem for ALL powered shades is the loss of Set Limits. The shade motors will retain their Set-Limit memory when the coach's power supply is kept within a normal range of 11.0 to 13.6 volts. They will also retain their Set Limits if the power supply is cut off completely from the shade motor (0 volts). However, if power is gradually drained and falls below the lower limit of 11 volts, the motors could lose their electronic Set Limits and will require reprogramming once normal power has been restored.*

1. Verify the voltage applied to the motor. Voltage should be between 11.0 and 13.6 volts DC. The positive wire is identified by large lines on the insulation. If voltage is low, charge the chassis/coach batteries and retry motor operation. Voltage can be verified in the disconnect/butt splices in the shade motor wiring leads.

Verify positive and negative voltage (both up and down directions) from the switch.

2. Does the remote control correctly operate other shades? If not, replace the remote control battery/batteries. Be certain that the batteries are inserted correctly.
3. Verify correct shade operation with the remote controller.
4. If shade fails to move, attempt to reset motor by shorting learning wires together. The motor should beep.
5. If the motor does not beep, verify power to motor. If power is not present, correct the power problem.
6. Short the learning wires together for two long beeps and three short beeps. Repeat two more times.
7. Note: Resetting the motor only removes the link between it and the remote controller(s). The motor will still retain upper and lower set-limits and correct motor direction.
8. Refer to the proper section of this Manual and follow the directions to link the shade motor to your model of remote controller.
9. If a shade motor fails to link to the remote controller, try to use a spare button on your 14-Channel or 2-Channel remote controller. If the motor links to the remote controller on an alternate button, please contact MCD for assistance.
10. If the motor will not program to any button on any remote controller, the batteries have been replaced, and correct voltage has been verified, please contact MCD for assistance.

Please contact us with any questions.

800-804-1757

[info@mcdinnovations.com](mailto:info@mcdinnovations.com)

NOTE: If the windshield shade fails to move and it is in the down position and you need to drive the coach, you can roll the shade onto itself starting at the bottom of the shade. Continue to roll it up to the shade rollers and use some form of tie (bungee, rope, strap) to attach the shade material to the upper assembly. **DO NOT ROLL THE SHADE ONTO THE ROLLER TUBE MANUALLY.** This can cause severe damage to the motor and gearbox and will not be covered by warranty. Call MCD Innovations for help to resolve this issue.



## Limited Warranty, Getting Service, and Product Returns Policy

### MCD Statement of Limited Warranty

MCD Innovations (herein referred to as “MCD”), provides a one (1) year limited warranty against defects in materials and workmanship for all products manufactured by MCD and sold under the MCD name. MCD extends this Limited Warranty to the first retail purchaser and it applies only to the MCD products properly installed for the use intended by MCD. This Limited Warranty is not transferable.

This Limited Warranty does not apply if, in the sole judgment of MCD, the product fails due to damage from shipment, handling, storage, accident, abuse or misuse, improper installation, improper operation, or if the product has been used or maintained in a manner not conforming to MCD’s instructions and specifications, or has been modified in any way. Any repair or modification attempted or performed by anyone other than an MCD-approved agent under MCD’s specific guidance and instruction at the time of repair will cause this Limited Warranty to become void and of no further force or effect.

This Limited Warranty does not provide benefits for or apply to conditions caused by normal product wear and tear. It also does not apply to product damage caused by vehicle accident, fire, flood, wind, rain, lightening, or other acts of God.

IN ANY EVENT, MCD’S MAXIMUM LIABILITY UNDER THIS LIMITED WARRANTY IS LIMITED TO THE ORIGINAL PRODUCT PURCHASE PRICE FROM MCD. MCD will replace or repair, at our option, any defective product at no charge. A defective product shall be determined solely at our discretion. Installation, labor, delivery both ways, removal and reinstallation and their associated costs, tools, accessories, or components are not the responsibility of MCD. In no event shall MCD be liable for any special, indirect, incidental, or consequential damages, loss of revenues, profits, or opportunities arising out of or connected with this Limited Warranty or the MCD products, regardless of whether a claim is based on contract, tort, strict liability, or otherwise. Your sole remedy hereunder is limited to repair or replacement of the MCD product and in no event shall exceed the original MCD purchase price. You may have other rights under state law. NO PERSON OR ENTITY IS AUTHORIZED TO ALTER OR AMEND THIS LIMITED WARRANTY

## MCD Policy for Warranty & Out-of-Warranty Products

If any MCD product appears inoperable - whether covered by our Limited Warranty or not - a product return can often be avoided with a quick phone call to one of our Customer Support Technicians at 800-804-1757, or 972-548-1850. In the event that a product repair or return is necessary due to defects covered under our Limited Warranty policy, and for products no longer covered by warranty, the following procedure must be followed:

1. All returns must be pre-approved with a Return Authorization (RA) number. We cannot accept shipments without a Return Authorization. An RA number can be obtained by first contacting MCD Customer Support at 800-804-1757, or 972-548-1850, or [info@mcdinnovations.com](mailto:info@mcdinnovations.com).
2. MCD will troubleshoot the problem with you to determine if a component is defective. If a component is defective, MCD will issue an RA number and will ship the replacement part to you.
3. Once you receive the replacement part and if MCD requested return of the replaced part, securely package the returning part in the same packaging. We aren't responsible for shipping damage.
4. After securely packaging the return, send it to our address below. Clearly identify your RA number on the outside of the box. Include all contact information with name, address, phone number, email address, RA number, and any other information requested, inside of the box.
5. If your product is no longer covered under our Limited Warranty, or if, in MCD's sole opinion, the product needs repair due to damage, misuse, or other causes not covered under our Limited Warranty, we offer repair services for a fee. All repairs that are not covered under MCD's Limited Warranty and all related shipping expenses shall be the responsibility of the Customer. Repair prices for damaged product not covered by warranty shall be discussed with the Customer prior to issuing Return Authorization. Any unforeseen product repairs not disclosed to MCD or subsequently identified when the product is returned will be the responsibility of the Customer.
6. Any shipment received by MCD under an RA that was issued more than 30 days prior will be refused and returned to the Customer, freight collect.

## MCD Product Return & Restocking Fees

Custom products manufactured by MCD may not be returned for any reason except ordering or manufacturing errors that, in MCD's sole determination, were MCD's responsibility. Additionally, custom products that are in production, but have not shipped to the Customer, CANNOT be cancelled. All orders are final at the time of placing an order and Customer's receipt of an Order Confirmation, Sales Order number, or Shipping Date.

---

*As MCD continuously strives to improve our products and services, we reserve the right to change designs, specifications, features, pricing, program benefits, and other factors without notice. Such changes do not create an obligation to update or upgrade previous products, or incorporate any improvements into existing products and programs.*

**Please see our website for additional information and contact us with any questions. Thank you for your business. We appreciate you!**

*Page left intentionally blank*



**MCD Innovations  
3303 N. MCDonald St.  
McKinney, TX 75071**

**[www.mcdinnovations.com](http://www.mcdinnovations.com)**

***Proudly Conceived, Engineered and  
Manufactured in the USA***

**Please contact us with any questions  
800.804.1757  
972.548.1850  
972.542.4881 fax  
[info@mcdinnovations.com](mailto:info@mcdinnovations.com)**

©2014 MCD Innovations, All Rights Reserved

Ver 032514