

MIDI® STYLE BOLT-DOWN FUSE RATED 32V

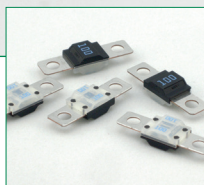

Also available:
Clear MIDI® version &
MIDI® one hole version



(transparent nylon composite cover / *not UL recognized)



Specifications

Interrupting Rating:	1000A @ 32 VDC
Voltage Rating:	32 VDC
Operating Temperature Range:	-40°C to + 125°C
Housing Material:	Heat Resistant 94-V0 Thermoplastic
Terminal:	Tin plated Copper
Mounting Torque M5:	4.5 Nm +/- 1Nm
Mounting Torque M6:	5.5-6.5 Nm +/- 1Nm
Complies with:	ISO 8820-5 UL 248 Special Purpose Fuses

Ordering Information













Part Number	Package Size	Mfg Location
M5 Version		
0498xxx.H	100	North America
0498xxx.M*	1000	North America
0498.xxx.M-CN*	1000	Asia
M6 Version		
0498xxx.MXM6*	1000	North America
0498.xxx.MXM6-CN*	1000	Asia
Clear MIDI® Version		
0498xxx.SXT	20	North America
0498xxx.MXT	1000	North America
One Hole Version		
0498xxx.MX1M5*	1000	North America
0498xxx.MX1M5-CN*	1000	Asia

* Materials manufactured in Asia are produced to the same specifications as materials manufactured in North America, and meets the same test requirements. Multiple production locations are for capacity expansion only.

Description

This MIDI® style fuse offers a bolt-on space saving fuse for high current wiring protection and provides time delay characteristics with “Diffusion Pill Technology”. The MIDI® was designed and patented by Littelfuse.

Ratings

Part Number	Current Rating	Housing Material Color	Typ. Voltage Drop Littelfuse max.	Cold Resistance	I²t
0498023._ ²	23 A		90 mV	3.43 mΩ	1,800 A²s
0498030._ ²	30 A		65 mV	2.06 mΩ	4,200 A²s
0498040._	40 A		65 mV	1.398 mΩ	10,000 A²s
0498050._	50 A		65 mV	1.025 mΩ	13,000 A²s
0498060._	60 A		68 mV	0.865 mΩ	21,700 A²s
0498070._	70 A		70 mV	0.72 mΩ	24,000 A²s
0498080._	80 A		58 mV	0.541 mΩ	24,600 A²s
0498100._	100 A		60 mV	0.457 mΩ	51,300 A²s
0498125._ ²	125 A		71 mV	0.394 mΩ	73,200 A²s
0498150._ ^{1,2}	150 A		77 mV	0.323 mΩ	81,900 A²s
0498175._ ^{1,2}	175A		77 mV	0.285 mΩ	100,000 A²s
0498200._ ^{1,2}	200A		77 mV	0.261 mΩ	125,000 A²s

MIDI® STYLE BOLT-DOWN FUSE RATED 32V



Temperature Derating Curve

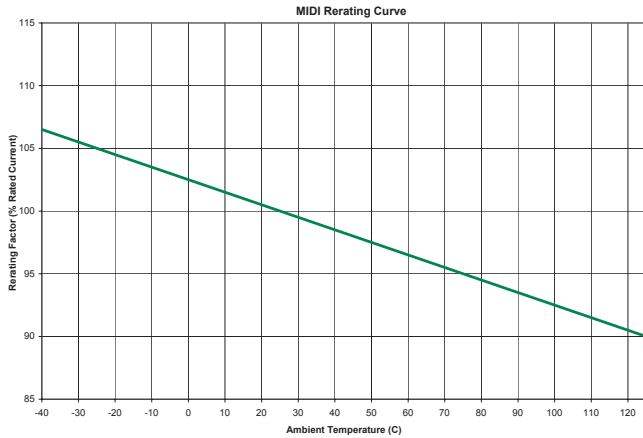

Time-Current Characteristic Curves

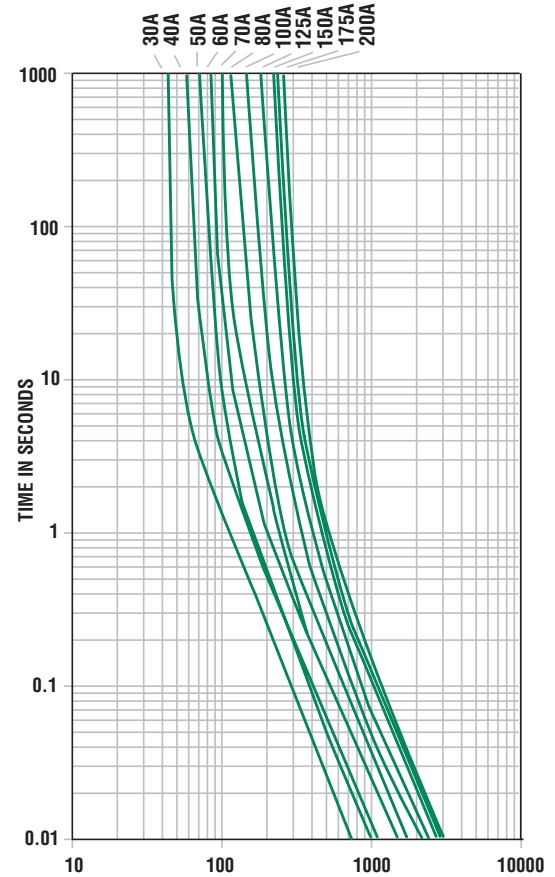

Dimensions

Dimensions in mm

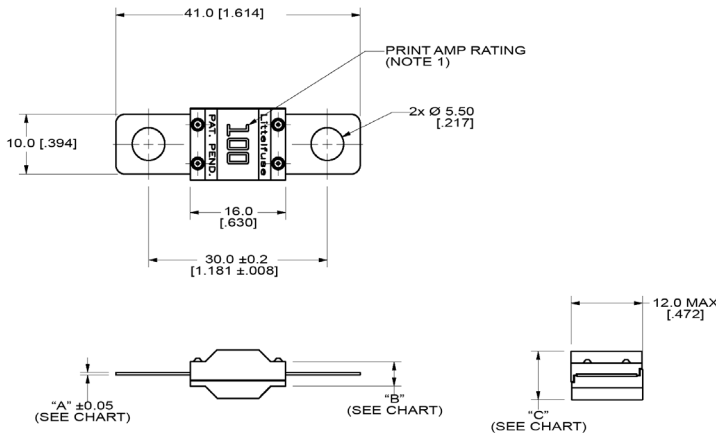

Part Number	"A" mm (inch)	"B" mm (inch)	"C" mm (inch)
0498030_	0.41 (0.016)	4.0 (0.157)	8.0 (0.315)
0498040_	0.41 (0.016)	4.0 (0.157)	8.0 (0.315)
0498050_	0.41 (0.016)	4.0 (0.157)	8.0 (0.315)
0498060_	0.41 (0.016)	4.0 (0.157)	8.0 (0.315)
0498070_	0.41 (0.016)	4.0 (0.157)	8.0 (0.315)
0498080_	0.41 (0.016)	4.0 (0.157)	8.0 (0.315)
0498100_	0.63 (0.025)	4.3 (0.169)	8.3 (0.327)
0498125_	0.63 (0.025)	4.3 (0.169)	8.3 (0.327)
0498150_	0.63 (0.025)	4.3 (0.169)	8.3 (0.327)
0498175_	0.63 (0.025)	4.3 (0.169)	8.3 (0.327)
0498200_	0.63 (0.025)	4.3 (0.169)	8.3 (0.327)

Time-Current Characteristics

% of Rating	Opening Time Min / Max (s)	
	30-125A	150-200A
75	- / -	360,000 s / -
100	360,000 s / -	- / -
110	14,400 s / -	- / -
150	90 s / 3,600 s	- / -
200	3 s / 100 s	1 s / 15 s
300	0.3 s / 3 s	- / -
350	- / -	0.3 s / 5 s
500	0.1 s / 1 s	0.1 s / 1 s

Mouser Electronics

Authorized Distributor

Click to View Pricing, Inventory, Delivery & Lifecycle Information:

Littelfuse:

[0498030.SXT](#) [0498050.SXT](#) [0498070.SXT](#) [04980918ZXT](#) [0498150.SXT](#) [0498125.SXT](#) [0498080.SXT](#)
[0498040.SXT](#) [0498175.SXT](#) [0498100.SXT](#) [0498060.SXT](#) [0498200.SXT](#)