

LAUREATE SERIES

SCALE / WEIGHT METER OWNERS MANUAL



LAUREL Electronics Inc.

3183-G Airway Ave, Costa Mesa, CA, 92626, USA

Tel: (714) 434-6131 • Fax: (714) 434-3766 • Website: www.laurels.com

1. ORDERING GUIDE

Configure a model number in this format: **LW20201SG1, CBL01**

LW Laureate scale / weight meter

Display Color

1 DPM with green LED

2 DPM with red LED

Power

0 85-264 Vac

1 10-48 Vdc or 12-32 Vac

Setpoint Output

0 None

1 Two 8A contact relays

2 Two solid state relays

Analog Output

0 None

1 4-20 mA, 0-10V, -10V to +10V

Digital Interface

0 None

1 RS232

2 RS485

4 RS485-Modbus

5 USB

6 USB-to-RS485 gateway

Input Type

Process Signals

(4-20 mA, 0-10V, etc.)

P 4-20 mA = 0-100.00

P1 Custom Scaling

Specify min signal & reading, max signal & reading. 10 Vdc excitation.

Strain Gauge, Potentiometer

(4-wire ratio)

SG 0-200 mV = 0-100.00

SG1 Custom Scaling

Specify min signal & reading, max signal & reading. Full-scale ranges 200 mV to 20V. 10 Vdc excitation.

Load Cells (6-wire ratio)

WM1 -99,999 to +99,999

Specify min input & reading, max signal & reading. Full-scale range 20 mV to 500 mV. 10 Vdc excitation.

Options & Accessories

BL Blank lens, no button pads

CBL01 RJ11-to-DB9 RS232 cable
Connects meter to PC com port.

CBL02 USB-to-DB9 adapter
For use with CBL01

CBL05 USB-cable
Type A male to Type B male.

IPC NEMA-4 panel cover

BOX1.... .. NEMA4 wall mount enclosure

BOX2.... .. BOX1 plus IPC

2. TABLE OF CONTENTS

1.	ORDERING GUIDE	2
2.	TABLE OF CONTENTS.....	3
3.	PRODUCT INTRODUCTION.....	4
4.	ADVANCED OPERATING FEATURES.....	5
5.	RECEIVING & UNPACKING	6
5.	SAFETY CONSIDERATIONS.....	6
7.	CONNECTOR WIRING INFORMATION	7
8.	MECHANICAL ASSEMBLY	9
9.	FRONT PANEL SETUP KEYS	11
10.	ENABLING & LOCKING OUT MENU ITEMS	13
11.	PROCESS & STRAIN INPUT JUMPERS	14
12.	LOAD CELL INPUT JUMPERS	15
13.	SCALE METER SETUP.....	16
14.	DUAL RELAY OUTPUT OPTION	21
15.	ANALOG OUTPUT OPTION	24
16.	SERIAL COMMUNICATION OPTIONS	25
17.	EXCITATION OUTPUT & POWER SUPPLY.....	30
18.	INSTRUMENT SETUP VIA PC.....	31
19.	SCALE METER CALIBRATION.....	34
20.	SCALE METER SPECIFICATIONS.....	35
21.	GLOSSARY OF TERMS.....	38
22.	WARRANTY	44

3. PRODUCT INTRODUCTION

The Scale Meter is a compact, inexpensive, and extremely accurate digital panel meter with special firmware for weighing applications. It is available with a load cell or a DC signal conditioner board.

The load cell signal conditioner board accepts full-scale ranges of ± 20 , ± 50 , ± 100 , ± 250 and ± 500 mV with 4 or 6-wire load cell hookup. With 4 wires, the scale meter operates in a ratiometric mode to eliminate errors due to power supply variations. With 6 wires, it also eliminates errors due to resistance of the excitation wires, thereby allowing long cable runs in changing temperature environments. The built-in, isolated excitation supply can power up to four 350-ohm load cells in parallel at 10 Vdc.

The DC signal conditioner board can be jumpered for ratiometric strain gauge voltage ranges ± 200 mV, ± 2 V or ± 20 V. It can be used with a 20 mV full scale strain gauge, but that output will only use 10% of the meter's most sensitive range.

Meter accuracy is 0.01% of full scale ± 2 counts. Custom curve linearization, available with an optional Extended main board, can extend the accuracy of actual load cells near the low and high ends of their ranges. It also allows high accuracy readings to be achieved with lower cost, less linear load cells.

The standard power supply is a switching model designed for universal AC power. A low-voltage supply is optional for power from 10-48V batteries or from 12-30 Vac. Both supplies provide an isolated 5, 10 or 24Vdc transducer excitation output.

The meter case conforms to the 1/8 DIN size standard. It is made of high impact, 94V-0 UL-rated plastic and is watertight to NEMA-4 (IP65) when panel mounted. Mounting is from the front of the panel and requires less than 110 mm behind the panel. Power and signal wiring is via removable plugs conforming to UL61010C safety standards. All output options are isolated from meter and power ground to 250 Vac.

Alarm or setpoint control is provided by an optional relay board with two Form C 8A contact relays or two Form A 130 mA solid state relays. The setpoints may be latching or non-latching, be energized above or below the setpoint, or operate in a fail-safe mode. The relays can operate from the filtered signal to reduce relay chatter or from the unfiltered signal for fastest response. Snubber circuits and a programmable relay switching time delay extend relay contact life.

An isolated analog output of 4-20 mA, 0-20 mA, 0-10V or -10 to +10V can be provided by an optional analog output board. The output is linearized to the display and can operate from the filtered or unfiltered signal input. It can be scaled via front panel pushbuttons or the meter's serial interface.

USB, RS232 or RS485 (2-wire half-duplex or 4-wire full-duplex) serial communications options are available with the Modbus RTU protocol or a simpler custom ASCII protocol. Modbus operation allows up to 247 digital addresses. Up to 32 devices can be connected to an RS485 line without a repeater. A USB-to-RS485 gateway boards allow a meter to be interfaced to a PC and to multiple meters on an RS485 network. Ethernet communications are not supported by the scale meter, but are supported by the closely related Laureate load cell meter.

Scale meter programming can be via the meter's front panel or a PC running Windows based Instrument Setup Software (serial interface option required).

4. ADVANCED OPERATING FEATURES

- **Setpoint offset.** The ON/OFF setpoint control action can be programmed to occur with a specified offset. For instance, if bags are to be filled to 100 lbs and the material delivery spout is known to hold and dispense an additional 2.5 lbs following shut-off, an offset of -2.5 lbs can be programmed. The setpoint can then be set to 100 lbs, and the filling valve will be automatically shut off when the measured weight reaches 97.5 lbs.
- **Dribble factor.** On/off setpoint control action can be programmed to occur with a specified offset. For instance, if bags are to be filled to 100 lbs and the material delivery spout is known to hold and dispense an additional 2.5 lbs following shut-off, an offset of -2.5 lbs can be programmed. The setpoint can then be set to 100 lbs, and the filling valve will be automatically shut off when the measured weight reaches 97.5 lbs.
- **Count-by function.** The weight meter can be programmed so that the display is rounded off to multiples of 1, 2, 5, 10, 20, 50, 100, 200, 500 or 1000. For example, if count-by 10 is selected, the meter will display 20 for an internal count of 15 to 24.
- **Fixed dummy right-hand zero.** The display can be shifted to the left for a fixed zero to the right, allowing values up to 999,990 to be displayed. This removes the ability to have decimal points.
- **Auto-zero function.** An auto-zero limit from 0 to 9 counts can be programmed to compensate for load cell drift. Whenever the meter comes to rest within that limit from zero, it will auto-zero. It will auto-tare to display zero with a slowly drifting input. Entering 0 disables auto-zero.

Two tare functions: auto-tare and manual tare. In auto-tare, a control input line is grounded by an external pushbutton. This causes the current weight, which is normally the empty weight of the container to be stored in memory as an offset. In manual tare, the tare value can be entered manually via the front panel or a computer. For instance, the tare value may be the stated empty weight of a truck or rail car. Pressing the Reset button on the front panel toggles the display between gross weight (total weight on the scale) and net weight (gross weight with tare subtracted).

5. RECEIVING & UNPACKING

Your scale meter was carefully tested and inspected prior to shipment. Should the meter be damaged in shipment, notify the freight carrier immediately. In the event the meter is not configured as ordered or the unit is inoperable, return it to the place of purchase for repair or replacement. Please include a detailed description of the problem.

6. SAFETY CONSIDERATIONS



Warning: Use of this equipment in a manner other than specified may impair the protection of the device and subject the user to a hazard. Visually inspect the unit for signs of damage. If the unit is damaged, do not attempt to operate.

Caution:

- This unit must be powered with AC (mains) from 85-264 Vac with the high voltage power supply option, or 12-32 Vac (10-48 Vdc) with the low voltage power supply option. Verify that the proper power option is installed for the power to be used. This meter has no AC (mains) switch. It will be in operation as soon as power is connected.
- The 85-264 Vac mains connector (P1 Pins 1-3) is colored Green to differentiate it from other input and output connectors. The 12-32 Vac (10-48 Vdc) mains connector is colored Black.
- Do not make signal wiring changes or connections when power is applied to the instrument. Make signal connections before power is applied. If reconnection is required, disconnect the AC (mains) power before such wiring is attempted.
- To prevent electrical or fire hazard, do not expose the instrument to excessive moisture.
- Do not operate the instrument in the presence of flammable gases or fumes; such an environment constitutes a definite safety hazard. This meter is designed to be mounted in a metal panel.
- Verify the panel cutout dimensions, and mount according to instructions.

Symbols used



Caution (refer to accompanying documents)



Caution, risk of electric shock.



Equipment protected throughout by double insulation or reinforced insulation.



Earth (ground) terminal.



Both direct and alternating current.

Operating environment:



The meter is Class II (double insulated) equipment designed for use in Pollution degree 2.



7. CONNECTOR WIRING INFORMATION

CONNECTORS

Connectors for signal and power are UL-rated screw-clamp terminal blocks that plug into mating jacks on the printed circuit board. Communication connectors are a single RJ11 plug for RS232, dual RJ11 plugs for RS485, dual RJ45 plugs for RS485 Modbus, or USB.

P1 - POWER AND DIGITAL CONTROLS

AC HI (+DC HI)	1	
AC NEUTRAL (DC RET)	2	
EARTH GROUND	3	

	CONTROL INPUT 2*	4	
	CONTROL INPUT 1*	5	
	DIGITAL GROUND	6	

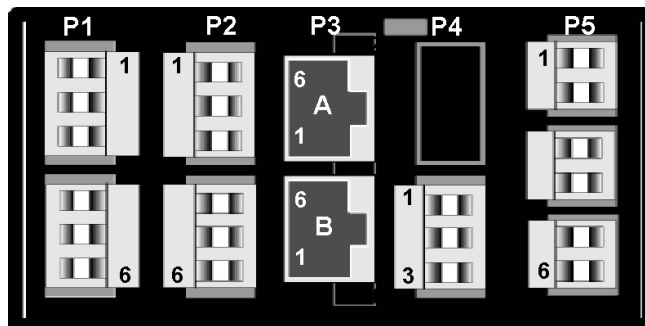

* Control inputs 1 & 2 of P1 are menu selectable.

Warning: Hazardous voltages may be present on pins 4, 5 & 6 of P1 since digital ground is tied to pin 3 of P5 (-Signal Input). Keep pin 3 close to earth ground to minimize common mode voltage or shock hazard at pins 4, 5 & 6 of P1.

P5 – SIGNAL INPUT

DC & PROCESS

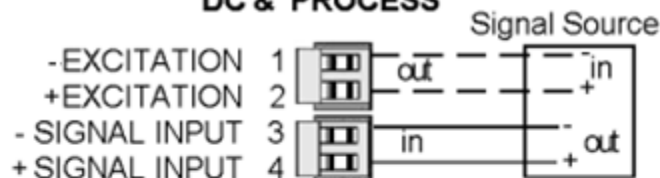

2 WIRE PROCESS TRANSMITTER

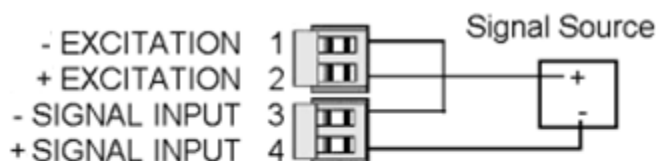

STRAIN GAUGE

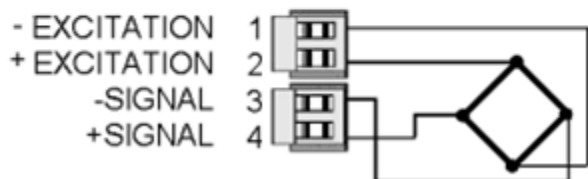

LOAD CELL METER

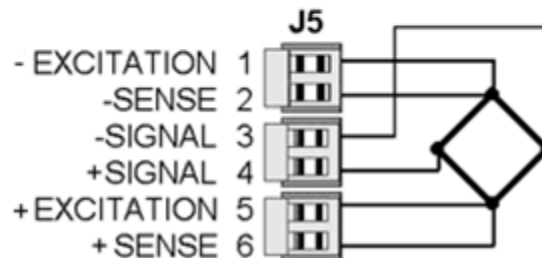

Excitation voltage can be jumpered for 5, 10 or 24 Vdc (Section 17).

P2 - SETPOINT CONTROLLER

DUAL MECHANICAL RELAY OUTPUTS



DUAL SOLID STATE RELAY OUTPUTS

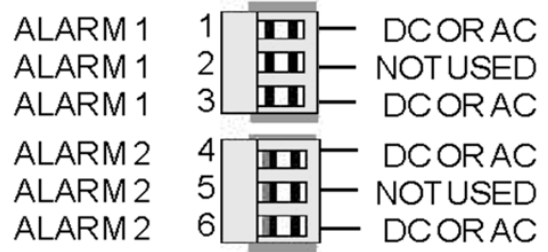

The analog output is sourcing. Do not put an external voltage source in series. Applying an external 24 Vdc source will burn out the analog output board.

P3 - SERIAL COMMUNICATIONS

RS232 INTERFACE

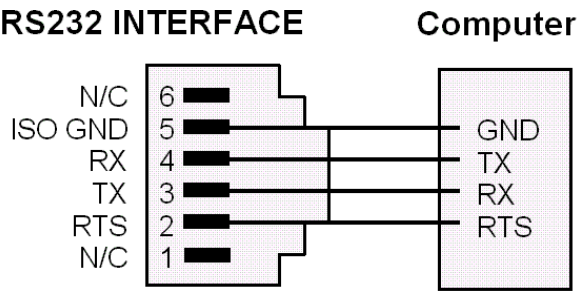

P4 - ANALOG OUTPUT

UNIPOLAR CONNECTIONS

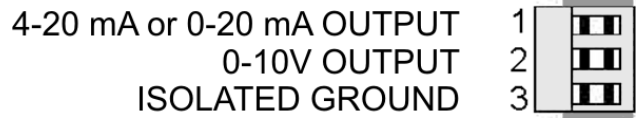

BIPOLAR CONNECTIONS

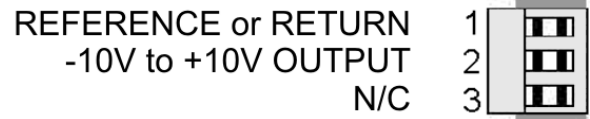

RS485, RJ11, FULL DUPLEX

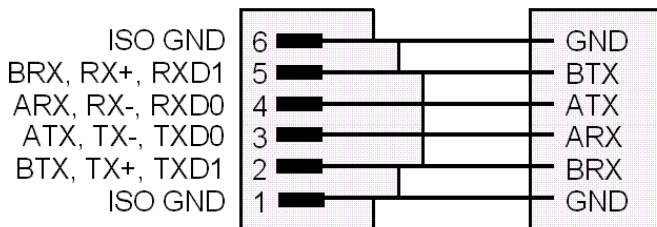

RS485, RJ11, HALF DUPLEX

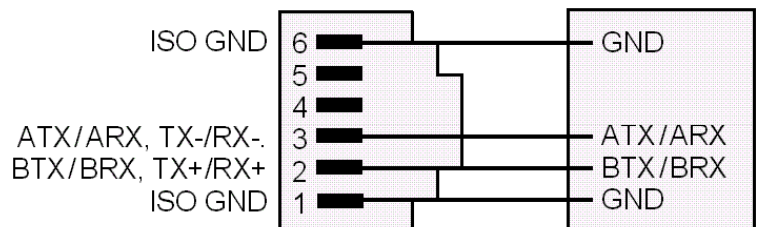

RS485, RJ45, FULL DUPLEX

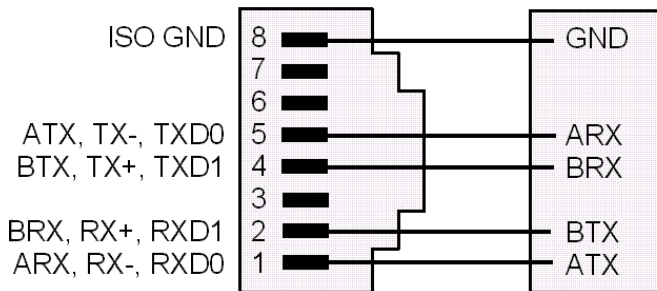

RS485, RJ45, HALF DUPLEX

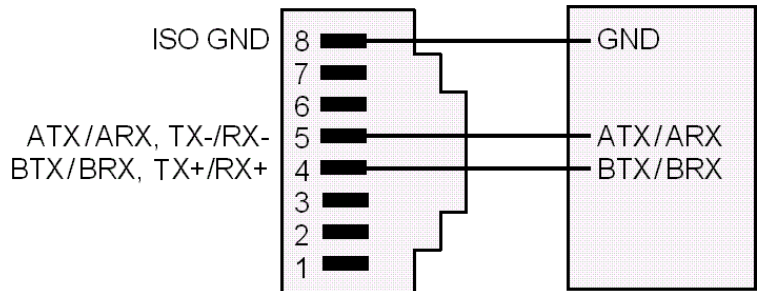

8. MECHANICAL ASSEMBLY

REMOVING THE REAR PANEL

First remove any connectors. Use one hand to press in the two sides of the rear of the case, and the other hand to press down the two protruding tab releases at the top of the rear panel (see figure below). This will unhook the rear panel from the case.

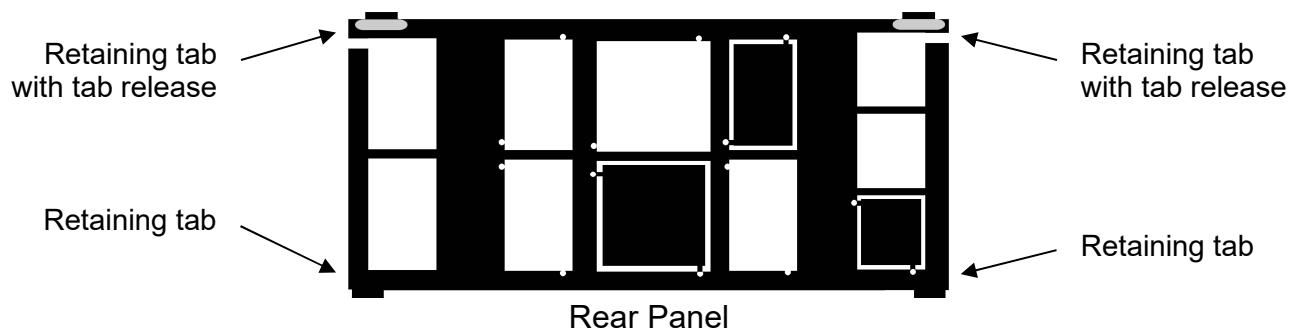

REMOVING THE ELECTRONICS & INSTALLING OPTION BOARDS

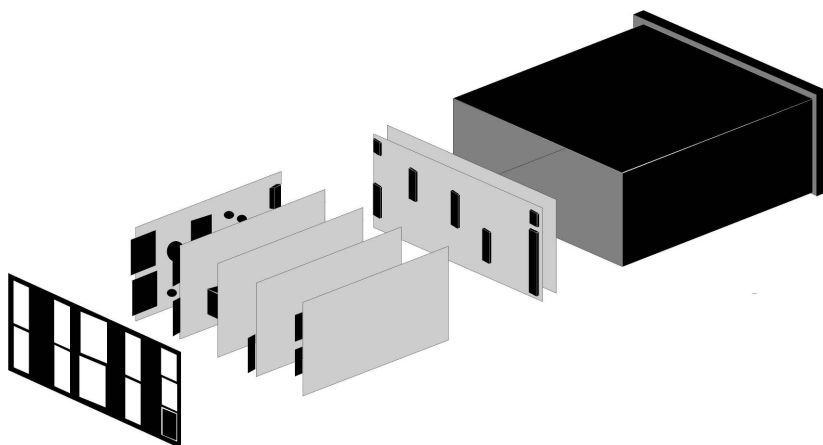

With the rear panel removed, the electronic assembly will easily slide out through the rear of the case.

Options boards plug into the main board at the front of the meter. These are plug-and-play and may be installed in the field. New boards will be recognized by the meter software for access to the appropriate menu items. You may need to remove rear panel knock-outs to fit new boards.

Note: When an option board is installed correctly, the top and bottom edges of the main board and option board are aligned. Misaligned boards will burn out the electronics.

Option Board	Main Board Plug	Rear Panel Jack
Power supply	P11	J1
Relay board	P12	J2
Serial interface board	P13	J3
Analog output board	P14	J4
Signal conditioner board	P15	J5

REASSEMBLING YOUR METER

Slide the electronics assembly back into the case until the display board is seated flush against the front of the case. Insert the bottom tabs of the rear panel into the case, and then carefully align the board connectors with the openings in the rear panel. Ensure that all option boards are properly aligned with the molded board retaining pins on the inside of the

rear panel. Once the rear panel is in place, reinstall the input/output screw clamp terminal plugs.

PANEL MOUNTING

Slide the meter into the 45 x 92 mm 1/8 DIN panel cutout. Ensure that the provided gasket is in place between the front of the panel and the back of the meter bezel.

The meter is secured by two pawls, each held by a screw. Turning a screw clockwise extends the pawl outward. Turning the screw clockwise further tightens it against the panel to secure the meter.

Turning a screw counterclockwise loosens the pawl and retracts it into its well. This allows the meter to be inserted into the panel cutout for installation, or to be removed from the panel cutout following installation.

Note: In no case should a screw be removed from its pawl. Doing so would cause the screw and pawl to fall off and likely get lost.

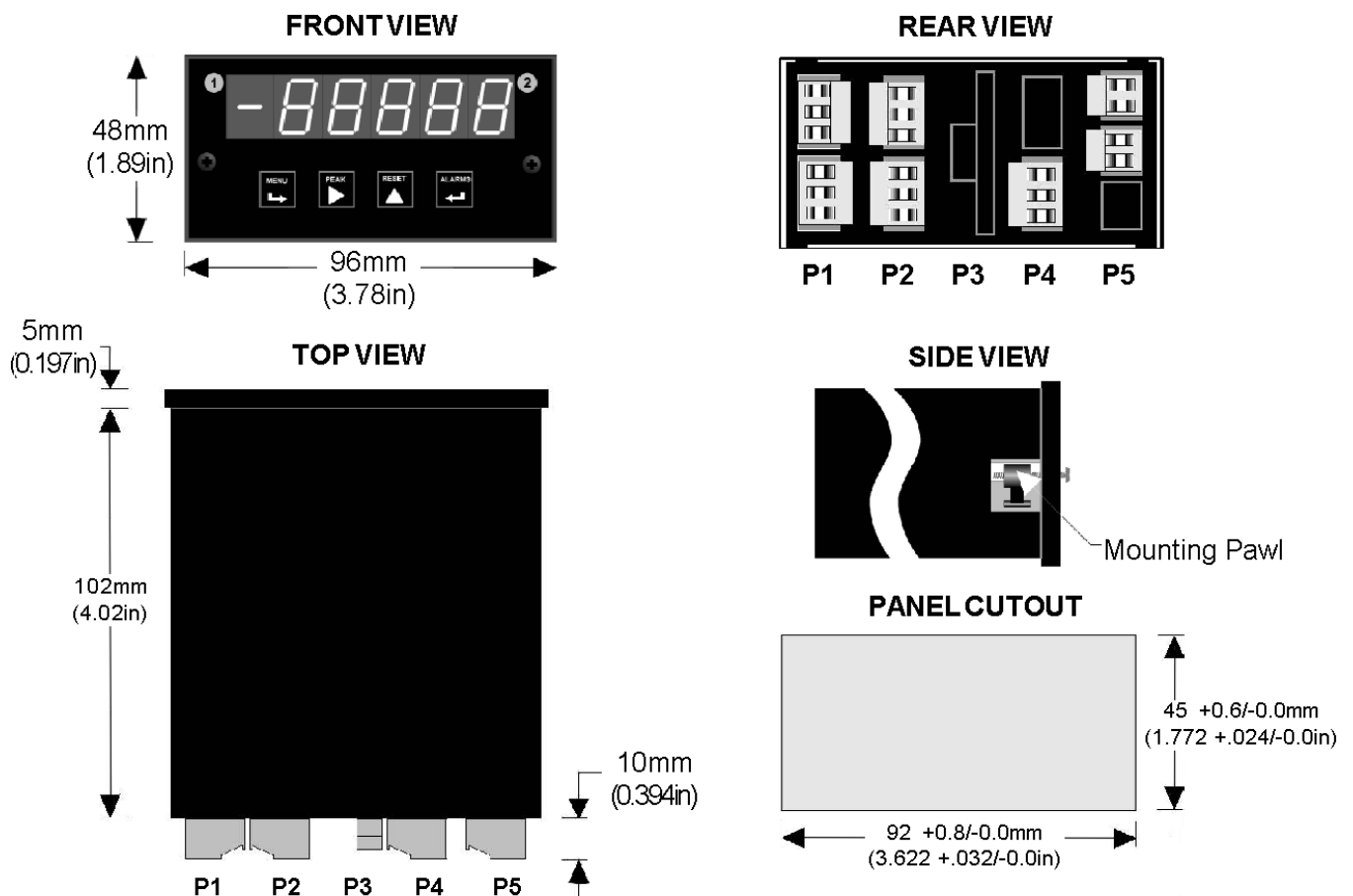
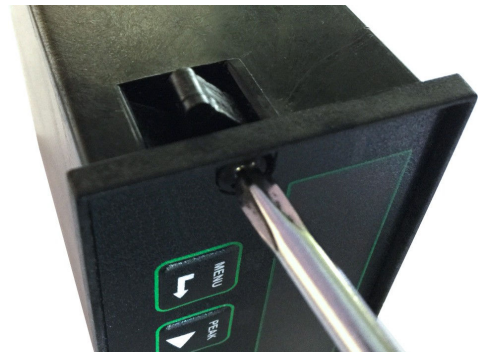

Dimensioned case drawings

9. FRONT PANEL SETUP KEYS

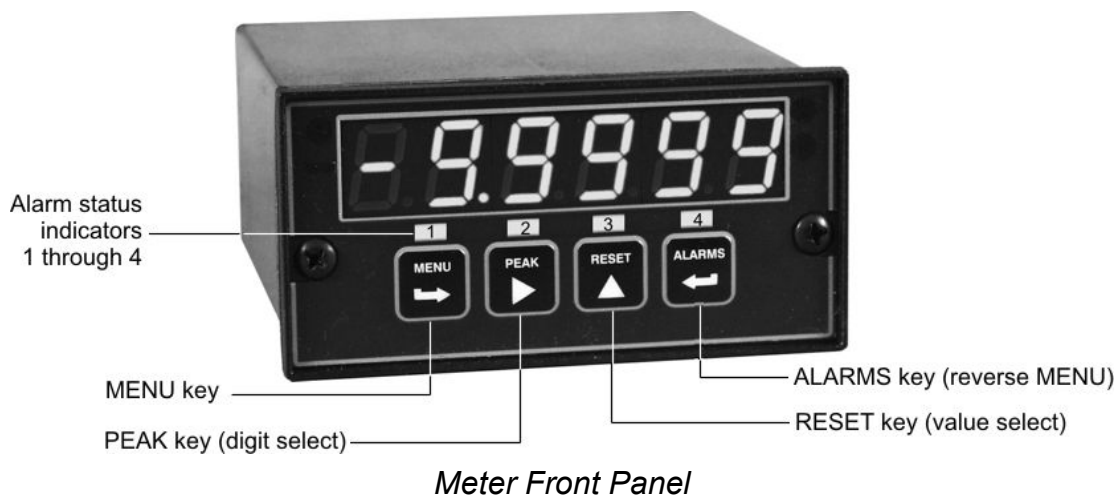

There are four front panel keys, which change function for the **Run Mode** and **Menu Mode**, effectively becoming eight keys. The keys are labeled with alphanumeric captions (MENU, PEAK, RESET, ALARMS) for the Run Mode and with symbols (➡ right arrow, ▶ right triangle, ▲ up triangle, ← left arrow) for the Menu Mode.

FRONT PANEL LOCKOUT

The Menu Mode will not work with most meters as received from the factory, since all menu items have been disabled in software and a lockout jumper is in place. That jumper needs to be removed for the Menu Mode to work, and menu items under *Loc 1*, *Loc 2* and *Loc 3* then need to be set to "0" via the front panel for these menu items to be unlocked See Section 10. The paragraphs below assume that all menu items have been unlocked.

MENU MODE KEY ACTION

In the Menu Mode, pressing a key momentarily advances to the next menu item. Holding down a key automatically advances through multiple menu items for fast menu navigation.

KEYS IN RUN MODE

MENU Key. Pressing *MENU* from the Run Mode enters the Menu Mode. Pressing *MENU* repeatedly will step the meter through the various menu items (if these have not been locked out) and then back to the Run Mode.



PEAK Key. Pressing *PEAK* normally causes the peak value of the input signal to be displayed. The peak display then blinks to differentiate it from the normal present value display. Pressing *PEAK* again returns the display to the present value. The *PEAK* key can also be programmed to display Valley, alternating Peak or Valley, or to Tare the reading to zero. When Peak or Valley is selected, periodic horizontal bars at the top of the display indicate Peak, and periodic horizontal bars at the bottom indicate Valley.

RESET Key. Pressing *RESET* with *PEAK* resets peak and valley values. Pressing *RESET* with *ALARMS* resets latched alarms. Pressing *RESET* with *MENU* performs a meter reset (same as power on). Meter reset can also be applied via a rear panel connect or a serial ASCII command.

ALARMS Key. Pressing *ALARMS* once displays the setpoint for Alarm 1. Pressing it again displays the setpoint for Alarm 2. Pressing it again returns to the present value.



KEYS IN MENU MODE



Right Arrow Key (MENU). Pressing  steps the meter through all menu items that have been enabled and then back to the Run Mode. With the DC signal conditioner board and no option boards, available menu items are **InPut**, **SEtuP**, **ConFG**, **FiLtr**, **dEc.Pt**, **SCALE**, **OFFSt**, **Loc 1**, **Loc 2**, **Loc 3**. If a change has been made to a menu item, that change is saved to non-volatile memory when the  key is pressed next, and **StoreE** is displayed briefly.



Right Triangle Key (Digit Select).

- Pressing  from the *InPut* menu brings up all meter functions available with the meter's signal conditioner. For the DC signal conditioner, these are **dC U**, **dC A** and **rAtio**.
- Pressing  from the *SEtuP*, *ConFG*, *FiLtr*, *SCALE*, *OFFSt*, *Loc 1*, *Loc 2* or *Loc 3* menus items sequentially selects digit positions 1 - 5, as indicated by a flashing digit: **00000**, **00000**, **00000**, **00000**, **00000**.
- Pressing  from the *dEC.Pt* menu item sequentially selects decimal point positions, which will flash: **d_ddd**, **dd_ddd**, **ddd_ddd**, **dddd_d**, **dddd_d**, **._ddd**.



Up Triangle Key (Value Select). Pressing  for a flashing item (digit position or decimal point position) will increment that item. Pressing *MENU* will save any changes.



Left Arrow Key (Reverse Menu). Pressing  has the same effect as the *MENU* key, except that menu items are brought up in reverse order.

10. ENABLING & LOCKING OUT MENU ITEMS

For security reasons and ease of meter operation, any or all menu items may be disabled or "locked out" so that they are no longer accessible from the front panel. Each function to be disabled can be set to "1" under menu headers *Loc 1-4*, while each function to be enabled can be set to "0." Access to the menu headers *Loc 1-4* can in turn be locked out by installing a hardware jumper on the power supply board. With the jumper installed, the operator only has access to previously enable menu items, not to the menu headers *Loc 1-4* and hence not to the menu items below. With the jumper removed, the operator has access to menu headers *Loc 1-4* and hence to the menu items below.

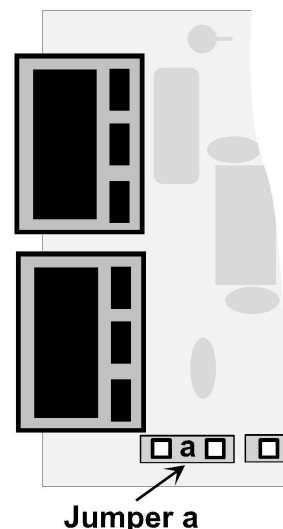

SETTING THE HARDWARE LOCKOUT JUMPER

To access the lockout jumper, remove the rear panel per Section 10 and locate jumper "a" in the lower portion of the power supply board next to the input connectors (see figure).

SETTING SOFTWARE LOCKOUTS

Set the lockout digit to "1" if you do not want the menu item to be changed by an operator, otherwise to "0".

Loc 1 **Loc 2** **Loc 3** **Loc 4**

Press the **➡** *MENU* key until *Loc 1*, *Loc 2*, *Loc 3* or *Loc 4* is displayed. **Note:** hardware lockout jumper "a" must be removed (see above).

0000
12345

Press **▲** to set the flashing digit to "0" to enable the menu item or to "1" to disable. Press *MENU* to enter. See the table to the right for the list of menu items that can be enabled or disabled.

1111

Press **▶** to display the lockout status, consisting of 1's and 0's. The left digit will flash. Press **▶** again to step to the next digit, which will flash.

Lockout Digits for Menu Items

Loc 1

- 2 – Net/Gross display (reset key)
- 3 – Input type selection
- 4 – Setup, config. & decimal point
- 5 – Count-by and auto-zero

Loc 2

- 2 – Filtering
- 3 – Scale, Lo In, Hi In
- 4 – Offset, Lo Rd, Hi Rd
- 5 – Tare

Loc 3

- 2 – Alarm setup
- 3 – Change alarm setpoints
- 4 – Analog output scaling
- 5 – Serial comm. config.

Loc 4

- 2 – View peak value
- 3 – View alarm setpoints
- 4 – Front panel function resets
- 5 – Front panel meter reset

11. PROCESS & STRAIN INPUT JUMPERS

Process and strain input scale meters utilize the DC signal conditioner board, which offers sensitivity to ± 200 mV and can operate in a ratiometric mode, which removes effects caused by variations in the excitation supply. This board needs to be configured via jumpers for the desired voltage or current range. All signal ranges are factory calibrated with calibration factors stored in EEPROM. The meter software recognizes the board and will bring up the appropriate menu items for it; however, it does not recognize the jumper settings. Please see further manual sections for relay output, analog output, communications, and transducer excitation output.

RANGE SELECTION VIA JUMPERS

Voltage Ranges	Jumpers		
FS Input	E1	E2	E3
± 200.00 mV	A	f	b
± 2.0000 V	A	f	a
± 20.000 V	B	h	b
± 200.00 V	B	h	a
± 300 V (UL)	B	g	a
± 600 V (not UL)	B	g	a

Current Ranges	Jumpers		
FS Input	E1	E2	E3
± 2.0000 mA	A	e, g	b
± 20.000 mA	A	d, g	b
± 200.00 mA	A	c, g	b
± 5.000 A	A	a, b, g	b

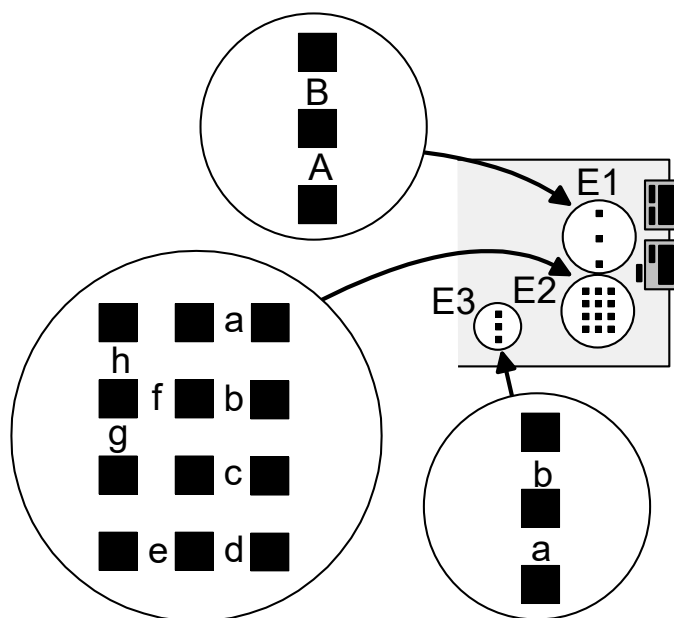

1. Letters indicate jumper position. Jumpers are installed on pins adjacent to letters.
2. Use 5 mm (0.2") jumpers for locations designated by a capital letter.
3. Use 2.5 mm (0.1") jumpers for locations designated by a lower case letter.
4. Store spare jumpers on an unused jumper post not associated with a capital letter.

SCALE & OFFSET SETUP

For process, strain, and load cell scale meters, scaling is normally set up from the front panel using the \blacktriangleright and \blacktriangle keys, but can also be set up via RS232/485 using PC-compatible Instrument Setup software (available at no charge). The meter allows three scaling methods to be selected: 1) Scale & Offset method, 2) Coordinates of 2 Points method, or 3) Reading Coordinates of 2 Points method. Only menu items applicable to the selected method will be presented. Please see the Glossary for an explanation of each method.

12. LOAD CELL INPUT JUMPERS

Load cell scale meters utilize the load cell signal conditioner board, which offers sensitivity to ± 20 mV full scale and 4- or 6-wire load cell connection. This board needs to be configured via jumpers for the desired voltage range. All signal ranges are factory calibrated with calibration factors stored in EEPROM. The meter software recognizes the board and will bring up the appropriate menu items for it; however, it does not recognize the jumper settings. Please see further manual sections for relay output, analog output, communications, and transducer excitation output.

RANGE SELECTION VIA JUMPERS

Ranges & Display with Scale Factor = 1

Input	Jumpers	Full scale display
± 20 mV	e	± 20000
± 50 mV	a	± 50000
± 100 mV	b	± 10000
± 250 mV	c	± 25000
± 500 mV	d	± 50000

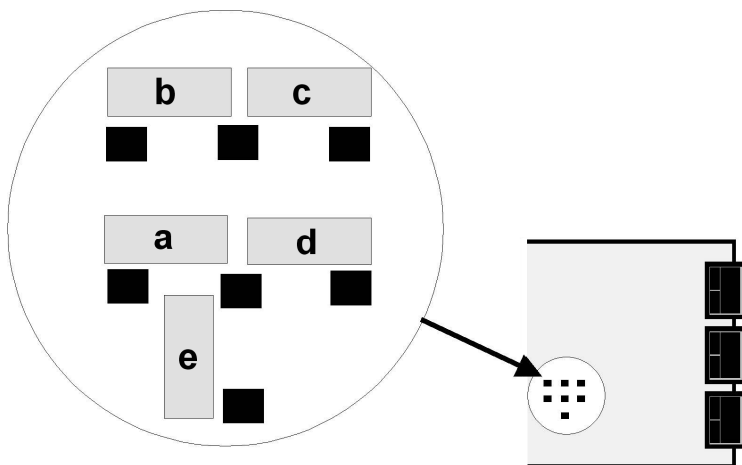

- Notes**
1. See Section 17 to select 10V excitation.
 2. Jumpers are 2.5 mm (0.1 in).
 3. Store spare jumpers on an unused jumper post.

SCALE & OFFSET SETUP

For load cell scale meters, scaling is normally set up from the front panel using the **▶** and **▲** keys, but can also be set up via RS232/485 using special PC-compatible Instrument Setup software (available at no charge). The meter allows three scaling methods to be selected: 1) Scale & Offset method, 2) Coordinates of 2 Points method, or 3) Reading Coordinates of 2 Points method. Only menu items applicable to the selected method will be presented. Please see the Glossary for an explanation of each method.

13. SCALE METER SETUP

When the *Reading Coordinates of 2 Points* scaling method is selected under **ConFG**, the four menu items below will appear ahead of all other menu items when the **MENU** or **→** key is first pressed from the run mode. This scaling method applies a straight line fit between two points, which are determined from actual transducer signals and the desired corresponding meter readings. A low signal, such as the output of a load cell at zero weight, and a high signal, such as the output of the same load cell at a known high weight, are applied to the meter. The desired corresponding low and high readings are then entered from the front panel. The meter then applies straight line fit between the high and low calibration points. This scaling method has the advantage of calibrating the transducer and meter as a system. The actual voltage or current at either point does not need to be known. This method is ideal for process and load cell scale meters, which require zero and span adjustment.



The other two scaling methods, namely scale and offset method and coordinates of 2 points method, are selectable under **SEtuP** when **ConFG**, digit 2 is set to 0.



The programming example below is for *Reading Coordinates of 2 Points* scaling for a scale meter used with a 4-20 mA load cell transducer for 0-100 lbs. Decimal points are set separately using the *dEC.Pt* menu.

MENU → Press Menu Select Key	PEAK ▶ Press Digit Select Key	RESET ▲ Press Value Select Key
Lo In Apply low signal input (e.g., transducer output for 0 psi).	40.21 Press ▶ to display reading at low signal input (e.g., 4.021 mA).	40.21 Press ▲ to store low reading.
Hi In Apply high signal input (e.g., transducer output for known 100.00 psi source).	200.94 Press ▶ to display reading at high signal input (e.g., 20.094 mA).	200.94 Press ▲ to store high reading.
Lo rd Mode to enter desired low reading (e.g., 0.00).	000.00 000.00 000.00 000.00 000.00 Select digit to flash.	0.00 Select 9 thru 9 for flashing first digit, 0 thru 9 for other flashing digits.
Hi rd Mode to enter desired high reading (e.g., 100.00).	000.00 000.00 000.00 000.00 000.00 Select digit to flash.	100.00 Select 9 thru 9 for flashing first digit, 0 thru 9 for other flashing digits.

OTHER KEYSTROKES FOR SCALE METER SETUP

**If the *MENU*  key does not work, see Section 10 "Enabling & Locking Out Menu Items."

 MENU Press Menu Select Key	 PEAK Press Digit Select Key	 RESET Press Value Select Key																																																																			
InPut DC signal conditioner board	dC U DC Volts	0.2U 2.0U 20.0U 200.0U 600.0U 0.2, 2, 20, 200, 660V FS																																																																			
	dC A DC Amps	2.0A 20.0A 200.0A 5.0A 0.2, 20, 200 mA, 5A FS																																																																			
	rAtio Strain gauge & ratio	0.2U 2.0U 20.0U 0.2, 2, 20V FS.																																																																			
InPut Load cell signal conditioner board	Strn Strain or ratiometric	20.0 50.0 100.0 250.0 500.0 20, 50, 100, 250, 500 mV FS voltage																																																																			
	dC u DC millivolts	20.0 50.0 100.0 250.0 500.0 20, 50, 100, 250, 500 mV FS voltage																																																																			
SEtUP Meter Setup	00000 Dummy right-hand zero for large numbers	0 No dummy zero (display to 99999) 1 Dummy zero (display to 999990) (removes decimal points)																																																																			
	00000 Power line frequency	0 Noise minimized for 60 Hz 1 Noise minimized for 50 Hz																																																																			
	00000 Peak Key Action	0 Display peak 1 Tare action																																																																			
	00000 Scaling method	0 Scale and offset method 1 Coordinates of 2 points method <u>Reading</u> Coordinates of 2 points method is selected by ConFG digit 2.																																																																			
	00000 Control inputs 1 & 2 or both: True = logic 1 (0V or tied to digital ground) False = logic 0 (5V or open)	<table border="0"> <thead> <tr> <th></th> <th><u>Input 1</u></th> <th><u>Input 2</u></th> <th><u>Both 1 & 2</u></th> </tr> </thead> <tbody> <tr><td>0</td><td>Meter Reset</td><td>Meter Hold</td><td>Meter Reset</td></tr> <tr><td>1</td><td>Funct Reset</td><td>Peak Displ</td><td>Meter Reset</td></tr> <tr><td>2</td><td>Meter Hold</td><td>Peak Displ</td><td>Funct Reset</td></tr> <tr><td>3</td><td>Meter Hold</td><td>Tare Action</td><td>Tare Action</td></tr> <tr><td>4</td><td>Peak Disp</td><td>Tare Action</td><td>Funct Reset</td></tr> <tr><td>5</td><td>Meter Reset</td><td>Tare Action</td><td>Meter Reset</td></tr> <tr><td>6</td><td>Funct Reset</td><td>Tare Action</td><td>Meter Reset</td></tr> <tr><td>7</td><td>Tare Reset</td><td>Tare Action</td><td>Meter Reset</td></tr> <tr><td>8</td><td>Displ Blank</td><td>Tare Action</td><td>Meter Reset</td></tr> <tr><td>9</td><td>Meter Reset</td><td>Displ Blank</td><td>Meter Reset</td></tr> <tr><td>A</td><td>Funct Reset</td><td>Displ Blank</td><td>Meter Reset</td></tr> <tr><td>B</td><td>Displ Item</td><td>Tare Action</td><td>Tare Action</td></tr> <tr><td>C</td><td>Displ Item</td><td>Displ Blank</td><td>Funct Reset</td></tr> <tr><td>D</td><td>Meter Reset</td><td>Displ Item</td><td>Meter Reset</td></tr> <tr><td>E</td><td>Funct Reset</td><td>Displ Item</td><td>Meter Reset</td></tr> <tr><td>F</td><td>Meter Hold</td><td>Displ Item</td><td>Meter Reset</td></tr> </tbody> </table>		<u>Input 1</u>	<u>Input 2</u>	<u>Both 1 & 2</u>	0	Meter Reset	Meter Hold	Meter Reset	1	Funct Reset	Peak Displ	Meter Reset	2	Meter Hold	Peak Displ	Funct Reset	3	Meter Hold	Tare Action	Tare Action	4	Peak Disp	Tare Action	Funct Reset	5	Meter Reset	Tare Action	Meter Reset	6	Funct Reset	Tare Action	Meter Reset	7	Tare Reset	Tare Action	Meter Reset	8	Displ Blank	Tare Action	Meter Reset	9	Meter Reset	Displ Blank	Meter Reset	A	Funct Reset	Displ Blank	Meter Reset	B	Displ Item	Tare Action	Tare Action	C	Displ Item	Displ Blank	Funct Reset	D	Meter Reset	Displ Item	Meter Reset	E	Funct Reset	Displ Item	Meter Reset	F	Meter Hold	Displ Item
	<u>Input 1</u>	<u>Input 2</u>	<u>Both 1 & 2</u>																																																																		
0	Meter Reset	Meter Hold	Meter Reset																																																																		
1	Funct Reset	Peak Displ	Meter Reset																																																																		
2	Meter Hold	Peak Displ	Funct Reset																																																																		
3	Meter Hold	Tare Action	Tare Action																																																																		
4	Peak Disp	Tare Action	Funct Reset																																																																		
5	Meter Reset	Tare Action	Meter Reset																																																																		
6	Funct Reset	Tare Action	Meter Reset																																																																		
7	Tare Reset	Tare Action	Meter Reset																																																																		
8	Displ Blank	Tare Action	Meter Reset																																																																		
9	Meter Reset	Displ Blank	Meter Reset																																																																		
A	Funct Reset	Displ Blank	Meter Reset																																																																		
B	Displ Item	Tare Action	Tare Action																																																																		
C	Displ Item	Displ Blank	Funct Reset																																																																		
D	Meter Reset	Displ Item	Meter Reset																																																																		
E	Funct Reset	Displ Item	Meter Reset																																																																		
F	Meter Hold	Displ Item	Meter Reset																																																																		

MENU  <i>Press Menu Select Key</i>	PEAK  <i>Press Digit Select Key</i>	RESET  <i>Press Value Select Key</i>
ConFG Meter Configuration	00000 Negative readings	0 Allow negative readings 1 Disallow negative readings
	00000 Setup method	0 Setup method selected by SEtUP, digit 4 1 <u>Reading</u> coordinates of 2 points method
	00000 Dribble function	0 Dribble enabled 1 Dribble disabled
	00000 Peak key action	0 Peak of net value 1 Peak of Gross value
	00000 Adaptive filtering	0 Enable adaptive filtering 1 Disable adaptive filtering
Count Count-by or Auto-zero function	00 Count by (see Glossary)	0 Count by 1 5 Count by 50 1 Count by 2 6 Count by 100 2 Count by 5 7 Count by 200 3 Count by 10 8 Count by 500 4 Count by 20 9 Count by 1000
	00 Auto-zero (see Glossary)	0 No auto-zero 5 ± 1 count 1 ± 2 counts 6 ± 3 counts 2 ± 4 counts 7 ± 5 counts 3 ± 6 counts 7 ± 7 counts 4 ± 8 counts 9 ± 9 counts
FiLtr Filtering	00000 Alarm filtering	0 Unfiltered output 1 Filtered output
	00000 Peak & Valley filtering	0 Unfiltered Peak & Valley 1 Filtered Peak & Valley
	00000 Display filtering	0 Display batch average every 16 readings 1 Display filtered signal
	00000 Adaptive filter threshold	0 Low adaptive filter threshold level 1 High adaptive filter threshold level

FiLtr Filtering (continued)	00000 Input signal filtering. Can be applied to display, setpoint, analog output, data output.	0 Autofilter Readings 1 Batch avg 16 <u>60 Hz</u> <u>50 Hz</u> 2 Moving avg .07 s .08 s 3 Moving avg .14 .16 4 Moving avg .28 .34 5 Moving avg .57 .68 6 Moving avg 1.13 1.36 7 Moving avg 2.27 2.72 8 Moving avg 4.53 5.44 9 Moving avg 9.06 10.88 A Moving avg 18.1 21.7 B Moving avg 36.2 43.4 C Moving avg 72.5 85 D Moving avg 145 174 E Moving avg 290 348 F No filter
dEc.Pt Not for dummy zero	d_ddd Decimal point flashes.	d_ddd dd_ddd ddd_dd dddd_d dddd_ _dddd Press ▲ to shift the decimal point.
Scaling method "Scale and Offset" if selected under SEtUP		
SCALE Scale factor	0.0000 0.0000 0.0000 0.0000 0.0000 0.0000 Select digit to flash.	Select -9 thru 9 for flashing first digit, 0 thru 9 for other flashing digits. Select decimal point location when decimal point is flashing.
OFFst Offset value	0.0000 0.0000 0.0000 0.0000 0.0000 Select digit to flash.	Select -9 thru 9 for flashing first digit, 0 thru 9 for other flashing digits. Decimal point location is selected by dEC.Pt .
Scaling method "Coordinates of 2 points" if selected under SEtUP . Appears before InPut .		
Lo In Low signal input.	0.0000 0.0000 0.0000 0.0000 0.0000 Select digit to flash.	Select -9 thru 9 for flashing first digit, 0 thru 9 for other flashing digits. Decimal point is set by input range chosen.
Lo rd Desired reading at Lo In.	0.0000 0.0000 0.0000 0.0000 0.0000 Select digit to flash.	Select -9 thru 9 for flashing first digit, 0 thru 9 for other flashing digits. Decimal point is set by dEC.Pt .
Hi In High signal input.	0.0000 0.0000 0.0000 0.0000 0.0000 Select digit to flash.	Select -9 thru 9 for flashing first digit, 0 thru 9 for other flashing digits. Decimal point is set by input range chosen.
Hi rd Desired reading at Hi In.	0.0000 0.0000 0.0000 0.0000 0.0000 Select digit to flash.	Select -9 thru 9 for flashing first digit, 0 thru 9 for other flashing digits. Decimal point is set by dEC.Pt .
tArE Tare value	0.0000 0.0000 0.0000 0.0000 0.0000 Select digit to flash.	Select -9 thru 9 for flashing first digit, 0 thru 9 for other flashing digits. Decimal point location is selected by dEC.Pt .

Option board dependent menu items
ALSEt SP1 d SP2 d Menu items related to alarm setup . These will only appear if a relay board is detected. If so, please see Section 14.
AnSEt An Lo An Hi Menu items related to analog output setup . These will only appear if an analog output board is detected. If so, see Section 15.
SER 1 SER 2 SER 3 SER 4 Addr Menu items related to serial communications . These will only appear if an RS232 or RS485 I/O board is detected. If so, see Section 16.
Menu lockout items
Loc 1 Loc 2 Loc 3 Loc 4 Menu items used to enable or lock out (hide) other menu items. Loc menu items may in turn be locked out by a hardware jumper. Please see Section 10.

* Scaling method 2, "Reading Coordinates of 2 Points Scaling Method," will appear before all other Menu items, including **InPut**. Decimal point is set by **dEC.Pt**.

14. DUAL RELAY OUTPUT OPTION



An optional relay board may be installed in the scale meter main board at plug position P2, adjacent to the power supply board. This board is available in two versions: 2 mechanical relays or 2 solid state relays. Once installed, the relay board is recognized by the meter software and PC-based Instrument Setup software, which will bring up the appropriate menu items for the board type. These menu items will only be brought up if a relay board is detected. Both relay boards offer a choice of operating modes: Off or On in alarm mode; latched or non-latched; alarm high, low or disabled; alarms on net or gross weight; and time delay to alarm.





KEYSTROKES FOR SETPOINT SETUP











If the *MENU* key does not work, see Section 10 “Enabling & Locking Out Menu Items.”

Press Menu Select Key	Press Digit Select Key	Press Value Select Key																										
<p>ALSEt Alarm Setup for relays 1 & 2 if detected.</p> <p>Press until ALSEt is displayed.</p>	<p>00000 Relay state when alarm is active.</p>	<table style="width: 100%; border: none;"> <tr><td style="border: none;">0</td><td style="border: none;">Relay 1 On</td><td style="border: none;">Relay 2 On</td></tr> <tr><td style="border: none;">1</td><td style="border: none;">Relay 1 Off</td><td style="border: none;">Relay 2 On</td></tr> <tr><td style="border: none;">2</td><td style="border: none;">Relay 1 On</td><td style="border: none;">Relay 2 Off</td></tr> <tr><td style="border: none;">3</td><td style="border: none;">Relay 1 Off</td><td style="border: none;">Relay 2 Off</td></tr> </table>	0	Relay 1 On	Relay 2 On	1	Relay 1 Off	Relay 2 On	2	Relay 1 On	Relay 2 Off	3	Relay 1 Off	Relay 2 Off														
	0	Relay 1 On	Relay 2 On																									
	1	Relay 1 Off	Relay 2 On																									
	2	Relay 1 On	Relay 2 Off																									
3	Relay 1 Off	Relay 2 Off																										
<p>00000 Alarm latching or non-latching.</p>	<table style="width: 100%; border: none;"> <tr><td style="border: none;">0</td><td style="border: none;">AL1 non-latching</td><td style="border: none;">AL2 non-latching</td></tr> <tr><td style="border: none;">1</td><td style="border: none;">AL1 latching</td><td style="border: none;">AL2 non-latching</td></tr> <tr><td style="border: none;">2</td><td style="border: none;">AL1 non-latching</td><td style="border: none;">AL2 latching</td></tr> <tr><td style="border: none;">3</td><td style="border: none;">AL1 latching</td><td style="border: none;">AL2 latching</td></tr> </table>	0	AL1 non-latching	AL2 non-latching	1	AL1 latching	AL2 non-latching	2	AL1 non-latching	AL2 latching	3	AL1 latching	AL2 latching															
0	AL1 non-latching	AL2 non-latching																										
1	AL1 latching	AL2 non-latching																										
2	AL1 non-latching	AL2 latching																										
3	AL1 latching	AL2 latching																										
<p>00000 Alarms high, low, or disabled.</p>	<table style="width: 100%; border: none;"> <tr><td style="border: none;">0</td><td style="border: none;">AL1 hi active</td><td style="border: none;">AL2 hi active</td></tr> <tr><td style="border: none;">1</td><td style="border: none;">AL1 lo active</td><td style="border: none;">AL2 hi active</td></tr> <tr><td style="border: none;">2</td><td style="border: none;">AL1 disabled</td><td style="border: none;">AL2 hi active</td></tr> <tr><td style="border: none;">3</td><td style="border: none;">AL1 hi active</td><td style="border: none;">AL2 lo active</td></tr> <tr><td style="border: none;">4</td><td style="border: none;">AL1 lo active</td><td style="border: none;">AL2 lo active</td></tr> <tr><td style="border: none;">5</td><td style="border: none;">AL1 disabled</td><td style="border: none;">AL2 lo active</td></tr> <tr><td style="border: none;">6</td><td style="border: none;">AL1 hi active</td><td style="border: none;">AL2 disabled</td></tr> <tr><td style="border: none;">7</td><td style="border: none;">AL1 lo active</td><td style="border: none;">AL2 disabled</td></tr> <tr><td style="border: none;">8</td><td style="border: none;">AL1 disabled</td><td style="border: none;">AL2 disabled</td></tr> </table>	0	AL1 hi active	AL2 hi active	1	AL1 lo active	AL2 hi active	2	AL1 disabled	AL2 hi active	3	AL1 hi active	AL2 lo active	4	AL1 lo active	AL2 lo active	5	AL1 disabled	AL2 lo active	6	AL1 hi active	AL2 disabled	7	AL1 lo active	AL2 disabled	8	AL1 disabled	AL2 disabled
0	AL1 hi active	AL2 hi active																										
1	AL1 lo active	AL2 hi active																										
2	AL1 disabled	AL2 hi active																										
3	AL1 hi active	AL2 lo active																										
4	AL1 lo active	AL2 lo active																										
5	AL1 disabled	AL2 lo active																										
6	AL1 hi active	AL2 disabled																										
7	AL1 lo active	AL2 disabled																										
8	AL1 disabled	AL2 disabled																										
<p>00000 Alarms comparison on gross or net weight</p>	<table style="width: 100%; border: none;"> <tr><td style="border: none;">0</td><td style="border: none;">AL1 net</td><td style="border: none;">AL2 net</td></tr> <tr><td style="border: none;">1</td><td style="border: none;">AL1 gross</td><td style="border: none;">AL2 net</td></tr> <tr><td style="border: none;">2</td><td style="border: none;">AL1 net</td><td style="border: none;">AL2 gross</td></tr> <tr><td style="border: none;">3</td><td style="border: none;">AL1 gross</td><td style="border: none;">AL2 gross</td></tr> </table>	0	AL1 net	AL2 net	1	AL1 gross	AL2 net	2	AL1 net	AL2 gross	3	AL1 gross	AL2 gross															
0	AL1 net	AL2 net																										
1	AL1 gross	AL2 net																										
2	AL1 net	AL2 gross																										
3	AL1 gross	AL2 gross																										

	00000 Number of consecutive readings in alarm zone to cause an alarm.	0 After 1 reading 1 After 2 readings 2 After 4 readings 3 After 8 readings	4 After 16 readings 5 After 32 readings 6 After 64 readings 7 After 128 reading
MENU  Press Menu Select Key	PEAK  Press Digit Select Key	RESET  Press Value Select Key	
SPI d Alarm 1 dribble value	0.0000 0.0000 0.0000 0.0000 0.0000 Select digit to flash.	Select -9 thru 9 for flashing first digit, 0 thru 9 for other flashing digits. Active high alarms will activate above the setpoint (positive dribble value) or below the setpoint (negative dribble value).	
SP2 d Alarm 2 dribble value	0.0000 0.0000 0.0000 0.0000 0.0000 Select digit to flash.		

KEYSTROKES FOR VIEWING & CHANGING SETPOINTS

The  (Alarms) key can be used to step through and view setpoints while the meter continues to make conversions and performs setpoint control. If the  (Peak) key is pressed while a setpoint is displayed, conversion stops and the setpoint can be changed. After pressing , you have 30 seconds, or the meter will revert to the normal display. To view setpoints, menu item Loc3, digit 3, must have been set to 0. To change setpoints, menu item Loc4, digit 3, must have been set to 0.

ALARMS  Press Alarms Key	PEAK  Press Digit Select Key	RESET  Press Value Select Key
300.24 Press  (Alarms) to display Alarm 1 setpoint.	200.00 Current setpoint 1 digit blinks, and Alarm 1 LED indicator lights. Press  to select another digit, which will blink.	295.00 To change setpoint 1 value, press  to change the selected blinking digit value.
395.00 Press  (Alarms) to display Alarm 2 setpoint.	395.00 Current setpoint 2 digit blinks, and Alarm 2 LED indicator lights. Press  to select another digit, which will blink.	305.00 To change setpoint 2 value, press  to change the selected blinking digit value.
300.24 Press  (Alarms) again. Meter will reset and display current reading.		

ALARM TYPES

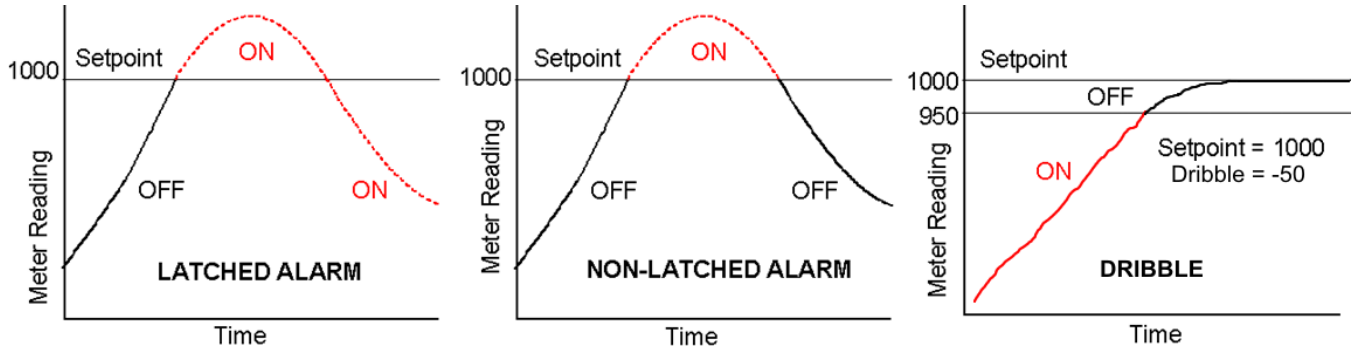

Latched alarms stay actuated until reset. They can shut down machinery or a process when a setpoint (or limit) has been exceeded or maintain an alarm condition until acknowledged by an operator.

Non-latched alarms change state automatically when a reading rises above a setpoint and change back automatically when the reading falls below that setpoint.

Dribble is a settable scale meter parameter in counts which allows a flow to be shut off before the setpoint value has been reached. For example, set the setpoint to 100.0 (1000 counts) and the dribble factor to -50 counts to turn off the fill of a 100.0 lb bag at 95.0 lbs if the shut-off system is known to dribble another 5.0 lbs following shut-off.

15. ANALOG OUTPUT OPTION

An analog board may be installed in the meter at rear panel jack position J4, adjacent to the signal conditioner board. Once installed, this board is recognized by the meter, which will bring up the appropriate menu items for it. These will not be brought up if an analog output board is not installed.

The analog output can be a 0-20 mA, 4-20 mA or 0-10V unipolar signal with respect to isolated ground, or a bipolar -10V to +10V voltage signal with respect to a reference return line. Unipolar or bipolar operation is selected by a jumper. A unipolar current or voltage output is selected at the connector. Unipolar 4-20 mA or 0-20 mA current is selected in software.

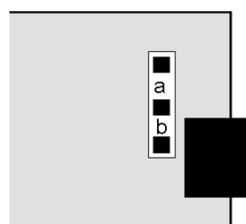

UNIPOLAR CONNECTIONS

4-20 mA or 0-20 mA OUTPUT
0-10V OUTPUT
ISOLATED GROUND

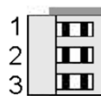

Unipolar current or voltage: Jumper **a**

BIPOLAR CONNECTIONS

REFERENCE or RETURN
-10V to +10V OUTPUT
N/C

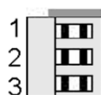

Bipolar -10 to +10 voltage: Jumper **b**

The low analog output (0 mA, 4 mA, 0V, or -10V) may be set to correspond to any low displayed reading **An Lo**. The high analog output (20 mA, 0V or 10V) may be set to correspond to any high displayed reading **An Hi**. The meter will then apply a straight line fit between these two end points to provide an analog output scaled to the meter reading.

KEYSTROKES FOR SETUP

If the **MENU** key does not work, see Section 10 “Enabling & Locking Out Menu Items.”

MENU Press Menu Select Key	PEAK Press Digit Select Key	RESET Press Value Select Key
AnSEt Analog Output Setup. Press until AnSEt is displayed (requires analog output board).	00 Analog output signal selection.	0 0-20 mA current output 1 0-10V voltage output 2 4-20 mA current output 3 -10 to +10V voltage output
	00 Analog output source.	0 Net filtered 1 Gross filtered 2 Net unfiltered 3 Gross unfiltered
An Lo Low displayed value for 0 mA, 4 mA, 0V, or -10V output	0.0000 0.0000 0.0000 0.0000 0.0000 Select digit to flash.	Select -9 thru 9 for flashing first digit, 0 thru 9 for other flashing digits. Decimal point location is fixed by dEC.Pt selection.
An Hi High displayed value for 20 mA or 10V output	0.0000 0.0000 0.0000 0.0000 0.0000 Select digit to flash.	Select -9 thru 9 for flashing first digit, 0 thru 9 for other flashing digits. Decimal point location is fixed by dEC.Pt selection.

16. SERIAL COMMUNICATION OPTIONS



A serial communications board may be connected to the meter main board at plug position P13 (middle position). Available boards are RS232, RS485 (with dual RJ11 connectors), RS485 Modbus (with dual RJ45 connectors), USB, and a USB-to-RS485 gateway. The dual connectors of RS485 boards are wired in parallel to allow daisy chaining of addressable meters without use of a hub. Two serial communication protocols are selectable for all serial boards: the Custom ASCII protocol, and the Modbus RTU protocol.

To connect a meter with a USB board to a computer, use a USB cable with Type A and Type B connectors. The computer will display “Found new Hardware” followed by “Welcome to the Found new Hardware Wizard.” Follow the instructions for software installation from a CD. When the installation is complete, use Device Manager to determine the com port. To get to Device Manager, go to the Windows Control Panel, click on System, click on the Hardware tab, then click on Device Manager. Go down the device list and click on Ports (COM & LPT) and USB serial port (com #). Note the com port # for use with communications to your meter, then exit Control Panel. If you later need to change the Com port, right-click on USB serial port (com #), then on Properties, Port settings, and Advanced. Change port to the desired number, click OK, then exit Control Panel.

A USB-to-RS485 gateway board allows a meter to be interfaced to a computer and be the device server for a network of up to 31 other meters on an RS485 bus, while itself retaining all capabilities of a meter. The remote meters need to be equipped with our RS485 digital interface board with dual 6-pin RJ11 jacks, not our RS485 digital interface with dual 8-pin RJ45 jacks. The dual 6-pin RJ11 jacks on the RS485 board are wired in parallel to allow multiple meters to be daisy-chained using readily available 6-wire data cables with no need for hand-wiring or an RS485 hub. The outer two wires are used for ground.

Use 6-wire, straight-through data cables, P/N CBL03, not 4-wire telephone cables or crossover cables, all the way from the device server to the last device on the RS485 bus. Connect ATX to ATX, BTX to BTX, etc., with no crossover as you go from device to device.

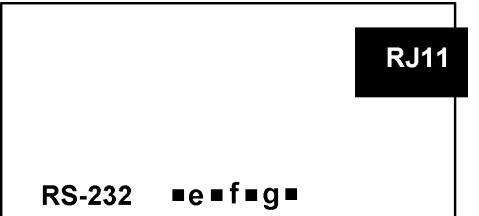
BOARD SETUP VIA JUMPERS

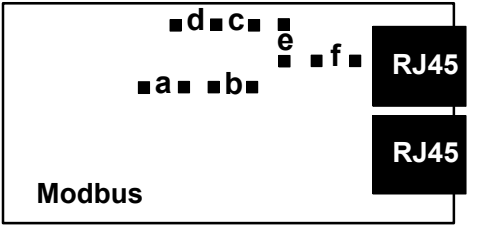

<p>USB Board (P/N LUSB) No jumpers required.</p>	 <p>The diagram shows a rectangular board with a single jumper labeled 'USB' positioned at the top right corner. The text 'USB' is also printed on the board near the bottom left corner.</p>
<p>RS232 Board (P/N L232) e - Do not use (except for externally enabled RTS). Prevents use of Instrument Setup PC software. f - Do not use. g - Installed for normal operation. Note: Board is shipped with jumper g installed.</p>	 <p>The diagram shows a rectangular board with a single jumper labeled 'RJ11' positioned at the top right corner. Below the board, the text 'RS-232' is printed, followed by a row of seven jumpers labeled 'e', 'f', and 'g'. Jumper 'g' is shown as installed.</p>
<p>RS485 Board, RJ11, P/N L485, Full Duplex Operation b & d - Installed on last meter in long cable run. RS485 Board, RJ11, P/N L485, Half Duplex Operation a & c - Installed for half duplex operation. d - Installed on last meter in line with long cable runs. Note: Board is shipped with no jumpers installed.</p>	 <p>The diagram shows a rectangular board with two jumpers labeled 'RJ11' positioned on the right side. Above the board, a row of four jumpers labeled 'a', 'b', 'c', and 'd' is shown. Jumper 'd' is shown as installed.</p>
<p>RS485 Board, RJ45, P/N LMOD, Full Duplex Operation b & e - Bias jumpers should be installed on 1 board. a & d - Installed on last meter in long cable run. RS485 Board, RJ45, P/N LMOD, Half Duplex Operation b & e - bias jumpers installed on 1 board. c & f - installed for half duplex operation. a - installed on last meter in line with long cable runs. Note: Board is shipped with no jumpers installed.</p>	 <p>The diagram shows a rectangular board with two jumpers labeled 'RJ45' positioned on the right side. Above the board, a row of six jumpers labeled 'a', 'b', 'c', 'd', 'e', and 'f' is shown. Jumpers 'e' and 'f' are shown as installed.</p>

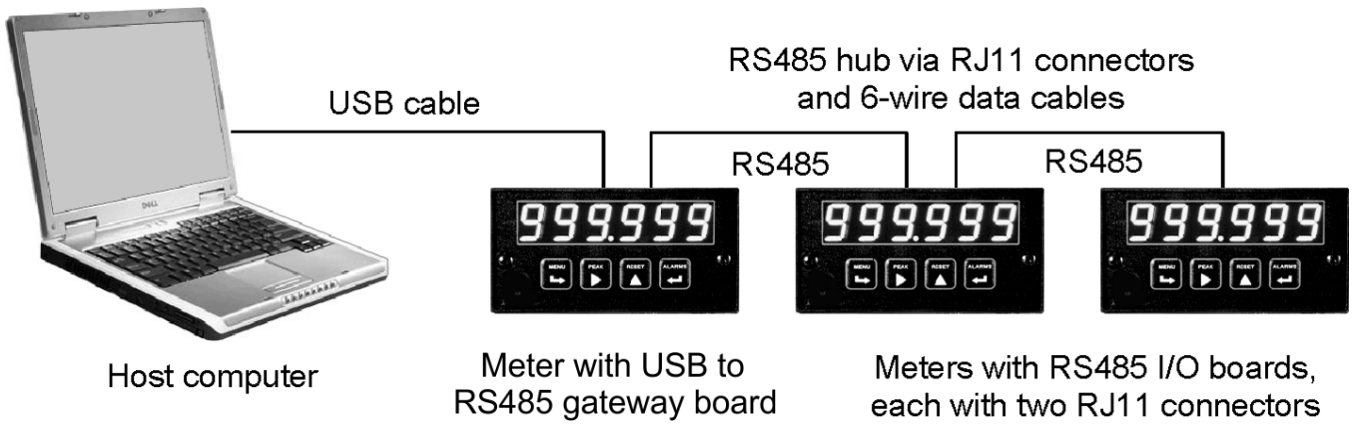
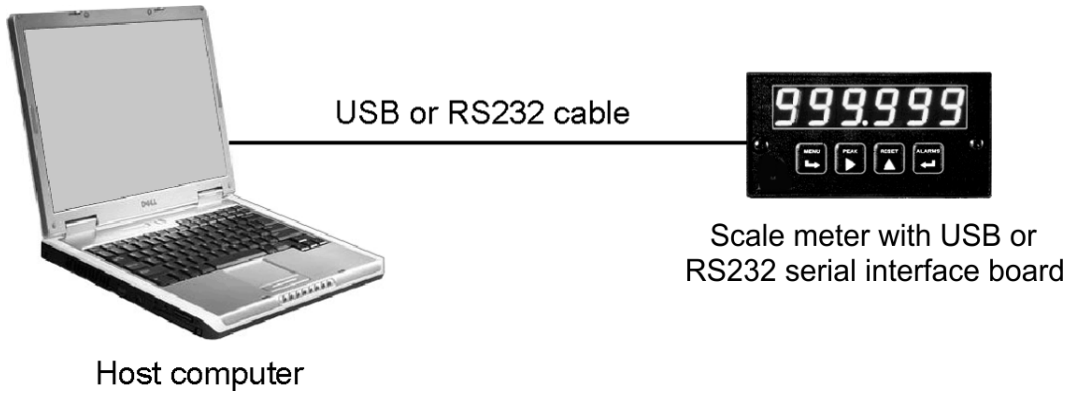

SERIAL CONNECTION EXAMPLES



KEYSTROKES FOR SETUP

If the *MENU*  key does not work, see Section 10 “Enabling & Locking Out Menu Items.”

 MENU <i>Press Menu Select Key</i>	 PEAK <i>Press Digit Select Key</i>	 RESET <i>Press Value Select Key</i>																																
Ser 1 Fixed Parameters: No parity 8 data bits 1 stop bit	000 Output signal source	0 Send unfiltered value 1 Send filtered value																																
	000 Baud rate	0 300 baud 1 600 baud 2 1200 baud 3 2400 baud 4 4800 baud 5 9600 baud 6 19200 baud																																
	000 Output update rate for continuous mode	<table border="0"> <tr> <td></td> <td><u>60 Hz</u></td> <td><u>50 Hz</u></td> </tr> <tr> <td>0</td> <td>Line frequency</td> <td>Line frequency</td> </tr> <tr> <td>1</td> <td>0.28 sec</td> <td>0.34 sec</td> </tr> <tr> <td>2</td> <td>0.57 sec</td> <td>0.68 sec</td> </tr> <tr> <td>3</td> <td>1.1 sec</td> <td>1.4 sec</td> </tr> <tr> <td>4</td> <td>2.3 sec</td> <td>2.7 sec</td> </tr> <tr> <td>5</td> <td>4.5 sec</td> <td>5.4 sec</td> </tr> <tr> <td>6</td> <td>9.1 sec</td> <td>10.9 sec</td> </tr> <tr> <td>7</td> <td>18.1 sec</td> <td>21.8 sec</td> </tr> <tr> <td>8</td> <td>36.6 sec</td> <td>43.5 sec</td> </tr> <tr> <td>9</td> <td>72.5 sec</td> <td>97 sec</td> </tr> </table>		<u>60 Hz</u>	<u>50 Hz</u>	0	Line frequency	Line frequency	1	0.28 sec	0.34 sec	2	0.57 sec	0.68 sec	3	1.1 sec	1.4 sec	4	2.3 sec	2.7 sec	5	4.5 sec	5.4 sec	6	9.1 sec	10.9 sec	7	18.1 sec	21.8 sec	8	36.6 sec	43.5 sec	9	72.5 sec
	<u>60 Hz</u>	<u>50 Hz</u>																																
0	Line frequency	Line frequency																																
1	0.28 sec	0.34 sec																																
2	0.57 sec	0.68 sec																																
3	1.1 sec	1.4 sec																																
4	2.3 sec	2.7 sec																																
5	4.5 sec	5.4 sec																																
6	9.1 sec	10.9 sec																																
7	18.1 sec	21.8 sec																																
8	36.6 sec	43.5 sec																																
9	72.5 sec	97 sec																																

MENU  Press Menu Select Key	PEAK  Press Digit Select Key	RESET  Press Value Select Key
Ser 2 Serial Setup 2	0000 Line feed	0 No line feed after carriage return 1 Line feed after carriage return
	0000 Alarm data with readings	0 No alarm data 1 Alarm data with reading
	0000 Control of data output	0 Continuous data output 1 Data output on command only
	0000 Meter address with Custom ASCII protocol	Select 1 thru F for addresses 1 thru 15. Select 0. thru F. (with decimal point) for addresses 16 thru 31.
Ser 3 Serial Setup 3	00000 Half or full duplex	0 Half or full duplex 1 Do not use
	00000 Special start & stop char.	0 Standard continuous mode 1 Special start & stop characters
	00000 RTS mode	0 Normal RS232 operation 1 Single RS232 transmission mode with -e jumper on RS232 board
	00000 Termination characters	0 Only at end of all items 1 At end of each item
	00000 Data sent in continuous mode	0 Net + gross 1 Net only 2 Gross only 3 Peak only 4 Net + gross + peak
Ser 4 Serial Setup 4.	000 Modbus ASCII gap timeout	0 1 sec 1 3 sec 2 5 sec 3 10 sec
	000 Serial protocol	0 Custom ASCII, 8 bits, no parity 1 Modbus RTU, 8 bits 2 Modbus ASCII, 7 bits
	000 Parity	0 None, 2 or more stop bits 1 Odd, 1 or more stop bits 2 Even, 1 or more stop bits
Addr Modbus Address. Appears only if the Modbus protocol is selected.	000 000 000 Select digit to flash.	247 Select 0 through 9 for flashing digit. Address range is 1 to 247.

17. EXCITATION OUTPUT & POWER SUPPLY

Three isolated transducer excitation output levels are available from the power supply board. These are selectable via jumpers b, c, d, e, f in the upper right of the board, as illustrated. In addition, the board provides three jumper positions for special features. The same jumper locations apply to the universal power supply (85-264 Vac) and to the low voltage power supply (12-32 Vac or 10-48 Vdc).

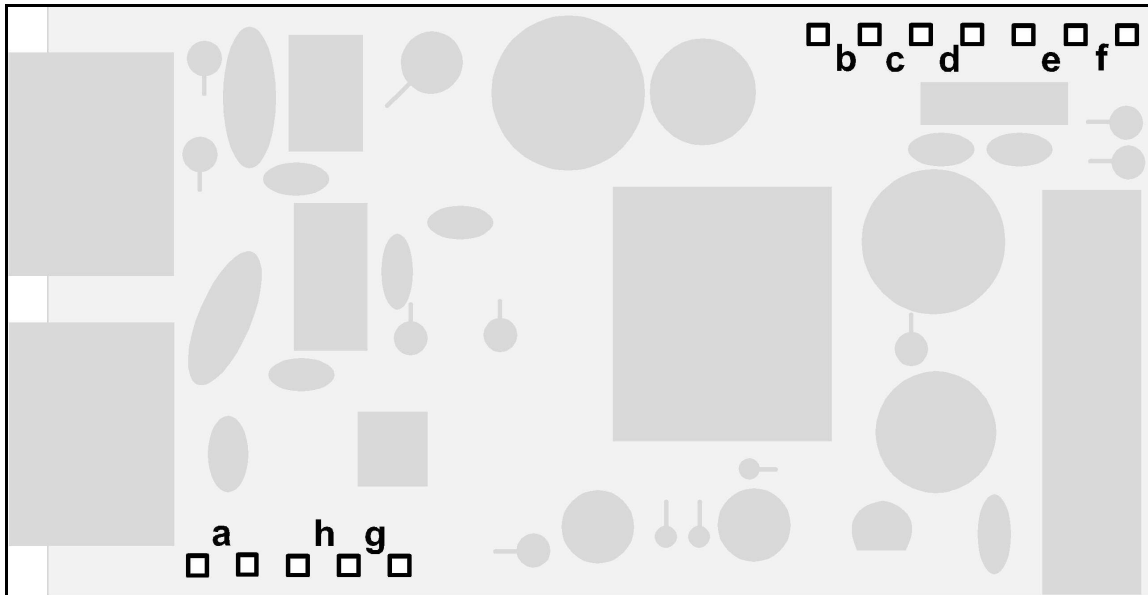

Excitation output	Jumper locations							
5 Vdc \pm 5%, 100 mA max	b, d, e	<table style="margin: auto; border-collapse: collapse;"> <tr> <td style="text-align: center;">■ b ■</td> <td style="text-align: center;">■ d ■</td> <td style="text-align: center;">■ e ■</td> <td style="text-align: center;">■</td> </tr> </table>	■ b ■	■ d ■	■ e ■	■		
■ b ■	■ d ■	■ e ■	■					
10 Vdc \pm 5%, 120 mA max	b, d, f	<table style="margin: auto; border-collapse: collapse;"> <tr> <td style="text-align: center;">■ b ■</td> <td style="text-align: center;">■ d ■</td> <td style="text-align: center;">■</td> <td style="text-align: center;">■ f ■</td> </tr> </table>	■ b ■	■ d ■	■	■ f ■		
■ b ■	■ d ■	■	■ f ■					
24 Vdc \pm 5%, 50 mA max	c	<table style="margin: auto; border-collapse: collapse;"> <tr> <td style="text-align: center;">■</td> <td style="text-align: center;">■ c ■</td> <td style="text-align: center;">■</td> <td style="text-align: center;">■</td> <td style="text-align: center;">■</td> <td style="text-align: center;">■</td> </tr> </table>	■	■ c ■	■	■	■	■
■	■ c ■	■	■	■	■			

SELECTION OF OTHER JUMPERS

Jumper a - Front panel menu lockout, locked when installed. (See Section 10)

Jumper g - Provides +5V power output at P1-4 when installed.

Jumper h - Connects "Control Input 2" to P1-4 when installed.

18. INSTRUMENT SETUP VIA PC

Instrument Setup software is a PC program which is much easier to learn than front panel programming. It is of benefit whether or not the meter is connected to a PC. With the meter connected to a PC, it allows uploading, editing and downloading of setup data, execution of commands under computer control, listing, plotting and graphing of data, and computer prompted calibration. With the meter unconnected to a PC, it provides quick selection of jumper locations and a printable display of menu selections for front panel setup.

SOFTWARE INSTALLATION

Download *IS2*.exe* onto your PC from the web or the distribution CD. Double-click on the downloaded file to unzip it into a special directory, such as *c:\temp*. Within that directory, double-click on *setup.exe*, which will install the software on your PC.

PREREQUISITES FOR CONNECTED USE

- 1) PC with available Com port.
- 2) Meter to be set up.
- 3) Communication board in the meter. This board can be used for meter setup, then be removed.
- 4) Cable to connect the meter and PC (see Section 1, Ordering Guide).
- 5) *Instrument Setup* software.



RJ11-to-DB9 RS232 cable with rear view of DB9 connector to PC

ESTABLISHING COMMUNICATIONS

Connect the meter and PC. Apply power to the meter. Be sure that the meter is in Run Mode, not Setup Mode. To start the software from Windows, click on *Start => Programs => IS2 => IS2*. Click on *RS232* and select the meter parameters. The program will temporarily set the selected Com port to the required baud rate, parity, data bits and stop bit. Once communications have been established, click on *Main Menu*. The software will sense the type of meter and installed boards, but it cannot sense jumpers positions nor set jumpers for you. If the computer is not connected to a meter, select *DPM* and *Series 2*.

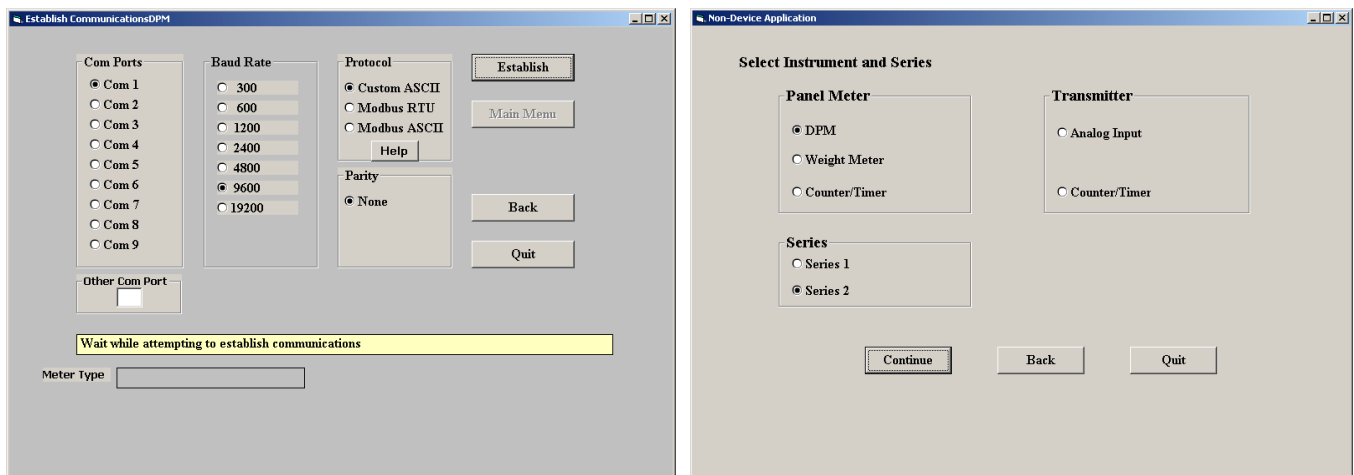

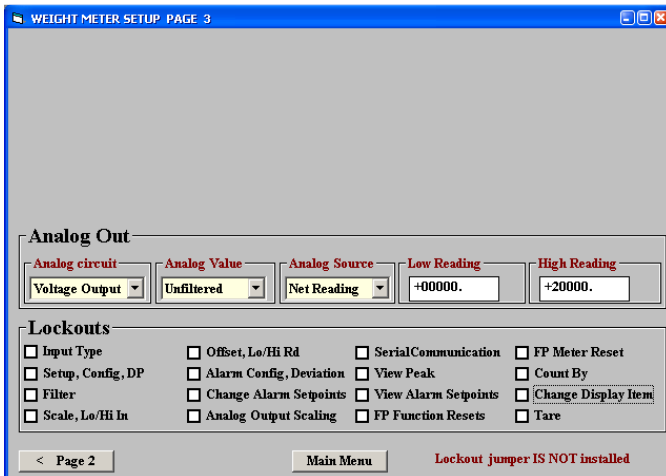
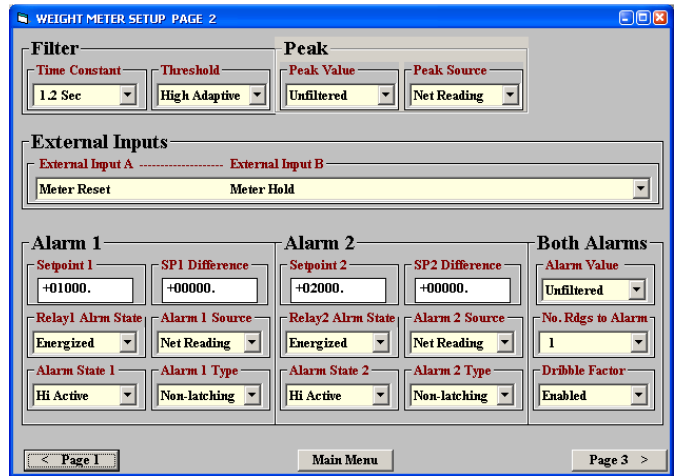
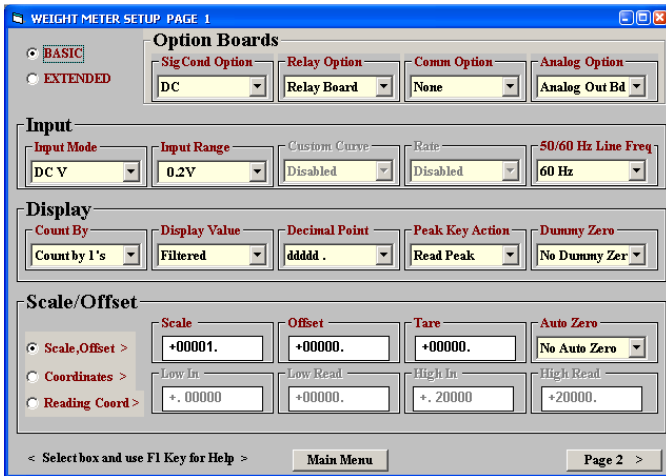

SETUP OF CONNECTED METER

A setup file can be retrieved from the meter (*DPM => Get Setup*), be edited (*View => Setup*), be saved to disk (*File => Save Setup*), be retrieved from disk (*File => Open Setup*), and be downloaded into one or multiple meters (*DPM => Put Setup*). Downloading of setup files from a PC can be a major time saving when multiple meters have to be set up in the same way.

You will find that *Instrument Setup software* is very user friendly, with separate tab-selectable windows for *Input+Display*, *Scaling*, *Filter*, *Relay Alarms*, *Communications*, *Analog Out*, and *Lockouts*. If the required hardware, such as the analog output board, is not sensed, the corresponding tab will be grayed out.

ADDITIONAL FEATURES

- **The Commands pull-down menu** allows you to execute certain meter functions by using your computer mouse. You can reset individual meter functions, display current or peak readings, and enter numbers to be displayed remotely by the DPM. The first position of a transmitted number must be a blank, + sign or - sign. Five digits and a decimal point must be transmitted. Leading 0's serve as blanks. The *Commands* pull-down menu will be grayed out unless a *Get Setup* has been executed.

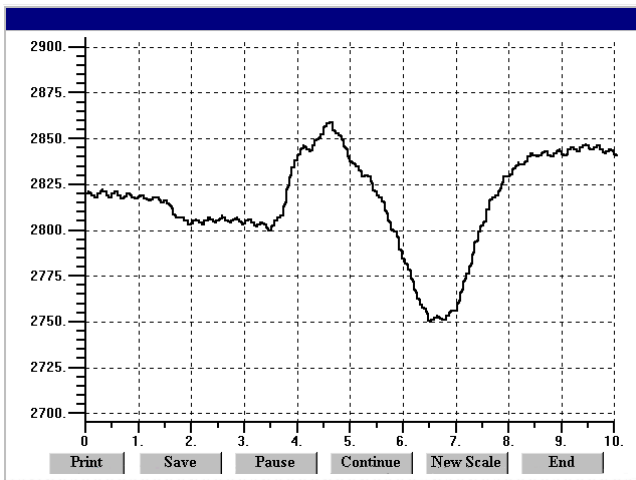

Plot

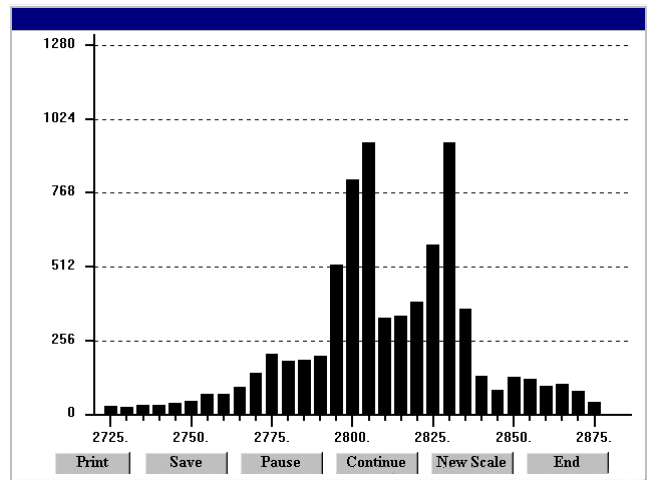

Graph

- **The Readings pull-down menu** provides three formats to display DPM data on the PC monitor. Use the *Pause* and *Continue* buttons to control the timing of data collection, then press **Print** for a hardcopy using your PC printer.
 - **List** presents the latest readings in a 20-row by 10-column table. Press *Pause* at any time to freeze the display. Press *Print* for a hardcopy. *List* can capture peak readings.
 - **Plot** generates a plot of readings vs. time in seconds. It effectively turns the DPM-PC combination into a printing digital oscilloscope.
 - **Graph** generates a histogram, where the horizontal axis is the reading and the vertical axis is the number of occurrences of readings. The display continually resizes itself as the number of readings increases.

- **The Jumpers pull-down menu** provides jumper positions for the various meter boards, duplicating information in this manual.

- **The Calibration pull-down menu** allows easy calibration of voltage and current ranges for the DC, load cell, and AC RMS signal conditioner boards. The PC first recognizes the type of board, then prompts you to apply specific jumpers and calibration signals. Press *Ready* to take a reading. Press *Repeat* to take more readings. When you have decided on which reading to accept, press on the number 1 through 10 of that reading. Additional calibration software is available online.

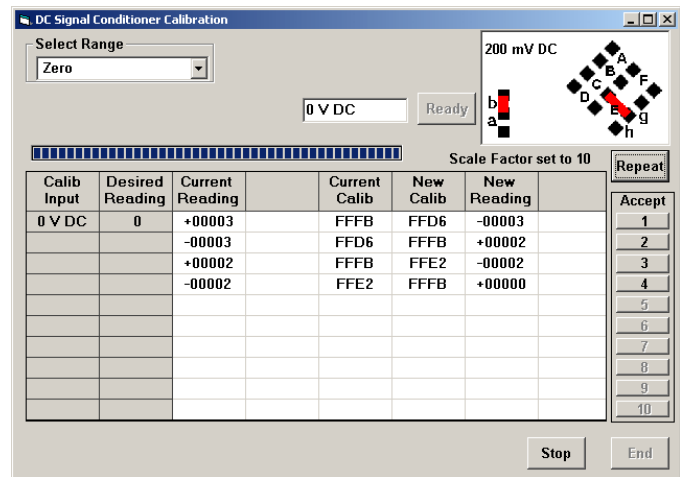

METER SETUP WITH AN UNCONNECTED PC

Instrument Setup software is also of benefit when the PC is not connected to a meter. Upon launching the software, click on *None* for *Communications*, then on *DPM* and *Series 2*. Click on *File => Default Setup* to retrieve a default setup file from disk, or on *File => Open Setup* to retrieve a previously saved setup file from disk.

To enter new setup information, click on *View => Setup*, then make your screen selections as if you were connected to a meter. Tabs will be grayed out if you have not selected the required hardware under the *Input+Display* tab. When done, press on *Main Menu*, then on *View => Menu*. The selections made under *Setup* will now be shown in the form of the required front panel programming sequence, where each row corresponds to a menu item selected by the **↵** key, and the seven data columns correspond to values entered via the **▶** and **▲** keys.

Click on any step in the sequence to bring up a detailed help window.

Click on *Print* for a hardcopy, which you can then use as an instruction sheet to program your meter via its front panel.

Click on *Main Menu => File => Save Setup As* to save your setup to disk and have an electronic record.

MENU KEY	S	1	2	3	4	5
InPut			d	C		V
SEtuP		0	0	0	0	0
ConFiG		0	0	0	0	0
FiLteR		0	0	1	1	6
DecPt		d	d	d.	d	d
SCALE		0	0	0	1	0
OFFSt		0	0	0.	0	0
SEr 1				0	5	0
SEr 2			0	0	1	1
Loc 1		0	0	0	0	0
Loc 2			0	0	1	0
Loc 3			0	0	0	0

19. SCALE METER CALIBRATION

All analog input and analog output ranges of the meter have been digitally calibrated at the factory prior to shipment using calibration equipment certified to NIST standards. Calibration constants are stored digitally in non-volatile memory in EEPROM on the signal conditioner board and analog output board. As a result, these boards may be changed without requiring meter recalibration.

If recalibration is required, the meter may be returned to the factory or to any authorized distributor. Easy calibration of DC and load cell signal conditioner ranges is possible using our Instrument Setup software. To allow computer aided calibration, an RS232 or RS485 interface card must be installed in the meter. This card may be installed temporarily and be removed following calibration. Step-by-step instructions and advanced calibration software are available from the factory.

20. SCALE METER SPECIFICATIONS

Meter Display

Type 5 LED, 7-segment, 14.2mm (.56") high digits & 3 LED indicators
Color..... Red or green
Range..... -99999 to +99999 and -99990 to +99990

A to D Conversion

Technique (Pat.5,262,780)..... Concurrent Slope™
Read Rate 60/s for 60 Hz NMR, 50/s for 50 Hz NMR
Output Update Rate56/s at 60 Hz, 47/s at 50 Hz
Display Update Rate 3.5/s at 60 Hz, 3/s at 50 Hz

Noise Rejection

CMV from DC to 60 Hz.....Withstand 250Vac
Dielectric strength..... 3.5 kV ac for 5 sec, 2.3 kV ac for 1 min
CMR from DC to 60 Hz 130 dB
NMR at 50/60 Hz.....90 dB with minimum digital filtering

Control Inputs (CMOS/TTL levels, logic 0 = tied to digital ground, logic 1 = open)

/ Hold input Logic 0 holds display and outputs
/ Peak Logic 0 displays peak value
/ Tare Logic 0 offsets input value to zero
/ Tare Reset..... Logic 0 resets Tare value to zero
/ Meter Reset..... Logic 0 resets all meter functions
/ Function Reset..... Logic 0 resets peak values and alarms
/ Display Blank..... Logic 0 shuts off the display
/ Display Item..... Logic 0 displays Gross value

Power Requirements

Input Voltage rating (standard)..... 85-264 Vac or 90-300 Vdc (DC range not UL approved)
Input Voltage rating (low voltage option) 12-32 Vac or 10-48 Vdc
Power Line Frequency DC and 47-63 Hz
Power Consumption, Max 5 Watts

Excitation Outputs

Voltage & Current Levels (jumper selectable) 5 Vdc ±5%, 100 mA max
10 Vdc ±5%, 120 mA max
24 Vdc ± 5%, 40 mA max
Excitation Output Ripple..... 100 mVp max
Isolation from power and outputs 250 Vac
Insulation dielectric strength to power and outputs..... 3.5 kV ac for 5 sec, 2.3 kV ac for 1 min
Isolation to signal common 50 Vdc

Current Compliance, 0-10V, -10 to +10V Output.....2 mA (5 kOhm or higher load)
 Accuracy Meter input accuracy $\pm 0.02\%$ of full scale analog output
 Resolution 16 bit (1 part in 65,536)
 Response Time 50/60Hz update rate
 Scaling of Reading for Zero Output.....-99,999 to +99,999
 Scaling of Reading for Full Scale Output..... -99,999 to +99,999
 Isolation rating between signal common and analog output..... 250V ac
 Insulation dielectric strength between signal common and analog output.....
 3.5 kV ac for 5 sec, 2.3 kV ac for 1 min

Serial Interface Option (USB, RS232, RS485, RS485-Modbus boards)

Output Types.....RS232, RS485, RS485-Modbus, USB, USB-to-RS485 gateway
 Power to Interface Option.....Powered by meter
 RS485 Wiring Half or full duplex
 Baud Rates 300, 600, 1200, 2400, 4800, 9600, 19200
 Serial Protocols Custom ASCII, Modbus RTU (selectable)
 Signal Levels Meet RS232, RS485, USB standards
 Isolation rating between signal common and serial I/O 250V ac
 Insulation dielectric strength between signal common and serial I/O
 3.5 kV ac for 5 sec, 2.3 kV ac for 1 min

Option Board Connectors:

RS232 Single RJ11 jack
 RS485 Two RJ11 jacks (for daisy chaining with 6-wire data cables)
 RS485 Modbus..... Two RJ45 jacks (for daisy chaining with 8-wire data cables)
 USB..... USB type B plug
 USB-to-RS485 gatewayUSB type B plug plus RJ11 jack to RS485 bus

Environmental

Operating Temperature0°C to 55°C
 Storage Temperature -40°C to 85°C
 Relative Humidity 95% from 0°C to 40°C, non-condensing
 Case..... NEMA-4X (IP65) from front when panel mounted (not verified for UL)
 Shock 10 G at 1 kHz, applied in X, Y, Z axes
 Vibration 15 Hz to 150 Hz, 1 mm to 2 mm amplitude, 20 G max.

21. GLOSSARY OF TERMS

Adaptive Filter Threshold

A threshold which causes an adaptive moving average filter to be reset to the latest reading when the accumulated difference between individual readings and the filtered reading exceeds that threshold. Adaptive moving average filtering allows a meter to respond rapidly to actual changes in signal while filtering out normal noise. The accumulated difference is also reset to zero when the latest reading has a different polarity than the filtered reading. A low adaptive filter threshold is normally selected. A high filter threshold should be selected if the signal has large transients.

Alarm, Latched

An alarm which stays actuated until reset. Latched alarms can shut down machinery or a process when an operating limit has been exceeded, or maintain an alarm condition until acknowledged by an operator.

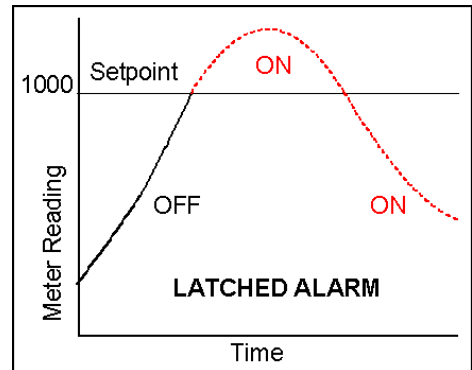

Alarm, Non-latched

An alarm which changes state automatically when the reading rises above a specified limit and changes back automatically when the reading falls below a limit.

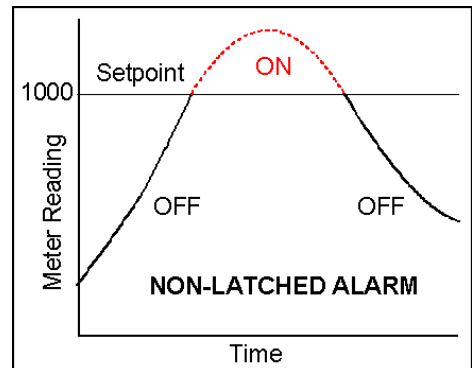

Autofilter

A selectable digital filter mode which automatically selects an appropriate moving average filter time constant from 0.08 sec to 9.6 sec for the encountered noise condition.

Auto-tare

A selectable meter operating mode, where the first reading following power-on or meter reset is used to zero the display. Further readings are then relative to this new zero.

Auto-zero

An auto-zero limit from 0 to 9 counts can be programmed to compensate for load cell drift. Whenever the meter comes to rest within that limit from zero, it will auto-zero. Auto-zero can be enabled or disabled.

Batch Average Filter

A digital filter mode which averages 16 readings and then displays the average. Readings are taken at 60/sec with 60 Hz power and 50/sec with 50 Hz power.

Counts

The reading displayed on the panel meter ignoring the decimal point.

Count-by

A settable scale meter parameter which allows readings to be rounded to 1, 2, 5, 10, 20, 50 or 100 counts. For example, set the count-by to 10 to read weight to the nearest 1 lb if each count is 0.1 lb.

Custom ASCII Protocol

A simplified, short protocol for use with these panel meters. It allows 31 digital addresses. Not an industry-standard protocol, like the more complex *Modbus protocol*, which is also offered with the meters.

Display Blank A rear panel input which blanks the display when the input is tied to logic ground by a switch or 0V is applied (logic level true). The meter display will light when the input is open or is held at +5V (logic level false).

Dribble A settable scale meter parameter in counts which allows a flow to be shut off before the setpoint value has been reached. For example, set the setpoint to 100.0 (1000 counts) and the dribble factor to -50 counts to turn off the fill of a 100.0 lb bag at 95.0 lbs if the shut-off system is known to dribble another 5.0 lbs following shut-off.

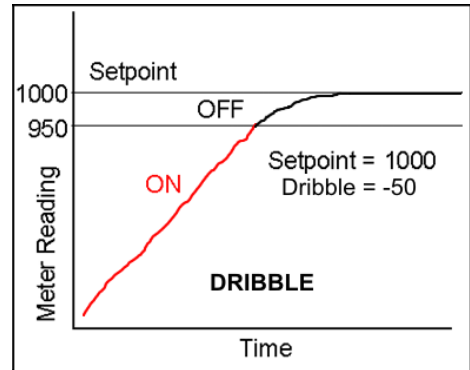

Full Scale The maximum input signal range for which the meter has been configured. For example, the most sensitive full scale for the load cell meter is ± 20 mV (signal range from -20 mV to +20 mV).

Function Reset

A rear panel control input which resets Peak, Valley and any latched alarms when the input is tied to logic ground by a switch or 0V is applied (logic level true). To reset the value again, the input must be open or 5V applied (logic level false) and then set low.

Ground Loop A closed conductive path in external ground wiring that allows stray currents to flow in ground wiring, creating ground noise. The meters in this manual minimize ground loop problems by mutually isolating the grounds associated with meter power, signal input, and all output and communication options.

Jumper A push-on component which provides a short between two adjacent posts on a circuit board. For example, jumpers are used to configure signal conditioner boards for different signal types and full-scale ranges. Unused jumpers are stored by pushing one side over an unused post.

Hysteresis Band

A band which controls relay action symmetrically around a setpoint. The relay closes (or opens) when the reading goes above the setpoint plus one hysteresis limit, and opens (or closes) when the reading falls below the setpoint less one hysteresis limit. A narrow hysteresis band is often used to minimize relay chatter around a setpoint due to electrical noise or signal feedback caused by load switching. A wide hysteresis band can be used for control applications, such as turning on a fill pump when the tank level has reached a lower limit and shutting off the pump when the tank level has reached an upper limit. The hysteresis band will be equal to two hysteresis limits.

Menu Mode The meter programming mode used for input and range selection, meter setup, and meter configuration. Entered into from the Run mode by pressing the *MENU* key. The Menu mode can be locked out completely by a jumper.

Meter Hold A rear panel input which freezes the meter display and all meter outputs while that input is tied to logic ground by a switch or is held at 0V (logic level true). The meter will resume operation when the input is allowed to float or is held at +5V (logic level false).

Modbus An industry-standard serial communications protocol which allows devices by different manufacturers to be digitally addressed by a PC on the same communication line, with up to 247 digital addresses. More complex than the *Custom ASCII* protocol, which is also supported by these meters.

Moving Average Filter

A digital filter mode which displays a weighting moving average of readings. Readings are taken at 60/sec with 60 Hz power and 50/sec with 50 Hz power. Display update rates remain 3.5/sec with 60 Hz power and 3.0/sec with 50 Hz power. There are eight moving average modes:

- Old average $\times 1/2$ + new reading $\times 1/2$ (equivalent to 0.08 sec RC time constant).
- Old average $\times 3/4$ + new reading $\times 1/4$ (equivalent to 0.15 sec RC time constant).
- Old average $\times 7/8$ + new reading $\times 1/8$ (equivalent to 0.3 sec RC time constant).
- Old average $\times 15/16$ + new reading $\times 1/16$ (equivalent to 0.6 sec RC time constant).
- Old average $\times 31/32$ + new reading $\times 1/32$ (equivalent to 1.2 sec RC time constant).
- Old average $\times 63/64$ + new reading $\times 1/64$ (equivalent to 2.4 sec RC time constant).
- Old avg. $\times 127/128$ + new reading $\times 1/128$ (equivalent to 4.8 sec RC time constant).
- Old avg. $\times 255/256$ + new reading $\times 1/256$ (equivalent to 9.6 sec RC time constant).

Offset A constant adder used for the displayed reading. This is the term b in the straight line formula $y = mx + b$, where y is the displayed reading in counts, m is the scale factor, x is the measured reading in counts, and b is the offset. For direct readout in (milli)volts or (milli)amps, *offset* is 0.

Peak Display The maximum (or most positive) reading since that maximum was last reset. Reset can be via the meter front panel, an external input, or a software command. The displayed value can reflect the filtered or unfiltered readings.

Process Signal

A signal whose display requires setup of *scale* and *offset* settings for display in engineering units. A classical process signal is 4-20 mA, where the 4 mA and 20 mA end points can each correspond to a desired meter reading.

Reading The value displayed by the meter. "Taking a reading" is the action of the meter to make an analog-to-digital conversion. Readings are taken at 60/sec with 60 Hz power or 50/sec with 50 Hz power, and are displayed with an update rate of 3.5/sec with 60 Hz power or 3.0/sec with 50 Hz power.

Remote Display

A display mode which allows the meter to serve as a remote display to another meter when connected to it by a 4-wire phone cord. Also allows the meter to transmit raw measurement data to a computer and then display processed data

from the computer. A serial communications option board is required in the meter. If such a board is not installed or no serial data is received, the meter displays *rESEt*.

Reset

There are three types of Reset:

- Peak Reset. Achieved by simultaneously pressing the *RESET* and *PEAK* keys.
- Latched Alarm Reset. Achieved by simultaneously pressing the *RESET* and *ALARMS* keys.
- Meter Reset. Causes the meter to reinitialize and take a tare reading when set up for *auto-tare*. Achieved powering up the meter, by pressing the *RESET* and *MENU* keys simultaneously, stepping through all top-level menu choices, grounding a rear panel connector, or supplying an ASCII command. *rESEt* is displayed briefly.

RS485 Half Duplex

Serial communications implemented with two wires, allowing data transmission in both directions, but not simultaneously.

RS485 Full Duplex

Serial communications implemented with four wires, allowing data transmission in two directions simultaneously.

Run Mode

The normal operating mode of the meter, where readings are taken, as opposed to the *menu mode*.

Scale

A constant multiplier used to go from A/D converter counts to displayed counts. This is the slope term m in the straight line formula $y = mx + b$, where y is the displayed reading in counts, m is the scale factor, x is the measured reading in counts, and b is the offset. For direct readout in (milli)volts or (milli)amps, scale is 1.

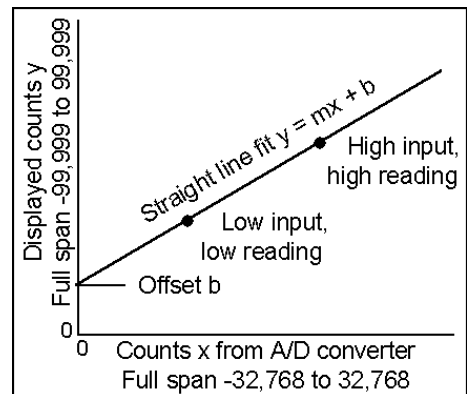

Scaling

The process of setting *scale* and *offset* so that the meter reads properly in engineering units (such as psi).

Scaling, Coordinates of 2 Points Method

A scaling method where four numbers are entered manually: low input, desired reading at low input; high input, and desired reading at high input. The meter then applies a straight line fit. The decimal point is set by the separate *dEC.Pt* menu item.

Scaling, Scale and Offset Method

A scaling method where *scale* and *offset* are entered manually.

Scaling, Reading Coordinates of 2 Points Method

A scaling method, where the low and high input values are determined from actual signals. A known low signal is first applied to the meter, such as the output of a pressure transducer at zero pressure. That signal is captured as the

low input value, and the desired low reading is entered. A known high signal is then applied, such the output of a transducer for a know weight or pressure. That signal is captured as the high input value, and the desired high reading is entered. The meter then applies straight line fit. This scaling method has the advantage of calibrating the transducer and meter as a system. The actual voltage or current at either point does not need to be known. The decimal point is set by the separate *dEC.Pt* menu item.

- Setpoint** A value compared to the reading to determine the state of a relay. Term often used interchangeably with “alarm setpoint.” The relay action can by *latching* or *non-latching*, utilize a *hysteresis band*, or utilize a *deviation band*. Hysteresis bands and deviation bands are specified by two symmetrical limits around the *setpoint*.
- Span** The number of *counts* corresponding to a given signal range.
- Tare** A rear panel input which causes the display to be set to zero when the input is momentarily tied to logic ground by a switch or is held at 0V (logic level true) for a minimum of 50 ms. When the input is allowed to float or is held at +5V (logic level false), the meter displays readings relative to this new zero. A common application is in weighing, where an external Tare button is pressed to read the weight of an empty scale (tare), and tare is then automatically subtracted as a constant from gross weight for display of net weight. Tare can also be used for other applications where a reading relative to starting point is desired.
- Zero** When used with process meters, *zero* is an adjustment so that a given low transducer output reads zero on the meter. *Zero* is adjusted by programming *offset*.

22. WARRANTY

Laurel Electronics Inc. warrants its products against defects in materials or workmanship for a period of one year from the date of purchase.

In the event of a defect during the warranty period, the defective unit may be returned to the seller, which may be Laurel or a Laurel distributor. The seller may then repair or replace the defective unit at its option. In the event of such a return, freight charges from the buyer shall be paid by the buyer, and freight charges from the seller shall be paid by the seller.

LIMITATION OF WARRANTY

The foregoing warranty shall not apply to defects resulting from:

1. Improper installation or miswiring.
2. Improper or inadequate maintenance.
3. Unauthorized modification or misuse.
4. Operation outside the environmental specifications.
5. Mishandling or abuse.

The warranty set forth above is exclusive and no other warranty, whether written or oral, is expressed or implied. Laurel specifically disclaims implied warranties of merchantability and fitness for a particular purpose.

Any electronic product may fail or malfunction over time. To minimize risks associated with reliance on Laurel products, users are expected to provide adequate system-level design and operating safeguards. Laurel's products are intended for general purpose industrial or laboratory use. They are not intended nor certified for use in life-critical medical, nuclear, or aerospace applications, or for use in hazardous locations.

EXCLUSIVE REMEDIES

The remedies provided herein are Buyer's sole and exclusive remedies. In no event shall Laurel be liable for direct, indirect, incidental or consequential damages (including loss of profits) whether based on contract, tort, or any other legal theory.