

# GEN 1 ETHERNET MANUAL

- LNET & LNET485 modules for Series 2 Digital Panel Meters & Counters (Ethernet ordering options 7 & 8)
- LTE and LTSE Series Ethernet Transmitters.



**LAUREL Electronics Inc.**

3183-G Airway Ave, Costa Mesa, CA, 92626, USA

Tel: (714) 434-6131 Fax: (714) 434-3766 Website: [www.laurels.com](http://www.laurels.com)

# 1. TABLE OF CONTENTS

1.	Table of Contents .....	2
2.	Applicability.....	3
3.	Ethernet Primer & Definitions .....	4
4.	Network Configuration Examples .....	6
5.	How To Use Instrument Setup PC Software.....	9
6.	How To Set Up Nodes Using Node Manager PC Software .....	18
7.	How To Set Up Nodes Using Their Built-In Web Server .....	31
8.	Troubleshooting Hints.....	43

## 2. APPLICABILITY

**This Ethernet Manual** applies to 1/8 DIN size Laureate digital panel meters, counters and timers with a Gen 1 **LNET** or **LNET485** Ethernet communication board, and to Laureate Gen 1 **LTE** and **LTSE** Series DIN-rail Ethernet transmitters. Details are as follows:

- **LNET Ethernet board.** Plugs into a host 1/8 DIN Laureate Series 2 digital panel meter, counter or timer. Provides an RJ45 connector for a 10/100BaseT Ethernet interface to a PC or Local Area Network (LAN). Before using this board with your meter, verify that the meter is a Laureate Series 2 meter. The meter can be ordered with a choice of displays, signal conditioner boards, relay output boards, and analog output boards. For new applications, order the new, faster **LNET1 Ethernet board** (introduced in 2022).
- **LNET485 Ethernet-to-RS485 gateway board.** Plugs into a host 1/8 DIN Laureate Series 2 digital panel meter, counter or timer. Provides an RJ45 connector for a 10/100BaseT Ethernet interface to a PC or Local Area Network (LAN), plus an RJ11 connector to serve as a Modbus Master for up to 31 meters on an RS485 bus. RS485 wiring is via commercial straight-through 6-wire data cables with RJ11 connectors (Laurel P/N CBL03). The host meter can be ordered with a choice of displays, signal conditioner boards, relay output boards, and analog output boards, and will function as a normal meter.
- **LTE Series Ethernet transmitters.** These DIN-rail mounted instruments provide an RJ45 connector for a 10/100BaseT Ethernet interface, plus a 4-20 mA, 0-20 mA or 0-10V isolated analog output and two 120 mA AC/DC solid state relays. The Ethernet chip is on the transmitter main board. LTE transmitters accept the same signal conditioner boards as our 1/8 DIN size digital panel meters, counters and timers.
- **LTSE is serial input, analog output transmitter.** These DIN-rail mounted serial-to-analog converter provide an RJ45 connector for a 10/100BaseT Ethernet interface, plus a 4-20 mA, 0-20 mA or 0-10V isolated analog output and two 120 mA AC/DC solid state relays. The LTSE uses an LTE counter main board but no signal conditioner board. It responds to Modbus TCP/IP commands, not to streaming data, which is not supported by the Modbus protocol.

**Gen 1 Ethernet Nodes** and instruments attached to an LNET485 gateway Node can be accessed over a LAN or a WAN using the Modbus TCP/IP protocol once the Nodes have been configured by our [Instrument Setup \(IS\) software](#) (Section 5), by our [Node Manager software](#) (Section 6), or by our [Web Server firmware](#) (see Section 7), which is built into each Gen 1 Node.

### 3. ETHERNET PRIMER & DEFINITIONS

**An Ethernet node** is an Ethernet connection point. Node (with a capital “N”) refers to our Laureate Ethernet nodes. These run special firmware, which allows them to be discovered and configured by our Instrument Setup (IS) PC software, by Node Manager (NM) PC software, or by the Node’s built-in Web Server software. Configuration data is stored in flash memory of the Node.

**Instrument Setup (IS) software** is a free Window-based application that runs on a host PC. It can automatically discover all Nodes on the same Local Area Network (LAN) as the host PC, plus any RS485 devices connected to an LNET485 Ethernet-to-RS485 gateway board. It can rename the discovered Nodes and devices. It can scale the data to be displayed and output digitally, scale the analog output, set relay operation modes, and set setpoints for relay operation. While Laureate 1/8 DIN panel mounted meters can also be programmed from their front panel, Laureate DIN rail mounted transmitters can only be programmed with IS software. The host meter of an LNET485 Ethernet-to-RS485 gateway board can be programmed with IS software via the Ethernet link, but the remote meters on the RS485 bus can only be programmed from their front panel or via their RS485 interface using IS software. Laureate meters and transmitters require both jumper settings and software entries. Please refer to the instrument user manuals.

**Node Manager (NM) software** is a free Windows-based application that runs on a host PC. Like IS software, it can automatically discover all Nodes on the same Local Area Network (LAN) as the host PC, plus any RS485 devices connected to an LNET485 Ethernet-to-RS485 converter board. Only Node Manager software can be used to assign static IP addresses, change port numbers, change TCP connection timeout, set up emails or text message to be sent periodically or upon alarm, set up time zones for time stamped readings, and update Node firmware, as described in this manual. Once the configuration data has been stored in flash memory of all Nodes, Node Manager software can be closed. Unlike IS software, Node Manager software cannot be used to scale the display of the host meter, scale the analog output, set relay operation modes, or set setpoints for relay operation.

**Web Server capability** is built into each Node’s firmware to allow the Node to perform the same functions as Node Manager software except upgrading the Node’s firmware. A PC with a web browser is required. Once a Node is attached to a LAN, the router that controls the LAN will assign a unique IP address to the Node (such as 192.168.0.19). Entering that IP address as a URL into the browser will open the website and discover all other Nodes on the LAN.

**A MAC address** is an identifier assigned to each Node at our factory for permanent identification. That address is 6 bytes long and is unique in the world.

**An IP address** (e.g., 192.168.0.19) is used to address Ethernet nodes on a LAN or WAN. An IP address can be Static and Public so that it can be addressed on a WAN. An IP address can also be dynamic as assigned by a router or by another DHCP for addressing the same LAN. Dynamic IP addresses on a LAN are also called private or local IP addresses.

**Port numbers** are associated with each software application and serve as passwords for two-way packet transmissions. Default port numbers assigned to our Nodes are TCP port 502 for Modbus TCP transmissions, UDP port 63179 for UDP transmissions, and TCP port 80 for web server http:// transmissions.

**A router** is a device that bridges two networks and forwards data packets to their destinations on a LAN based on their IP addresses and port number. Normally a router will use its built-in DHCP server capability, and network devices will use their built-in DHCP client capability, to negotiate private (or local) IP addresses for all devices on the LAN.

**A switch** is a device that filters and forwards data packets between segments in the same network.

**DHCP server capability** is built into our Nodes. When a Node fails to find a DHCP server that responds to its request for a private IP address, it assigns one. When several Nodes fail to receive a Private IP address, they mutually agree to make one of the Nodes a temporary DHCP server that assigns a Private IP address to each device on the network. Built-in DHCP server capability allows Nodes to constitute themselves into a network and be connected directly to a host computer when no router or dedicated DHCP server is present. The time for Nodes to decide that there is no dedicated DHCP server is about 25 seconds. The Nodes are intelligent enough that when another DHCP server comes online, the temporary DHCP server Node relinquishes its unique status and seamlessly becomes a client network device.

**On a Local Area Network (LAN)** where the host computer is part of the network, our Nodes are discovered by our Instrument Setup Software or by Node Manager Software, which then lists the Nodes' MAC address and private IP address. When one of the discovered Nodes is selected, all of the active devices on that Node are discovered, and the following information is listed for each device: device name, address, type, revision, signal conditioner, protocol, communication settings, and reading format.

**On a Wide Area Network (WAN or Internet)** where the host computer is outside of the remote LAN, the public IP address of the router of the remote LAN must be entered for discovery of all Nodes on the LAN.

**Emails and text messages with device readings and alarm status** can be sent to a computer or to a smart phone when devices on a Node encounter an alarm condition, go on- or off-line, or at selected intervals. Emails containing device readings can also be sent from the Node in response to email requests. Each Node can be configured with an email account, recipient email addresses, and notification intervals. Setup of email and text messages is via Node Manager software.

**Modbus TCP** is the only communication protocol supported by Laureate Nodes, not Laurel's Custom ASCII protocol. Modbus TCP uses the same query-response format as Modbus RTU, but it includes headers and trailers to constitute Ethernet packets (or frames). When used with an LNET485 Ethernet-to-RS485 gateway Node, Modbus TCP is seamlessly converted by the Node to Modbus RTU for communication with the meters and transmitters on the RS485 bus. Note that the Modbus specification does not make provision for continuous data streaming, which is user selectable with RS232, RS485 or USB serial interfaces using the Custom ASCII protocol.

## 4. NETWORK CONFIGURATION EXAMPLES

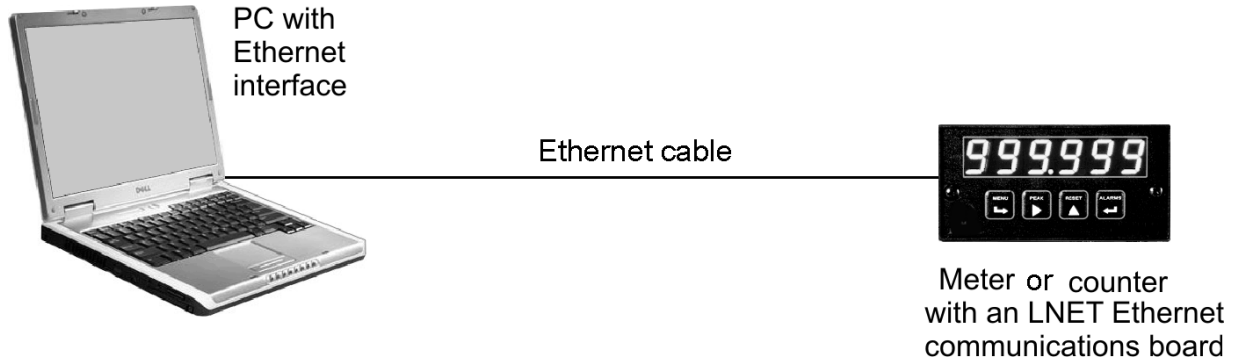

**Example 1.** The host PC has a direct Ethernet cable connection to a Laureate meter or counter with an LNET Ethernet board or to an LTE series transmitter. This is an easy way to program the Laureate using Instrument Setup software or to datalog readings from the Laureate to a PC using XLog2 Datalogging software.

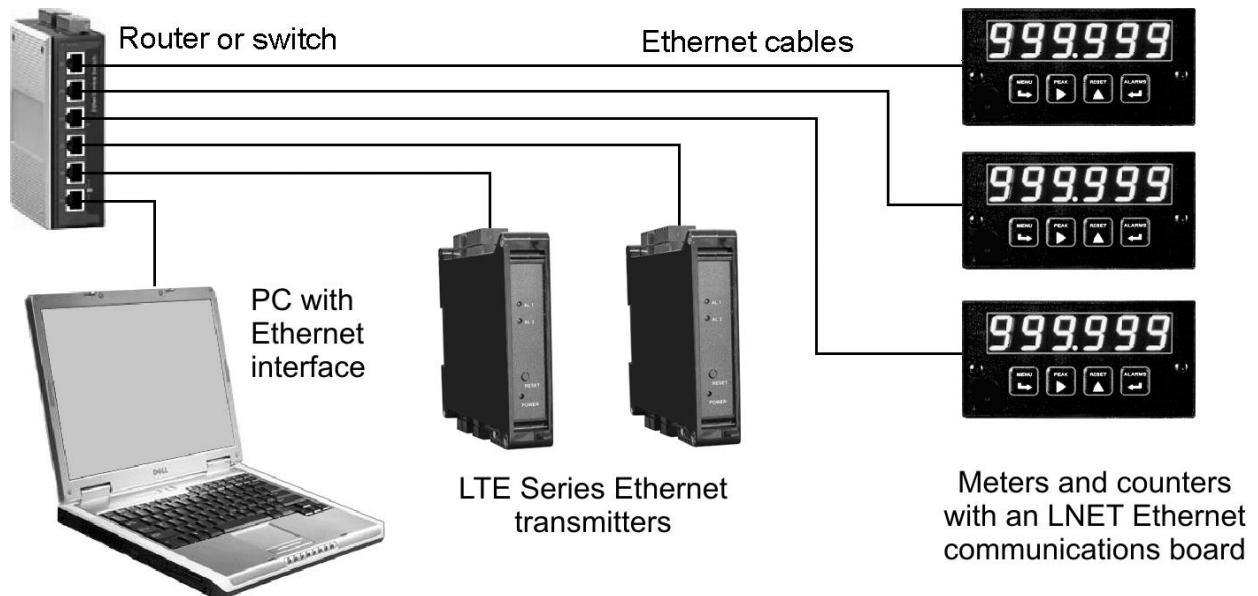

**Example 2.** The host PC is connected via an Ethernet cable to the same router or switch as multiple LNET or LTE Nodes so that the PC and Nodes are on the same LAN. The Nodes are automatically discovered by Instrument Setup software running on the PC, and their associated Devices (or instruments) can be set up by that same software. Nodes can also be discovered by using the Web Server built into each Node. To do so, use a web browser and enter the public IP address of the router or the IP address of any Node in the network.

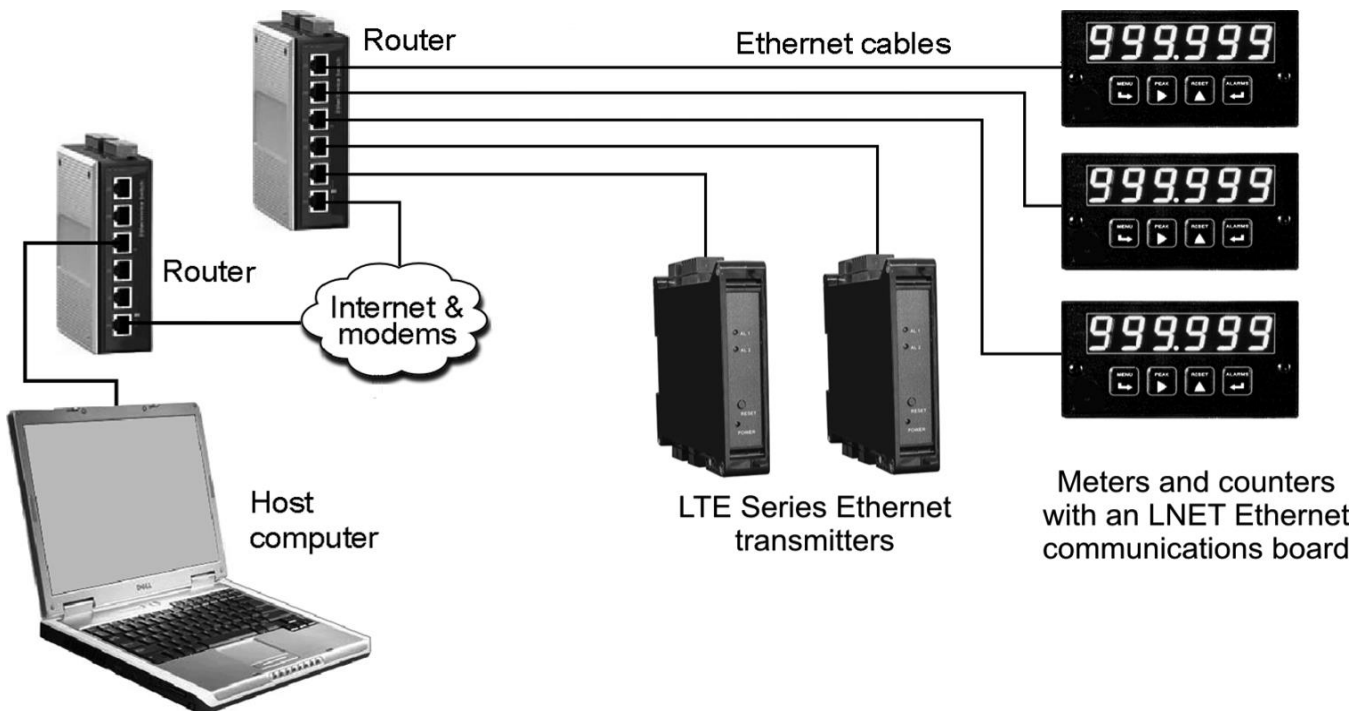

**Example 3.** For connection via the Internet, the PC can be plugged into a local LAN, and remote instruments can be plugged into a remote LAN. When the IP address of the remote router is supplied, Laureate Ethernet Nodes and any Devices attached to them via an RS485 bus are automatically discovered by our Node Manager software, Instrument Setup Software, or XLog2 Datalogging software.

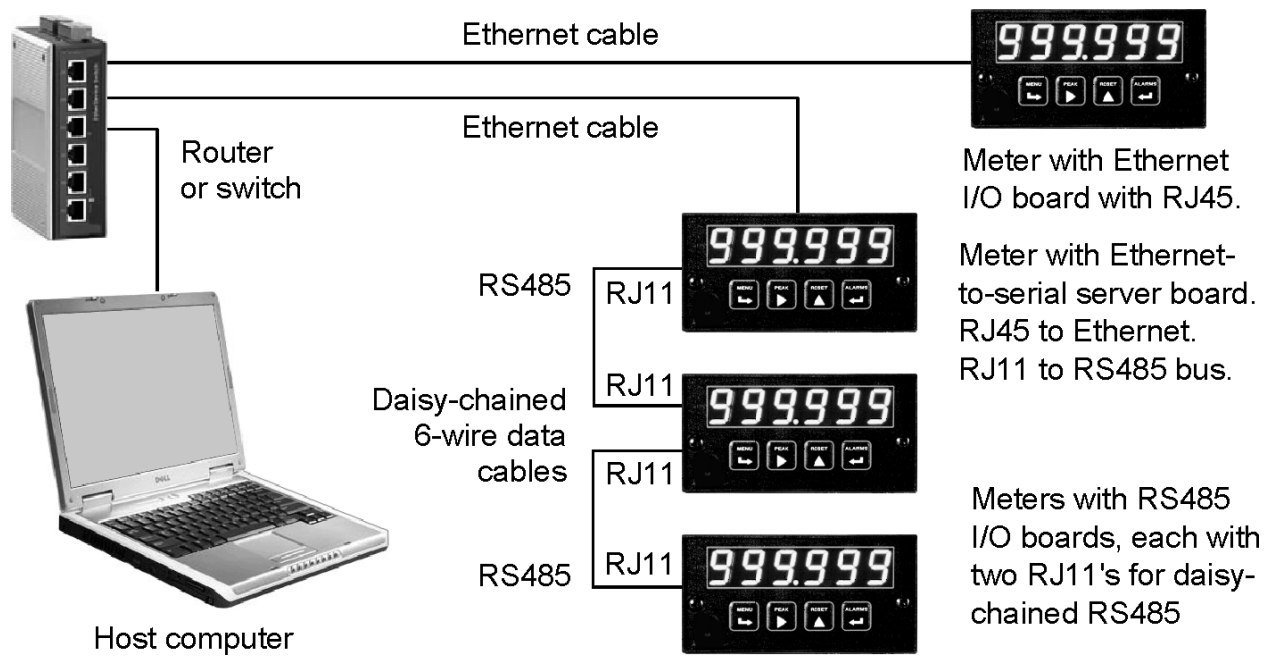

**Example 4.** Multiple Laurel meters can be connected to the single Ethernet port of a PC if the first meter is equipped with an LNET485 Ethernet-to-RS485 gateway board. With this board, the host first meter can take measurements and also act as the gateway to up to 31 remote meters on a half-duplex RS485 bus. The remote meters need be equipped with an L485 RS485 communication board and be daisy chained using 6-wire data cables (Laurel P/N CBL03). All meters with an RS485 interface are automatically discovered by our Instrument Setup software, Node Manager software, or XLog2 Datalogging software.



## 5. HOW TO USE INSTRUMENT SETUP (IS) PC SOFTWARE

**Instrument Setup (IS) Software** is a tool to program Laureate digital panel meters, counters, timers and transmitters when communications and a PC connection are available. While digital panel meters can also be programmed from their front panel, IS software is required to program LTE and LTSE series DIN-rail mounted Ethernet transmitters. Programming includes changing the instrument's protocol from the Custom ASCII protocol to the Modbus RTU protocol, scaling the items to be displayed or transmitted, scaling the instrument's analog output, setting the instrument's relay operating modes, setting the setpoints of relays, and setting other parameters, like signal filtering. To avoid errors, ensure that only one copy of IS software is running at the same time.

**Programming the host instrument.** IS software can use the Ethernet link from the PC to the host instrument of a Laureate Node to program and scale the host instrument. The Node can be the LNET or LNET485 Ethernet board of a Laureate meter, or the Ethernet chip inside a Laureate LTE or LTSE series transmitter. The communication protocol to which the host instrument is set for IS software to work can be Custom ASCII, Modbus RTU or Modbus ASCII.

**Programming remote instruments.** IS software cannot use the Ethernet link from the PC to the host instrument to program remote instruments on the RS485 bus connected to an LNET485 gateway board inside a host instrument. The remote instruments need to be programmed from their front panel if they are meters, or via IS software with a direct RS485 connection to the PC if they are LT series RS485 transmitters. The PC connection is normally via Laurel's cables CBL02 and CBL04, which connect the RS485 port of the LT transmitter to the USB port of the PC.

**Programming on the fly.** Once Laureate instruments have been connected directly to a PC or to the same LAN as the PC and the communication protocol has been set to Modbus RTU/TCP, these can be programmed on the fly using Modbus TCP commands (same as Modbus RTU commands). Please see our separate [Modbus Communication Manual, Analog Input](#) and [Modbus Communication Manual, Pulse Input](#).

**To install Instrument Setup software,** first set User Account Control (UAC) of your version of Windows to "Never notify" so that the installation can create directories. Use Google for instructions on how to change UAC. Power down and restart your computer for the UAC change to take effect. Download the compressed file [IS3\\_5\\_4.exe](#) from our website onto your PC. Double-click on the downloaded file to unzip it into a temporary directory, such as C:\temp. Double-click on setup.exe and follow the prompts to install the software on your PC. Create a desktop icon. Following installation, you may return UAC to its previous security setting.

**To establish Ethernet communications** with IS software, connect the Ethernet port of your PC directly to the Laureate instrument, or connect it to the same LAN as the instrument. Ensure that the instrument is under power. Start IS software by clicking on Start => Programs => IS2 => IS2 or on the desktop shortcut that you may have established. This will open the Communications screen (shown below). Click on "Ethernet", which will open the "Node Discovery" screen.



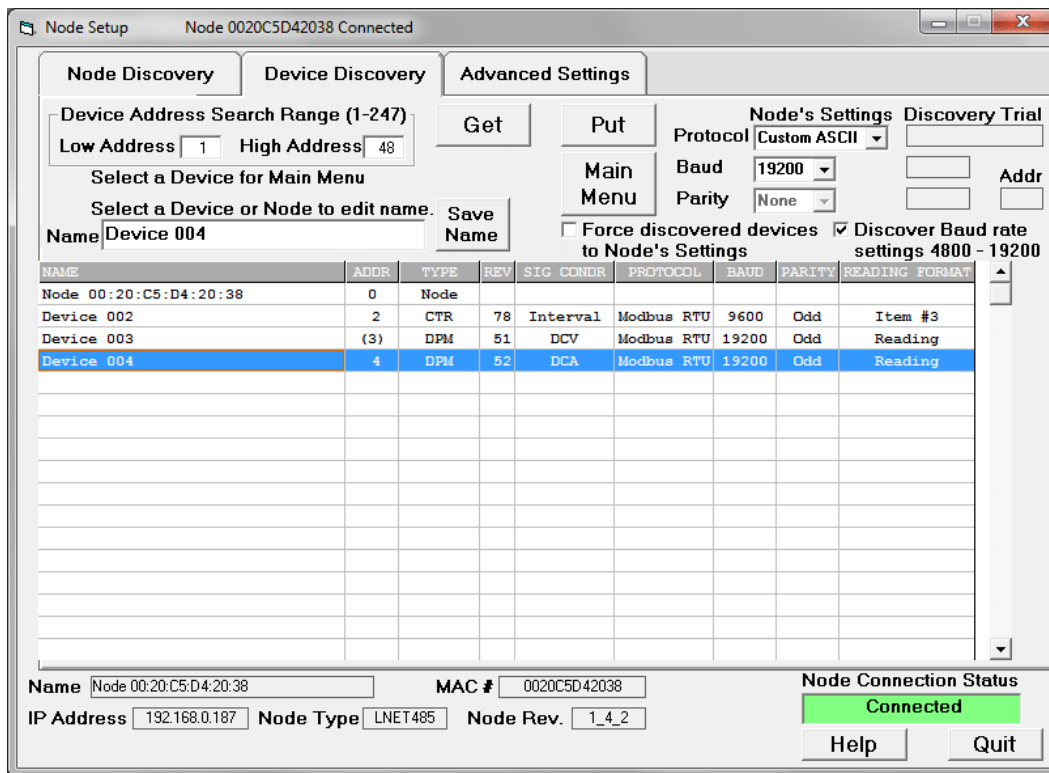

To discover remote devices on an RS485 bus interconnected by Laurel's CBL03 data cables:

- Jumper the LNET485 board and the remote L485 boards for half-duplex RS485.
- Set the LNET485 host meter and remote L485 meters to Modbus RTU from the front panel by setting "SEr 4" to 010.
- Enter different Modbus addresses from 1 to 247 for the host meter and remote meters from their front panel by entering the value under "Addr." The factory default address is always 1.

Setup of meters and transmitters requires both jumper settings and software selections. The instruments cannot sense the jumper settings, so this information needs to be provided either from the front panel of a meter or via IS software. For use with IS software:

- The host device of an LNET or LNET485 Node, or of the Node in an LTE transmitter, can be programmed via IS software regardless of the entered protocol (Custom ASCII, Modbus RTU or Modbus ASCII). Click on the discovered host device, whose row will then turn blue.
- Remote instruments on an RS485 bus (remote meters with an L485 communication board or remote LT series transmitters) cannot be programmed via IS software through an LNET485 board. These need to be programmed from their front panel or via IS software when they are connected directly to the PC via RS485. LT series transmitters can only be programmed by connecting them directly to a PC via RS232 or RS485.

Click on the Main Menu button to use IS software for setup of the host meter of an LNET or LNET485 Node, or for setup of an LTE or LTSE Ethernet transmitter.

In the resulting DPM or Counter Main Menu screen, which is a mostly blank screen, go to “DPM” or “Counter,” and execute a “Get Setup” to upload the setup data from the selected Device to your PC. Then click on “View” and “Setup.” The resulting Setup screen will allow you to view and change Device setup parameters. After making changes, click on “Main Menu”. In the resulting DPM or Counter Main Menu screen, go to “DPM” or “Counter,” and execute a “Put Setup” to download the changed setup data into your selected Device.

The Input+Display tab will display the input and output board types that the microcomputer board of your meter has discovered. The microcomputer board cannot read jumper positions, so enter input range information into this screen. Laureate instruments work in counts. Select the position of the decimal point, which does not affect the arithmetic in counts. Select 50 Hz or 60 Hz AC line frequency for noise rejection purposes. Refer to your instruments’ user manual for details.

The screenshot shows the 'Input+Display' configuration screen with the following sections:

- Option Boards:**
  - BASIC
  - EXTENDED
- Sig Cond Option:** DC
- Relay Option:** 2-Relay Board
- Comm Option:** RS485/U/E/ME
- Analog Option:** 16 Bit Uni/Bipolar
- Signal Input:**
  - Mode: DC V
  - Range: 20.0V (dropdown menu is open showing 0.2V, 2.0V, 20.0V, 200.0V, 600.0V, Filtered)
  - Custom Curve: Disabled
  - Rate: Disabled
  - 50/60 Hz Line Freq: 60 Hz
- Display:**
  - Resolution: 4.5 Digits
  - Decimal Point: dd . ddd
  - Auto Tare: Disabled
  - Peak Button Action: Peak
- Control Inputs:**
  - Control Input 1: Meter Reset
  - Control Input 2: Meter Hold
  - Both Ctrl 1,2: Meter Reset
- Control Input Commands:**
  - Click True (button)
  - Click True (button)

**The Scaling tab** relates input counts to output (or displayed) counts. Scaling can be by means of three methods: 1) scale and offset method, where m and b coefficients are entered for a  $y = mx + b$  straight line fit, 2) coordinates of 2 points method, where two (x, y) points are entered to define the straight line, and 3) reading coordinates of 2 points method, which fits the straight line to two actual readings, thereby calibrating the instrument and transducer as a system. Refer to your instruments’ user manual for details.

Input+Display	<b>Scaling</b>	Filter	Relay Alarms	Communication	Analog Out	Lockouts
---------------	----------------	--------	--------------	---------------	------------	----------

**Scaling**

<input checked="" type="radio"/> <b>Scale, Offset &gt;</b> <input type="radio"/> <b>Coordinates &gt;</b> <input type="radio"/> <b>Reading Coord&gt;</b>	<b>Scale</b>	<b>Offset</b>		
	+00001.	+00.000		
	<b>Low In</b>	<b>Low Read</b>	<b>High In</b>	<b>High Read</b>
	+00.000	+00.000	+05.000	+03.600

**The Filter tab** provide a choice of filtering methods. For analog inputs, the factory default is the equivalent of a 9.6 sec RC time constant, which provides very stable readings for constant or slowly changing signals. Smart adaptive filtering allows the meter to respond in about 30 msec to actual changes in signal by resetting filtering. The threshold to reset adaptive filtering can be set to Low or High. Refer to your instruments' user manual for details.

Input+Display	Scaling	<b>Filter</b>	Relay Alarms	Communication	Analog Out	Lockouts
---------------	---------	---------------	--------------	---------------	------------	----------

**Filter**

<b>Time Constant</b>	<b>Threshold</b>	<b>Peak/Valley Value</b>
9.6 Sec	Low Adaptive	Filtered

- 150 mSec
- 300 mSec
- 600 mSec
- 1.2 Sec
- 2.4 Sec
- 4.8 Sec
- 9.6 Sec
- No Filter

The **Relay Alarms tab** allows you to define different action modes for operation, setpoints and hysteresis bands for two of four relays, as sensed. Relay setpoints are often changed on the fly using Modbus commands. Refer to your instruments’ user manual for details.

Use the **Communication tab** to set the communication protocol to Modbus RTU, which uses the same command set as Modbus TCP/IP and is required for Ethernet operation. Do this even if you launched IS software with the Custom ASCII protocol. Set your baud rate to 9600, not higher. To enter your change into your instrument, execute a “Put Setup” from the DPM or counter pull-down menu of the IS software Main Menu.

**Use the Analog Out tab** to control to define the rules for your instrument’s analog output. First inform the software of your range as set by jumpers. Then define the reading for the bottom of the range, like 4 mA, and the top of the range, like 20 mA. Refer to your instruments’ user manual for details.

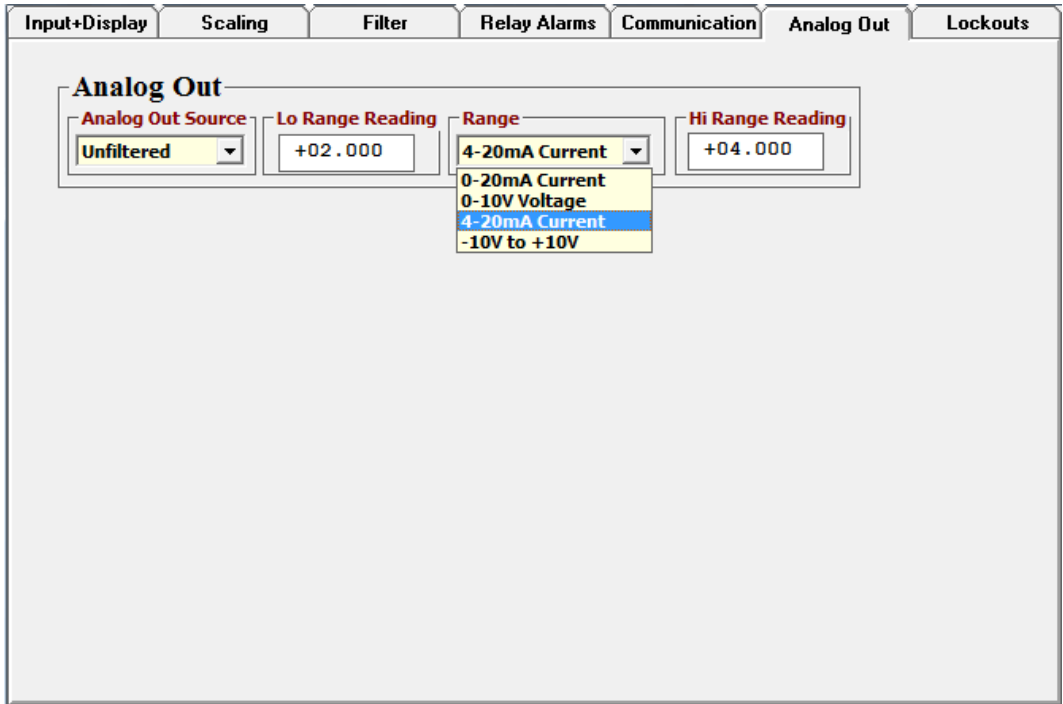

**Use the Lockouts tab** to protect meters by disabling front panel accessible menu items. Place a checkmark for all menu items to be disabled. To disable all menu items, place jumper “a” on the power supply board. Refer to your instruments’ user manual for details.

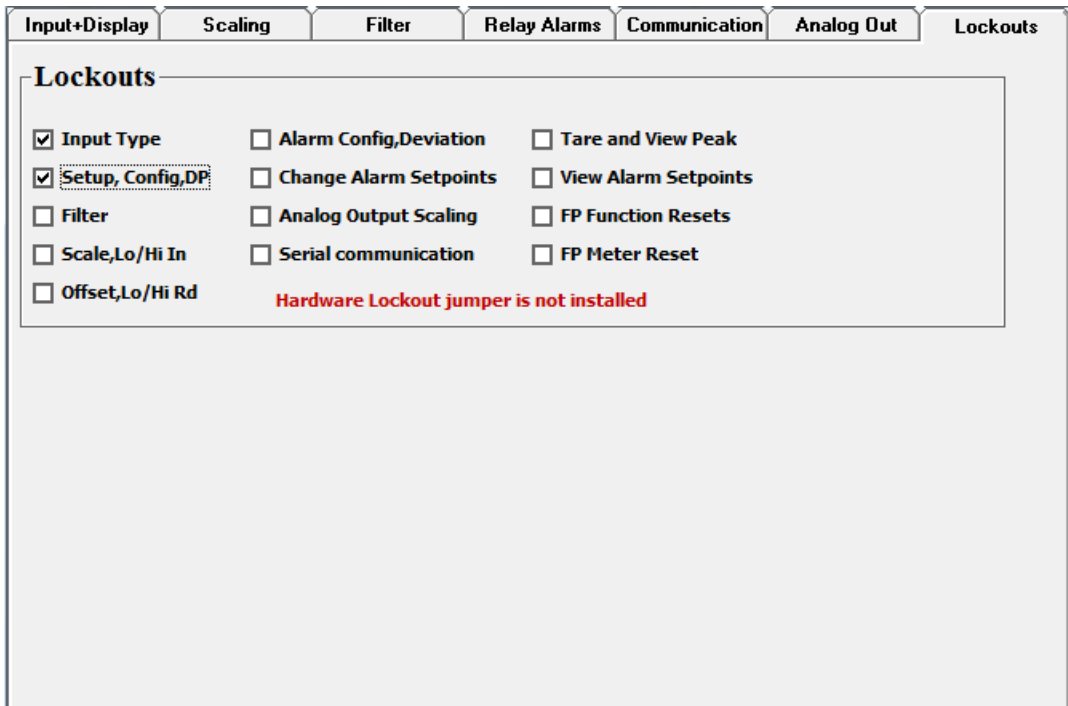

## Summary IS Software Operations:

- To select a meter or transmitter, highlight its associated Node under the Node Discovery tab, then click on the Device Discovery tab. All discovered meters and transmitters will be listed.
- To work on a discovered device, select it, then click on the “Main Menu” button.
- To retrieve device setup information from the device, click on Device => Get Setup.
- To retrieve device setup information from disk, click on File => Open Setup.
- To view and then edit that the retrieved information, click on View => Setup.
- To download the edited information back into the device, click on Device => Put Setup.
- To save the edited information to disk, click on File -> Save Setup.

## Additional Instrument Setup Software Features

**The Commands pull-down menu** in the menu bar at the top of the Main Menu allows execution of certain meter functions by using a computer mouse. With an Ethernet connection and Modbus RTU/TCP, these functions are limited compared to what would work with a serial RS232, RS485 or USB connection and the Custom ASCII protocol.

- The RESETS buttons allow Meter Reset (same as turning power on and off), Function Reset, Latched Alarm Reset, Peak Reset, Valley Reset, Tare Reset, and Remote Display Reset.
- The READINGS buttons can bring up the Latest, Peak or Valley readings.

**The Readings pull-down menu** offers the Display button. Clicking on it causes the meter reading to be displayed in the form of a large image on the computer screen.

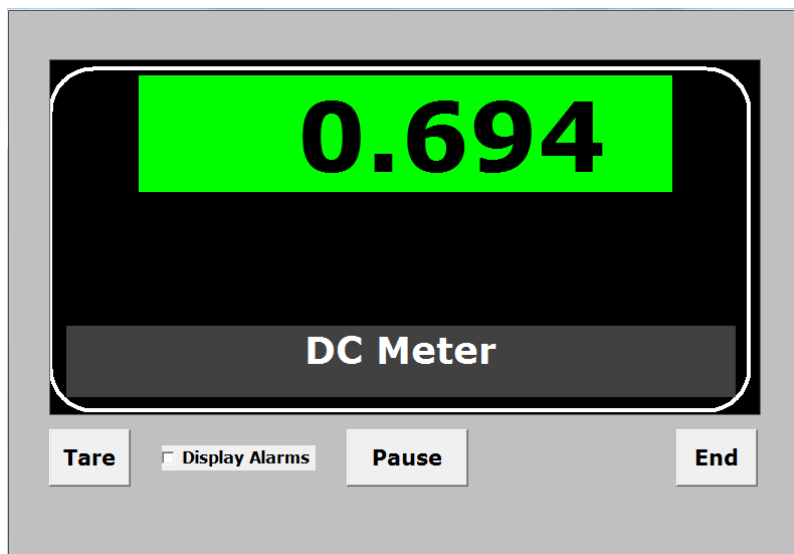



## 6. HOW TO SET UP NODES WITH NODE MANAGER PC SOFTWARE

**Node Manager (NM) software** is a free Windows-based application that runs on a host PC. Like IS software, it can automatically discover all Nodes on the same Local Area Network (LAN) as the host PC, plus any RS485 devices connected to an LNET485 Ethernet-to-RS485 converter board. Only Node Manager software can be used to assign static IP addresses, change port numbers, change TCP connection timeout, set up emails or text message to be sent periodically or upon alarm, set up time zones for time stamped readings, and update Node firmware, as described in this manual. Once the configuration data has been stored in flash memory of all Nodes, Node Manager software can be closed. Unlike IS software, Node Manager software cannot be used to scale the display of the host meter, scale the analog output, set relay operation modes, or set setpoints for relay operation. To install and use:

- 1. Connect all Nodes and RS485 devices.** The Nodes can be on the same LAN as the host computer or be connected to it via a WAN (Internet). They can also be connected directly to the host computer using a straight-through or cross-over Ethernet cable. Connection via a LAN or a straight-through cable is recommended for initial Node setup.
- 2. Install Node Manager Software on the host computer.** The self-extracting executable file [NodeMgr1\\_1\\_7.exe](#) can be downloaded from our website at no charge. To install, click on the .exe file and follow the prompts. The recommended installation directory is C:\Program Files\NodeMgr.
- 3. Launch NodeMgr.exe** by clicking on that file name or on the corresponding desktop icon that you may have created. A welcome splash screen will be displayed briefly, followed by the Node Discovery screen.
- 4. Discover all Nodes on the network (Node Discovery tab).** This is done automatically by Node Manager for all Nodes on a LAN upon entering the Node Discovery screen. When the Nodes are on a WAN (Internet), the public IP address of the router must be entered. Your Windows firewall settings must allow Node Manager to run, or Nodes will not be discovered.
- 5. Discover all devices attached to each server Node (Device Discovery tab).** This is done automatically and continuously for the Node's serial settings over the selected range of device addresses, also for all possible combinations of protocol, parity and baud rates of 4800, 9600 and 19200 if this option is checked.
- 6. Force serial settings of discovered devices to those of the server Node (Device Discovery tab).** Select the desired protocol, baud rate and parity for the Node, then check a box to force the discovered devices to the Node's settings.
- 7. Enter the time zone for each Node (Time Zone tab).** This time zone plus UTC/GMT time obtained by the Node over the Internet will allow the Node to send correctly time-tagged readings and alarm notifications via email or streaming data.

8. **Enter email addresses for each Node (E-Mail Addresses tab).** These addresses will receive readings and alarm notifications via email messages from the Node, as programmed.
9. **Set up the email account for each Node (E-Mail Account tab).** Enter the email address, incoming mail server and outgoing mail server so that the Node can receive and send email.
10. **Set up TCP and UDP ports (Advanced Settings tab).** Enter the TCP port, a second UDP port, and a TCP connection timeout. Also use the Advanced Settings screen to write Node setup data to disk and read it from disk.
11. **Upgrade the Node's firmware (Firmware Upgrade tab)** at no charge from our website when a new Node firmware version is available.

## GENERAL INFORMATION

**F1 Help Key.** Pressing the F1 Key for any tab or control item in the Node Manager program brings up comprehensive help information. To avoid executing a command item, right-click on the command button before pressing the F1 key.

**Get and Put Commands.** The Get command reads configuration data from the Node for display on the host computer. The Put command writes configuration data from the host computer into the Node. If a Put command is not executed before exiting a Node Manager screen, any entered changes will be lost. A warning message will be displayed first.

### Password Protection

A Node can operate with or without Password protection. If a Node is configured with Password protection, Node Manager allows node configuration data to be read with a Get command without a Password; however, any changes to Node configuration with a Put command require a valid password. For each session of Node Manager, the Password only needs to be entered the first time that a Put command is issued for that Node.

If a Password is not desired, "NoPassword" appears as the Password. This allows Node configuration changes to be made with only a "Continue" command from the Password screen.

Passwords consist of 1 to 16 case-sensitive alphanumeric characters. These are encoded for storing in the Node and for transmission over the Ethernet. Nodes can each have a different Password, or the same Password can be used for all Nodes.

A Node operating without Password protection can be changed to Password protection by unchecking the "Do not use Node Password protection" box and then entering the desired Password. If the Node is operating with Password protection, the Password can be changed by clicking on the "Change Password" button after first entering the current Password. The new Password is stored in the Node when the Continue command is clicked.

If you have forgotten your password, call the factory number shown in the opening screen of Node Manager. Please have Node Manager running, the Node connected, and the Password screen open when you call.

# 1. CONNECTION METHOD TAB

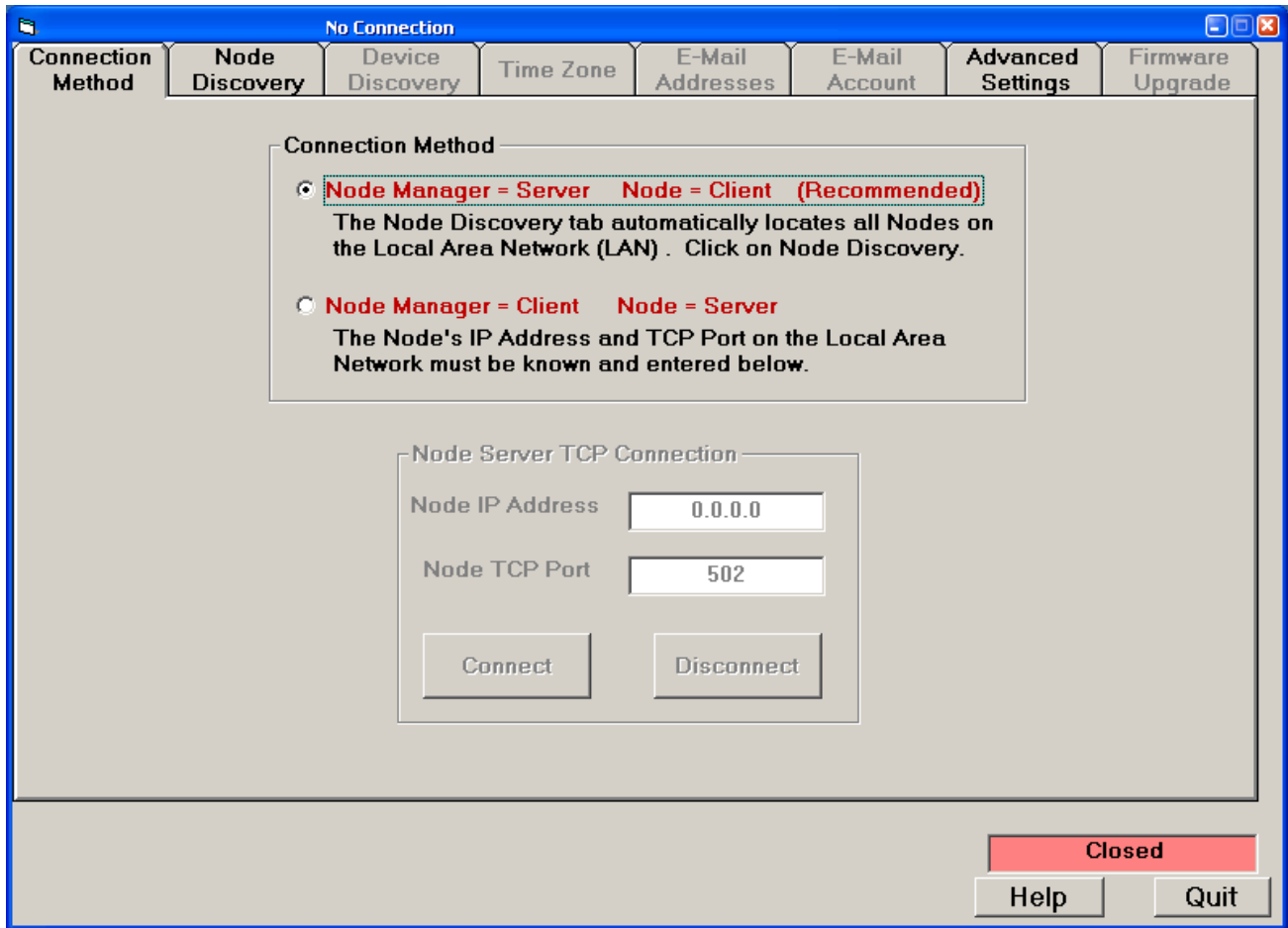

The PC-to-Node connection can be made by two methods:

Method 1: PC running Node Manager Software is the server, Node is the client.

The PC sends a broadcast signal to all of the Nodes via the UDP protocol, and requests them to send back their IP and MAC addresses. Node Manager then lists all of responding Nodes, and the user chooses the one of interest. Node Manager then notifies that Node to send a request for a TCP connection. When the Node Manager receives it, it sends an acknowledgement to the Node, and the connection is completed. This method has the advantage that the IP Addresses of all of the Nodes are discovered, and these do not need to be known beforehand. The Node Discovery tab is associated with this Connection Method.

Method 2: Node is the server, PC running Node Manager Software is the client.

To create a connection with a Node, the Node Manager must then know the Node's IP Address and TCP Port number. With this information, it sends a request for a TCP connection directly to the Node, which is constantly listening. The Node sends an acknowledgement, and the TCP connection is completed. This method does not require the use of the UDP protocol to make a connection. If the Node's IP Address and TCP Port are unknown, Method 1 can be used for Node discovery, and Method 2 can then be used.

## 2. NODE DISCOVERY TAB, LAN

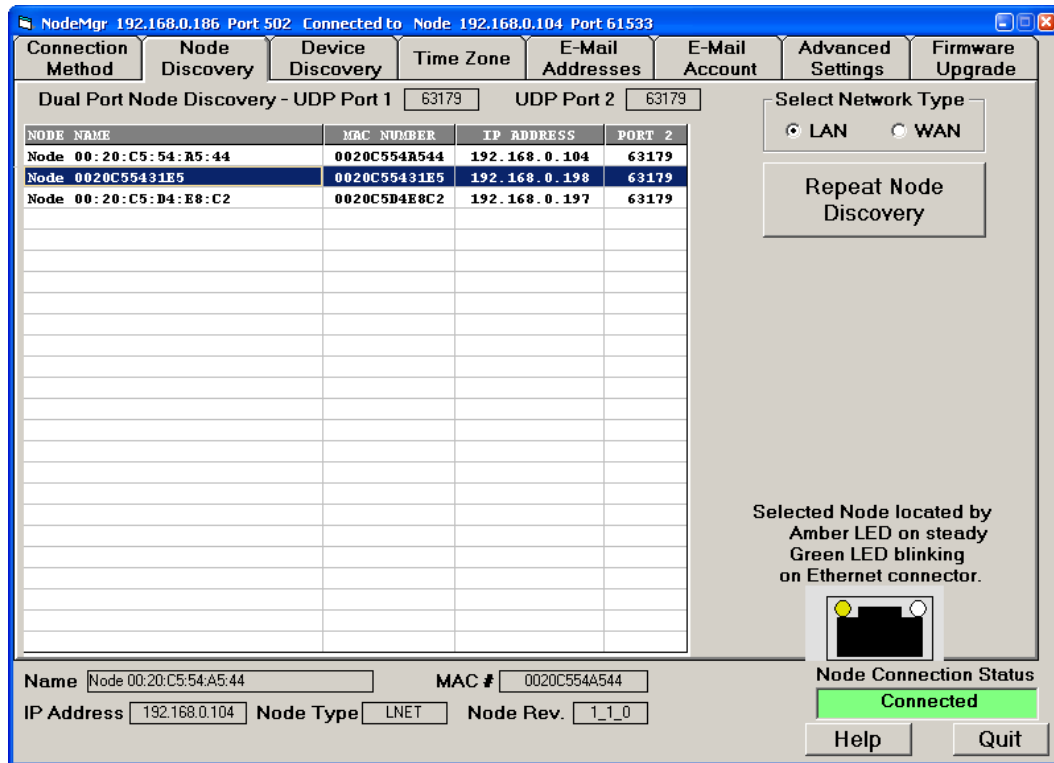

Nodes on a local LAN are automatically discovered under the Node Discovery tab when “LAN” is selected under “Select Network Type”. Nodes can be rediscovered at any time by pressing the “Repeat Node Discovery” button. Your Windows firewall settings must allow Node Manager Software to run, or Nodes will not be discovered. Check with your IT department if you suspect a firewall issue.

Node discovery uses UDP Port 63179. If this port is blocked by a router, go to the “Advanced Settings” tab. There you can change the Local TCP port number and enter a second UDP port number, which will then be used for discovery in addition to 63179.

A discovered Node must be selected before it can be configured. To select a Node, click anywhere on its line. The line should then be highlighted, the “Node Connection Status” field should change from “Closed” to “Connected”, and the RJ45 jack of the connected Node should show a steady amber LED and a blinking green LED. If the selected node is already connected to another host computer, a new connection cannot be made, and a Node Busy message will be displayed.

**Shown at the bottom of the screen** for each selected Node are the Node Name, Node MAC #, Node IP address, Node Type, and Node firmware revision.

### 3. NODE DISCOVERY TAB, WAN

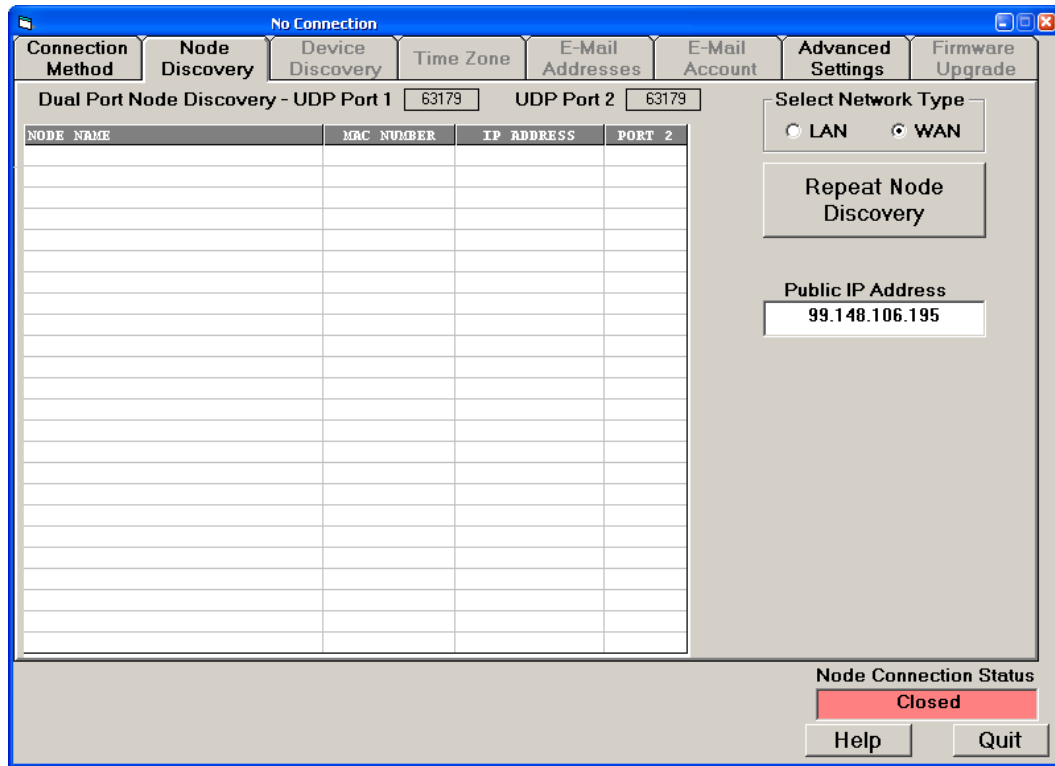

Nodes on a remote LAN are automatically discovered via the Internet by selecting “WAN” under “Select Network Type”, entering the Public IP Address of the router to which the Nodes are connected, and pressing on “Repeat Node Discovery”.

Node discovery uses UDP Port 63179. If this port is blocked by the router, go to the “Advanced Settings” tab. There you can change enter a second UDP port number, which will then be used for discovery in addition to 63179. All of our other Nodes must also be changed to the new UDP port.

Once discovered, individual Nodes can be selected for configuration by clicking on their line, as described on the previous page. Shown at the bottom of the screen for each selected Node are the Node Name, Node MAC #, Node IP address, Node Type, and Node firmware revision.

#### 4. DEVICE DISCOVERY TAB, NOT A DEVICE SERVER NODE

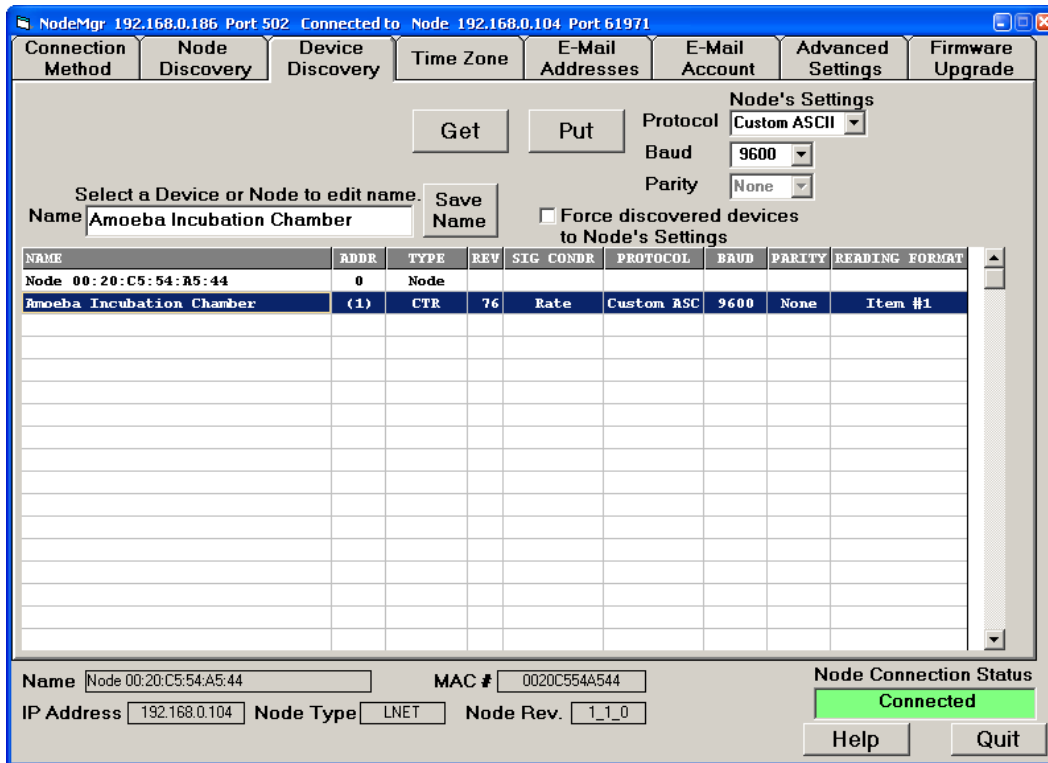

If the selected Node is an LNET Ethernet I/O board of a meter or an LTE Ethernet transmitter, only that single host meter or transmitter will be discovered as the device for that Node. If the selected Node is an LNET485 Ethernet-to-RS485 converter, the host meter and all RS485 meters on the RS485 bus will be discovered as devices. The Node itself will be shown with an artificially assigned address of 0. The address of the discovered device will be a number from 1-247 with the Modbus protocol. The address of the Node hosting device is always shown in parentheses ( ). For discovery, the Protocol under “Node’s Settings” must that of the device(s) to be discovered.

To force a discovered device to the Node’s settings (protocol, baud rate, parity), check the box “Force discovered devices to Node’s settings,” then press “Put” to save your data in the device.

To change the name of the Node or of a discovered device, select the item, enter the desired name, and press on “Save Name”. The new name will then be stored in the Node and will be included in emails and streaming data.

## 5. DEVICE DISCOVERY TAB, DEVICE SERVER NODE

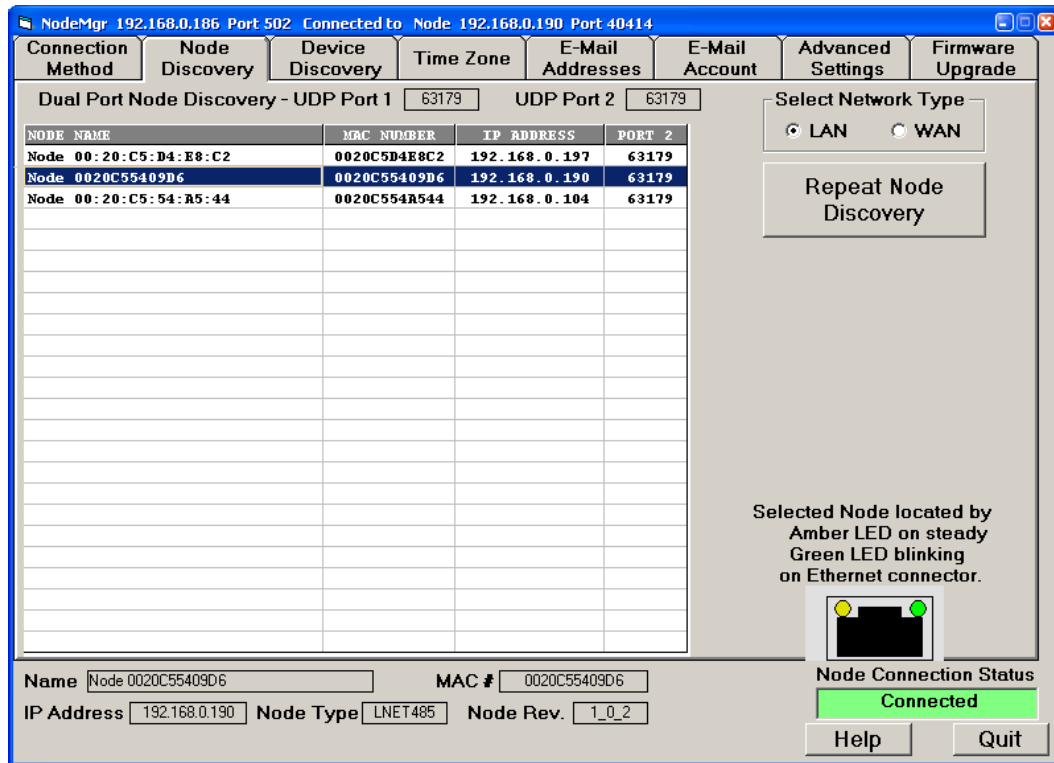

If the selected Node is the LNET485 Ethernet-to-serial device server option board of a meter, up to 31 RS485 physical devices may be discovered, including the host meter of the LNET485 option board. Since Modbus allows addresses of 1-247, there can be unused addresses.

Devices are being discovered continuously as the server Node tries different combinations of device address, protocol, baud rate, and parity. All devices with baud rates of 4800, 9600 or 19200 can be discovered as a group, regardless of their protocol, parity or address, by checking the box “Discover Baud rate settings 4800 - 19200” and then pressing “Put”. Devices with baud rates below 4800 baud can be included in the discovery process by entering their serial settings under “Node’s Settings” and then pressing “Put“. The combination being tried at any moment for device discovery is displayed under “Discovery Trial” in the upper right of the screen. To speed up discovery, enter the narrowest possible address range, then press “Put”. Also avoid searching at baud rates below 4800 if these are known not to apply.

Set the same serial settings for the Node and all listed devices. Make your selections under “Node’s Settings” (protocol, baud rate, parity), check the box “Force discovered devices to Node’s settings”, then press “Put” to save your data in the Node.

## 6. TIME ZONE TAB

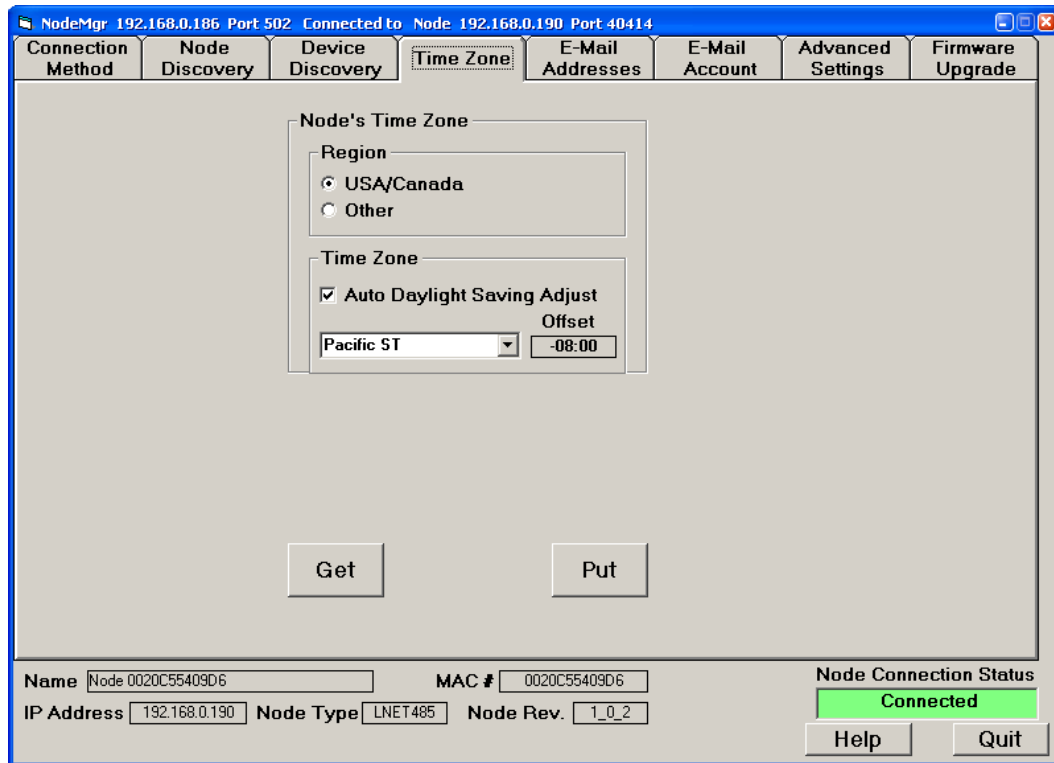

A time stamp is included in email messages and in streaming data sent by the Node. If the Node has a path to the Internet (also required for email), the Node will automatically obtain accurate UTC/GMT time (Coordinated Universal Time or Greenwich Mean Time) from an online time server. The Node's time zone or the offset from UTC/GMT time must be also supplied using this screen.

To set the Node's time zone, select the Region as "USA/Canada" or "Other". If the selected Region is "USA/Canada", the program offers eight selectable time zones, each with the corresponding offset from UTC/GMT in hours. The offset is corrected for Daylight Saving time if that box is checked. If the selected Region is "Other", the offset from UTC/GMT needs to be entered in +/- hh:mm format. If the offset time for a particular region is unknown, go to an Internet source such as [www.timetemperature.com](http://www.timetemperature.com). To enter your selections, press "Put". To read previously entered selections, press "Get".

Note: Only one instance of Node Manager can connect to the same Node at the same time.



## 7. EMAIL ADDRESSES TAB

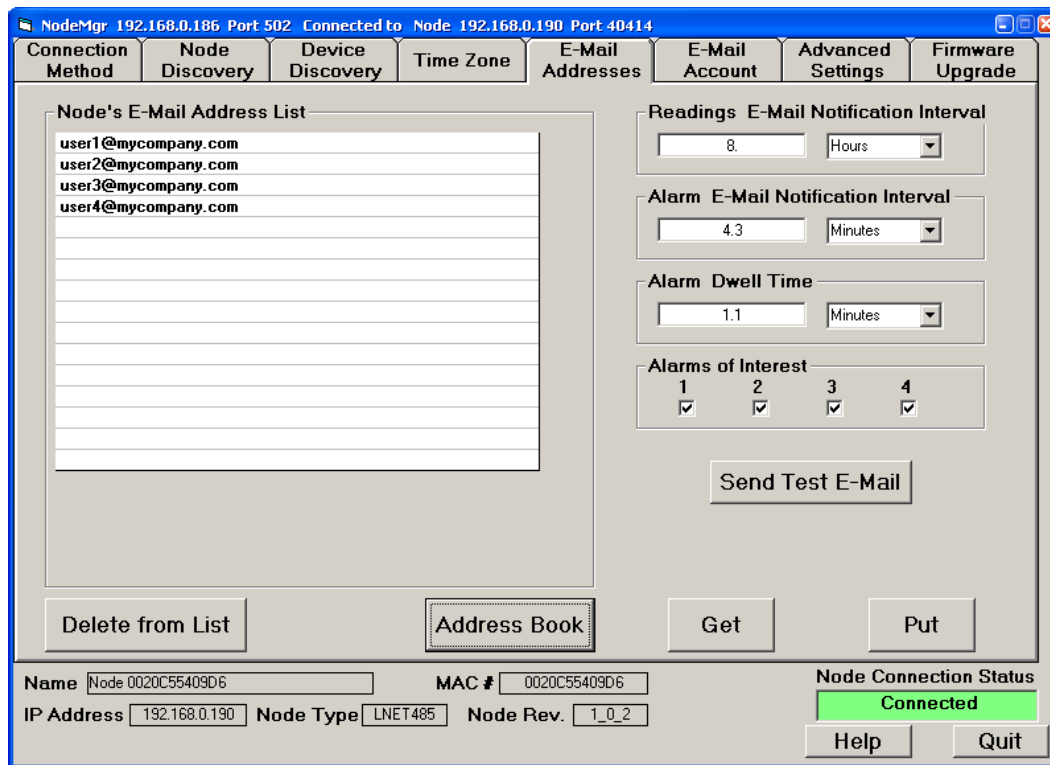

Readings and alarm notifications can be emailed by the Node to a list of email addresses stored in the Node.

Node's E-Mail Address List displays email addresses stored in the Node that will be receiving emails from the Node. To retrieve that list from the Node, press on "Get". To delete an address from the Node, highlight it, press on "Delete from List", then press on "Put".

Address Book is a new window (see next page) which displays email addresses stored in the host computer under Node Manager. To reduce typing time, these addresses can be downloaded into multiple Nodes, not just the currently active Node. To remove an email address from Address Book, select it, then press on "Remove Selected Book Address". To download email addresses from Address Book into the Node's E-Mail Address List (shown above), select them, then press on "Add Selections to Node's List". This will close the Address Book window. To download the Node's E-mail Address List to the Node, press on "Put".

Readings Email Notification Interval. The readings of all devices connected to the Node are emailed to all email addresses in the Node at this selected time interval. Reading emails are disabled by entering an interval of 0 (hours or minutes).

Alarm Email Notification Interval. An alarm notification email can be sent to all email recipients each time the alarm status of a device connected to the Node changes. To reduce the number of emails, this interval dictates the minimum time between consecutive emails. Alarm emails are disabled by entering an interval of 0 (hours, minutes or seconds).

Alarm Dwell Time. To reduce the number of emails, an Alarm Dwell Time is set so that an email message is sent only when the changed alarm state has lasted longer than this dwell time. If the alarm state changes during the dwell time, the dwell timer is reset.

Alarms of Interest. A device with alarms may have 2 or 4 alarms, some of which may not be of interest. To remove an alarm from Alarm Email Notifications, uncheck that alarm.

Send Test E-mail sends a test email to all of the Nodes' email recipients.

Commands can be emailed to the Node with only these capitalized words in the subject line:

LIST – Adds the sender's email address to the email list in the Node.

DELIST – Removes the sender's email address from the email list in the Node.

ACQUIRE – Requests the last readings of all devices under this Node.

IDENTIFY – Requests the MAC address of the Node.

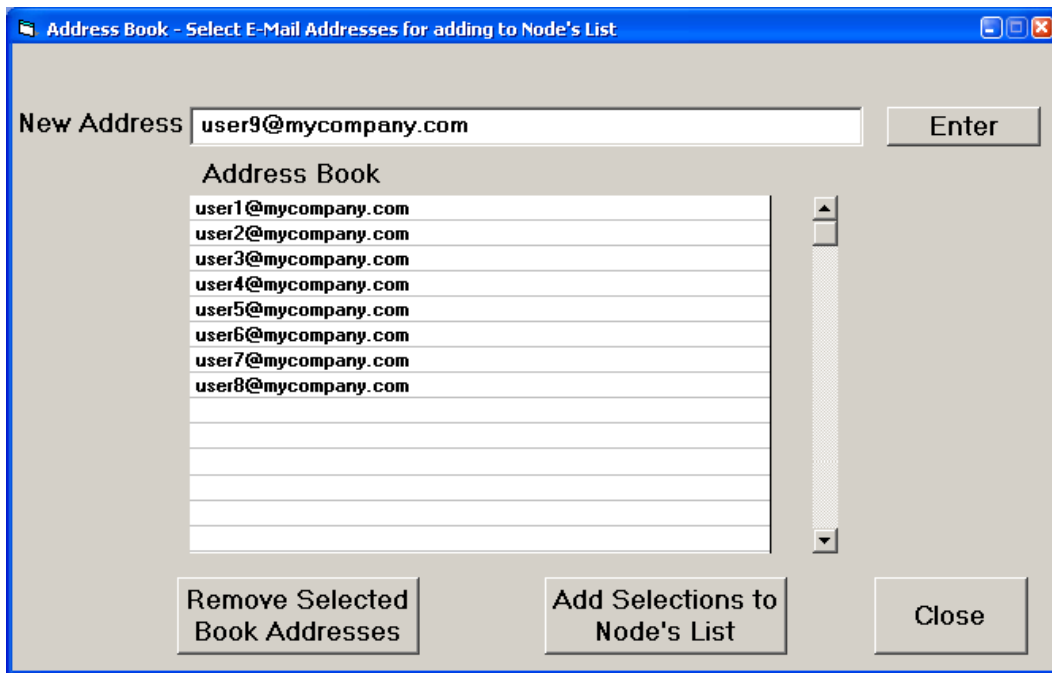

Note: Only one instance of Node Manager can connect to the same Node at the same time.

## 8. EMAIL ACCOUNT TAB

The screenshot shows the 'E-Mail Account' tab in the Node Manager software. The window title is 'NodeMgr 192.168.0.186 Port 502 Connected to Node 192.168.0.190 Port 40414'. The interface includes several sections for configuring email settings:

- Node's E-Mail Address:** A text field containing 'node1@mycompany.com'.
- Server Information (Names):** Fields for 'Incoming Mail (POP3)' (mail.mycompany.com) and 'Outgoing Mail (SMTP)' (relay.myisp.com).
- Incoming Mail (POP3) Server Logon Information:** Fields for 'Username' (node1) and 'Password' (masked with asterisks).
- Alternate Server Information (IP Addresses):** A section with a checkbox for 'Advanced User'. Below it are fields for 'Incoming Mail (POP3)' (112.41.0.0) and 'Outgoing Mail (SMTP)' (240.44.0.0).
- Server Ports:** A section with a checkbox for 'Advanced User'. Below it are fields for 'Incoming Mail (POP3)' (110) and 'Outgoing Mail (SMTP)' (25).

At the bottom, there are fields for 'Name' (Node 0020C55409D6), 'MAC #' (0020C55409D6), 'IP Address' (192.168.0.190), 'Node Type' (LNET485), and 'Node Rev.' (1\_0\_2). A 'Node Connection Status' indicator shows 'Connected' in a green box. 'Get' and 'Put' buttons are located between the IP and Port sections. 'Help' and 'Quit' buttons are at the bottom right.

A Node must have its own email account so that it can send and receive emails.

**Node's E-Mail Address.** Enter a unique email address for the Node so that it can receive email, then press on “Put”. That address will also be shown as the sender in emails from the Node.

**Server Information (Names).** Enter names for the Incoming Mail (POP3) and Outgoing Mail (SMTP) servers for the Node. This information should be the same as for other email clients on the same network. In MS Outlook, it is found under Tools > E-mail Accounts. It should also be available from the network administrator or company IT department.

**Advanced User Checkboxes.** If desired, IP addresses can be entered instead of names for the Incoming Mail (POP3) and Outgoing Mail (SMTP) servers, and server ports can be changed from their default settings. Standards are Port 110 for Incoming Mail and Port 25 for Outgoing Mail. While Outgoing Port 25 is the standard for sending email, it is also often used for sending spam, so Internet Service Providers may block it. If blocked, try Port 2525 or Port 587.

**Note:** Only one instance of Node Manager can connect to the same Node at the same time.

## 9. ADVANCED SETTINGS TAB

NodeMgr 192.168.0.186 Port 502 Connected to Node 192.168.0.190 Port 40414

Connection Method	Node Discovery	Device Discovery	Time Zone	E-Mail Addresses	E-Mail Account	Advanced Settings	Firmware Upgrade
TCP Port <input type="text" value="502"/>		UDP Port 2 <input type="text" value="63179"/>		Static IP Address <input type="text" value="0.0.0.0"/>		Gateway <input type="text" value="0.0.0.0"/>	
TCP Connection Timeout <input type="text" value="32"/> Seconds				Subnet Mask <input type="text" value="0.0.0.0"/>		0.0.0.0 indicates that a DHCP Server is supplying these parameters. If no DHCP Server, these parameters must be supplied.	
Minimum = 16 secs Maximum = 99 hours Disabled = 0 secs							
Parent Meter Interrogation <input checked="" type="checkbox"/> Enabled							
Disable only if there is a Serial Input Device connected to the Node							
<input type="button" value="Get"/>		<input type="button" value="Put"/>					
		<input type="button" value="Read Node Setup File"/>		<input type="button" value="Write Node Setup File"/>			
Name <input type="text" value="Node 0020C55409D6"/>		MAC # <input type="text" value="0020C55409D6"/>		Node Connection Status		<input type="button" value="Help"/> <input type="button" value="Quit"/>	
IP Address <input type="text" value="192.168.0.190"/>		Node Type <input type="text" value="LNET485"/>		Node Rev. <input type="text" value="1_0_2"/>		<input type="button" value="Connected"/>	

Change “Local TCP Port” from its default of 502 if that port value is blocked by your router.

Change “Remote Node UDP Port 2” from its factory default of 63179 if that port value is blocked by your router. Node discovery will use both Node UDP Port 1 at 63179 and Node UDP Port 2 at the value set using this screen.

Change “TCP Connection Timeout” from its factory default of 30 seconds if so desired. Minimum timeout is 16 seconds. Enter 0 to disable timeout. If no TCP activity is detected by the Node during the timeout, the TCP connection is broken by the Node.

Set “Parent Meter Interrogation” to “Enabled” so that the Node will read data from its host meter or counter. Set it to “Disabled” if the host device is a remote serial display or a serial-to-analog transmitter which does not supply data, otherwise the device will go into Reset.

Press “Put” to save your Advanced Setting changes in the Node.

Press “Read Node Setup File” to retrieve a previously saved Node setup file from disk.

Press “Write Node Setup File” to save your current Node setup to disk.

Enter the Static IP Address, Gateway and Subnet Mask if not supplied by a DHCP server.

## 10. FIRMWARE UPGRADE TAB

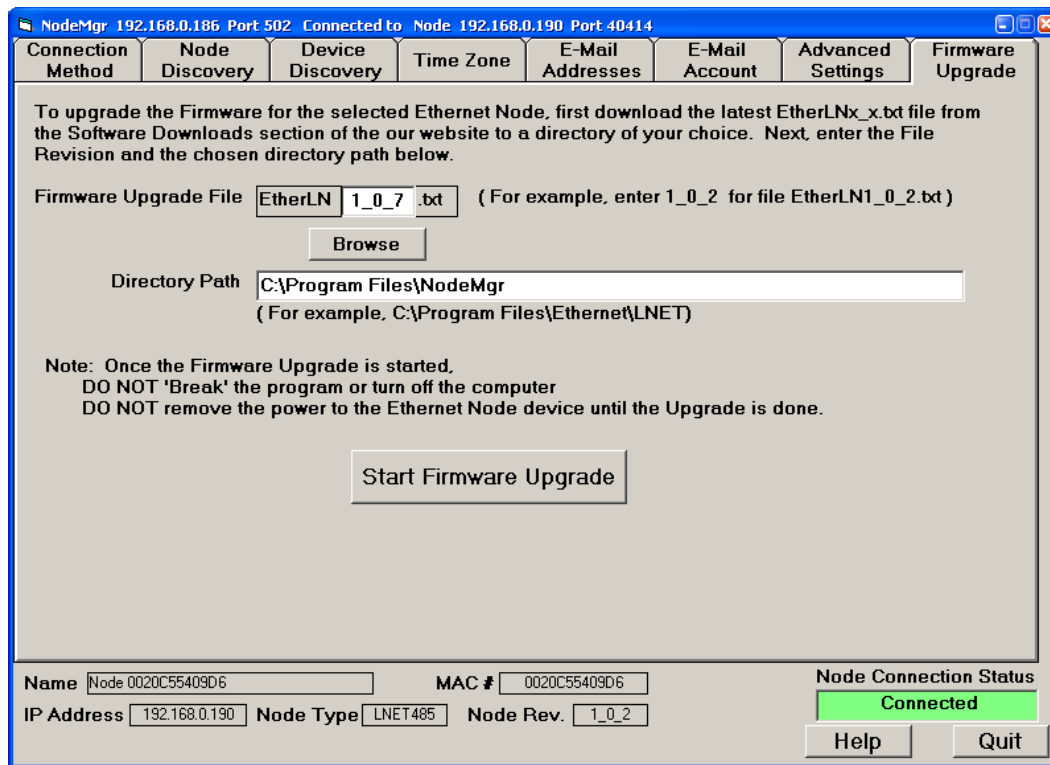

Node firmware upgrades are available from the factory at no charge and should be installed into each Node when available. Upgrading the firmware will not affect data stored in the Node.

To see if a Node needs an upgrade, click on the Firmware Upgrade tab and note the revision of the currently installed firmware. Then go to our web page <https://www.laurels.com/download-software.php> and note the latest posted revision, which is EtherLN1\_4\_3.txt as of the date of this manual. If the latest posted version is newer than the currently installed version, download it into a computer directory of your choice. This directory could be C:\Program Files\NodeMgr\ which is also recommended for the Node Manager executable file.

EtherLN1\_4\_3.txt overcomes a serious bug in the previous version EtherLN1\_4\_1.txt. That bug corrupted the registered MAC address supplied on an on-board EEPROM so that managed switches blocked Ethernet communications; however, the MAC address on the EEPROM remained unchanged. The upgraded firmware version EtherLN1\_4\_3.txt fixes that bug.

To upgrade a Node, connect to the Node. Use the “Browse” button to locate your download directory. Select your downloaded firmware file and press on “Open”. Then press the “Start Firmware Upgrade” button. A red box will appear indicating “Upgrade in Process”. While this indication is present, do not turn off your computer or disconnect the Node, as that could corrupt the firmware of the Node. Once the upgrade has been completed (in about 5 seconds), the box will turn green. To repeat for other Nodes, connect to each Node, then repeat the upgrade process.

## 7. HOW TO SET UP NODES WITH THEIR BUILT-IN WEB SERVER

A Web Server is built into each of our Nodes and hosts a website with an IP address, which can be entered into the URL field of a web browser or be the destination of a web link. The Web Server offers the same Node discovery and setup functions as Node Manager Software, except that only Node Manager Software can be used for Node firmware upgrades.

**All web server pages offer online help.** Simply click on the blue captions associated with each data entry field.

### How to get started:

- Node access with browser on same LAN as the Nodes. Once the IP address of any of our Nodes has been entered into your browser, all other Nodes will automatically be discovered by our Web Server and will be listed in the Node Discovery web page. An easy way to discover a first Node IP address (as well as all other Node IP addresses) is to use our Node Manager Software, as explained in the previous section of this manual.
- Node access over the Internet. If the browser is to access our Nodes on a remote LAN over the Internet, port forwarding must first be set up for the router that controls the remote LAN. The default port numbers programmed into our Nodes are UDP port **63179** for Node discovery, TCP port **502** for Modbus TCP, and TCP port **80** for http:// communications. If any of these ports are blocked by the router or a firewall, different port values can be entered into our Nodes, and you or your company's IT department will then need to set up the remote router to forward these different port values. Once port forwarding has been set up, simply enter the public IP address of the remote router into your browser. This will open our Node Discovery web page, which lists all of our Nodes on the remote LAN.

# 1. NODE DISCOVERY Web Page

Node :D4:20:38

## NODE DISCOVERY

---

NODE NAME	IP ADDRESS	TYPE	FIRMWARE	
Node :D4:20:38	<a href="#"><u>192.168.0.197</u></a>	LNET485	1_3_3	<a href="#">SETUP</a>   <a href="#">DEVICES</a>
Node :D4:40:72	<a href="#"><u>192.168.0.196</u></a>	LNET	1_3_3	<a href="#">SETUP</a>   <a href="#">DEVICES</a>
Node 00:20:C5:54:09:D6	<a href="#"><u>192.168.0.195</u></a>	LNET	1_1_4	<a href="#">SETUP</a>   <a href="#">DEVICES</a>

---

Date: Tuesday, March 19, 2013, 04:16 PM

Navigation: [LAN](#) | [NODE](#)

How to get here: Upon entering the public IP address of your router or the first IP address of a Node into your browser, this web page displays all LNET, LTE and LNET485 Nodes on the same LAN as the router.

**NODE NAME:** A Node's default name is "Node" followed by the Node's unique MAC address. This name may be changed by the user to a more descriptive name by clicking on SETUP.

**IP ADDRESS:** The Node's IP address, which can be entered into a web browser or be the destination of a web link.

**TYPE:** The Node's type (LNET, LNET485 or LTE). LNET is an Ethernet communication board in a 1/8 DIN instrument. LNET485 is an Ethernet-to-RS485 device server board in a 1/8 DIN instrument. LTE is a DIN rail mounted transmitter with an Ethernet interface. Clicking on TYPE brings up a FACTORY SETUP screen, which is password protected.

**FIRMWARE:** The Node's firmware version, which can be updated using Node Manager Software without loss of setup data. Check for the latest version, which can be downloaded from our website.

**SETUP:** A link to the NODE SETUP web page, which allows changes to the Node's time zone, name, LED status, and passwords.

**DEVICES:** A link to the DEVICE DISCOVERY web page, which lists all Devices (or instruments) attached to the Node. With an LNET or LTE Node, this will be a single meter or transmitter. With an LNET485 server Node, there can be a mix of up to 31 meters and transmitters on an RS485 bus.

**LAN:** A link to the NODE DISCOVERY screen (this screen), which lists all Nodes on the LAN.

**DEVICES:** A link to the DEVICE DISCOVERY screen, which lists all Devices attached to this Node.

## 2. NODE SETUP Web Page

Node :D4:20:38

### NODE SETUP

[DEVICE INTERFACE SETUP](#) | [EMAIL SETUP](#) | [NETWORK SETUP](#) | [NODE SETUP](#)

<b>TIME ZONE</b> <input type="text" value="Pacific"/>	<b>DAYLIGHT SAVING</b> YES <input checked="" type="radio"/> / <input type="radio"/> NO	<b>GMT OFFSET (SEC)</b> <input type="text" value="-28800"/>	<input type="button" value="GO"/>
<b>CHANGE NODE NAME</b> <input type="text" value="Node :D4:20:38"/>	<b>CHANGE LED STATES</b> <input type="text" value="0, Normal"/>		<input type="button" value="GO"/>
<b>CHANGE PASSWORD</b> <input type="text"/>	<b>CONFIRM PASSWORD</b> <input type="text"/>		<input type="button" value="GO"/>

Date: Tuesday, March 19, 2013, 04:33 PM

Navigation: [LAN](#) | [NODE](#)

How to get here: From the top navigation bar of the selected Node.

Background: A time stamp is included in email messages and in streaming data sent by the Node. If the Node has a path to the Internet (also required for email), the Node will automatically obtain accurate UTC/GMT time (Coordinated Universal Time or Greenwich Mean Time) from an online NTP time server. The Node's time zone, daylight saving time status, and the offset from UTC/GMT time are supplied using this screen.

TOP ROW: Links to DEVICE INTERFACE SETUP, EMAIL SETUP, and NETWORK SETUP screens for this Node.

TIME ZONE: Select one of the six listed North American time zones, or select "Other". This data will be used in the time stamp included in email messages and in streaming data sent by the Node. Press GO to enter any change.

DAYLIGHT SAVINGS: Indicate whether or not GMT Offset (Sec) should be automatically corrected for daylight saving time, which causes the local clock to be adjusted forward one hour in spring and backward one hour in autumn. This correction is only applied if a North American time zone was selected. Press GO to enter any change.

GMT OFFSET (SEC): When the Node has a path to the Internet (as required for email), it will automatically obtain accurate UTC/GMT time (Coordinated Universal Time / Greenwich Mean Time) from an online NTP time server. If a North American time zone was selected, this field will automatically display the offset in seconds from UTC/GMT time. If "Other" was selected, you need to enter the GMT offset in seconds. To obtain the required entry, do a Google search for "world time zones" and convert the listed offset in hours to seconds by multiplying by 3600. Press GO to enter any change.



**CHANGE NODE NAME:** Used to enter a descriptive name for the Node, such as "Tank 1 Level". If a custom entry is not made, the assigned default name is in the format Node :D4:20:38, where the word "Node" is followed by the Node's MAC address. Press GO to enter any change.

**CHANGE LED STATES:** Use the pull-down selections to change the color assignments of the two indicator LEDs on the RJ45 jack. Changing the color assignments may be used as a temporary diagnostic to identify a specific Node from its light pattern. Press GO to enter any change.

Normal operation is as follows:

- 1) Following power-up, the green and amber LEDs are on steady until an IP address has been assigned to the Node.
- 2) Once an IP address has been assigned to the Node, the amber LED is turned off. It will light up whenever the Node detects data packet activity.
- 3) When the Node has made a TCP connection, the green LED alternates on (1 sec) and off (1 sec), while the amber LED is on steady.

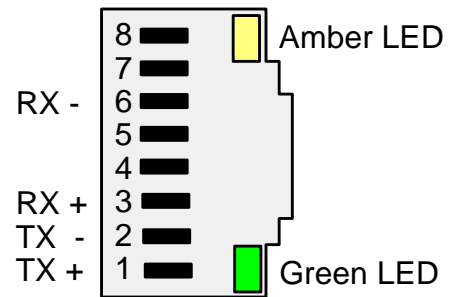

**Ethernet Indicators**

**CHANGE PASSWORD and CONFIRM PASSWORD:** If you wish to password protect the Node, enter the same password in these two fields. A Node can operate with or without password protection. If a password has been defined using this screen, this password will be required for any change to Node Setup, including changing the password. Passwords consist of 1 to 16 case sensitive alphanumeric characters, which are encoded for storing in the Node and for transmission over the Ethernet. Nodes can have the same or different passwords. If you have changed a password, you will be given a 5-minute grace period for the change to take effect. If you have forgotten your password, call the Laurel and ask for Ethernet Support. Please have the Node connected and the Node Setup screen open when you call.

### 3. DEVICE INTERFACE SETUP Web Page

Node 00:20:C5:D4:20:38  
**INTERFACE SETUP**

---

[DEVICE INTERFACE SETUP](#) | [EMAIL SETUP](#) | [NETWORK SETUP](#) | [NODE SETUP](#)

---

<b>SELECT DEVICE</b>		<b>CHANGE DEVICE NAME</b>	
<input type="text" value="15=Device 015"/>	<input type="text"/>	<input type="text"/>	<input type="button" value="GO"/>

---

<b>NODE PROTOCOL</b>	<b>BAUD RATE</b>	<b>PARITY</b>	<input type="button" value="GO"/>
<input type="text" value="Custom ASCII"/>	<input type="text" value="9,600"/>	<input type="text" value="No"/>	

---

<b>ALARM NOTIFICATION (SEC)</b>	<b>ALARM DWELL TIME (SEC)</b>	ALARM MASK: 1, 2, 3, 4	<input type="button" value="GO"/>
<input type="text" value="258"/>	<input type="text" value="66"/>	<input checked="" type="checkbox"/> 1 <input type="checkbox"/> 2 <input type="checkbox"/> 3 <input type="checkbox"/> 4	

---

<b>DATA EMAIL INTERVAL (SEC)</b>	<b>URL REFRESH RATE (SEC)</b>	<input type="button" value="GO"/>
<input type="text" value="28800"/>	<input type="text" value="16"/>	

---

Stop interrogating parent meter continuously? YES  /  NO  
 Force all Laurel devices to the node's communication setting? YES  /  NO

---

Date: Wednesday, April 22, 2015, 01:08 PM Navigation: [LAN](#) | [NODE](#)

How to get here: From the top navigation bar of the selected Node.

Background: The Device Interface Setup screen applies to the Node whose MAC address is shown in the top right of the screen.

Top row: Links to the EMAIL SETUP, NETWORK SETUP, and NODE SETUP web pages for this Node.

**SELECT DEVICE:** Click on the selector button to display all devices that have been discovered for the selected Node. If the Node is an LNET Ethernet I/O board of a meter, only that host meter will be discovered as the device. If the Node is an LNET485 Ethernet-to-RS45 gateway Node, up to 247 physical devices may be discovered, including the host device of the Node. There can be unused addresses. All device names are preceded by a number followed by an = sign. Click on a device name to select that device, and its name will then be shown in reverse font. You will then be able to make setup changes for the selected device using this screen.

**CHANGE DEVICE NAME:** To rename a device, first select the device using the "Select Device" field to the left, then enter a new desired name. Press GO to enter any change. The new name will then appear under "Select Device" preceded by the device number and an = sign. For example, you may change the name of the first device to "Boiler 1 Pressure" to make reports more understandable.

**NODE PROTOCOL:** Select Modbus for the device that has been selected under "Select Device". If only our devices are used, the node protocol, baud rate and parity are automatically selected in a plug-and-play mode as part of device discovery. Press GO to enter any change.

Use the Modbus TCP protocol to communicate over a LAN with our Nodes. This protocol is seamlessly converted by an LTNET485 Ethernet-to-RS485 gateway Node to Modbus RTU for communication with remote meters and transmitters on an RS485 bus. The Custom ASCII protocol is not supported with Ethernet.

The ? question mark protocol selection is a pass-through protocol where the Node simply passes through data packets to the LAN without modification in a tunneling mode. This feature should only be used to accommodate devices by other manufacturers and is not supported by Laurel.

**BAUD RATE:** Select the baud rate for the device that has been selected under "Select Device". Normally select 9600 baud, which is Laurel's default baud rate for all devices. Baud rates above 9600 may cause errors. Baud rates much below 9600 would cause unnecessary transmission delays. If only our devices are used, the node protocol, baud rate and parity are automatically selected in a plug-and-play mode as part of device discovery. Press GO to enter any change.

**PARITY:** Use the "Parity" field suitable for Modbus RTU. The factory default is "None." Press GO to enter any change.

**ALARM NOTIFICATION (SEC):** An alarm notification email can be sent to all email recipients each time the alarm status of a device connected to the Node changes. To reduce the number of emails, this interval in seconds dictates the minimum time between consecutive emails. Alarm emails are disabled by entering an interval of 0. Press GO to enter any change.

**ALARM DWELL TIME (SEC):** An alarm dwell time can be set in seconds to reduce the number of emails sent by the Node. An email message will only be sent when the changed alarm state has lasted longer than the dwell time. If the alarm state changes during the dwell time, the dwell timer is reset. Press GO to enter any change.

**ALARM MASK: 1, 2, 3, 4:** Check any boxes 1, 2, 3, 4 to receive alarm email mail notifications from any alarms 1, 2, 3, 4 the selected devices connected to the Node. If the device is one of our meters (DPM or counter), it can have 2 or 4 alarms. If it is one of our LT or LTE transmitters, it will have 2 solid state alarms. Not all alarms may be of interest for email notification. To remove an alarm from alarm email notifications, uncheck that alarm. Press GO to enter any change.

**DATA EMAIL INTERVAL (SEC):** The data readings of all devices connected to the Node are emailed to all email addresses in the Node at this selected time interval. Data emails are disabled by entering an interval of 0. Press GO to enter any change.

**URL REFRESH (SEC):** This is the time interval in seconds at the root pages for Node Discovery and Device Discovery self-refresh, thereby showing the latest Node and device discovery status. The default value is 16 seconds. Press GO to enter any change.

Stop interrogating parent meter continuously? The default is NO, which means that the Node continuously interrogates the parent meter or transmitter for data supplied by the signal conditioner board. Select YES if the node is housed in a serially driven remote display or in a serial-to-analog transmitter, neither of which has a signal conditioner board to interrogate. Failure to select YES will cause a serially driven remote display or serial-to-analog transmitter to reset.

Force all our devices to the Node's communication setting? All devices attached to an LNET485 Ethernet-to-RS485 gateway Node can have their own communication settings (baud rate, parity, protocol, and digital address). Select YES to force all discovered devices on a device server Node to the Node's communication settings, otherwise select NO. Press GO to enter any change.

## 4. EMAIL SETUP Web Page

Node :D4:20:38

### EMAIL SETUP

---

[DEVICE INTERFACE SETUP](#) | [EMAIL SETUP](#) | [NETWORK SETUP](#) | [NODE SETUP](#)

---

POP3 SERVER	POP3 USERNAME	POP3 PASSWORD	POP3 PORT	POP3 INTERVAL (SEC)
<input type="text"/>	<input type="text"/>	<input type="text"/>	<input type="text" value="110"/>	<input type="text" value="256"/>

---

SMTTP SERVER	SMTTP EMAIL ADDRESS	SMTTP PORT	<input type="button" value="GO"/>
<input type="text"/>	<input type="text"/>	<input type="text" value="25"/>	

---

<a href="#">DELETE</a>	<a href="#">ADD NEW EMAIL ADDRESS</a>	<a href="#">TEST EMAIL</a>	<input type="button" value="GO"/>
	<input type="text"/>	<input type="checkbox"/>	

---

Date: Friday, April 5, 2013, 08:52 PM

Navigation: [LAN](#) | [NODE](#)

How to get here: From the top navigation bar of the selected Node.

Background: An email account can be set up for each Node. This allows the Node to send data readings at periodic intervals, when it encounters an alarm condition, when it goes on-or off-line, or in response to email requests. Commands can also be emailed to the Node with these capitalized words in the subject line:

- LIST – Adds the sender’s email address to the email list in the Node.
- DELIST – Removes an email address from the email list in the Node.
- ACQUIRE – Requests the last readings of all devices under this Node.
- IDENTIFY – Requests the MAC address of the Node.

A powerful feature of our Nodes is the ability to send Alarm information to cell phones via text messages. This allows operators to receive alarm information within a couple of seconds wherever they are, even if they are in a meeting, at lunch, or outside the plant. Sending a text message in North America is as easy as sending an email. Specify the receiving address in the format below, which will vary with the cell phone carrier. “Number” is the 10-digit cell number without spaces or punctuation:

- AT&T: number@txt.att.net
- Qwest: number@qwestmp.com
- T-Mobile: number@tmomail.net
- Verizon: number@vtext.com
- Sprint: number@messaging.sprintpcs.com
- Sprint: number@pm.sprint.com
- Virgin Mobile: number@vmobl.com
- Nextel: number@messaging.nextel.com
- Alltel: number@message.alltel.com
- Metro PCS: number@mymetropcs.com
- Powertel: number@ptel.com
- Boost Mobile: number@myboostmobile.com
- Suncom: number@tms.suncom.com
- Tracfone: number@mmst5.tracfone.com
- U.S. Cellular: number@email.uscc.net

Top row: Links to DEVICE INTERFACE SETUP, NETWORK SETUP, and NODE SETUP web pages.

**POP3 SERVER:** The incoming mail server to be used for the Node. Enter the same name as for the other email clients on the same network, such as mail.mycompany.com. Press on the first GO to enter.

**POP3 USERNAME:** The username to be supplied to retrieve incoming email. It is tied to the Node's specific email address and is normally supplied by the network administrator or company IT department. Press on the first GO to enter.

**POP3 PASSWORD:** The password to be supplied to retrieve incoming email. It is tied to the Node's specific email address and is normally supplied by the network administrator or company IT department. Press on the first GO to enter.

**POP3 PORT:** A number which identifies the type of incoming email port. Leave at 110, which is the normal number for a POP3 port. The POP3 protocol assumes that there is only one client connected to the mailbox. On rare occasions, a network administrator or company's IT department may specify a different number. Press on the first GO to enter.

**POP3 INTERVAL (SEC):** The interval in seconds at which to Node will check email. Enter 0 to disable email checking. The maximum interval is over 4 million seconds. Normally do not check email more often than every 60 seconds. Press on the first GO to enter.

**SMTP SERVER:** The outgoing mail server to be used for the Node. Enter the same name as for the other email clients on the same network, such as mail.mycompany.com. Press on the first GO to enter. Press on the first GO to enter.

**SMTP EMAIL ADDRESS:** The email address that will be shown as the sender of the email. A typical email address would be in the format user1@mycompany.com. Press on the first GO to enter.

**SMTP PORT:** A number which identifies the type of outgoing email port. Normally leave the number at 25, which is the standard for sending email via SMTP. Since port is also often used for sending spam, Internet Service Providers may block it. If blocked, try Port 2525 or Port 587. Press on the first GO to enter.

**ADD NEW EMAIL ADDRESS:** Write in each email address which is to receive emails from the Node, then press GO. Addresses should be in the format user@mycompany.com. All entered addresses will appear below the email entry field, each preceded by a DELETE box.

**DELETE:** Check each box to the left of any previously entered recipient email address that you wish to delete from the Node, then press GO to execute. This will update the Email Setup screen.

**TEST EMAIL:** Check the Test Email box, then press then press GO to execute. This will send a test email to all email recipients that have been defined using the ADD NEW EMAIL ADDRESS field to the left, thereby verifying email operation.

## 5. NETWORK SETUP Web Page

Node :D4:20:38

# NETWORK SETUP

---

[DEVICE INTERFACE SETUP](#) | [EMAIL SETUP](#) | [NETWORK SETUP](#) | [NODE SETUP](#)

---

REFRESH NET	STATIC IP	GATEWAY IP	SUBNET MASK	GO
<input type="checkbox"/>	<input type="text" value="0.0.0.0"/>	<input type="text" value="0.0.0.0"/>	<input type="text" value="0.0.0.0"/>	<input type="button" value="GO"/>

---

TCP TIME-OUT (SEC)	MODBUS TCP PORT	HTTP PORT	GO
<input type="text" value="40"/>	<input type="text" value="502"/>	<input type="text" value="80"/>	<input type="button" value="GO"/>

---

DISCOVERY PORT	STEALTH MODE	AUTO-DISCOVERY	GO
<input type="text" value="63179"/>	<input type="radio"/>	<input checked="" type="radio"/>	<input type="button" value="GO"/>

---

NTP SERVER	NTP INTERVAL (SEC)	GO
<input type="text" value="pool.ntp.org"/>	<input type="text" value="86400"/>	<input type="button" value="GO"/>

---

Date: Saturday, April 6, 2013, 06:26 PM

Navigation: [LAN](#) | [NODE](#)

How to get here: From the top navigation bar of the selected Node.

Background: Each Node has an IP address which is used to address the Node on a local area network (LAN) or on the Internet (WAN). An IP address can be static and public so that it can be addressed on over the Internet and have an associated domain name. It can also be a dynamic address assigned by a router or other DHCP server on a LAN. Such an address is also called a private or local IP address. Our Node-resident firmware automatically discovers the IP address of all Nodes on a LAN or WAN, plus any Devices on the RS485 bus connected to an Ethernet-to-RS485 Device Server Nodes.

Top row: Links to DEVICE INTERFACE SETUP, EMAIL SETUP, and NODE SETUP web pages.

REFRESH NET: Enter a checkmark and press GO to refresh the Node's IP address on command from the network.

STATIC IP: Enter a static IP address for the Node if you want to be able to address the Node from anywhere over the Internet. An IP address is a 4-byte number (e.g., 192.168.0.57). Leave the entry at 0.0.0.0 if you want the IP address to be assigned dynamically by the router for the LAN on which the Node is located, or by the Node itself if there is no router or other DHCP server. Press GO to enter any change.

**GATEWAY IP:** Enter the static IP address of your LAN's gateway router if you want to be able to address your Nodes from anywhere over the Internet. This address is normally provided by your organization's IT department. Leave the entry at 0.0.0.0 if you do not want address your Nodes from anywhere over the Internet. Press GO to enter any change. A gateway router is a device which provides the entrance to a local area network (LAN). This is normally a router which assigns dynamic IP addresses and also serves as a firewall. A gateway can interface a first LAN to another LAN or to the Internet.

**SUBNET MASK:** Enter the subnet mask for your LAN's gateway router if you want to be able to address Nodes on the LAN from anywhere over the Internet and if a subnet mask entry has been requested by your organization's IT department. A subnet mask is a way of telling your router which network addresses it can consider local and which are remote. Leave at 0.0.0.0 to disable the subnet mask feature. Press GO to enter any change.

**TCP TIME-OUT:** Change "TCP Connection Timeout" from its factory default of **32** seconds if so desired. Minimum timeout is 16 seconds. Enter 0 to disable timeout. If TCP activity has not been detected by the Node for this timeout period, the TCP connection is broken by the Node. Press GO to enter any change.

**MODBUS TCP PORT:** Enter the TCP port number of the Node or leave that number at **502** if you have no reason to change. Press GO to enter any change. The standard TCP port number for Modbus is 502. It is possible to use a different port number, provided that both the client and server can be set to use a different port number. This may not be possible, and in most cases it will be most convenient to just use the standard port number 502. Our Node discovery software uses TCP port 502 and UDP port 63179.

**HTTP PORT:** Enter the HTTP port number of the Node or leave that number at **80** if you have no reason to change. Press GO to enter any change. By default, port 80 is used by URLs that begin with http:// and is the default port number for HTTP communications. Port 443 is used by URLs that begin with https:// . Only enter a port number other than 80 if that number has been blocked by the IT department and a different number has been supplied. If the port number is changed to anything other than 80, all web addresses that reference the Node must include that port number.

**DISCOVERY PORT:** Enter a second UDP port number if required. Leave the UDP number at **63179** if you do not require a second UDP port number. Press GO to enter any change. The TCP and UDP protocols specify a source and destination port number in their packet headers. A port number is a software construct associated with permissions for an application such as our Node discovery. Our Node discovery software uses TCP port 502 and UDP port 63179. If port 63179 is blocked by a router, this field can be used to enter a second UDP port number, which will then be used for Node discovery in addition to 63179.

**AUTO-DISCOVERY:** This default selection permits the Node to broadcast a 70-byte self identification message over the LAN every 15 seconds, a very light load on the network. This allows the Nodes to discover each other's IP Addresses, thereby greatly facilitating network setup and maintenance.



**STEALTH MODE:** This setting precludes the Node from broadcasting a 70-byte self-identification message over the LAN every 15 seconds. This setting should only be selected if such broadcasting is not allowed by IT department policy, as it does not allow the Nodes to discover each other's IP Addresses. However, IP addresses can still be discovered by our PC-resident Node Manager software.

**NTP SERVER:** Enter an NTP time server, if desired, other than [www.pool.ntp.org](http://www.pool.ntp.org). This is the default online NTP time server used to synchronize the clocks in our Nodes and also millions of other networked devices. It returns extremely accurate UTC/GMT time (Coordinated Universal Time or Greenwich Mean Time), which is then modified by our Nodes for the local time zone and is used to time and date stamp emailed and streamed reading data. Press GO to enter any change.

**NTP INTERVAL (SEC):** Specifies how often the Node will correct its own quartz crystal clock by checking the NTP time server. The default interval is 86400 seconds, or one day. Press GO to enter any change.

## 6. DEVICE DISCOVERY Web Page

Node :D4:20:38

### DEVICE DISCOVERY

---

NAME	TYPE	DATA	ALARM
<u>Device 004</u>	<u>DPM</u>	<u>+262.55</u>	<u>0000</u>
<u>Device 004</u>	<u>CTR</u>	<u>+300.03</u>	<u>0000</u>
<u>Device 004</u>	<u>DPM</u>	<u>+2.001 / +2.001 / +2.001</u>	<u>0000</u>

---

Date: Tuesday, March 19, 2013, 04:19 PM

Navigation: [LAN](#) | [NODE](#)

How to get here: Select a specific Node on the NODE DISCOVERY PAGE and click on DEVICES or on NODE.

Background: This screen displays all Devices (or instruments) discovered for the Node. If the Node is an LNET Ethernet board in a meter or counter or is an LTE transmitter, only a single Device will be shown, namely the host meter, counter or transmitter. If the Node is an LNET485 Ethernet-to-RS485 gateway Node, there can be up to 247 Devices, namely the host meter or counter plus additional Devices on an RS485 bus. Hovering over any underlined item will bring up an informational bubble.

NAME: The name assigned to the discovered Device using the DEVICE INTERFACE SETUP page.

TYPE: The instrument type programmed into the Device by the factory. Choices are DPM for analog input (including panel instruments and transmitters), CTR for pulse input (including panel instruments and transmitters), and WT for meters with weighing firmware (panel instruments).

DATA: The data transmitted by the Device. Setup of transmitted data can be by means of Instrument Setup Software (panel instruments and transmitters) or front panel keys (panel mounted instruments). Hover for data labels. For example, hovering over “+2.001 / +2.001 / +2.001” brings up the bubble “Reading / Peak / Valley”.

ALARM: State of up to 4 alarms, where 0 indicates no alarm and 1 indicates an alarm state. If the Device is one of our panel instruments, it can have 2 or 4 alarms. If it is one of our LT or LTE transmitters, it will have 2 alarms. Setup of alarms can be by means of Instrument Setup Software (panel instruments and transmitters) or front panel keys (panel mounted instruments).

## 8. TROUBLESHOOTING HINTS

Inability to discover a Node may be due to a corrupted MAC address in the Node. That may be the case if the Node can be discovered with a direct cable connection to a PC or through an unmanaged switch, but not through a managed switch. Laurel Nodes shipped between June and October 2022 have been known to corrupt the supplied registered MAC address so that the Node cannot be pinged or discovered through a managed switch. The solution is to upgrade the Node's firmware to EtherLN1\_4\_3.txt, as explained under the [FIRMWARE UPGRADE TAB](#) of this manual.

Laurel factory support is prepared to assist you, but we can only go so far in resolving system-level network issues. We will first ask if the Node can be pinged. If it cannot be pinged, it is not available on the network, and we cannot do remote troubleshooting. To do the latter, we will ask that TeamViewer or similar remoted desktop software be installed on a customer's PC connected to the customer's network.

Inability to install Instrument Setup (IS) software is most often due to User Account Control (UAC), a Windows security feature. To allow IS software installation, first set UAC of your version of Windows to "Never notify" so that the installation can create directories. Use Google for instructions on how to change UAC with your version of Windows. Power down and restart your computer for the UAC change to take effect. Following installation of IS software, you may return UAC to its previous setting.

Inability to open the IS Software Main Menu for a discovered and highlighted Device is most often caused by a Windows Defender firewall, which prevents IS software executable components from running and results in a variety of error messages. To open the firewall of your version of Windows for IS software, enter "firewall" into the search field of the Windows icon in the lower left of your monitor. Or click on "Windows Firewall" from the Windows Control Panel. Follow the links and ensure that Instrument Setup and its executable .exe components are allowed. With normal IS installation, the executable IS files are listed in the directory C:\Program Files (x86)\IS2 and are as follows:

- Ctr5T.exe
- CtrW.exe
- DPM5T.exe
- DPMW.exe
- Instrument Setup.exe
- WT5T.EXE
- WtW.exe

Firewall issues can also be caused by third-party firewall and antivirus protection software like McAfee or Norton. Do a Google search on how to change such third-party firewall settings to allow our specific software to run. The IT departments of large companies often set tight firewall rules. If you suspect a firewall issue and work for a large company, call in an IT representative.

Inability to open the IS Software Main Menu can also be caused by the factory default choice of Custom ASCII protocol. That protocol works great with RS232, RS485 or USB, but not with Ethernet, which requires Modbus TCP/IP. Modbus RTU is seamlessly converted to Modbus TCP/IP and back by our Nodes.

If your Laureate is a panel meter or counter that was set to Custom ASCII, the easiest way to change it to Modbus is from the front panel by setting the menu item “Ser 4” to 010.

If your Laureate is an LTE or LTE transmitter that was set to Custom ASCII, you can change it to Modbus with Node Manager software or IS software. With IS software:

1. In the “Communication” screen, select “Custom ASCII” and “Transmitter LTE, LTSE.”
2. Press “Ethernet.”
3. In the resulting “Node Discovery” screen, highlight your Node and press “Device Discovery.”
4. In the resulting “Device Discovery” screen, checkmark “Force discovered devices to Node’s Settings,” highlight your Device, and press “Main Menu.”
5. In the Main Menu, press “Counter” or “DPM” in the top menu bar depending on your Device, and press “Get Setup.”
6. In the resulting IS software main screen, press “View” and then “Setup.”
7. Press the “Communication” tab and verify that “Serial Protocol” is set to “Modbus RTU.” If not, set it to “Modbus RTU,” click on “Main Menu,” and execute a “Put” to download your Modbus RTU selection into your Device.

Get and Put commands will not work as expected when multiple copies of IS software are running on your PC. Ensure that only one copy of IS software is active on your PC at the same time.

As an aid to diagnostics, the Ethernet connector for all of our Ethernet Nodes is provided by an RJ45 jack, where green and amber LEDs on the jack indicate network operation:

- 1) Following power-up, the green and amber LEDs are on steady until an IP address has been assigned to the Node.
- 2) Once an IP address has been assigned to the Node, the amber LED is turned off. It will light up whenever the Node detects data packet activity.
- 3) When the Node has made a TCP connection, the green LED alternates on (1 sec) and off (1 sec), while the amber LED is on steady.

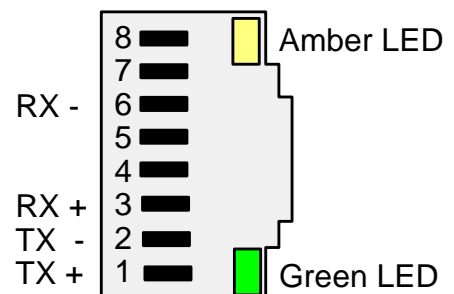

Ethernet cables (CAT5 or better) can be straight-through or crossover. Our Ethernet Nodes automatically adapt for either.