

LTE SERIES TRANSMITTERS

Pulse Input,
Ethernet & Isolated 4-20 mA Outputs
USER MANUAL



LAUREL Electronics Inc.

3183-G Airway Ave, Costa Mesa, CA, 92626, USA

Tel: (714) 434-6131 • Fax: (714) 434-3766 • Website: www.laurels.com

1. ORDERING GUIDE

Configure a model number in this format: **LTE60FR**

Transmitter Type

LTE..Pulse input transmitter with 4-20 mA, 0-20 mA or 0-10V isolated analog output, isolated Ethernet serial data output (Modbus or Custom ASCII protocol), two isolated solid state relays, and isolated transducer excitation output. Default jumpered for 10V excitation.

Main Board

6..... Standard pulse or AC input
8..... Extended pulse of AC input
Please see notes for "Extended."

Power

0..... 85-264 Vac
1..... 12-32 Vac or 10-48 Vdc

Input Type

FR Dual Channel Pulse or AC Input

Standard main board

Frequency (2 channels), rate (2 channels), total (2 channels), period, stopwatch, time interval.

Extended main board

Above plus rate and total simultaneously, linearized inputs using up to 180 points, arithmetic functions applied to channels A & B (A+B, A-B, A*B, A/B, A/B-1), phase angle, duty cycle, up/down counting, batch control.

VF1 4-20 mA Process Input
VF2 0-1 mA Process Input
VF3 0-10V Process Input
VF4 Custom Input

Standard main board

Rate or total from analog process signals. Selectable square root extraction for use with differential pressure flow meters.

Extended main board

Above plus rate and total simultaneously (analog totalizer), custom curve linearization using up to 180 points, batch control, and time based on rate.

QD Quadrature

Standard main board

Position or length from encoders. Accepts differential or single-ended inputs: 1x, 2x or 4x, plus zero index.

Extended main board

Above plus bidirectional rate (rate and position or length are not simultaneous).

2. TABLE OF CONTENTS

1.	Ordering Guide.....	2
2.	Table of Contents.....	3
3.	Complementary Manuals.....	4
4.	Product Overview.....	5
5.	Receiving & Unpacking Your Transmitter.....	6
6.	Safety Considerations.....	6
7.	Main Board Jumpers & Field Wiring.....	7
8.	Programming Your Transmitter.....	9
9.	Opening Your Transmitter Case.....	18
10.	Dual-Channel Pulse Input Signal Conditioner Board.....	19
11.	V-to-F Converter Signal Conditioner Board.....	36
12.	Quadrature Signal Conditioner Board.....	38
13.	Dual Relay Operation.....	41
14.	Input Signal Filtering.....	44
15.	Transmitter Calibration.....	45
16.	Custom Curve Linearization.....	46
17.	Modbus Protocol Transmitter Communications.....	47
18.	Custom ASCII Protocol Transmitter Communications.....	52
19.	Specifications, LTE Series Analog Input Transmitters.....	57
20.	Warranty.....	60

3. COMPLEMENTARY MANUALS

This manual covers LTE Series DIN rail transmitters with an isolated 4-20 mA output, Ethernet I/O, dual relays, and pulse inputs to the microcomputer. The signal conditioners be for dual pulse inputs, for quadrature, or for an analog signal (4-20 mA, 0-1 mA or 0-10V), which is converted to a pulse input by a voltage-to-frequency converter. This manual covers hardware aspects such a pinout and on-board jumpers, and transmitter setup such as scaling and relay setpoints. It also presents the main commands and text strings to be used with the Modbus and Custom ASCII communications protocols. It is intended to be used with the following separate manuals:

- **Ethernet Manual.** Covers Ethernet Node discovery and setup using Node Manager PC Software or the Web Server Software built into each Node. Required for use of Ethernet transmitters and normally shipped with this manual.
- **Modbus Communications Manual.** Covers strings and commands to be used with the Modbus protocol (if selected). Intended for programmers.
- **Serial Communications Manual.** Covers strings and commands to be used with Custom ASCII protocol (if selected). Intended for programmers.

LT Series DIN rail transmitters with an isolated 4-20 mA output, RS232 or RS485 I/O, dual relays, and a pulse input signal conditioner are covered in a separate manual.

4. PRODUCT OVERVIEW

LTE Series counter transmitters duplicate the signal conditioning and signal processing features of our 1/8 DIN panel-mounted counters for exceptional performance at high read rates. Signal sources are accommodated by three signal conditioner boards, which are the same as for our panel-mounted counters:

- **Dual-channel pulse input signal conditioner** (for frequency, rate, total, arithmetic combinations of two channels, stopwatch, timer, phase angle, duty cycle).
- **Voltage-to-frequency signal conditioner** (for rate or total from 4-20 mA, 0-1 mA or 0-10V process signals).
- **Quadrature signal conditioner** (for position or rate from quadrature encoder signals).

Extended software capabilities are provided by an “Extended” main board, which needs to be specified at the time of order. Please see our Ordering Guide on page 2 and the signal conditioner sections of this manual.

An isolated 4-20 mA, 0-20 mA or 0-10V output is standard. This output is generated by an ultra-linear 16-bit digital to analog converter which tracks an internal linearized digital reading.

Isolated Ethernet communications are standard via an RJ45 connector for a 10/100BaseT interface. Four serial communication protocols are understood by our transmitters: Modbus TCP, Modbus RTU, Modbus ASCII, and Custom ASCII (a simpler protocol than Modbus).

An isolated transducer excitation output is standard. Three output levels are jumper selectable: 5V at 100 mA, 10V at 120 mA, or 24V at 50 mA. The factory default setting is 10V.

Two control inputs are standard. These can be programmed for function reset or meter reset, or to change operation of the Extended transmitter. A control input is applied by connecting that input to digital ground using an external switch.

Two isolated solid state relays are standard. These are rated 120 mA at 140 Vac or 180 Vdc.

Isolation to 250V rms is provided for power, signal input, analog output, relay outputs, and communications. Isolation adds safety and avoids possible ground loops. The transducer excitation output is isolated to $\pm 50V$ from signal ground.

Internal jumpers are used to select the signal range and excitation level. The transmitter configuration is specified by the model number on the transmitter label. A user can reconfigure the transmitter by opening the case and moving jumpers.

Transmitter scaling is via serial connection to a PC using MS Windows based Instrument Setup Software, which can be downloaded at no charge.

5. RECEIVING & UNPACKING YOUR TRANSMITTER

Your transmitter was carefully tested and inspected prior to shipment. Should the transmitter be damaged in shipment, notify the freight carrier immediately. In the event the transmitter is not configured as ordered or is inoperable, return it to the place of purchase for repair or replacement. Please include a detailed description of the problem.

6. SAFETY CONSIDERATIONS



Warning: Use of this transmitter in a manner other than specified may impair the protection of the device and subject the user to a hazard. Do not attempt to operate if the unit shows visible damage.

Cautions:

- This unit may be powered from 85-264 Vac or with the worldwide voltage power supply option, or from 12-32 Vac or 10-48 Vdc with the low voltage power supply option. Verify that the proper power option is installed for the power to be used.
- The 85-264 Vac power connector (P1 Pins 1-3) is colored **Green** to differentiate it from other input and output connectors. The 12-32 Vac or 10-48 Vdc power connector is colored **Black**. This transmitter has no power switch. It will be in operation as soon as power is applied.
- To avoid dangers of electrocution and/or short circuit, do not attempt to open the case while the unit is under power.
- To prevent an electrical or fire hazard, do not expose the transmitter to excessive moisture. Do not operate the transmitter in the presence of flammable gases or fumes, as such an environment constitutes an explosion hazard.

Symbols applicable to this product:



Caution (refer to accompanying documents)



Caution, risk of electric shock.



Equipment protected throughout by double insulation or reinforced insulation.



CE Mark. Indicates that the product meets EU safety, health and environmental requirements.



Earth (ground) terminal.



Both direct and alternating current.



ETL Mark. Indicates that product conforms to UL Std. 61010-1 and is certified to CAN/USA Std. C22.2 No. 61010-1. Mark pending as of Oct 2013.

Operating environment:

Transmitter Class II (double insulated) equipment designed for use in Pollution degree 2.

7. LTE TRANSMITTER MAIN BOARD JUMPERS & FIELD WIRING

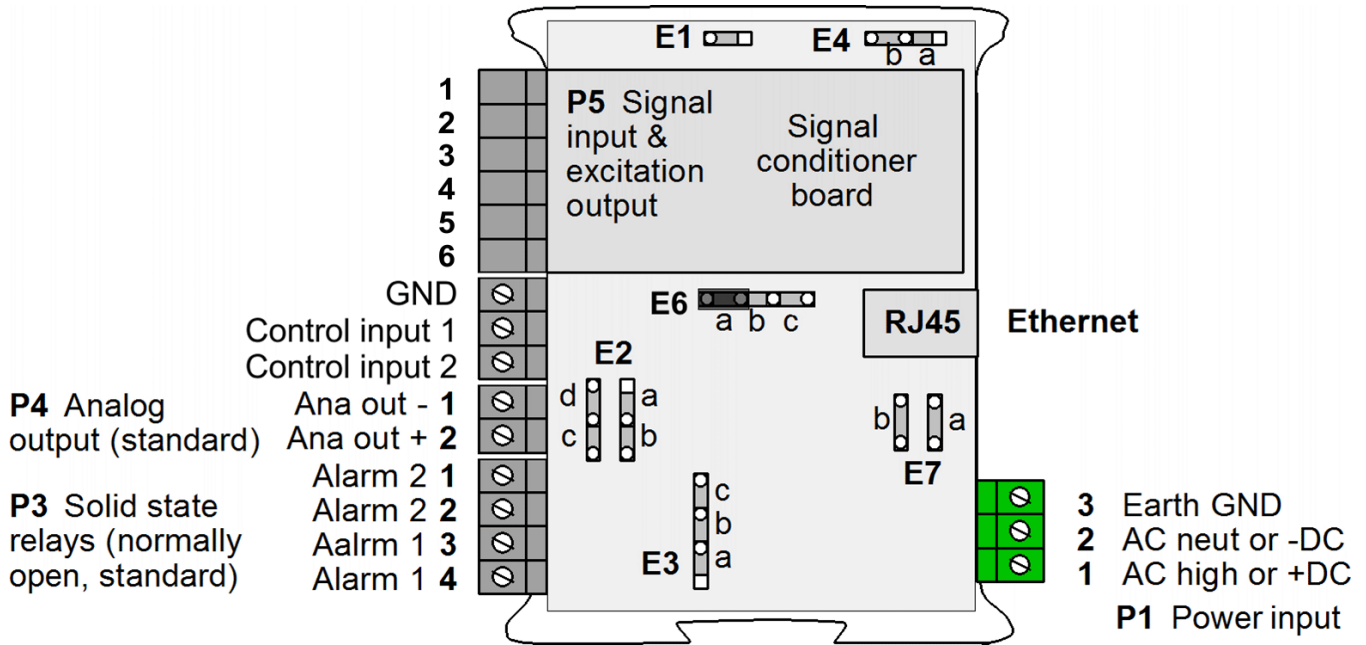

An **RJ45 Ethernet connector** allows the transmitter to be connected directly to a computer, router, switch or hub via an Ethernet cable. An isolated analog output and dual relays are also standard.

Jumpers on the main board allow selection of the following:

- Analog output (current or voltage). This output is sourcing. Do not apply an external voltage. Applying an external voltage of 24 Vdc will burn out the transmitter main board.
- Excitation output. Attempting to draw more than the rated transducer excitation output current will shut down the output.

Jumpers on analog input signal conditioner boards are described in later manual sections. Normal operation, as opposed to factory test, requires that the E6 jumper be installed as shown.

To reset the transmitter (same as power-up), press the Reset button.

To reset communications to 9600 baud, command mode, Custom ASCII protocol, and Address 1, place a jumper at E1, turn power on and off, remove the jumper, and restart the transmitter.

Analog Output	Jumpers
Current (0-20 or 4-20 mA)	E2 a + d
Voltage (0-10V)	E2 b + c
Communication Reset	Jumper
Jumper + power-up	E1

Excitation Output	Jumpers
5V, 100 mA	E3 a + c; E4 a
10V, 120 mA	E3 a + c; E4 b
24V, 50 mA	E3 b, E4 none

P5- SIGNAL INPUT DETAIL

PROCESS / TOTALIZER SIGNAL INPUT

DC & Externally Powered Process

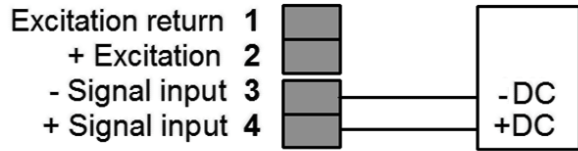

2-Wire Process Transmitter

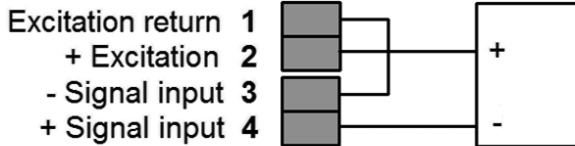

QUADRATURE SIGNAL INPUTS

Differential or Complementary Inputs

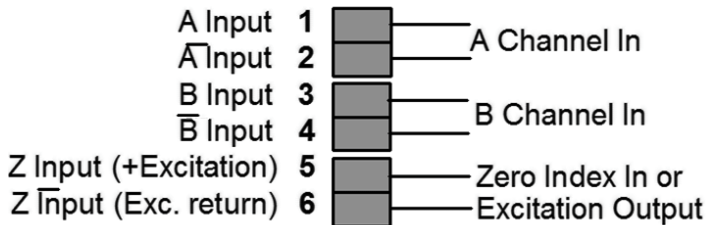

Single Ended Inputs

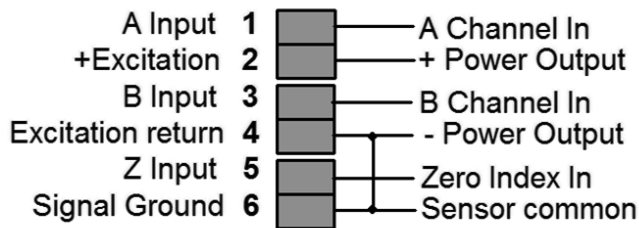

MOUNTING FOR COOLING

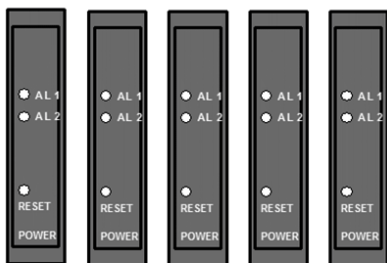

Mount transmitters with ventilation holes at top and bottom. Leave minimum of 6 mm (1/4") between transmitters, or force air with a fan.

DUAL CHANNEL PULSE SIGNAL INPUT

Single Powered Sensor Input

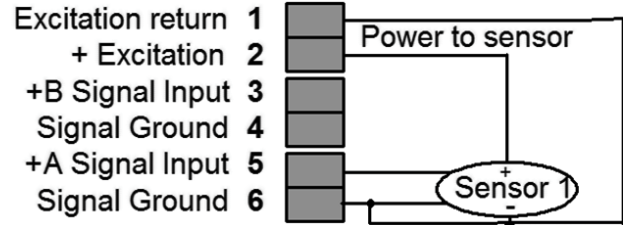

Two Powered Sensor Inputs

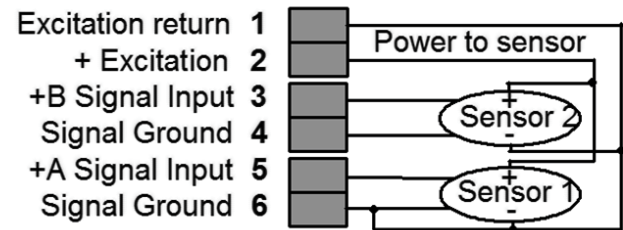

Active and Passive Inputs

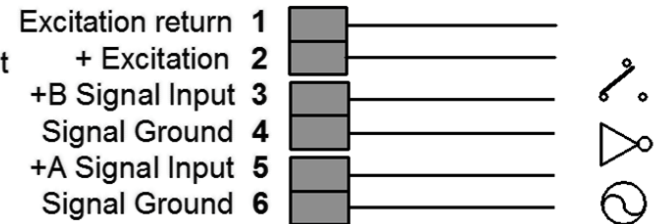

Inputs can be proximity switches, contact closures, digital logic, magnetic pickups, or AC inputs to 250V
Warning: Dual-channel signal grounds 4 & 6 are connected internally.

P4 - ANALOG OUTPUT DETAIL

Driving a Load with 4-20 mA

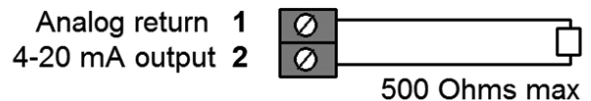

Driving a Load with 0-10V

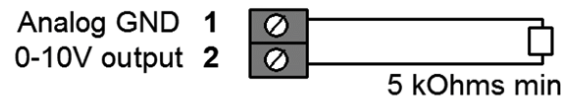

Analog output is sourcing. Do not apply external voltage. External 24 Vdc power will damage the analog output section.

8. PROGRAMMING YOUR TRANSMITTER

OVERVIEW

LTE transmitters are easily programmed by connecting them to the same LAN as a PC or by connecting them directly to a PC with an Ethernet cable, and then running Instrument Setup Software on the PC. This MS Windows based software allows Node and Device discovery, uploading, editing, downloading and saving of setup data, execution of commands under computer control, listing, plotting and graphing of data, and computer prompted calibration.

INSTALLING INSTRUMENT SETUP SOFTWARE

Download the file ISx_x_x.exe from our website and double-click on the file name. Click on Install Instrument Setup Software and follow the prompts.

LAUNCHING INSTRUMENT SETUP SOFTWARE

Connect your LTE transmitter to your PC via an Ethernet cable, or connect the transmitter to the same LAN as the PC. To launch IS software, press on Start => Programs => IS2 => Instrument Setup or on the desktop icon that you may have created. Following a brief splash screen, the Communications Setup screen will appear.

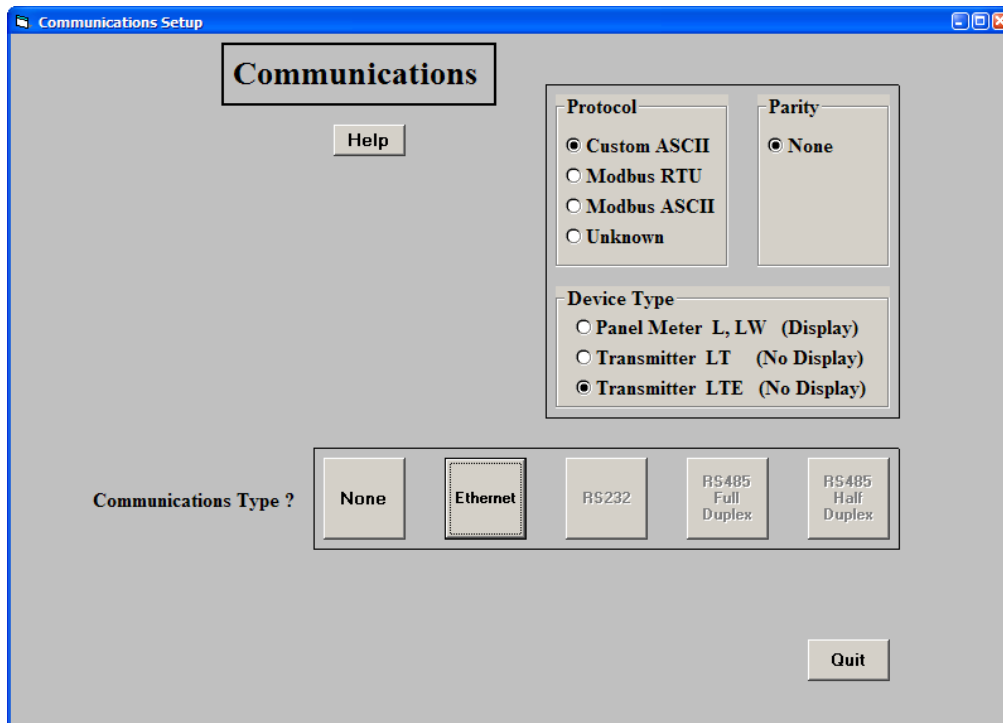

In the Communications Setup screen, select Transmitter LTE as the Device Type, Ethernet as the Communication Type, any of the protocols listed.

Upon clicking on Ethernet for the first time, you may be presented with the Windows Security Alert shown below. Click on Unblock, and IS software will be launched. If you ever click on Keep Blocking, IS software will not be able to establish Ethernet communications. You will then need to restore Windows Firewall defaults by clicking on Control Panel => Windows Firewall => Advanced => Restore Defaults.

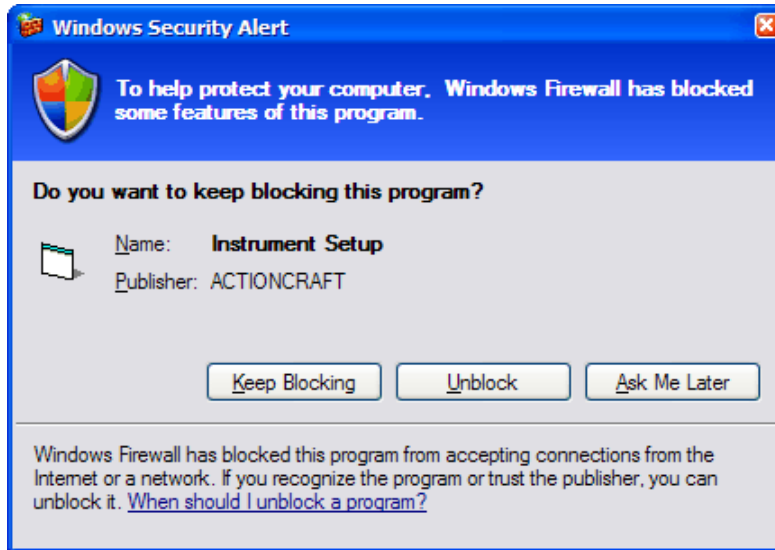

The Node Discovery tab under Node Setup will open once you have passed the Windows Firewall. With a direct cable connection to the PC, only one Ethernet Node will be listed. With a LAN connection, multiple Ethernet Nodes may be discovered on the same LAN. Select the Node which is integral with your transmitter Device.

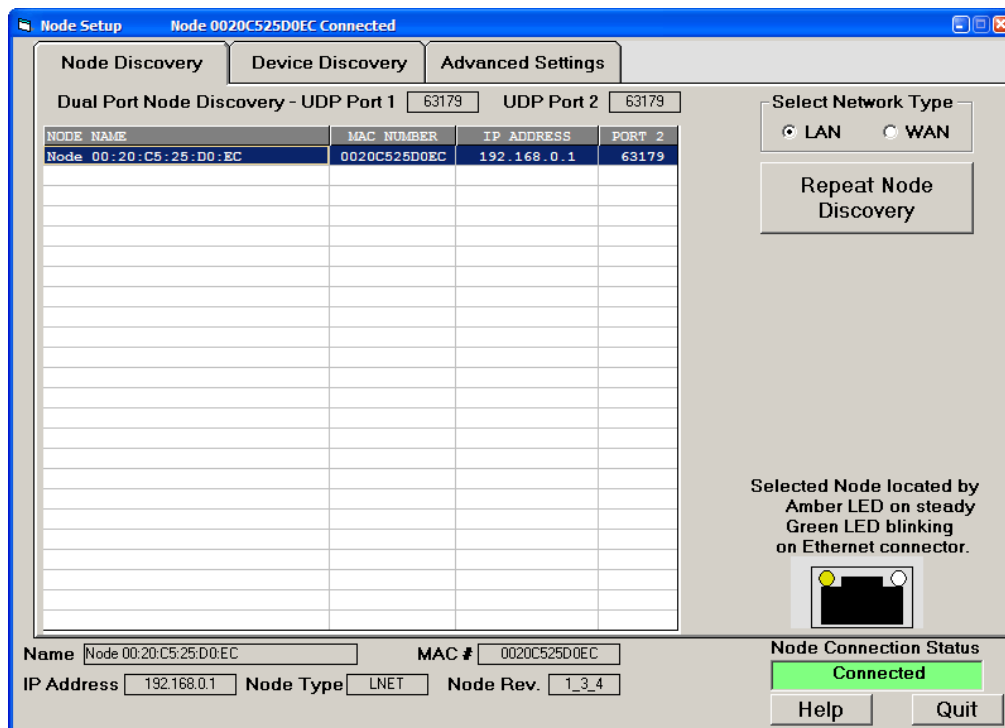

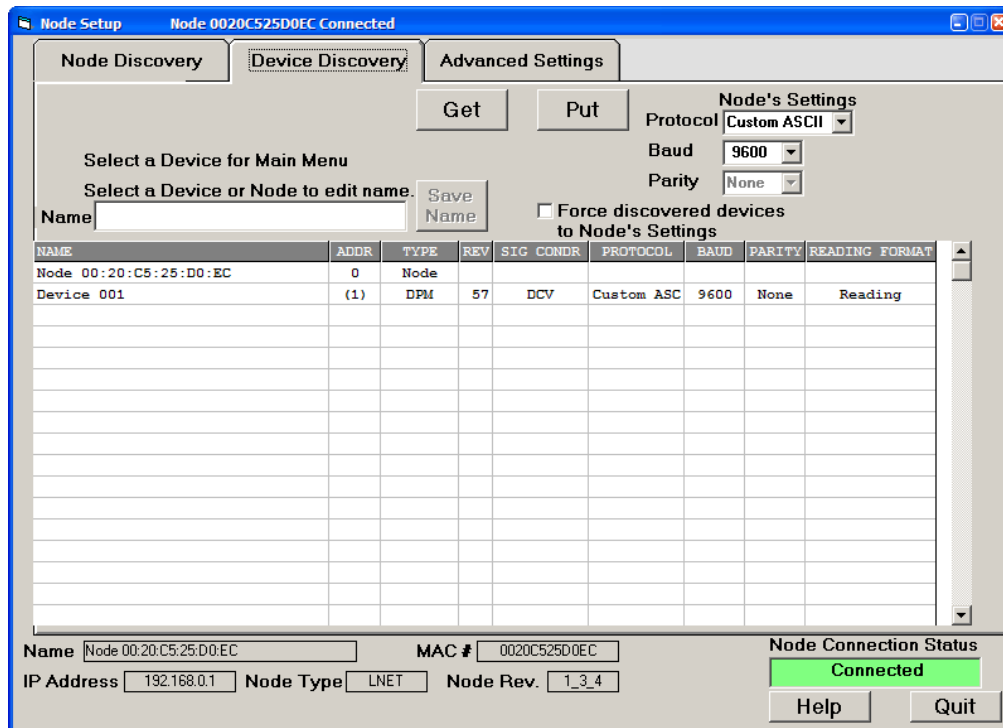

Click on the Device Discovery tab, and all Devices attached to your Node will be listed. With an LTE transmitter, the transmitter will be the only Device listed. With a device server Node, there can be up to 30 Devices (meters and transmitters) on an RS485 bus. Please see our Ethernet manual.

Highlight your Node, and you will be able to assign a descriptive name to it, such as Tank Farm. The default name is the Node's unique MAC address. You can also use this tab to change your Node's communication settings. Press Get to retrieve settings from the Node to the PC. Press Put to write settings from the PC to the Node.

Highlight your Device, and you will be able to assign a descriptive name to it, such as Flow Rate. Press Get to retrieve settings from the Device to the PC. Press Put to write settings from the PC to the Device.

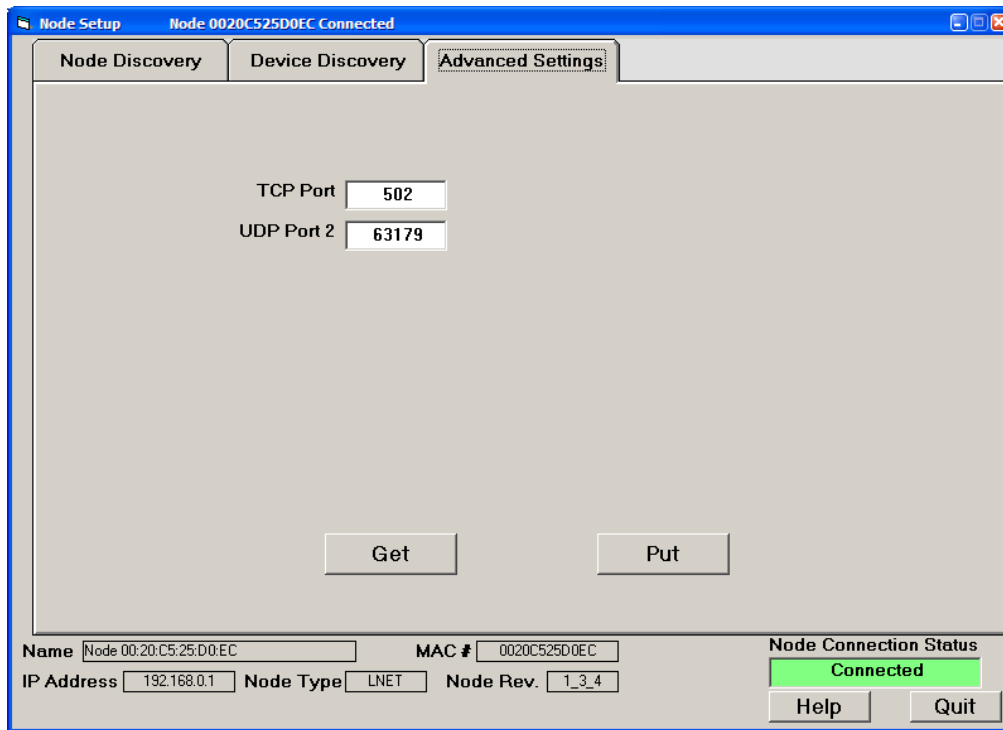

Click on the Advanced Settings tab, and you will be given the opportunity to change the Node's TCP and UDP Port settings. Press Get to retrieve settings from the Node to the PC. Press Put to write settings from the PC to the Node.

If a browser is to access our Nodes on a remote LAN over the Internet, port forwarding must first be set up for the router that controls the remote LAN. The default port numbers programmed into our Nodes are UDP port **63179** for Node discovery and TCP port **502** for Modbus TCP. If these ports are blocked by the router or by a firewall, different port values can be entered into our Nodes. You or your company's IT department will then also need to set up the remote router to forward these different port values.

As an aid to diagnostics, the Ethernet connector for all of our Ethernet Nodes is provided by an RJ45 jack, where green and amber LEDs on the jack indicate network operation:

- 1) Following power-up, the green and amber LEDs are on steady until an IP address has been assigned to the Node.
- 2) Once an IP address has been assigned to the Node, the amber LED is turned off. It will light up whenever the Node detects data packet activity.
- 3) When the Node has made a TCP connection, the green LED alternates on (1 sec) and off (1 sec), while the amber LED is on steady.

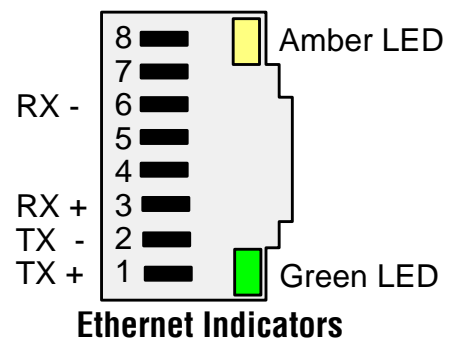

Ethernet cables (CAT5 or better) can be straight-through or crossover. Our Ethernet Nodes automatically adapt for either.

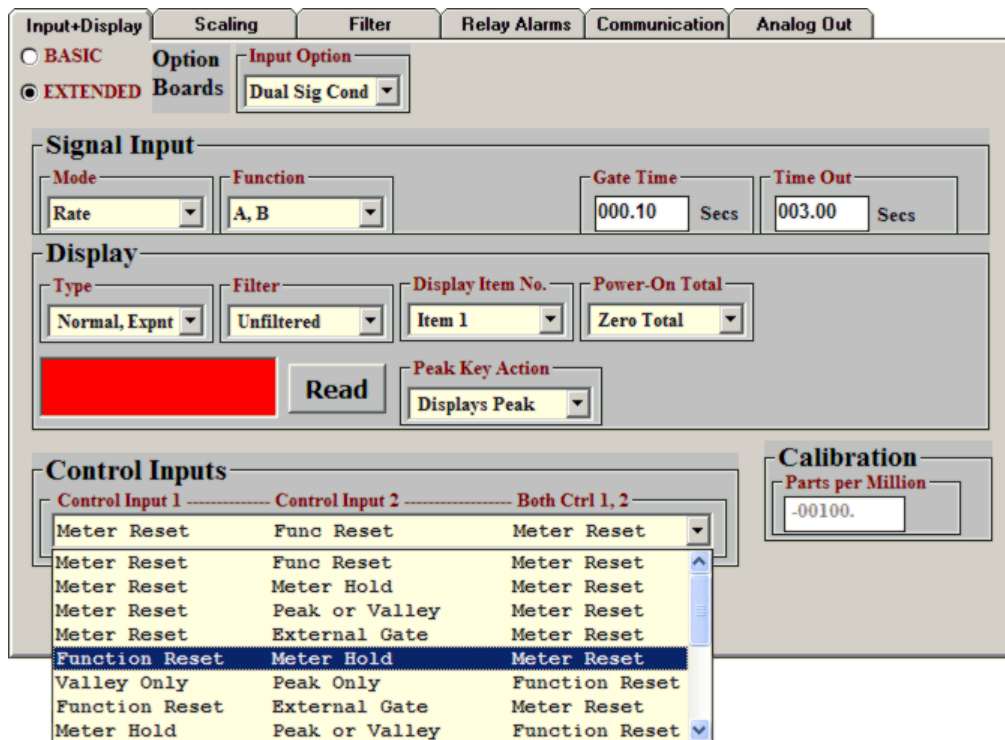

To reach the above Input+Display tab screen, follow this procedure:

- 1) Highlight your device under the Device Discovery tab.
- 2) Click on the Main Menu button. A new Counter Main Menu window will open with a help screen. Click on Counter in the top menu bar. Our pulse input transmitters and counters use the same software. While a scaled digital reading is not displayed by transmitters, it is used internally.
- 3) Click on Get Setup to retrieve the setup data currently in the transmitter.
- 4) Click on View => Setup to reach the above setup window with five tabs.

The Input+Display tab is used to set up Signal Input Mode, Signal Input Function, Gate Time, Time Out, Display Type, Display Filter, Power-On Total, and the roles of Control Inputs 1 and 2.

Clicking on the Control Inputs field opens a pull-down menu which allows selection of the roles of Control Input 1, Control Input 2, and simultaneous Control Inputs 1 and 2. For example, with a Dual Pulse Input signal conditioner and the highlighted selection, grounding Control Input 1 causes a Function Reset, which resets Peak, Valley and latched alarms; grounding Control Input 2 places the transmitter on Hold, and causes the Peak reading to be transmitted, and grounding both Control Inputs 1 and 2 causes a Meter Reset, causes a power-on reset of the transmitter. A control input is applied by connecting that input to digital ground using an external switch.

The above sample screen is for the dual pulse input signal conditioner. The actual screen and Control Input choices will be for the detected signal conditioner, and later screens will vary depending on selections made in this screen.

Press the F1 key for context-sensitive help with any item.

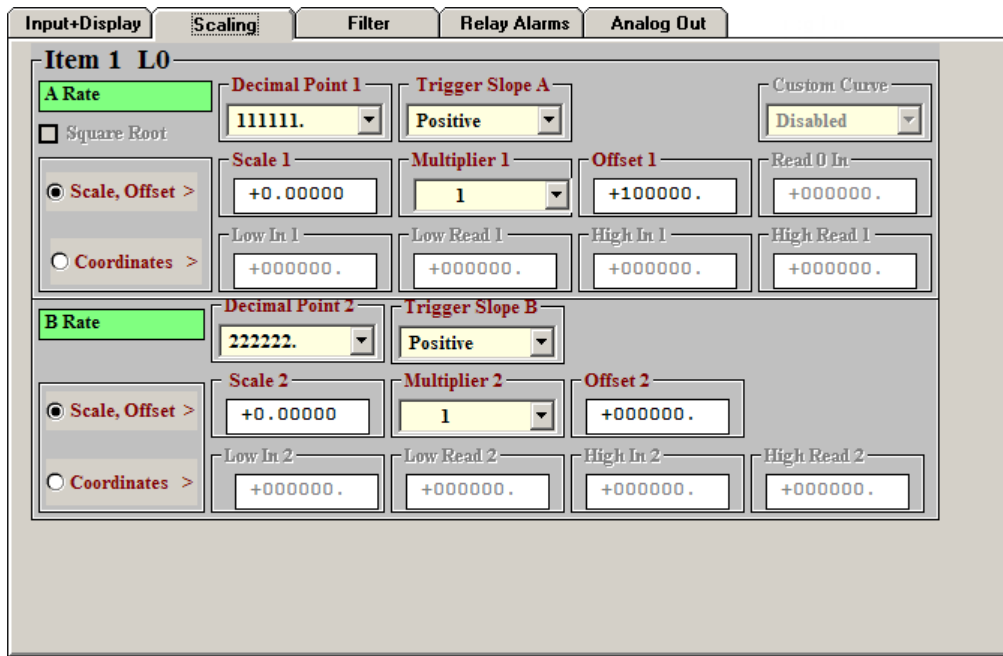

Click on the Scaling tab to scale your transmitter. The actual screen will vary depending on the detected signal conditioner board, signal input and signal function, as selected under the Input+Display tab. Press the F1 key for help with any highlighted item.

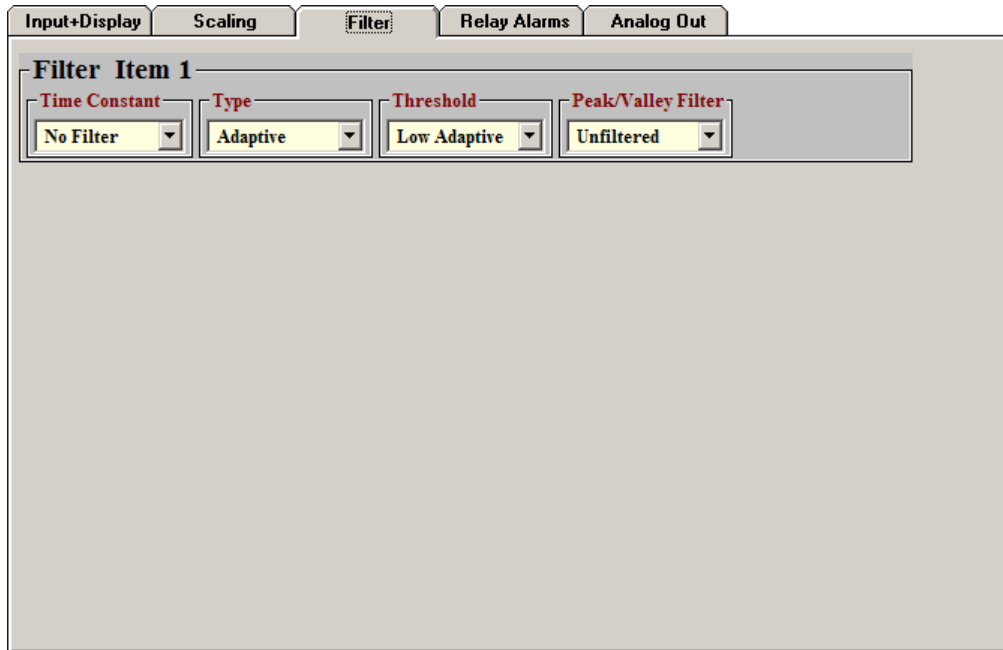

Click on the Filter tab to set to set up filtering for your readings. The filter time constant can be automatic, be specified in seconds, or be turned off. The adaptive threshold modifies the time constant in response to noise. A low adaptive threshold is recommended for normal low noise. A high adaptive threshold is recommended for high noise environments. Press the F1 key for help with any highlighted item.

The screenshot shows the 'Relay Alarms' configuration window. It is divided into two columns for Alarm 1 and Alarm 2. Each column contains the following settings:

- Setpoint 1**: +000000.
- Deviation 1**: +000000.
- Alarm 1 Source**: Item 1 (dropdown)
- Alarm 1 State**: High Active (dropdown)
- Relay1 Alarm State**: Active On (dropdown)
- Deviation 1 Type**: Band Deviation (dropdown)
- Alarm 1 Type**: Non-Latching (dropdown)

At the bottom of the window, there is a dropdown menu labeled 'Alarms 1,2 No. Rds to Alarm' with the value '1 Reading' selected.

Click on the Relay Alarms tab to set up your transmitter's two solid state relays, which are standard. Press the F1 key for help with any highlighted item.

The screenshot shows the 'Analog Output' configuration window. The 'Analog Output' section is highlighted. It contains the following settings:

- Source**: Item 1 (dropdown)
- Lo Range Reading**: +000000. (text field)
- Range**: 0-20mA Current (dropdown)
- Hi Range Reading**: +100000. (text field)

An 'Enter Decimal Value' dialog box is overlaid on the screen. It has a title bar 'Enter Decimal Value' and a numeric keypad with the following display: '+ 0 0 0 0 0 0.'. Below the keypad are 'OK' and 'Cancel' buttons.

Click on the *Analog Out* tab to scale your analog output, which is standard. Under Range, select 0-20 mA Current, 0-10V Voltage, or 4-20 mA. Type in your Lo Range Reading and Hi Range reading. These will create the two endpoints of your analog output range. Press the F1 key for help with any highlighted item.

PULL-DOWN MENU FEATURES

- **The File pull-down menu** allows you to save setup files to disk by pressing on Save Setup and to open setup files from disk by pressing on Open Setup. Opened setup files can then be edited on the PC, be saved to disk, and be downloaded into Devices by using DPM => Put Setup.
- **The Commands pull-down menu** allows you to execute certain functions by using your computer mouse. This menu will be grayed out unless a Get Setup has been executed.
- **The Readings pull-down menu** provides three formats to display input data on your PC monitor. Use the Pause and Continue buttons to control the timing of data collection, then press Print for a hardcopy on your PC printer.
 - **List** presents the latest internal readings in a 20-row by 10-column table. Press Pause at any time to freeze the display. Press Print for a hardcopy.
 - **Plot** generates a plot of internal readings vs. time in seconds. It effectively turns the transmitter-PC combination into a printing digital oscilloscope.
 - **Graph** generates a histogram, where the horizontal axis is the internal reading, and the vertical axis is the number of occurrences of readings. The display continually resizes itself as the number of readings increases.

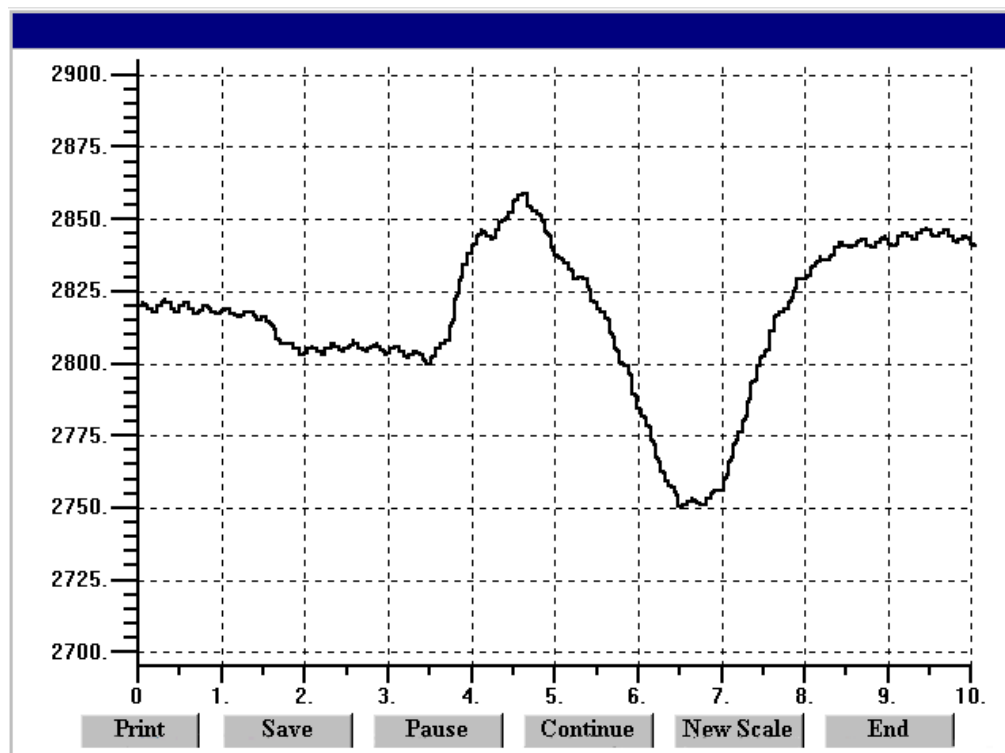

Plot

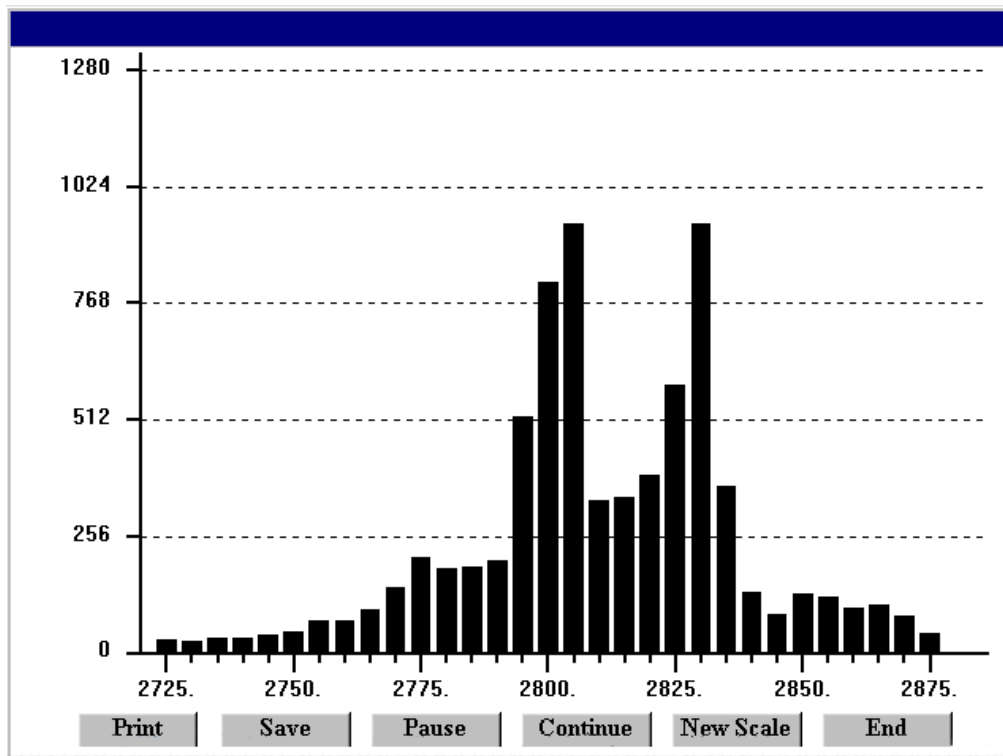

Graph

- **The Jumpers pull-down menu** shows jumper positions for the selected signal conditioner boards and the main board, duplicating information in this manual.

DC Signal Conditioner Jumpers

DC Signal Conditioner

Voltage		Current	
Input Range	Jumper Positions	Input Range	Jumper Positions
200 mV	E, b	2 mA	D, h, b
2 V	E, a	20 mA	C, h, b
20 V	F, g, b	200 mA	B, h, b
200 V	F, g, a	5 A	A, h, b
660 V	F, h, a		

Notes:

1. Click on Jumpers/Power Supply to select jumpers for 5, 10 or 24V Excitation.
2. Upper case letter positions require 5mm(.2in) jumpers, lower case 2.5mm(0.1in) jumpers.
3. Store spare jumpers on single unused jumper posts NOT associated with upper case letters.

Print OK

9. OPENING YOUR TRANSMITTER CASE

WHEN TO CHANGE JUMPERS

Your transmitter case does not need to be opened if jumpers have already been set by your distributor. Otherwise you will need to open the case and either set jumpers or verify that the factory default jumper positions will meet your needs. Jumpers are used for the following:

- 1) **On the dual channel pulse input signal conditioner board** to set trigger levels, frequency response, bias resistance, and contact debounce. See Section 9.
- 2) **On the V-to-F signal conditioner board** to set the analog input signal type (0-10V, 0-1 mA or 4-20 mA). See Section 10.
- 3) **On the quadrature signal conditioner board** to set the quadrature input type, input termination, phase for up-counting, count-by options, and zero index polarity. See Section 11.
- 4) **On the main board** to set the serial communication signal (RS232 or RS485), termination resistor for long cable runs, analog output signal (current or voltage), and sensor excitation output (5V, 10V or 24V). Default factory settings are RS232, no termination resistor, and 10V excitation output. Section 12.

HOW TO OPEN & CLOSE THE CASE



The two clamshell halves of the case are held together with a bolt and a nut at each of the four corners. Use a Phillips screwdriver to remove the four bolts. The nut will then drop off, and the clamshell halves will separate. When closing the case, make sure that the ventilation grills are properly aligned.



Caution: The nuts at the four corners are not captive and are black. Take precautions so that the nuts do not fall off and get lost.

10. DUAL CHANNEL PULSE SIGNAL CONDITIONER BOARD

The dual channel signal conditioner board is used for the frequency, rate, period, timing, batch control, phase and duty cycle functions. The board needs to be configured via jumpers for the input signal type and level. It is recognized by the transmitter software, which will bring up the applicable menu items. It does not require calibration, since the quartz crystal oscillator that is used for frequency and timing applications is located on the transmitter main board.

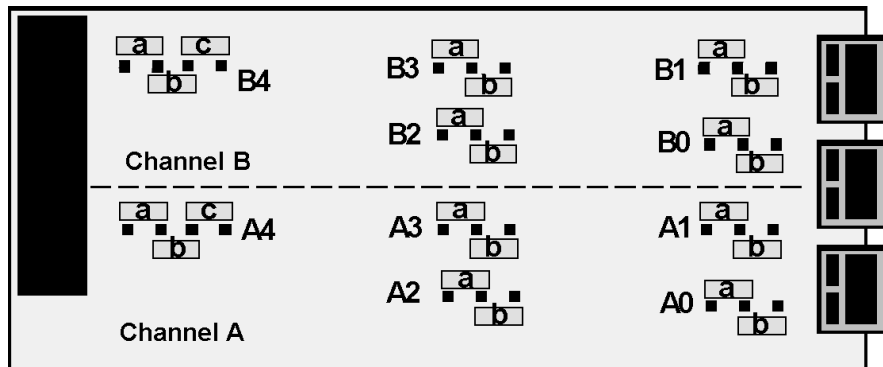

Jumper Settings for Expected Signal Levels

The jumper settings for Channel A (A2 & A3) and Channel B (B2 & B3) need to be set for the expected signal voltage. A voltage input is recognized as a pulse when it exceeds a high hysteresis limit, and is unrecognized as a pulse below a low hysteresis limit. Hysteresis is used to avoid false counts due to electrical noise. A wide hysteresis band improves noise immunity. To count negative pulses, reverse the inputs to the counter.

A2 B2	A3 B3	Hysteresis Limits	
		High	Low
a	-	+12 mV	-12 mV
b	-	+150 mV	-150 mV
-	-	+1.15V	-1.15V
a	a	+60 mV	+30 mV
b	a	+600 mV	+350 mV
-	a	+2.1V	+1.25V
a	b	-30 mV	-60 mV
b	b	-350 mV	-600 mV
-	b	-1.25V	-2.1V

Built-in pull-up or pull-down resistors are used to provide a +5V or -5V signal bias with open collector sensors or dry contact closures. They should not be used for other input types. Debounce circuitry keeps the meter from counting extra pulses due to contact bounce. High voltages V_{in} can be attenuated by a resistor R in series with the meter's input resistance, which is 100 k Ω for non-biased signals greater than $\pm 3V$. This creates a voltage divider, so that the sensed voltage is $V_{in} \times 100 \text{ k}\Omega / (R + 100 \text{ k}\Omega)$.

Function	Group	Jumper	Jumper effect	Input Resistance
Frequency Response	A0 & B0	-	1 MHz max	1 M Ω for V within $\pm 3V$ 100 k Ω for V outside $\pm 3V$
		b	30 kHz max	
		a	250 Hz max	
Bias Resistor	A1 & B1	-	No pull-up or pull-down	10 k Ω
		a	10 k Ω pull-up to +5V	
		b	10 k Ω pull-down to -5V	

Contact Debounce	A4 & B4	b a, c c	No debounce 3 msec 50 msec	No effect on input resistance
-------------------------	---------	----------------	----------------------------------	-------------------------------

Common Jumper Settings

Input Type	Vmax	A0 & B0	A1 & B1	A2 & B2	A3 & B3	A4 & B4
Logic levels	250V	-	-	-	a	b
NPN open collector	+25V	b	a	-	a	b
PNP open collector	-15V	b	b	-	-	b
Contact closures	-15V, +25V	a or b	a	-	a	a, c
Line frequency	250V	b	-	-	-	a, c
Magnetic pickup, 2-wire	250V	b	-	a	-	b

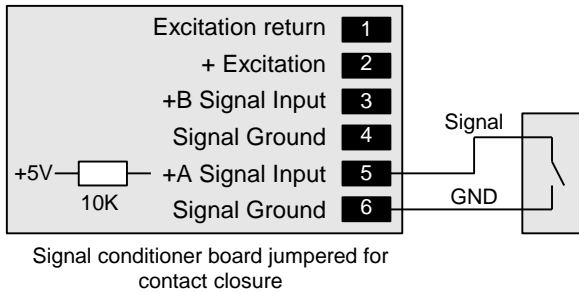

A contact closure is normally an On/Off switch to ground. When the board is jumpered for contact closure, the signal seen by the board is +5V when the switch is open and 0V when the switch is closed. No need to connect excitation, since the counter's internal +5V is applied through a current limiting 10K pull-up resistor.

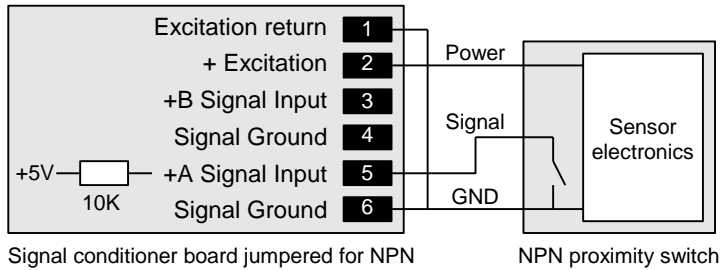

An NPN sensor is like an On/Off switch to ground. When the board is jumpered for NPN, the signal seen by the board is +5V when the switch is open and 0V when the switch is closed. Excitation is only used to power the sensor electronics. Excitation return and signal ground have to be tied together.

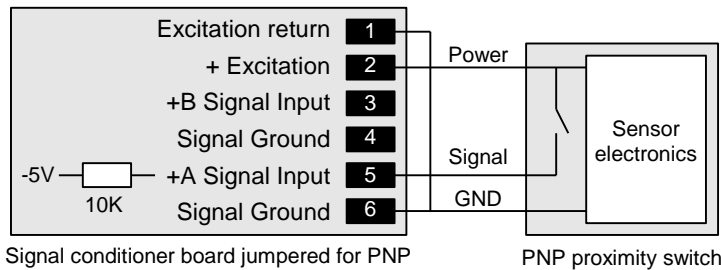

A PNP sensor is like an On/Off switch to +Excitation. When the board is jumpered for PNP, the signal seen by the board is -5V when the switch is open and +Excitation when the switch is closed. Excitation return and signal ground have to be tied together.

10.1 RATE & FREQUENCY MODES

Frequency in Hz is determined by timing an integral number of pulses over a user-specified Gate Time from 0 to 199.99 sec and taking the inverse of average period. The typical internal display update rate is Gate Time + 1 period + 30 ms. Selecting a longer Gate Time produces a more stable reading as more cycles are averaged, but slows down the update rate. At very low frequencies, the update rate is controlled by the period. A Time Out from 0 to 199.99 sec is also selectable. This is the time the transmitter waits for a signal to start or end a conversion. If the signal is not received before the Time Out ends, the transmitter reads zero. The longer the Time Out, the lower the minimum frequency that can be processed.

Rate in engineering units can be obtained by applying a scale factor to frequency, or by using the Coordinates of 2 Points method, where two inputs in Hz and the corresponding desired two internal readings are entered directly.

- **Rate A, B** determines rate independently for Channel A (Item #1) and Channel B (Item #2). Either item can be selected for the analog output.
- **Rate A Only** determines rate only for Channel A. Channel B is not used.
- **Rate A, A Total** (Extended main board) determines Rate for Channel A (Item #1) and Total for Channel A (Item #2) since last reset. Total can count down from an offset by entering a negative scale factor.
- **Rates A+B, A-B, AxB, A/B, A/B-1** (Extended main board) can output arithmetic combinations of Rates A and B (Item #1), Rate A (Item #2), or Rate B (Item #3). With rates A and B scaled to produce a ratio close to 1 and an offset of -1, the special combination A/B-1, called "Draw," can output percentage changes, such as elongation of material as it passes between rollers.

Applicable to all rate & frequency application examples:

Connect your transmitter to a PC running Instrument Setup (IS) Software. Establish communications. To open a setup file for editing, click on "Get Setup" under the Counter tab to retrieve the latest setup file from your transmitter, or click on "Open Setup" under the File tab to retrieve a previously saved setup file from disk.

Relay Alarms and Analog Out respond to the counts that are transmitted digitally. While a decimal point can be specified and will be transmitted digitally, it does not affect counts (except for power factor). For example, the same 58134 count frequency can be transmitted as 58134 Hz or 58.134 kHz

Following editing, click on the Main Menu button. Under the Counter tab, click on "Put Setup" to download your setup file into your transmitter. Under the File tab, click on "Save Setup As" to save your setup to disk if desired.

Example 1: Transmit frequency in Hz with 1 Hz resolution

Application: Transmit digital frequency readings f from 1 Hz to 999999 Hz with no decimal point, update rate of 4/sec, and adaptive moving average filter for 0.4 sec. Set analog output to 0V at 0 Hz and 10V at 25 kHz.

The image shows three screenshots of a control panel interface, likely for a frequency counter or similar instrument. The interface is divided into several tabs: Input+Display, Scaling, Filter, Relay Alarms, Communication, and Analog Out.

First Screenshot (Input+Display tab):

- Option:** BASIC (selected), EXTENDED
- Boards:** Dual Sig Cond
- Signal Input:**
 - Mode: Rate
 - Function: A Only
 - Gate Time: 000.25 Secs
 - Time Out: 002.00 Secs
- Display:**
 - Type: Norml 999999
 - Filter: Unfiltered
 - Display Item No.: Item 1
 - Power-On Total: Zero Total

Second Screenshot (Scaling tab):

- Item 1 L0:**
 - A Rate (selected)
 - Decimal Point 1: 111111
 - Trigger Slope A: Positive
 - Custom Curve: Disabled
 - Scale, Offset > (selected)
 - Scale 1: +1.00000
 - Multiplier 1: 1
 - Offset 1: +000000.
 - Read 0 In: +000000.
 - Coordinates > (selected)
 - Low In 1: +0.00000
 - Low Read 1: +000000.
 - High In 1: +1.00000
 - High Read 1: +000001.

Third Screenshot (Analog Out tab):

- Analog Output:**
 - Source: Item 1
 - Lo Range Reading: +000000.
 - Range: 0-10V Voltage
 - Hi Range Reading: +025000.

Solution:

- Under Input+Display tab and Signal Input, set Mode to “A Rate”, Function to “A only”, Gate Time to 0.25 sec, and Time Out to 2 sec. Under Display, set Type to “Norml 999999”.
- Under Scaling tab, set decimal point to 111111. If “Scale, Offset” is selected as scaling method, set Scale to +1.00000, Multiplier to 1, and Offset to +000000. If Coordinates is selected as scaling method, enter 0 for Lo In and 0 for High Read. Also enter +100000 for High In and +100000 for High Read. To minimize rounding errors, do not enter small values for High In and High Read.
- Under Filter tab, set Time Constant to 0.4 sec.
- Under Analog Out tab, set Range to “0-10V Voltage”, Lo Range Reading to +000000, and Hi Range Reading to +025000.

Example 2: Transmit rate as 0-100.00 for a 10 kHz to 11 kHz input

Application: Transmit 0.00 to 100.00 (with two decimal places) for a 10 kHz to 11 kHz frequency input. Set analog output to 4-20 mA for this range.

The image shows three screenshots of a control panel interface, likely for a frequency-to-current converter. The interface is divided into several tabs: Input+Display, Scaling, Filter, Relay Alarms, Communication, and Analog Out.

Input+Display Tab: This tab is selected. It shows the following settings:

- Mode:** Rate
- Function:** A Only
- Gate Time:** 000.10 Secs
- Time Out:** 002.00 Secs
- Type:** Norml 999999
- Filter:** Unfiltered
- Display Item No.:** Item 1
- Power-On Total:** Zero Total

Scaling Tab: This tab is selected. It shows the following settings for Item 1 LO:

- Decimal Point 1:** 1111.11
- Trigger Slope A:** Positive
- Custom Curve:** Disabled
- Scale 1:** +1.00000
- Multiplier 1:** 10
- Offset 1:** -1000.00
- Read 0 In:** +000000.
- Low In 1:** +010000.
- Low Read 1:** +0000.00
- High In 1:** +011000.
- High Read 1:** +0100.00

Analog Out Tab: This tab is selected. It shows the following settings for Analog Output:

- Source:** Item 1
- Lo Range Reading:** +0000.00
- Range:** 4-20mA Current
- Hi Range Reading:** +0100.00

Solution:

- Under Input+Display tab and Signal Input, set Mode to Rate, Function to “A only”, Gate Time to 0.1 sec, Time Out to 2 sec, and Display Type to “Norml 999999”. Native units will be Hz.
- Under Scaling tab, set Decimal Point to two places. If “Scale, Offset” is selected as scaling method, set Scale to +1.00000 and Multiplier to 10. Product of Scale and Multiplier will ensure that 1000 Hz are displayed as 10,000 counts (decimal point has no effect on counts). Also enter an Offset of -100,000 counts (previously selected decimal point will be displayed, but has no effect on counts). If Coordinates is selected as scaling method (by far the easiest scaling method for this example), simply enter endpoints as shown.
- Under the Analog Out tab, set Range to “4-20mA Current”, Lo Range Reading to +0000.00, and Hi Range Reading to +0100.00.

Example 3: Transmit rate in GPM from 36.67 pulse/gallon turbine flow meter

Application: Transmit rate in gallons per minute with three decimal places from a turbine flow meter with a K factor of 36.67 pulses per gallon. Set analog output to 4 mA at 0 GPM and 20 mA at 30 GPM.

The image displays three screenshots of a control panel interface, likely for a flow meter or similar device, showing configuration settings for a turbine flow meter.

Screenshot 1: Input+Display Tab

- Input+Display** (Selected):
 - Option: BASIC, EXTENDED
 - Boards: Dual Sig Cond
 - Signal Input**:
 - Mode: Rate
 - Function: A Only
 - Gate Time: 000.30 Secs
 - Time Out: 002.00 Secs
 - Display**:
 - Type: Norml 999999
 - Filter: Unfiltered
 - Display Item No.: Item 1
 - Power-On Total: Zero Total

Screenshot 2: Scaling Tab

- Item 1 L0**
 - A Rate (Selected)
 - Decimal Point 1: 111.111
 - Trigger Slope A: Positive
 - Custom Curve: Disabled
 - Scale 1: +1.63621
 - Multiplier 1: 1000
 - Offset 1: +000.000
 - Read 0 In: +000000.
 - Low In 1: +000000.
 - Low Read 1: +000.000
 - High In 1: +036670.
 - High Read 1: +060.000

Screenshot 3: Analog Out Tab

- Analog Output**
 - Source: Item 1
 - Lo Range Reading: +000.000
 - Range: 4-20mA Current
 - Hi Range Reading: +030.000

Solution:

- Under Input+Display tab and Signal Input, set Mode to Rate, Function to “A only”, Gate Time to 0.3 sec, and Time Out to 2 sec. Under Display, set Type to “Norml 999999”. Native units will be pulses/sec (Hz).
- Under Scaling tab, set Decimal Point tab to 111.111. If “Scale, Offset” is selected as scaling method, set Scale to 1.63621 with a multiplier of 1000. The scale of 1.63621 is the inverse of K factor, namely 0.027270 gallons per pulse, multiplied by 60 to go from the transmitter’s native rate per second to rate per minute. The multiplier of 1000 changes the units of volume from gallons to milligallons, as required for three decimal places. If Coordinates is selected as scaling method, enter 0 for Low In and Low Read. Enter 36670 (milli-gallons/sec) for High In and +060.000 for High Read (60.000 GPM). Note that Low In and High In are in converted units after the Multiplier of 1000 to go from gallons to milligallons.
- Under Analog Out tab, set Range to “4-20mA Current”, Lo Range Reading to +000.000, and Hi Range Reading to +030.000, both in GPM.

Example 4: Transmit rate of fuel consumptions in liters/km and drive a 0-10V meter

Application: Transmit a ship's rate of fuel consumption to two decimal places in liters/km and display fuel consumption from 0-100 liters/km on a 0-10V analog meter. Fuel flow is measured using a turbine flow meter with a K factor of 5.126 pulses/liter. Speed is measured using a 100 pulses/km speedometer.

Solution:

- Under Input+Display tab, check Extended (an Extended main board is required). Set Mode to Rate and Function to A/B. Set a relatively long Gate Time of 3 sec since the maximum speedometer pulse rate is expected to be 2000 pulses/hour at 20 km/hour, or 1 pulse every 1.8 sec. Set Time Out to its maximum of 199.99 sec, since pulse rates will be very low when the ship starts. Click on Read to display Item 1 (A/B). The red field will change to green.
- Under Scaling tab, set up Item 2 (A Rate or fuel consumption/sec) to have a scale factor of 0.19508 liters/sec. This is pulses/sec x (1 liter)/(5.126 pulses). Set up Item 3 (B Rate or rate of travel in km/sec) to have a scale factor 0.01 km/sec. This is pulses/sec x (1 km)/(100 pulses). Ignore Decimal Point, since B Rate is not displayed. Set Item 1 (A Rate / B Rate) to Decimal Point 2222.22 and Resolution to 100. This changes the displayed units to centiliters/sec. The decimal point is not part of the arithmetic.
- Under Analog Out tab, set Source to Item 1, Range to “0-10V Voltage”, Lo Range Reading to +0000.00, and Hi Range Reading to +0100.00 (liters/km).

10.2 PERIOD MODES: Inverse of frequency. Native units are microseconds, so scale appropriately.

10.3 TOTAL MODES

- **Total A, B** determines Total independently for Channel A (Item #1) and Channel B (Item #2). Either item can be selected for the analog output.
- **Total A Only** determines Total only for Channel A (Item #1). Channel B is not used.
- **Total Burst** (Extended main board) determines the total number of signal bursts applied to Channel B (Item #1). Gate time should be set to zero. Time Out must be greater than the maximum time between bursts.
- **Total B, A Rate** (Extended main board) determines Total for Channel B (Item #1) and Rate for Channel A (Item #2).
- **Total A, B UpDnCtl** (Extended main board) determines Total A (Item #1), where the up or down count direction is determined by an input on Channel B. If the menu item SLOPE is set to 0 for Channel B, an input level on B below the jumper set Low Threshold B causes the count to go up, and an input level above the jumper set High Threshold causes the count to go down. If SLOPE for Channel B is set to 1, the opposite occurs. The maximum frequency on A that can be counted is 250 kHz, or a minimum of 4 μ s between pulses.
- **Total A, B InhibitCtl** (Extended main board) determines Total A (Item #1), where counting may be inhibited by a control input on Channel B. If the menu item SLOPE is set to 0 for Channel B, a low input level on B allows counting, and a high input level inhibits counting. If the SLOPE for Channel B is set to 1, the opposite occurs. The maximum frequency on A that can be counted is 1 MHz.
- **Totals A+B, A-B, AxB, A/B, A/B-1** (Extended main board) determine arithmetic combinations of Totals A and B (Item #1). Total A (Item #2) and Total B (Item #3) are also tracked and can be selected for analog output.

Applicable to all totalizing application examples:

Connect your transmitter to a PC running Instrument Setup (IS) Software. Establish communications. To open a setup file for editing, click on “Get Setup” under the Counter tab to retrieve the latest setup file from your transmitter, or click on “Open Setup” under the File tab to retrieve a previously saved setup file from disk.

Relay Alarms and Analog Out respond to the units that are transmitted digitally. While a decimal point can be specified and will be transmitted digitally, it does not affect the number of units. If “Scale, Offset” is used as the scaling method and liquid volume is to be transmitted in L with three decimal places, first change the units to mL, then set the decimal point.

Following editing, click on the Main Menu button. Under the Counter tab, click on “Put Setup” to download your setup file into your transmitter. Under the File tab, click on “Save Setup As” to save your setup to disk if desired.

Example 1: Transmit volume in gallons from a 36.67 pulse/gallon flow meter

Application: Digitally transmit volume in gallons with two decimal places from a flow meter with a K factor of 36.67 pulses/gallon. Also transmit 4-20 mA corresponding to 0-50 gallons.

The image displays three screenshots of a control panel interface, likely for a flow meter or similar device, showing configuration settings for digital and analog output.

Screenshot 1: Input+Display Tab

- Option: **BASIC** (selected), Boards: **Dual Sig Cond**
- Signal Input:
 - Mode: **Total**
 - Function: **A Only**
 - Gate Time: **000.00** Secs
 - Time Out: **002.00** Secs
- Display:
 - Type: **Norml 999999**
 - Filter: **Unfiltered**
 - Display Item No.: **Item 1**
 - Power-On Total: **Restore Total**

Screenshot 2: Scaling Tab (Item 1 L0)

- Selected Item: **A Total**
- Decimal Point 1: **1111.11**
- Trigger Slope A: **Positive**
- Custom Curve: **Disabled**
- Scale 1: **+2.72702**
- Multiplier 1: **1**
- Offset 1: **+0000.00**
- Read 0 In: **+000000.**
- Low In 1: **+000000.**
- Low Read 1: **+0000.00**
- High In 1: **+0036.67**
- High Read 1: **+0001.00**

Screenshot 3: Analog Output Tab

- Source: **Item 1**
- Lo Range Reading: **+0000.00**
- Range: **4-20mA Current**
- Hi Range Reading: **+0050.00**

Solution:

- Under Input+Display tab, set Mode to Total, Function to “A Only”, and Gate Time to 0 sec (to maximize display update rate). Set “Power-On Total” to “Restore Total” to retain total in event of power loss.
- Under Scaling tab, set Decimal Point to two places. If “Scale, Offset” is selected as scaling method, set Scale to 2.72702 and Multiplier to 1. The product of Scale and Multiplier is 2.72702 hundredths of a gallon/pulse, which is the inverse of K factor. If Coordinates scaling method is selected, enter High In and High Read to indicate that 36.67 pulses should read 1.00 gallon.
- Under Analog Out tab, set Range to “4-20 mA current”. Enter 0.00 gallons for Lo Range Reading and 50.00 gallons for Hi Range Reading, as shown.

Example 2: Transmit simultaneous rate & total from a 36.67 pulse/gallon flow meter

Application: Digitally transmit rate in gallons/minute with two decimal places from a flow meter with a K factor of 36.67 pulses/gallon, also display volume in gallons with no decimal point.

The image shows two screenshots of a flow meter configuration interface. The top screenshot is the 'Input+Display' tab, and the bottom screenshot is the 'Scaling' tab.

Input+Display Tab:

- Input Option: Dual Sig Cond
- Mode: Rate
- Function: A, A Total
- Gate Time: 000.00 Secs
- Time Out: 010.00 Secs
- Type: Norml 999999
- Filter: Unfiltered
- Display Item No.: Item 1
- Power-On Total: Restore Total

Scaling Tab (Item 1 L0):

A Rate:

- Decimal Point 1: 1111.11
- Trigger Slope A: Positive
- Custom Curve: Disabled
- Scale 1: +1.63621
- Multiplier 1: 100
- Offset 1: +0000.00
- Read 0 In: +000000.
- Low In 1: +000000.
- Low Read 1: +0000.00
- High In 1: +0036.67
- High Read 1: +0060.00

A Total:

- Decimal Point 2: 222222.
- Scale 2: +1.66666
- Multiplier 2: 0.0001
- Offset 2: +000000.
- Low In 2: +000000.
- Low Read 2: +000000.
- High In 2: +006000.
- High Read 2: +000001.

Solution:

- Under Input+Display tab, check Extended (an Extended main board is required). Set Mode to Rate and Function to “A, A Total”. Rate A will be Item 1, Total A will be Item 2. In this mode, total is calculated by adding rate/sec every sec, not directly from the count of flow meter pulses. Set “Power-On Total” to “Restore Total” to retain total in event of power loss.
- Under Scaling tab for A Rate, set two decimals. If “Scale, Offset” is selected, set Scale to +1.63621 and Multiplier to 100. This is inverse of K factor, multiplied by 100 to change counts from gallons to hundredths of a gallon, and further multiplied by 60 to go from the native rate per sec to rate per minute. If Coordinates is selected, enter Hi In and High Read so that 36.67 pulses/sec reads 60.00 gallons/minute (GPM). With both scaling methods, rate counts will be in hundredths of a gallon/minute and disregard the decimal point.
- Under Scaling tab for A Total, set decimal to far right. If “Scale, Offset” is selected, set Scale 2 to 1.66666 and Multiplier to 0.0001 to go from hundredths of a gallon/minute to gallons/sec. If Coordinates is selected, enter Hi In and High Read so that a rate of 6000 hundredths of a gallon/minute is totalized every second to produce a total of 1 gallon.

Example 3: Transmit total volume by adding two flow meter channels

Application: Digitally transmit total volume in gallons to two decimal places from two pipes dispensing liquids into the same tank. Flow meter A is calibrated to 36.67 pulses/gallon, flow meter B to 58.12 pulses/gallon. Assign the transmitter’s analog output to total volume.

The image shows two screenshots of a transmitter configuration interface. The top screenshot is the 'Input+Display' tab. It has radio buttons for 'BASIC' and 'EXTENDED' (selected). Under 'Option Boards', 'Dual Sig Cond' is selected. In the 'Signal Input' section, 'Mode' is 'Total' and 'Function' is 'A+B'. 'Gate Time' is 000.00 Secs and 'Time Out' is 002.00 Secs. In the 'Display' section, 'Type' is 'Norml 999999', 'Filter' is 'Unfiltered', 'Display Item No.' is 'Item 1', and 'Power-On Total' is 'Restore Total'. The bottom screenshot is the 'Scaling' tab. It shows three items: 'Item 1 L2' (A Total + B Total) with 'Decimal Point 2' set to 2222.22 and 'Resolution' set to 1. 'Item 2 L2' (A Total) has 'Scale 1' set to +2.72702, 'Multiplier 1' set to 1, 'Offset 1' set to +0000.00, and 'Trigger Slope A' set to Positive. 'Item 3 L2' (B Total) has 'Decimal Point 1' set to 1111.11, 'Trigger Slope B' set to Positive, 'Scale 2' set to +1.72057, 'Multiplier 2' set to 1, and 'Offset 2' set to +0000.00. Both 'Scale, Offset' and 'Coordinates' options are selected for items 2 and 3.

Solution:

- Under Input+Display tab, check Extended (an Extended main board is required for Total). Set Mode to Total and Function to “A+B”. “A Total + B Total” will be Item 1, A Total will be Item 2, and B Total will be Item 3. Set Gate Time to 0 sec to maximize the update rate. Set “Power-On Total” to “Restore Total” to retain total in event of power loss.
- Under Scaling tab, set both decimal points to two places. If “Scale, Offset” is selected as scaling method, set Scale 1 to +2.72702 for A Total and Scale 2 to +1.72057 for B Total. Set both Multipliers to 1 so that the product of Scale and Multiplier produces the inverse of K factor expressed in hundredths of a gallon/pulse. If Coordinates is selected as the scaling method, enter High In and High Read as shown to indicate that 36.67 pulses should read 1.00 gallon for Channel A, and that 58.12 pulses should read 1.00 gallon for Channel B.
- Under Analog Out tab, set Source to Item 1 (A Total + B Total).

10.4 TIMING MODES

- **Time Interval A to B** determines the time between periodic inputs on Channels A and B. Timing starts when a pulse is applied to Channel A (positive edge if slope A is 0, negative edge if slope A is 1), and ends when a pulse is applied to Channel B (positive edge if slope B is 0, negative edge if slope B is 1). Pulse width may be measured by tying inputs A and B together and selecting a positive or negative edge to start (Slope A) and the opposite polarity edge to stop (Slope B). If multiple start and stop pulses occur during the Gate Time, the displayed value is the average of pulse widths. The value is updated at the end of each Gate Time. With a scale factor of 1, one count is one microsecond.
- **Stopwatch A to A** times individual events applied to Channel A (Item 1) and the accumulated “Grand Total Time” of all events since last reset (Item 2). Timing is based on the same positive (or negative) edge of start and stop pulses. Time of individual events is reset to 0 when a new start pulse occurs. Time of accumulated events is reset via a reset line.
- **Stopwatch A to B** measures time between a start pulse on Channel A and a stop pulse on Channel B. Timing is the same as for A to A, except that positive or negative edges may be selected separately for Channels A and B. This allows the pulse width measurement of single pulses by tying Channels A and B together. One slope is selected to start timing, and the opposite slope to stop timing.

Applicable to all timing application examples:

Connect your transmitter to a PC running Instrument Setup (IS) Software. Establish communications. To open a setup file for editing, click on “Get Setup” under the Counter tab to retrieve the latest setup file from your transmitter, or click on “Open Setup” under the File tab to retrieve a previously saved setup file from disk.

Relay Alarms and Analog Out respond to the units that are transmitted digitally. While a decimal point can be specified and will be transmitted digitally, it does not affect the number of units. Native counts in timing modes are in microseconds. Note that total modes can also be used for timing, for example to count 50 or 60 Hz AC power line pulses. Total modes have the advantage that they can retain counts in the event of power loss.

Following editing, click on the Main Menu button. Under the Counter tab, click on “Put Setup” to download your setup file into your transmitter. Under the File tab, click on “Save Setup As” to save your setup to disk if desired.

Example 1: Transmit machine run time with 0.00 hour resolution

Application: Track two machine run times in hours. Channel A time will have two decimals, will be per job for billing purposes, and will be reset at end of each job. Channel B time will have no decimals, will be total accumulated hours for machine maintenance purposes, and will be reset following maintenance. Turn on a warning light after 1000 hours of run time.

The image displays two screenshots of a control panel interface. The top screenshot shows the 'Input+Display' tab with 'BASIC' selected, 'Mode' set to 'Total', 'Function' set to 'A, B', 'Gate Time' at '000.00', and 'Power-On Total' set to 'Restore Total'. The bottom screenshot shows the 'Item 1 L0' configuration screen for Channel A and Channel B. Channel A is configured with 'Decimal Point 1' at '1111.11', 'Trigger Slope A' at 'Positive', 'Scale 1' at '+0.46296', and 'Multiplier 1' at '0.001'. Channel B is configured with 'Decimal Point 2' at '222222.', 'Trigger Slope B' at 'Positive', 'Scale 2' at '+0.46296', and 'Multiplier 2' at '0.00001'.

Solution:

- Apply 60 Hz power cycles to channels A and B and measure time by counting pulses using the totalizer mode, which can restore total following loss of power. There will be 216,000 pulses/hour or 0.0000046296 hours/pulse.
- Under Input+Display tab, set Mode to Total, Function to “A, B” and Gate Time to 0 sec. Set “Power-On Total” to “Restore Total” to retain total in event of power loss.
- Under Scaling tab for Channel A, set decimal point to 2 places. If “Scale, Offset” is selected, set Scale to +0.46296 and Multiplier to 0.001 for time in hundredths of an hour per 60 Hz pulse. If Coordinates is selected, enter 216000 pulses for 100 hundredths of an hour.
- Under Scaling tab for Channel B, set decimal point to 0 places. If “Scale, Offset” is selected, set Scale to +0.46296 and Multiplier to 0.00001 for time in hours per 60 Hz pulse. If Coordinates is selected, enter 216000 pulses for 1 hour.

Example 2: Transmit relay closing time in msec with 0.001 msec resolution

Application: Transmit closing time of a relay in msec with 0.001 msec resolution using stopwatch mode. Also transmit relay closing time from 0 to 200 msec as a 4-20 mA signal.

The image shows three screenshots of a software interface for configuring a relay timing measurement.

Top Screenshot (Input+Display tab): Shows the 'Signal Input' section with 'Mode' set to 'Stopwatch' and 'Function' set to 'A to B'. 'Gate Time' is 000.00 Secs and 'Time Out' is 199.99 Secs. The 'Display' section has 'Type' set to 'Norml 999999', 'Filter' set to 'Unfiltered', 'Display Item No.' set to 'Item 1', and 'Power-On Total' set to 'Zero Total'.

Middle Screenshot (Scaling tab): Shows 'Item 1 L0' settings. 'Stopwatch A to B' is selected. 'Decimal Point 1' is 111.111. 'Trigger Slope A' is Positive and 'Trigger Slope B' is Negative. 'Scale 1' is +1.00000 and 'Multiplier 1' is 1. 'Offset 1' is +000.000. 'Read 0 In' is +000000. 'Low In 1' is +000000. 'Low Read 1' is +000.000. 'High In 1' is +010000. 'High Read 1' is +010.000.

Bottom Screenshot (Analog Out tab): Shows 'Analog Output' settings. 'Source' is 'Item 1'. 'Lo Range Reading' is +000.000. 'Range' is '4-20mA Current'. 'Hi Range Reading' is +200.000.

Solution:

- As shown under Common Jumper Settings (page 17), set Channel A to “Logic levels” and Channel B to “NPN open collector.”
- Use Channel A to sense a positive voltage applied to relay coil. Wire Channel B across relay contacts. Upon contact closure, Channel B pull-up voltage will drop from 5V to 0V.
- Under Input+Display tab, set Mode to Stopwatch, Function to “A to B”, and Gate time to 0 sec. Set Display Type to “Norml 999999”. Native counts will be microseconds.
- Under Scaling tab, set decimal point to 3 places. Set Trigger Slope A to Positive and Trigger Slope B to Negative. If “Scale, Offset” is selected as scaling method, set Scale to +1.00000 and Multiplier 1 to read in units of 0.001 msec (or native microseconds). If “Coordinates” is selected as scaling method, set High In to +010000 and High Read to +010.000. Or select a similar pair of numbers which reflect a slope of 1. Ignore Item 2, “Grand Total Time”.
- Under Analog Out tab, set Range to “4-20mA Current”, Lo Range Reading to +000.000 and Hi Range Reading to +200.000.

10.5 PHASE ANGLE (Extended main board).

- **Phase A to B (0-360)** measures the phase difference between signals of the same period applied to Channels A and B over a span from 0° to 360°. Select this span if no negative readings are expected.
- **Phase A to B (+/-180)** measures the phase difference between signals of the same period applied to Channels A and B over a span from -180° to +180°. Select this span if negative readings are expected. If you experience an anomaly at 0°, set the A trigger slope to positive and the B trigger slope to negative. This will create a 180° offset, which you can correct under scaling.

Example of phase angle measurement with 0.01° resolution

Application: Measure phase difference to 0.01° between two AC signals centered around 0°.

The image shows two screenshots of a control panel interface for phase angle measurement.

Top Screenshot (Input+Display Tab):

- Input+Display:**
 - Option: BASIC, EXTENDED
 - Boards: Input Option (Dual Sig Cond)
- Signal Input:**
 - Mode: Phase
 - Function: A to B (+-180)
 - Gate Time: 001.00 Secs
 - Time Out: 002.00 Secs
- Display:**
 - Type: Norml 999999
 - Filter: Unfiltered
 - Display Item No.: Item 1
 - Power-On Total: Zero Total

Bottom Screenshot (Scaling Tab):

- Item 1 L0:**
 - Phase A to B +/-180
 - Decimal Point 1: 1111.11
 - Trigger Slope A: Positive
 - Trigger Slope B: Positive
 - Custom Curve: Disabled
 - Scale, Offset: +1.00000
 - Multiplier 1: 100
 - Offset 1: +0000.00
 - Read 0 In: +000000.
 - Low In 1: +0000.00
 - Low Read 1: +0000.00
 - High In 1: +1.00000
 - High Read 1: +0001.00

Solution:

- Jumper the signal conditioner for maximum sensitivity to catch zero voltage crossings and minimize effects of amplitude jitter. Apply one AC signal to Channel A and one to Channel B.
- Under Input+Display tab, select Extended (an extended main board is required for phase). Set Mode to Phase, Function to “A to B (+-180)”, and Gate time 1 sec (if one transmittal per second is desired). Native units will be degrees.
- Under Scaling tab, set decimal point to 2 places. Make both trigger slopes the same. If “Scale, Offset” is selected as scaling method, set Scale to +1.00000 and Multiplier to 100 to change units to hundredths of degrees. If Coordinates is selected as scaling method, enter +1.00000 for High In and +0001.00 for High Read, or to a similar pair of numbers for the same slope.

10.6 POWER FACTOR (Extended main board).

Power factor of an AC power system is the ratio of real power in watts (W) divided by apparent power in volt-amperes (VA). For sinusoidal signals, power factor is calculated from phase angle θ as $\cos(\theta)$. Power factor readings can range from 1.000 to 0.000 with three decimal places and an accuracy of 0.1% for sinusoidal signals at 50/60 Hz. While power factor is always positive, a minus sign is artificially assigned for negative phase angles, and power factor is set to 0 for phase angles greater than 90° .

Example of power factor measurement to 0.001 resolution

Application: Measure power factor with 0.001 resolution for two sinusoidal AC signals centered around 0° .

The image shows two screenshots of a control interface for power factor measurement. The top screenshot is the 'Input+Display' tab, and the bottom screenshot is the 'Scaling' tab.

Input+Display Tab:

- Option:** EXTENDED (selected), BASIC
- Input Option:** Dual Sig Cond
- Signal Input:**
 - Mode: Phase
 - Function: A to B (+-180)
 - Gate Time: 000.25 Secs
 - Time Out: 002.00 Secs
- Display:**
 - Type: Normal, Expt
 - Filter: Unfiltered
 - Display Item No.: Item 1
 - Power-On Total: Zero Total

Scaling Tab:

- Item 1 L0:** Phase A to B +-180
- Decimal Point 1:** 111.111
- Trigger Slope A:** Positive
- Trigger Slope B:** Positive
- Custom Curve:** Power Factor
- Scale 1:** +1.00000
- Multiplier 1:** 1
- Offset 1:** +000.000
- Read 0 In:** +000000.
- Low In 1:** +000000.
- Low Read 1:** +000.000
- High In 1:** +010000.
- High Read 1:** +010.000

Solution:

- As for phase angle, jumper signal conditioner for maximum sensitivity to catch zero voltage crossings and minimize effects of amplitude jitter. Apply one AC signal to Channel A and one to Channel B.
- Under Input+Display tab, select Extended (an extended main board is required). Set Mode to Phase, Function to “A to B (+-180)”, and Gate time 0.25 sec (if four transmittals per second are desired).
- Under Scaling tab, set decimal point to 3 places. Make both trigger slopes the same. Set Custom Curve to “Power Factor”. A Multiplier is not needed with power factor.

10.7 DUTY CYCLE (Extended main board)

Duty Cycle (A to B)/A measures On or Off period as a percentage of total period over a Gate Time which is selectable up to 199.99 s. The same signal is applied to Channels A and B. Time is measured between positive and negative edges of the signal, with averaging over multiple integral periods over the selected Gate Time. Native units are percent.

Example of duty cycle measurement with 0.01% resolution

Application: Measure “on” period of periodic laser pulses as % of total period with 0.01% resolution over a time interval of 10 sec. Output 0-100% to a 0-10V analog recorder.

The image shows three screenshots of the instrument's configuration interface, arranged vertically. Each screenshot has a menu bar at the top with tabs: Input+Display, Scaling, Filter, Relay Alarms, Communication, and Analog Out.

Top Screenshot (Input+Display tab):
- Radio buttons: BASIC, EXTENDED
- Option: Boards
- Input Option: Dual Sig Cond
- Signal Input section:
 - Mode: Duty Cycle
 - Function: (A to B)/A
 - Gate Time: 010.00 Secs
 - Time Out: 020.00 Secs
- Display section:
 - Type: Norml 999999
 - Filter: Unfiltered
 - Display Item No.: Item 1
 - Power-On Total: Zero Total

Middle Screenshot (Scaling tab):
- Item 1 L0
- Duty Cycle(AtoB)/A (highlighted)
- Square Root:
- Scale, Offset > (selected)
- Coordinates > (dotted)
- Decimal Point 1: 1111.11
- Trigger Slope A: Positive
- Trigger Slope B: Positive
- Custom Curve: Disabled
- Scale 1: +1.00000
- Multiplier 1: 100
- Offset 1: +0000.00
- Read 0 In: +000000.
- Low In 1: +0000.00
- Low Read 1: +0000.00
- High In 1: +0100.00
- High Read 1: +0100.00

Bottom Screenshot (Analog Out tab):
- Analog Output section:
 - Source: Item 1
 - Lo Range Reading: +0000.00
 - Range: 0-10V Voltage
 - Hi Range Reading: +0100.00

Solution:

- Under Input+Display, select Extended (an extended transmitter is required for duty cycle). Set Mode to “Duty Cycle”. Function will automatically be shown as “(A to B)/A”. Set Gate Time to 010.00 Secs.
- Under Scaling tab, set decimal point to 2 places. Set Trigger Slopes as needed. If “Scale, Offset” is selected as scaling method, set Scale to +1.00000 and Multiplier to 100. This will change units from 1% to 0.01%. Decimal Point selection does not affect counts. If Coordinates is selected as scaling method, set High In to +0100.00 hundredths of a percent and the desired High Read to +0100.00.

12. PROCESS RECEIVER SIGNAL CONDITIONER BOARD

The process receiver signal conditioner board converts 0-1 mA, 4-20 mA or 0-10 V analog process signals to a frequency signal, which is then processed mathematically by the counter main board to produce an internal reading of rate, total (time x rate), or 1/rate (time based on rate). Square root extraction is selectable in software. For example, with this capability, the transmitter can output a serial signal or a 4-20 mA process signal which tracks flow rate or totalized flow (volume) from a differential pressure flow transducer. The board needs to be configured via jumpers for the input signal type. It is recognized by Instrument Setup software, which will bring up the applicable menu items for the V-F Converter input option.

JUMPER SETTINGS

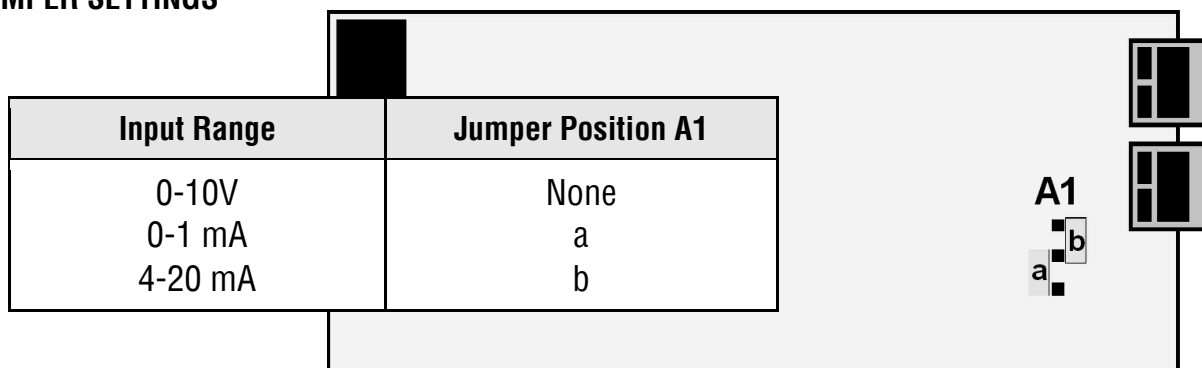

OPERATING MODES

- **A Only** (Rate A, Basic counter) accepts 0-1 mA, 4-20 mA or 0-10 V analog process signals to calculate an internal rate reading, which is then converted to rate. Scaling can be done by entering Scale and Offset, or using the Coordinates of 2 Points method. Measurements are averaged over a Gate Time, which is programmable from 10 ms to 199.99 sec. Selecting a long Gate Time provides a slower display update rate but superior noise filtering. Moving average filtering is selectable for noise reduction. Square root extraction is selectable for use with differential pressure flow transducers. Custom curve linearization is available with the Extended main board.
- **A, A Total** (Rate A, Total A, Basic Counter) allows rate to be determined as Item #1 and total as Item #2. Rate can be scaled using Scale and Offset, or the Coordinates of 2 Points method. Total can only be scaled using Scale and Offset. Total is calculated by adding rate per second every second. If square root extraction or custom curve linearization (available with Extended main board) is selected, the rate used is after square root extraction or linearization.
- **1/(A Rate)** (Extended main board) determines the inverse of rate. For example, this can be the time it takes an item to traverse an oven at a measured rate. Like Rate, 1/Rate can be scaled using Scale and Offset, or using the Coordinates of 2 Points method. Square Root extraction can be selected for rate. 1/Rate is not available with custom curve linearization.

Example of rate and volume from a 4-20 mA flow meter

Application: Transmit flow rate in GPM to three decimals and totalized volume in gallons to two places from a 4-20 mA flow meter calibrated so that 4 mA = 0 GPM and 20 mA = 18.756 GPM. Do not totalize reported flow rates below 0.050 GPM, as these are deemed to be noise.

The image shows two screenshots of a control panel interface for a flow meter. The top screenshot shows the 'Input+Display' tab with the following settings:

- Signal Input:** Mode: VF 4-20 mA, Function: A, A Total, Cutoff Value: 00.050, Gate Time: 00.100 Secs, Time Out: 003.00
- Display:** Type: Normal, Expnt, Filter: Unfiltered, Display Item No.: Item 1, Power-On Total: Restore Total, Cutoff Enable: Enabled

The bottom screenshot shows the 'Scaling' tab for 'Item 1 L0' with the following settings:

- VF 4-20mA A Rate:**
 - Decimal Point 1: 111.111
 - Trigger Slope A: Positive
 - Custom Curve: Disabled
 - Scale 1: +1.17225
 - Multiplier 1: 1
 - Offset 1: -004.689
 - Read 0 In: +00.0000
 - Low In 1: +04.0000
 - Low Read 1: +000.000
 - High In 1: +20.0000
 - High Read 1: +018.756
- A Total:**
 - Decimal Point 2: 2222.22
 - Scale 2: +1.00000
 - Multiplier 2: 1
 - Offset 2: +0000.00
 - Low In 2: +00.0000
 - Low Read 2: +0000.00
 - High In 2: +01.0000
 - High Read 2: +0100.00

Solution:

- Under Input+Display tab, set Signal Input Mode to “VF 4-20 mA”, Function to “A, A Total”, Cutoff Value to 00.050, Cutoff Enable to Enabled, and Power-On Total to “Restore Total” (to retain total in event of a power failure).
- Under Scaling tab for “VF 4-20 mA A Rate”, set Decimal Point to three places. If “Scale, Offset” scaling method is selected, set Scale 1 to +1.17225 (which is 18.756 GPM / 16.000 mA), and set Offset 1 to -4.689 GPM (so that 4 mA will read 0 GPM). If Coordinates is selected as scaling method, simply enter Low In, Low Read, High In, High Read as shown.
- Under Scaling tab for “A Total”, the time integration interval 1 sec. Enter 0.3126 Scale 2 (which is rate in gallons/sec) and +0000.00 for Offset 2 in gallons if you want the starting volume to be 0 gallons since last reset.

12. QUADRATURE SIGNAL CONDITIONER BOARD

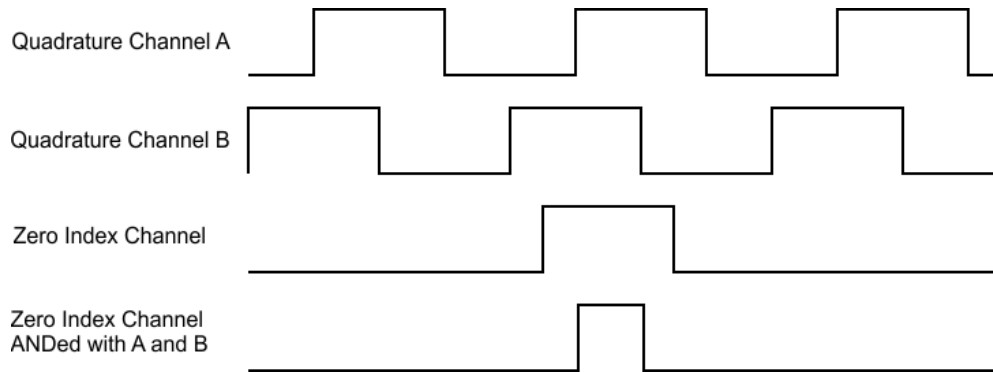

The quadrature signal conditioner can be used for position (Basic or Extended main board) or for position or rate (Extended main board). Two quadrature signals, which are 90° out of phase, are applied to Channel A and B inputs. Their phase relationship determines whether the count is clockwise (+) or counterclockwise (-). A zero index signal may be applied to a Z Channel as a position reference. For more detailed information, please see our Counter Manual, which has a 16-page section on quadrature and zero indexing. Always connect excitation return to Pin 6 of P5 (see page 8).

JUMPER SETTINGS

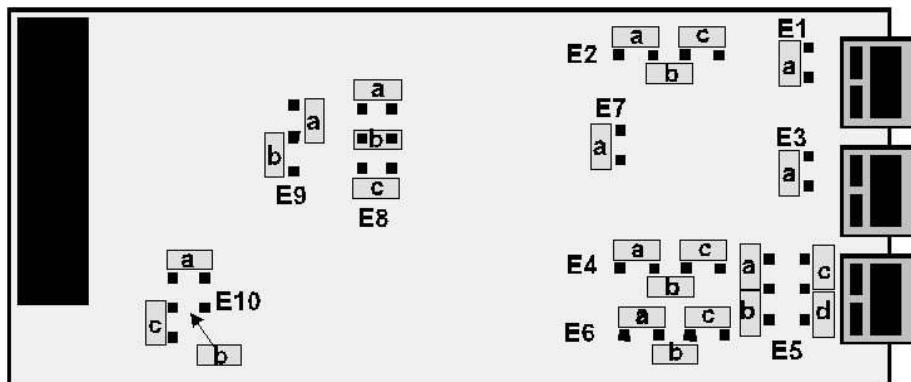

Input Type	E2	E4	E6	E5
Single ended, with excitation, no zero index	a, c	a, c	a, c	a, c
Single ended, with excitation, with zero index	a, c	a, c	a, c	c
Single ended, with external supply, no zero index	c	c	a, c	a, c
Single ended, with external supply, with zero index	c	c	a, c	a, c
Differential, with excitation, no zero index	b	b	a	b, d
Differential, with external supply, no zero index	b	b	a, c	a, c
Differential, with external supply, with zero index	b	b	b	c
Differential, with excitation, with zero index	Selection not available			

Input Termination (differential inputs only)	E1	E3	E5
For long cable runs (> 1000 ft, > 300 m)	a	a	a

Phase for Up Count	E7	
A positive, negative B transition (A leads B)	none	
A positive, positive B transition (B leads A)	a	

Count-by Options	E9	
X1 = positive edge of A input	none	
X2 = positive & negative edges of A input	a	
X4 = positive & negative edges of A & B inputs	b	

Zero Index Polarity	E8	
Positive	c	
Negative	none	

Zero Index ANDing	E10	E8
Zero Index (no ANDing)	c	-
Zero Index AND /A	a	-
Zero Index AND /B	a	a
Zero Index AND A	a	b
Zero Index AND B	a	a, b
Zero Index AND /A AND /B	b	-
Zero Index AND /A AND B	b	a
Zero Index AND A AND /B	b	b
Zero Index AND A AND B	b	a, b

OPERATING MODES

- Quadrature Total** (Basic or Extended main board) determines position in engineering units by subtracting counterclockwise transitions from clockwise transitions, as determined by the signal phase relationship, applying a programmable scale factor to the total, and adding a programmable offset to the scaled total. The output update rate is set by a Gate Time, which should be set to its minimum of 10 ms. When the scaled total reaches a programmable Preset, it is reset to Offset.
- A zero index function** is available on a separate zero index channel to reset the count to the expected count when a zero index pulse is detected. For example, if 3000 counts is expected after three 1000-count revolutions, but the current count is 2998 when the zero index pulse is detected, the count is reset to 3000. Since a wide zero index pulse could cause a count discrepancy in the region between transitions, the zero index pulse can be shaped by an AND combination with the A or B channels, as set by jumpers. Please see the diagram at the top of the previous page.
- Quadrature Rate** (Extended main board) determines rate in engineering units by subtracting counterclockwise rate from clockwise rate. Both rates can be scaled using Scale and Offset, or the Coordinates of 2 Points method. Rate is measured over a gate time, which is

programmable from 10 ms to 199.99 sec. Since one of the two channels may not be measuring any pulses over the gate time, a Time Out from 10 ms to 199.99 sec is also programmable. The transmitter update rate will never be less than every Time Out.

Example of rate in feet/sec from a 1024 pulse/revolution quadrature encoder

Application: Transmit rate in feet/sec with 3 decimals using a 1024 pulse/revolution quadrature encoder tied to a roller with 1.782 ft circumference. Have 4 updates/sec.

Solution:

- Under Input+Display tab, set Signal Input Mode to Quadrature, Function to Rate, Gate Time to 0.22 sec, and Time Out to 1.00 sec. Note that quadrature rate only works with Extended version. Under “Pulses per Rev”, press the F1 key for details on zero indexing.
- Under Scaling tab, apply same scaling to clockwise (CW) and counterclockwise (CCW) rates, which are subtracted for net rate. Set decimal points to three places, which requires the units to be in one thousands of a foot/sec. If “Scale, Offset” scaling method is selected, set Scale to +1.74023 one thousands of a foot per/sec per pulse/sec. If Coordinates scaling method is selected, set High In to 1024 pulses/sec and High Read to 1.782 ft/sec. Set Trigger Slope B to change count direction.

13. DUAL RELAY OPERATION

Dual AC/DC solid state relays rated 120 mA are standard for alarm or setpoint control and are independently set up via the “Relay Alarms” tab of Instrument Setup Software. For online help with any data entry field, press the F1 key.

- Setpoint.** The number to which the current reading is compared if deviation is set to zero. The reading is the count in engineering units that is transmitted digitally and is also used for analog output. For example, if the transmitted reading is in gallons/minute, the setpoint will be referenced to that reading, not to the raw pulse rate sent from a turbine flow meter.

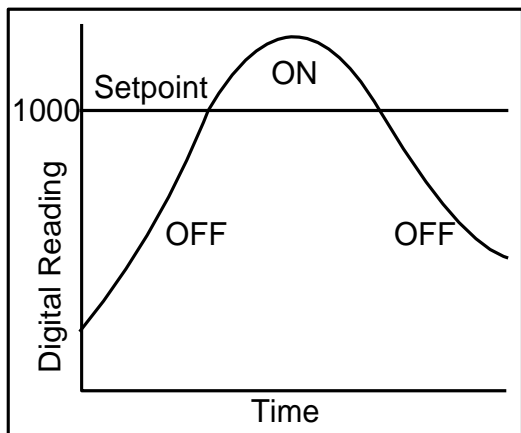

*“Active High” On/Off setpoint control
with deviation = 0*

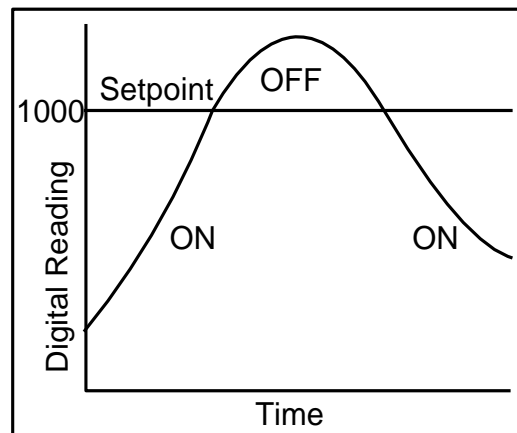

*“Active Low” On/Off setpoint control
with deviation = 0*

- **Deviation.** A positive number that can be added or subtracted from the setpoint, depending on the Deviation Type, to determine when an alarm becomes Active or Inactive.
- **Alarm Source.** Depending on the Signal Input Mode and Function selected under the Input+ Display tab, the alarm can be assigned to any of up to three Items, for example to Item 1 (A rate / B rate), Item 2 (A rate), or Item 3 (B rate).
- **Alarm State.** If “Active High” is selected, the Active Alarm State is defined as being above the setpoint. If “Active Low” is selected, the Active Alarm State is defined as being below the setpoint. If “Disabled” is selected, the Alarm State is always inactive.
- **Relay State.** A setting with ties the Relay State to the Alarm State. If “Active On” is selected, the relay will be closed when the Alarm State is 1. If “Active Off” is selected, the relay will be open when the Alarm State is 1.
- **Deviation Type.** Three choices are offered: Band Deviation, Split Hysteresis, and Span Hysteresis. These define how Setpoint and Deviation are to be combined to set Alarm State.

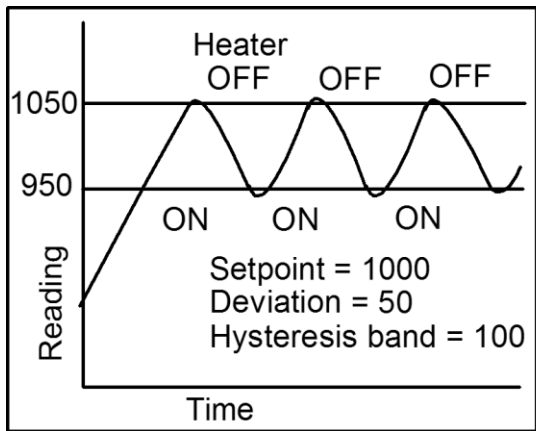

Split Hysteresis for heater control

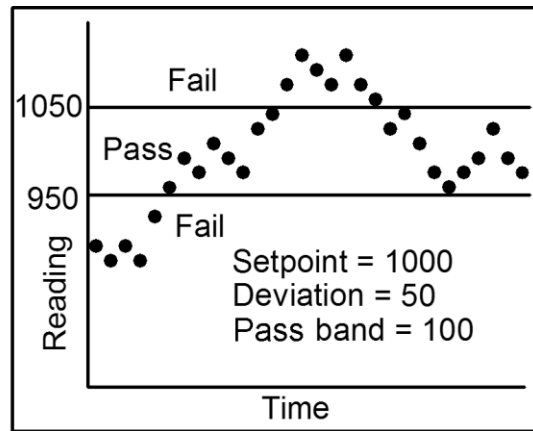

Band Deviation for component testing

In Band Deviation, the relay opens (or closes) when the reading falls within the deviation band, and closes (or opens) when the reading falls outside. Two deviation limits lie symmetrically around the setpoint to create the deviation band. Passbands around a setpoint are often used for go-no-go component testing.

In Split Hysteresis, the relay opens (or closes) when the reading goes above the Setpoint plus one Deviation, and closes (or opens) when the reading falls below the Setpoint less one Deviation. Two Deviation limits lie symmetrically around the Setpoint to create a deviation band. A narrow hysteresis band is often used to minimize relay chatter. A wide band can be used for on-off control.

In Span Hysteresis, operation is as for Split Hysteresis, except that the Setpoint is always on the high side, and a single Deviation lies below the Setpoint to create the hysteresis band. Span Hysteresis is considered by some to be more intuitive than Split Hysteresis.

- **Alarm Type.** Selections are Non-Latching and Latching. Under Non-Latching, the relay is only closed (or open) while the Alarm State is Active. Under Latching, the activated relay remains closed (or opens) until reset regardless of the Alarm State. Resetting is normally achieved by temporarily grounding one of the transmitter's control inputs, which has been set to Function Reset under the "Input+Display" tab.
- **Alarms 1,2 No. Rdgs to Alarm.** Selections are binary steps from 1 to 128. This is the number of consecutive alarm readings that must occur to create an Active alarm. Numbers higher than 2 provide some Alarm filtering so that 1 or 2 noisy readings do not cause an Active Alarm. The Alarm becomes Inactive if one of the consecutive readings fails to be an Alarm reading. The Alarm readings counter then resets to 0.

14. INPUT SIGNAL FILTERING

The **Filter tab** provides selections to minimize the effect time jitter and electrical noise which can affect trigger points. In most cases, filtering is only available for Item 1 and is grayed out for totalizing and stopwatch functions.



- **Time Constant** provides a moving average filter with the following eight equivalent RC time constants: no filter, 0.1 sec, 0.2 sec, 0.4 sec, 0.8 sec, 1.6 sec, 3.2 sec, and 6.4 sec. The longer time constants provide superior noise filtering at the expense of fast response time. Note that filtering can also be accomplished by lengthening the Gate time under the Input+Display tab.
- **Type** allows selection of Adaptive or Conventional filtering. With Adaptive, the time constant is changed dynamically so that the transmitter can respond rapidly to actual changes in signal while filtering out random noise. The moving average filter is reset to the latest reading when the accumulated difference between individual readings and the filtered reading exceeds a Threshold. The accumulated difference is also reset to zero when the latest reading has a different polarity than the filtered reading. With Conventional filtering, the adaptive feature is disabled and the Time Constant does not change.
- **Threshold** allows selection of Low Adaptive or High Adaptive for the Adaptive filter selection. Normally select Low. Select High if the signal has large spurious transients which should not be considered as an actual change in signal.
- **Peak/Valley Filter** allows the peak (maximum) or valley (minimum) functions to be based on Unfiltered or Filtered readings. Normally select Unfiltered. Select Filtered if you expect spurious readings which you do not wish to capture.

15. TRANSMITTER CALIBRATION

All ranges of our transmitters have been digitally calibrated at the factory prior to shipment using computers and calibration equipment certified to NIST standards. If recalibration is required, your transmitter may be returned to the factory or to an authorized distributor.

The counter main board contains an EEPROM, which stores calibration constants for the quartz crystal oscillator and the analog output. The V-to-F converter signal conditioner board stores its own stores its own voltage-to-frequency calibration constants EEPROM. The dual channel pulse input signal conditioner and quadrature signal conditioner boards do not require calibration. As a result, transmitter signal conditioner boards can be interchanged without recalibration.

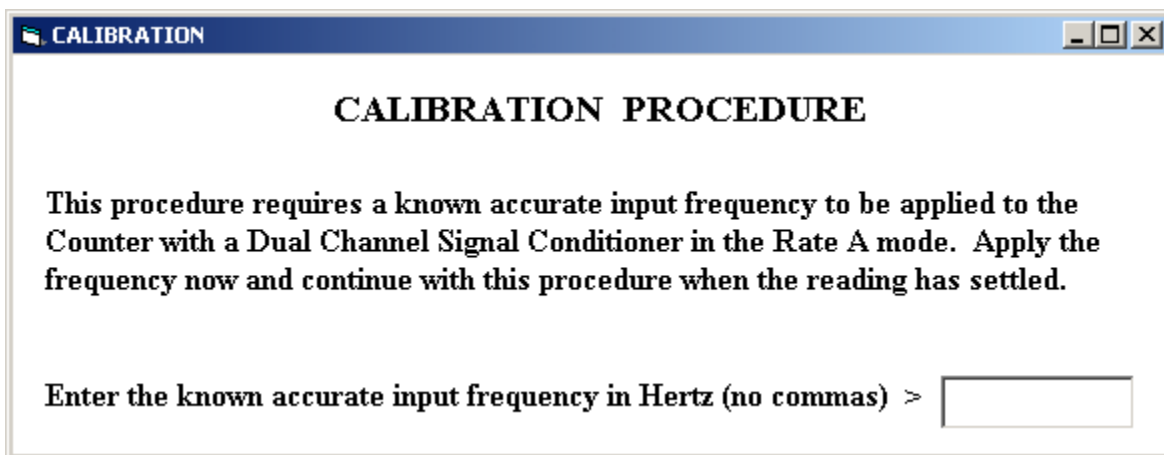

Calibration of the quartz crystal is easily accomplished using Instrument Setup software. First set jumpers for "Logic levels" (top of page 20) to remove filtering. Select Calibration from the Main Menu. Apply a frequency reference signal, and enter the known frequency in Hz.

Calibration of the V-to-F signal conditioner requires use of voltage reference signals and the calibration program `vfc3.exe`, which is available for free download.

16. CUSTOM CURVE LINEARIZATION

Curve.exe is a DOS-based, executable PC program used to set up an Extended transmitter so that the analog output and internal digital readings have a user-defined, non-linear relationship with the input signal. The calculated linearizing parameters are downloaded into non-volatile memory of the transmitter. The curve-fitting algorithm uses quadratic segments of varying length and curvature, and includes diagnostics to estimate curve fitting errors. The program is self-prompting, avoiding the need for detailed printed instructions. This manual section is only intended as an introduction.

GETTING STARTED

Download **curve.exe** from the distribution CD into the same directory that will contain your data files, such as **c:\curves**. Connect your transmitter to the PC and double-click on **curve.exe**, which is an executable file. Follow the steps on the computer screens, which will prompt you and provide extensive help information. Pressing R (Enter) returns to the main menu. You will be given the choice of four data entry modes, all of which are explained in detail.

- 1) Text file entry mode,
- 2) 2-coordinate keyboard entry mode,
- 3) 2-coordinate file entry mode, and
- 4) Equation entry mode.

17. MODBUS PROTOCOL TRANSMITTER COMMUNICATIONS

1.0 GENERAL

The Modbus capability conforms to the Modbus over Serial Line Specification & Implementation guide, V1.0. Both the Modbus RTU and Modbus ASCII protocols are implemented. This 5-page manual section presents key programmable Modbus features. Our detailed Modbus manual can be downloaded from <http://www.laurels.com/downloadfiles/modbus.pdf>

Modbus RTU

Baud Rate..... 300, 600, 1200, 2400, 4800, 9600 or 19200
Data Format 1 start bit, 8 data bits, 1 parity bit, 1 stop bit (11 bits total)
Parity..... None, Odd, Even (if None, then 2 Stop bits for 11 total)
Address..... 0 for broadcast, 1-247 for individual meters

Modbus ASCII

Baud Rate..... 300, 600, 1200, 2400, 4800, 9600 or 19200
Data Format 1 Start bit, 7 Data bits, 1 Parity bit, 1 Stop bit (10 bits total)
Parity..... None, Odd, Even (if None, then 2 Stop bits for 10 total)
Address..... 0 for broadcast, 1-247 for individual meters

2.0 FRAMING

Modbus RTU: Message frames are separated by a silent interval of at least 3.5 character times. If a silent interval of more than 1.5 character times occurs between two characters of the message frame, the message frame is considered incomplete and is discarded. Frame Check = 16 bit CRC of the complete message excluding CRC characters.

Modbus ASCII: The message begins immediately following a colon (:) and ends just before a Carriage Return/ Line Feed (CRLF). All message characters are hexadecimal 0-9, A-F (ASCII coded). The system allowable time interval between characters may be set to 1, 3, 5 or 10 seconds. Frame Check = 1 byte (2 hexadecimal characters) LRC of the message excluding the initial colon (:) and trailing LRC and CRLF characters.

3.0 COMMUNICATIONS SETUP

Parameters selectable via downloaded Instrument Setup software:

Serial Protocol Custom ASCII, Modbus RTU, Modbus ASCII
Modbus ASCII Gap Timeout..... 1 sec, 3 sec, 5 sec, 10 sec
Baud Rate..... 300, 600, 1200, 2400, 4800, 9600, 19200
Parity No parity, odd parity, even parity
Device Address 0 to 247

4.0 SUPPORTED FUNCTION CODES

FC03: Read Holding Registers

Reads internal registers containing setup parameters (Scale, Offset, Setpoints, etc.)

FC10: Write Multiple Registers (FC10 = 16 dec)

Writes internal registers containing setup parameters (Scale, Offset, Setpoints, etc.)

FC04: Read Input Registers

Reads measurement values and alarm status. Returns values in 2's Complement Binary Hex format without a decimal point. The displayed system decimal point can be read with FC03 at address 0057. Use only **odd** Register Addresses and an **even** number of Registers.

Register Address	TM Transmitter Response
-----	-----
00 01	Returns Hi word of Alarm status
00 02	Returns Lo word of Alarm status
00 03	Returns Hi word of Measurement value
00 04	Returns Lo word of Measurement value
00 05	Returns Hi word of Peak value
00 06	Returns Lo word of Peak value
00 07	Returns Hi word of Valley value
00 08	Returns Lo word of Valley value

FC05: Write Single Coil

Action command to meter

Output Address	Output Value	Action Command
-----	-----	-----
00 01	FF 00	Transmitter Reset (No Response)
00 02	FF 00	Function Reset (Peak, Valley)
00 03	FF 00	Latched Alarm Reset
00 04	FF 00	Peak Reset
00 05	FF 00	Valley Reset
00 0C	FF 00	Tare Command (Weight Transmitter) (00 00 resets Tare)

FC08: Diagnostics

Checks communications between the Master and Slave, and returns the count in the Modbus Slave counters (which are reset when the meter is reset).

Hex Sub Function Code	Data Send	Response Data	Description
00 00	Any	Same as sent	Returns Query Data (N x 2 bytes). Echo Request.
00 01	FF 00 00 00	FF 00 00 00	Restarts Communications. If in the Listen-Only mode, no response occurs. Takes Slave out of the Listen-Only mode and one of the following: Clears communications event counters. Does not clear communications event counters.
00 04	00 00	None	Forces Listen-Only. All addressed and broadcast Messages are monitored and counters are incremented, but no action is taken or response sent. Only Sub-Function 00 01 causes removal of this Listen-Only state.
00 0A	00 00	00 00	Clears all Modbus slave counters.
00 0B	00 00	Total Message Count	Returns total number of messages detected on the bus, including those not addressed to this Slave. Excludes bad LRC/CRC, parity error or length < 3.
00 0C	00 00	Checksum Error Count	Returns total number of messages with bad LRC/ CRC, parity or length < 3 errors detected on the bus including those not addressed to the Slave.
00 0D	00 00	Exception Error Count	Returns total number of Exception responses returned by the Addressed Slave or that would have been returned if not a broadcast message or if the Slave was not in a Listen-Only mode.
00 0E	00 00	Slave Message Count	Returns total number of messages, either broadcast or addressed to the Slave. Excludes bad LRC/CRC, parity or length < 3 errors.
00 0F	00 00	No Response Count	Returns total number of messages, either broadcast or addressed to the Slave, for which Slave has returned No Response, neither a normal response nor an exception response. Excludes bad LRC/CRC, parity or length < 3 errors.
00 11	00 00	Slave Busy	Returns total number of Exception Code 6 (Slave Busy) responses.

5.0 SUPPORTED EXCEPTION RESPONSE CODES

Code	Name	Error Description
01	Illegal Function	Illegal Function Code for this Slave. Only hex Function Codes 03, 04, 05, 08, 10 (dec 16) are allowed.
02	Illegal Data Address	Illegal Register Address for this Slave.
03	Illegal Data Value	Illegal data value or data length for the Modbus protocol.
04	Slave Device Failure	Slave device failure (eg. Transmitter set for external gate).

6.0 MESSAGE FORMATTING

MA = Meter Address	DD = Data (Hex)	CL = CRC Lo Byte
FC = Function Code	WW = Data (On/Off)	CH = CRC Hi Byte
RA = Register Address	SF = Sub-Function	CR = Carriage Return
NR = Number of Registers	EC = Error Code	LF = Line Feed
NB = Number of bytes	LRC = ASCII Checksum	

Modbus RTU Format

FC	Action	> 3.5 Char	Byte Number										
			1	2	3	4	5	6	7	8	9	10	11
03	Request	NoTx	MA	FC	RA	RA	NR	NR	CL	CH			
03	Response	NoTx	MA	FC	NB	DD*	DD*	CL	CH				
04	Request	NoTx	MA	FC	RA	RA	NR	NR	CL	CH			
04	Response	NoTx	MA	FC	NB	DD*	DD*	CL	CH				
05	Request	NoTx	MA	FC	RA	RA	WW	WW	CL	CH			
05	Response	NoTx	MA	FC	RA	RA	WW	WW	CL	CH			
08	Request	NoTx	MA	FC	SF	SF	WW	WW	CL	CH			
08	Response	NoTx	MA	FC	SF	SF	DD	DD	CL	CH			
10	Request	NoTx	MA	FC	RA	RA	NR	NR	NB	DD*	DD*	CL	CH
10	Response	NoTx	MA	FC	RA	RA	NR	NR	CL	CH			
	Exception Response	NoTx	MA	FC +80	EC	CL	CH						

DD* = (DD DD) times NR (Number of Registers)

Modbus ASCII Format

FC	Action	Byte Number												
		1	2	3	4	5	6	7	8	9	10	11	12	13
03	Request	:	MA	FC	RA	RA	NR	NR	LRC	CR	LF			
03	Response	:	MA	FC	NB	DD*	DD*	LRC	CR	LF				
04	Request	:	MA	FC	RA	RA	NR	NR	LRC	CR	LF			
04	Response	:	MA	FC	NB	DD*	DD*	LRC	CR	LF				
05	Request	:	MA	FC	RA	RA	WW	WW	LRC	CR	LF			
05	Response	:	MA	FC	RA	RA	WW	WW	LRC	CR	LF			
08	Request	:	MA	FC	SF	SF	WW	WW	LRC	CR	LF			
08	Response	:	MA	FC	SF	SF	DD	DD	LRC	CR	LF			
10	Request	:	MA	FC	RA	RA	NR	NR	NB	DD*	DD*	LRC	CR	LF
10	Response	:	MA	FC	RA	RA	NR	NR	LRC	CR	LF			
	Exception Response	:	MA	FC +80	EC	LRC	CR	LF						

DD* = (DD DD) times NR (Number of Registers)

7.0 MESSAGE EXAMPLES

All examples are for Transmitter Address = 01 and No Parity.

Ser_4 -> Addr ->	Action	Modbus RTU	Modbus ASCII
		010 001	020 001
Restart Com- munications	Request Response*	010800010000B1CB 010800010000B1CB	:010800010000F6crLf :010800010000F6crLf
Meter Reset	Request Response	01050001FF00DDFA None	:01050001FF00FAcrLf None
Digital Reading ** ***	Request Response	01040003000281CB 010404000009D67C4A	:010400030002F6crLf :010404000009D618crLf
Write Setpoint 1 = +37.00***	Request Response	0110000100020400000E743624 01030400000E74FE74	:0110000100020400000E7466crLf :011000010002ECcrLf
Read Setpoint 1 = +37.00***	Request Response	01030001000295CB 01030400000E74FE74	:010300010002F9crLf :01030400000E7476crLf

* Suggested as first message after power-up. If transmitter is in Listen-Only mode, no response is returned. ** Example while reading +25.18 *** Decimal point is ignored.

8.0 INTERNAL REGISTERS: Please refer to the full Modbus Protocol Communications Manual, which is downloadable from our website.

18. CUSTOM ASCII PROTOCOL TRANSMITTER COMMUNICATIONS

1.0 SERIAL COMMUNICATION FORMAT

Mode Full Duplex (Separate transmit and receive lines) and Half Duplex (RS485 only)
Baud Rate 300, 600, 1200, 2400, 4800, 9600, 19200 selectable with Instrument Setup software.
Parity None
Word length..... 8 data bits
Stop bit 1

The Custom ASCII protocol is simpler than the Modbus protocol. This 5-page manual section provides some of its key programmable features. Our detailed Serial Communications manual can be downloaded from <http://www.laurels.com/downloadfiles/serialcom2.pdf>

2.0 MEASUREMENT DATA FORMAT

The basic measurement data format consists of 8 ASCII characters for analog input “DPM” transmitters, such as +999.99<CR>, where <CR> is the carriage return character. The first character is always a plus or minus sign. A decimal point is always furnished, even when it follows the last digit.

Adding a Line Feed Character to the Basic Format: Printers and other devices that receive the data may require a line feed character <LF> following the <CR>. The line feed character <LF> may be selected using Instrument Setup software.

Adding a Coded Data Character to the Basic Format: A coded character from A to H may be added to the data string according to the table below to indicate the alarm and overload status of the device. If used, this character precedes the <CR>, so that it is the last printable character in the string. With the optional <LF> and coded character selected, the data string will consist of 10 characters for analog input “DPM” transmitters, such as +999.99A<CR><LF>.

Alarm Status	No Overload	Overload
**Neither Alarm set	A	E
Alarm 1 set only	B	F
Alarm 2 set only	C	G
Both Alarms set	D	H

For example, a coded character “G” indicates that Alarm 2 only is set and that the transmitter is in the overload condition. This information is useful when data is supplied to a computer for

listing and analysis, or when data is supplied to a Remote Display in a Master-Slave configuration.

Values are transmitted in a continuous string with no intervening spaces. If the 5th digit in is set to 1 using Instrument Setup software, the termination characters of <CR> and optional <LF> appear after each value. If the 5th digit is set to 0, the termination characters appear only once at the end of the string. In either case, if included, the coded character appears at the end of the last value only.

3.0 NETWORK CONFIGURATIONS

Using the Custom ASCII protocol, TM Series transmitters can operate in a point-to-point mode using RS232 or RS485, or in a multi-point mode using RS485.

The point-to-point mode is a direct connection between a computer (or other digital device) and the transmitter. Any device address can be selected; however, it is suggested that address 1 be selected as a standard for the point-to-point mode.

The multi-point mode is a connection from a host computer to a multiplicity of transmitters bused together with their inputs and outputs connected in parallel. For long cable runs, the last device should have a termination resistor installed. It is necessary to set up each device on the bus with a different address from 1 to 31. To command a particular device, its address is used in conjunction with the command, and only that device responds. The outputs of all of the devices on the bus are set to a high impedance state, except the device being addressed. The device addresses range from 1 to 31, with 0 being a special address to which a meter responds only internally (e.g. Reset), but does not transmit any response on the output lines. All devices may be commanded simultaneously with a 0 address, and there will not be any output response contention. Addressing of transmitters can be set with Instrument Setup software.

4.0 COMMAND MODE OVERVIEW

Using the Custom ASCII protocol, TM Series transmitters operate in the Command Mode only. In this mode, the device does not send data automatically, but responds to commands received from a host computer. These commands can be:

- To transmit the latest or peak measurement
- To reset the meter completely or just the peak value and/or latched alarms
- To display a value sent from the computer
- To transmit present setup parameters
- To receive new setup parameters,
- To monitor or alter data in selected memory locations of the meter.

5.0 COMMAND MODE FORMAT

CHAR 1 - Command Identifier

All commands begin with “*” followed by the meter address, then a command letter followed by a sub-command number or letter. Additional characters may be appended. All commands terminate with <CR> (<LF> ignored).

Char #	Character	Description
1	*	Command Identifier. Recognition Character.
2	0-V	Device Address. 0 addresses all devices, 1-V specific devices.
3	A-Z	Command Function
4	0-U	Sub-command. Number of Bytes of RAM or Words (2 Bytes) of non-volatile memory data being transferred.

CHAR 2 - Address Codes

A Serial Communications Address Code from 1 to V follows the “*” to indicate the device address number from 1 to 31.

Device #	Address Code	Device #	Address Code	Device #	Address Code
1	1	12	C	23	N
2	2	13	D	24	O
3	3	14	E	25	P
4	4	15	F	26	Q
5	5	16	G	27	R
6	6	17	H	28	S
7	7	18	I	29	T
8	8	19	J	30	U
9	9	20	K	31	V
10	A	21	L		
11	B	22	M		

CHARS 3 & 4 - Commands and Subcommands

The examples below use a default address of 1 following the “*”. Substitute the desired address from the above table of Serial Comm Address Codes. All command sequences shown must terminate with <CR>, followed by an optional <LF>.

Request DPM Values

Get reading** *1B1
 Peak reading *1B2
 Valley reading *1B3

** The meter transmits the value or values selected with Instrument Setup software.

Reset Functions, DPM Transmitter

Cold reset	*1C0	Reads NVMEM into RAM locations after RAM is zeroed.
Latched alarms reset	*1C2	
Peak value reset	*1C3	
Remote display reset	*1C4	
Valley reset	*1C9	
Tare function	*1CA	
Tare reset	*1CB	

6.0 READING AND WRITING TO RAM AND NONVOLATILE MEMORY

CHAR 1, 2: The Recognition character and Meter Address Code are the same as shown in previous table.

CHAR 3: Command character:

G	Read bytes from RAM Memory
F	Write bytes to RAM Memory (DPM and Scale meter only)
R	Read bytes from Upper RAM Memory
Q	Write bytes to Upper RAM Memory
X	Read words from Non-Volatile Memory
W	Write words to Non-Volatile Memory

CHAR 4: Command character. Sub-command. Number of Bytes of RAM or Words (2 Bytes) of non-volatile memory data being transferred.

Code #	Number	Code #	Number	Code #	Number
1	1	B	11	L	21
2	2	C	12	M	22
3	3	D	13	N	23
4	4	E	14	O	24
5	5	F	15	P	25
6	6	G	16	Q	26
7	7	H	17	R	27
8	8	I	18	S	28
9	9	J	19	T	29
A	10	K	20	U	30

CHAR 5, 6: See tables for the RAM MEMORY ADDRESSES and NONVOLATILE MEMORY ADDRESSES with their respective data definitions.

General, Reading and Writing Ram Memory Data

RAM memory data is read and written as a continuous string of bytes consisting of 2 hex characters (0-9,A-F) per byte. Included in the command are the total number of bytes to be transferred and the most significant address in RAM of the continuous string of bytes. The format is:

Read lower RAM data	*1Gnaa
Write lower RAM data	*1Fnaa<data>
Read upper RAM data	*1Rnaa
Write upper RAM data	*1Qnaa<data>

where: n is the number of bytes to be read or written.
aa is the most significant address in RAM of the bytes to be read or written.
<data> is n bytes of 2 hex characters per byte in order from the most to the least significant byte.

The number of bytes n consists of a single code character representing values from 1 to 30 as shown above under CHARACTER 4. The most significant address aa consists of 2 hex characters as shown below under RAM MEMORY ADDRESSES AND DATA DEFINITIONS.

General, Reading and Writing Nonvolatile Memory Data

Nonvolatile data is read and written as a continuous string of words consisting of 2 bytes or 4 hex characters (0-9,A-F) per word. Included in the command is the total number of words to be transferred and the most significant address in nonvolatile memory of the continuous string of words. The format is:

Read nonvolatile memory data	*1Xnaa (followed by Meter reset)
Write non-volatile memory data	*1Wnaa <data> (followed by Meter reset)

where: n is the number of words to be read or written.
aa is the most significant address in nonvolatile memory of the words to be read or written.
<data> is n words of 2 bytes or 4 hex characters per word in order from the most to the least significant address.

The coded number of words n consists of a single character representing values from 1 to 30 as shown under CHARACTER 4. The most significant address aa consists of 2 hex characters as shown under NONVOLATILE MEMORY ADDRESSES.

19. SPECIFICATIONS, LTE SERIES PULSE INPUT TRANSMITTERS

Mechanical

Case dimensions.....	120 x 101 x 22.5 mm
Case mounting.....	35 mm DIN rail per EN 50022
Electrical connections.....	Detachable screw plug connectors

Environmental

Operating temperature.....	0°C to 55°C
Storage temperature.....	-40°C to 85°C
Relative humidity.....	95% from 0°C to 40°C, non-condensing

Power & Electrical

Power to Transmitter.....	85-264 Vac or 90-300 Vdc (DC range is not ETL certified) 12-32 Vac or 10-48 Vdc (low voltage power option)
Power Isolation.....	250 Vrms between power, signal input, analog output, relays, and serial I/O

Transmitter Setup

Selection of signal ranges & temperature sensors.....	Jumpers on signal conditioner board
Selection of excitation output & analog output.....	Jumpers on main board
Programming.....	Via PC using Instrument Setup software and Ethernet cable

Analog to Digital Conversion)

Conversion rate.....	60/sec at 60 Hz power, 50/sec at 50 Hz power
Input resolution.....	16 bits (65,536 steps)

Analog Output (standard)

Output Levels.....	4-20 mA, 0-20 mA, 0-10V, -10V to +10V
Compliance at 20 mA.....	10V (0-500 ohm load)
Compliance at 10V.....	2 mA (5 kohm minimum load)
Output Resolution.....	16 bits (65,536 steps)
Output Accuracy.....	±0.02% of FS
Output Update Rate, Max.....	30/sec. Limited by programmable gate time for rate
Output Filtering.....	Digitally programmable

Ethernet I/O (standard)

Serial protocols.....	Modbus (TCP, RTU or ASCII) and Custom ASCII
Serial connector.....	RJ45
Data rates.....	300 to 9600 baud

Transducer Excitation Output (standard)

Output Isolation.....	50 Vdc to meter ground
Selectable levels.....	5 Vdc ± 5%, 100 mA; 10 Vdc ± 5%, 120 mA; 24 Vdc ± 5%, 50 mA

Relay Output (standard)

Relay type Two solid state relays, SPST, normally open, Form A
Load rating 130 mA at 140 Vac or 180 Vdc

DUAL CHANNEL SIGNAL CONDITIONER

Crystal Accuracy at 25°C ±2 ppm
Crystal Tempco ±1 ppm/degree C
Long-Term Drift of Crystal ±5 ppm/year
Signal Types AC, NPN, PNP transistor outputs, contact closures, magnetic pickups
Max Pulse Rate 1 MHz on Channel A, 250 kHz on Channel B
Channel Isolation Channel A & channel B share common ground
Low Pass Filter 250 Hz or 30kHz (selectable)
Hysteresis 15 mV to 2.2 Vp-p (selectable)
Trigger level ±15 mV to ±1.7 V (selectable)
Debounce Circuitry 0, 3, 50 ms (selectable)

V-TO-F PROCESS RECEIVER & TOTALIZER SIGNAL CONDITIONER

Signal Levels 0-1 mA, 4-20 mA, 0-10 V (selectable)
Input Resistance 50Ω for 4-20 mA, 1.00 k Ω for 0-1 mA, 1.01 MΩ for 0-10V
Accuracy at 25°C ±0.01%
Span Tempco ±0.003% of reading /°C
Zero Tempco ±0.003% of full scale /°C

QUADRATURE SIGNAL CONDITIONER

Signal Type Differential or single-ended quadrature
Transitions Monitored x1, x2 or x4
Max Pulse Rate 250 kHz at x1, 125 kHz at x2, 62.5 kHz at x4
Differential High Threshold Voltage +200 mV
Differential Low Threshold Voltage -200 mV
Differential Limits -11V to +14V
Common Mode Voltage for ±200 mV sensitivity ±7V
Single-ended High Voltage 2.5V to 5.5V
Single-ended Low Voltage -1V to +1V
Input resistance, Typ. 17 kOhm
Conversion Technique for Rate 1/period
Conversion Time for Rate Programmed gate time + 30 ms + 0-2 signal periods
Time Before Zero Output for Rate 0 to 199.99 sec (selectable)
Zero Wait Time for Rate 0 to 199.99 sec (selectable)
Output Update for Rate Same as conversion rate
Output Update for Total 30 ms
Time Base Accuracy for Rate Calibrated to ±2 ppm

20. WARRANTY

Laurel Electronics Inc. warrants its products against defects in materials or workmanship for a period of one year from the date of purchase.

In the event of a defect during the warranty period, the defective unit may be returned to the seller, which may be Laurel or a Laurel distributor. The seller may then repair or replace the defective unit at its option. In the event of such a return, freight charges from the buyer shall be paid by the buyer, and freight charges from the seller shall be paid by the seller.

LIMITATION OF WARRANTY

The foregoing warranty shall not apply to defects resulting from:

1. Improper installation or miswiring.
2. Improper or inadequate maintenance.
3. Unauthorized modification or misuse.
4. Operation outside the environmental specifications.
5. Mishandling or abuse.

The warranty set forth above is exclusive and no other warranty, whether written or oral, is expressed or implied. Laurel specifically disclaims implied warranties of merchantability and fitness for a particular purpose.

Any electronic product may fail or malfunction over time. To minimize risks associated with reliance on Laurel products, users are expected to provide adequate system-level design and operating safeguards. Laurel's products are intended for general purpose industrial or laboratory use. They are not intended nor certified for use in life-critical medical, nuclear, or aerospace applications, or for use in hazardous locations.

EXCLUSIVE REMEDIES

The remedies provided herein are Buyer's sole and exclusive remedies. In no event shall Laurel be liable for direct, indirect, incidental or consequential damages (including loss of profits) whether based on contract, tort, or any other legal theory.