

# Installation and Technical Manual

## Pressure Governor

### for Electronic Engines

#### V6.0

### Contents

#### Operation Section

Overview .....	2-3
v6.0 Features .....	4
Operation .....	5-8

#### Troubleshooting / Diagnostics

Diagnostics .....	9-17
Self Test .....	18

#### Installation / Wiring

Installation .....	19
-4 & -12 Connector .....	20
PSI Transducer .....	21
Wiring .....	22-23
ISC Wiring .....	24
ISM Wiring .....	25
CAT Wiring .....	26
Navistar Wiring .....	27
DDEC Wiring .....	28
Mack Wiring .....	29
MBE900 Wiring .....	30
Engine ECM .....	31
Preset Programming .....	32
Engine Type Programming .....	33
Parameter Programming .....	34
Miscellaneous .....	35
Notes .....	36

# Overview

## Electronic Engine Pressure Governor

The Class1 Pressure Governor is designed to maintain a selected pump pressure or engine speed setting. This unit will work with electronically controlled engines that accept a variable analog voltage signal (0-5 VDC) or a Pulse Width Modulated Signal (PWM 12%-87% at 400 Hz) as a remote accelerator (throttle) signal.

**Included in the package** The standard governor control is shipped with the following components.

	Package 105244	Package 105246
Governor Control	C1-PN 107396	107269
Pressure Transducer	C1-PN 100581	100581
User Manual	C1-PN 107490	107490
Installation Harness	C1-PN 105247	Not Included

### Modes of Operation

**Power On** When the unit is first powered up, the display will show [MODE] and the engine will remain at idle until the mode switch is pressed to select the desired operating mode (**PSI MODE** or **RPM MODE**).

There is an internal relay that should be used to turn on the remote throttle at the engine ECU. This relay will not energize until the MODE switch is pressed and a valid throttle ready input is present at Pin 2 of the 12 pin connector. If the pump is engaged and the OK to Pump LED is illuminated, PRESSURE will be the first mode selected otherwise Throttle will be the first mode.

**RPM Mode** When the unit is in RPM mode, the display will read “**THROTTLE**” and the green RPM LED will be illuminated. Engine speed is controlled by the **INCREASE** and **DECREASE** switches, the display will indicate “**INCREASE**” or “**DECREASE**” as appropriate when these switches are depressed. The governor will maintain the last output signal attained with these switches. The engine will maintain an RPM appropriate for the throttle signal being sent.

**NOTE: IF WHILE OPERATING IN RPM MODE THE PRESSURE INCREASES MORE THAN 50 PSI FROM THE PRESSURE LOGGED AT THE LAST SWITCH PRESS, THE GOVERNOR WILL LIMIT THE PRESSURE INCREASE TO NO MORE THAN A 50 PSI DIFFERENTIAL. THE GOVERNOR MAY REDUCE ENGINE RPM TO ACHIEVE THIS AND THE MESSAGE PSI LIMIT WILL BE DISPLAYED IN THE MESSAGE CENTER.**

**NOTE: THE GOVERNOR WILL NOT ATTEMPT TO REGULATE PRESSURE IN THIS MODE, ONLY LIMIT THE DIFFERENTIAL PRESSURE TO 50 PSI FROM THE PRESSURE PRESENT WHEN THE LAST SWITCH WAS PRESSED.**

**Pressure Mode** When the unit is operating in the Pressure mode, the display will show “**PRESSURE**” and the amber PRESSURE LED will be illuminated. Pump pressure is set by using the **INCREASE** and **DECREASE** switches. The governor will attempt to maintain the last pressure achieved with these switches. The display will indicate “**INCREASE**” or “**DECREASE**” as appropriate. The governor maintains pump pressure by controlling engine RPM in response to a signal from the pressure transducer mounted on the pump. When controlling in this manner, the display will show **CTRL DEC** or **CTRL INC**.

**Switching between modes** Pressing the mode switch will change the governor from RPM to Pressure mode without a significant change in engine speed or pump pressure. The message center will indicate “**PRESSURE**” or “**THROTTLE**” as appropriate once the mode change has been made. When switching to PRESSURE, the pressure setpoint is whatever pressure is on the transducer at the change.

## Preset Mode

Pressing the **PRESET** switch in either mode will control the engine to attain the preset RPM or pump pressure programmed in governor memory. If there is more than 10 PSI pressure on the pump, the RPM Preset is disabled and the Message Center will display **DISABLED**.

## High Idle Mode

An input is available to bring the engine speed to a PRESET RPM (High Idle) from a remotely mounted switch. While operating in this mode, the display will show **HIGHIDLE**. This function is inoperative when the pump engaged input is active, there is more than 10 PSI on the pressure transducer or if the MODE switch on the governor has been pressed. Pressing the **IDLE** switch causes the high idle to drop out and the high idle input must be toggled off and then on again to reinstate high idle. The **INC** and **DEC** switches are active in high idle mode and the engine speed can be adjusted, changing engine speed in this manner will not change the preset RPM that is set in memory.

**Idle Mode** Pressing the **IDLE** switch at any time returns the engine to idle speed.

**NOTE: A FIRM, POSITIVE SWITCH DEPRESSION IS NECESSARY TO ACTIVATE THIS FEATURE AND A QUICK PRESS MIGHT BE IGNORED.**

## SENSOR



Whenever the transducer signal is below 0.3 VDC or above 4.8 VDC, a sensor fault will be logged and **SENSOR** will be displayed in the message center. (**SENSOR** will flash if the failure occurs while operating in PSI Mode) Once a failure is detected, the governor can no longer maintain a pressure setting. It will hold the current engine RPM and only operate as a throttle.

Once the **SENSOR** message is displayed, it will not clear until power to the governor is reset. It is extremely important that the cause for this message is investigated.

The governor **cannot** control discharge pressure properly unless the sensor signal is reliable and correct.

## Switch Session Pressure Increase

If the **INC** switch is held the governor will not allow a change greater than **80 PSI** without releasing the **INC** switch and pressing it again. This is only applicable when the discharge pressure is above **90 PSI**. This function prevents high pressures from being introduced by a distracted operator.

## Pressure / Water Loss

If the discharge pressure drops below **30 PSI** for any reason, engine speed will not be increased. The governor output voltage will reduce to the last known value (engine RPM) where the pressure setpoint was obtained. The display will flash **-INTAKE-** during this low pressure condition. If the pressure increases above 30 PSI, **OPERATOR** will flash and the governor will not increase output unless the operator presses the **INC** or **PRESET** switches. If pressure above **30 PSI** is not regained within **5 seconds**, the governor will return the engine to idle and display **LoSupply**. The operator must make certain that the water supply is adequate and then reinstate governing using the **MODE**, **INC** and/or **PRESET** switches.

## Pressure Recovery / Cavitation (TRIM)

The governor has a trim adjustment, this can be set between 5% and 20% of maximum throttle. This parameter limits the governor's maximum increase in a pressure recovery attempt. The message center will flash **OPERATOR** when this limit is reached and the RPM will not increase further. The operator must take positive action to restore discharge pressure. If pressure is not restored within 4 seconds, the governor will reduce output to the last known output where pressure was maintained. The operator must input a new setpoint with the **INC/DEC** or **PRESET** switches. If the pressure rises above the original setpoint and the governor controls a decrease in engine speed, the governor will return to normal operation and **PSI MODE** is displayed.

# v60 Features

## Version Display

While the governor is at idle and **[MODE]** is being displayed, if the **IDLE** switch is depressed for 7 seconds, the message center will scroll through the version number, governor settings and I/O voltage. When the sequence is complete, the display will return to **[MODE]** and normal operation is available.

## PSI Enable

The pressure governor will not control pressure until a discharge pressure of **70 PSI** is attained. It will act as a throttle until this pressure point is achieved.

## Setting PRESET

If the **PRESET** switch is held down for 10 seconds after a Power On Cycle (before pressing any other switch), the governor will enter the PRESET programming mode.

## Selecting Engine Type

Only the **INC** and **PRESET** switches are active in the engine selection menu. Selecting the engine type is only necessary at first power on of a new governor.

## RPM Preset Disable

If there is pressure on the pump transducer or the Pump Engaged Interlock is active, RPM Preset is disabled and a **DISABLED** message will be displayed in the Message Center.

## Pressure Preset

While the governor is attempting to reach the preset PSI, the increase is tested at intervals and if the pressure is not increasing, the governor will maintain the engine speed at the point the pressure stops increasing and uses that as the pressure setpoint.

## High Idle

The High Idle feature is disabled if there is **> 10 PSI** at the pump transducer.

## Switch Session Pressure

If the **INC** switch is held and the operating pressure is above **90 PSI**, the governor will not allow a change greater than **80 PSI** without releasing the **INC** switch and pressing it again. This is to prevent high pressures from being introduced by a distracted operator.

## New Messages

**OPERATOR** will be flash anytime the governor can't achieve a desired pressure.

This indicates that the governor will not increase engine speed until the pump operator intervenes.

**-INTAKE-** will be displayed anytime the governor is operating in pressure mode and the discharge pressure drops below **30 PSI**. If pressure remains below **30 PSI**, the display will change to **LoSupply** and engine speed will be reduced to idle. When **LoSupply** is displayed the governor is no longer active and the operator must ensure an adequate water supply and reinstate governing using the **MODE** Switch and either **INC** or **PRESET**.

**OPERATOR** will be flashed anytime the governor can't achieve a function or pressure.

This indicates that the governor will not increase engine speed until the pump operator intervenes.

**CTRL INC** will be flash in the display if the governor cannot regain the set pressure. It will change to **OPERATOR** flashing if pressure cannot be regained within 4 seconds.

During these periods, the governor will not command an increase in engine speed and will return to the last known engine speed command where the setpoint was achieved.

# Operation

When the governor is initially powered up, neither the RPM nor the PRESSURE LED will be illuminated. If the IDLE Switch is held on prior to power being applied, the information will remain in the message center as long the IDLE Switch is depressed.

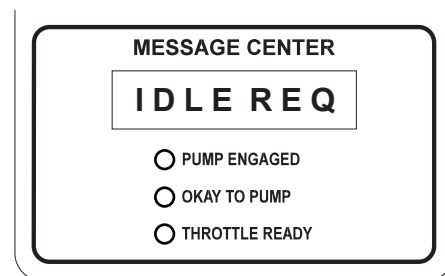

At this point, the operator must select an operating mode with the MODE switch before the governor will operate.

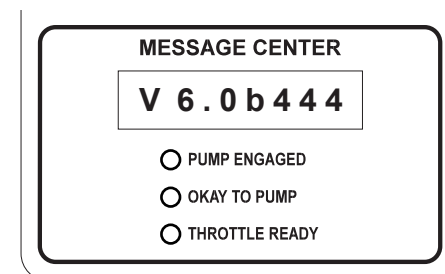

The governor will check for a valid pressure transducer signal at power up, if none is found **SENSOR** will be displayed in the message center. The governor will operate, but will not be able to maintain a pump pressure.

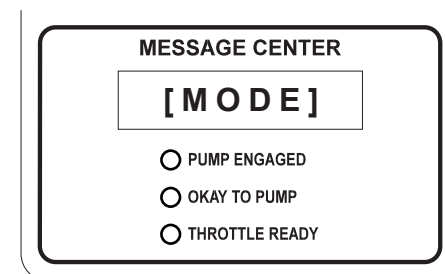

If no interlocks are established, **NO-INTLK** will be displayed in the message center when the MODE switch is pressed and the governor will not respond to an increase or decrease request.

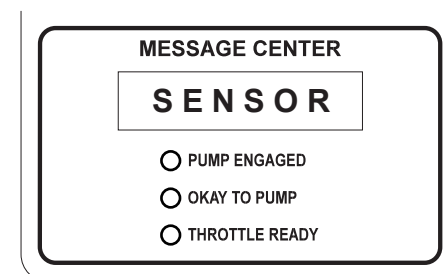

If only the OEM throttle interlock is active, you may select RPM mode and **RPM** will be displayed.

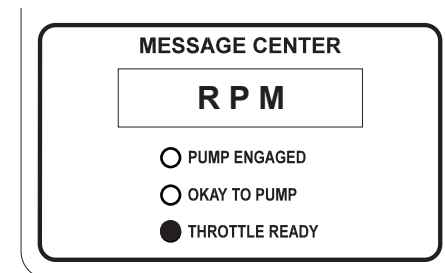
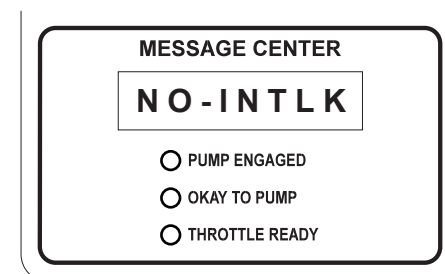

# Operation

If you attempt to select pressure mode, **NO-INTLK** will be displayed when the MODE switch is pressed and the governor will revert to RPM mode and **RPM** will be displayed.

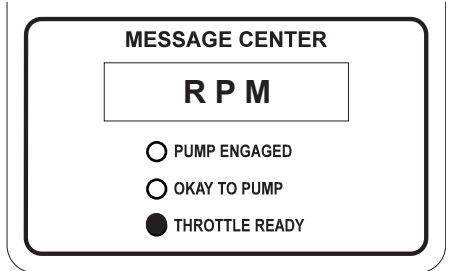
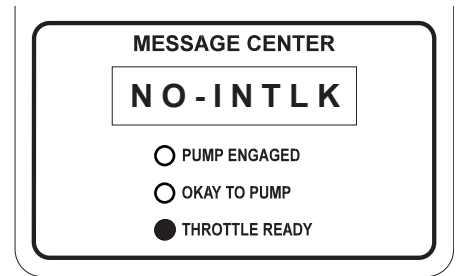

The governor will respond to increase and decrease commands from the INC and DEC switches within the operating capabilities of the engine. When the INC switch is pressed, **INCREASE** is displayed in the message center.

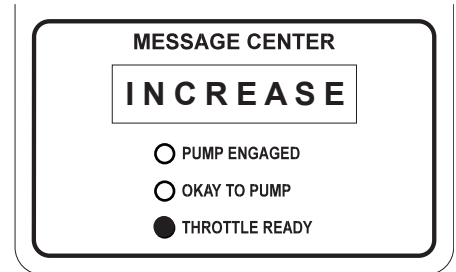

When the DEC switch is pressed, **DECREASE** is displayed.

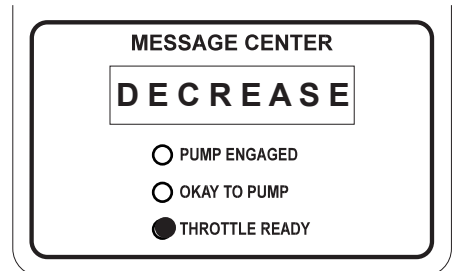

Each time the INC or DEC switch is released, the current engine RPM is maintained by the governor and the message center will display **RPM** to indicate that the governor is active and which mode it is operating in.

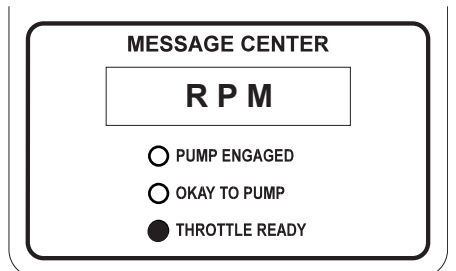

When the PTO Engaged Interlock is active, pressure mode can be selected and governor operation is identical to RPM mode except that **PSI** is displayed instead of **RPM** and the PRES-SURE LED will be illuminated.

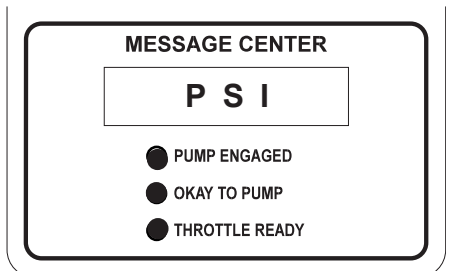

# Operation

Whenever you desire to return to idle, press the IDLE switch with a firm positive switch depression. The message center will display **IDLE REQ** and the engine speed will be reduced to normal idle. This clears the governor of any pressure or RPM set points and **[MODE]** will be displayed in the message center.

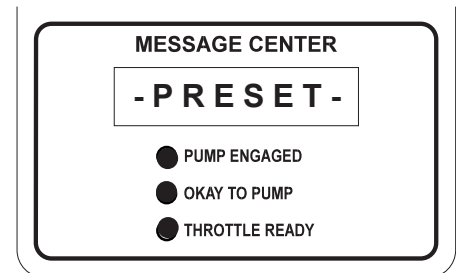
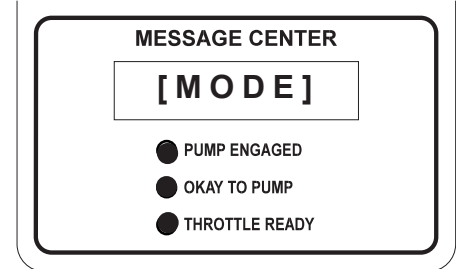
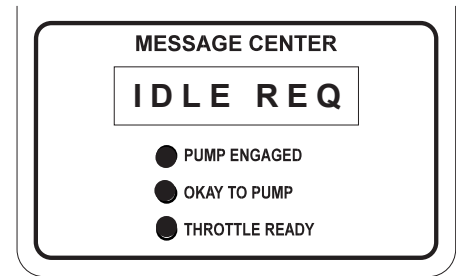

The PRESET switch can be used anytime after an operating mode has been chosen to promptly bring the engine or pump to the preset point.

The message center will display **-PRESET-** while the engine is being adjusted and then either **RPM** or **PSI** will be displayed dependent on the operating mode selected.

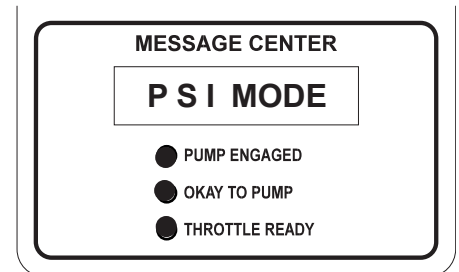
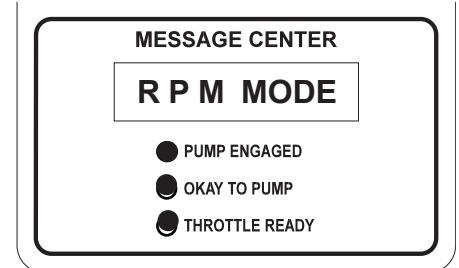

While the governor is powered up and the OEM Throttle Interlock is active, a remote High Idle function is available. A 12 volt input is available to activate this feature.

This feature will not activate if a governing mode has been selected, the pump engaged interlock is active or the throttle interlock is lost. If the High Idle is active, it will drop out if the pump is engaged or the throttle interlock is lost. While the high idle feature is active, **HighIdle** will be displayed in the message center. The INC and DEC switches are active in the High Idle Mode.

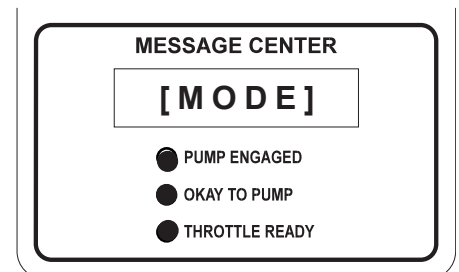

# Operation

When operating in pressure mode, once the pump pressure exceeds 70 PSI, the governor will monitor the pump discharge pressure and respond to changes in pressure by modulating engine/pump speed.

If the discharge pressure drops and the governor is unable to regain pressure within 4 seconds, the Message Center will flash -INTAKE- to indicate an insufficient water supply the governor will then reduce speed to the point that the pressure was last achieved. At this time the Message Center will display OPERATOR and will no longer attempt to automatically regulate a decrease in pressure until the pump operator presses the DEC, INC or PRESET switches. ***The governor will respond to an increase in pressure if it occurs.***

If the pump discharge pressure drops below 30 PSI for more than 5 seconds, the governor will return the engine to idle.

**LOSUPPLY** will be displayed in the message center. The governor enters its initial power up state and a mode must be selected to enable governing again.

**NOTE:** While the governor is determining cavitation, the discharge pressure drop will be treated normally. That is, the engine will be commanded to increase speed to compensate for the pressure reduction within the Trim Limit. ***This could result in the engine running at a speed that can cause a pressure “spike”.***

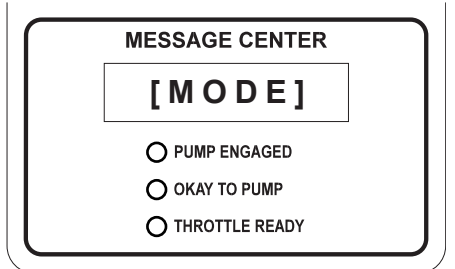
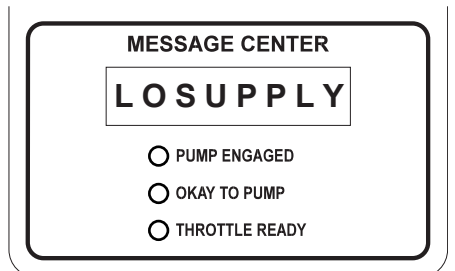
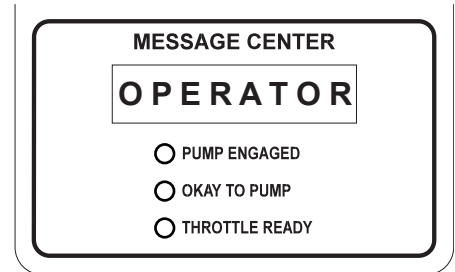
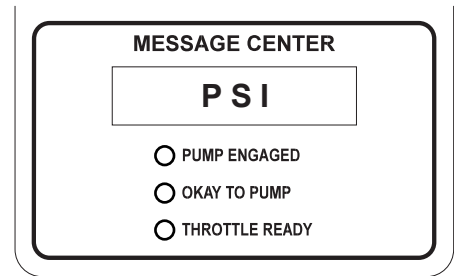



# Diagnostics

## Class1 Uni-Governor Quick Tests

### Operation description:

The governor is simply a Throttle Position Sensor (TPS) for the Engine Control Module (ECM). It sends a varying voltage signal, or for Caterpillar Engines (CAT) a Pulse Width Modulated (PWM) signal to the ECM at the remote throttle signal input. When operating in pressure (PSI) mode, the governor modulates the output signal to maintain a specific input voltage from its pressure transducer. This voltage is “set” into the governor’s memory by the use of the INC and DEC switches. A PRESET function is available that causes the governor to attain either a specific pre-programmed voltage or pressure. For Cummins, CAT and Navistar engines, once the ECM is programmed for remote throttle, the ECM continuously looks for the signal. If it is not present, the ECM will record a fault and illuminate the CEL or SEL dependent on the ECM. This is a quick check to see if a valid signal is present at the ECM. If there is no Check Engine Light (CEL) or Stop Engine Light (SEL), then a valid signal from the governor is present.

For most engines the remote throttle must be ‘turned on’ in the ECM to use the remote throttle signal. For Cummins and CAT, this is performed by grounding a terminal at the ECM. Navistar ECM’s use switched voltage.

The governor will not operate in any mode unless 12 VDC is applied at terminal 2 of the 12 pin connector (THROTTLE READY Interlock). This is evidenced by the illumination of the THROTTLE READY LED. This will allow the governor to operate in RPM mode. 12 VDC applied to pin 10 of the 12 pin connector (PUMP ENGAGED Interlock) illuminates the PUMP Engaged LED. If both the THROTTLE READY and PUMP ENGAGED LED’s are lit, then the governor will illuminate the OKAY TO PUMP LED and the governor will operate in either PRESSURE (PSI) or THROTTLE (RPM) mode.

**note:** The THROTTLE READY and PUMP ENGAGED LED’s will illuminate if the governor has a ground and the inputs are active (12 VDC). This is not dependent on the governor functioning or even having power applied. The OKAY TO PUMP LED is turned on by governor software and usually indicates that the governor is operational.

### Preliminary Diagnostic information:

To assist in governor diagnostics there is some preliminary information necessary. When power is first applied to the governor, a set of characters is displayed. These are referred to as the ‘V’ number. On governors produced after January 2001, if the IDLE switch is held when power is applied, the ‘V’ number will continue to be displayed until the IDLE switch is released. A typical number will look like the following: V3.7b444. This contains the software version number, the engine type programmed into the governor and the parameter settings.

The other information necessary is a brief but accurate description of the problem trying to be resolved. What are you trying to correct? Provide a brief description of the operational anomaly.

---

---

---

[See page 3](#) for a diagnostic guide relating to this problem

## Passwords:

There are several diagnostic modes available in the governor. Access is provided by entering a password that uses the INC and IDLE switches in a specific sequence.

The Message Center must display **[MODE]** prior to entering any password.

## Governor Self Test:

The Self Test password is:

**IDLE INC IDLE INC IDLE INC IDLE INC**

This test is capable of determining if there is a problem with the governor that replacement of the governor display will correct.

Results are displayed in the Message Center as a numeral matching its position in the display.

The Message Center (Test) positions are numbered left to right as follows:

**0 1 2 3 4 5 6 7**

When the self test starts, the governor checks for the type of output signal present, analog (ANA) or pulse width modulated (PWM). This is displayed along with the output voltage range if the signal is analog (Make note of this range. It should vary from ~0.7 to 4.0 VDC). Once this output test is complete the Message Center will display a results screen. Any X indicates that a particular function has not been tested.

The Message Center will display X X X 3 - 5 X X for analog or X X X - 4 5 X X for PWM.

Either a '3 -' or a '- 4' are in the 3 and 4 positions dependent on whether the governor is configured for Analog or PWM output. The 5 in position 5 indicates that the pressure transducer is transmitting a no pressure signal (expected).

If the pump is engaged, an H (high) will be shown. If the signal is too low, an F (fail) will be displayed.

- 0** The input to terminal 2 Throttle Ready changed  
Release the Park Brake or shift the Transmission to change the interlock
- 1** The input to terminal 10 Pump Engaged changed  
Shift the Pump
- 2** Each of the switches on the governor have been pressed  
The switch pressed will be displayed i-IDLE p-PRESET m-MODE u-INC d-DEC
- 3** Analog Output, a (-) will be in position 4
- 4** PWM Output, a (-) will be in position 3
- 5** Transducer voltage is between 0.3 and 0.9  
an (H indicates voltage > 1.0) (F indicates voltage < 0.3)
- 6** The High Idle Input (terminal 3) has been toggled  
Toggle the High Idle switch ON and then OFF if equipped
- 7** The internal relay has been activated

**NOTE:** THIS CHECK DOES NOT TEST FOR THE VALIDITY OF THE SIGNAL IN NOR IF THE SIGNAL IS TRULY SENT TO THE ECM. THAT TEST MUST BE DONE MANUALLY IF IT IS THOUGHT THAT THE REMOTE PTO ON SIGNAL THROUGH THE GOVERNOR IS THE PROBLEM.

## Contents Page

### Problem specific tests:

- 1 **Governor does not power up**, Message Center is blank  
THROTTLE READY led and/or PUMP ENGAGED LEDs may be illuminated.
- 2 **No throttle response**  
Governor will not change engine RPM or pump pressure
- 3 **Governor displays SENSOR**
- 4 **Governor changes engine RPM but will oscillate when in RPM mode**
- 5 Governor changes engine RPM, **Engine searches or hunts (oscillates) in pressure mode**
- 6 Governor overshoots the **PRESET PSI** and **then oscillates with increasingly wider swings**
- 7 **Governor does not respond fast enough** to a discharge opening or closing (sluggish)
- 8 RPM PRESET, PSI **PRESET** or both not working
- 9 **One or more switches are inoperative**
- 10 **Fast Idle does not work**
- 11 **Pressure Spikes**
- 12 **Control does not return to Cab Throttle** when finished pumping
- 13 **Message Center display garbled or dim**
- 14 **CAVITATE is displayed in the Message Center**
- 15 **PUMP ENGAGED/THROTTLE READY LED's inoperative**

## 1 Governor does not power up, Message Center is blank

Check for power at pin 1 of the 4 pin connector and ground at pin 2 with a voltmeter across pin 1 (red lead, power) and pin 2 (black lead, ground).

Check that the terminals are fully inserted into the connector, the orange wedge lock is inserted properly and the weather seal is in place and not distorted.

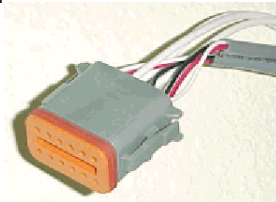

If Power and Ground are present and the governor Message Center is still blank then the problem is internal and the governor should be replaced.

If either power or ground is missing, then the problem is in the vehicle wiring and that should be investigated. (contact OEM if necessary).

**Replacing the governor will not rectify this situation.**

## 2 Governor will not change engine RPM or pump pressure

The THROTTLE READY Interlock must be present. A visual determination can be made by observing the THROTTLE READY LED. If it isn't on then check for a 12 V interlock to pin 2 of the governor's 12 pin connector. This is an OEM function and must be present for the governor to operate.

If 12 VDC is not present at the wire installed at pin 2, then the governor is not the problem.

Contact the OEM for further assistance.

A MODE must be selected before the governor will control the engine. Make sure that either the RPM or PRESSURE LED is illuminated and the Message Center indicates THROTTLE or PRESSURE.

The output signal will not change if a mode is not selected. Output will remain at hardware idle (approx. 0.7 VDC or 12% PWM). Once a mode is selected, the governor idle output will increase to the appropriate software idle signal.

To monitor the governor output voltage, an internal voltmeter is included.

With [MODE] showing in the display, enter the following Password:

**INC IDLE IDLE IDLE IDLE IDLE INC**

The Message Center becomes an output voltmeter

**OUT=x.xV**

The output voltage can be monitored to ensure that it increases and decreases with the INC and DEC switches.

Check that the remote throttle switch is active at the ECM. Use a meter or diagnostic reader (DDR).

Most engines require this input before they will utilize a remote throttle signal.

The governor may or may not be used to satisfy this requirement. The OEM is best able to answer this question. If the governor is being used, then the signal should be at pin 11 and the output to the engine found at pin 12 **after** a MODE is selected. Check that the relay is switching and that terminal 11 and 12 of the 12 pin connector have continuity. If a mode can be selected, the governor output is changing, and the relay closes then the governor is not the problem.

Contact the OEM for further assistance.

### 3 Governor Message Center displays SENSOR

The governor will display SENSOR whenever the transducer input is less than 0.3 VDC. This input is at pin 7 of the governor 12 pin connector. You can measure this voltage in either of two ways. A voltmeter back probing pin 7 or on the governor Message Center.

Enter the password:

**INC IDLE IDLE IDLE IDLE IDLE INC IDLE**

The message center will display **XDC=x.xV** where x.x is the voltage to one decimal place that is read at pin 7.

There are 2 main requirements for the transducer to operate correctly.

1. Five volts supplied from the governor at pin 6 to the transducer pin B.
2. Ground supplied from the governor at pin 5 to the transducer pin A.

If either of these are missing, check the output at the governor and if present, check the wiring.

If both are present at the transducer, then with power on and the connector installed, back probe terminal C of the transducer and check for 0.7 VDC. This is the zero pressure output of the transducer +/- 0.1 VDC. If present, check the signal wire to the governor.

Note: There have been many cases of moisture and corrosion in the transducer connections causing problems. Use a bright light and inspect the transducer and connector for visible moisture, corrosion and/or mineral deposits. If present, this might be the reason for the SENSOR reading. There is a removable seal on the round section of the transducer connector, ensure that it is still present. Check under the wire weather seal for corrosion and moisture as well. If moisture or corrosion is present, clean the contacts (the use of a moisture displacing chemical is recommended (WD40, CRC 5-56, etc.) and check for signal voltage again.

Once SENSOR is displayed, the SENSOR message will not clear until power to the governor is removed and reapplied even if the error is corrected.

**DIELECTRIC GREASE CAN BE ADDED TO THE SEALING SURFACE TO ENSURE A BETTER MOISTURE BARRIER.**

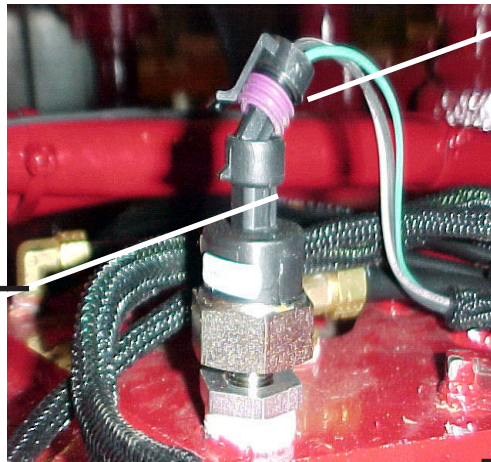

**REMOVABLE SEAL**

**CHECK THAT THE HARNESS ISN'T PULLED TO ONE SIDE DISTORTING THE WIRE WEATHER SEAL. THIS IS ANOTHER SOURCE OF MOISTURE INTRUSION.**

### 4 Governor changes engine RPM but will oscillate when in RPM mode

This is usually attributable to the governor sending out a PWM signal when the engine requires an analog signal. Check the V number for an 'a' or an 'F'. An F indicates the governor is programmed for CAT and an 'a' shows that there is a 12 VDC input on terminal 4 of the 12 pin connector. If this is not the case then a poor ground at pin 9 or a fluctuating 5 volt supply at pin 1 needs to be investigated.

## 5 Governor changes engine RPM but will search or hunt (oscillate) when in pressure mode

There are three programmable parameters that can fine tune governor operation. These are RAMP, GAIN and SENSITIVITY.

To enter the Menu System:

With [MODE] showing in the Message Center,

Press and hold the IDLE and PRESET switches. While still holding these, press MODE. This puts you into the MENU system where the RAMP, GAIN and SENS settings can be changed. Scroll through the 3 parameters using the MODE switch. Use the INC or DEC switch to enter that parameter and change the values. Press PRESET before scrolling to the next parameter.

The governor is shipped from Class1 with all 3 set to 5.

### Rate

This parameter controls how much voltage increase or decrease occurs with each press of the INC or DEC switch. The nominal value of 5 will work on every engine and normally doesn't need to be changed.

### GAIN

This parameter controls how fast the voltage will change automatically in response to a pressure change or when using the PRESET switch. The lower the value, the slower the response. A value of 5 on some engine-pump combinations will exacerbate the hunt condition.

(The governor is commanding changes faster than the apparatus can follow)

Try a value of 4 first and don't change any other setting. If this slows the oscillations but they are still present, then change the SENSitivity setting (described below). The effect of decreasing the GAIN is to slow down the governor reaction to change. If it becomes too slow, then the governor will not be able to decrease RPM fast enough when a discharge is closed. Usually 4 is slow enough but in extreme cases a 3 might be necessary. Do not go to 3 until you have tried a sensitivity change first.

### SENS-itivity

This parameter controls how much pressure deviation is allowed before the governor responds.

A setting of 5 allows approximately 5 PSI swings before the governor attempts to restore the set pressure. The higher the number, the "looser" the "window". After setting the GAIN to a 4, set the SENS to 6 if necessary. Normally this value should never be higher than 7. A setting of 10 allows up to 30 PSI swings.

Randomly changing values can be counterproductive. Lower the GAIN first, try it and then the SENS and back to GAIN if necessary. Change by a value of 1 only. If you go too far, it might solve the oscillation problem but create a response problem. There is no magic set of numbers that will optimize your installation. Each installation is unique to Engine Torque, Transmission Gearing, Transfer Gear ratio and pump capacity and design. The parameters are used to match the governor to the apparatus.

A note about two-stage pumps:

In pressure mode, engine RPM is relatively low compared to a single stage pump or the two-stage in volume mode. This places the engine outside of its optimal torque range and small changes in RPM equate to substantial changes in pressure. This can create two problems.

1 The engine is slow to respond to commands and the governor starts a lead lag situation that can result in oscillations. The setup cannot be "tweaked" for best performance in both volume and pressure.

2 Snapping a nozzle closed will result in a pressure "spike" that is too fast to be controlled by a governor or a discharge relief valve. This could also result in an uncontrollable oscillation.

Discretion should be used whenever operating in Pressure Mode, this mode allows for governor operation in which the governor and engine have the least ability to compensate for pressure changes.

## 6 Governor overshoots the PRESET PSI and then oscillates with increasingly wider swings

This can be caused by GAIN being set too high or SENSitivity set too low. In a few cases, the PRESET is just set too high. PRESET is intended to allow very fast initial response to get up and pumping and a normal setting would be around 125 PSI. Once the apparatus is pumping water, the pressure setpoint should be manually invoked with the INC or DEC switches. A two stage pump in pressure mode and a PRESET PSI of 150 PSI or greater could easily result in oscillations.

Check the GAIN and SENS settings. A lower GAIN will have the biggest impact on this condition. Do not compensate for operating procedures that can create problems by substituting less than optimum governor operation.

## 7 Governor does not respond fast enough to a discharge opening or closing (sluggish)

This is normally the result of the GAIN being set too low. Check the GAIN setting and if less than 4, change it to a 4 and reevaluate operation. In a rare case, it could be caused by the SENS being set to 7 or greater. Check this and bring it back to a 6 or 7 if necessary. Potentially, this could be caused by torque loading of the engine being excessive and the apparatus does not have enough “muscle” to adequately control the pump. If after setting the governor parameters to the best values for response, try a different pump loading scenario to evaluate power-train efficiency.

## 8 RPM PRESET, PSI PRESET or both not working

The governor must have 12 VDC on pin 2 to operate in RPM mode and THROTTLE MODE must be selected.

If the RPM PRESET doesn't work, then verify that there is an RPM PRESET. Enter the Password: **INC IDLE IDLE INC IDLE INC IDLE INC** This will place the governor in it's view settings mode. The parameter settings will be shown RAMP GAIN SENS is the sequence displayed as X X X.

This will be followed by the Idle CNTS and then the Pressure Preset PXXX and this is followed by the RPM preset as a CNT value.

The RPM Preset CNT should be higher than the Idle CNT value by at least 15.

The CNT value is the number of steps on the digital potentiometer used by the governor. low CNTS=low output and high CNTS=high output. Operational CNTS can be viewed using the Password

**INC IDLE IDLE INC IDLE INC IDLE IDLE**

The values seen can be used to identify how many counts relate to engine RPM values.

If the governor works in THROTTLE mode, then the RPM PRESET should work. It is most likely that the RPM PRESET is not set.

To set PRESET values, enter the following Password:

**INC IDLE IDLE INC IDLE INC INC IDLE**

The Message Center should display PRESET, select a mode with the MODE switch. You must view the RPM/PRESSURE LED's to know which mode you are operating in. Use the INC/DEC switches to attain the RPM or Pressure you want as a PRESET and then press the PRESET switch to store the value. Select the other MODE if desired, adjust the setpoint and then store that value with the PRESET switch. You must then press the IDLE switch to save these settings to memory and exit the PRESET mode.

If the PSI PRESET does not work, it will be most likely because the transducer signal is not changing. Operate the apparatus with the pump engaged and water available. Enter one of the following two passwords dependent on which is easier for you to correlate to operating conditions.

**INC IDLE IDLE IDLE IDLE IDLE INC IDLE** places you in the transducer voltmeter mode. The voltage should increase with pressure.

**INC IDLE IDLE INC IDLE IDLE INC INC** places you in the PSI display mode. The pressure displayed should be reasonably close to the master discharge Gauge reading. (+- 25 PSI)

If the values appear not to change with pressure then you will have to diagnose the transducer system. see [Section Three \(3\)](#).

## 9 One or more switches are inoperative

This condition can be diagnosed with the self test **IDLE INC IDLE INC IDLE INC IDLE INC**

If you cannot enter the selftest, then one of the switches is shorted to ground and the governor must be replaced. If you can enter the selftest, when the Message Center displays X X X 3 - 5 X X Each time you press a switch a letter will be displayed in position 2, just before the 3.

i=IDLE

p=PRESET

u=INC (i is used for idle)

d=DEC

m=MODE

If there is a letter constantly displayed in position 2 then that switch is shorted and the governor should be replaced. If one of the switches does not display it's letter, then that is the switch that is bad and again the governor should be replaced. If all of the switches display, then the governor is OK and one of the functions is not set properly. PRESET would be the most likely one, however if the governor is configured for the wrong engine type it could show up as the INC switch not seeming to operate.

note: The IDLE switch has a longer 'debounce' time than the rest. It must be held for a half second to adequately be read. This is to prevent an accidental drop to idle when operating.

## 10 Fast Idle does not work

An RPM PRESET must be configured. [Refer to section 8](#)

12 VDC must be present on pin 2 (Throttle Ready)

12 VDC must **NOT** be present on pin 10 (Pump Engaged)

12 VDC must be actively toggled at pin 3 once the governor has been powered on. If it is present at governor power on, it will be ignored until it is turned off and then back on. Automatic Fast Idle activation can cause this to occur.

## 11 Pressure Spikes

This can usually be traced to the **GAIN** setting. Set GAIN to a higher number if it is at 3 or below. The other possibility is that the discharge is being closed too fast. The governor can maintain pressure within 30 PSI as long as the change is not faster than 3 seconds. The governor can actually manage faster changes than this, but the NFPA specification is 3-10 seconds. The governor operates best in this range.

Snapping a nozzle closed could result in a pressure spike that the governor cannot handle fast enough to protect other Firefighters.

## 12 Control does not return to Cab Throttle when finished pumping

This condition is the result of the PTO ON switch not being released. The governor drops out its internal relay whenever the IDLE switch is pressed. (The governor has no Mode selected.) This can be tested with a voltmeter at terminals 11 and 12 of the governor 12 pin connector. The PTO ON switch can be tested at the engine ECM or with a Diagnostic Data Reader (DDR) with the appropriate software. The governor is not necessarily used to control the PTO ON switch.

**Consult your OEM for additional trouble shooting assistance in this area.**



### **13 Message Center display garbled or dim**

This is an internal component of the governor and there is no field repair to correct a dim display. The governor should be replaced.

Contact Class1 at **1 800 533 3569**

### **14 CAVITATE is displayed in the Message Center**

This indicates that the governor has performed a cavitation check and the transducer signal remained below 25 psi for at least 5 seconds. If the apparatus was run away from water then this is the case. If not, the [transducer circuit](#) needs to be checked.

### **15 PUMP ENGAGED/THROTTLE READY LED's inoperative**

These LED's are connected directly to their associated interlock. If 12 VDC is present at pin 2, then the THROTTLE READY LED should be on. If 12 VDC is present at pin 10, then the PUMP ENGAGED LED should be on.

If 12 VDC is present and the LED is not on, the governor will need to be replaced. The LED's can be damaged by electrical "spikes" from the chassis and this condition may or may not be covered by the Class1 warranty. In any event, this condition is most likely the result of external conditions and they should be investigated before replacing the governor to prevent a recurrence.

# Self Test

## TEST SETUP

The apparatus should have the engine running at idle with the transmission in neutral, the parking brake applied and the pump should not be engaged.

Monitor the Message Center and note what is displayed. If type=ANA is displayed, it will be followed by a voltage range. This range is very important for diagnostics.

To exit the selftest, press IDLE and PRESET at the same time.

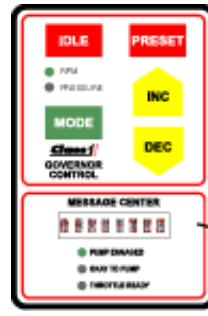

- POS-0 OEM Interlock
- POS-1 PTO Interlock
- POS-2 Switch Panel
- POS-3 Analog Type
- POS-4 PWM Type
- POS-5 Transducer
- POS-6 High Idle Input
- POS-7 Internal Relay

POS-0 X  
POS-1 X  
POS-2 X  
POS-3 X  
POS-4 X  
POS-5 X  
POS-6 X  
POS-7 X

Enter the Self Test by pressing in sequence: **IDLE INC IDLE INC IDLE INC IDLE INC**

Below is a guide to the tests and at the bottom, a place to record your readings.

The Okay to Pump LED will begin flashing and the output type is checked. The Message Center will display: Type = **ANA** or Type = **PWM**

ANA will be followed by a voltage range, please note this range below.

After determining output type, the Message Center will normally look like one of these.

X X X **3** - X X 7                      X X X - **4** X X 7

The 7 may or may not be shown depending on the condition of the interlocks.

OEM Interlock Test POS-0

Release the Park Brake or Shift from Neutral

**0** X X 3 - X X 7

Reapply the Parking Brake or shift back to Neutral

**0** indicates that the interlock input changed.

**X** indicates that the input has not changed.

PTO Interlock Test POS-1

Shift into Pump Gear

**0 1** X 3 - X X 7

Shift to Back to Road Gear

**1** indicates that the interlock input changed.

**X** indicates that the input has not changed.

Transducer 0 PSI test POS-5

**0 1** X 3 - **5** X 7

**5** indicates normal 0 PSI

**0 1** X 3 - **H** X 7

**H** indicates more than 0 PSI

**0 1** X 3 - **F** X 7

**F** indicates failure.

Switch Panel Test POS-2

(press each switch at least once, in any order)

**0 1 u** 3 - 5 x 7

**0 1 p** 3 - 5 x 7

**0 1 2 3** - 5 x 7

A 2 indicates that all switches were recognized. X indicates at least one was missed.

High Idle Switch Test POS-6

Engage the High Idle Switch if equipped.

**0 1 2 3** - 5 **6** 7

**0 1 2 3** - 5 **X** 7

A 6 indicates that the High Idle switch was recognized. X indicates that the switch was not seen, if High Idle worked, then this would mean that the governor High Idle circuit is not being used.

Enter your results here... Type = **ANA** ( ) Analog

**PWM** ( ) Pulse Width Modulated (CAT)

Analog \_\_\_\_\_ to \_\_\_\_\_ VDC

  0     1     2     3     4     5     6     7  

At this point, all of the basic governor functions have been tested. If all sections passed, then the problem is likely not in the governor. You can press PRESET and IDLE at the same time to exit the Self Test. Remove power from the governor. Press and hold the IDLE switch and reapply power to the governor. A 'V' number will appear and remain as long as you continue to hold the IDLE switch.

Record the V number here:

  V     6     .   0     x     4     4     4

## Installation

### Control Module

The control module requires a rectangular cutout as shown. The module is watertight and may be mounted in any location on the operators panel.

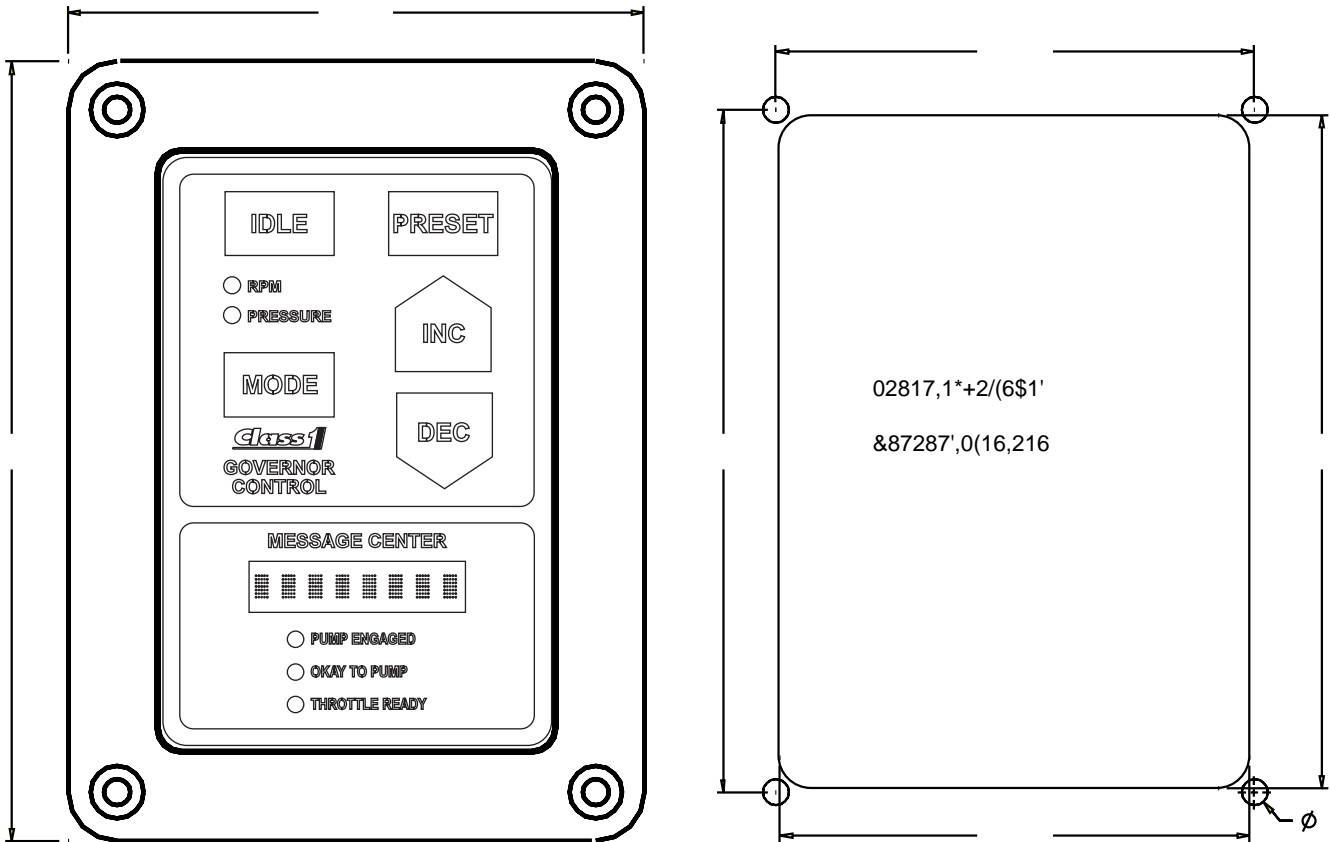

### Pressure Transducer

Locate the pressure transducer where it can read pump discharge pressure without turbulence. A 'tee' at the Master Discharge Gauge would be a good location, this should also reduce vibration to the transducer. Threads are 1/4 NPT and a sealant should be applied prior to installation. The transducer should be located in an area with minimum turbulence. When tightening the transducer, apply torque to the 1-1/4" hex flange of the transducer, not the body. Every effort should be made to eliminate the chance for moisture entering the transducer connector including immediate connection of the transducer harness connector after installation.

### System Wiring

The pressure governor comes with wiring and connectors for installation.

Refer to the diagrams in the manual for specific input requirements.

Refer to the appropriate Engine Electronic Application and Installation Guide for information on engine electrical interfacing and programming.

# -4& -12Connector

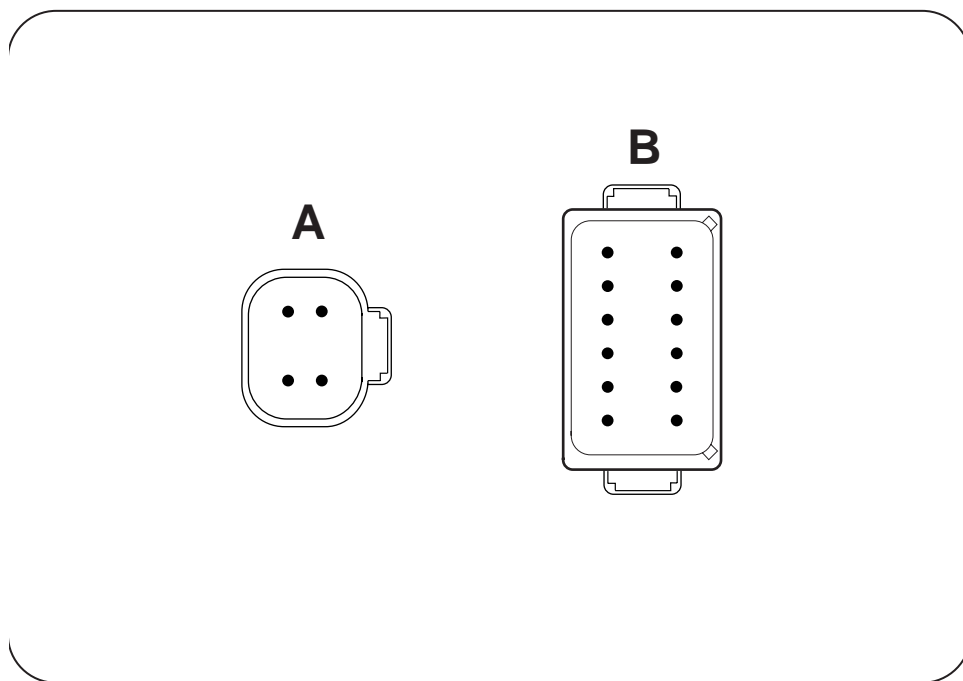

Connector A DT06-4S

1	System Power	12 VDC	INPUT
2	System Ground	Ground	INPUT
3	Plug	NC	-----
4	Plug	NC	-----

Connector B DT06-12S

1	5 VDC input	5 VDC	INPUT
2	Throttle Interlock	12VDC	INPUT
3	High Idle	12 VDC	INPUT
4	CAT ID Input	12 VDC	INPUT
5	Transducer Ground	XDucer Ground	OUTPUT
6	Transducer Voltage	XDucer 5 VDC	OUTPUT
7	Transducer IN	Xducer Signal	INPUT
8	Analog Out	Control Signal	OUTPUT
9	Signal Ground	Ground	INPUT
10	Pump Engaged Interlock	12 VDC	INPUT
11	Delay Relay Common (30)	Enable Input	INPUT
12	Delay Relay NO (87)	Enable Output	OUTPUT

## Governor Connectors

# PSI Transducer

## Pressure Transducer cable and connector.

7JDQVGXFHU&RQQI

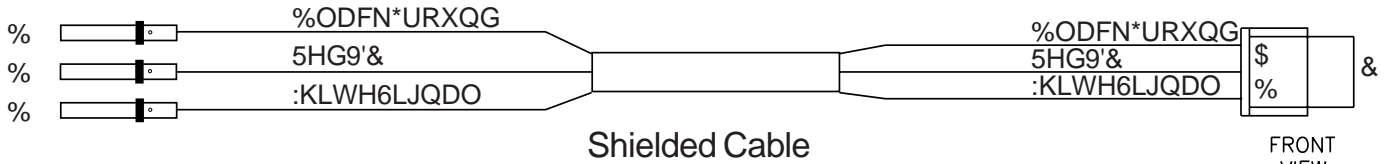

	100581 P165-5276 300 PSI
True Pressure	Transducer Voltage Low mV
0-22	680
23-34	988
35-44	1168
45-54	1307
55-64	1427
65-74	1567
75-84	1708
85-94	1846
95-104	1988
105-114	2105
115-124	2243
125-134	2384
135-144	2522
145-154	2664

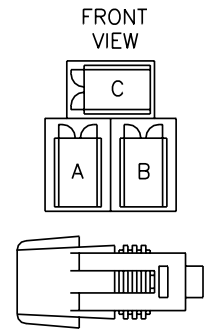

WARNING

Make certain that the weather seal is in place before inserting into the transducer.

## Pressure Transducer

Locate the pressure transducer where it can read pump discharge pressure without turbulence.

A 'tee' at the Master Discharge Gauge would be a good location, this should also serve to reduce vibration and shock to the transducer. Threads are 1/4 NPT and a sealant should be applied prior to installation. When tightening the transducer, apply torque to the 1-1/4" hex flange of the transducer, not the body.

Every effort should be made to eliminate the chance for moisture entering the transducer connector including immediate connection of the transducer harness connector after installation.

# Wiring

8211(8725)(8768+
76\$
326.\$(685.37.21
9&
20.17(5/28.9&
+ +, /9&
8\$7.17(5/28.9&
75\$1(68&(5*5281'
75\$1(68&(56833<
4217(5/2/5.'1\$/'
6.'1\$.'5281'
372.17(5/28.9&
15%/(6833<
15%/(287387

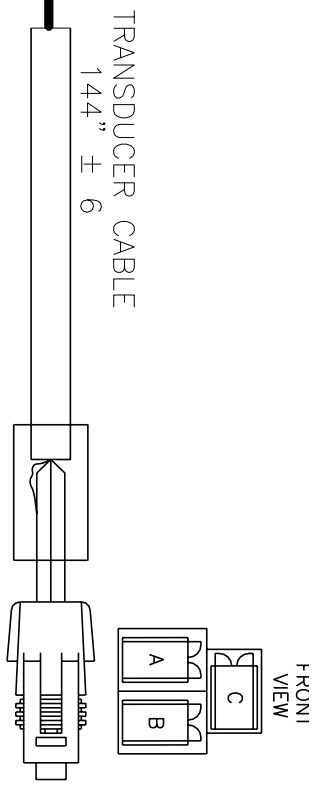
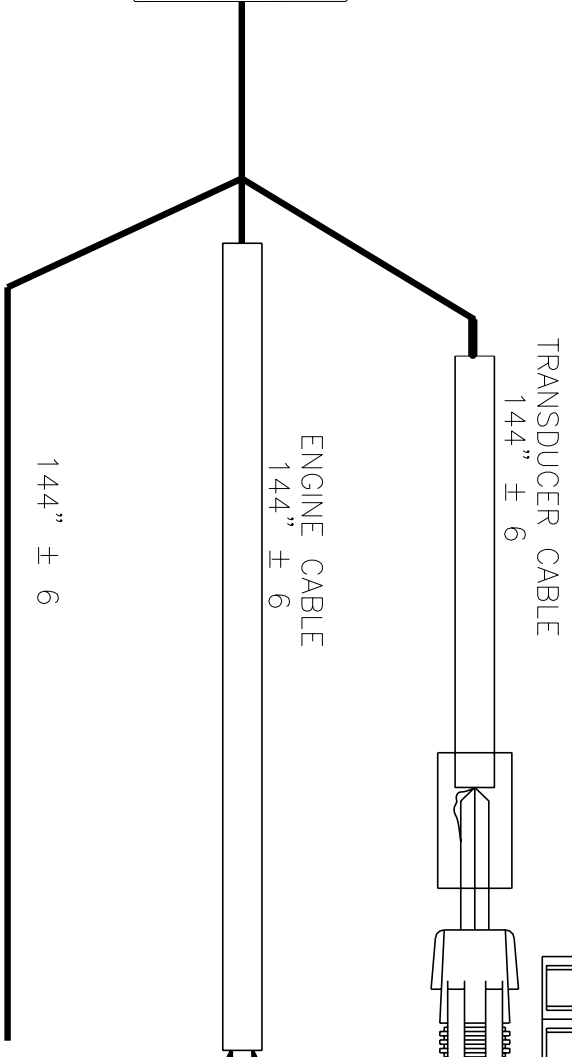
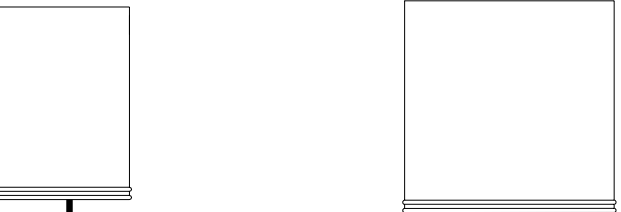

821138&,\$5'
326.\$(685.37.21
\$61(625517851
%6(16256833<
86.'1\$/'

&RORU.5'(685.37.21
5/9&
%ODFN&LJDDO'TURXOG
4HOOR&RQWUROR&LJDDO
%URZQ&57'
2UDQJH(ODEOH,OSXW
%OXH(DDDEOH2XW\$XW

&LUF&XLW
20.QWHUDORFN
37ZIQDJHG
+LJKGOH

&LUF&XLW
6XSSO9&
*URXQOG

8211(8725)(8768+
76
326.\$(685.37.21
5/9&
%/6&.'5281'
3/8*
3/8*

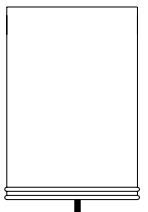

## Power and Ground

It is imperative that the **Class I** Pressure Governor be supplied power and ground from the same source as the engine Electronic Control Module.

***This is the only configuration that will assure reliable operation.***

Terminal A-1            This is the Governor power input 12/24 VDC.

Terminal A-2            This is the Governor ground input.

## Interlocks

There are two (2) 12 VDC interlocks that must be supplied to the governor for operation.

Terminal B-2

The Throttle Ready or OEM Interlock must be continuously maintained once it is established. This input allows the governor to operate in RPM mode and accept a High Idle input.

Terminal B-10

The Pump Engaged Interlock is necessary to initiate pressure governing and it must not cause the OEM interlock to dropout when it is established or erratic operation of the governor could ensue. When the pump engaged interlock is active, the high idle function is precluded.

If a CAT Engine is installed, provide 12 VDC to terminal 12-4. This will ensure that the governor will always output a PWM signal and ignore any engine type programming. This engine type will show up as an 'a' during the power on sequence.

## High Idle

Terminal B-3

This 12 volt signal input causes the governor to bring the engine to a preset RPM.

## Throttle Enable Relay

Terminals B-11 and B-12

There is a governor controlled relay available to switch signal voltage or ground to the remote throttle enable signal. This is the recommended configuration to handle the throttle source switching function from the cab throttle to the remote throttle. Since it is controlled by the governor, it disables remote throttle operation whenever **[MODE]** is shown in the display.

## Transducer Connection

Terminals B-5, B-6 & B-7

Sensor ground is provided at terminal B-5.

Sensor voltage (5VDC) for the pressure transducer is at terminal B-6.

Sensor signal is input at terminal B-7.

Wiring should be straight from the transducer for at least 2 inches before being bent.

## Engine ECM Connections

Terminal B-1, B-8 and B-9

The engine control signal output (B-8) is sent to the engine ECM. It should be connected to the remote throttle input terminal. B-1 is ECM 5 VDC and B-9 is ECM signal ground.

# Cummins ISC Governor Wiring Revision

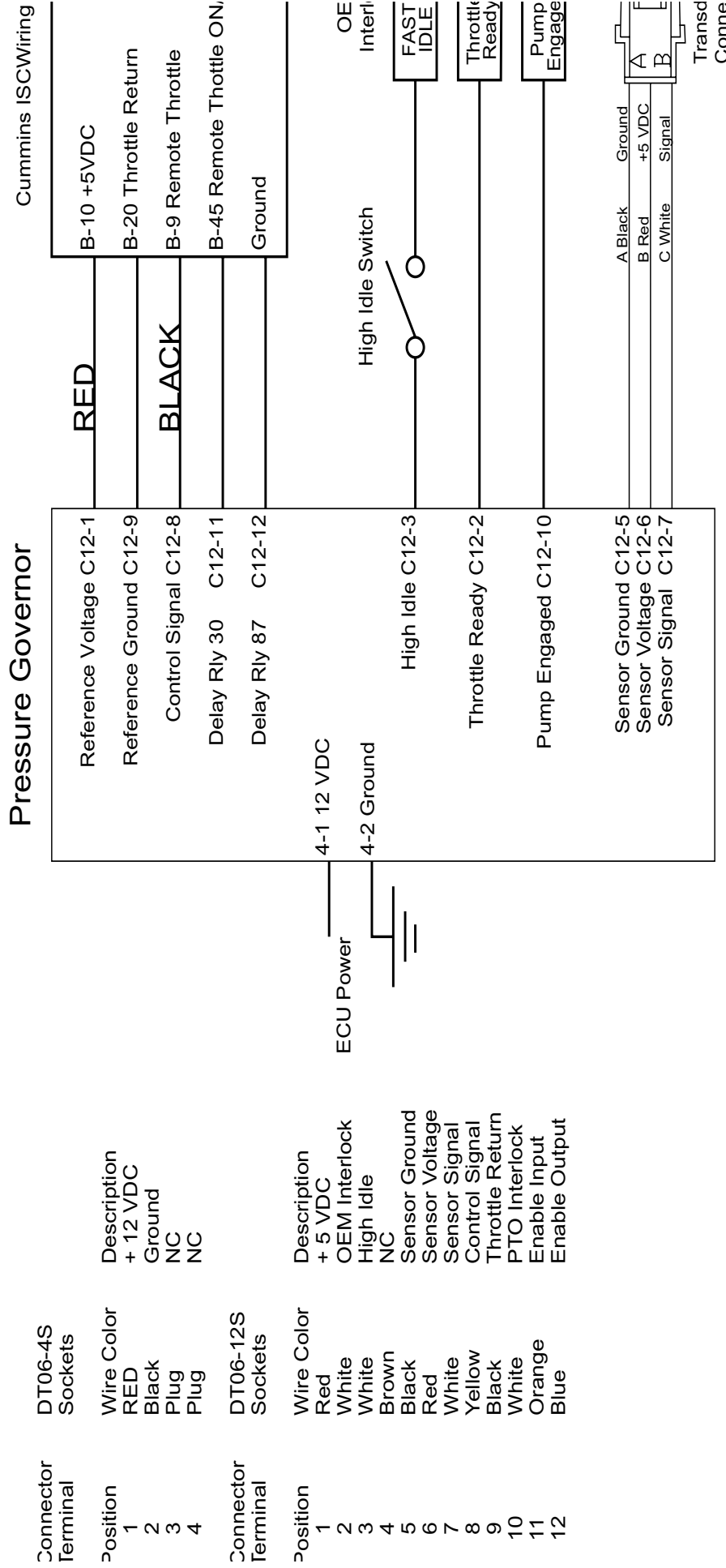

**Important:** This governor version incorporates the Engine 5 Volt and Ground References IT WILL NOT OPERATE without these circuits wired as shown.  
Any questions should be directed to Class1 Support at 1-800-533-3569



# Cummins ISM Governor Wiring Revision



## Pressure Governor

## Cummins ISM Wiring

Connector Terminal	DT06-4S Sockets	DT06-12S Sockets	Wire Color	Description
1	RED		Red	+ 5 VDC
2	Black		White	OEM Interlock
3	Plug		White	High Idle
4	Plug		Brown	NC
			Black	Sensor Ground
			Red	Sensor Voltage
			White	Sensor Signal
			Yellow	Control Signal
			Black	Throttle Return
			White	PTO Interlock
			Orange	Enable Input
			Blue	Enable Output

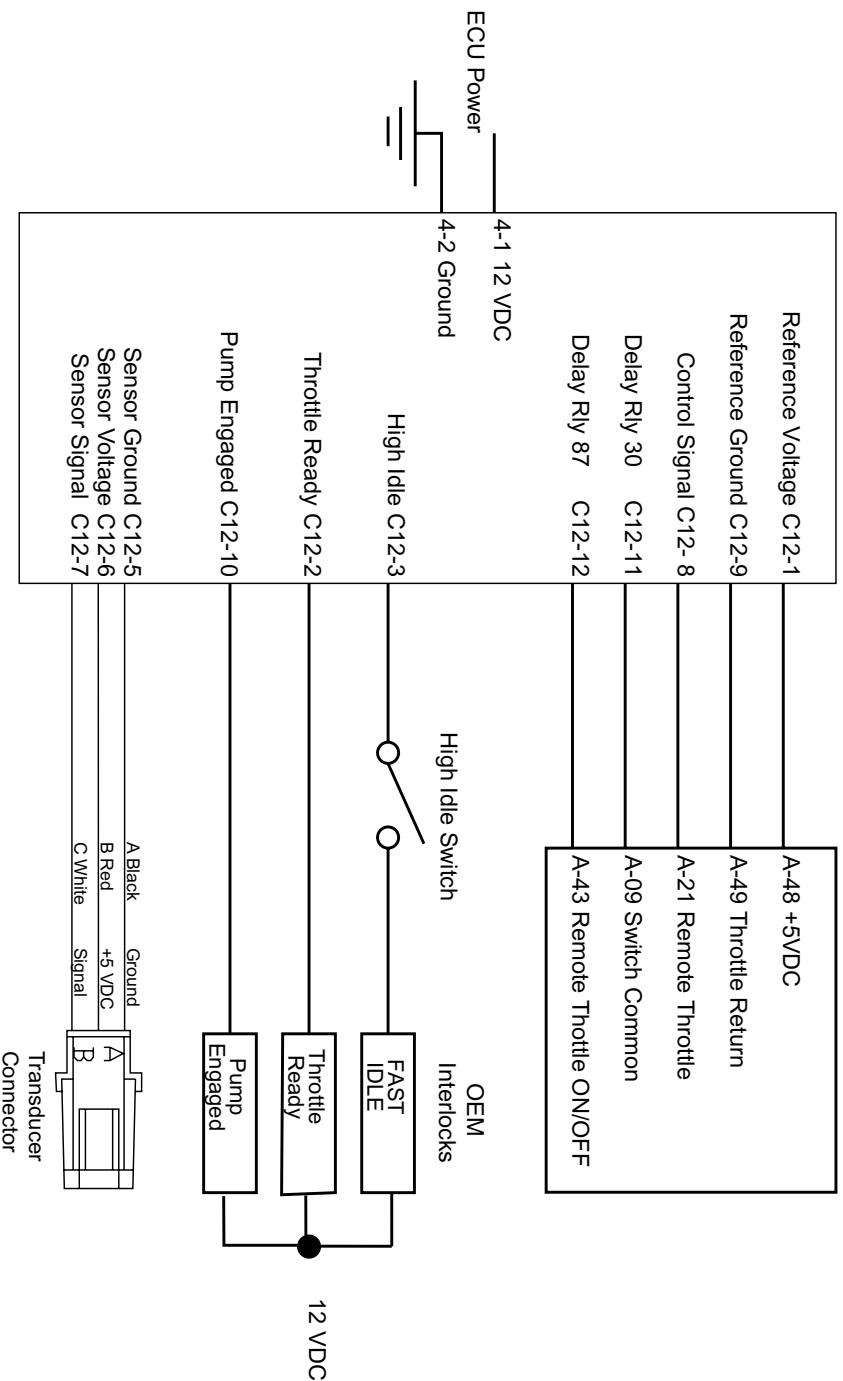

**Important:** This governor version incorporates the Engine 5 Volt and Ground References. IT WILL NOT OPERATE without these circuits wired as shown.

Any questions should be directed to Class 1 Support at 1-800-533-3569

Connector DT06-4S (C4)  
Terminal Sockets

Position	Wire Color	Description
4-1	RED	+ 12 VDC
4-2	Black	Ground
3	Plug NC	
4	Plug NC	

ECU Power

Connector DT06-12S (C12)  
Terminal Sockets

Position	Wire Color	Description
1	Red	NC
2	White	OEM Interlock
3	White	High Idle
4	Brown	CAT ID Input 12 VDC
5	Black	Sensor Ground
6	Red	Sensor Voltage
7	White	Sensor Signal
8	Yellow	Control Signal
9	Black	NC
10	White	PTO Interlock
11	Orange	Enable Input
12	Blue	Enable Output

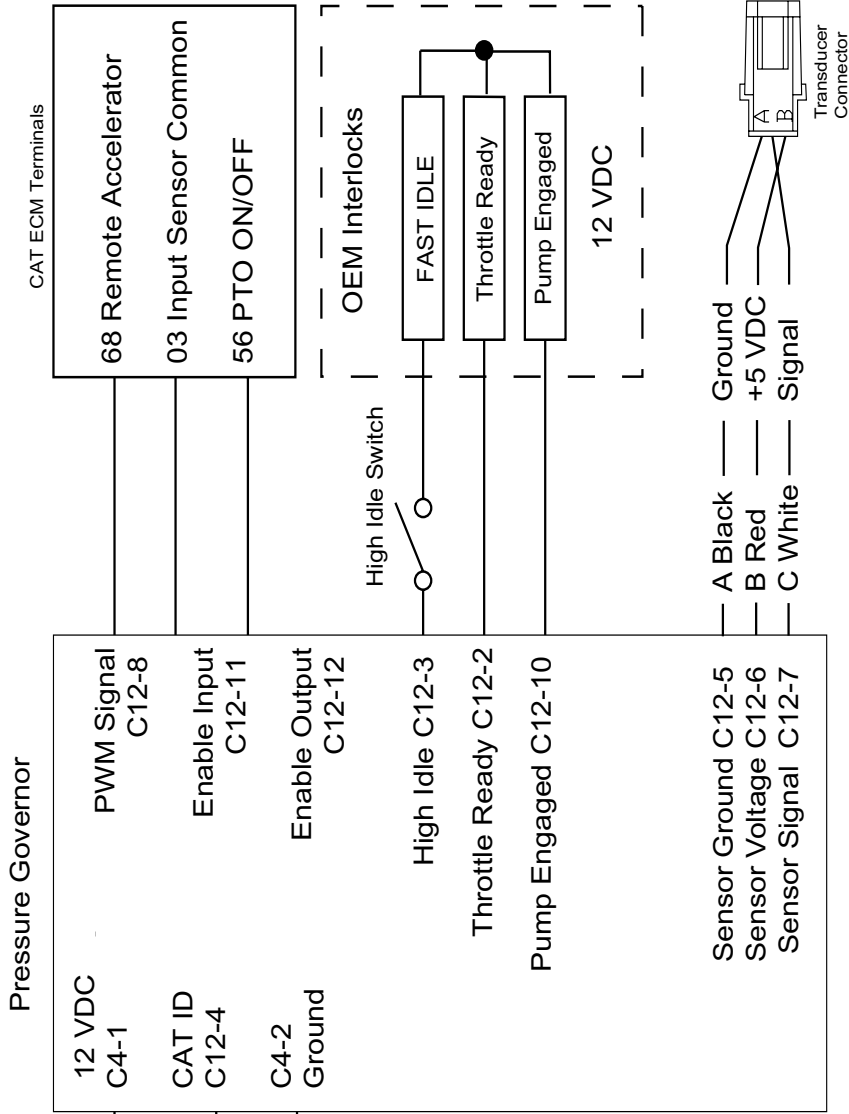

**Important:** This governor utilizes the CAT ID input at terminal 12-4 to ensure proper operation. Any questions should be directed to Class1 Support at 1-800-533-3569

## Navistar Governor Wiring



### Pressure Governor

### Navistar Wiring

Connector Terminal	Socket	Wire Color	Description
1	RED	RED	+ 12 VDC
2	Black Plug	Black	Ground
3	Black Plug	Black	NC
4	Black Plug	Black	NC

Position	Wire Color	Description
1	Red	97 DD
2	White	OEM Interlock
3	White	High Idle
4	Brown	CAT ID
5	Black	Sensor Ground
6	Red	Sensor Voltage
7	White	Sensor Signal
8	Yellow	Control Signal
9	Black	97 HM
10	White	PTO Interlock
11	Orange	Enable Input
12	Blue	Enable Output

Navistar Circuit	ECM Pin
97DE Switch Voltage	12 VDC 1 Amp
97CC Variable Enable	36
99F Remote Sensor Output	30
97DD 5 Volt reference	05
97HM Reference Ground	06

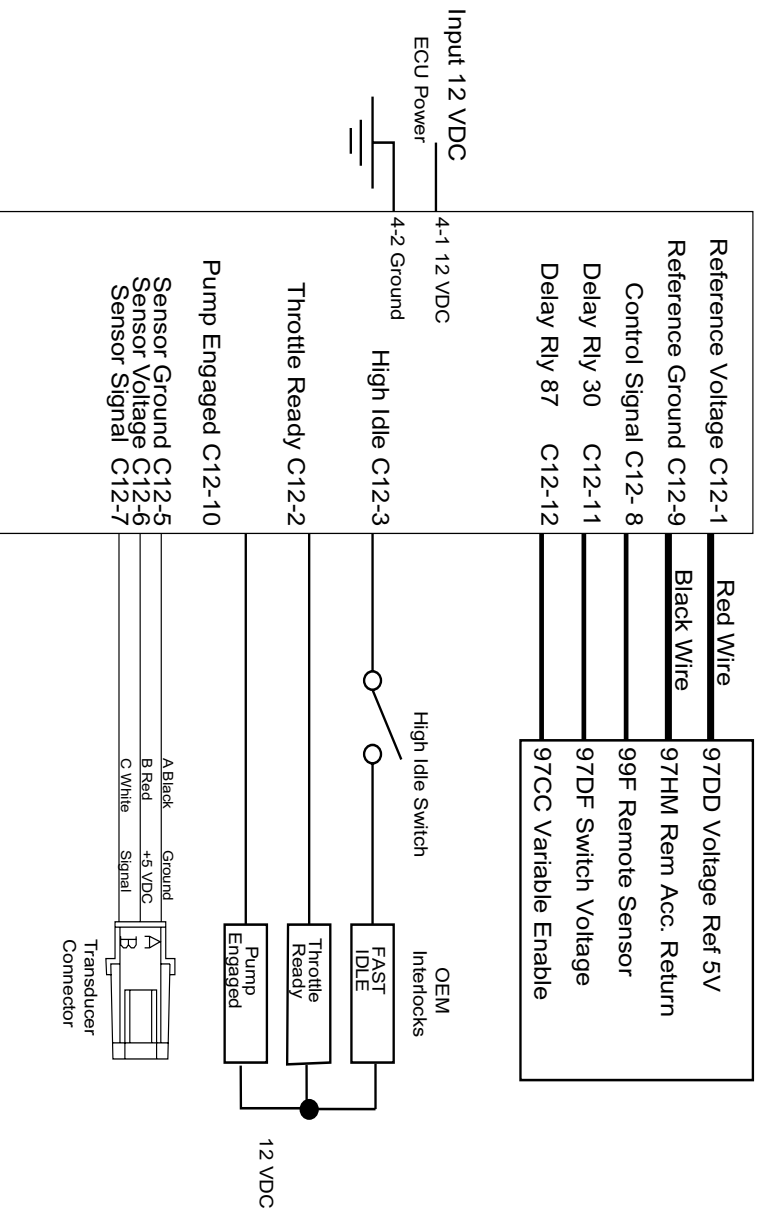

### Important:

This governor version incorporates the Engine 5 Volt and Ground References. IT WILL NOT OPERATE without these circuits wired as shown.

Any questions should be directed to Class1 Support at 1-800-533-3569

# DDEC Governor Wiring

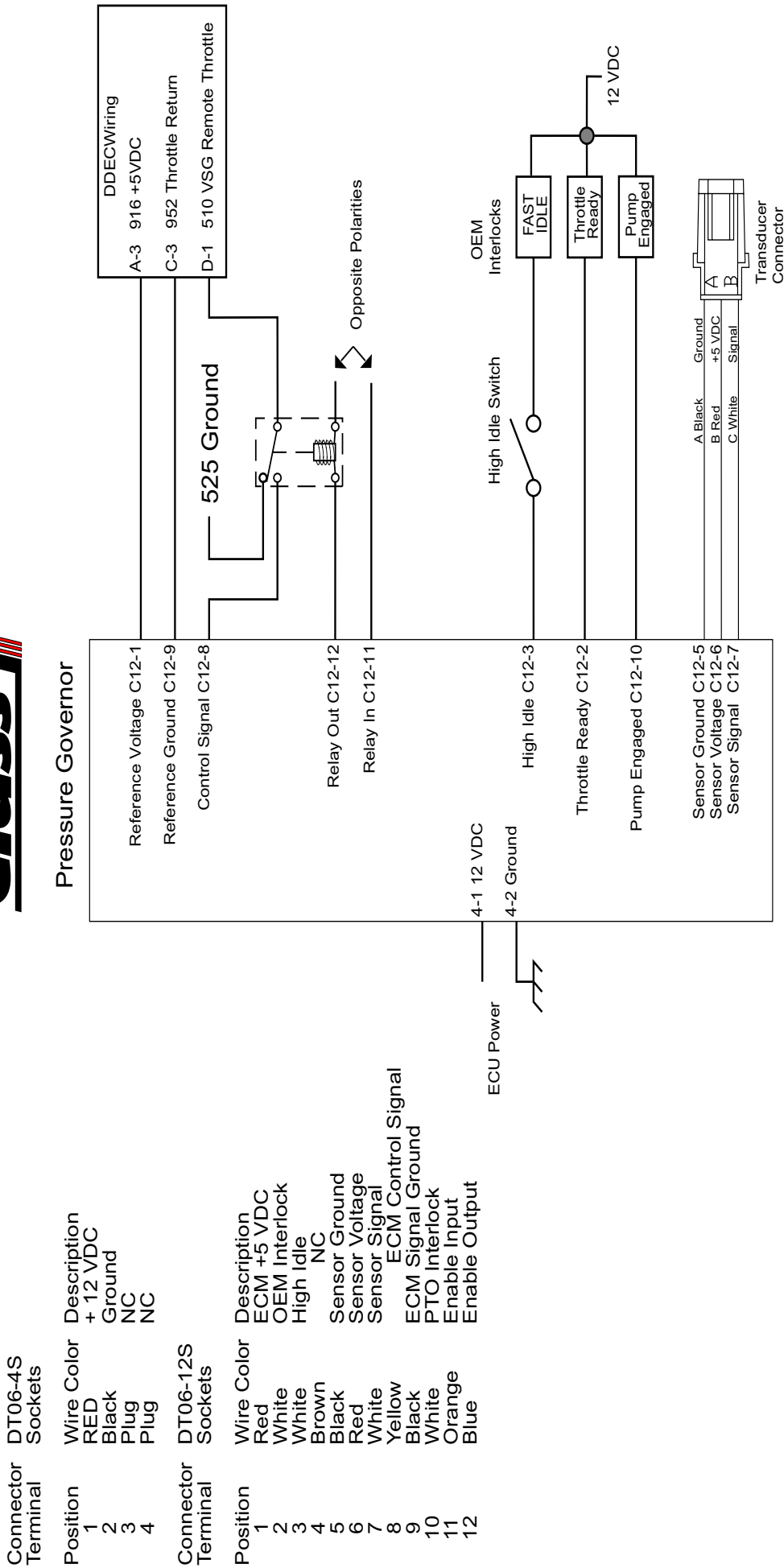

**Important:** This governor version incorporates the Engine 5 Volt and Ground References. IT WILL NOT OPERATE without these circuits wired as shown. Any questions should be directed to Class1 Support at 1-800-533-3569

## Mack Governor Wiring



### Pressure Governor

### Mack ECM Wiring

Connector Terminal	DT06-4S Sockets	Wire Color	Description
1	RED	+ 12 VDC	Reference Voltage
2	Black	Ground	Reference Ground
3	Plug	NC	Control Signal
4	Plug	NC	Delay Relay

Connector Terminal	DT06-12S Sockets	Wire Color	Description
1	Red	+ 5 VDC	Reference Voltage
2	White	OEM Interlock	High Idle
3	Brown	NC	Sensor Ground
4	Black	Sensor Voltage	Sensor Signal
5	Red	Control Signal	Throttle Return
6	Yellow	Throttle Return	PTO Interlock
7	Black	Enable Input	Enable Output
8	White		
9	Orange		
10	White		
11	Orange		
12	Blue		

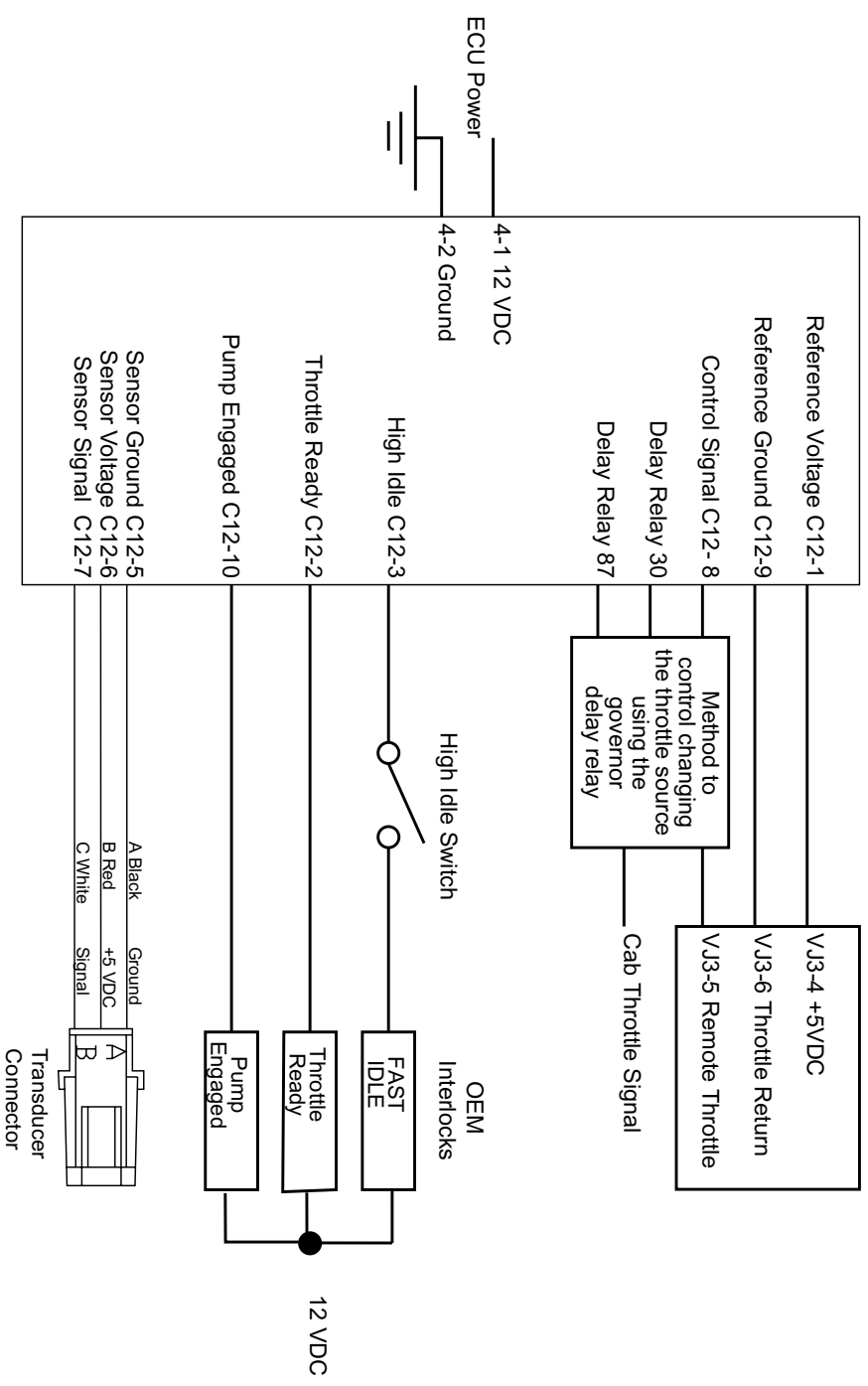

**Important:** This governor version incorporates the Engine 5 Volt and Ground References.

IT WILL NOT OPERATE without these circuits wired as shown.

Any questions should be directed to Class 1 Support at 1-800-533-3569

# Mercedes MBE 900 Governor Wiring



Connector DT06-4S Terminal Sockets

Position	Wire Color	Description
1	RED	+ 12 VDC
2	Black	Ground
3	Plug	NC
4	Plug	NC
Connector Terminal	DT06-12S Sockets	
Position	Wire Color	Description
1	Red	+ 5 VDC
2	White	OEM Interlock
3	White	High Idle
4	Brown	NC
5	Black	Sensor Ground
6	Red	Sensor Voltage
7	White	Sensor Signal
8	Yellow	Control Signal
9	Black	Throttle Return
10	White	PTO Interlock
11	Orange	Enable Input
12	Blue	Enable Output

Mercedes MBE900 VCU Wiring

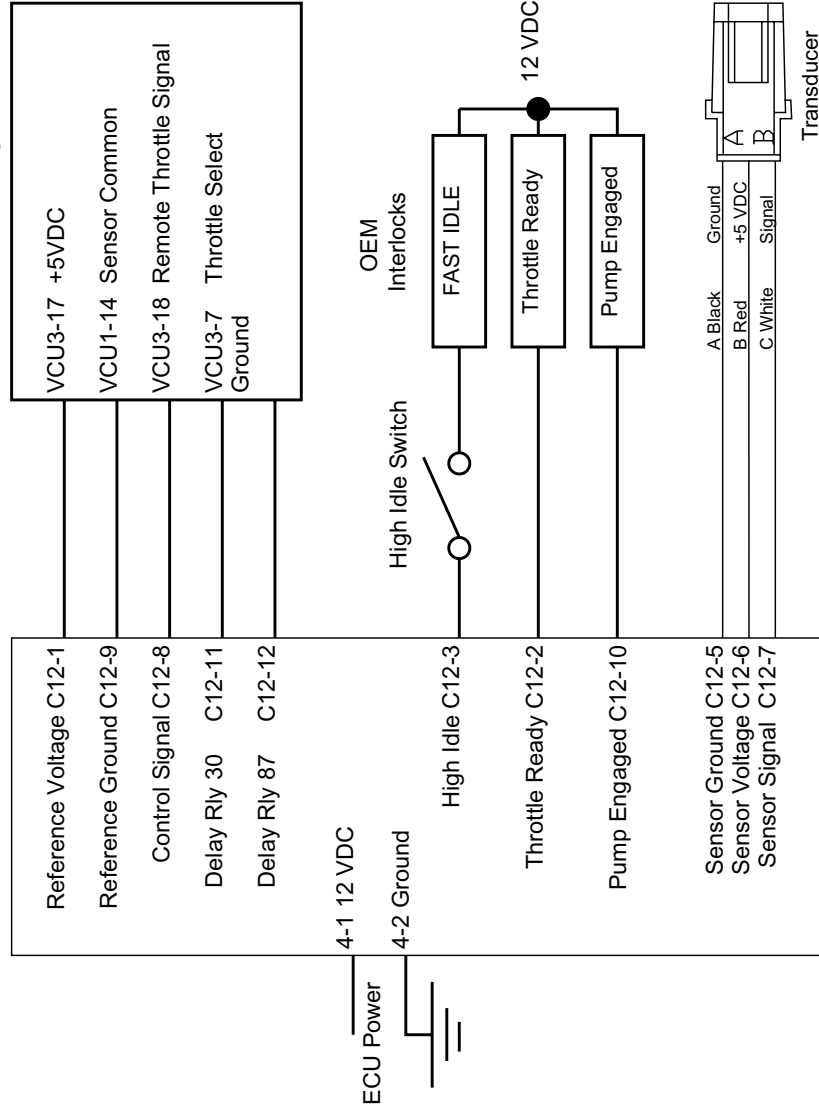

**Important:** This governor version incorporates the Engine 5 Volt and Ground References.

IT WILL NOT OPERATE without these circuits wired as shown.

Any questions should be directed to Class1 Support at 1-800-533-3569

# Engine ECM

## Special Programming Considerations for the engine

Some Engine Manufacturer's Electronic Engine Control Module (ECM) must be programmed for remote PTO or remote Throttle operation. Refer to the appropriate Engine Manual for details. If available, the engine should operate in VSG mode when pumping.

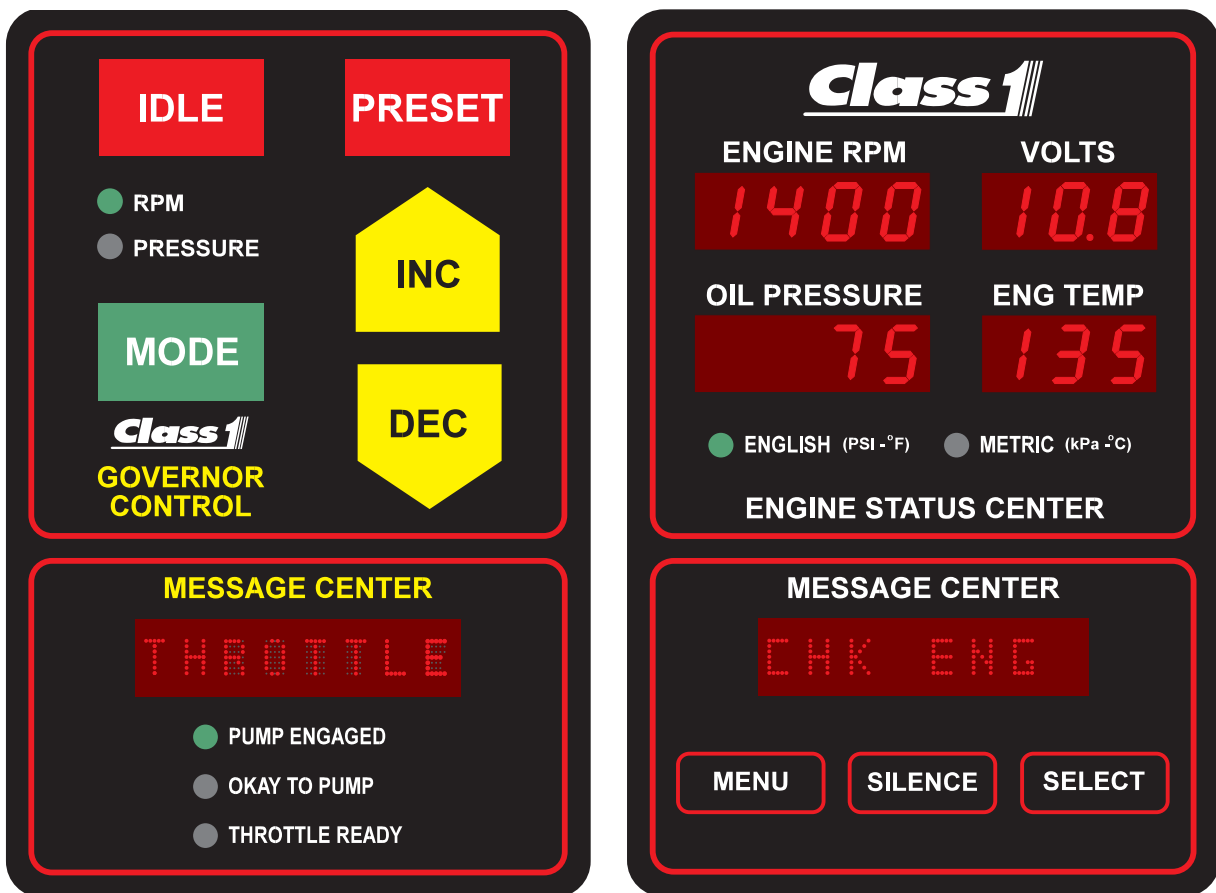

The pressure governor can be combined with a **Class 1** Engine Status Center or ENFO III to provide the pump operator with necessary engine information in a matching style display.

# Preset Programming

## Changing the preset RPM or Pressure

Holding the PRESET switch as the first function after the governor Power On Cycle accesses the governor PRESET programming function.

Apply power to the controller and hold the preset switch until the display indicates **PRESET**, then release the switch (approx. 10 seconds).

Typically, the RPM Preset is an engine speed that either enhances alternator output or provides good pump priming ability. Once set to department specification, it should not need to be changed.

The Preset Pressure is normally one that is set by the department for initial attack operation or a safe pressure for pre-connects. If set too high, it could present a hazard to operators. The design intent is to get the apparatus up and pumping in a minimal amount of time. Once the truck is operating, the pressure should be adjusted to the operation being performed.

The display will show **PRESET** while in the **PRESET** programming mode.

The apparatus must be operating (engine running) to preset an RPM and the pump must be engaged to preset a Pressure. The only indication of mode will be the two LED's at the top left of the controller.

The green RPM LED will be illuminated in the Throttle Mode and the amber PRESSURE LED is illuminated when operating in Pressure Mode.

Operate the controller using the **INC** and **DEC** switches until you attain the desired RPM or pressure.

Press the **PRESET** switch to store this value.

**STORING** will be displayed in the Message Center.

Change the operating mode and operate the controller to achieve the desired value for that mode.

Press the **PRESET** switch to store this value.

**STORING** will be displayed in the Message Center.

Press **IDLE** to return to normal operation and save the settings to memory.

**UPDATING** will be displayed in the Message Center.

The controller is now in operational condition with **[MODE]** showing in the Message Center.

To test the presets, select a mode and press the **PRESET** Switch. The governor should operate the engine to the correct Preset Point for the mode you selected.

Presets can be set individually if desired.



# Engine Type Programming

## Selecting Engine Type

The engine code at powerup should reflect the engine type of the apparatus. If it becomes necessary to change the engine type, a password can be entered to allow engine selection.

With **[MODE]** showing in the message Center, enter the following keypress sequence:

**IDLE INC INC IDLE IDLE INC IDLE INC**

The Message Center will display **ENG= ???**

Select the correct engine type by scrolling through the options using the **INC** or **DEC** switches. When the correct engine is displayed, press **PRESET**.

Engine Types	Code	Idle Output	Max. Output
CAT using the CAT ID Input and type select	a	12%	87%
Cummins = IS for ISX ISL ISB ISC ISM	b	1.25	3.8 V
Navistar = NAV (All)	c	0.7	4.2 V
Detroit Diesel Series 40 = S40 (Navistar)	d	0.7	4.2 V
Detroit Diesel = DET (All DDEC)	e	0.7	4.2 V
Mack (V-MAC III)	f	0.7	4.2 V
Mercedes (MBE900)	g	1.0	4.0 V
Custom Range	h	>0.7	<4.2 V
Caterpillar = ID wire, Not CAT select	z	12%	87%
Caterpillar = CAT select, no ID wire	Z	12%	87%

---

## Programming the governor to match the engine

A Custom Engine setup is provided. This allows the governor to establish a unique idle value and top engine speed.

Start the engine and enable the Throttle Ready Interlock. Enter the following password:

**IDLE INC INC IDLE IDLE INC INC INC**

The Message Center will display **IDLE=000**

Use the **INC** and **DEC** switches to bring the engine to the desired low point (at the idle threshold or a slight idle 'bump' as desired) press **PRESET**.

**STORE LO** will be displayed followed by  
**FULL=000**

Increase engine speed to the desired maximum RPM and then press **PRESET**

**STORE HI** will be displayed followed by

**IDLE REQ,**

then **[MODE]** and a return to normal operation.

# Parameter Programming

## Programmable Parameters

These adjustable settings allow the governor to better match the engine/PTO/pump configuration of the apparatus.

Press and hold the **IDLE** and **PRESET** switches, then press the **MODE** switch (All three depressed simultaneously). The message center will show

**-MENU-**

press the MODE switch. This will scroll through the three menu options.

**SET RAMP**  
**SET SENS**  
**SET GAIN**  
**SET TRIM**

When the option that you want to change is displayed, press the INC switch to select it. More detailed information on the effect of these settings is available on page 21.

---

**RPM Ramp Rate:** This parameter controls how fast the governor responds to increase and decrease switch requests. Values are 0-10 with 5 being the default. The lower the value, the greater the response with each switch press.

**Ramp XX**

is displayed where XX is the current numeric value. Pressing the INC/DEC switches changes the value. Press PRESET to save the change. Press MODE to scroll to the next parameter.

---

**PSI Gain:** This parameter controls the pressure gain or how quickly the governor controls the engine when reacting to pressure changes. Values are 0-10 with 5 being the default. The lower the value, the slower the response.

**Gain XX**

is displayed where XX is the current numeric value. Pressing the INC/DEC switches changes the value. Press PRESET to save the change. Press MODE to scroll to the next parameter.

note; this parameter is critical to good operation. If set too high, the governor can cause an oscillation or surging condition with high pressures resulting. If it is set too low, the governor might not respond fast enough to pressure changes. This parameter should only be adjusted when flowing water in a 'normal' configuration.

---

**PSI Sensitivity:** This parameter controls the pressure sensitivity or how much the pressure is allowed to deviate from the set point before the governor will control the engine to restore the set point pressure. Values are 0-10 with 5 being the default. The lower the value, the tighter the pressure window the governor will maintain.

**Sense XX**

is displayed where XX is the current numeric value. Pressing the INC/DEC switches changes the value. Press PRESET to save the change. Press MODE to scroll to the next parameter.

---

**Trim:** This parameter controls how much the governor will increase engine speed in an attempt to correct a pressure drop. It can be varied from 5% to 20% of maximum governor output. Essentially this will limit an RPM increase to between 200 and 400 RPM above the RPM used to achieve the pressure setpoint. If the engine is running at 1500 RPM and the trim is set to 5%, the engine speed will increase to only around 1700 RPM. If the trim is at 20%, the RPM could increase to around 1900 RPM. The actual increases are engine dependent and the figures stated here are only approximations. Pressing IDLE twice exits from the Menu and saves the current parameters. The message displayed is:

**-DONE-**



Incorrectly configured parameters can cause erratic operation, serious injury or even death. Contact your OEM or Class1 for guidance in their configuration.



# Miscellaneous

It is essential that the governor be powered at the same time as the engine ECM and that the control signal does not drop out when the engine is started. This signal can be checked at the 12 way connector terminal 8 with a voltmeter. Valid signals for idle are 0.6• VDC and higher, for maximum throttle 3.6 to 4.2 VDC.

The governor must have a throttle interlock (12 VDC) signal at terminal 12-2 in order to operate as a throttle or to act on a fast idle input (12 VDC) at terminal 12-3. Additionally, a pump engaged (12 VDC) signal must be present at terminal 12-10 before it can operate in the pressure governing mode.

If the governor is powered with the OEM Throttle interlock and the High Idle request active, it will ignore the High Idle request. High Idle requires an active toggle.

The governor **does not** default to an operating mode, this means that the operator **must** select which mode to operate in before the unit will respond. If the interlocks exist for pressure mode, the first selection will be **PRESSURE**. Once a mode is selected, it remains in effect until the mode switch is pressed, the idle switch is pressed, the unit is powered off, the OEM Throttle interlock is lost or cavitation is detected.

The PRESET function is very useful to expedite initial pumping operations. It can also be very useful to have both a **THROTTLE** and a **PRESSURE** preset. Any time that the PRESET switch is pressed, the engine will go to that point either from a higher pressure/RPM or a lower one. You do not have to be at idle for **PRESET** to function.

When increasing engine RPM from idle using the **INC**rease switch, the governor output must go from its base idle output and cross the idle threshold of the engine being governed. This is very similar to “taking up the slack” in a mechanical engine throttle cable. By using the PRESET function, the “slack” is taken care of automatically and the engine will increase to a known parameter eliminating the guesswork.

Note: A custom engine configuration can be programmed that will tailor the minimum idle output for an application.

Cavitation (running away from water). The governor will react to a pressure drop below 30 PSI for five seconds or more by dropping the engine to idle speed and showing LoSupply in the Message Center. If the pressure climbs above 30 PSI before water loss is recognized, the 5 second timer resets. This means that if the pump has some water, the governor may never “see” a continuous pressure drop below 30 PSI and the engine could run at an advanced speed until it is manually decreased. The maximum speed will be restricted to the last value plus the trim parameter, usually less than a 300 RPM increase. If water is introduced during the period that engine speed is advanced, a pressure spike could result.

**Pump operators should be trained in all aspects of governor operation and have knowledge of all powertrain operating characteristics.**

# Notes

The **first time** that the governor is powered up on a vehicle, the Message Center will display ENG?  
Use the INC and DEC switches to find the proper engine and then press PRESET to save.

For all engines except CAT, the control signal is an analog voltage that is software controlled for minimum and maximum output. There is a hardware minimum of 700 mV for idle and 4.2 V for maximum throttle.

If the signal is present and varies with the INC/DEC switches, it is functioning.

CAT uses a PWM signal. This is a 400 Hz square wave that varies from 12% to 87% duty cycle. It can be measured as voltage. Range is 0.68 to 4.0 VDC.

A relay is incorporated that activates when the MODE switch is pressed if a 12 V input on terminal 2 of the 12 pin connector. Common (30) at pin 11 and NO (87) at pin 12.

12 V at pin 2 allows Throttle Operation and 12 V at pins 2 and 10 allow Pressure Governing.

---

The transducer must have 5 VDC from the governor (B-6) at terminal B.  
The transducer must have ground from the governor (B-5) at terminal A.  
The transducer returns a variable voltage signal from terminal C to the governor (B-7).  
Check for signal voltage and ground at the transducer with a meter between pins A and B with the transducer unplugged. **It must be +5.0 VDC +/- 0.1V.** If the voltage and ground are correct, plug the transducer in and check for PSI voltage at the governor (B-7). It must range between 700 mV and 4.5 V and vary with pressure.

Self diagnostics are entered from the keypad by entering 55:  
IDLE INC IDLE INC IDLE INC IDLE INC  
Complete instructions are on page 18.

Engine selection is available from the keypad by entering 65:  
IDLE INC INC IDLE IDLE INC IDLE INC

Engine types:

CAT using the CAT ID Input and CAT	a	12%
Cummins = IS for ISX ISL ISB ISC ISM	b	1.25
Navistar = NAV (All)	c	0.7
Detroit Diesel Series 40 = S40 (Navistar)	d	0.7
Detroit Diesel = DET (All DDEC)	e	0.7
Mack (V-MAC III)	f	0.7
Mercedes (MBE900)	g	1.0
Custom Range	h	x.x
Caterpillar = CAT ID wire	z	12%
Caterpillar = CAT (All) w/o ID wire	Z	12%

Press **PRESET** to save selection.

55	Self Test
65	Set Engine Type
81	Output Display
82	Xducer Display
83	Defaults
91	PWM
92	RAW XDCR
93	PSI
94	POT Counts
95	Show Setpoints
96	PRESET
97	Custom Range
99	SET--ACT PSI
	0=IDLE 1=INC

To return the governor to default settings, enter 83:  
INC IDLE IDLE IDLE IDLE IDLE INC INC (PRESET)