



**Class 1**

ISO 9001 CERTIFIED

607 NW 27th Ave  
Ocala, FL 34475  
Phone: (352) 629-5020 or 800-533-3569  
Fax: (352)-629-2902

# PRODUCT MANUAL

## Vehicle Data Recorder (VDR) and Seat Belt Warning system



**P/N 119914  
VDR module**



**P/N 118093  
Seat Belt Warning Input module**



**P/N 118620  
Seat Belt Warning display (small)**



**P/N 118551, P/N 119375  
Seat Belt Warning display (large)**

 607 NW 27th Ave Ocala, FL 34475 Ph: 352-629-5020 or 1-800-533-3569 Fax : 352-629-290 or 1-800-520-3473	<b>PRODUCT MANUAL</b>			<b>PAGE</b>	<b>1 OF 26</b>	
	<b>PRODUCT GROUP</b>	<b>ES-Key</b>	<b>P/N</b>	<b>119914, 118093, 118620, 118551, 119375</b>	<b>DATE</b>	<b>10/17/2011</b>
	<b>PRODUCT</b>	<b>Vehicle Data Recorder and Seat Belt Warning system</b>			<b>REV</b>	<b>1.70</b>
					<b>BY</b>	<b>AMS</b>

<b>1.</b>	<b>REVISION LOG .....</b>	<b>2</b>
<b>2.</b>	<b>OVERVIEW .....</b>	<b>3</b>
2.1.	VEHICLE DATA RECORDER FEATURES .....	3
2.2.	SEAT BELT WARNING FEATURES .....	3
<b>3.</b>	<b>PART NUMBERS .....</b>	<b>4</b>
3.1.	MODULE PART NUMBERS .....	4
3.2.	KIT PART NUMBERS .....	4
3.3.	MISCELLANEOUS PART NUMBERS .....	4
<b>4.</b>	<b>CONFIGURATION .....</b>	<b>5</b>
4.1.	VEHICLE DATA RECORDER (P/N 119914) .....	5
4.1.1.	<i>Vehicle Data Recorder configuration using the VDR View Data Management software</i> .....	5
4.1.2.	<i>Vehicle Data Recorder information retrieval</i> .....	5
4.2.	SEAT BELT WARNING INPUT MODULE (P/N 118093) .....	6
4.2.1.	<i>Input type configuration</i> .....	6
4.2.2.	<i>“Seat bounce” error validation timing</i> .....	6
4.2.3.	<i>“Leaning in seat” and “seat and belt tie” error validation</i> .....	6
4.2.4.	<i>Address configuration</i> .....	7
4.3.	SEAT BELT WARNING DISPLAY (LARGE – P/N 118551, P/N 119375) .....	8
4.3.1.	<i>Seat belt display indicator position and address configuration</i> .....	8
4.3.2.	<i>Blanking labels</i> .....	8
<b>5.</b>	<b>OPERATION .....</b>	<b>9</b>
5.1.	SEAT AND SEAT BELT DETECTION OVERVIEW .....	9
5.1.1.	<i>Sequence violation during power on cycle</i> .....	9
5.1.2.	<i>“Seat bounce” error validation</i> .....	9
5.2.	SEAT BELT WARNING DISPLAY (SMALL – P/N 118620) .....	10
5.2.1.	<i>Display initialization</i> .....	10
5.2.2.	<i>Operating indications</i> .....	10
5.2.3.	<i>Communication error indication</i> .....	11
5.3.	SEAT BELT WARNING DISPLAY (LARGE – P/N 118551, P/N 119375) .....	11
5.3.1.	<i>Display initialization</i> .....	11
5.3.2.	<i>Operating indications</i> .....	11
5.3.3.	<i>Diagnostic indications</i> .....	12
5.4.	VEHICLE DATA RECORDER (P/N 119914) .....	13
5.4.1.	<i>Alarm operation</i> .....	13
A.	<i>Seat belt violation alarm</i> .....	13
B.	<i>VDR error condition alarm</i> .....	13
5.4.2.	<i>Diagnostic LEDs</i> .....	14
5.4.3.	<i>OEM responsibility</i> .....	14
5.5.	SEAT BELT WARNING INPUT MODULE (P/N 118093) .....	15
5.5.1.	<i>Network alarm tags</i> .....	15
5.5.2.	<i>Diagnostic LEDs</i> .....	15
<b>6.</b>	<b>APPLICATION .....</b>	<b>16</b>
6.1.	TYPICAL VDR SYSTEM .....	16
6.1.1.	<i>Number of seats permitted</i> .....	16
<b>7.</b>	<b>TROUBLESHOOTING .....</b>	<b>17</b>
<b>8.</b>	<b>DIMENSIONS AND INSTALLATION .....</b>	<b>19</b>

 607 NW 27th Ave Ocala, FL 34475 Ph: 352-629-5020 or 1-800-533-3569 Fax : 352-629-290 or 1-800-520-3473	<b>PRODUCT MANUAL</b>			<b>PAGE</b>	<b>2 OF 26</b>	
				<b>DATE</b>	10/17/2011	
	<b>PRODUCT GROUP</b>	ES-Key	<b>P/N</b>	119914, 118093, 118620, 118551, 119375	<b>REV</b>	1.70
	<b>PRODUCT</b>	<b>Vehicle Data Recorder and Seat Belt Warning system</b>			<b>BY</b>	<b>AMS</b>

8.1.	SEAT BELT WARNING INPUT MODULE (P/N 118093) DIMENSIONS .....	19
8.2.	SEAT BELT WARNING DISPLAY (SMALL – P/N 118620) DIMENSIONS .....	20
8.3.	SEAT BELT WARNING DISPLAY (LARGE – P/N 118551, P/N 119375) DIMENSIONS .....	20
8.4.	VEHICLE DATA RECORDER (P/N 119914) DIMENSIONS .....	21
<b>9.</b>	<b>CONNECTOR DESCRIPTION.....</b>	<b>22</b>
9.1.	SEAT BELT WARNING INPUT MODULE (P/N 118093) .....	22
9.2.	SEAT BELT WARNING DISPLAY (SMALL – P/N 118620).....	23
9.3.	SEAT BELT WARNING DISPLAY (LARGE – P/N 118551, P/N 119375).....	23
9.4.	VEHICLE DATA RECORDER (P/N 119914) .....	23
<b>10.</b>	<b>OPERATING PARAMETERS.....</b>	<b>24</b>
10.1.	SEAT BELT WARNING INPUT MODULE (P/N 118093) .....	24
10.2.	SEAT BELT WARNING DISPLAY (SMALL – P/N 118620).....	24
10.3.	SEAT BELT WARNING DISPLAY (LARGE – P/N 118551, P/N 119375).....	24
10.4.	VEHICLE DATA RECORDER (P/N 119914) .....	25

## 1. Revision Log

Rev	Date	Changes
1.70	10/17/2011	Corrected PINOUT for the VDR module.
1.60	8/23/2011	Added "leaning in seat" and "seat and belt tie" error validation configurations.
1.50	4/15/2010	Added kit part numbers. Removed VDR View manual reference.
1.40	10/2/2009	Removed VDR View software configuration and referenced the VDR View software manual (p/n 120328).
1.30	8/14/2009	Added pigtail harness p/n 118420 for small display.
1.20	6/9/2009	Changed VDR part number from 118097 to 119914 to reflect hardware change.
1.10	2/17/2009	Added Seat Belt Warning input module configuration of "seat bounce" error validation timing (software version 1.2) Added Seat Belt Warning input module network tag alarms (software version 1.2) Added P/N 119375 large display with 6 seat positions. Added 119340 blanking labels.
1.00	1/27/2009	Initial requirements

 607 NW 27th Ave Ocala, FL 34475 Ph: 352-629-5020 or 1-800-533-3569 Fax : 352-629-290 or 1-800-520-3473	<b>PRODUCT MANUAL</b>			<b>PAGE</b>	<b>3 OF 26</b>	
	<b>PRODUCT GROUP</b>	<b>ES-Key</b>	<b>P/N</b>	<b>119914, 118093, 118620, 118551, 119375</b>	<b>DATE</b>	10/17/2011
	<b>PRODUCT</b>	<b>Vehicle Data Recorder and Seat Belt Warning system</b>			<b>REV</b>	1.70
					<b>BY</b>	<b>AMS</b>

## 2. Overview

The Class 1 Vehicle Data Recorder (VDR) system is comprised of a Vehicle Data Recorder and a Seat Belt Warning system.

The Vehicle Data Recorder (p/n 119914) monitors and records engine RPM, throttle percentage, vehicle speed, ABS events, transmission range information, parking brake position, master warning position, and seatbelt status via J1939 CAN messages in accordance with NFPA 1901-2009 requirements.

The Seat Belt Warning system utilizes an input module (p/n 118093) and a display (small – p/n 118620, large – p/n 118551, or large – p/n 119375) to indicate the state of each seat.

### 2.1. Vehicle Data Recorder features

- Utilizes the SAE J1939 CAN standard to record NFPA required data
- 32 bit ARM processor.
- Retains the last 100 hours of stored data in memory (saved in one second intervals).
- Internal real-time clock with 10 year battery back-up.
- Two discrete inputs: Park Brake (ground polarity) and Master Warning (positive polarity).
- USB connector for data retrieval via VDR management software (p/n 119206).



### 2.2. Seat Belt Warning features

- Monitor up to 20 seats and 20 seat belts (ground polarity inputs) \*.
- Each input is selectable for Normally Open (N.O.) or Normally Closed (N.C.) switch contacts (inputs are default set to N.O.).
- Validates seat/seatbelt sequencing.
- Enhanced “seat bounce” error validation.
- Small display fits into standard switch cutout (20 seats).
- Large display shows all seat states simultaneously (10 seats).

\* Requires 2 Seat Belt Warning input modules. Each input module can monitor 10 seat and 10 seat belts.



The large display p/n 119375 is the same as the large display p/n 118551 except that the label only has 6 seat positions.



 607 NW 27th Ave Ocala, FL 34475 Ph: 352-629-5020 or 1-800-533-3569 Fax : 352-629-290 or 1-800-520-3473	<b>PRODUCT MANUAL</b>			<b>PAGE</b>	<b>4 OF 26</b>	
	<b>PRODUCT GROUP</b>	<b>ES-Key</b>	<b>P/N</b>	<b>119914, 118093, 118620, 118551, 119375</b>	<b>DATE</b>	10/17/2011
	<b>PRODUCT</b>	<b>Vehicle Data Recorder and Seat Belt Warning system</b>			<b>REV</b>	1.70
					<b>BY</b>	<b>AMS</b>

### 3. Part numbers

#### 3.1. Module part numbers

Seat Belt Warning Input module	118093
Seat Belt Warning Display (small)	118620
Seat Belt Warning Display (large, 10 position)	118551
Seat Belt Warning Display (large, 6 position)	119375
Vehicle Data Recorder Module	119914

#### 3.2. Kit part numbers

Vehicle Data Recorder (VDR) system module kit **121004**

Module kit includes

Seat Belt Warning Input module	QTY-1	118093
Seat Belt Warning Display (small)	QTY-1	118620
Vehicle Data Recorder Module	QTY-1	119914

Vehicle Data Recorder (VDR) system harness kit **120157**

Harness kit includes

Vehicle Data Recorder pigtail harness	QTY-1	120159
Seat Belt Warning Module harness	QTY-1	120158

#### 3.3. Miscellaneous part numbers

CAN connector items

Deutsch 3- position mating plug - GRAY	DT06-3S
Deutsch 3- position mating plug wedge lock - BLUE	W3S-1939
Deutsch 3- position mating plug wedge lock - ORANGE	W3S
Deutsch DT series socket (16 GA) - GOLD	0462-201-1631
Deutsch DT series 3-way "Y" receptacle	DT04-3P-P007
Deutsch 3- position mating plug (120 Ohm terminating resistor)	DT06-3S-P006

 607 NW 27th Ave Ocala, FL 34475 Ph: 352-629-5020 or 1-800-533-3569 Fax : 352-629-290 or 1-800-520-3473	<b>PRODUCT MANUAL</b>			<b>PAGE</b>	<b>5 OF 26</b>	
				<b>DATE</b>	10/17/2011	
	<b>PRODUCT GROUP</b>	<b>ES-Key</b>	<b>P/N</b>	<b>119914, 118093, 118620, 118551, 119375</b>	<b>REV</b>	1.70
	<b>PRODUCT</b>	<b>Vehicle Data Recorder and Seat Belt Warning system</b>			<b>BY</b>	<b>AMS</b>

## 4. Configuration

### 4.1. Vehicle Data Recorder (p/n 119914)

Configuration of the Vehicle Data Recorder module requires installation of the VDR View Data Management software (p/n 119917). The software (on CD media) may be obtained by contacting Class 1 and requesting part number 119916.

The VDR View Data Management Software requires Microsoft® Windows® XP (with SP3 or later) or Microsoft® Windows® Vista, or Mac OS® X.

#### 4.1.1. Vehicle Data Recorder configuration using the VDR View Data Management software

The Vehicle Data Recorder (p/n 119914) must be initially configured for accurate operation.

- **VDR identification parameters.**
  - Fire department's name
  - Vehicle identification number (VIN)
  - Apparatus ID
  - Comments for data identification purposes

Read the VDR View Data Management software manual for instructions on configuring the Vehicle Data Recorder (included on the VDR View Data Management CD).

#### 4.1.2. Vehicle Data Recorder information retrieval

The Vehicle Data Recorder's saved data is retrieved and viewed using the VDR View Data Management software. Read the VDR View Data Management software manual for usage instructions (included on the VDR View Data Management CD).

 607 NW 27th Ave Ocala, FL 34475 Ph: 352-629-5020 or 1-800-533-3569 Fax : 352-629-290 or 1-800-520-3473	<b>PRODUCT MANUAL</b>			<b>PAGE</b>	<b>6 OF 26</b>	
	<b>PRODUCT GROUP</b>	<b>ES-Key</b>	<b>P/N</b>	<b>119914, 118093, 118620, 118551, 119375</b>	<b>DATE</b>	10/17/2011
	<b>PRODUCT</b>	<b>Vehicle Data Recorder and Seat Belt Warning system</b>			<b>REV</b>	1.70
					<b>BY</b>	<b>AMS</b>

#### 4.2. Seat Belt Warning Input module (p/n 118093)

The Seat Belt Warning input module (p/n 118093) must be configured for the seat and seatbelt switch operation (either Normally Open or Normally Closed), “seat bounce” error validation timing (2, 3, 4, or 5 seconds), and the module address (either address 1 or address 2).

Open the Seat Belt Warning input module to gain access to the switch configuration switches and the address configuration jumper.

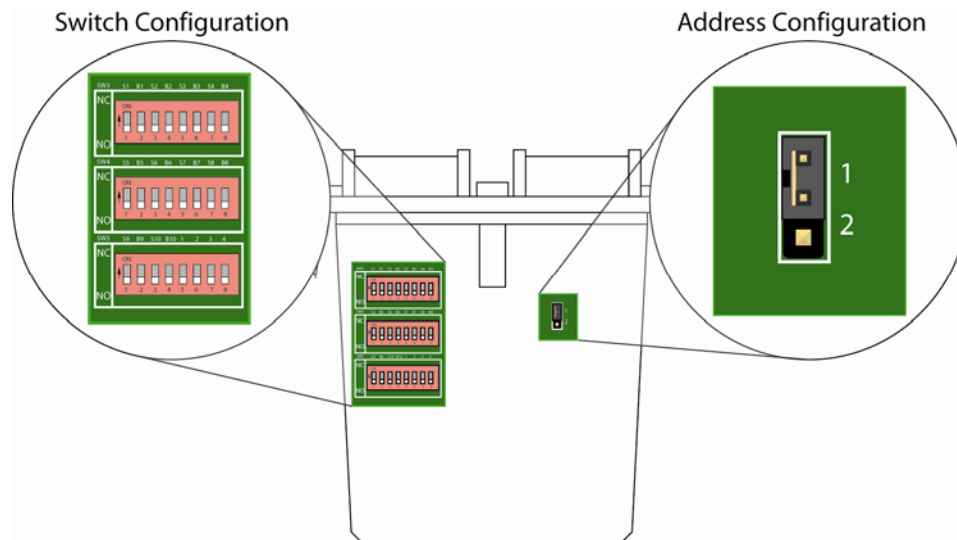

##### 4.2.1. Input type configuration

The inputs for the seats and the seatbelts are designed for ground polarity. The configuration switches set the input type: NC = Normally Closed, NO = Normally Open (default). The “seat” configuration switches are labeled with an “S” and the seat position number, and the “seatbelt” configuration switches are labeled with a “B” and the seat position number. For example, the seat and seatbelt switches for seat position 2 are labeled “S2” and “B2”.

- The Normally Closed (NC) configuration is for inputs that are *open* when the seat (or belt) switch is activated.
- The Normally Open (NO) configuration is for inputs that are *closed* when the seat (or belt) switch is activated.

##### 4.2.2. “Seat bounce” error validation timing

The default time for the “seat bounce” error validation (see section 5.1.2) is two seconds. This time can be increased to three, four, or five seconds by placing switch configuration switches 1, 2, or 3 into the ON position. If all three switches are in the OFF position then no time is added to the default timing of two seconds. Each switch turned to the ON position adds one second to the default timing. For example, if switches 1 and 2 are set to the ON position then the “seat bounce” error validation timing is set to four seconds (two default seconds plus two added seconds).

##### 4.2.3. “Leaning in seat” and “seat and belt tie” error validation

*Software versions 1.3 and later.*

Switch configuration switch 4 sets the “leaning in seat” and “seat and belt tie” error validation. Set the switch to the OFF position to configure a **tight** error validation or set the switch to ON to configure a **loose** error validation.

##### Leaning in seat error validation

The system will set an error condition (red) when the seat and belt were previously cycled correctly, but now the seat switch has been de-activated for longer than the “seat bounce” timing (2-5 seconds).

 607 NW 27th Ave Ocala, FL 34475 Ph: 352-629-5020 or 1-800-533-3569 Fax : 352-629-290 or 1-800-520-3473	<b>PRODUCT MANUAL</b>			<b>PAGE</b>	<b>7 OF 26</b>	
	<b>PRODUCT GROUP</b>	<b>ES-Key</b>	<b>P/N</b>	<b>119914, 118093, 118620, 118551, 119375</b>	<b>DATE</b>	10/17/2011
	<b>PRODUCT</b>	<b>Vehicle Data Recorder and Seat Belt Warning system</b>			<b>REV</b>	1.70
					<b>BY</b>	<b>AMS</b>

**Tight error validation:** The seat position will remain in an error condition (red) even when the seat switch is reactivated. This error validation reduces the risks associated with occupants attempting to subvert the system by connecting the belt behind their bodies.

**Loose error validation:** The seat position will return to a valid seat/belt indication (green) when the seat switch is reactivated. This error validation allows the occupant to lean in the seat (seat switch deactivated) for longer than the “seat bounce” timing without maintaining an error condition when the seat switch is reactivated.

#### Seat and belt tie error validation

The system will set an error condition (red) when the seat and belt switches are activated at the same time.

**Tight error validation:** The system will set an error condition (red) when the seat and belt switches are activated at the same time. This error validation reduces the risks associated with occupants attempting to subvert the system by connecting the belt behind their bodies prior to the system power being applied (applicable only when the system is not continuously powered).

**Loose error validation:** The system will set a valid seat/belt indication (green) when the seat and belt switches are activated at the same time. This error validation allows an occupant to be seated and belted properly prior to the driver applying vehicle power while still maintaining a valid indication.

#### **4.2.4. Address configuration**

The Seat Belt Warning input module can be set to address 1 (default) or address 2. This allows two Seat Belt Warning input modules to be used in applications where up to 20 seat/belt positions are required. Place the address configuration jumper into the desired position (1 or 2).

- The Seat Belt Warning display (small – p/n 118620) can display the seat status from two Seat Belt Warning input modules (up to twenty seats).
- Two Seat Belt Warning displays (large – p/n 118551) must be used to display the seat status from two Seat Belt Warning input modules (up to twenty seats).



 607 NW 27th Ave Ocala, FL 34475 Ph: 352-629-5020 or 1-800-533-3569 Fax : 352-629-290 or 1-800-520-3473	<b>PRODUCT MANUAL</b>			<b>PAGE</b>	<b>8 OF 26</b>	
	<b>PRODUCT GROUP</b>	<b>ES-Key</b>	<b>P/N</b>	<b>119914, 118093, 118620, 118551, 119375</b>	<b>DATE</b>	10/17/2011
	<b>PRODUCT</b>	<b>Vehicle Data Recorder and Seat Belt Warning system</b>			<b>REV</b>	1.70
				<b>BY</b>	<b>AMS</b>	

**4.3. Seat Belt Warning display (large – p/n 118551, p/n 119375)**

The Seat Belt Warning display (p/n 118551, p/n 119375) may be configured for a desired layout of the physical seat locations on the display (five different layouts) and the display's address (address 1 or address 2) by selecting a position on the configuration switch.

Remove the rubber plug from the rear of the Seat Belt Warning display to gain access to the configuration switch (replace the rubber plug after setting the position of the switch).

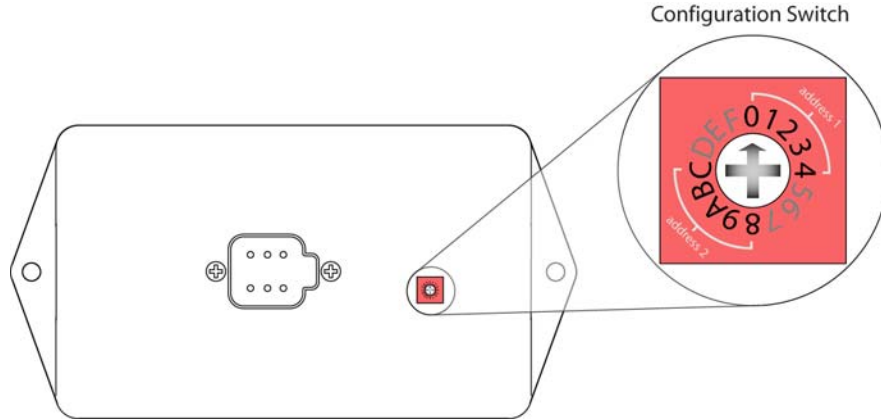

**4.3.1. Seat belt display indicator position and address configuration**

Configuration Switch positions 0, 1, 2, 3, and 4 set the Seat Belt Warning display to address 1 (which receives seat belt data from a Seat Belt Warning input module set to address 1) and sets the seat belt display indicator positions to one of the five (5) available.

Configuration Switch positions 8, 9, A, B, and C set the Seat Belt Warning display to address 2 (which receives seat belt data from a Seat Belt Warning input module set to address 2) and sets the seat belt display indicator positions to one of the five (5) available.

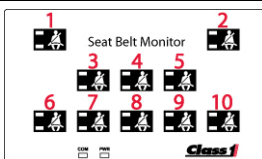
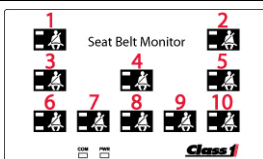
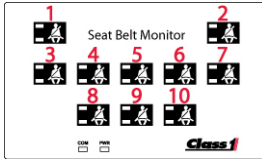
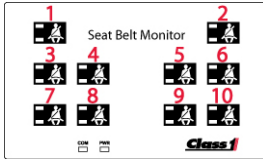
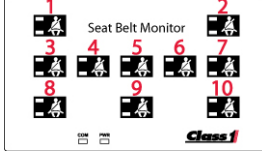
Configuration Switch position	Seat Belt Display indicator positions	Configuration Switch position	Seat Belt Display indicator positions
0 = address 1 or 8 = address 2		3 = address 1 or B = address 2	
1 = address 1 or 9 = address 2		4 = address 1 or C = address 2	
2 = address 1 or A = address 2			

The Seat Belt Display indicator positions directly correlate to the physical inputs of the address associated Seat Belt Warning input module.

**4.3.2. Blanking labels**

A set of blanking labels (p/n 119340) are included with the large display (p/n 118551 and p/n 119375) so that unused seating positions may be covered if desired.

 607 NW 27th Ave Ocala, FL 34475 Ph: 352-629-5020 or 1-800-533-3569 Fax: 352-629-290 or 1-800-520-3473	<b>PRODUCT MANUAL</b>			<b>PAGE</b>	<b>9 OF 26</b>	
	<b>PRODUCT GROUP</b>	<b>ES-Key</b>	<b>P/N</b>	<b>119914, 118093, 118620, 118551, 119375</b>	<b>DATE</b>	10/17/2011
	<b>PRODUCT</b>	<b>Vehicle Data Recorder and Seat Belt Warning system</b>			<b>REV</b>	1.70
					<b>BY</b>	<b>AMS</b>

## 5. Operation

### 5.1. Seat and Seat Belt detection overview

The Seat Belt Warning system is designed to detect when a seat is occupied and when its associated seat belt is buckled correctly. The Seat Belt Warning system recognizes five (5) distinct seat/seat belt conditions: not occupied, occupied and buckled, seat belt violation, buckled and not occupied, and sequence violation.

The chart below describes the conditions with the associated alarm and indications.  
 (RED = negative indication, GRN = affirmative indication).

TYPE	CONDITION	DESCRIPTION	INDICATION		
			VDR ALARM	RED	GRN
Valid	Not occupied	Seat is NOT occupied and associated seat belt is NOT buckled.			
Valid	Occupied and buckled	Seat is occupied and THEN the associated seat belt is buckled.			●
Error	Seat belt violation	Seat is occupied BUT the associated seat belt is NOT buckled.	●	●	
Error	Buckled and not occupied	Seat belt is buckled BUT the associated seat is not occupied.		●	
Error	Sequence violation	Seat belt is buckled and THEN the associated seat is occupied.	●	●	

Note: The VDR alarm will only sound when the park brake input is not active (see section 5.4.1.A).



The Seat Belt Warning system is designed to detect safe and unsafe conditions for seated occupants, but the system cannot defend against tampering with the seat or seat belt switches, system modules, or intentional manipulation of the seat and seat belt activations to circumvent safe operation. Class 1 cannot be held responsible in these circumstances.

#### 5.1.1. Sequence violation during power on cycle

The Seat Belt Warning input module (p/n 118093) will indicate a *sequence violation* for a seat position if the seat is occupied and buckled before the input module power on cycle. This is due to the fact that the Seat Belt Warning input module cannot determine the order of seat/seat belt activation and therefore assumes the worst case scenario (seat belt was pre-buckled and occupant sits on top of seat belt).

This potential scenario can be eliminated by keeping the Seat Belt Warning input module powered continuously (see section 10.1 for current draw) **OR** by configuring the system for *loose error validation* (see section 4.2.3).

#### 5.1.2. “Seat bounce” error validation

The seat inputs of the Seat Belt Warning input module (p/n 118093) have a special two to five second bounce timer which is designed to prevent the system from reporting a *buckled and not occupied* error when a buckled occupant removes pressure from the seat’s occupant detection switch which could easily happen if an occupant adjusts their body or the vehicle encounters a bump during operation.

The system will report a *buckled and not occupied* error if a buckled occupant removes pressure from the seat’s occupant detection switch for longer than the configured “seat bounce” error validation time (see section 4.2.2).

The system can be configured to report *occupied and buckled* (green) **OR** *sequence error* (red) when the occupant again sits and activates the seat switch (see section 4.2.3).

 607 NW 27th Ave Ocala, FL 34475 Ph: 352-629-5020 or 1-800-533-3569 Fax : 352-629-290 or 1-800-520-3473	<b>PRODUCT MANUAL</b>			<b>PAGE</b>	<b>10 OF 26</b>	
	<b>PRODUCT GROUP</b>	<b>ES-Key</b>	<b>P/N</b>	<b>119914, 118093, 118620, 118551, 119375</b>	<b>DATE</b>	10/17/2011
	<b>PRODUCT</b>	<b>Vehicle Data Recorder and Seat Belt Warning system</b>			<b>REV</b>	1.70
					<b>BY</b>	<b>AMS</b>

## 5.2. Seat Belt Warning display (small – p/n 118620)

The Seat Belt Warning display (p/n 118620) is capable of showing the seat status of up to 20 seats with its position indicator and seat belt warning icon.

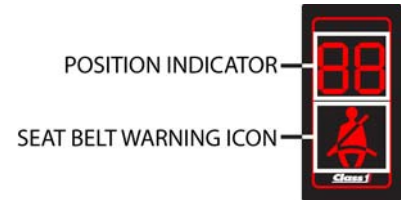

### 5.2.1. Display initialization

The Seat Belt Warning display performs a visual initialization cycle during the first three (3) seconds after a new power cycle. This initialization should be used to verify that the display's warning indicators are functioning properly.



The display shows "88" and the seat belt warning icon is red during the first second after a power cycle.



The display shows "88" and the seat belt warning icon is green during the next (2<sup>nd</sup>) second after a power cycle.



The display shows a normal operating indication after the last (3<sup>rd</sup>) second after a power cycle.

### 5.2.2. Operating indications

The Seat Belt Warning display indicates the status of the seat and seat belt inputs based on communication messages from the Seat Belt Warning input module (p/n 118093).



The Seat Belt Warning display position indicator and seat belt warning icon will remain dark when no seats are occupied and no seat belts are buckled.



The Seat Belt Warning display will light the seat belt warning icon green when all occupied seats are buckled properly.



The Seat Belt Warning display will indicate a position number and light the seat belt warning icon red when an occupied seat has a seat belt violation or seat belt sequence error. When more than one seat has a seat belt violation or seat belt sequence error the position indicator will cycle through the seat positions in violation/error.

 607 NW 27th Ave Ocala, FL 34475 Ph: 352-629-5020 or 1-800-533-3569 Fax : 352-629-290 or 1-800-520-3473	<b>PRODUCT MANUAL</b>			<b>PAGE</b>	11 OF 26	
	<b>PRODUCT GROUP</b>	ES-Key	<b>P/N</b>	119914, 118093, 118620, 118551, 119375	<b>DATE</b>	10/17/2011
	<b>PRODUCT</b>	Vehicle Data Recorder and Seat Belt Warning system			<b>REV</b>	1.70
					<b>BY</b>	AMS

### 5.2.3. Communication error indication



The Seat Belt Warning display position indicator shows dashes and the seat belt warning icon flashes red when communication messages are not received from the Seat Belt Warning input module (see section 7 for troubleshooting).

### 5.3. Seat Belt Warning display (large – p/n 118551, p/n 119375)

The Seat Belt Warning display (p/n 118551) is capable of showing the seat status of up to 10 seats with individual (red and green) seat status LEDs.

The Seat Belt Warning display (p/n 119375) is capable of showing the seat status of up to 6 seats with individual (red and green) seat status LEDs.

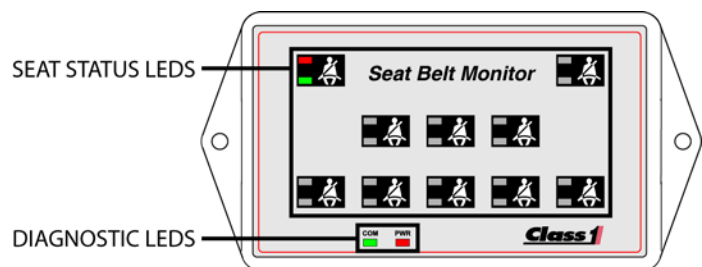

#### 5.3.1. Display initialization

The Seat Belt Warning display performs a visual initialization cycle during the first three (3) seconds after a new power cycle. This initialization should be used to verify that the display's LEDs are functioning properly.

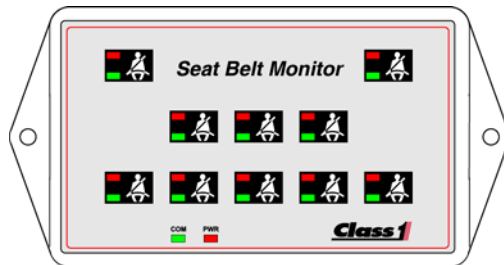

The display activates all seat status LEDs during the first 3 seconds after a power cycle.

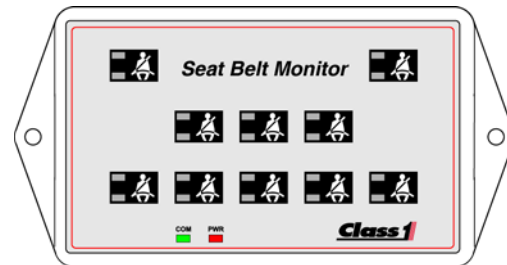

The display then shows a normal operating indication.

#### 5.3.2. Operating indications

The Seat Belt Warning display indicates the status of the seat and seat belt inputs based on communication messages from the Seat Belt Warning input module (p/n 118093).



The seat status LEDs will remain dark when a seat is not occupied and the associated seat belt is not buckled.



The green seat status LED will light when a seat is occupied and its associated seat belt is buckled properly.



The red seat status LED will light when a seat is occupied and has a seat belt violation or has a seat belt sequence error.

 607 NW 27th Ave Ocala, FL 34475 Ph: 352-629-5020 or 1-800-533-3569 Fax : 352-629-290 or 1-800-520-3473	<b>PRODUCT MANUAL</b>			<b>PAGE</b>	<b>12 OF 26</b>	
	<b>PRODUCT GROUP</b>	<b>ES-Key</b>	<b>P/N</b>	<b>119914, 118093, 118620, 118551, 119375</b>	<b>DATE</b>	10/17/2011
	<b>PRODUCT</b>	<b>Vehicle Data Recorder and Seat Belt Warning system</b>			<b>REV</b>	1.70
					<b>BY</b>	<b>AMS</b>

### 5.3.3. Diagnostic indications

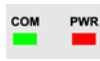

The green COM diagnostic LED will be lit when communication messages are properly received from the Seat Belt Warning input module.

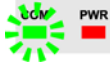

The green COM diagnostic LED will flash slowly (once per second) when communication messages are not received from the Seat Belt Warning input module.

Verify matching addresses of the Seat Belt Warning display (section 4.3.1) and the Seat Belt Warning input module (section 4.2.4). Verify that the Seat Belt Warning input module is properly connected to the CAN bus.

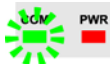

The green COM diagnostic LED will flash quickly (five times per second) when there is a passive communication error.

Verify that terminating resistor(s) are installed, verify the connection to the CAN bus is properly connected, etc.

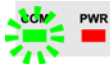

The green COM diagnostic LED will double flash (every two seconds) when there is an active communication error.

Verify that CAN H and CAN L are not shorted together or to ground or power, etc.



The green COM diagnostic LED and the red PWR diagnostic LED will be OFF if there is a problem with the main display power.

Verify that power is connected properly to the display (pin 1 – power, pin 2 – ground).

 607 NW 27th Ave Ocala, FL 34475 Ph: 352-629-5020 or 1-800-533-3569 Fax : 352-629-290 or 1-800-520-3473	<b>PRODUCT MANUAL</b>			<b>PAGE</b>	<b>13 OF 26</b>	
	<b>PRODUCT GROUP</b>	<b>ES-Key</b>	<b>P/N</b>	<b>119914, 118093, 118620, 118551, 119375</b>	<b>DATE</b>	<b>10/17/2011</b>
	<b>PRODUCT</b>	<b>Vehicle Data Recorder and Seat Belt Warning system</b>			<b>REV</b>	<b>1.70</b>
					<b>BY</b>	<b>AMS</b>

#### 5.4. Vehicle Data Recorder (p/n 119914)

The Vehicle Data Recorder saves a continuous loop of 100 engine hours of second-by-second time and date stamped data as directed by NFPA.

- Vehicle speed (SAE CAN message)
- Engine RPM (SAE CAN message)
- Throttle position (SAE CAN message)
- Vehicle acceleration (derived from vehicle speed)
- Vehicle deceleration (derived from vehicle speed)
- ABS events (SAE CAN message)
- Master warning input (physical input – pin 8)
- Park brake input (physical input – pin 5)
- Seat and seat belt status (Seat belt warning CAN message)



The recorded data can be retrieved by using the VDR Management Software (see section 4.1.2).

##### 5.4.1. Alarm operation

An external alarm connected to the Vehicle Data Recorder is used to alert the vehicle operator to seat belt violations and Vehicle Data Recorder error conditions.

The VDR has two outputs for external alarm use and both are switched. Pin 7 is switched positive vehicle voltage and pin 6 is switched ground. The two outputs are activated simultaneously so any of the three alarm connection methods below may be used.

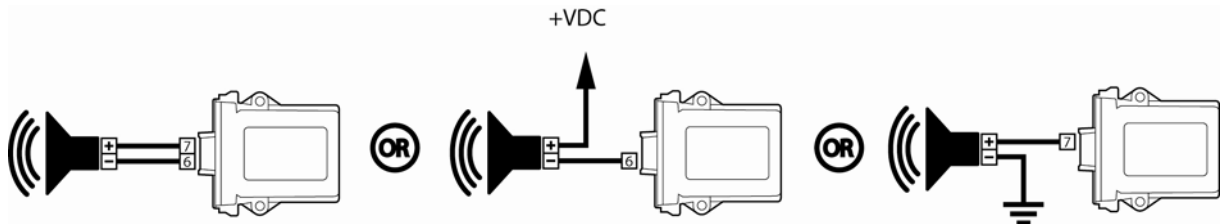

##### A. SEAT BELT VIOLATION ALARM

The Vehicle Data Recorder will beep the alarm at one second intervals when it receives a seat belt violation or sequence violation (see section 5.1) while the park brake input (pin 5) is turned OFF.

##### B. VDR ERROR CONDITION ALARM

The Vehicle Data Recorder will beep the alarm ten (10) times very quickly during a new power cycle to indicate that an internal error has been detected. The VDR will then pulse the alarm once, twice, or three times to indicate the specific error condition.

ALARM PULSES	ERROR	DESCRIPTION
1	Not receiving CAN messages.	The Seat Belt Warning CAN bus (pins 2, 11) or the Engine/Transmission CAN bus (pins 4, 9) may have a wiring problem. Use the VDR's diagnostic LEDs to determine which bus is causing the error condition (see section 5.4.2).
2	Internal memory read/write error.	The VDR is having difficulty reading or writing from memory and may not be able to record the required NFPA data.
3	Internal clock error.	The internal real time clock is not advancing and will cause time stamped data to be inaccurate.

 607 NW 27th Ave Ocala, FL 34475 Ph: 352-629-5020 or 1-800-533-3569 Fax : 352-629-290 or 1-800-520-3473	<b>PRODUCT MANUAL</b>			<b>PAGE</b>	<b>14 OF 26</b>	
	<b>PRODUCT GROUP</b>	<b>ES-Key</b>	<b>P/N</b>	<b>119914, 118093, 118620, 118551, 119375</b>	<b>DATE</b>	10/17/2011
	<b>PRODUCT</b>	<b>Vehicle Data Recorder and Seat Belt Warning system</b>			<b>REV</b>	1.70
					<b>BY</b>	<b>AMS</b>

#### 5.4.2. Diagnostic LEDs

The Vehicle Data Recorder has 5 LEDs which are intended for quick diagnostic evaluation and are viewable through the amber enclosure.

**PWR** – red LED is ON when the VDR module has proper voltage after the internal fuse.

**BUS** – yellow LED is on when the VDR module has proper voltage at the connector (pins 1, and 12 – see section 9.4).

**COM1** – green LED is ON solid when CAN communication is good with the Seat Belt Warning system.

**COM2** – green LED is ON solid when CAN communication is good with the engine/transmission system.

**USB** – green LED is ON solid when the VDR module has made a valid connection to the host computer running the VDR Management software.

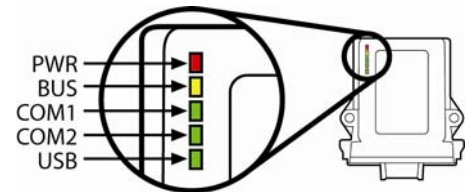

The CAN communication LEDs (COM1, COM2) will flash to indicate an error.

- Slow flash (once per second) indicates that the CAN bus is good but the VDR is not receiving messages from the Seat Belt Warning system.
- Fast flash (five times per second) indicates that there is an issue with the CAN bus. Verify that terminating resistor(s) are installed, verify the connection to the CAN bus is properly connected, verify that CAN H and CAN L are not shorted together or to ground or power, etc.

#### 5.4.3. OEM responsibility

The Vehicle Data Recorder must be properly powered and connected to the associated CAN buses to record NFPA data correctly. It is the OEM's responsibility to ensure that the VDR is connected properly and the potential for tampering is minimized.

 607 NW 27th Ave Ocala, FL 34475 Ph: 352-629-5020 or 1-800-533-3569 Fax : 352-629-290 or 1-800-520-3473	<b>PRODUCT MANUAL</b>			<b>PAGE</b>	<b>15 OF 26</b>	
	<b>PRODUCT GROUP</b>	<b>ES-Key</b>	<b>P/N</b>	<b>119914, 118093, 118620, 118551, 119375</b>	<b>DATE</b>	10/17/2011
	<b>PRODUCT</b>	<b>Vehicle Data Recorder and Seat Belt Warning system</b>			<b>REV</b>	1.70
					<b>BY</b>	<b>AMS</b>

## 5.5. Seat Belt Warning input module (p/n 118093)

The Seat Belt Warning input module (p/n 118093) monitors the status of 10 seats and 10 seat belts for use in determining seat and seat belt status and transmitting the results to the Seat Belt Warning display and Vehicle Data Recorder.

The Seat Belt Warning input module transmits four ES-Key network tags based on seat and seat belt combinations that may be used within an ES-Key network database for alarm purposes.



### 5.5.1. Network alarm tags

The Seat Belt Warning input module is recognized as an *input module* within the ES-Key network database. The address is determined by the Seat Belt Warning input module's address jumper position (see section 4.2.4). The address is 14 when the jumper is in position 1, and 15 when the jumper is in position 2.

INPUT SPACE	CONDITION	DESCRIPTION
24	Buckled but occupant is leaning	This input is ACTIVE when a seat position was occupied and buckled correctly, but currently the seat switch is not activated.
25	Seat belt violation	This input is ACTIVE when a seat is occupied BUT the associated seat belt is NOT buckled.
26	Buckled and not occupied	This input is ACTIVE when a seat belt is buckled BUT the associated seat is not occupied.
27	Sequence violation	This input is ACTIVE when a seat belt is buckled and THEN the associated seat is occupied.

### 5.5.2. Diagnostic LEDs

The Seat Belt Warning input module has 3 LEDs which are intended for quick diagnostic evaluation and are viewable through the amber enclosure.

**PWR** – red LED is ON when the VDR module has proper voltage after the internal fuse.

**BUS** – yellow LED is on when the VDR module has proper voltage at the gray connector (power stud, and pin 12 – see section 9.1).

**COM** – green LED is ON solid when CAN communication is good with a Seat Belt Warning display.

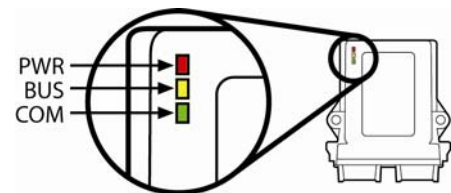

The CAN communication LED (COM) will flash to indicate an error.

- Slow flash (once per second) indicates that the CAN bus is good but the Seat Belt Warning input module is not receiving messages from the Seat Belt Warning display.
- Fast flash (five times per second) indicates that there is a passive CAN bus communication error. Verify that terminating resistor(s) are installed, verify the connection to the CAN bus is properly connected, etc.
- Double flash (every two seconds) indicates that there is an active CAN bus communication error. Verify that CAN H and CAN L are not shorted together or to ground or power, etc.



 607 NW 27th Ave Ocala, FL 34475 Ph: 352-629-5020 or 1-800-533-3569 Fax : 352-629-290 or 1-800-520-3473	<b>PRODUCT MANUAL</b>			<b>PAGE</b>	<b>16 OF 26</b>	
	<b>PRODUCT GROUP</b>	<b>ES-Key</b>	<b>P/N</b>	<b>119914, 118093, 118620, 118551, 119375</b>	<b>DATE</b>	<b>10/17/2011</b>
	<b>PRODUCT</b>	<b>Vehicle Data Recorder and Seat Belt Warning system</b>			<b>REV</b>	<b>1.70</b>
				<b>BY</b>	<b>AMS</b>	

## 6. Application

### 6.1. Typical VDR system

The illustration below shows a typical VDR system utilizing the Vehicle Data Recorder and Seat Belt Warning modules.

Not all modules are required to comprise a system. The Vehicle Data Recorder module may be omitted if only the Seat Belt Warning system is desired and vice-versa.

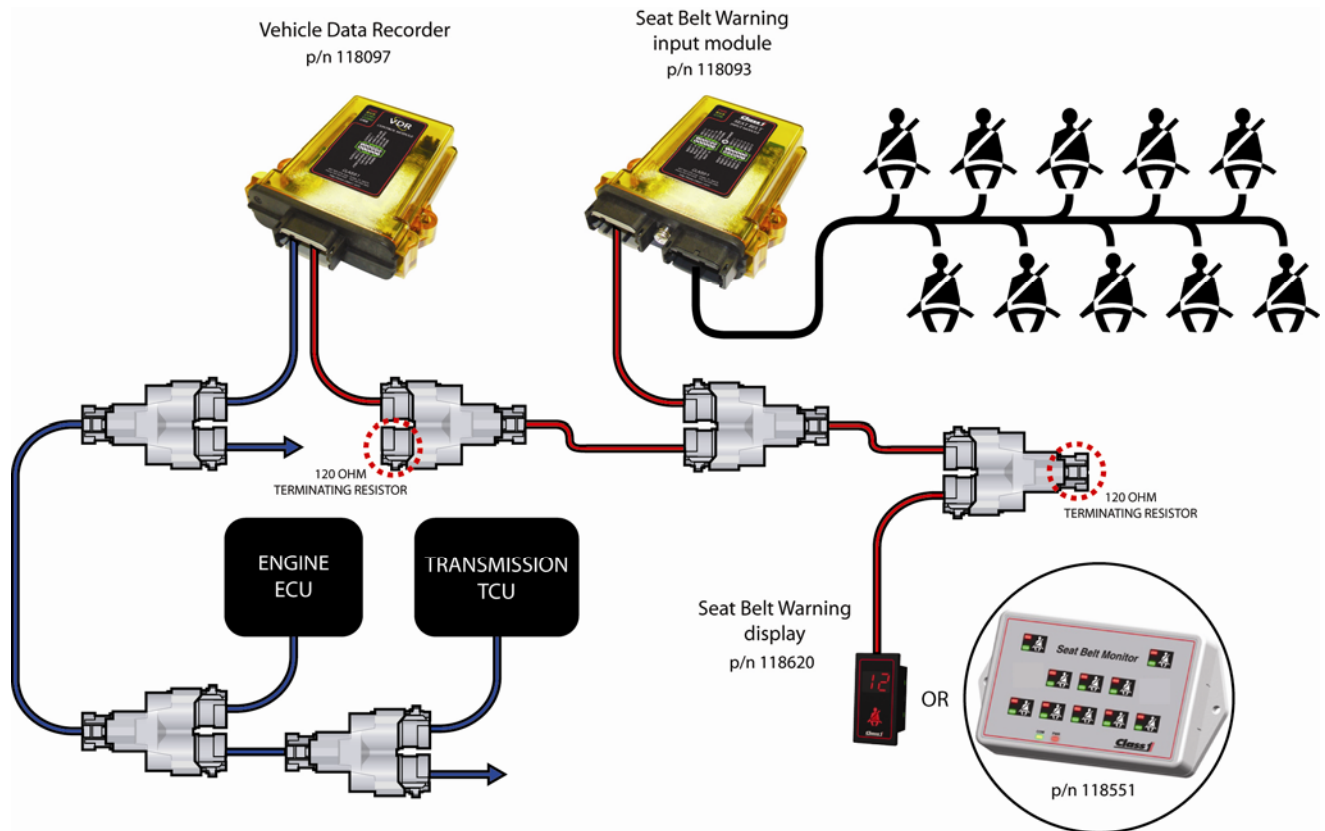

*Note: Proper CAN bus termination is required. The seat belt warning CAN bus should have a 120 Ohm terminating resistor located at its ends (2 resistors per bus).*

#### 6.1.1. Number of seats permitted

The Seat Belt Warning Input module (p/n 118093) can support up to 10 seats. If more seats (up to 20) are required then a second Seat Belt Warning Input module must be installed and addressed correctly (see section 4.2.4).

The Seat Belt Warning display (p/n 118551) can support up to 10 seats (p/n 119375 can support up to 6 seats). If more seats (up to 20) are required then a second Seat Belt Warning display must be installed and addressed correctly (see section 4.2.4).

A single Seat Belt Warning display (p/n 118620) can support up to 20 seats.

 607 NW 27th Ave Ocala, FL 34475 Ph: 352-629-5020 or 1-800-533-3569 Fax : 352-629-290 or 1-800-520-3473	<b>PRODUCT MANUAL</b>			<b>PAGE</b>	<b>17 OF 26</b>	
	<b>PRODUCT GROUP</b>	<b>ES-Key</b>	<b>P/N</b>	<b>119914, 118093, 118620, 118551, 119375</b>	<b>DATE</b>	10/17/2011
	<b>PRODUCT</b>	<b>Vehicle Data Recorder and Seat Belt Warning system</b>			<b>REV</b>	1.70
					<b>BY</b>	<b>AMS</b>

## 7. Troubleshooting

<b>PROBLEM</b>	<b>LIKELY CAUSES</b>	<b>WHAT TO DO</b>
Seat Belt Warning display shows warning even when associated seat isn't occupied and associated seat belt isn't buckled.	Associated seat input is active <b>OR</b> Associated seat belt input is active <b>OR</b> Associated seat input configuration switch is set incorrectly <b>OR</b> Associated seat belt input configuration switch is set incorrectly.	Verify seat and seat belt input configuration switch settings in the Seat Belt Warning input module (see section 4.2.1). Verify seat and seat belt input pins on Seat Belt Warning input module (p/n 118093) for proper polarity and continuity (see section 9.1). Verify proper operation of OEM seat and seat belt switches.
Seat Belt Warning display shows warning when occupant is properly seated and buckled.	Associated seat input is not active <b>OR</b> Associated seat belt input is not active <b>OR</b> Associated seat input configuration switch is set incorrectly <b>OR</b> Associated seat belt input configuration switch is set incorrectly <b>OR</b> Occupant was seated and buckled prior to power activation of the Seat Belt Warning input module (p/n 118093).	Verify seat and seat belt input configuration switch settings in the Seat Belt Warning input module (see section 4.2.1). Verify seat and seat belt input pins on Seat Belt Warning input module (p/n 118093) for proper polarity and continuity (see section 9.1). Verify proper operation of OEM seat and seat belt switches. Make certain that power is applied to the Seat Belt Warning input module (p/n 118093) prior to occupant seating.
Seat Belt Warning display does not show warning when occupant is seated while not buckled.	Associated seat input is not active <b>OR</b> Associated seat input configuration switch is set incorrectly.	Verify seat input configuration switch settings in the Seat Belt Warning input module (see section 4.2.1). Verify seat input pins on Seat Belt Warning input module (p/n 118093) for proper polarity and continuity (see section 9.1). Verify proper operation of OEM seat and seat belt switches.
Small Seat Belt Warning display (p/n 118620) shows incorrect seat warning.	Seat Belt Warning input module (p/n 118093) may be addressed incorrectly. When the address is incorrectly selected the displayed seat error will be either 10 +/- the actual seat. For example, if the warning should be seat 2 but seat 12 is displayed then the Seat Belt Warning input module's address is set to "2" when it should be set to "1" <b>OR</b> The seat input or seat belt input is connected to the wrong pin of the Seat Belt Warning input module. For example, if the warning should be seat 2 but seat 6 is displayed.	Verify the address setting in the Seat Belt Warning input module (see section 4.2.4). Verify that the correct seat/seat belt input is being used in the connector of the Seat Belt Warning input module (see section 9.1).
Small Seat Belt Warning display (p/n 118620) shows dashes and the warning icon is flashing red.	The Seat Belt Warning display is not properly connected to the CAN bus <b>OR</b> The Seat Belt Warning input module is not properly connected to the CAN bus or is not powered.	Verify the display's CAN connection to the CAN bus (see section 9.2). Verify that the Seat Belt Warning input module is powered and properly connected to the CAN bus (see section 9.1).

 607 NW 27th Ave Ocala, FL 34475 Ph: 352-629-5020 or 1-800-533-3569 Fax : 352-629-290 or 1-800-520-3473	<b>PRODUCT MANUAL</b>			<b>PAGE</b>	<b>18 OF 26</b>	
	<b>PRODUCT GROUP</b>	<b>ES-Key</b>	<b>P/N</b>	<b>119914, 118093, 118620, 118551, 119375</b>	<b>DATE</b>	10/17/2011
	<b>PRODUCT</b>	<b>Vehicle Data Recorder and Seat Belt Warning system</b>			<b>REV</b>	1.70
					<b>BY</b>	<b>AMS</b>

<b>PROBLEM</b>	<b>LIKELY CAUSES</b>	<b>WHAT TO DO</b>
Large Seat Belt Warning display (p/n 118551, p/n 119375) does not show warnings and the green COM LED flashes.	Seat Belt Warning display is addressed incorrectly. The display's address should match that of the Seat Belt Warning input module <b>OR</b> The Seat Belt Warning display is not properly connected to the CAN bus <b>OR</b> The Seat Belt Warning input module is not properly connected to the CAN bus or is not powered.	Verify the address setting in the Seat Belt Warning display (see section 4.3.1). Verify the type of COM LED flash (see section 5.3.3) and verify the probable CAN bus error. Verify that the Seat Belt Warning input module is powered and properly connected to the CAN bus (see section 9.1).
The audible warning alarm sounds for active violations when the parking brake is applied.	The park brake input to the Vehicle Data Recorder's pin 5 is not active <b>OR</b> The park brake input to the Vehicle Data Recorder's pin 5 is the wrong polarity <b>OR</b> The OEM parking brake switch is not functioning.	Verify the continuity from the park brake switch to pin 5 of the VDR module. Verify that the input from the park brake is a ground polarity signal. Verify operation of the OEM park brake switch.
The audible warning alarm never sounds even when the Seat Belt Warning display shows active violations.	The park brake input to the Vehicle Data Recorder's pin 5 is always active. The Vehicle Data Recorder is not powered.	Verify the input to pin 5 of the VDR module is not shorted to ground. Verify operation of the OEM park brake switch. Verify that the Vehicle Data Recorder is powered. Use on board diagnostic LEDs (see section 5.4.2).
Master warning switch activations never recognized (per VDR Management software report).	The master warning input to the Vehicle Data Recorder's pin 8 is not active <b>OR</b> The master warning input to the Vehicle Data Recorder's pin 8 is the wrong polarity <b>OR</b> The OEM master warning switch is not functioning.	Verify the continuity from the master warning switch to pin 8 of the VDR module. Verify that the input from the master warning switch is a positive polarity signal of at least 70% of system voltage. For example, if the system voltage is 13.8V then the voltage to the input should be 9.6V or greater. Verify operation of the OEM master warning switch.
Master warning switch is always active (per VDR Management software report).	The master warning input to the Vehicle Data Recorder's pin 8 is always active.	Verify the input to pin 8 of the VDR module is not shorted to positive voltage. Verify operation of the OEM master warning switch.

 607 NW 27th Ave Ocala, FL 34475 Ph: 352-629-5020 or 1-800-533-3569 Fax : 352-629-290 or 1-800-520-3473	<b>PRODUCT MANUAL</b>			<b>PAGE</b>	<b>19 OF 26</b>	
	<b>PRODUCT GROUP</b>	<b>ES-Key</b>	<b>P/N</b>	<b>119914, 118093, 118620, 118551, 119375</b>	<b>DATE</b>	<b>10/17/2011</b>
	<b>PRODUCT</b>	<b>Vehicle Data Recorder and Seat Belt Warning system</b>			<b>REV</b>	<b>1.70</b>
					<b>BY</b>	<b>AMS</b>

## 8. Dimensions and Installation

### 8.1. Seat Belt Warning Input Module (p/n 118093) dimensions

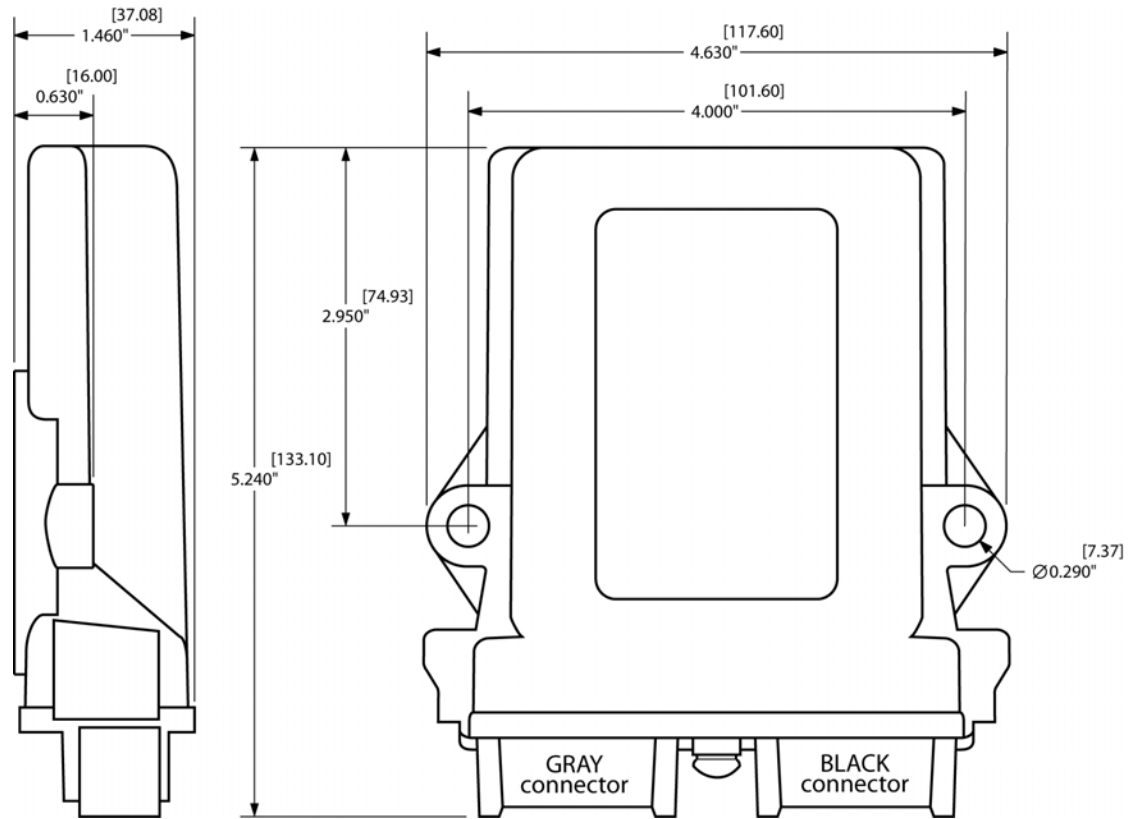

**DIMENSIONS IN INCHES [MILLIMETERS]**

 607 NW 27th Ave Ocala, FL 34475 Ph: 352-629-5020 or 1-800-533-3569 Fax : 352-629-290 or 1-800-520-3473	<b>PRODUCT MANUAL</b>			<b>PAGE</b>	<b>20 OF 26</b>	
	<b>PRODUCT GROUP</b>	<b>ES-Key</b>	<b>P/N</b>	<b>119914, 118093, 118620, 118551, 119375</b>	<b>DATE</b>	<b>10/17/2011</b>
	<b>PRODUCT</b>	<b>Vehicle Data Recorder and Seat Belt Warning system</b>			<b>REV</b>	<b>1.70</b>
					<b>BY</b>	<b>AMS</b>

**8.2. Seat Belt Warning Display (small – p/n 118620) dimensions**

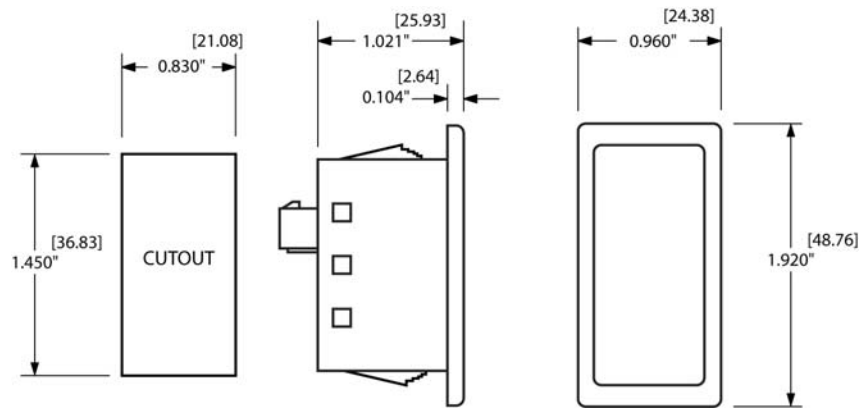

**DIMENSIONS IN INCHES [MILLIMETERS]**

**8.3. Seat Belt Warning Display (large – p/n 118551, p/n 119375) dimensions**

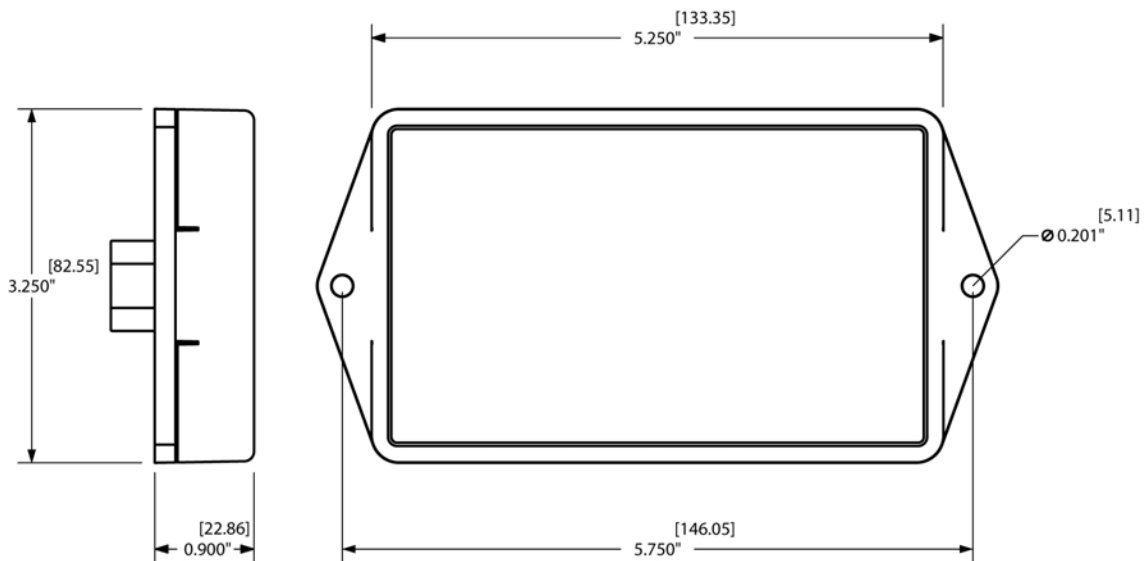

**DIMENSIONS IN INCHES [MILLIMETERS]**

 607 NW 27th Ave Ocala, FL 34475 Ph: 352-629-5020 or 1-800-533-3569 Fax : 352-629-290 or 1-800-520-3473	<b>PRODUCT MANUAL</b>			<b>PAGE</b>	<b>21 OF 26</b>	
	<b>PRODUCT GROUP</b>	<b>ES-Key</b>	<b>P/N</b>	<b>119914, 118093, 118620, 118551, 119375</b>	<b>DATE</b>	<b>10/17/2011</b>
	<b>PRODUCT</b>	<b>Vehicle Data Recorder and Seat Belt Warning system</b>			<b>REV</b>	<b>1.70</b>
				<b>BY</b>	<b>AMS</b>	

**8.4. Vehicle Data Recorder (p/n 119914) dimensions**

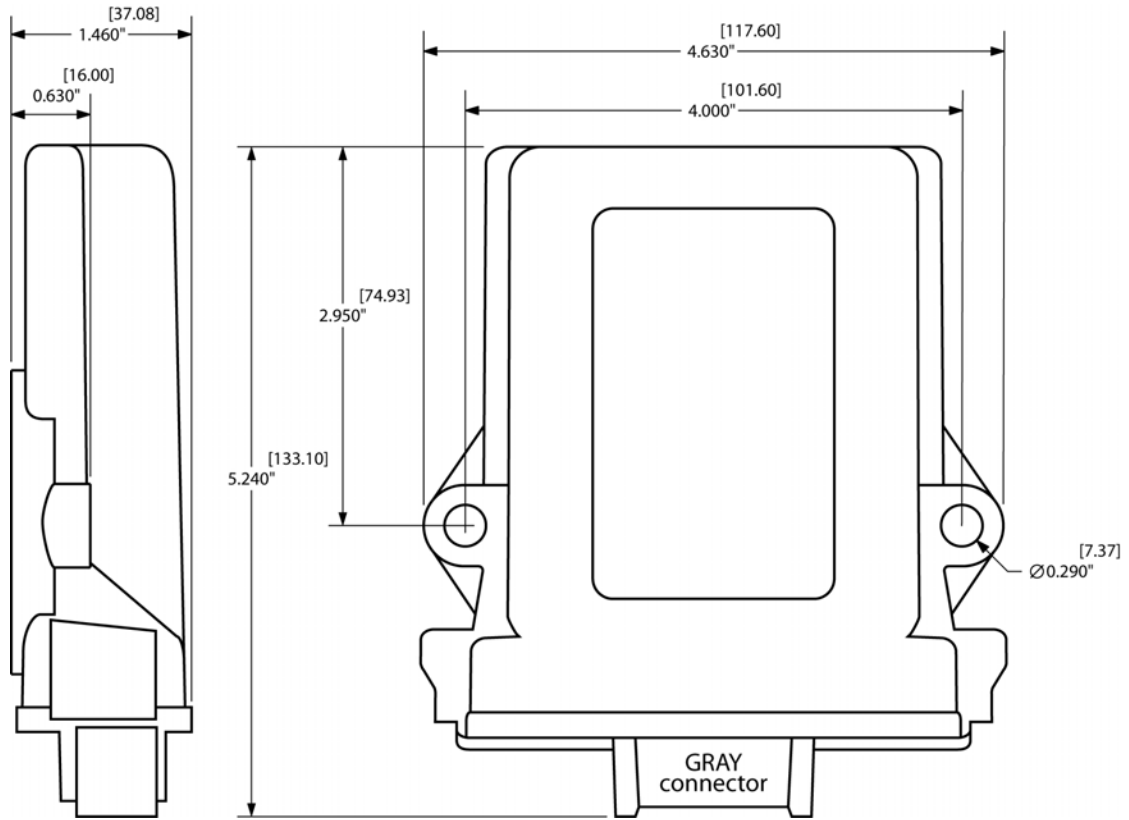

**DIMENSIONS IN INCHES [MILLIMETERS]**

 607 NW 27th Ave Ocala, FL 34475 Ph: 352-629-5020 or 1-800-533-3569 Fax : 352-629-290 or 1-800-520-3473	<b>PRODUCT MANUAL</b>			<b>PAGE</b>	22 OF 26	
	<b>PRODUCT GROUP</b>	ES-Key	<b>P/N</b>	119914, 118093, 118620, 118551, 119375	<b>DATE</b>	10/17/2011
	<b>PRODUCT</b>	Vehicle Data Recorder and Seat Belt Warning system			<b>REV</b>	1.70
					<b>BY</b>	AMS

## 9. Connector Description

### 9.1. Seat Belt Warning Input module (p/n 118093)

**Mating connector:** Deutsch DTM06-12SA GRAY  
**Mating sockets:** 0462-201-20141 (nickel)  
 0462-201-2031 (gold) recommended for CAN  
**Wedge lock:** W12S Recommended wire gage: 20-24 AWG

PIN	CIRCUIT	DESCRIPTION
1	SEAT 10	(INPUT) – Seat input (ground polarity)
2	CAN HIGH	(DATA) – Seatbelt CAN data, 250Kbits/s
3	CAN SHIELD	(DATA) – Seatbelt CAN data, 250Kbits /s
4	SEAT 9	(INPUT) – Seat input (ground polarity)
5	SEAT 8	(INPUT) – Seat input (ground polarity)
6	SEAT 7	(INPUT) – Seat input (ground polarity)
7	BELT 7	(INPUT) – Belt input (ground polarity)
8	BELT 8	(INPUT) – Belt input (ground polarity)
9	BELT 9	(INPUT) – Belt input (ground polarity)
10	BELT 10	(INPUT) – Belt input (ground polarity)
11	CAN LOW	(DATA) – Seatbelt CAN data, 250Kbits /s
12	SUPPLY (-)	(INPUT) – Battery ground

**Recommended ring terminal: #10**  
**Recommended wire gage: 12-18 AWG**

PIN	CIRCUIT	DESCRIPTION
STUD	SUPPLY (+)	(INPUT) – Battery voltage (+9VDC...+32VDC)

**Mating connector:** Deutsch DTM06-12SB BLACK  
**Mating sockets:** 0462-201-20141  
**Wedge lock:** W12S Recommended wire gage: 20-24 AWG

PIN	CIRCUIT	DESCRIPTION
1	BELT 1	(INPUT) – Belt input (ground polarity)
2	BELT 2	(INPUT) – Belt input (ground polarity)
3	BELT 3	(INPUT) – Belt input (ground polarity)
4	BELT 4	(INPUT) – Belt input (ground polarity)
5	BELT 5	(INPUT) – Belt input (ground polarity)
6	BELT 6	(INPUT) – Belt input (ground polarity)
7	SEAT 6	(INPUT) – Seat input (ground polarity)
8	SEAT 5	(INPUT) – Seat input (ground polarity)
9	SEAT 4	(INPUT) – Seat input (ground polarity)
10	SEAT 3	(INPUT) – Seat input (ground polarity)
11	SEAT 2	(INPUT) – Seat input (ground polarity)
12	SEAT 1	(INPUT) – Seat input (ground polarity)



 607 NW 27th Ave Ocala, FL 34475 Ph: 352-629-5020 or 1-800-533-3569 Fax : 352-629-290 or 1-800-520-3473	<b>PRODUCT MANUAL</b>			<b>PAGE</b>	23 OF 26	
	<b>PRODUCT GROUP</b>	ES-Key	<b>P/N</b>	119914, 118093, 118620, 118551, 119375	<b>DATE</b>	10/17/2011
	<b>PRODUCT</b>	Vehicle Data Recorder and Seat Belt Warning system			<b>REV</b>	1.70
					<b>BY</b>	AMS

## 9.2. Seat Belt Warning display (small – p/n 118620)

A pig tail harness is available from Class 1 (p/n 118420).

Mating connector: AMP 794617-6  
 Mating sockets: AMP 794610-1 (tin), 794610-3 (gold)  
 Recommended wire gage: 20-24 AWG

PIN	CIRCUIT	DESCRIPTION
1	SUPPLY (+)	(INPUT) – Battery voltage (+9VDC...+16VDC)
2	SUPPLY (-)	(INPUT) – Battery ground
3	----	Not used
4	CAN HIGH	(DATA) – Seatbelt CAN data, 250Kbits/s
5	CAN LOW	(DATA) – Seatbelt CAN data, 250Kbits /s
6	CAN SHIELD	(DATA) – Seatbelt CAN data, 250Kbits /s



## 9.3. Seat Belt Warning display (large – p/n 118551, p/n 119375)

Mating connector: Deutsch DT06-6S GRAY  
 Mating sockets: 0462-201-16141 (nickel)  
 0462-201-1631 (gold) recommended for CAN  
 Wedge lock: W6S Recommended wire gage: 16-20 AWG

PIN	CIRCUIT	DESCRIPTION
1	SUPPLY (+)	(INPUT) – Battery voltage (+9VDC...+32VDC)
2	SUPPLY (-)	(INPUT) – Battery ground
3	----	Not used
4	CAN HIGH	(DATA) – Seatbelt CAN data, 250Kbits/s
5	CAN LOW	(DATA) – Seatbelt CAN data, 250Kbits /s
6	CAN SHIELD	(DATA) – Seatbelt CAN data, 250Kbits /s



## 9.4. Vehicle Data Recorder (p/n 119914)

Mating connector: Deutsch DTM06-12SA GRAY  
 Mating sockets: 0462-201-20141 (nickel)  
 0462-201-2031 (gold) recommended for CAN  
 Wedge lock: W12S Recommended wire gage: 20-24 AWG

PIN	CIRCUIT	DESCRIPTION
1	SUPPLY (+)	(INPUT) – Battery voltage (+9VDC...+32VDC)
2	CAN HIGH	(DATA) – Seatbelt CAN data, 250Kbits/s
3	CAN SHIELD	(DATA) – Seatbelt CAN data, 250Kbits /s
4	CAN HIGH	(DATA) – VDR SAE J1939 CAN, 250Kbits/s
5	INPUT 2	(INPUT) – Park Brake, ground polarity
6	OUTPUT 2	(OUTPUT) – Alarm, ground polarity (switched, 0.25A)
7	OUTPUT 1	(OUTPUT) – Alarm, positive polarity (switched, 0.25A)
8	INPUT 1	(INPUT) – Master Warn, positive polarity
9	CAN LOW	(DATA) – VDR SAE J1939 CAN, 250Kbits /s
10	CAN SHIELD	(DATA) – VDR SAE J1939 CAN, 250Kbits /s
11	CAN LOW	(DATA) – Seatbelt CAN data, 250Kbits /s
12	SUPPLY (-)	(INPUT) – Battery ground





 607 NW 27th Ave Ocala, FL 34475 Ph: 352-629-5020 or 1-800-533-3569 Fax : 352-629-290 or 1-800-520-3473	<b>PRODUCT MANUAL</b>			<b>PAGE</b>	<b>24 OF 26</b>	
	<b>PRODUCT GROUP</b>	<b>ES-Key</b>	<b>P/N</b>	<b>119914, 118093, 118620, 118551, 119375</b>	<b>DATE</b>	10/17/2011
	<b>PRODUCT</b>	<b>Vehicle Data Recorder and Seat Belt Warning system</b>			<b>REV</b>	1.70
					<b>BY</b>	<b>AMS</b>

## 10. Operating Parameters

### 10.1. Seat Belt Warning input module (p/n 118093)

Product category	SAE J1939 CAN
Voltage range	+9VDC...+32VDC
Current draw (@ 13.8VDC)	32mA (no inputs active)
	34mA (2 inputs active)
	37mA (4 inputs active)
	40mA (6 inputs active)
	42mA (8 inputs active)
	44mA (10 inputs active)
	47mA (12 inputs active)
	50mA (14 inputs active)
	53mA (16 inputs active)
55mA (18 inputs active)	
57mA (all inputs active)	
Temperature range	-40°C...+85°C
Environmental range	IP 67
CAN specification	SAE J1939, 250 Kbits/second
Protection	Internal thermal fuse
	Reverse voltage protection (pins 1 and 12 of gray connector)
	CAN buses protected to 24V
	ESD voltage protected to SAE J1113 specification for heavy duty trucks
	Transient voltage protected to SAE J1113 specification for heavy duty trucks

### 10.2. Seat Belt Warning display (small – p/n 118620)

Product category	SAE J1939 CAN
Voltage range	+9VDC...+16VDC
Current draw (@ 13.8VDC)	57mA
Temperature range	-40°C...+85°C
Environmental range	IP 10
CAN specification	SAE J1939, 250 Kbits/second
Protection	Internal thermal fuse
	Reverse voltage protection (pins 1 and 2 of connector)
	CAN buses protected to 24V
	ESD voltage protected to SAE J1113 specification for heavy duty trucks

### 10.3. Seat Belt Warning display (large – p/n 118551, p/n 119375)

Product category	SAE J1939 CAN
Voltage range	+9VDC...+32VDC
Current draw (@ 13.8VDC)	25mA (no seat LEDs active)
	75mA (all green seat LEDs active)
Temperature range	-40°C...+85°C
Environmental range	IP 42
CAN specification	SAE J1939, 250 Kbits/second
Protection	Internal thermal fuse
	Reverse voltage protection (pins 1 and 2 of connector)
	CAN buses protected to 24V
	ESD voltage protected to SAE J1113 specification for heavy duty trucks
	Transient voltage protected to SAE J1113 specification for heavy duty trucks

 607 NW 27th Ave Ocala, FL 34475 Ph: 352-629-5020 or 1-800-533-3569 Fax : 352-629-290 or 1-800-520-3473	<b>PRODUCT MANUAL</b>			<b>PAGE</b>	<b>25 OF 26</b>	
	<b>PRODUCT GROUP</b>	<b>ES-Key</b>	<b>P/N</b>	<b>119914, 118093, 118620, 118551, 119375</b>	<b>DATE</b>	<b>10/17/2011</b>
	<b>PRODUCT</b>	<b>Vehicle Data Recorder and Seat Belt Warning system</b>			<b>REV</b>	<b>1.70</b>
					<b>BY</b>	<b>AMS</b>

#### 10.4. Vehicle Data Recorder (p/n 119914)

Product category	SAE J1939 CAN
Voltage range	+9VDC...+32VDC
Current draw (@ 13.8VDC)	78mA
Temperature range	-40°C...+85°C
Environmental range	IP 42
CAN specification	SAE J1939, 250 Kbits/second
Protection	Internal thermal fuse Reverse voltage protection (pins 1 and 12 of connector) CAN buses protected to 24V ESD voltage protected to SAE J1113 specification for heavy duty trucks Transient voltage protected to SAE J1113 specification for heavy duty trucks

  
 Unit of IDEX Corporation  
 607 NW 27th Avenue  
 Ocala, FL 34475 U.S.A  
 Phone: 1.800.533.3569 • 352.629.5020  
 Fax: 1.800.520.3473 • 352.629.2902  
[www.class1.com](http://www.class1.com)