

**THE**

**hafler**

**XL-280**

**EXCELINEAR  
POWER AMPLIFIER**



**INSTRUCTIONS  
for OPERATION  
and KIT ASSEMBLY**

**NOTE:**

IF THE SPEAKER FUSES BLOW, NO SOUND  
WILL BE HEARD. ALWAYS CHECK FOR  
BLOWN FUSES FIRST.

LM 165  
**\$3.00**

THE DAVID HAFLEER COMPANY  
5910 Crescent Boulevard, Pennsauken, New Jersey 08109  
A Division of the Rockford Corporation, Tempe, AZ 85281

Please refer to this  
serial number in all communications  
regarding this equipment.

**B**

## SPECIFICATIONS

### Power Rating:

Less than 0.05% total harmonic distortion at any power level up to 145 watts continuous average power per channel into 8 ohms at any frequency between 20 Hz and 20 kHz with both channels driven.

### Continuous Power Output:

Into 4 ohms, below 0.1% THD, 20-20 kHz, per channel: 200 watts  
Into 8 ohms, below 0.1% THD, 20-20 kHz, mono mode: 400 watts

### Continuous Power at Clipping:\*

Into 8 ohms, per channel: 180 watts  
Into 8 ohms, mono mode: 560 watts  
Into 4 ohms, per channel: 280 watts  
Into 2 ohms, per channel: 360 watts  
Into 1 ohm, per channel: 325 watts

### IM Distortion (SMPTE):

Less than 0.04% from 1 watt to 145 watts, each channel, into 8 ohms

### Typical THD at 145 watts into 8 ohms:

1 kHz—0.007%    10 kHz—0.02%    20kHz—0.04%

### Frequency Response @ 1 watt into 8 ohms:

± 0.1 db, 10 Hz to 500 kHz    ± 3 db, 0.1 Hz to 500 kHz

### Power Bandwidth:

Greater than 100 kHz

### Phase Shift from 20 Hz to 20 kHz:

Less than 15 minutes (1/4 of one degree)

### Typical Channel Separation:

20 Hz: 70 dB    1 kHz: 80 dB    20 kHz: 70 dB

### Signal to Noise Ratio, unweighted:

More than 100 dB @ 145 watts into 8 ohms

### Input Impedance:

47,000 ohms.

### Input Sensitivity:

1.6 volts rms for 145 watts into 8 ohms

### Damping Factor:

300 to 1 kHz into 8 ohms    250 to 10 kHz into 8 ohms    180 to 20 kHz into 8 ohms

### Slew Rate:

10 kHz, 60 volts peak to peak square wave: 75 V/μs

### Rise Time:

10 kHz, 60 volts peak to peak square wave, 10% to 90%: 0.7 μs

### Semiconductor Complement:

30 transistors, 12 power MOSFETs, 9 diodes, 4 zener diodes, 2 diode bridges

### Power Consumption:

Quiescent: 150 VA    Maximum: 1200 VA  
@ 145 watts/channel into 8 ohms: 540 VA    @ 200 watts/channel into 4 ohms: 840 VA

### Size:

5-1/8" high, 17" wide, 10-1/2" deep.

### Net Weight:

27 lbs.

### Shipping Weight:

31 lbs.

\*Continuous duty cycle across the audio band. Depending on impedance, time may be thermally limited to several minutes.

## THE XL-280 AMPLIFIER

CONGRATULATIONS on your choice of this Hafler EXCELINEAR amplifier. The XL-280 initiates the second generation of amplifiers bearing the David Hafler name. It clearly reflects the more than 30 year Hafler reputation for providing superior audio performance and exceptional value. The goal of this new Hafler circuit was a reduction of all forms of audible distortion below current standards. The results are demonstrably superior to the most costly amplifier designs, using a test of irrefutable logic.

This is the first EXCELINEAR — it excels in linearity — amplifier. In phase, amplitude, transfer characteristic and other distortions, the XL-280 sets new standards for accuracy. It is so close to perfection that for the first time you can make a meaningful comparison of this amplifier with the classic zero distortion reference: a straight wire. Your Hafler dealer can lend you a convenient switch-box — the XL-10 — which enables you to do just that. In your home, with your own speakers, you can hear for yourself just how little audible distortion this, or other fine amplifiers add to your reproduction of music.

An EXCELINEAR amplifier also enables the 'golden ear' who demands the absolute in system linearity to move one step closer to perfection. A special internal control facilitates the adjustment of one more parameter to make the speaker-amplifier interface maximally flat for the chosen speaker load.

Whether or not you choose to perform this last step to perfection, [patience and quiet, and the XL-10 circuit are required] the XL-280 consistently delivers the outstanding performance defined by its superb specifications. The EXCELINEAR adjustment will only enhance the sound quality — not compromise it. Hafler innovation now makes it possible for you to perceive and eliminate distortion which is below the threshold of the finest measuring facilities.

This amplifier includes several protective systems to provide maximum security against malfunction damage to either your speakers or to the amplifier. An AC line fuse and separate B+ and B- fuses for each channel are internal, along with independent thermal breakers for each channel. If a thermal breaker shuts down the amplifier, it will automatically reset after a few minutes. If one of the internal fuses blows, a knowledgeable technician should check the amplifier. Loudspeaker protection fuses for each channel are accessible on the back panel. These should be sized for the chosen speakers, since their sole purpose is to protect your speakers from excessive signals.

**We urge you to read the 'Operation' section of this manual before turning the amplifier on for the first time.**

This amplifier is capable of delivering appreciably more power than many speakers can safely accommodate. The David Hafler Company cannot assume any responsibility for damage to the load (loudspeaker) because the choice of speaker protection fuse size is in your hands.

Though descended from the renowned Hafler DH-200 and DH-220, the XL-280 circuit is a substantial engineering advance. Like its predecessors, it drives MOSFET output devices with an arrangement which is fully complementary from input to output. But here the input is to quadruple J-FETS in a double differential push-pull cascoded arrangement. This was chosen for its thermal stability and low distortion, low noise, high impedance 'tube-like' characteristics. The second stage current-mirrors the input for improved linearity. The traditional input capacitor and output choke have been designed out, virtually eliminating phase shift, while excellent stability has been retained. The circuit is direct coupled throughout. At the transformer output there are separate power supplies for each channel, with an independent supply for the driver stages. Total filter capacitance has been increased 56%, and additional output MOSFETs effectively double the low impedance drive capability, substantially improving the amplifier's ability to drive difficult loads.

Those who build the XL-280 kit will find that the left and right audio modules (combined printed circuit and heat sink) are fully assembled. This greatly simplifies the completion of the kit, so it can be done in a few hours without special skills. It also assures the audio integrity of the finished product, since all active circuitry has been tested to meet specified performance criteria which are the same as for factory assembled amplifiers. The modular design avoids the necessity to return the entire amplifier if one channel is at fault.

Accessories for the XL-280 include an alternate power transformer which accommodates multiple AC line voltages from either 50 Hz or 60 Hz sources, for operation in other countries; and the following special panels:

XL-281 — sculptured 19" panel for deluxe rack installations, including sculptured handles

XL-282 — sculptured 17" appearance panel without handles

XL-285 — flat 19" panel for standard rack installations, with handles

Welcome to Hafler affordable high accuracy sound!

**CAUTION:** For continued protection, replace the power fuse only with the same type and rating as indicated.

**WARNING:** TO PREVENT FIRE OR SHOCK HAZARD, DO NOT EXPOSE THIS EQUIPMENT TO RAIN OR MOISTURE.

©Copyright 1988. The David Hafler Company. All rights reserved.

## INSTALLATION

### Ventilation

Adequate air flow is important to the continuing reliability of any power amplifier. Cool air must circulate freely through the perforations in the cover and under the chassis, and through the heat sinks on the ends. If the feet rest on a smooth, level surface, their clearance will provide adequate circulation underneath. If the amplifier is mounted in a rack, or through a panel, the feet may be removed, but be sure sufficient cool air can reach the bottom openings. It is normal for the cover and heat sinks to become quite warm in normal use. If a heat sink consistently runs very hot, a technician should check the amplifier's bias adjustment.

### Location

If the amplifier is to be installed close to a magnetic phono cartridge, you should check to be certain the cartridge does not pick up hum from the amplifier's power transformer. Any large power transformer has some hum field, and while Hafler transformers are designed to minimize this field, certain cartridges are more sensitive than others, and require greater separation from the amplifier. Check at a comparatively high level setting, moving the tone arm across a record.

### Line Connections and Switching

Be sure your amplifier is wired for **your** line voltage **before you plug it in**. The XL-280 is normally wired for use on 60 Hz 120VAC power lines, as in the USA. If your line (mains) voltage is different, you will need an amplifier which includes the optional Hafler export power transformer which accommodates other line voltages, and which can accommodate 50 Hz current.

The XL-280's power switch may be left ON, and the amplifier switched remotely by connecting its line cord to a preamplifier (or other control center) which provides a switched AC outlet. Make sure the control device can supply a current of 10 amperes to the XL-280, in addition to the requirements of other units it may also be switching. You may instead connect the amplifier directly to a wall outlet, and control it with its own front panel power switch.

NOTE: As a general rule, power amplifiers should be turned **ON last**, and turned **OFF first** in the electronics lineup, to avoid loudspeaker damage due to switching transients which may be generated in prior stages. Hafler DH-100 and DH-110 preamplifiers include protective muting circuitry which obviates this concern. If, when you first turn on the amplifier, a loud, sharp 'thump' is heard from the speakers, you should turn off the amplifier and refer to "In Case of Difficulty" later in this manual. A minor thump or click at turn-on is normal.

### Connecting Cables

**OUTPUT** Use speaker wiring of sufficient size to preserve the XL-280's high damping factor. Standard #18 gauge lamp cord (zip cord) is satisfactory for up to 15 feet for 8 ohm or higher impedance speakers. Use a heavier gauge (#16) wire for 4 ohm speakers, or for longer runs. The XL-280's red and black output binding posts accept standard 'banana plug' connectors, including the double ones with 3/4" spacing. These are the most convenient to use if you may wish to change connections at times. The binding posts will also clamp a spade lug, or a bare wire through the hole in the center post. Be sure there are no frayed wire strands which could touch adjacent terminals or the chassis. 'Tin' bare wire ends with solder to secure all strands.

**INPUT** Conventional shielded cables, often supplied with preamplifiers, may connect the control center to the amplifier's gold input jacks. The gold plated jacks provide added assurance of a secure, noise-free connection. Be sure your cables are in good condition and that the plug's outer shield is tight on the jack, to avoid hum. If you wish to install the XL-280 at some distance from the preamp, the preamp's output impedance and the cable capacitance determine the permissible cable length to avoid high frequency losses. If, as with Hafler preamps, the output impedance is 600 ohms or less, and cable capacitance is under 50 picofarads per foot, up to 50 feet is acceptable. Common interconnecting cables often have higher capacitance per foot, but low capacitance shielded cabling is available. On long runs, keep the left and right channel cables close together, and avoid running them parallel to AC power wiring to reduce the likelihood of hum.

**PHASING** This is a factor of signal integrity which is determined by 'which wire goes where'. Consistent phase relationships are important when connecting speakers, to enable full bass reproduction and to maintain a cohesive sound stage, as well as to preserve mid- and high-frequency 'time alignment'. To be sure that all speakers in a system are wired to the amplifier 'in phase', each 'ground' or '-' speaker terminal should be connected to the black binding post on the XL-280, and each speaker's '+' terminal connected to the corresponding red binding post. Speaker cables identify one conductor from the other by the wire color, or by marking or coloring the insulation. If you are uncertain as to whether a speaker is wired correctly, switch the preamp to mono, and you will hear a 'hole in the middle' when two stereo speakers are wired out of phase. **Note:** In the special case of monophonic operation of the XL-280, described below, different speaker connections are employed.

**GROUNDING** The black output binding posts of the XL-280 are connected together at the power supply. They connect to the chassis through a 5 ohm resistor. This facilitates the use of external devices which use a common ground connection, such as some headphone junction boxes. You must be sure that the '-', ground or shield connection from such a device goes to the black binding post on the XL-280. It is very important that any device with an external common ground be connected properly before the amplifier is turned on. The RED terminals of the amplifier must NEVER be connected together. **Note:** No connection may be made to the black ground terminals when the XL-280 is connected for bridged mono operation as described below.

### Connections For Monophonic Operation

When you wish to drive a single loudspeaker load with increased power capability, the XL-280 can be operated in a 'bridged' configuration. This drives both channels with the same signal and combines their output to deliver over 400 watts into 8 ohms. In this mode only the Left input is used, and the speaker is connected **only** to the two RED binding posts. The right red post becomes a virtual ground, or '-' connection. This is a 'floating' output. No connections may be made to either black binding post, or to the right input jack. Set the Mono/Stereo switch to MONO. It is best to make this change with the power off, and it is a good idea to block the black output terminals and the right input jack with tape, or otherwise mark the amplifier's Mono mode to avoid later errors.

## OPERATION

### Power Switch/Pilot Lamp

The pilot lamp in the power switch will glow steadily whenever power is applied to the XL-280. If it does not light, a technician should check for a blown internal AC line fuse. This switch lamp also indicates a high temperature shut-down by blinking on and off. Reduce the input signal to allow the amplifier to cool. Operation will be automatically restored after several minutes if the XL-280 has not been turned off, and the lamp will return to a steady glow. If a second shutdown soon occurs, you should check for insufficient ventilation, continuing excessive input signal, or a load impedance well below 4 ohms. If none of these conditions exist, the amplifier may have malfunctioned, and requires service. The XL-280's very substantial heat sinks will accommodate the normal signal power capacity with ease.

### Initial System Checkout

The first time, leave the XL-280 switched off (rocker to the left) and turn on the rest of your system. Wait 30 seconds, and switch on the XL-280. If you hear a loud sharp 'thump' from your speakers, turn off the amplifier and see the section "In Case of Difficulty" which follows. Minor turn-on noises are normal.

### Mono/Stereo Switch

This back panel slide switch should be left in the STEREO (down) position unless the amplifier is to be operated in the bridged MONO mode. See Connections for Monophonic Operation above.

### Speaker Fuses

please read

An amplifier of this size can deliver enough power to damage almost any speaker if driven carelessly. Though they are no substitute for reasonable care and common sense, the fuses on the back panel, if of the proper rating, can provide substantial protection for your loudspeakers against unintended signal levels. The fuses do **not** protect the amplifier, but are only for **your** convenience and the safety of your speakers. David Hafler amplifiers are among the very few that provide this extra means of assuring that your speakers are only operated within their capabilities. But the choice of fuse current rating, and thus its effectiveness, is up to you the user. Thus the Hafler Company cannot assume any responsibility for damage to the loudspeaker load.

The XL-280 is supplied with 2 ampere fuses in these holders. This value will afford reasonable protection for most speakers. If the instructions for your speakers recommend a specific fuse size, obtain type 3AG (or AGC) fuses of that size and install them. In certain circumstances, such as when driving only high frequency speakers which have limited power handling capacity, a smaller fuse value may be advisable. A pair of 5 ampere fuses has been provided as spares, but these will offer no speaker protection. If you intend to test the amplifier's maximum power, 7 ampere (or larger — depending on the load impedance) fuses are needed.

We have deliberately supplied fuses of much lower rating than the power the amplifier can deliver so you can have sensible speaker protection. Because a fuse does not blow immediately on overload, useful speaker protection requires a much lower value fuse than would be implied by the usual calculation based on a speaker's power and impedance ratings. Even the 2 ampere fuse will pass the full amplifier power on normal musical peaks. But, over time, any fuse size which provides realistic protection may eventually succumb to the high power bursts which are a part of music with wide dynamic range. Should your amplifier fail to function, always **check the speaker fuses first**. Keep spare fuses of the same size at hand.

In their pursuit of sonic perfection, some audiophiles regard speaker fuses as an unnecessary component which can compromise absolute quality because they have the potential for introducing trace amounts of distortion and lowering the damping factor. For these reasons, Slo-Blo type fuses are not recommended in speaker applications. Conventional fuse types are much better, but it is true that their function precludes their being a perfect conductor, especially when allowance is made for the vagaries of fuse holders. As conservative designers, we believe their advantages greatly outweigh the possible limitations for most users.

But as sonic purists, we recognize that those with 'golden ears' may prefer to forego speaker safety. For them, we suggest alternatives which will not void the amplifier warranty. The simplest course is to use a larger size fuse, where sonic aberrations will be minimized (we find insignificant differences above 5 amps). Or you may bypass the **speaker** fuse holder internally. A third alternative preserves some speaker protection by retaining the fuse, and adds an internal 0.01 mfd capacitor across the fuse holder terminals. This minimizes any aberrations introduced by the fuse, but if the fuse blows, a path for high frequencies still exists which could, in the event of oscillation, damage a speaker.

### Cover Access Plugs

The two holes in the top of the XL-280 which are fitted with snap-in plugs are provided for the Excelinear Adjustment on each channel which is described below. These controls have been set at the factory for a typical speaker system, but if you choose, they can be readjusted in accordance with the instructions which follow, to match your own speakers more precisely. At any setting of these controls, however, the XL-280 will meet all its specifications.

## IN CASE OF DIFFICULTY

If a loud 'thump' is heard from the speaker when the amplifier is switched on, it could indicate a spurious DC voltage at the output terminals. Minor turn-on clicks or thumps may be ignored. Since the XL-280 is direct coupled, any DC present at the source will appear at the output. We consider more than 100 millivolts (1/10th volt) of DC at the output excessive, and a volt

or more would add speaker distortion, so it must be remedied. Check by breaking and making the speaker connections while the amplifier is turned on. No significant noise = no DC. If there is still a 'click' or crackling noise, turn off the XL-280, wait 20 seconds, disconnect the input cable at the amplifier, turn the XL-280 on again, and check by disconnecting/reconnecting the speaker again. If the noise disappears, the XL-280 is OK. Whatever equipment introduces the noise when it is connected probably has a defective output coupling capacitor, and **requires service**. While the input blocking capacitor present in most amplifiers provided backup to prevent the DC from reaching the speakers, this is no longer the case with the XL-280, so it must be corrected promptly.

Each module in the kit, which comprises all of the 'active' amplifier circuitry, has, like the factory built amplifiers, been tested to meet specifications for power, distortion and noise. Thus the likelihood of a module fault is near zero. Kit building errors are often found more easily by someone other than the builder, as it is common to make the same mistake twice.

If the XL-280 is inoperable, check the power switch pilot lamp. If it is blinking, excessive temperature has shut down the amplifier. After a few minutes to cool, it will turn on automatically. If it soon shuts down again, and the amplifier has sufficient ventilation, the malfunction is either internal, requiring competent service, or is the result of an excessive (and likely inaudible) input signal. In the latter case, investigate the signal source.

There are fuses inside the amplifier which are not considered to be replaceable by the user. There is a 10 amp slo-blo line fuse, and four 7 amp power supply fuses. Professional service may be required if one of these fuses is blown.

If the pilot lamp is not lighted, the main fuse in the single fuse clip inside the chassis is probably open. If a replacement 10 ampere Slo-Blo fuse (do not use a larger value) also blows, the amplifier has a power supply problem. For overseas line voltages which are 200 volts or higher, the fuse size is 5 amps.

If there is a problem in only one channel, that module may be isolated by removing the power supply fuses on its circuit board. We do not encourage service at other than factory authorized facilities because some components may not be available locally, and substitutions are not recommended. You may return a defective module for service (but only to the factory), rather than the entire amplifier. This reduces the weight, speeds service, and minimizes the risk of damage in transit. If you remove the module (leave the circuit board attached to the heat sink), tag each wire for reconnection.

If one module runs noticeably warmer than the other, a technician should first check the respective bias levels, which should be about 300mA with the AC line adjusted for its nominal value (120 volts in the USA). Do not confuse the bias potentiometer P1 with the Excelinear trimmer capacitor C11. If output transistors must be replaced, the bias should be checked. Remove one of the fuses on the board and connect an ammeter across the fuse clip. Avoid intermittent connections. Turn the amp on, make the adjustment, turn the amp off, and when the current has dropped to zero, remove the ammeter and replace the fuse.

## THE EXCELINEAR CONCEPT

The purpose of the Excelinear technology is to detect and to minimize all possible non-linearities, or distortions. The success of any amplifier design may be evaluated by a simple, inherently logical differential test procedure which has long been known, and sometimes attempted in the past. This is done by subtracting the output of the amplifier from its input. The perfect amplifier would have no residual signal. The less difference signal that remains, the better the amplifier.

In previous applications of this differential test, all audio amplifiers were insufficiently accurate in one or more respects such that the test signals had to be specially modified to achieve useful comparative information. The Hafler Excelinear amplifiers are the first to pass such a test with any appropriate test signal and deliver measureably superior results.

In the procedure described below you will be able to listen to only the differential residual — the sum total of all variations between the input to the amplifier and its output — the total audible distortion. It will already be exceedingly low on the XL-280 as you receive it. But when the XL-280 is coupled with your own speakers, you may be able to reduce the total distortion even further by careful readjustment.

This test is a very useful comparative technique which supplements conventional distortion measurements. The quantity and quality of the residual sound is a reflection of a given amplifier's linearity — and hence its accuracy. The test is as sensitive as one's hearing, and far more precise than available measurement technology because it is able to reveal the audible effect of **all** distortions — even those which have not yet been identified or quantified! Only a few amplifiers cannot be subjected to this test: those which are phase inverting; those which have floating (not grounded) outputs; and those which cannot tie together the output grounds. Some tube amplifiers ground the 4 ohm output tap.

Hafler Excelinear amplifiers provide a unique internal adjustment for 'fine tuning' each channel to attain maximum amplifier linearity when it is connected to **your** speakers. This 'fine tuning' or 'tweaking' may fairly be described as significant only to those persons often said to have 'golden ears'. This facility is provided because Hafler products are so frequently chosen by these critical listeners. The rest of us who simply wish to indulge ourselves with fine sound need not be concerned with this consummate pursuit of perfection.

As your XL-280 left the factory, it was adjusted to give optimum performance on a typical loudspeaker load. The setting for most loudspeakers will not be substantially different from this. The range of adjustment provided is within the defined operating specifications of the amplifier. Misadjustment will not damage or impair the performance of either amplifier or speaker. The change in response actually occurs several octaves above the range of human hearing. Yet we have found that minute differences in absolute linearity can be heard. It is to eliminate these that this 'fine tuning' is provided. You should not change the factory's setting until you have at hand the appropriate control circuit described below. This is needed to precisely set the gain of the amplifier under test. You will need patience, quiet, and good hearing, but no test instruments to complete the task. A special tool is provided with the amplifier to make this adjustment. The small round caps on the amplifier's cover provide access. Do not disturb these caps until you have read and understood, and intend to complete, the procedure described below.

When you have completed the Excelinear adjustment of your amplifier with your loudspeakers, you have, in effect, 'zeroed out' amplifier distortion in your music system. With the XL-280, the **total** of all residual distortion products will be on the order of 60 dB or more down across the audio band — a substantial improvement over other amplifiers, where 40 dB figures are among the best.

A pair of headphones which have a high degree of isolation from the surroundings may simplify your listening, but is not essential. Using your loudspeaker, what you hear is what [actual level of the distortion] you get.

### THE EXCELINEAR ADJUSTMENT

No instrumentation is required for this procedure. If a very sensitive meter is available, it can replace the listening requirement, but your ears are better than conventional meters. What is needed is a very precise attenuator (input level control) to adjust the gain of the amplifier under test so that the level of its output matches the input exactly. Conventional amplifier level controls are too coarse to provide useful results. One channel of the stereo amplifier is used as a driving source; the other is the amplifier under test. These are then interchanged to enable adjustment of both channels.

The circuit diagram shows the appropriate connections and the components values for a precision attenuator. The Hafler XL-10 switch box may be borrowed from your dealer to provide the circuit in convenient form. The XL-10 also provides a switch for making a direct comparison of the test amplifier with a straight wire — a means of confirming the results of the differential test.

The driving amplifier provides a signal at a typical listening level to the load loudspeaker. The accuracy of the driving amplifier is not a factor. If it has distortion, that distortion is simply a part of the test signal, and does not detract from the test accuracy. The test is simplified by using the two halves of a stereo amplifier for the drive and test amps, but the drive amplifier could be another high quality design, or even just a noise generating instrument. Any type of signal may be used — music, sine waves, white or pink noise, etc. The advantage in using a constant level wide band source, such as noise rather than music, is that it simplifies the listening process, is faster, and if measured, provides a single figure of merit for comparison.

The input to the test amplifier is adjusted so that the input and output levels are identical. The monitor loudspeaker is connected differentially across the outputs of the two amplifiers — between the input and the output of the amplifier under test. Any additive or subtractive variations between the input to, and

output from, the test amplifier represent some form of distortion and will be present as a signal voltage at the monitor. With some signals or brands of amplifiers, this residual distortion will have a musical relation to the program; in other cases it will be mostly noise.

The Excelinear adjustment optimizes the amplifier's performance when connected to the load loudspeaker. The monitor speaker is not a part of the load, and it may be replaced by headphones, or by an appropriately sensitive meter. Since the 'load' speaker's very audible output would interfere with listening to the much weaker signal from the monitor speaker, it must be moved to another room.

It is preferable to use a similar speaker for monitoring, because you hear the distortion products at realistic levels and content. It makes comparative evaluation of amplifiers more representative. A good amplifier will have low distortion, so you will have to listen very carefully, close to the speaker, to achieve the best null. However, headphones which have earcups which are effective seals may enable you to make the adjustment without having to move the 'load' speaker. Because headphones are much more sensitive than speakers, however, the relative loudness of the residual distortion may be misleading. The XL-10 box includes a series resistor to pad down the headphones so they cannot inadvertently receive the full power signal. A sensitive AC voltmeter which can read down to 0.001 volt is the measurement alternative.

The adjustment procedure is as follows:

1. Use the right channel of the XL-280 as the driving amplifier and the left channel as the test amplifier. **Turn off the amplifier** each time before making any changes in connections.
2. Connect a speaker to the right channel speaker terminals to first obtain a normal listening level by adjusting the preamp's volume control. A convenient signal is the interstation noise from an FM tuner with its muting deactivated. This is similar to white, or uniform broad band noise.
3. Now reconnect this 'Monitor' speaker (here you may instead use headphones or a meter) between the Left Red output binding post and the Right Red binding post.
4. Connect the attenuator circuit to the Right channel output, and connect the Left channel input to the attenuator. Be sure the attenuator is also connected to the Right channel ground.
5. Connect the 'Load' speaker to the Left output terminals.
6. Center the 'Fine' potentiometer, and adjust the 'Coarse' potentiometer for minimum signal from the monitor speaker. Readjust the 'Fine' control for the best null.
7. Remove the cap above the left channel by prying it up carefully. Using **only** the plastic tool provided, adjust the variable capacitor which is 1-1/2" below the surface. **DO NOT USE ANY METALLIC TOOL.** Alternate between the 'Fine' potentiometer and this 'tweaking' adjustment to achieve the best null.
8. Turn off the amplifier, change both input and output connections to the opposite channel, and repeat steps 6 and 7 to adjust the right channel. Replace the caps in the cover.

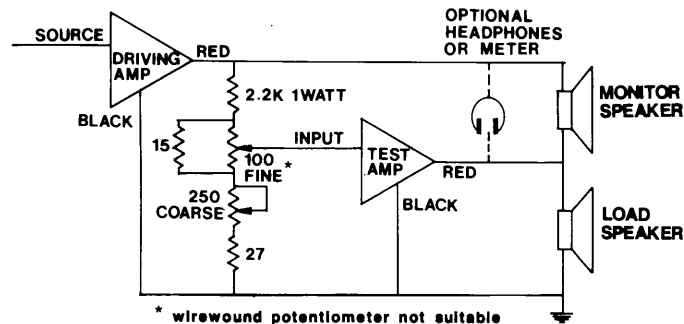

## ASSEMBLY INSTRUCTIONS

The XL-280 amplifier is a versatile component with sophisticated circuitry which has been made remarkably easy to build by individuals with many years of experience in the design and engineering of the finest performing audio kits, and in the preparation of their manuals.

There are three basic rules for success in electronic kit building:

1. Read the instructions carefully, and follow them in order.
2. Make secure solder connections, which are bright and smooth.
3. Check your work carefully after each step.

Kit building should be fun, and we are certain you will find this to be so. Assembly will be faster and more enjoyable if you have someone help you by reading the steps aloud and selecting the required parts as you proceed. Fatigue increases the risk of error, so take a break rather than push to early completion. There are relatively few separate components in this design, to make it easy to pack everything away, if need be.

Your work area should have good lighting, the proper tools, and a place where the large pictorial diagram can be tacked to the wall within easy reach for checking. The tools should include:

1. A 40 to 60 watt pencil soldering iron with a 3/16" or smaller tip which reaches 700°F.
2. 60/40 (60% tin) ROSIN CORE solder, 1/16" diameter or smaller.
3. A damp sponge or cloth to wipe the hot tip of the iron.
4. A wire stripping tool for removing insulation. This can be a *single-edge* razor blade, but inexpensive stripping tools are safer, faster and easier.
5. A medium-blade screwdriver (about 1/4" wide).
6. Needle-nose pliers (a long, narrow tip).
7. Diagonal or side-cutting small pliers.
8. Large "gas" or "slip-joint" pliers.
9. A 1/4" "Spin-tite" nut driver may be helpful, but is not necessary.
10. A Phillips head screwdriver.

### Proper Soldering

There are four steps to making a good solder connection:

1. Make a good mechanical connection to hold the wire in position while heat and solder is applied.
2. Heat the *junction* of the wire and lug, or eyelet, with the bright, shiny tip of the iron.
3. After heating for a couple of seconds, apply solder to the junction. It should melt immediately and flow smoothly around both surfaces.
4. Allow the connection to cool undisturbed.

The general procedure is to use a hot iron for a short time to heat a connection, then add solder with the iron still in contact. Remove the solder once it flows, and then remove the iron. A cooler iron applied for a longer time is more likely to damage components, or lift the copper circuit pattern from the boards. A break in the etched circuit can be mended by simply soldering a small piece of wire across it. Do not allow much build-up of solder on the tip of the iron, or it may fall into adjacent circuitry.

Remember that the connection is made by the solder, not by mechanically attaching the wire to the terminal. Usually the wire is looped through the lug and crimped in place, but some prefer to just place it through the hole and rely on the stiffness of the wire to hold it while soldering. Eyelet connections, of course, are handled this way.

Good solder connections are *essential* for trouble-free, noise-free operation. A good solder joint does not require much solder around the conductors. Never "butter" partially melted solder on the joint, as it is useless. A good connection looks smooth and bright because the solder flows into every crevice when the parts are hot enough. The iron must have a bright, shiny tip to transfer heat easily to the junction. That's why the damp sponge should be used frequently to wipe the tip, and occasionally you must add a small amount of solder to the tip, too. If a connection is difficult to heat, "wet" the tip with a small blob of solder to provide a bigger contact surface to the joint. Once the solder flows around the conductors, any movement must be avoided for a few seconds to allow a good bond. When cool, check the connection by wiggling the wire. If in doubt, or if the connection is not shiny, re-heat the joint. Excess solder may be removed from a connection by heating it and allowing the solder to flow onto the iron, which is then wiped on the sponge.

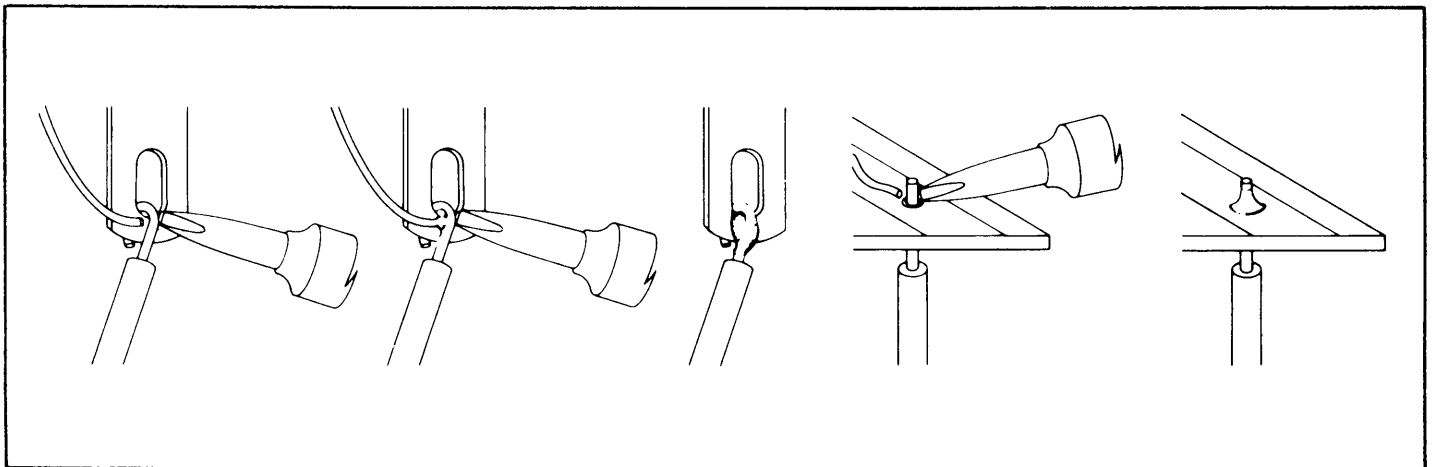



## ALL SOLDER USED MUST BE ROSIN CORE

Never use acid core solder or any separate flux in electronic work. Silver solder is also not suitable. If in doubt about unmarked solder, always obtain a fresh supply of rosin core solder. We recommend 60/40 for easiest use. Do not confuse it with 40/60, which is harder to melt.

When soldering to an eyelet or hole on the board, insert the wire so that bare wire is exposed on both sides of the board, and apply the iron to the joint so that you can see that the hole is then filled with solder for a secure bond. A round wooden toothpick is suggested so that you can heat and clear a hole of solder if it hinders your inserting the wire. Some builders prefer to clear every hole first with a touch of the iron and toothpick. Others connect the lead by bringing it up to the center of the hole on top of the board, applying the iron from the bottom of the board, and pushing the lead in as the solder in the hole melts. If the wire has first been "tinned," usually no additional solder is necessary, but it is a good practice to push the wire through, and then back it up a bit, to be sure solder fills the hole. On the bottom of the board, make certain a bright, shiny flow is evident from the wire onto the circuit pattern on the board.

"Tinning" refers to the process of applying a light coating of solder to the bared wire end. This keeps all the strands secured, and also makes a good connection easier. Simply touch the wire with the iron for a couple seconds, and apply solder. Allow the excess to flow away onto the iron. When properly done, the wire is uniformly bright, and no larger than before.

If any components are unfamiliar to you, checking the pictorial diagram should quickly identify them. Or, the quantities, and the process of elimination as you check the parts list, will help. The pictorial diagram is necessarily distorted to some extent for clarity, so that you can trace every wire in a single overall view for verification as you work. You may wish to check off on the diagram as you solder each location.

To "prepare" a wire means to cut the designated amount from the length of that color, and strip about 1/4" of insulation from each end. The wire supplied in the kit is #18 and #22, so you can set adjustable wire-strippers accordingly. The transformer leads are #18, and the line cord is #16. Be careful that you do not nick the wire when you strip it (that can happen more easily if you do not use wire strippers) for that weakens it.

Whenever a connection is to be soldered, the instructions will so state, or indicate by the symbol (S). If more than one wire is to be soldered to the same point, they will be indicated by (S-2), (S-4), etc. If soldering is not called for, other connections have yet to be made to that terminal. They would be more difficult if the connection was already soldered. Every connection in the kit will be soldered when it is complete. After soldering a connection, it is best to clip off any excess lead length to minimize the possibility of a short circuit (as on switch lugs, where terminals are very close together), and for neatness.

Handle the circuit boards carefully. They represent a major part of the kit cost. Stand-up components, such as transistors, should be checked when you install the module, to be sure all leads are separated.

Take the time to be accurate and neat, and you can be sure that your completed amplifier will meet the performance of a factory assembled unit, and can continue to perform properly for years to come. Check your work, and make sure the entire step has been completed before placing a check mark in the space provided, and continuing on to the next step.

## KIT PARTS LIST

Minor variations may sometimes be encountered in value or appearance. These will not affect performance. Some of the hardware listed here has been used to secure parts of the assembly for shipping security.

		Part No.
1	Chassis	MS033
1	Cover	MS034
4	Capacitor, 7800 mfd, 75V	CL156
4	Bracket, capacitor, round	HZ179
1	Circuit Board, PC-41	KB068
2	Cap, snap-in, plastic	HR178
2	Diode rectifier block	QD117
4	Foot, rubber	HR149
2	Fuse Holder, round	XA013
1	Fuse Clip, single	XA012
2	Input Socket, gold plated	XP017
1	Line Cord with plug	WA016
2	Output Module Assembly (1 each, left and right)	AH332
2	Output Terminal, black, with hardware	XK011
2	Output Terminal, red, with hardware	XK012
1	Switch, rocker, SPST, lighted, power	SWH-105 SL111
1	Switch, slide, DPDT	SZ122
1	Strain Relief, plastic	HR144
1	Terminal Strip, 5 lug	XK018
1	Transformer, Power, Domestic, 120V	TA145
	Transformer, alternate International	TA146
	Wire, white #18	
	Wire, green #18	
	Wire, red #22	
	Wire, black #22	
	Small Parts Envelope	
1	Capacitor, .39 mfd	CE117
3	Capacitor, .01 mfd, disc	CZ112
2	Capacitor, 470 mfd, electrolytic	CL157
5	Diode, 1N4003	QD115
1	Resistor, 1 megohm, 1/2w, 5%	RD113
1	Thermistor	RZ029
1	Tool, alignment screwdriver	HR177
	Hardware Envelope	
1	Lug, grounding, internal tooth, #6	HZ115
3	Lug, spade, 1/4", female	XZ014
2	Lug, ground, input socket, gold plated	HW132
4	Nut, #4-40 KEP	HK111
14	Nut, #6-32 KEP	HK112
8	Nut, #10-32 KEP	HK113
2	Nut, 1/2", for fuse holder	HK118
2	Nut, gold plated, for input socket	HK130
6	Screw, #4-40 x 5/16", Phillips, black	HP124
2	Screw, #6-32 x 3/4"	HA115
12	Screw, #6-32 x 1/2"	HA116
8	Screw, #10-32 x 1/4" SEMS	HA118
4	Screw, #10-32 x 1/2"	HA119
4	Screw, #10-32 x 3/4"	HA129
4	Screw, #6 sheet metal, Phillips head	HP117
16	Screw, #6 sheet metal, slotted hex head	HP118
4	Washer, flat, 7/8"	HW114
2	Washer, locking, 1/2" for fuse holder	HW116
2	Washer, rubber, 1/2" for fuse holder	HR117
2	Washer, shoulder, fiber, input socket	HR182
	Fuse Envelope	
2	Fuse, 2 ampere	SF011
2	Fuse, 5 ampere	SF012
1	Fuse, 10 ampere, Slo-Blo	SF038
1	Capacitor, .005 mfd, disc, 1000V	CZ113
	Alternate Fuse Envelope with International Transformer	
2	Fuse, 2 ampere	SF011
2	Fuse, 5 ampere	SF012
1	Fuse, 10 ampere, Slo-Blo	SF038
1	Fuse, 5 ampere, Slo-Blo	SF018
1	Capacitor, .005 mfd, disc, 1600V	CZ111
1	Terminal Strip, 2-lug	XK016
1	Nut, #4-40 KEP	HK111
1	Screw, 4-40 x 5/16"	HA113

## Assembly

- 1  When you unpack your kit, you will find that the transformer and the output module assemblies have been fastened to the chassis for safety during shipment. Detach the output modules (and the transformer, too, if you choose) from the chassis, and include all of this mounting hardware when you check off the components against the kit parts list. We recommend this check-off to be sure you have everything, and to enable you to identify any unfamiliar items by comparing them with the pictorial diagram or the count of items supplied. An egg carton is ideal for keeping hardware items separated.

A 'set' of hardware includes one screw and one KEP nut (with its attached lockwasher). Always install the lockwasher side of the nut first. If the size of the hardware is not specified, use the #6 size. The smallest is #4, and #10 the largest. Always insert a screw from outside the chassis.

It will simplify matters if you first separate the #4 nuts from the #6 nuts, which have the same outside dimensions. A #4 screw will pass through a #6 nut, aiding identification.

- 2  Select the 4 rubber feet and 4 Phillips head sheet metal screws. Insert each screw through a foot so that the head is recessed, and install the feet on the outside of the chassis at each corner hole.
- 3  Select the 2 black output terminals. Install them at LB and RB - the lower holes marked with a ground symbol on the rear of the chassis.

Follow the mounting sequence shown below. Before you fully tighten the first nut, unscrew the cap to expose the hole drilled through the threaded shaft. Connection of loudspeaker wires will be easier if this hole is horizontal. A nail through the hole will help to hold its position while the hardware is tightened. Each connecting lug should point to the outside when the last nut is secured. Make sure each nut is separately tightened as they are difficult to reach when the amplifier is completed.

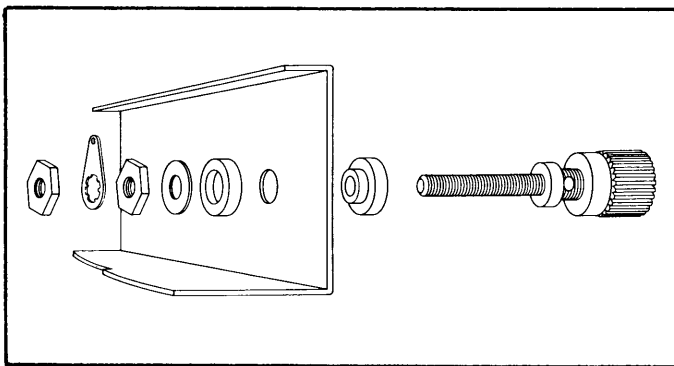

- 4  Select the 2 red output terminals and install them at locations LR and RR, marked +. Be sure the shaft holes are horizontal, the lugs point outward, and each nut is **tight**.
- 5  Select the 2 round fuse holders, and two each 1/2" rubber washers, lockwashers and nuts. First install the rubber washer on each holder, so it will be outside the chassis. Fasten the holders at LF and RF with the tip lugs pointing towards each other.

- 6  Select the 2 gold input sockets and their hardware: gold nuts and ground lugs, and fiber shoulder washers. The shoulder washers go outside the chassis, centering the sockets in holes LS and RS. The washers are not intended to isolate the socket from the chassis. Bend the tab of each ground lug up 90 degrees before installing it on the inside, followed by the nut. The tab should be at the bottom when tightened. To make sure these sockets are tight, you may wish to wrap masking tape around the outer larger-diameter collar a couple of times so you can grip it with pliers while you tighten the nut. Do **not** apply the pliers to the smaller diameter socket surface.
- 7  Select the single ground lug (with lockwasher teeth) and a black #4 screw and nut. Install it between the input sockets, pointing toward the bottom. Bend it out for access, and twist it 90 degrees so a wire may be inserted from the side. Be sure this is tight, as the locking teeth must cut through the chassis paint for a good ground connection.
- 8  Select the small slide switch and 2 black #4 screws. The switch assembly is tapped for the screws, so nuts are not necessary. Install it at MS.
- 9  Select the fuse clip and one set of #4 hardware. Install the clip at FC, the hole closest to the right front foot.
- 10  Select the 5-lug terminal strip and two sets of #4 hardware. Install it next to the fuse clip at TS. Note that the feet point to the right.

**NOTE:** Kits provided with the multiple voltage transformer for use in locations outside the USA which have a line (mains) voltage other than 120 VAC are also supplied with an additional two-lug terminal strip which is to be installed using an additional set of #4 hardware on the opposite side of the chassis.

- 11  Select the power switch. It may be one of several similar types. If it has a red window on one side of the rocker, that window goes to the right, or nearest edge of the chassis. If one lug is separated from the other two, the separate lug goes to the right. If there are molded lug numbers, the #3 lug goes to the right. The switch snaps into location PS from the outside.
- 12  Select the AC line cord and the plastic strain relief. Separate the two conductors for 2". Note that one of the leads is identified by one or more molded ribs. Cut 1" off the other (non-ribbed) lead. Strip 1/4" of insulation from each end, twist the strands tightly, and tin each end. 9" from the longest end make a sharp 'V' in the cord by bending it back on itself. Install the strain relief with the small end nearest the cut ends of the line cord. Crimp the two halves of the relief around the wire at the 'V' with heavy pliers, to partially form it before insertion into back panel hole AC. Then grip the larger diameter with the plier tips, squeeze it tightly, and insert the cord and the relief from the outside. A flat side of the relief mates with the hole shape, and it snaps into position when fully inserted.

Connect the shorter lead to FC lug #1. (S). Connect the longer lead to the **lower** hole of TS lug #2. (S). Note that lug 2 is the second protruding lug above the terminal strip. It is **not** the mounting foot for the terminal strip. Soldering this lead to the lower hole now will make later connections to the top portion of the lug easier. Be sure no stray strands of either lead are left unsoldered.

- 13  Select the two 4-lug diode block rectifiers, the 2 long #6 screws, and 2 nuts. Install the rectifiers at locations DL and DR in the holes nearest the back panel fuse holders. The plus (+) terminal of each rectifier must be located over the tiny indexing hole at the one corner. Correct orientation of these rectifiers is **essential**.
- 14  Select the PC-41 circuit board and 4 of the diodes. Note that one end of each diode is marked with a stripe (or an arrow head will point to that end). On the bottom of the circuit board, which is the side on which components will

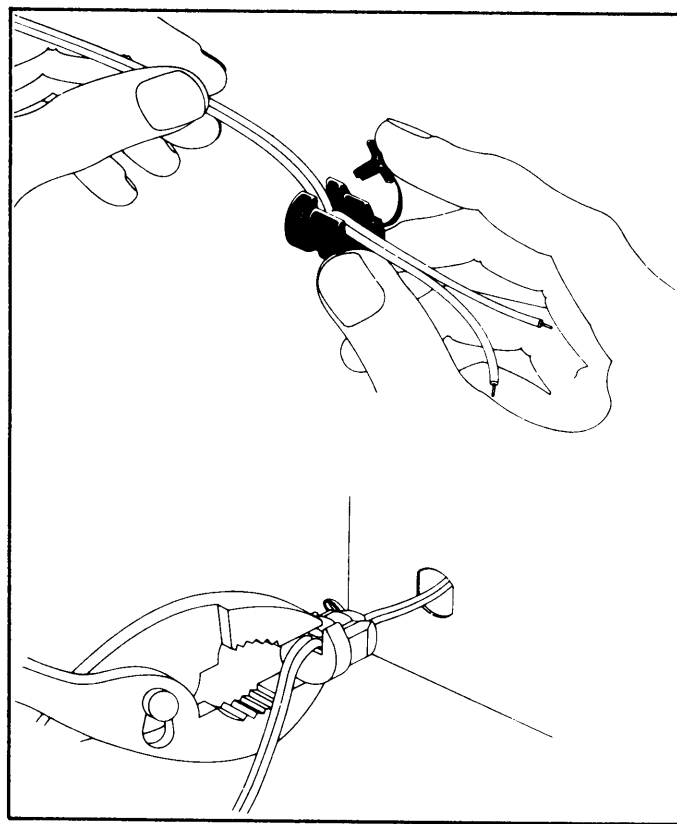
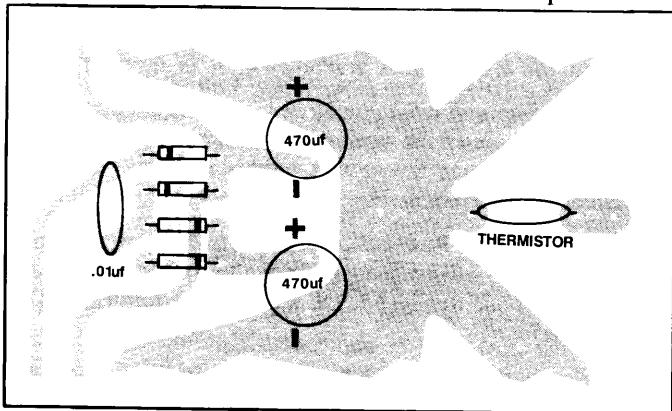

be mounted, arrow heads indicate the marked end of each diode. Correct orientation is **essential**. All these components should be mounted tight to the board. Cut off all excess leads on top of the board after soldering all 8 leads.

- 15  Select one of the .01 mfd disc capacitors (103M) and install it on the bottom of the board, adjacent to the 4 diodes. Solder and clip both leads.
- 16  Select the thermistor, and install it on the bottom of the board, opposite the capacitor. Solder and clip both leads.
- 17  Select the two 470 mfd capacitors and note that either the (-) or (+) lead is identified. Be sure these are oriented according to the markings on the board (both capacitors face the same way), be sure they are tight against the bottom of the board, and solder and clip their leads. Set the board assembly aside.
- 18  Prepare a 7" green wire and connect one end to lug #LB. (S). Place this wire off the left edge of the chassis.
- 19  Prepare a 1-1/2" white wire and connect one end to lug #LR. (S). Connect the other end to LF lug #2. (S).
- 20  Prepare a 10" green wire and connect one end to lug #RB. (S). Place this wire under the input jacks and the switch, and off the right edge of the chassis.
- 21  Prepare a 5" green wire, but strip 3/4" of insulation from one end. Pass the longer bare end through the ground lug between the input jacks and connect it to LS (ground) lug #2.
- 22  Prepare a 1" piece of bare wire, and connect it to RS (ground) lug #3. Connect the other end to the central ground lug. (S-2). Place this green wire straight back towards the transformer.
- 23  Prepare a 9-1/2" red wire and a 9-1/2" black wire. Twist these together equally throughout their length, and connect one end of the black wire to LS (ground) lug #2. (S-2). Connect the red wire to LS lug #1. (S). Place this wire over the left edge of the chassis.
- 24  Prepare a 2-1/2" red and black pair of twisted wires. Connect the black wire to RS (ground) lug #3. (S-2). Connect the corresponding red wire end to RS lug #4. (S). Connect the other end of the black wire to MS lug #2, and the red wire to MS lug #1.
- 25  Prepare an 8" red and black twisted pair, and connect it from the same (left) side of the same switch lugs: black to MS lug #2, (S-2); red to MS lug #1. (S-2). Place this pair off to the left.
- 26  Without removing the insulation from one black end, prepare a 10" red and black twisted pair. Wrap the insulated black end around the red wire in a tight full circle, as it will not be connected. This black wire provides shielding which is only to be connected at the opposite end. Connect the red wire to MS lug #5. (S). Place this pair over the right edge of the chassis.

- 27  Again leaving one black end insulated, prepare a 15" red and black twisted pair. Wrap the uncut black end as before, and connect the corresponding end of the red wire to MS lug #4 from the left. (S). Place this pair off to the left of the chassis.
- 28  Prepare a 7" white wire and connect it to lug #RR. (S). Place this wire above the input jacks and switch, and connect the other end to RF lug #1. (S).
- 29  Prepare a 2-1/2" white wire and select a spade shaped connecting lug. Solder it to one end of the wire, following the procedure below. Slip the lug onto the middle (#2) lug of the power switch PS, and connect the other end of the wire to FC lug #2. (S).

The proper way to attach a spade lug to a wire is to first cut the bared wire end to the right length (no more than 1/4") so that the insulation will be gripped by the longer, outer tabs, while the wire does not protrude into the spade clamp area. Tin the bare wire end. Bend the shorter, middle set of tabs tightly around the bare wire, and then bend the longer tabs around the insulation. Then flow solder into the joint around the bare wire, keeping the solder away from the spade section.

- 30  Prepare a 4" green wire, and solder another spade lug to one end. Slide it onto PS lug #3 and connect the other end of the wire to TS lug #4.
- 31  Select the remaining diode and note the marked (banded) end, which connects to TS lug #4. Connect the other end to TS lug #3. Keep the leads short.
- 32  Select the 0.39 mfd (.39K) capacitor. Connect one lead to TS lug #4. (S-3). Connect the other lead to TS lug #5.
- 33  Select the 1 megohm resistor (brown-black-green), keep its leads short, and connect one lead to TS lug #3. (S-2). Connect the other lead to TS lug #2.
- 34  Select the 4 large round capacitor mounting brackets, and 4 sets of #10 x 3/4" screws and nuts. These bolts are for the bracket clamps. On the pictorial diagram note the direction of insertion of the screw for each clamp. The clamp screws must be positioned so that they are accessible once the brackets and power transformer have been installed. Install a bolt in each clamp loosely.
- 35  Select 12 sets of #6 hardware (or only 8 sets, if the brackets have 2 legs instead of 3), and install the 4 brackets with the clamping screws correctly positioned. Just finger-tighten the mounting screws at first. Temporarily install a capacitor in each bracket in turn; make the clamp bolt snug but not tight; tighten the mounting hardware, and remove the capacitor. This procedure keeps the bracket from being distorted as the mounting bolts are tightened. Make sure none of the wires are trapped.
- 36  Prepare a 7-1/2" twisted white pair, but start one wire 3/4" longer than the other. Connect one longer end to DL lug #1, and the other wire to DL lug #4. Connect the shorter wire to DR lug #5, and the remaining end to DR lug #8.

- 37  Select one of the two .01 mfd (103M) disc capacitors, and trim its leads to 3/4". Strip two 1/2" pieces of insulation from the white wire, and slide one piece over each of the capacitor leads. Connect one lead to DR lug #5. (S-2). Connect the other lead to DR lug #8. (S-2). No bare lead should be visible where it emerges from the capacitor.
- 38  If you dismantled the power transformer in the beginning, reinstall it now, using the large washers **above** each foot, and the #10 x 1/2" hardware. The black and black/white leads go towards the power switch. Make sure none of the leads are trapped.

Be sure all strands of each transformer lead are tinned and soldered together before connection to a lug, so that there is no possibility of a stray strand touching anything but the lug.

Transformer leads may be shortened for neatness if you choose, but be sure you do not cut any of them too short, particularly if yours is the multi-voltage version, and any change to a different supply voltage is possible. Cutting the leads too short for re-use may void the transformer warranty if it is thought to be defective.

If the transformer is the optional multi-voltage version for overseas use, refer to the section of this manual "AC Line Connections For Overseas Use."

- 39  Separate the Red/Yellow transformer lead to avoid confusion, and twist together the two solid Red leads. Connect one Red lead to DL lug #4, and the other to DL lug #1.
- 40  Select the remaining .01 mfd disc capacitor. Trim and insulate its leads as in step 37. Connect one lead to DL lug #4. (S-3). Connect the other lead to DL lug #1. (S-3).
- 41  Prepare a twisted pair of 21" white wires. 7" in from one end of the pair, cut **one** of the wires, and unwind it about 1-1/2" in each direction from the cut. Strip 1/4" of insulation from each cut end. From the front center of the chassis, thread the shorter portion of the wire under the power switch, and place the pair down along the lower front edge of the chassis, with the break at terminal strip TS. Connect the cut end from the left to TS lug #2. (S-2). Connect the other cut end to TS lug #5. The free ends will project from the front corners of the chassis.
- 42  Connect the Black/White transformer lead to TS lug #5. (S-3).
- 43  Select the remaining spade lug and solder it to the end of the solid Black transformer lead. Slide the lug onto PS lug #1.
- 44  Select the .005 mfd disc capacitor (502M) and clip its leads to about 1". Allowing some extra lead length on the capacitor to enable disengagement of the spade lugs, wrap one lead around the shaft of the spade lug which is connected to PS lug #1, and the other lead around the shaft of the spade lug on PS lug #2. Solder both leads, but do **not** solder the spade to the switch lug!

- 45  Select the output modules (the two major items in the kit). Note that the only difference which distinguishes the left module from the right is the position of the thermal breaker TB. When you can read the circuit board hole numbers along the bottom, the thermal breaker is to the right on the right hand module.

Before connecting wires to these modules, it is best that you take the time to inspect the holes, or eyelets on the underside of the board, to make certain the connections already made to some of these are well soldered. You will be making connections from the top side of the board to holes #4, #5, #7, #8, #10 and #11. Make sure the hole is clear at each of these. If it is filled with solder, running the iron along the underside will reveal the hole, and it may be cleared with a wooden toothpick. Make sure none of the existing wires can interfere with the new connections. Because the position of some wires between the board and the heat sink is significant, avoid displacing these unnecessarily.

Wires will be connected to the holes from the top of the circuit board, and you must be sure they are soldered securely to both sides of the board. Each hole is 'plated through' so it makes a connection to the other side. A good solder connection, which heats the wire and the circuit pad on the board, will allow solder to flow through the hole for a secure connection. Every wire should have a tight tinned end. The wire supplied in the kit is already tinned, unless it is frayed. Melt a small amount of solder on the tip of the iron so it will make a good contact with both the wire and the pad on the board. Then add additional solder so there is a smooth, bright transition of solder from wire to board. Push the wire all the way in, then back it out a bit before removing the iron, so you can see the solder joint on both sides of the board and allow it to cool undisturbed.

- 46  Select the right hand module, and prepare a 6" white wire. Connect it to hole #5. (S).
- 47  Prepare a 7-1/2" green wire and connect it to hole #10. (S). Bring this wire over to the white wire, so that the free ends are even, and twist these together for the last 3".
- 48  Prepare a 6" white wire and connect it to hole #4. (S). Place this wire straight up towards the top of the board.
- 49  Prepare a 5" white wire and connect it to hole #7. (S). Bend this wire off to the left of the heat sink, between the other white wires and the board.
- 50  Prepare a 6" green wire and connect it to hole #8. (S). Bend a hook in this wire for identification and bend it towards the top of the board.
- 51  Prepare a 6-1/2" green wire and connect it to hole #11. (S). Bend this wire off to the right of the module. Set this module aside.
- 52  Select the left module, and prepare a 7-1/2" white wire. Connect it to hole #5. (S).
- 53  Prepare a 6" green wire and connect it to hole #10. (S). Bring the white wire over to the green wire so that their ends are even, and twist them together the last 3".
- 54  Prepare a 6-1/2" white wire and connect it to hole #4. (S). Bend this wire straight up to the top of the board.
- 55  Prepare a 5-1/4" white wire and connect it to hole #7. (S). Bend this wire off to the right of the heat sink.
- 56  Prepare a 6" green wire and connect it to hole #8. (S). Bend this wire towards the top, and put a hook in it.
- 57  Prepare another 6" green wire and connect it to hole #11. (S). Bend this wire off to the right. Set the module aside.
- 58  Select the main chassis assembly, and prepare a 4-1/2" green wire. Connect it to DL lug #2. (S). This wire sticks straight up.
- 59  Prepare another 4-1/2" green wire, and connect it straight up from DR lug #7. (S).
- 60  Prepare a 5" white wire and connect it straight up from DL lug #3. (S). This is the (+) lug.
- 61  Prepare another 5" white wire and connect it straight up from the DR (+) lug #6. (S).
- 62  Lift the green wire from between the input sockets straight up. Select the 4 large capacitors and place them fully down against the chassis in their brackets. Make sure no wires are trapped. Rotate them so that the positive (+) terminal marked on each capacitor is positioned according to the pictorial diagram. Note that they are not all the same.
- 63  Select the PC-41 circuit board assembly and note that it will be installed with the components down, and the "INPUT GND" reference to the rear. All wires will connect to it from the **underside**. Select the Red/Yellow transformer lead and connect it from below to the hole in the center of the board between the two capacitors. (S). Place the board on top of the 4 large capacitors with the Red/Yellow lead passing between C1 and C3. Do **not** place the lead between the transformer and C3.
- 64  Select the 8 short #10 SEMS screws with lockwashers attached and fasten the board to the capacitors. Now **tighten** the 4 capacitor clamp screws.
- 65  Select the green wire from between the input sockets, and connect it to the Input Ground hole at the rear of PC-41. (S).
- 66  Twist together the two Blue transformer leads and connect one to each of the two holes marked 'AC' in the left front corner of the board. Solder both.
- 67  Connect the green wire from output terminal LB on the rear of the chassis to the inner hole marked GND near the left center edge of the board. (S). This is on the board's main left-to-right circuit path.
- 68  Select the green wire which is at the right rear of the chassis (coming from RB) and connect it to the inner GND hole on the right edge of the board. (S).
- 69  Select the green wire from DR lug 7 and connect it to the hole in the adjacent (but separate) circuit pad on the edge of the board labelled B-. (S). This is one of two holes which are connected to the front right capacitor screw terminal.

- 70  Select the white wire from DR (+) lug 6 and connect it to the forward hole marked B+ on the board. (S). This hole is connected to the capacitor screw at the right rear.
- 71  Select the white wire from DL (+) lug 3 and connect it to the rear B+ hole on the center left edge. (S).
- 72  Select the green wire from DL lug 2 and connect it to the forward B- hole on the left. (S).
- 73  Select the right module (thermal breaker to the right) and observe the location of the holes 'B' and 'G', near the center of the board. G is at the base of the tall capacitor. With your soldering iron and a wooden toothpick, make sure these holes are clear, as well as the #1 and #2 holes at the top of the board. Avoid contacting any components with the hot soldering iron. Select the long red and black pair at the right rear of the chassis (coming from MS lug 5), and with the module alongside the chassis, bring the pair behind or under all the wires attached to the module. (This pair should be closest to the circuit board.) Connect the black wire to hole G. (S). Connect the red wire to hole B. (S). Be careful you do **not** attach it to hole A on this module.
- 74  Select 2 sheet metal screws and very loosely attach the module to the chassis. Make sure no wires are trapped underneath, or between the chassis and heat sink. Connect the twisted pair of white wires to the lugs on the thermal breaker TB. Solder both.
- 75  Attach the white wire which extends to the rear of the module from hole 7 to RF lug #2. (S).
- 76  Select the green wire with the hook in it from hole 8, and connect it to the center edge hole marked GND. (S).
- 77  Select the twisted pair, and connect the green wire to the front hole B--. (S). Connect the white wire to the adjacent hole B+ +. (S).
- 78  Select the green wire from hole 11 and connect it to the B- hole which is the third hole from the front. (S).
- 79  Connect the remaining white wire from hole #4 to the remaining B+ hole near the rear of the board. (S).
- 80  Select 2 sheet metal screws and secure the module to the chassis, tightening all 4 screws. Select the red/black pair from MS switch lugs 1 and 2 which went to the left. Connect the black wire to hole #2 at the top of the module circuit board. (S). Connect the red wire to hole #1. (S).
- 81  Select the left module and clear holes A, G, 1 and 2. Note that hole A is located below hole B. Place the module alongside the chassis and select the longer red/black pair which is connected to MS lug 4. Place the pair behind or beneath the wires connected to the module and connect the black wire to hole G. (S). Connect the red wire to hole A. (S). Make **no** connection to hole B on this module.
- 82  With 2 sheet metal screws, loosely attach the module. Be sure no wires are trapped. Connect the white pair to the thermal breaker lugs and solder both.
- 83  Connect the white wire which points to the rear from hole 7 to LF lug #1. (S).
- 84  Select the green wire which was bent towards the rear from hole 11, and connect it to the B- hole near the rear corner of the board. (S).
- 85  Select the green wire with the hook (from hole 8) and connect it to the GND hole near the center edge. (S).
- 86  Select the white wire from hole 4 and connect it to the remaining B+ hole. (S).
- 87  Select the green/white pair and connect the white wire to B+ +. (S). Connect the green wire to B- -. (S). Cut off all the wire stubs on PC-41 close to the board.
- 88  Select 2 sheet metal screws and secure the module by tightening all 4 screws. Connect the black wire of the remaining pair to hole #2 at the top of the board. (S). Connect the red wire to hole #1. (S).
- 89  Select the 10 ampere fuse and install it in the fuse clip near the power switch. Install the two 2 ampere fuses in the speaker fuse holders on the rear of the chassis. See the Operation section of this manual for more information on choosing appropriate fuses for speaker protection.
- Turn the amplifier upside down, and shake it to dislodge any debris such as wire clippings, etc. Check all connections to make sure they are securely soldered, and that no adjacent connections are likely to touch. Particularly check the disc capacitors on top of the rectifier blocks DL and DR; switch MS; the power switch; and look down inside the modules behind the circuit boards to make sure no bare leads there can touch other than their intended terminals.
- Place the red/black pairs which go to the center of each circuit board about 1" out from the board, and then tuck the excess length down into the rear corners of the chassis. Near switch MS these pairs have the black wires unconnected. Make sure that no bare stub protrudes from the black insulation where it might contact another terminal. The red/black input pairs to the top of each board should be placed about 1" out from the board, **not** down against the chassis, and away from the center power supply components as much as possible.
- 90  Insert the plastic caps in the holes in the cover, slide the cover in place, and fasten it with the 8 sheet metal screws. Remove the backing from the serial number label and apply it to the bottom at the center rear (if this was not already installed at the factory).
- You may wish to secure the small plastic insulated screwdriver to the bottom with tape. It is necessary at such time as you may wish to make the Excelinear adjustment to match your amplifier precisely to your speakers. This refined adjustment is described in the Operation section of this manual. Regardless of this adjustment, however, your amplifier is assured of meeting all performance specifications, and will provide demonstrably more accurate sound reproduction.
- Congratulations on a job well done!

## AC LINE CONNECTIONS FOR OVERSEAS USE

The power transformer supplied in XL-280 amplifiers sold in the USA is intended for 120 volt, 60 Hz operation only. For use with other voltages, an export version is supplied with multi-voltage transformer and the requisite additional 2-lug terminal strip, hardware, the higher voltage disc capacitor for the power switch, and a 5 ampere slo-blo type fuse. The terminal strip is mounted to the left of the power transformer. The schematic diagram details the series or parallel transformer winding combinations which are represented pictorially here. Note that extra wire jumpers are added in some cases. The 5 amp fuse should replace the 10 amp line fuse when wired for 200 to 240 volt operation.

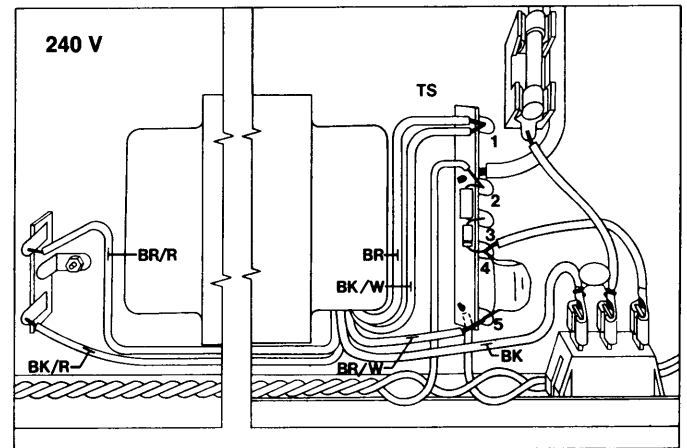
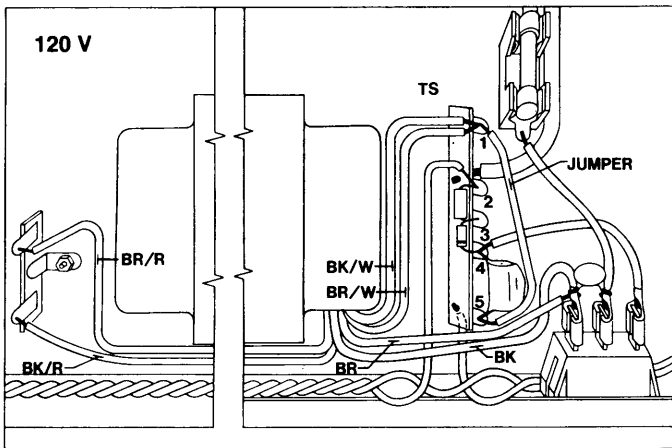
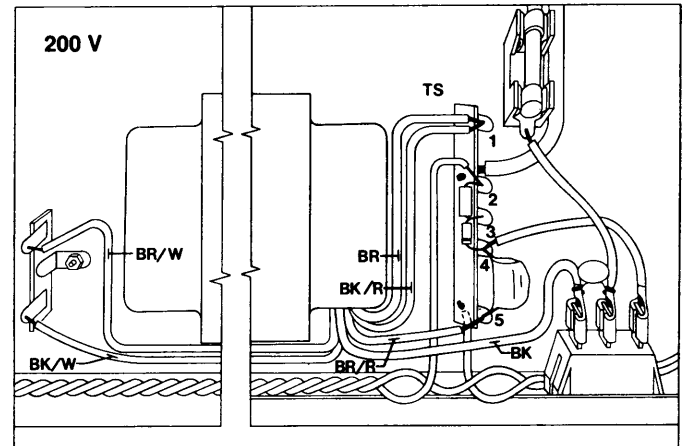
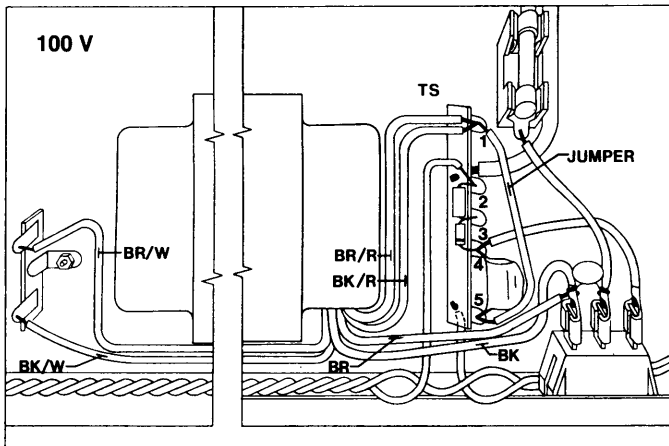
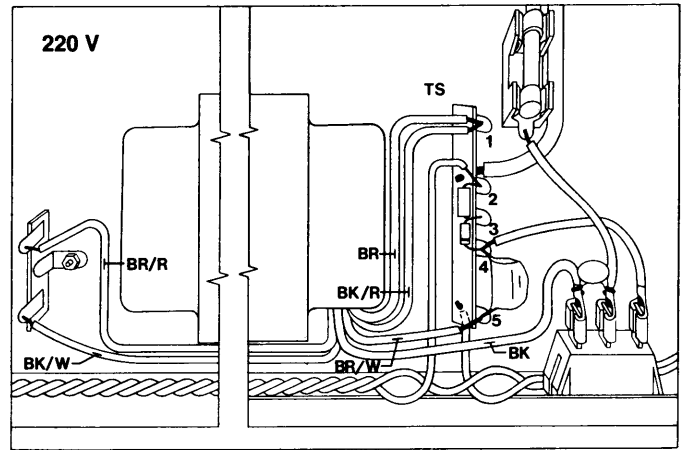

# COMPONENT PARTS LIST

All resistors are 1/4 watt 5% carbon film unless specified otherwise

	Part No.		Part No.		
R1	2,210 ohms, 1/4w, metal film, 1%	RM031	C1	47 pF, 500v, 3%, polypropylene	CP117
R2	47,500 ohms, 1/4w, metal film, 1%	RM036	C2	0.33 mfd, 63v, polyester	CE127
R3	110,000 ohms, 1/4w, metal film, 1%	RM061	C3	1 nF, 250v, 10%, polypropylene	CP136
R4	47,500 ohms, 1/4w, metal film, 1%	RM036	C4	10 nF, 160v, 10%, polypropylene	CP135
R5	27,000 ohms	RC075	C5	1 nF, 250v, 10%, polypropylene	CP136
R6	47,500 ohms, 1/4w, metal film, 1%	RM036	C6	1 nF, 250v, 10%, polypropylene	CP136
R7	1,000 ohms, 1/4w, metal film, 1%	RM021	C7	10 pF, 500v, 10%, mica	CM127
R8	1,000 ohms, 1/4w, metal film, 1%	RM021	C8	1000 mfd, 6.3v, non-polar electrolytic	CN111
R9	1,000 ohms, 1/4w, metal film, 1%	RM021	C9	100 nF, 100v, 10%, polycarbonate	CC125
R10	1,000 ohms, 1/4w, metal film, 1%	RM021	C10	330 pF, 630v, 3%, polypropylene	CP134
R11	47 ohms	RC039	C11	120 pF, variable	CZ130
R12	47 ohms	RC039	C12	150 pF, 500v, 5%, mica	CM116
R13	47 ohms	RC039	C13	100 nF, 100v, 10%, polycarbonate	CC125
R14	47 ohms	RC039	C14	150 pF, 500v, 5%, mica	CM116
R15	68 ohms	RC073	C15	100 nF, 100v, 10%, polycarbonate	CC125
R16	1,000 ohms, 1/4w, metal film, 1%	RM021	C16	100 nF, 100v, 10%, polycarbonate	CC125
R17	1,000 ohms, 1/4w, metal film, 1%	RM021	C17	100 mfd, 100v, electrolytic	CL122
R18	330 ohms	RC034	C18	100 mfd, 100v, electrolytic	CL122
R19	330 ohms	RC034	C19	120 pF, 500v, 10%, mica	CM128
R20	270 ohms	RC029	C20	100 nF, 100v, 10%, polycarbonate	CC125
R21	270 ohms	RC029	C21	100 nF, 100v, 10%, polycarbonate	CC125
R22	100,000 ohms	RC017	C101	910 pF, 100v, 2%, mica	CM124
R23	47,500 ohms, 1/4w, metal film, 1%	RM036	C102	100 nF, 100v, polyester	CE115
R24	47,500 ohms, 1/4w, metal film, 1%	RM036	C103	100 nF, 100v, polyester	CE115
R25	3,320 ohms, 1/4w, metal film, 1%	RM033	C201	470 mfd, 100v, electrolytic	CL157
R26	2,210 ohms, 1/4w, metal film, 1%	RM031	C202	470 mfd, 100v, electrolytic	CL157
R27	270 ohms	RC029	C203	10 nF, 1000v, disc	CZ112
R28	47,500 ohms, 1/4w, metal film, 1%	RM036	C204	7800 mfd, 75v, electrolytic	CL156
R29	47,500 ohms, 1/4w, metal film, 1%	RM036	C205	7800 mfd, 75v, electrolytic	CL156
R30	47,500 ohms, 1/4w, metal film, 1%	RM036	C206	7800 mfd, 75v, electrolytic	CL156
R31	680 ohms	RC059	C207	7800 mfd, 75v, electrolytic	CL156
R32	330 ohms	RC034	C301	10 nF, 1000v, disc	CZ112
R33	4.7 ohms	RC012	C302	10 nF, 1000v, disc	CZ112
R34	47 ohms, carbon composition	RZ011	C303	5 nF, 1000v, disc	CZ113
R35	47 ohms, carbon composition	RZ011	C304	390 nF, 100v, polyester	CE117
R36	220 ohms	RC063			
R101	470 ohms, 1/2w	RD117	D1	1N4148 Diode	QD116
R102	470 ohms, 1/2w	RD117	D2	1N4148 Diode	QD116
R103	470 ohms, 1/2w	RD117	D3	1N5245B Zener Diode, 15v	QD112
R104	220 ohms, 1/2w	RD114	D4	1N5245B Zener Diode, 15v	QD112
R105	220 ohms, 1/2w	RD114	D5	1N4003 Diode, 1A, 200PIV	QD115
R106	220 ohms, 1/2w	RD114	D6	1N4003 Diode, 1A, 200PIV	QD115
R201	5 ohms, thermistor	RZ029	D201	1N4003 Diode, 1A, 200PIV	QD115
R301	1 megohms, 1/2w	RD113	D202	1N4003 Diode, 1A, 200PIV	QD115
			D203	1N4003 Diode, 1A, 200PIV	QD115
			D204	1N4003 Diode, 1A, 200PIV	QD115
			D301	1N4003 Diode, 1A, 200PIV	QD115
Q1	2SK147 FET	QN138	DB301	Diode Bridge, 25A	QD117
Q2	2SK147 FET	QN138	DB302	Diode Bridge, 25A	QD117
Q3	2SJ72 FET	QP134			
Q4	2SJ72 FET	QP134	F1	7A, AGC/3AG	SFO39
Q5	2N5550	QN128	F2	7A, AGC/3AG	SFO39
Q6	2N5550	QN128	F301	10A, Slo-Blo ABC/3AB	SF038
Q7	2N5401	QP122	F302	5A, Slo-Blo ABC/3AB	SF018
Q8	2N5401	QP122	F303	2A, AGC/3AG (size optional)	SF011
Q9	2N5550	QN128			
Q10	2N5401	QP122	P1	1000 ohms, variable	RP011
Q11	2N5415	QP123		<i>SWH-105</i>	
Q12	2N3440	QN125	S301	SPST, lighted rocker	SL111
Q13	NP2222A	QN124	S302	DPDT, slide	SZ122
Q14	2N3440	QN125			
Q15	2N5415	QP123	TB301	Thermal Breaker	SF024
Q101	2SK134 MOSFET	QN112	TB302	Thermal Breaker	SF024
Q102	2SK134 MOSFET	QN112			
Q103	2SK134 MOSFET	QN112			
Q104	2SJ49 MOSFET	QP112			
Q105	2SJ49 MOSFET	QP112			
Q106	2SJ49 MOSFET	QP112			
T301	Power Transformer, Domestic	TA145	J301	Input jack, phono, gold plated	XP017
T302	Power Transformer, International	TA146	J302	Output binding post, 5 way, red	XK012
			J303	Output binding post, 5 way, black	XK011



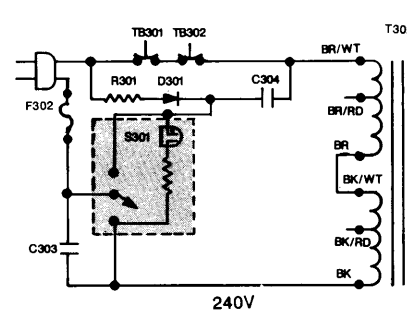
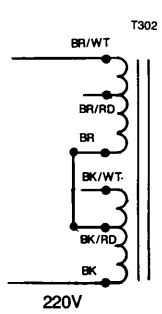
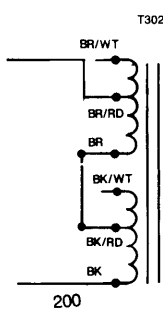
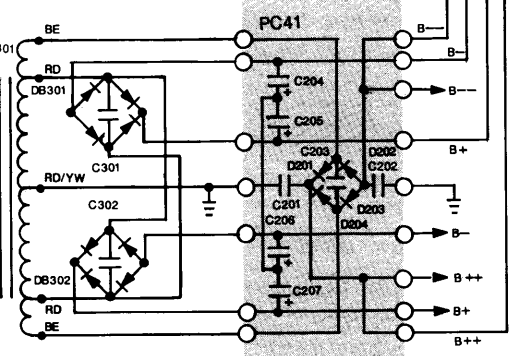
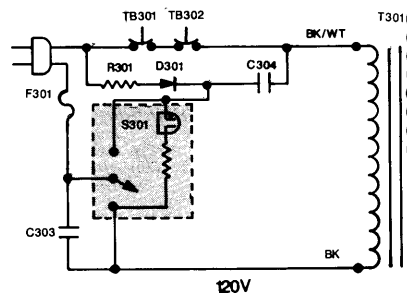
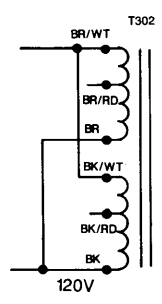
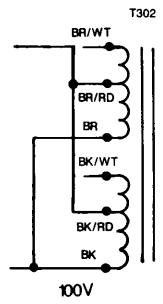
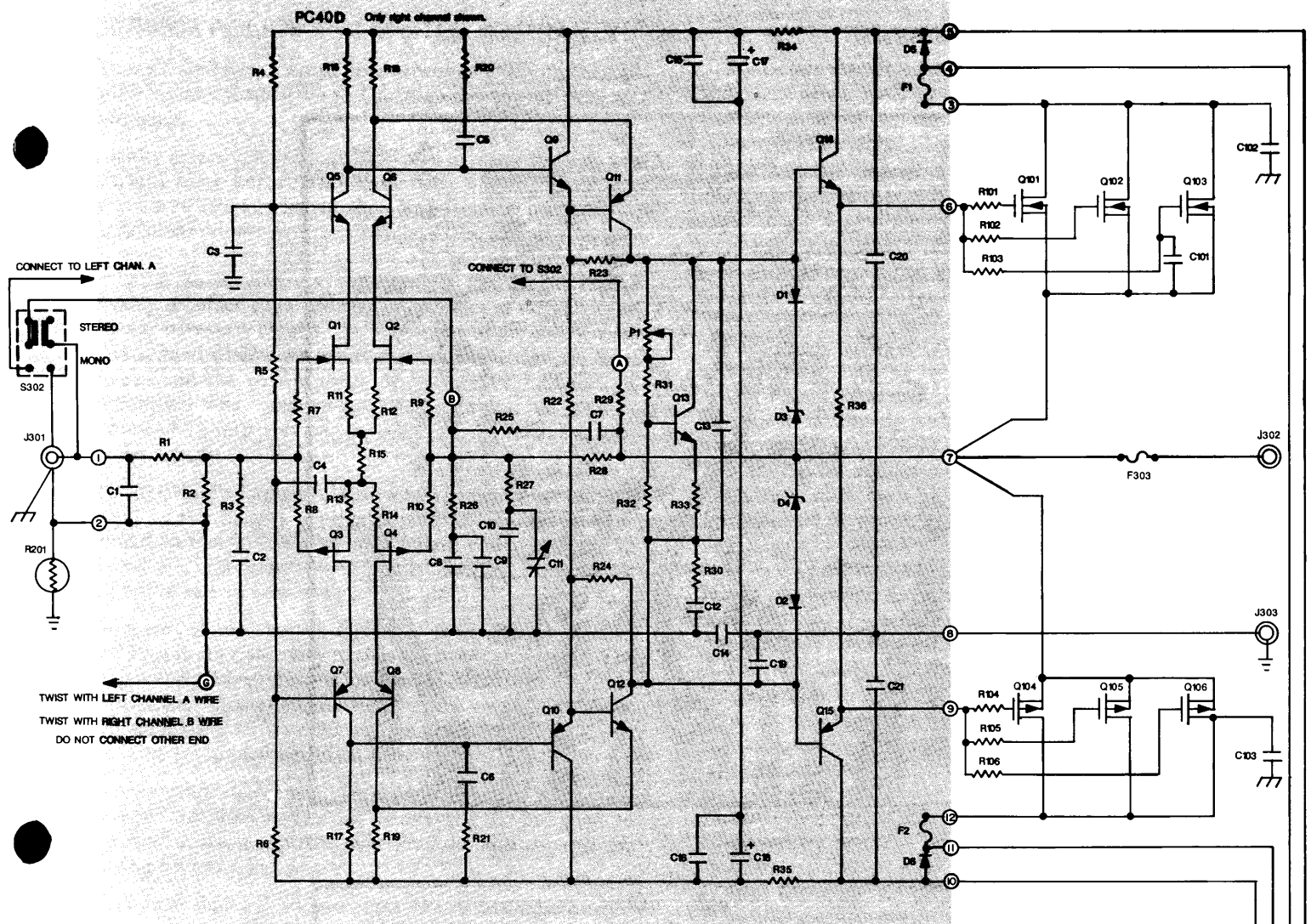

**SCHEMATIC  
DIAGRAM**  
© Copyright 1987.  
The David Hafler Company.  
All rights reserved.

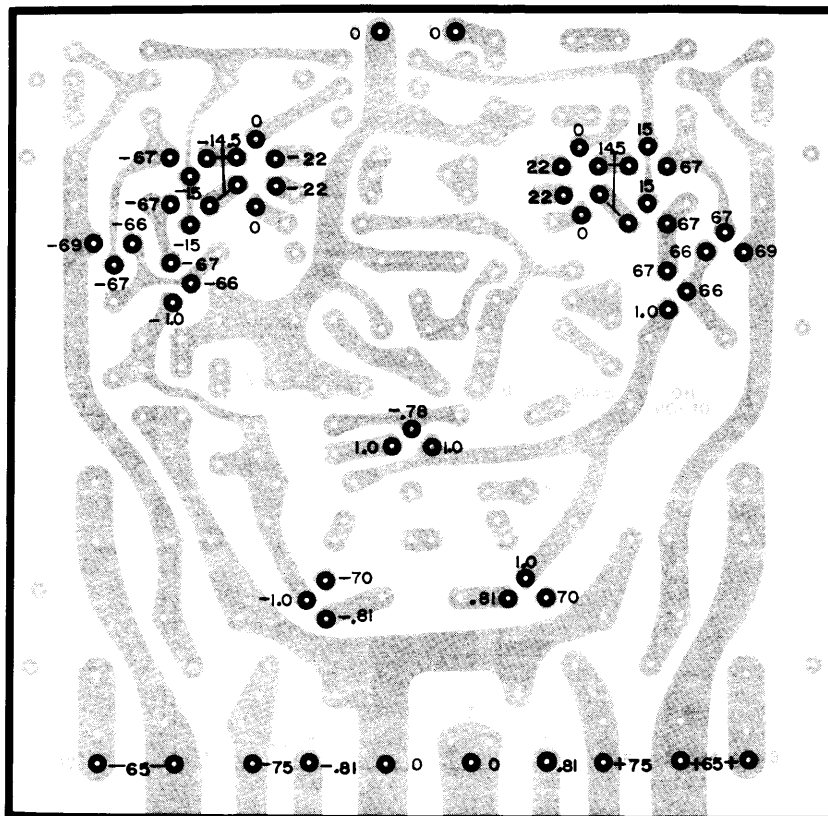
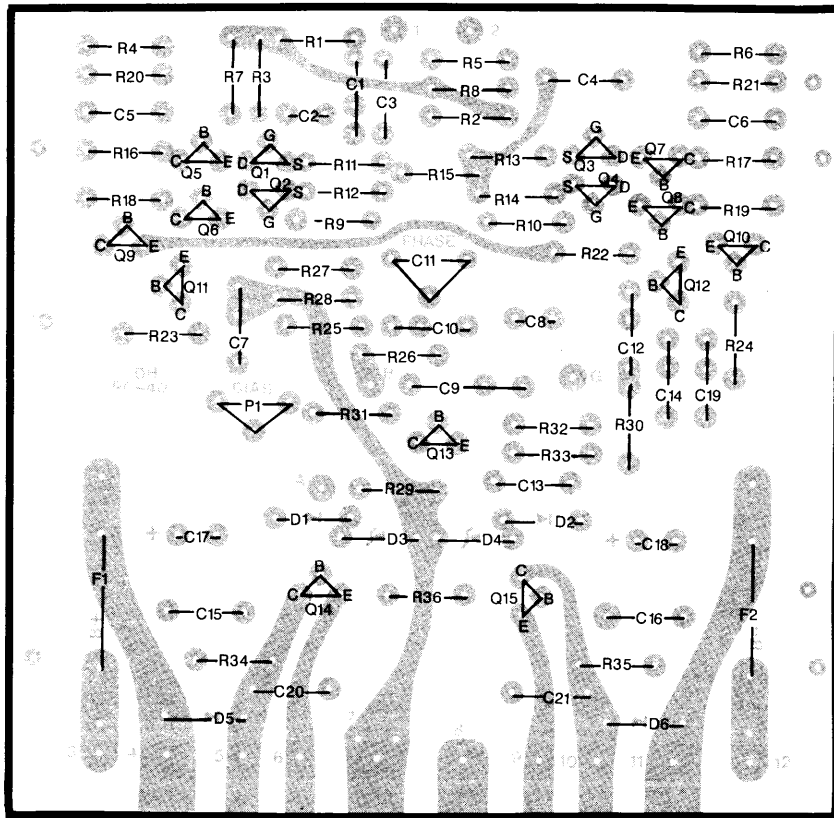

## SERVICE POLICY AND LIMITED WARRANTY

Your XL-280 Power Amplifier has been carefully engineered to provide many years of use without requiring any maintenance or servicing.

Factory assembled units are subjected to many physical and electrical tests before shipment. The amplifier module assemblies of kit units are similarly tested to meet performance specifications prior to packing. In spite of this, shipping damage does occur, a kit may not be assembled properly, or human error interferes, so service may be needed. The David Hafler Company provides complete service facilities at the factory to make any necessary repairs. Because many of the components in this refined design are not readily available through local sources, and the performance of the unit is likely to be compromised with "similar type" substitutions, we strongly recommend factory service, or obtaining the requisite parts from the factory.

It is the owner's responsibility to return or ship the unit freight prepaid to the factory service department and to provide insurance in transit. Units shipped freight collect will not be accepted. For units to be repaired under warranty, a copy of the dated bill of sale must accompany the unit.

Shipment should be via UNITED PARCEL SERVICE. Parcel Post is not a safe way to ship electronic equipment. The factory will not be responsible for damage caused by parcel post shipment and repairs will be made at the owner's expense. When shipping your XL-280 be sure to insure it for the full value of an assembled amplifier.

Use the complete original carton and all packing material to ship your amplifier. The kit packaging is designed to accommodate the completed unit. Enclose with the unit the following information:

1. Complete shipping address (Post Office box numbers are often not acceptable, except for correspondence).
2. The serial number.
3. Copy of dated bill of sale if repairs are to be made under warranty.
4. Description of the malfunction. If intermittent, be sure to indicate.
5. You may also wish to attach your address directly to the unit, or to the line cord.

All service work is guaranteed for 90 days.

Warranties apply to the original purchaser only. The warranty is void if the amplifier has been modified without factory authorization; or if parts have been substituted which, in the factory's judgment, are not suitable; or if the amplifier has been either physically or electrically abused, or used for some purpose for which it was neither designed nor intended. The warranty on the transformer is void if the leads have been cut too short for re-use.

Technical assistance to help you locate the source of a problem may be obtained by calling or writing the Technical Services Department. Phone (609) 662-6084 between 8 A.M. and 4 P.M., eastern time. It is helpful to know the serial number of the unit, and the results of any tests you have performed. However, we do not recommend that you attempt your own servicing unless you are knowledgeable in this regard.

## SERVICING AN AMPLIFIER

For factory assembled units which are not under warranty, the same provisions apply as for kits, described here. Because kit builders often wish to diagnose and repair their own units, some choices are available.

If a defective component is located, that **individual** part (not the complete circuit board) may be returned to the factory, along with the unit's serial number and date of purchase, and it will be replaced at no charge within the warranty period.

If you are certain that the problem is confined to one of the output modules (circuit board, heat sink, and output transistors), you may remove and return only the module for service (only to the factory). Be sure the components are well protected for shipping by a surrounding sleeve of cardboard which rests against the heat sink and projects to shield the components. Properly packed and insured for \$175, this can be sent by parcel post as well as UPS if necessary. A service fee of \$35 should be anticipated for every module, since a fault elsewhere could have inflicted damage to it. Because other faults cannot be ascertained, and because we have no control over its proper reinstallation, the service warranty on a separate module is limited to assurance of its proper functioning when it leaves our service facility. All are routinely tested to meet specifications. If you believe the fault is the factory's warranty responsibility, include the serial number and the bill of sale.

The complete amplifier may always be returned for service to the factory or to a factory authorized service facility. Only a complete amplifier can be fully checked and given a 90 day service warranty. The current factory rate is \$40 per hour, and service can be expedited if you send a money order for \$50 with the unit, which will likely cover packaging and return shipment. Personal checks must first clear. VISA and Mastercharge can be processed by phone — please give us your daytime phone number.

Most servicing can be completed in one hour. If the sole cause of a problem under warranty is a defective part, the unit will be repaired and returned to you transportation prepaid, and any submitted service fee, **less a charge for packing and shipping** will be returned to you. At the sole discretion of the factory service department, if the time required for diagnosis, repair and testing, and the nature of the malfunction warrants it, a portion of the submitted fee may be rebated. Special charges for expedited service or shipment, or overseas delivery are your responsibility.

## WARRANTY FOR KIT-BUILT UNITS

The parts in an XL-280 kit are warranted for a full year from the purchase date. Shipping charges, and labor charges to repair a kit are not included. The warranty is void if the kit has not been completely assembled, or if other than rosin core solder has been used. Units assembled with acid core solder or paste flux will be returned unserviced.

## WARRANTY FOR FACTORY ASSEMBLED UNITS

The XL-280 is warranted for 3 full years from the purchase date including parts and labor and normal shipping costs from the factory to the owner within the continental U.S. The owner is responsible for returning the unit to the factory and must submit a copy of the dated bill of sale.

This warranty gives you specific legal rights. You may also have other rights which vary from state to state.

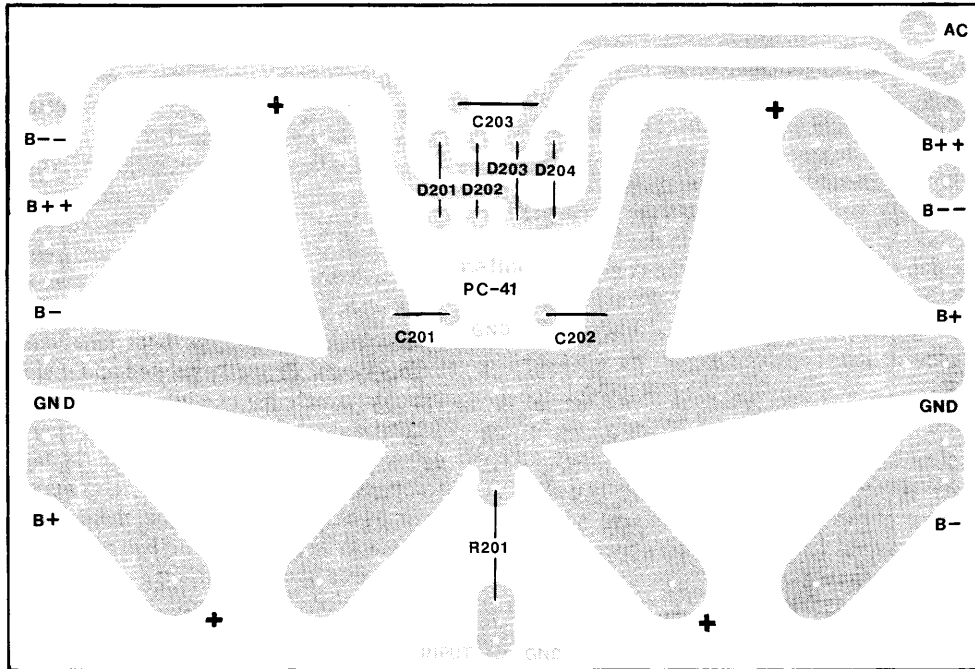

View of top of board.

