



User Manual

Model: FI9821P

Indoor HD Pan/Tilt Wireless IP Camera with P2P

(For Windows & Mac OS)



Black



White

Table of Contents

| | |
|---|----|
| Security Warning..... | 1 |
| 1 Overview..... | 1 |
| 1.1 Key Features..... | 2 |
| 1.2 Read Before Use..... | 2 |
| 1.3 Package Contents..... | 2 |
| 1.4 Physical Description..... | 3 |
| 1.5 SD Card..... | 4 |
| 2 Access the IP Camera..... | 5 |
| 2.1 Access the Camera in LAN..... | 5 |
| 2.2 Access the Camera in WAN..... | 6 |
| 2.3 Using the VLC player..... | 11 |
| 2.4 IP camera connection to the server..... | 13 |
| 3 Surveillance Software GUI..... | 14 |
| 3.1 Login Window..... | 14 |
| 3.2 Setup Wizard..... | 15 |
| 3.3 Surveillance Window..... | 18 |
| 4 Advanced Camera Settings..... | 25 |
| 4.1 Status..... | 25 |
| 4.2 Basic Settings..... | 27 |
| 4.3 Network..... | 36 |
| 4.4 Video..... | 53 |
| 4.5 Alarm..... | 58 |
| 4.6 Record..... | 61 |
| 4.7 PTZ..... | 64 |
| 4.8 Firewall..... | 69 |
| 4.9 System..... | 70 |
| 5 Playback..... | 74 |
| 6 Phone Apps..... | 76 |
| 7 Appendix..... | 76 |
| 7.1 Frequently Asked Questions..... | 76 |
| 7.2 Default Parameters..... | 84 |
| 7.3 Specifications..... | 84 |
| 7.4 CE & FCC..... | 85 |
| 8 Obtaining Technical Support..... | 86 |

Security Warning

Safeguarding Your Privacy

Foscam cameras require good security practices to safeguard your privacy. You can help protect your camera by changing the default username and/or password. Input a username and/or password that is at least 8 – 10 characters or longer. Try to use a combination of lower-case and upper-case letters as well as numbers and special characters. The more complex the username and password, the harder it will be to guess by an unauthorized user.

You should update your camera regularly at <http://www.foscam.us/firmware.html>. Make sure your camera has the latest firmware installed for your specific camera model. The latest firmware for Foscam cameras utilizes protection against various types of online hacking, cracking, and unauthorized access. Doing so will make your device more secure, may add features, and will contain bug fixes to make your device work faster.

1 Overview

FOSCAM Indoor HD Pan/Tilt Wireless IP Camera with P2P is an integrated wireless IP Camera with a color CMOS sensor enabling viewing in High Definition resolution. It combines a high quality digital video camera, with a powerful web server, to bring clear video to your desktop and mobile devices from anywhere on your local network or over the Internet.

Thanks to the P2P easy access technology, you don't need to do complicated Port Forwarding and DDNS settings, you just need to scan the QR code on the bottom of the camera to connect it on smart phone, or input the UID on CMS software to do remote access.

With flexible 300-degree pan and 120-degree tilt, FOSCAM IP Camera gives users more comprehensive control over a monitored site. The camera supports H.264 video compression technology, dramatically reducing file size and saving network bandwidth.

The camera is based on the TCP/IP standard. There is a WEB server inside which could support Internet Explore. Therefore the management and maintenance of your device is simplified by using the network to access the website of your camera.

The camera is designed for indoor surveillance applications such as home, retail store and office. Controlling the camera and managing images are simplified by using the provided web interface across the network utilizing wired or wireless connectivity.

FOSCAM provides Smart Phone App for Android and iPhone users, please search and install Foscam Viewer on Google Play for Android devices, search and install Foscam Viewer on App Store for iOS devices, then you can view your camera anywhere, anytime on your smart mobile devices.

Please note to change your default username and password once you have initially logged into your Foscam camera. Changing your default user settings enables better protection against any types of attacks against your camera.

1.1 Key Features

- Standard H.264 video compression algorithm to satisfy the transmission of high definition video in narrow bandwidth network
- P2P feature for easy access
- Megapixel HD video
- Pan 300 degree, tilt 120 degree
- Supports IE/Firefox/Google/Safari browser
- Supports WEP,WPA-PSK and WPA2-PSK Encryption
- Wireless connection is compliant with IEEE 802.11b/g/n Wi-Fi, up to 150Mbps
- IR night vision (Range: 8m)
- Supports image snapshot
- Supports dual-stream
- Supports SD Card storage up to 32GB
- Supports IR-Cut auto switch
- Embedded free FOSCAM DDNS(dynamic domain name service) Service
- Supporting the Third Party Domain Name Service
- Supports two-way audio
- Multi-level users management with password protection
- Motion detection alert via email or upload image to FTP
- Providing free Android and iPhone APP for viewing live video
- Providing free Central Management Software to manage and monitor multiple cameras

1.2 Read Before Use

Please first verify that all contents received are complete according to the Package Contents listed below. Before the IP Camera is installed, please carefully read and follow the instructions in the Quick Installation Guide to avoid damage due to faulty assembly and installation. This also ensures the product is used properly as intended.

1.3 Package Contents

| | |
|--------------------------------|-----------------------------|
| ● IP Camera × 1 | ● DC Power Adapter × 1 |
| ● Wi-Fi Antenna × 1 | ● Mounting bracket × 1 |
| ● Ethernet Cable × 1 | ● CD×1 |
| ● Quick Installation Guide × 1 | ● Security Warning Card × 1 |

1.4 Physical Description

Front Panel

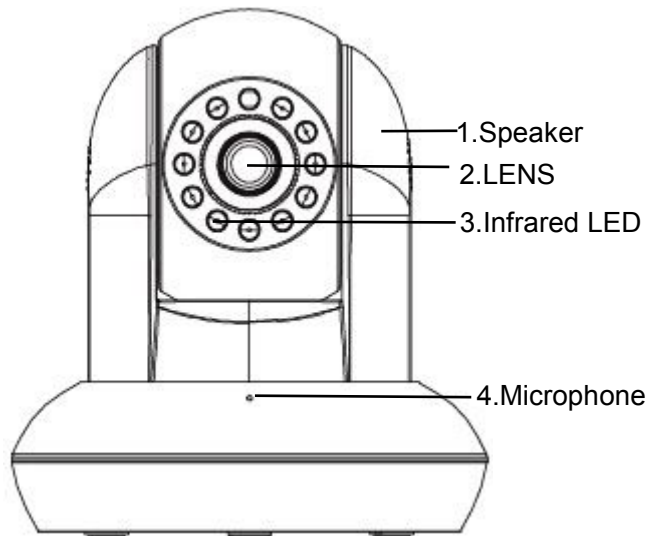

Figure 1.1

- 1.Speaker: Built-in speaker
- 2.LENS: Fixed focus lens.
- 3.Infrared LED: Infrared LEDs for night vision
- 4.Microphone: Built-in microphone

Rear Panel

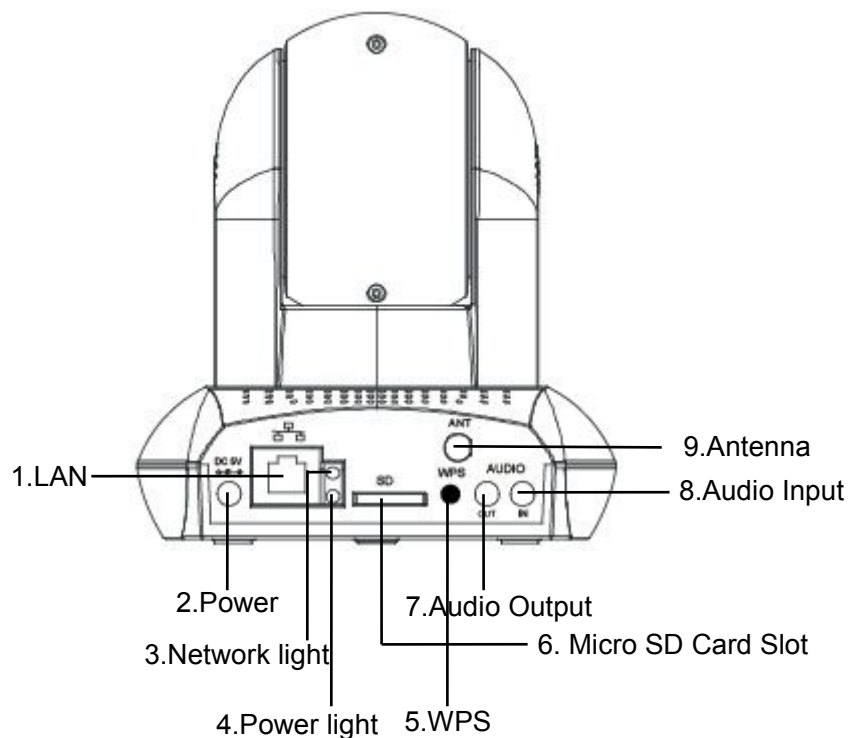

Figure 1.2

- 1.LAN: 10/100 Mbps RJ-45 port for wired connection
- 2.Power: DC 5V/2A Power supply
- 3.Network Light: The LED will blink slowly in wired connection, blink two times faster in wireless connection, blink four times faster when WPS
- 4.Power Light: If the power supply works fine, the light will turn on
- 5.WPS: Push the WPS button on the camera and wireless router in 1 minutes, the camera will connect the wireless router automatically, in WPS process, the Network Light will blink very fast
6. SD card Slot: Supports up to 32GB SD card for storing the video
- 7.Audio Output: This jack is used to plug an external speaker
- 8.Audio Input: This jack is used to plug an external microphone
- 9.Antenna: Used to connect external wireless antenna

Bottom View

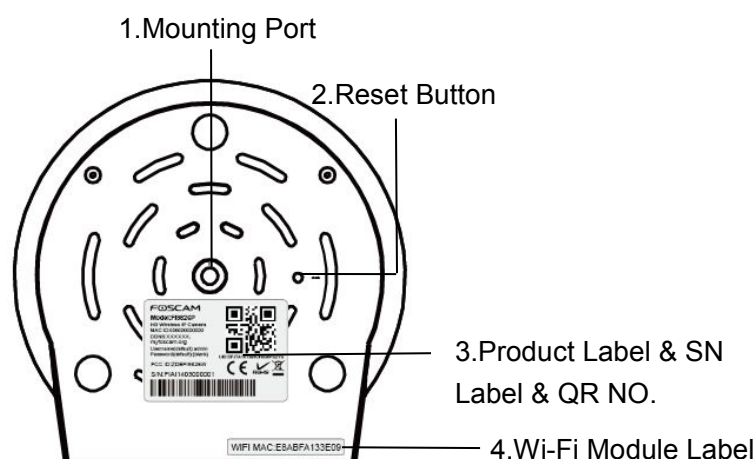

Figure 1.3

- 1.Mounting Port: Port for mounting bracket
- 2.Reset Button: Push and hold for more than 5 seconds to set the camera to factory default
- 3.Product Label: There are MAC address, DDNS URL, default username and password on the label
S/N Label: There is serial number of the camera on the label.
QR Code: Connect the camera via P2P.
- 4.Wi-Fi Module Label: There is Wi-Fi MAC address and serial number of the Wi-Fi module on the label

1.5 SD Card

This camera supports Micro SD Card and the max size of SD card must be under 32G.

When you plug in the Micro SD card during the camera work process, please reboot the camera again, or else the SD Card may be cannot work well.

Go to the **Settings**→**Status**→**Device Status** page, you can see the SD card status.

| Device Status | |
|---------------------|---------------|
| Alarm Status | Disabled |
| Record Status | Not Recording |
| SD Card Status | No SD card |
| SD Card Free Space | 0KB |
| SD Card Total Space | 0KB |
| NTP Status | Disabled |
| DDNS Status | Disabled |
| UPnP Status | Disabled |
| WiFi Status | Not connected |
| IR LED Status | Off |

The default storage path of alarm record files is SD card, when the available size of SD card is less than 256M, the old record files will be deleted automatically.

2 Access the IP Camera

This chapter explains how to access the camera through browser and RTSP player.

2.1 Access the Camera in LAN

This camera supports HTTP and HTTPS protocols, you can access the camera by two ways.

(1) http:// LAN IP + HTTP Port NO.

The default HTTP port no is 88. Double click the IP Camera Tool icon to run, and it should find the camera's IP address automatically after you plug in the network cable.



Figure 2.1

Double click the IP address of the camera; your default browser will open to the camera login page.

(2) https:// LAN IP + HTTPS Port NO.

The default Https port NO is 443. You can use the url to access the camera: https:// LAN IP + HTTPS port.

Go to **Settings - Network - Port** panel, you can see and change the http and https port NO.

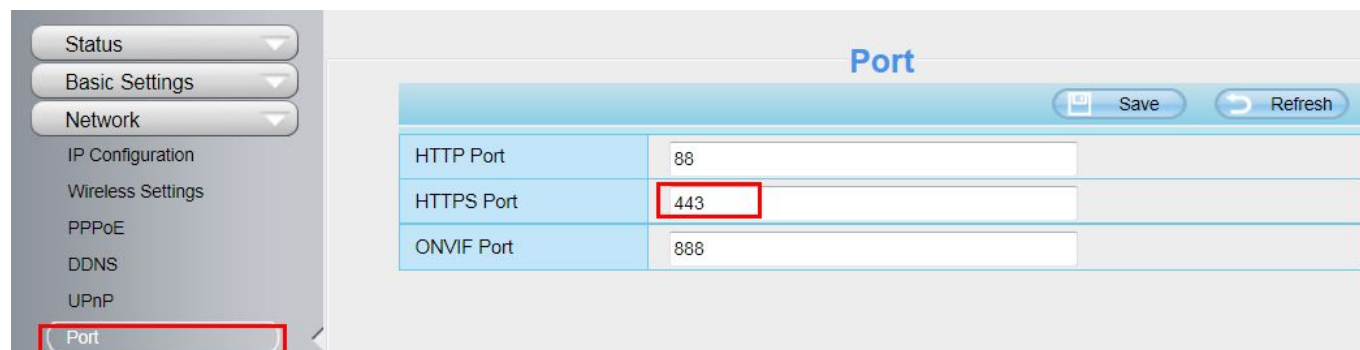

Figure 2.2

2.2 Access the Camera in WAN

2.2.1 Static IP Addresses

Users who have static IP addresses do not need to set DDNS service settings for remote access. When you have finished connecting the camera using the LAN IP address and port forwarding, you can access the camera directly from the Internet using the WAN IP address and port number.

How to Obtain the WAN IP address from a public website

To obtain your WAN IP address, enter the following URL in your browser: <http://www.whatismyip.com>. The webpage at this address will show you the current WAN IP.



Figure 2.3

Access your IP Camera from the Internet

You can access the IP Camera from the Internet (remote access). Enter the WAN IP address and port number in your standard browser. For example, you would enter [http:// 183.37.28.254:85](http://183.37.28.254:85)

NOTE:

Make sure port forwarding is successful. You can do port forwarding two ways.

1) Login to your router to enable the “UPNP” function. You can then login to the camera as administrator, choose **Network**, and then choose **UPnP** to enable UPnP. Make sure that the status of UPnP reads “UPnP Successful” on the Device Status page.

2) Do port (HTTP port and Media port) forwarding manually.

If your router has a Virtual Server, it can do port forwarding. Add the camera’s LAN IP and port which you had set earlier to your router’s port forwarding settings.

NOTE:

If you plug the camera into a router, it will have a dynamic IP address and you need to set DDNS service settings to view it remotely.

2.2.2 Dynamic IP Addresses

DDNS is a service that allows your IP Camera, especially when assigned with a dynamic IP address, to have a fixed host and domain name. This means that even though your WAN IP address is constantly changing, you will have a fixed hostname you can use to access your cameras at all times. You can access the camera directly from the Internet using the hostname and port number.

What is the HTTP Port NO.?

Default HTTP Port is 88

All cameras have the default HTTP port of 88. For example, if the LAN IP link of the camera is <http://192.168.1.110:88>, this means that the camera's HTTP port is 88. You can change port 88 to another port if you'd like such as 2000 or 8090, which will not be conflict with other existing ports like 25, 21, 10000. Here you can set the port no. between 1 and 65535.

Change the default http no.88 to another one.

How to assign a different HTTP Port No. and fixed the LAN IP of the camera by the IP Camera Tool?

Step 1: Open the IP Camera Tool, select the camera you would like to change the port of, right click on the IP address, and click on "Network Configuration", this brings up the network configuration box as shown in Figure 2.4 and 2.5.

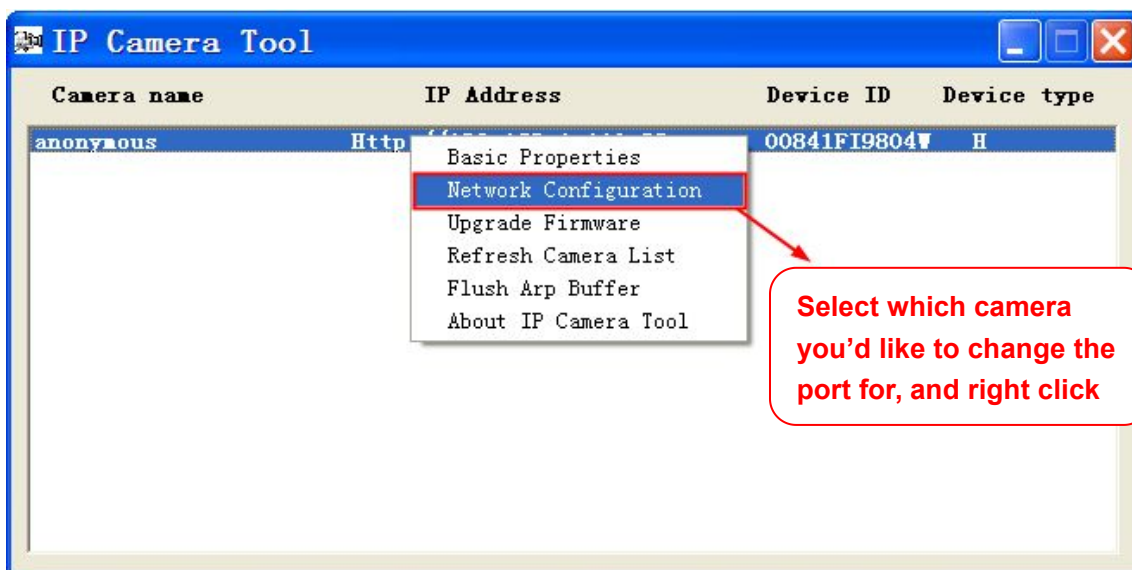

Figure 2.4

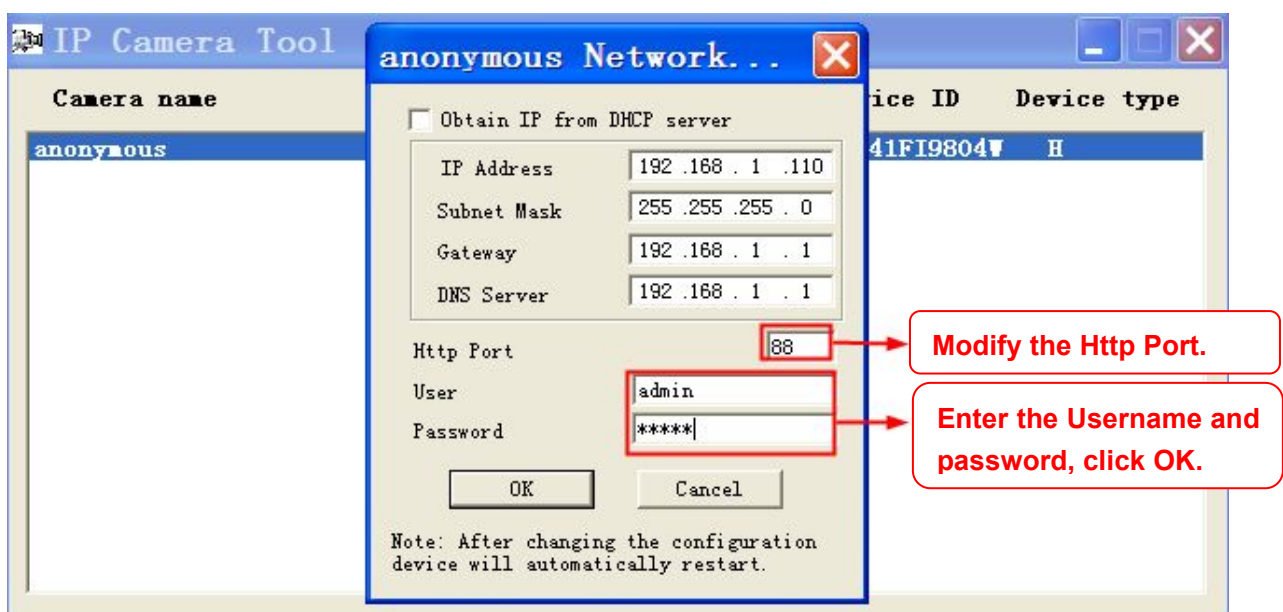
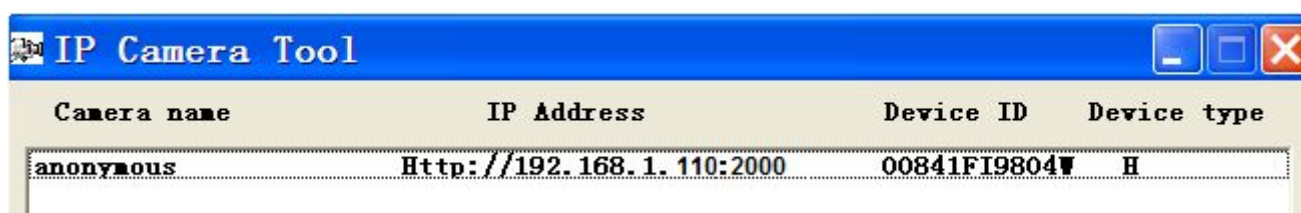

Figure 2.5

Step 2: Enter the username and password of the Administrator (default username is admin with a blank password), and click “OK” to apply changes.

Step 3: Wait around 10 seconds, you’ll see that the camera’s LAN IP address has changed. In our example it was changed to 2000, so we see <http://192.168.1.110:2000> in IP Camera Tool. Also, the LAN IP address is now fixed at a static IP address of <http://192.168.1.110:2000>. This IP address will not change even if the camera is powered off and back on, the camera will remain on this LAN IP address. This is very important that a static LAN IP address is set, or you may have problems later with remote access and seeing the camera remotely if the camera loses power and reconnects on a different LAN IP address. Make sure you set a static LAN IP address!



| Camera name | IP Address | Device ID | Device type |
|-------------|---------------------------|--------------|-------------|
| anonymous | Http://192.168.1.110:2000 | 00841FI9804W | H |

Figure 2.6

What is Port forwarding?

If you have never done port forwarding before, you can open and view the following link to understand the basic concept. Port forwarding allows for outside connections to access a specific device on your network from anywhere in the world. Every router automatically blocks any incoming connections for safety purposes. Using port forwarding, you are telling your router to allow a connection through a certain port (you can think of it as a gateway) into your router. You set this port to a specific device, in our case an IP Camera, so it can be accessed from anywhere in the world.

Click this link to learn more about port forwarding: <http://portforward.com/help/portforwarding.htm>

How do we configure Port Forwarding?

For this section, we will be using an example:

Let’s say the camera’s LAN IP address is <http://192.168.1.110:88>

Step 1: Login to the router, and go to your router’s port forwarding or port triggering menu. Sometimes this is also under the name of Virtual Server or NAT.

Using the Linksys brand router as an example, we would log into the router, and go to the Applications & Gaming menu. We would then click on the “Single Port Forwarding” sub-menu.

Step 2: Create a new column using the LAN IP address & HTTP Port of the camera within the router as shown below, then push OK or Submit to save your settings:

Wireless-N Home Router WRT120N

Applications & Gaming

Setup Wireless Security Access Restrictions Applications & Gaming Administration Status

Single Port Forwarding Port Range Forwarding Port Range Triggering DMZ QoS

Single Port Forwarding

Application Name

None

None

None

None

None

Foscam Cam

| External Port | Internal Port | Protocol | To IP Address | Enabled |
|---------------|---------------|----------|---------------|-------------------------------------|
| --- | --- | --- | 192.168.8. | <input type="checkbox"/> |
| | | | 192.168.8. | <input type="checkbox"/> |
| | | | 192.168.8. | <input type="checkbox"/> |
| | | | 192.168.8. | <input type="checkbox"/> |
| 2000 | 2000 | Both | 192.168.8.100 | <input checked="" type="checkbox"/> |
| | | Both | 192.168.8. | <input checked="" type="checkbox"/> |
| | | Both | 192.168.8. | <input type="checkbox"/> |

Help...

Fill the HTTP Port of the camera in the columns of External Port and Internal Port. Example: 2000

Assign a name for the port forward setting here

Fill in this section with the LAN IP of the camera; we would enter "100" for our example.

Figure 2.7

First method :

Use the embedded DDNS to access the camera via the Internet

Each Foscam camera has an embedded unique DDNS domain name, the format of this domain name is xxxxxx.myfoscam.org. On the bottom of the camera, you can see the domain name sticker with this information on it.

For example, we can use test09.myfoscam.org. In the camera, click Settings at the top, click "Network" on the left, then click "DDNS" to get to the DDNS settings page. Here you can see the unique domain name of your camera.

Status

Basic Settings

Network

IP Configuration

Wireless Settings

PPPoE

DDNS

UPnP

Port

Mail Settings

FTP Settings

DDNS

Save Refresh

Enable DDNS

Manufacturer's DDNS

Manufacturer's DDNS test09.myfoscam.org Restore DDNS to factory

Third Party DDNS

DDNS Server None

Domain

Figure 2.8

Now you can use "http://Domain name + HTTP Port" to access the camera via the Internet.

Take hostname test09.myfoscam.org and HTTP Port of 88 for example, the URL link to access the camera via the Internet would be http:// test09.myfoscam.org:88.

Second method :

Use the Third party DDNS to access the camera via the Internet

Step 1 Please go to the third party DDNS website(such as www.no-ip.com) to create a free hostname.

Step 2 DO DDNS Service Settings within the Camera

Please set DDNS Settings within the camera by hostname, a user name and password you've got from

www.no-ip.com

Take hostname ycxgwp.no-ip.info, user name foscam, password foscam2012 for example.

Firstly, goes to option of DDNS Settings on the administrator panel.

Secondly, select No-Ip as a server.

Thirdly, fill foscam as DDNS user, fill password foscam2012 as DDNS password, fill ycxgwp.no-ip.info as DDNS domain and server URL, Then click save to make effect. The camera will restart and to take the DDNS settings effective.

Fourthly, after the restart, login the camera, and go to option of Device Status on the administrator panel, and check if the DDNS status is successful.

If failed, please double check if you have input the correct hostname, user name, and password, and try to redo the settings.

NOTE:

If you have set Third Party DDNS successfully ,the Foscam Domain Name will be invalid. The Third Party DDNS and the Foscam Domain Name cannot work at the same time, the last time you configured will take effect.

2.3 Using the VLC player

This camera supports RTSP streaming, here you can view the camera using VLC player.

RTSP URL [rtsp:// \[user name\]\[:password\]@IP:HTTP port number/videosream](rtsp://[user_name][:password]@IP:HTTP_port_number/videosream)

The part in the square brackets may be omitted.

user name & password:

The user name and password to access the camera. This part can be omitted.

IP:

WAN or LAN IP address.

Videostream:

Here support three mode: videoMain, videoSub and audio. When the network speed is bad, here you had better select videoSub. If you select audio, you can only hear the sound but cannot see the video.

For example:

IP: 192.168.1.11

HTTP Port number: 88

User name: admin

Password: 123

Here I can enter one of the following URLs in the VLC.

- 1) rtsp://admin:123@192.168.1.11:88/videoMain
- 2) rtsp:// @192.168.1.11:88/videoMain
- 3) rtsp://:123@192.168.1.11:88/videoMain
- 4) rtsp://admin@192.168.1.11:88/videoMain

Open the VLC, and go to Media→Open Network Stream option, then enter the URL into VLC.

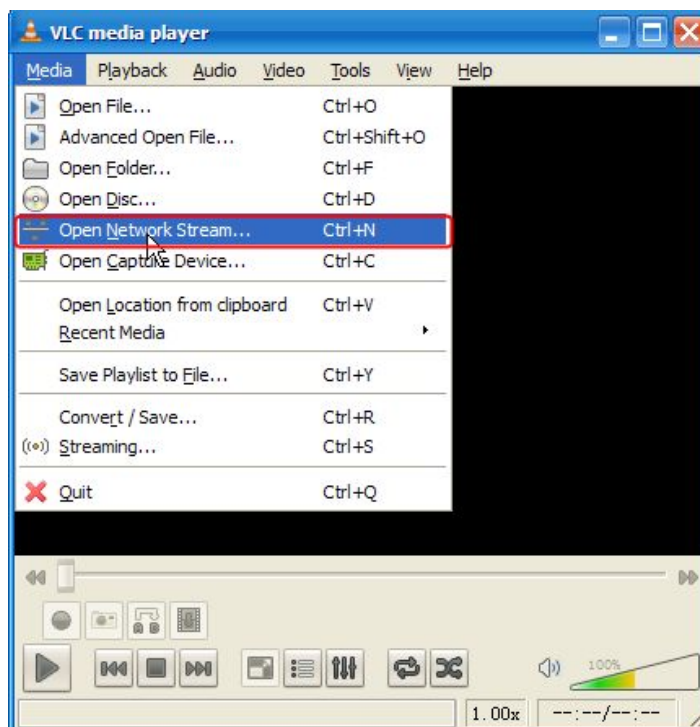

Figure 2.9

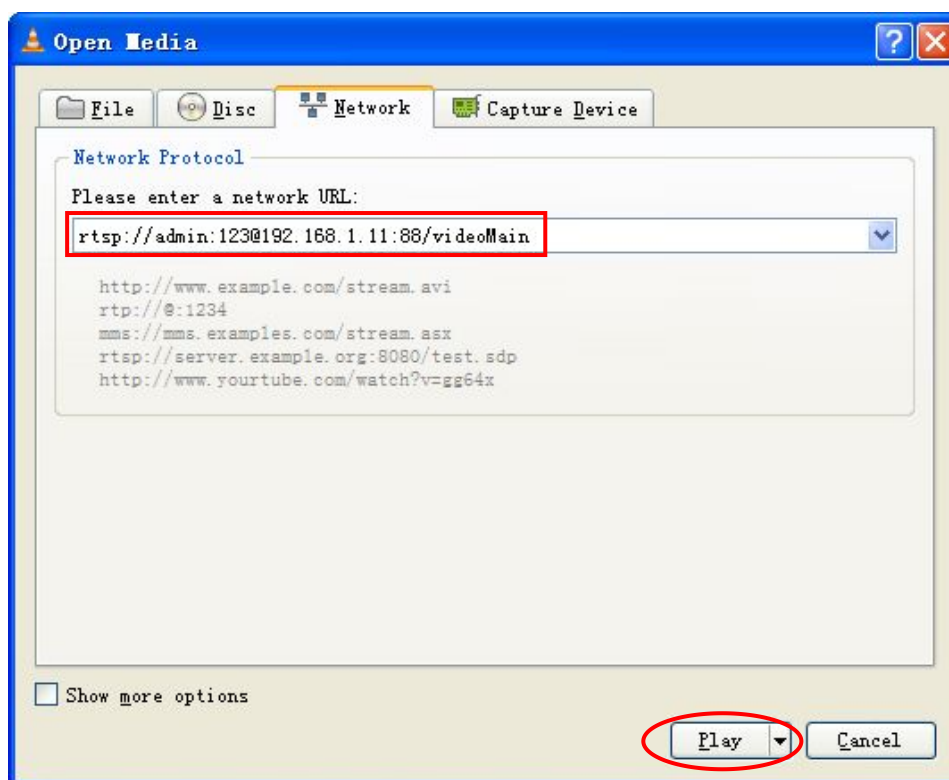

Figure 2.10

Sometimes you may need to enter the user name and password again. Click OK and you can see the real-time preview.



Figure 2.11

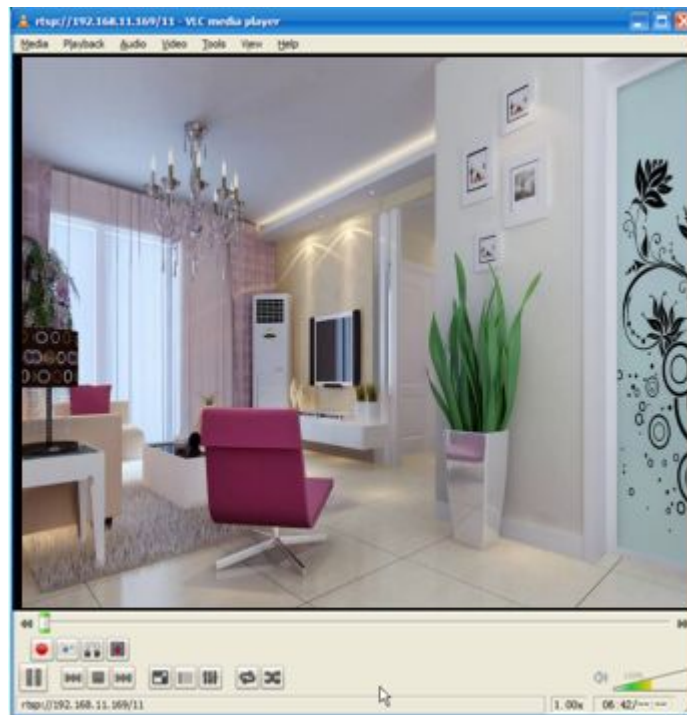

Figure 2.12

If you cannot play the video in the VLC player, please check the port mapping. You can read Quick Installation Guide about How to configure port forwarding.

NOTE:

If you modify the camera's username or password, you had better reboot the camera, or else the new username and password cannot take effect when you enter the authentication in the VLC.

2.4 IP camera connection to the server

Device supports ONVIF 2.2.1 protocol, You can easily access the NVR with ONVIF or server with ONVIF.

3 Surveillance Software GUI

Please refer to the Quick Installation Guide if you install the camera at first time. After finishing quick installation, you can take time to learn the operation of the software.

3.1 Login Window

Figure 3.1

Section1 Enter the User name and password

The default administrator username is admin with no password, please reset the password at first using and prevent unauthorized users login the camera (read chapter 3.2.4 about how to change).

Section2 Stream

The camera supports two stream modes: Main stream and Sub stream. If you want to access the camera form LAN, here you can select Main stream. If you want to access the camera from Internet, here we recommend Sub stream.

NOTE:

When the network bandwidth is badly you'd better select Sub Stream and the video will be more fluency.

Section3 Select the language

You can select the language you need via click on the language drop-down list to switch.

Section4 Login the camera

Click Login button and you will see the surveillance windows.(If login the camera for the first time, the page that modify the username and password will appears.)

NOTE:

When setting up your camera for the first time, it will request that you modify the default username and/or

password if both are still set to default. Input the new username and password, click "Modify" to complete the modification. You will now use the new username and password to login to the camera in the future.

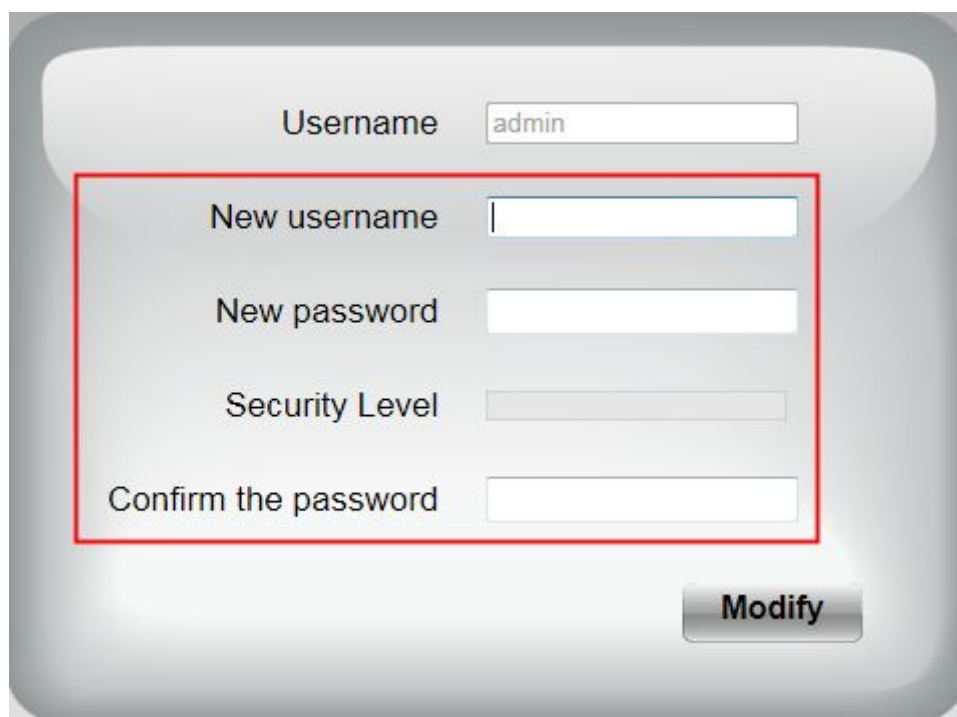

Username

New username

New password

Security Level

Confirm the password

Modify

Figure 3.2

Enter the New Username, New password and Confirm the password. Click **Modify** button, you will see the login page again.

3.2 Setup Wizard

After logging in for the first time, you will go to "Setup Wizard" automatically. Here you can set the basic parameters of camera, such as camera name, camera time, wireless settings, IP configuration.



Setup Wizard

Setup Wizard

Status

Basic Settings

Network

Video

Alarm

Setup Wizard

Setup Wizard - Start

Follow the guide to set your camera, click "Next" to start.

Please click the menu on the left for more settings.

Next

Figure 3.3

Device Name: You could give name for your camera.

Setup Wizard

Step 1 of 4 - Camera Name

| | |
|-------------|---|
| Camera Name | <input type="text" value="Anonymous"/> The maximum Device Name length is 20, support English, numbers, letters and symbols |
|-------------|---|

Figure 3.4

System Time: Select the time zone you need to set the date, time, format and so on.

Setup Wizard

Step 2 of 4 - Camera Time

| | |
|--|--|
| Time Zone | (GMT) Greenwich mean time; London, Lisbon, ▼ |
| Sync with NTP server <input checked="" type="checkbox"/> | |
| NTP Server | time.nist.gov ▼ |
| PC Time | <input type="text" value="2014-1-1"/> <input type="text" value="12"/> <input type="text" value="17"/> <input type="text" value="29"/> <input type="text" value="PM"/> <input type="button" value="Sync with PC"/> |
| Date Format | YYYY-MM-DD ▼ |
| Time Format | 12-hour ▼ |
| use DST <input type="checkbox"/> | |
| Ahead Of Time | <input type="text" value="0"/> Minute |

Figure 3.5

Wireless networks: Click “Scan” , find the SSID of your wireless router, select and enter the password.

Setup Wizard

Step 3 of 4 - Wireless Settings

Wireless Network List

| SSID(Network Name) | Encryption | Quality |
|--------------------|------------|---------|
| Tenda_373678 | WPA/WPA2 | |
| dlink-chenchen2.4G | WPA/WPA2 | |
| TP_LINK_TEST | WPA2 | |
| FOSCAM-docdev | WPA/WPA2 | |

1 Scan

| | |
|------------|---------------|
| SSID | FOSCAM-docdev |
| Encryption | WPA/WPA2 |
| Password | •••••••• |

3

2

The maximum password length is 63, including numbers, letters and symbols

Figure 3.6

IP: Set IP address of the camera. You could choose to obtain an IP automatically or set the IP address according to your needs.

Setup Wizard

Step 4 of 4 - IP Configuration

Obtain IP From DHCP

| | |
|----------------------|---------------|
| IP Address | 192.168.1.101 |
| Subnet Mask | 255.255.255.0 |
| Gateway | 0.0.0.0 |
| Primary DNS Server | 0.0.0.0 |
| Secondary DNS Server | 0.0.0.0 |

Note: Once you save your settings, the camera will restart.

Previous
Finish

Figure 3.7

3.3 Surveillance Window

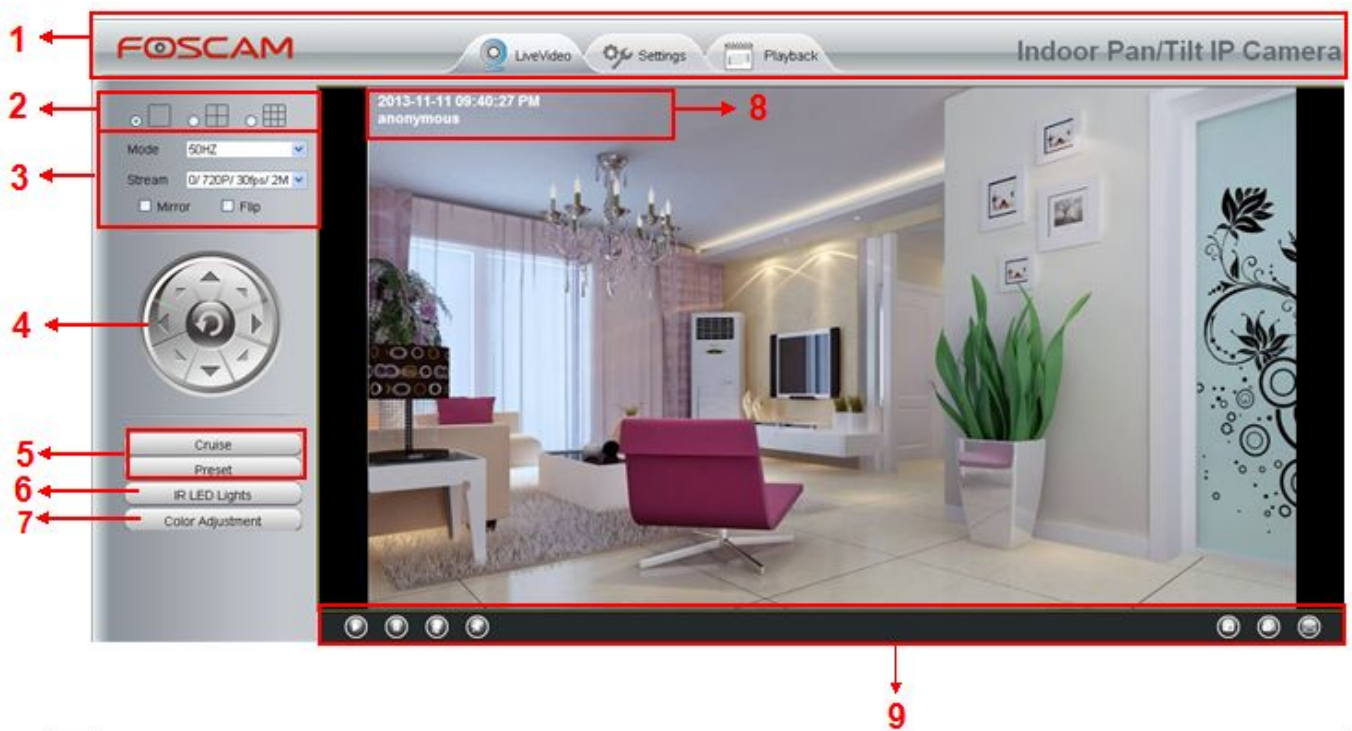

Figure 3.8

Section1 FOSCAM Logo/ Live Video / Settings/Playback buttons

FOSCAM: FOSCAM LOGO

LiveVideo: Path to surveillance window. Click this button and back to the surveillance window

Settings: Path to Administrator Control Panel, Click it, and it will lead to Administrator Control Panel and do advanced settings.

Playback: Click this button and back to the Playback panel to view the stored audio files stored in the SD Card.

Section2 Multi-Device Window



The firmware inside the camera supports up to maximum of 9 cameras being monitoring at the same time. You can add other cameras in multi-device setting (read chapter 4.2.4).

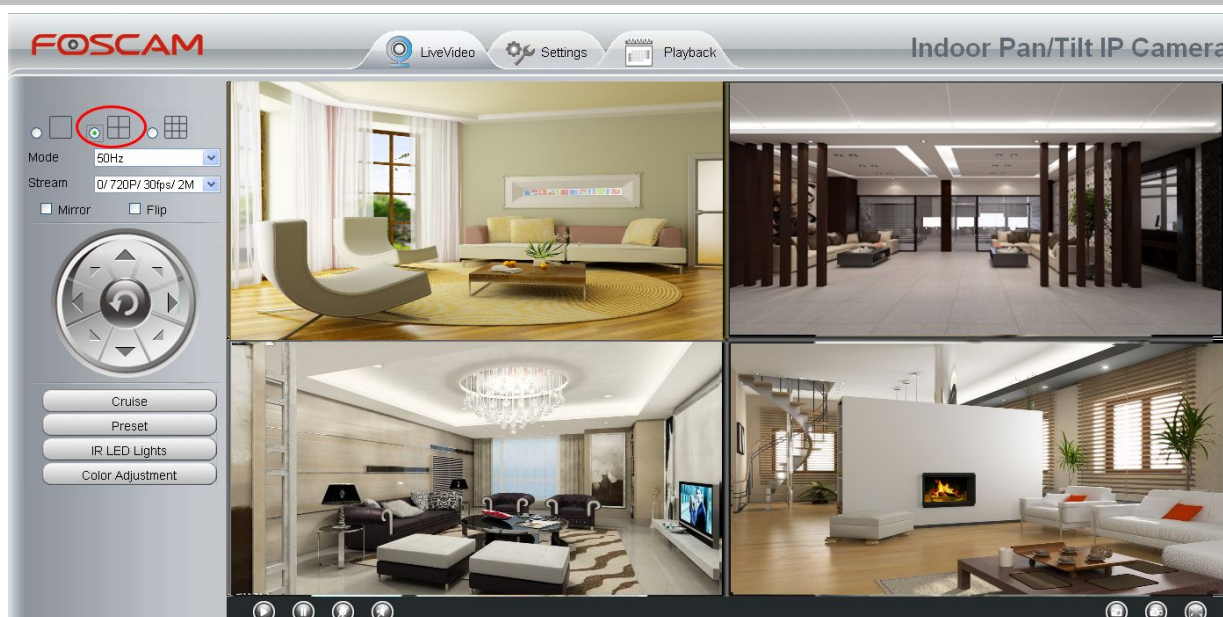

Figure 3.9

Section3 Mode/ Stream / Mirror/ Flip buttons

Mode

- 1) 50HZ -----Indoor surveillance (Region: Europe, China)
- 2) 60HZ -----Indoor surveillance (Region: USA, Canada)
- 3) Outdoor Mode-----Outdoor surveillance

Stream

The default Stream supports four modes: 0/720P/30fps/4M, 1/VGA/25fps/2M, 2/VGA/15fps/1M and 3/VGA/10fps/200K. The format of the stream type is Stream type NO. / Resolution / Maximum frame rate/

Bit rate.

1) **Stream type NO.** : The number is used to identify the stream type.

2) **720P/ VGA**

There are two resolutions, the bigger one is 720P, and the smaller one (VGA) is 640x480 pixels. The bigger the resolution, the better of the image quality is. If you are accessing the camera via internet and want to get more fluent video streaming, please select resolution VGA.

3) **Maximum frame rate**

When the video format is 50Hz, the maximum frame rate is 25 fps. When the video format is 60Hz, the maximum frame rate is 30 fps. You should lower frame rate when the bandwidth is limited. Normally, when the frame rate above 15, you can achieve fluently video.

4) **Bit rate**

Generally speaking, the larger the bit rate is, the clearer video will become. But the bit rate configuration should combine well with the network bandwidth. When the bandwidth is very narrow, and bit rate is large, that will lead to video can not play well.

You can reset the stream type on **Settings-> Video-> Video Settings** panel.

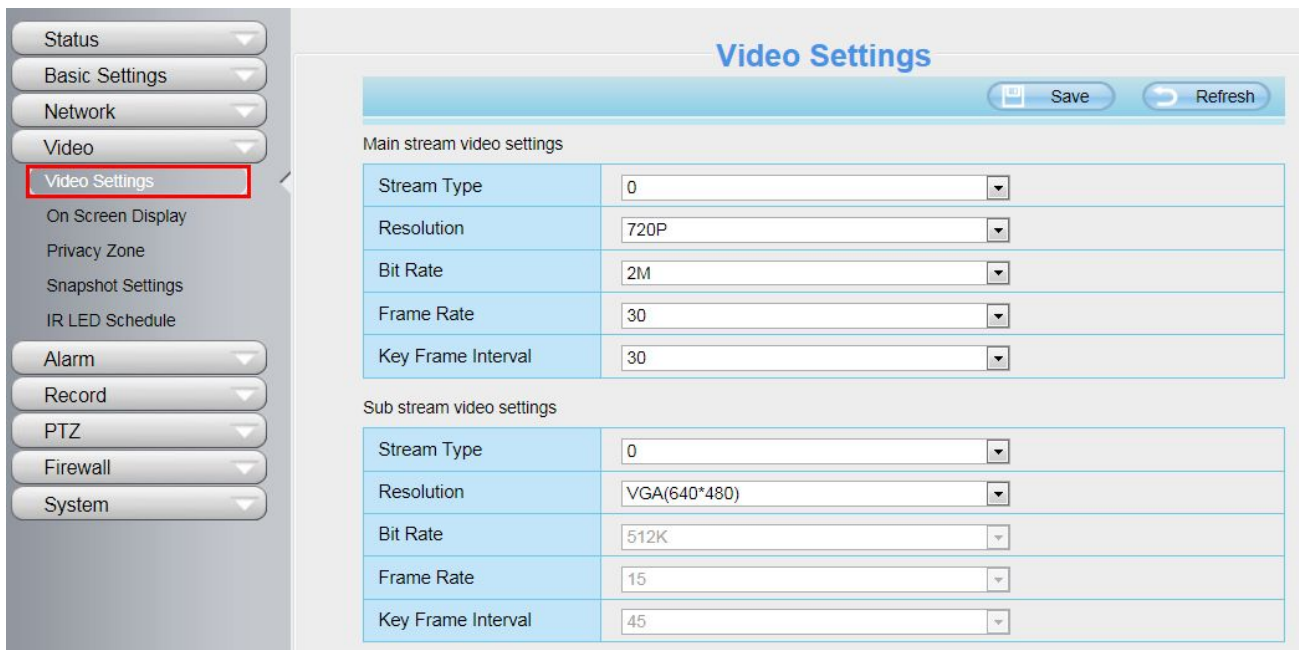
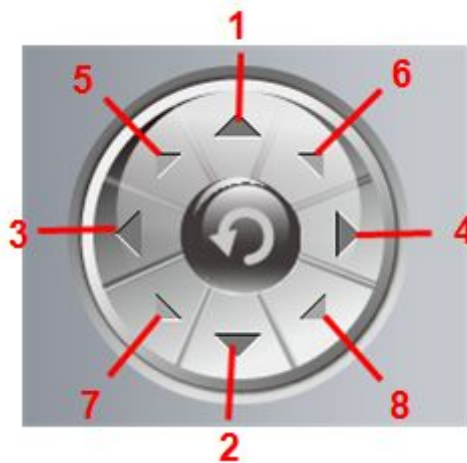

Figure 3.10

After changing, please re-login the camera and you can see the modification.

Section4 Pan/Tilt Control



- | | |
|---------------------------------|----------------------------------|
| 1 ---- Up control button | 2 ---- Down control button |
| 3 ---- Left control button | 4 ---- Right control button |
| 5 ---- Up-Left control button | 6 ---- Up-Right control button |
| 7 ---- Down-Left control button | 8 ---- Down-Right control button |



Click this button and go to center

Section5 Cruise / Preset settings



Cruise Settings



The default cruise tracks have two types: Vertical and Horizontal.

Vertical: The camera will rotate from up to down.

Horizontal: The camera will rotate from left to right.

: Start cruise. : Stop cruise.

If you want to define or change the cruise trace, please go to **Settings**---> **PTZ**---> **Preset Settings** panel.

How to do cruise?

Firstly: Select one track in the track drop-down list

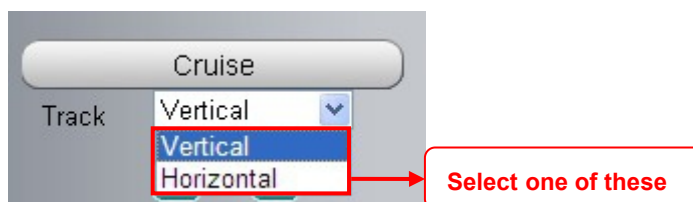

Secondly: Click Start cruise button, the camera will cruise following the predefined path.

Thirdly: Click stop button and finish cruising.

Preset settings



IPCAM supports 16 preset positions, which is considered enough for DIY home & small business surveillance market

The default preset position is TopMost, BottomMost, LeftMost, RightMost, you can add other preset positions.

 **Add** Click this icon to save the position you need the camera to remember

 **Delete** Select one preset position and click this button to delete it.

 **GO** Select one preset position in the preset drop-down list and click Go to make the camera move the preset position

How to do preset position?

Firstly, move the camera and stop at a desired place where you want make preset position.

Secondly, click  button and enter a descriptive name for the preset position. The preset position cannot contain special characters. Then click OK to save it. If you want to reset the preset position, click Cancel. After that, you can move the camera and stop at another place, and set another preset position. You can do all the 16 preset positions with this method.

If you want to see one preset position you have set, only select the preset position name from the preset drop-down list, and click go  button, the camera will go to the preset position.

Section6 IR LED Lights

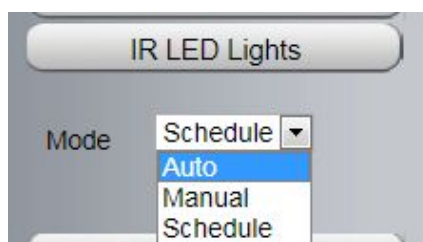

Click Infra led and there are three modes to adjust the infrared led: Auto, Manual and Schedule.

Auto: Select it and the camera will adjust the infra led (on or off) automatically.

Manual: Select it and you can turn on or turn off the infra led manually.

Schedule: Select it and the IR led light will be off at the schedule period. If you want to define or change the IR led lights schedule time, please go to **Settings--->Video---> IR LED Schedule** page.

Section7 Image quality settings

In this page, you can tune Hue, Brightness, Contrast, Saturation, and Sharpness to get higher quality.

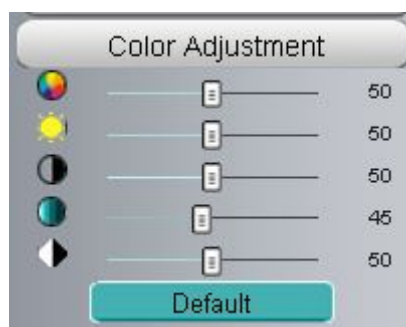

Section8 OSD

If you have added time and camera name in the video, you can see it in the live window.

Go to **Settings--->Basic settings--->Camera name** panel, and you can change another device name. The default device name is anonymous.

Go to **Settings --->Basic settings--->Camera time** panel and adjust the device time.

Go to **Settings--->Video--->On Screen Display** panel, you can add or no add OSD.

Section9 Play/Stop/ Talk/Audio/ Snap/ Record/ Full screen button



1-----Play Click it to play the video of the camera

2-----Stop Click it to stop the video of the camera

3----- Talk Click the button and the icon will become to , then talk to the microphone that connected with PC, people around the camera can here your voice. Click the icon again and stop talking.

4----- Audio Click this icon, the icon will become to  you can hear the sound around the camera by the earphone or speakers that connected with PC.

5----- Snapshot Click it to make snapshot and it pop-up a window which picture you snapshot, right click in the window and save the picture to anywhere you want.

6----- Record Click the icon  and the camera start recording, you can see a green dot in the live window. Click again and stop recording. The default storage path is C:\IPCamRecord. You can change the storage path: Go to Settings- >Record->Storage Location panel.

7-----Full Screen Click it to make full-screen, or you can double click the surveillance screen to make full-screen. Double click again and exit full-screen.

Onscreen Mouse Control

Right click the mouse and you can adjust the screen ration, full screen and Zoom up.



Figure 3.11

Keep ration: Select it and the camera will adjust the size of live window based on the the computer monitor

automatically. Sometimes there is a black border around the video, please select Keep ration to get a better visual quality .

Full Screen: Select it and Click it to make full-screen, press ESC and exit full-screen.

Zoom up: Select it and you can see a bigger screen than before.

First Method: Here is a convenient and fast solution to Zoom up/down screen by clicking Video Screen and adjusting Mouse pulley, or by press the CTRL key and click the mouse left button.

Second Method: Click it and the live view will be digital zoomed up, then click Zoom Down and the live view back to original size.

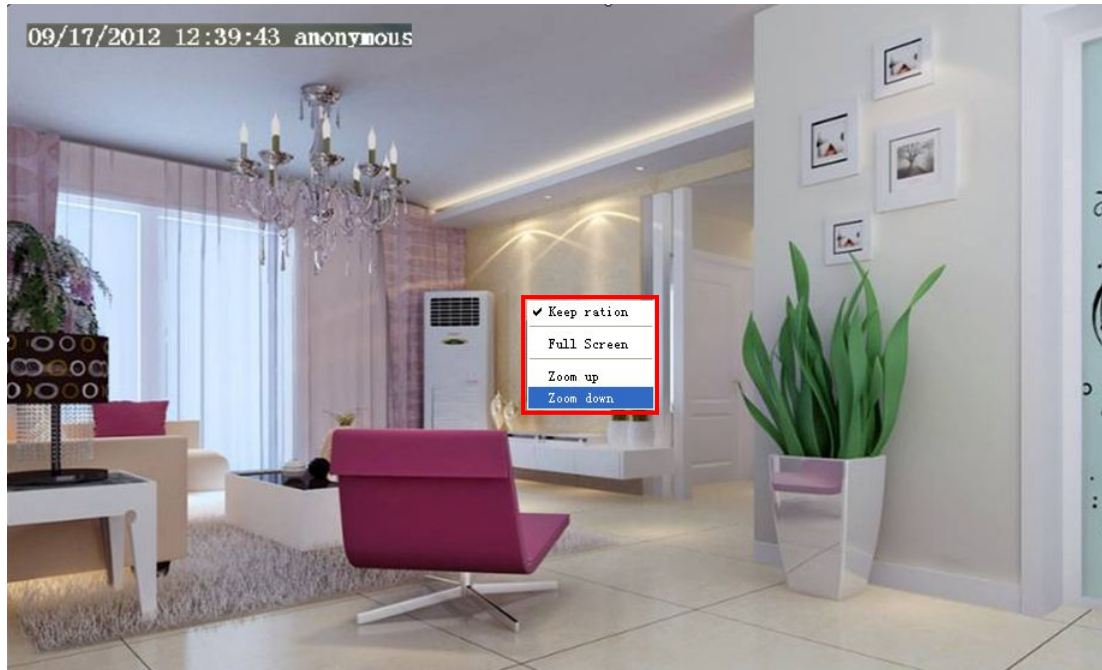

Figure 3.12

When you select the Full Screen, then click right mouse, there is a **Screen PTZ** button.

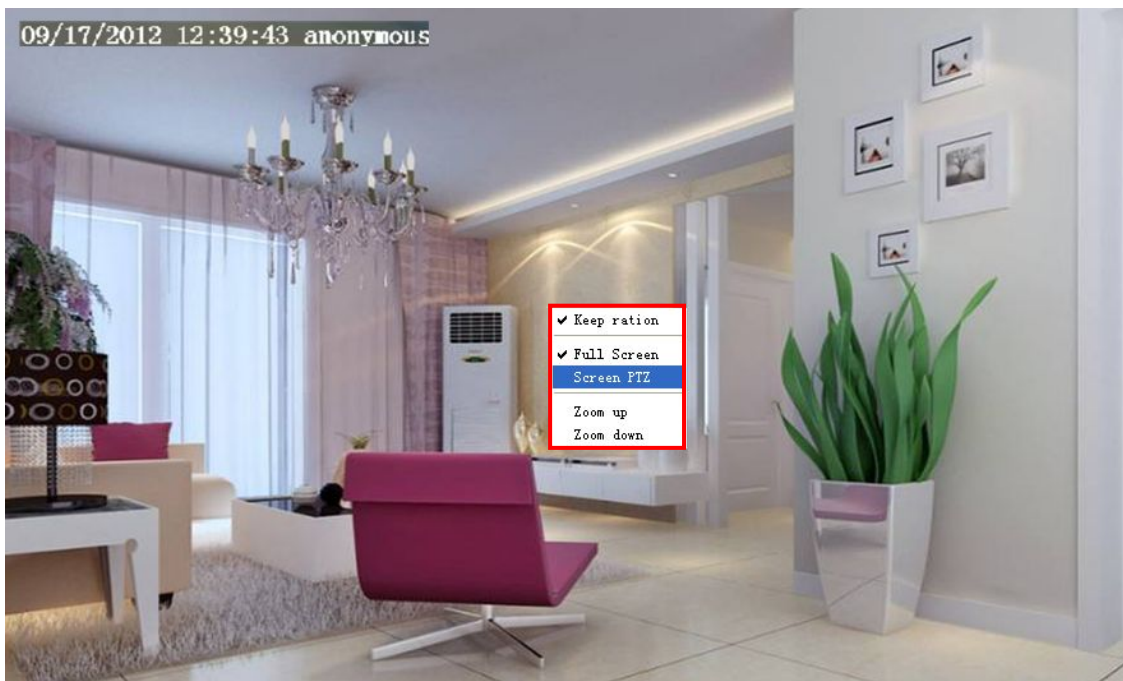

Figure 3.13

Click the **Screen PTZ** button and put the mouse on the screen to indicate the camera move direction you prefer, press the left mouse, the camera will move to the corresponding direction. Loosen the mouse and stop moving. Press Esc button or double click right mouse and cancel the function.

NOTE: For Mac OS, the plugin cannot support Onscreen Mouse Control, so you cannot allow to use it.

4 Advanced Camera Settings

Click the button "**Settings**", goes to Administrator Control Panel to make advanced camera settings.

4.1 Status

Status contains four columns: Device Information, Device Status, Session Status and Log, it will show you various information about your camera.

4.1.1 Device Information

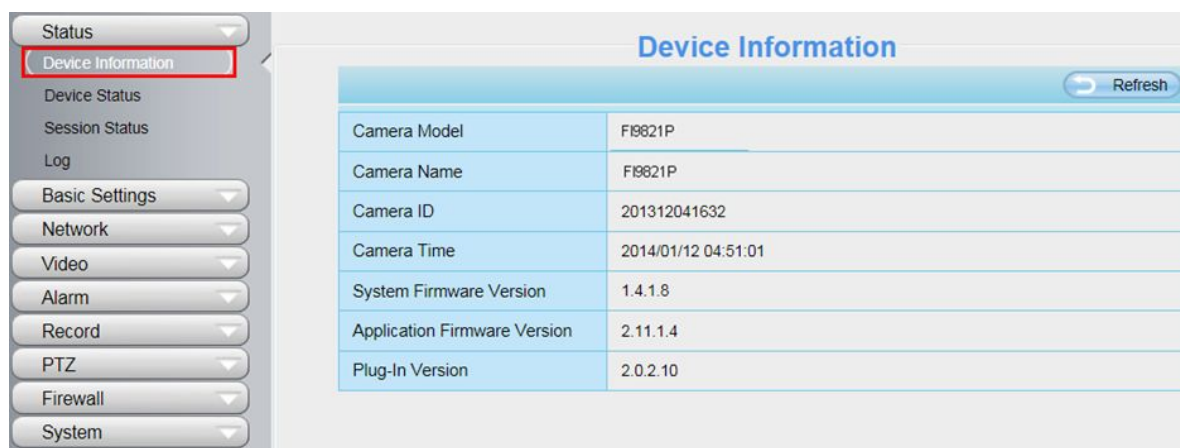

| Device Information | |
|------------------------------|---------------------|
| Camera Model | F8821P |
| Camera Name | F8821P |
| Camera ID | 201312041632 |
| Camera Time | 2014/01/12 04:51:01 |
| System Firmware Version | 1.4.1.8 |
| Application Firmware Version | 2.11.1.4 |
| Plug-In Version | 2.0.2.10 |

Figure 4.1

Camera Model: The camera model NO.

Camera Name: The Device Name is a unique name that you can give to your device to help you identify it. Click **Basic Settings** and go to **Camera name** panel where you can change your camera name. The default device name is anonymous.

Camera ID: Display the wired MAC address of your camera. For example Device ID is 000C5D00008, the

same MAC ID sticker is found at the bottom of the camera.

Camera Time: The system time of the device. **Click Basic Settings** and go to **Camera time** panel and adjust the time.

System Firmware version: Display the System Firmware version of your camera.

App Firmware version: Display the application firmware version of your camera.

Web version: Display the web UI version of your camera

Plug-in version: Display the plug-in version of your camera

4.1.2 Device Status

On this page you can see device status such as Alarm status/ Record Status ,DDNS status ,WiFi status and so on.

| Device Status | |
|---------------------|---------------|
| Alarm Status | No alarm |
| Recording Status | Not Recording |
| SD Card Status | No SD card |
| SD Card Free Space | 0KB |
| SD Card Total Space | 0KB |
| NTP Status | Failed |
| DDNS Status | Disabled |
| UPnP Status | Failed |
| WiFi Status | Not connected |
| IR LED Status | Off |

Figure 4.2

4.1.3 Session Status

Session status will display who and which IP is visiting the camera now.

| Session Status | |
|----------------|-------------|
| Username | IP Address |
| foscam | 172.16.3.10 |

Figure 4.3

4.1.4 Log

The log record shows who and which IP address accessed or logout the camera and when.

The screenshot shows the 'Log' page in the Foscam web interface. The left sidebar contains a menu with 'Log' highlighted. The main content area displays a table of log entries. The table has the following columns: NO., Time, User, IP, and Log. The entries are as follows:

| NO. | Time | User | IP | Log |
|-----|---------------------|---------|-------------|-----------------------|
| 1 | 2014-01-09 14:12:35 | root | 127.0.0.1 | Detected motion alarm |
| 2 | 2014-01-09 14:11:58 | root | 127.0.0.1 | Detected motion alarm |
| 3 | 2014-01-09 14:11:58 | root | 127.0.0.1 | Detected motion alarm |
| 4 | 2014-01-09 14:11:24 | foscarn | 192.168.8.2 | User off line |
| 5 | 2014-01-09 14:11:13 | foscarn | 192.168.8.2 | User off line |
| 6 | 2014-01-09 14:11:12 | foscarn | 192.168.8.2 | User off line |
| 7 | 2014-01-09 14:10:49 | root | 127.0.0.1 | Detected motion alarm |
| 8 | 2014-01-09 14:10:28 | root | 127.0.0.1 | Detected motion alarm |
| 9 | 2014-01-09 14:09:41 | root | 127.0.0.1 | Detected motion alarm |
| 10 | 2014-01-09 14:08:31 | root | 127.0.0.1 | Detected motion alarm |

Two red callout boxes provide instructions: 'Click the page number and go to the corresponding page to see more logs.' and 'Fill in one page number, click Go button and go to the corresponding page.'

Figure 4.4

Reboot the camera and clear the log records.

4.2 Basic Settings

This section allows you to configure your camera's Name, Time, Mail, User account and Multi-Device.

4.2.1 Camera Name

Default alias is anonymous. You can define a name for your camera here such as apple. Click Save to save your changes. The alias name cannot contain special characters.

The screenshot shows the 'Camera Name' configuration page in the Foscam web interface. The left sidebar has 'Camera Name' highlighted. The main content area displays a text input field with the value 'anonymous'. Below the field, there is a note: 'The maximum Device Name length is 20, support English, numbers, letters and symbols'. A 'Save' button is visible at the top right of the configuration area.

Figure 4.5

4.2.2 Camera Time

This section allows you to configure the settings of the internal system clocks for your camera.

Figure 4.6

Time Zone: Select the time zone for your region from the drop-down menu.

Sync with NTP server: Network Time Protocol will synchronize your camera with an Internet time server. Choose the one that is closest to your camera.

Sync with PC: Select this option to synchronize the date and time of the Network Camera with your computer.

Manually: The administrator can enter the date and time manually. Note select the date and time format.

use DST: Select the **use DST**, then select the daylight saving time from the drop-down menu. Click **Save** button and submit your settings.

NOTE:

If the power supply of camera is disconnect, you need set the camera's time again.

4.2.3 User Accounts

Here you can create users and set privilege, **visitor**, **operator** or **administrator**. The default user account is admin, with a blank password. You can enter the users accounts of visitor, operator and administrator Manually.

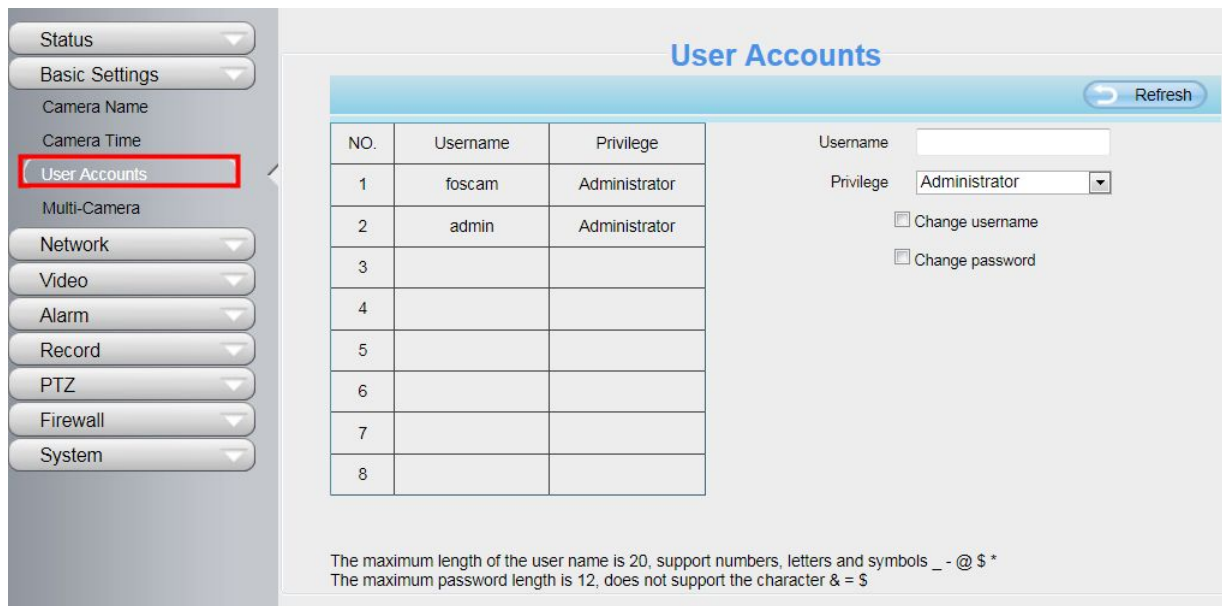

Figure 4.7

How to change the password of administrator?

Firstly, select the account of administrator, then select “Change password”, enter the old password and the new password, lastly click modify to take effect.

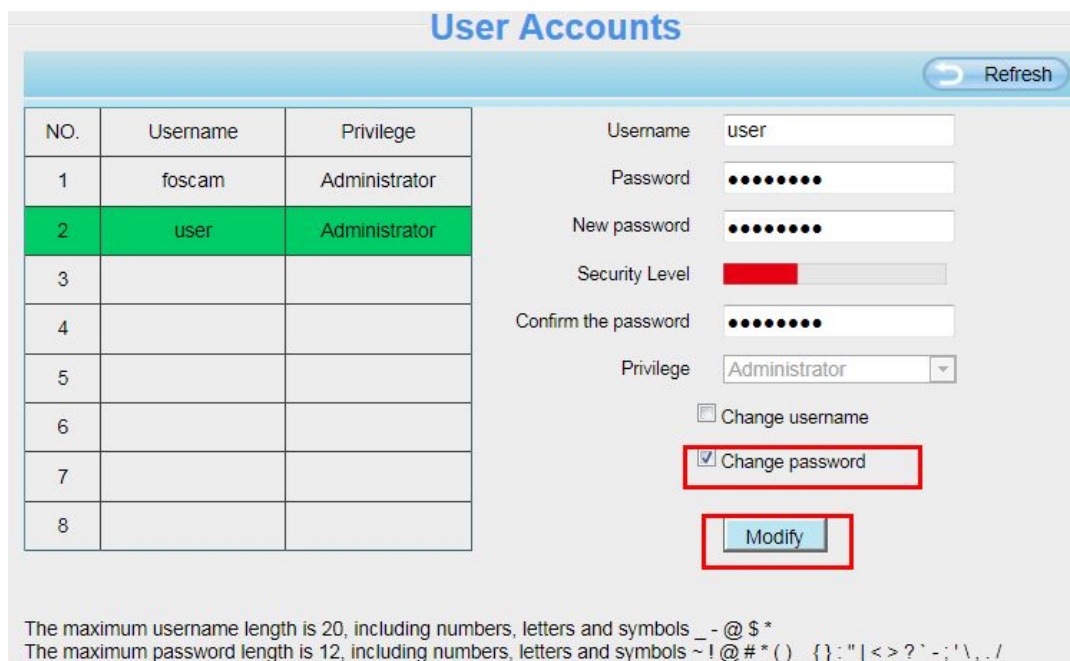

Figure 4.8

How to add account ?

Select one blank column, then enter the new user name, password and privilege, last click Add to take effect. You can see the new added account on the Account list.

User Accounts

Refresh

| NO. | Username | Privilege |
|-----|----------|---------------|
| 1 | foscam | Administrator |
| 2 | admin | Administrator |
| 3 | | |
| 4 | | |
| 5 | | |
| 6 | | |
| 7 | | |
| 8 | | |

Username:
 Password:
 Password Security Level: Low security level.
 Confirm the password:
 Privilege:

Change username
 Change password

Add

The maximum length of the user name is 20, support numbers, letters and symbols _ - @ \$ *
 The maximum password length is 12, does not support the character & = \$

Figure 4.9

User Accounts

Refresh

| NO. | Username | Privilege |
|-----|----------|---------------|
| 1 | foscam | Administrator |
| 2 | admin | Administrator |
| 3 | user | Administrator |
| 4 | | |
| 5 | | |
| 6 | | |
| 7 | | |
| 8 | | |

Username:
 Privilege:

Change username
 Change password

Delete

The maximum length of the user name is 20, support numbers, letters and symbols _ - @ \$ *
 The maximum password length is 12, does not support the character & = \$

Figure 4.10

Delete : Select the account which you want to delete, then click Delete button to take effect.

Note:

The default admin account cannot be deleted, but you can add other administrator users.

4.2.4 Multi-Camera

If you want to view multi-surveillance screens on one window, you need to login one camera, and set it as the main device, and do Multi-Device Settings, add other cameras to the first one camera. Before you do multi-cams settings, you need to assign different port such as 81, 82, 83, 84, 85, 86, 87, 88 to the cameras if there is 8 cams installed.

The firmware within the camera can support a maximum of 9 devices monitoring all at the same time. This page you can both add FOSCAM MJPEG and H.264 series cameras to the first camera and view multi-surveillance screen on one window.

Add cameras in LAN

In Multi-Device Settings page, you can see all devices searched in LAN. The 1st Device is the default one. You can add more cameras in the list in LAN for monitoring. The camera's software supports up to 9 IP Cameras online simultaneously. Click **The 2nd Device** and click the item in the **Device List in LAN**, the Alias, Host and Http Port will be filled in the boxes below automatically. Enter the correct username and password then click **Add**. Add more cameras in the same way.

Multi-Camera

Cameras On LAN

| |
|--------------------------------|
| FI9821P(172.16.0.94) |
| 1111(172.16.1.71) |
| FOSCAM(172.16.0.27) |
| anonymous(172.16.0.179) |
| FOSCAM(172.16.0.105) |

Refresh

The 1st Camera: This Camera

The 2nd Camera

| | |
|--------------|--------------|
| Camera Model | H264 |
| Camera Name | anonymous |
| Host | 172.16.0.179 |
| HTTP Port | 80 |
| Media Port | 80 |
| Username | admin |
| Password | |

Add Delete

The 3rd Camera: None

The 4th Camera: None

1 Click it, camera model, alias, host and HTTP Port will be filled in the following boxes automatically .

2 Enter the User name and password of the 2nd camera .

3 Click Add to take effect .

Figure 4.11

Camera Model: Our Company produces two series cameras: MJPEG and H.264. Here will show you which series the camera belongs to.

| Refresh | |
|--------------------------------|--|
| Cameras On LAN | anonymous(192.168.11.193) FI9821W for ebuyer (192.168.11.241) anonymous(192.168.11.203) anonymous(192.168.11.243) |
| | Refresh |
| The 1st Camera | This Camera |
| The 2nd Camera | anonymous(192.168.11.203) |
| The 3rd Camera | FI9821W for ebuyer (192.168.11.241) |
| The 4th Camera | anonymous(192.168.11.203) |
| The 5th Camera | None |
| The 6th Camera | None |
| The 7th Camera | None |
| The 8th Camera | None |
| The 9th Camera | None |

Note: If you want to access your camera remotely, make sure you are able to access it separately through a browser.

Figure 4.12

Back to **Surveillance Windows**, and click Four Windows option, you will see four cameras you added.

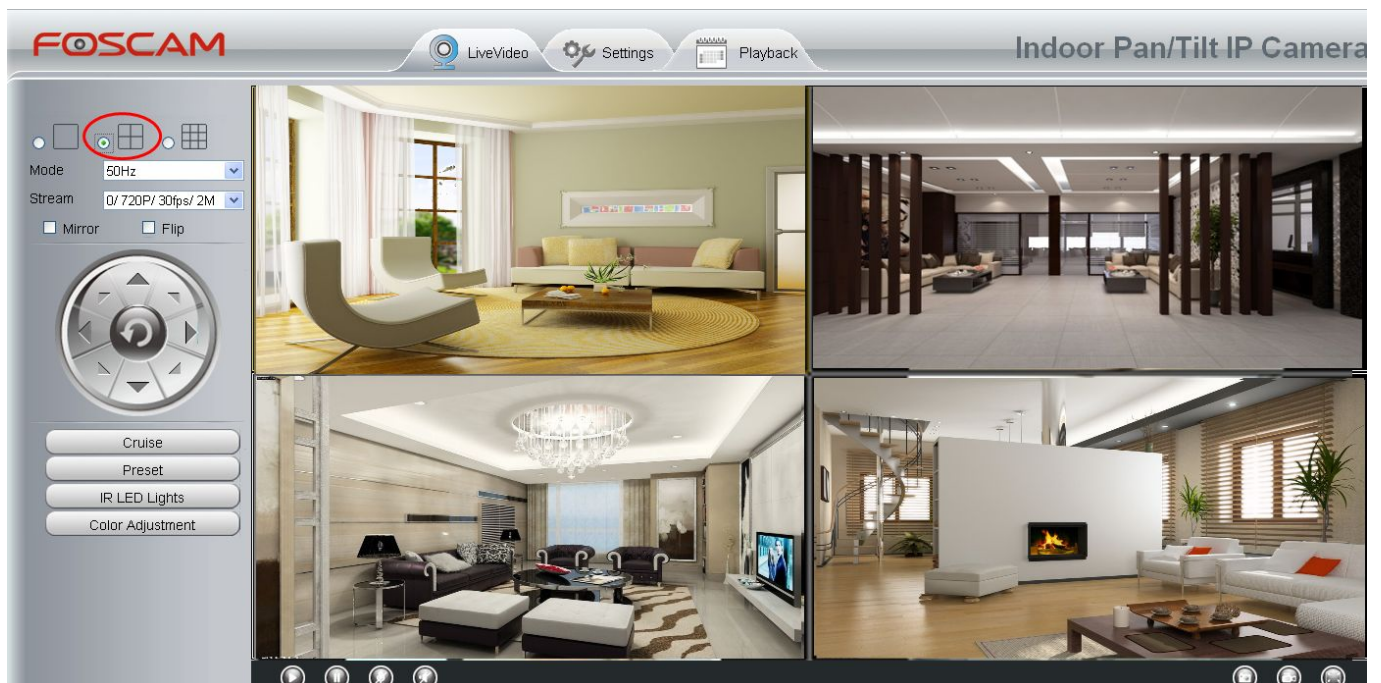

Figure 4.13

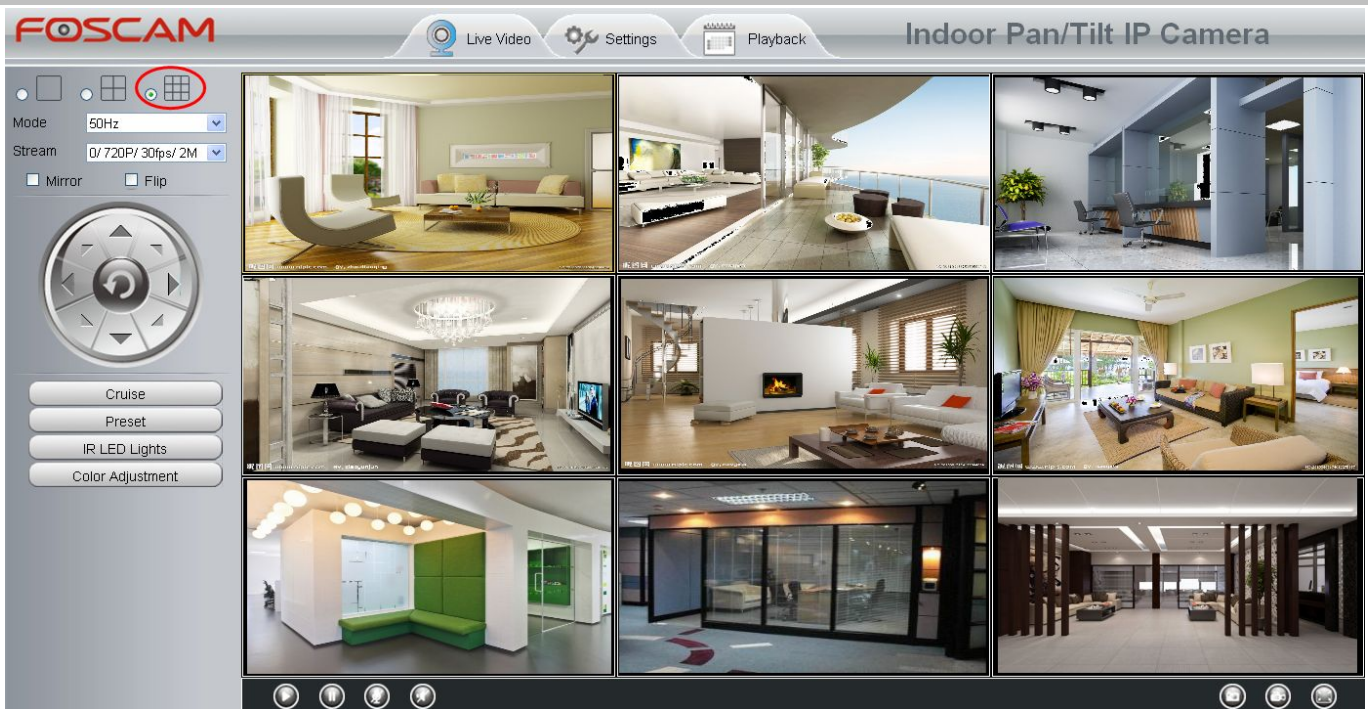

Figure 4.14

Add cameras in WAN

If you want to view all cameras via the internet(remote computer), you will need to add them using DDNS domain name. Firstly, make sure all of the cameras you added can be accessed through the internet. (Read **How to configure DDNS settings in chapter 4.3.4**)

Login to the first camera using a DDNS domain name and port.

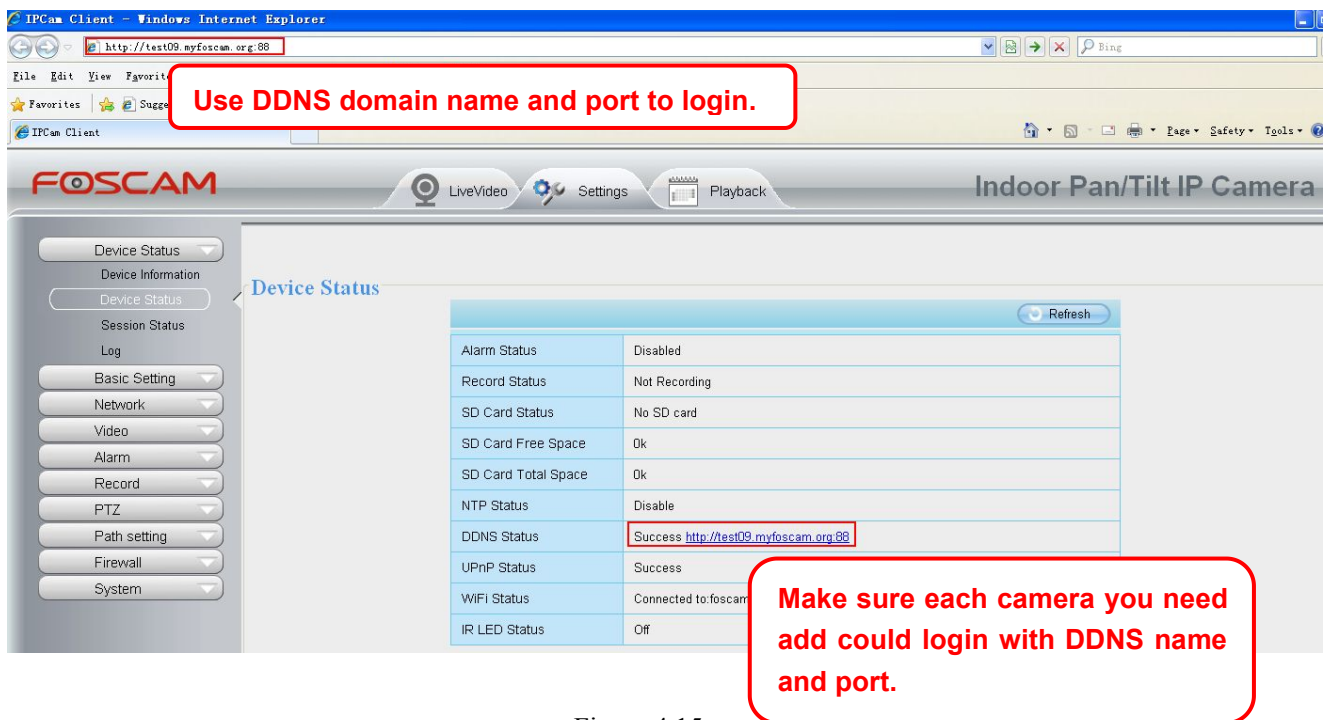

Figure 4.15

Click **Multi-Device Settings**. Choose **The 2nd Device**. Fill in the 2nd camera's name, DDNS domain name, port number. Enter user name and password and then choose Add. (Figure 4.16)

| | | |
|--------------------------------|---|---------|
| Cameras On LAN | FI9621W for ebuyer (192.168.11.241) anonymous(192.168.11.243) anonymous(192.168.11.203) | Refresh |
| The 1st Camera | This Camera | |
| The 2nd Camera | anonymous(192.168.11.203) | |
| Camera Model | MJ | 1 |
| Camera Name | apple | 2 |
| Host | camera.no-ip.info | |
| HTTP Port | 801 | 3 |
| Media Port | 801 | |
| Username | admin | 4 |
| Password | | |
| | Add Delete | 5 |
| The 3rd Camera | None | |
| The 4th Camera | None | |

Figure 4.16

- 1 ---- The camera model: MJ or H264.
- 2 ---- The 2nd camera's name
- 3 ---- Fill in the 2nd camera's DDNS host not LAN IP

NOTE:

The MJ series have the same HTTP Port NO. and Media Port NO.

- 4 ---- Enter the 2nd camera's user name and password
- 5 ---- Click Add button and to take effect

NOTE:

Here the Host must be entered as the second camera's DDNS domain name, not its LAN IP.

| Refresh | |
|--------------------------------|--|
| Device List in LAN | apple(192.168.13.102) mycamera(192.168.13.108) ipcam(192.168.13.107) F19821W-01(192.168.13.106) |
| The 1st Device | This Device |
| The 2nd Device | apple(camera.no-ip.info) |
| The 3rd Device | ipcam(test01.foscam.org) |
| The 4th Device | mycamera(owlejwww.no-ip.info) |
| The 5th Device | None |
| The 6th Device | None |
| The 7th Device | None |
| The 8th Device | None |
| The 9th Device | None |

Attention: If you want to access the device from internet, be sure the host and port that you set can be accessed from internet.

Figure 4.17

Return to video window. You will see all of the cameras accessible through the internet. When you are away from home, you can use the first camera's DDNS domain name and port to view all the cameras via internet.

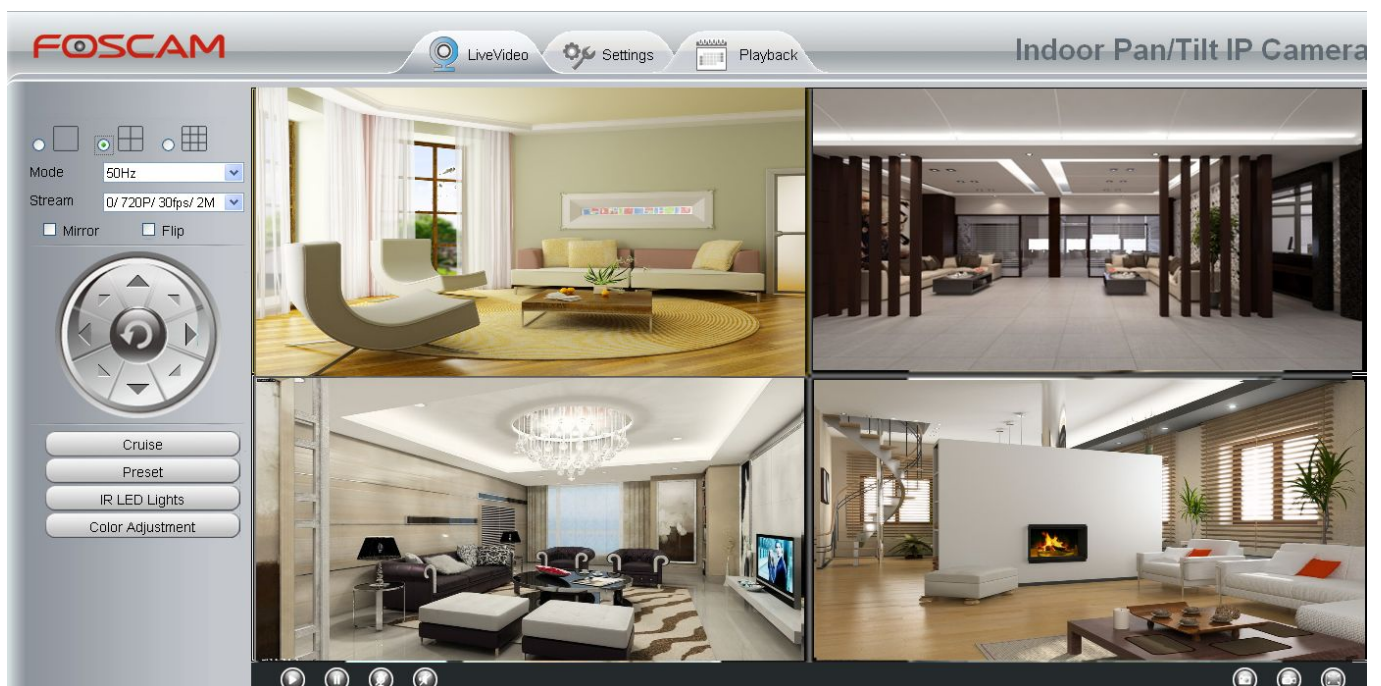

Figure 4.18

4.3 Network

This section will allow you to configure your camera's IP, PPPoE, DDNS, Wireless Settings, UPnP and Port.

4.3.1 IP Configuration

If you want to set a static IP for the camera, please go to **IP Configuration** page. Keep the camera in the same subnet of your router or computer.

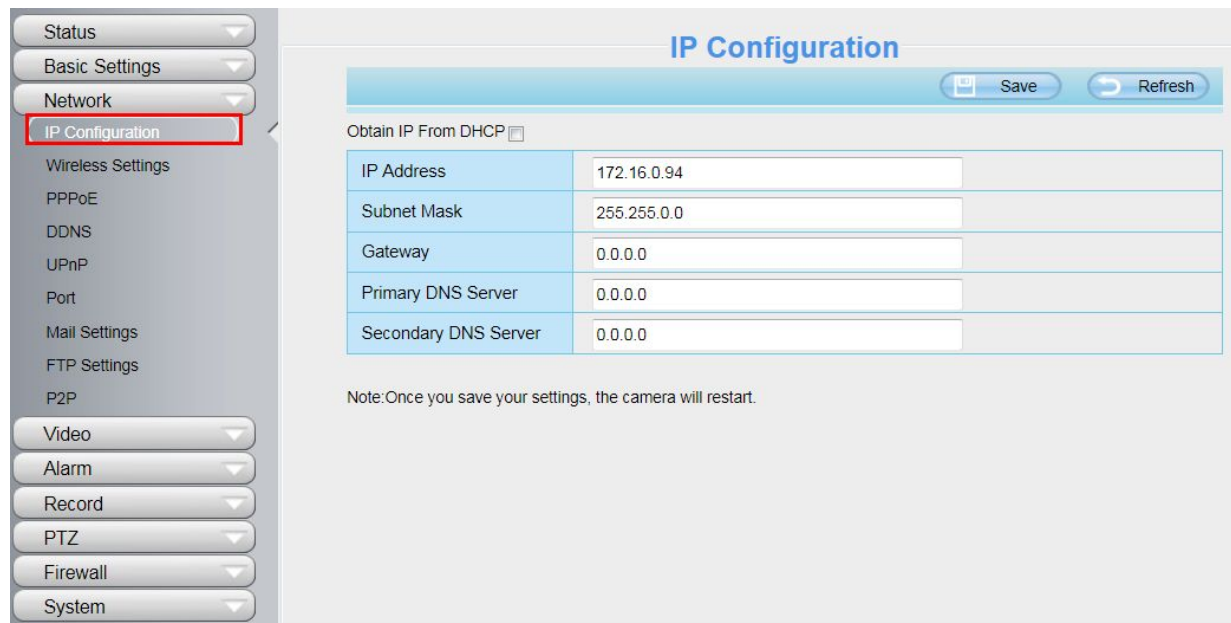

| IP Configuration | |
|--|-------------|
| Obtain IP From DHCP <input type="checkbox"/> | |
| IP Address | 172.16.0.94 |
| Subnet Mask | 255.255.0.0 |
| Gateway | 0.0.0.0 |
| Primary DNS Server | 0.0.0.0 |
| Secondary DNS Server | 0.0.0.0 |

Note: Once you save your settings, the camera will restart.

Figure 4.19

Changing settings here is the same as using the IP Camera Tool.

It is recommended that you use the subnet mask, gateway and DNS server from your locally attached PC. If you don't know the subnet mask, gateway and DNS server, you can check your computer's local area connection as follows:

Control Panel → Network Connections → Local Area Connections → Choose Support → Details.

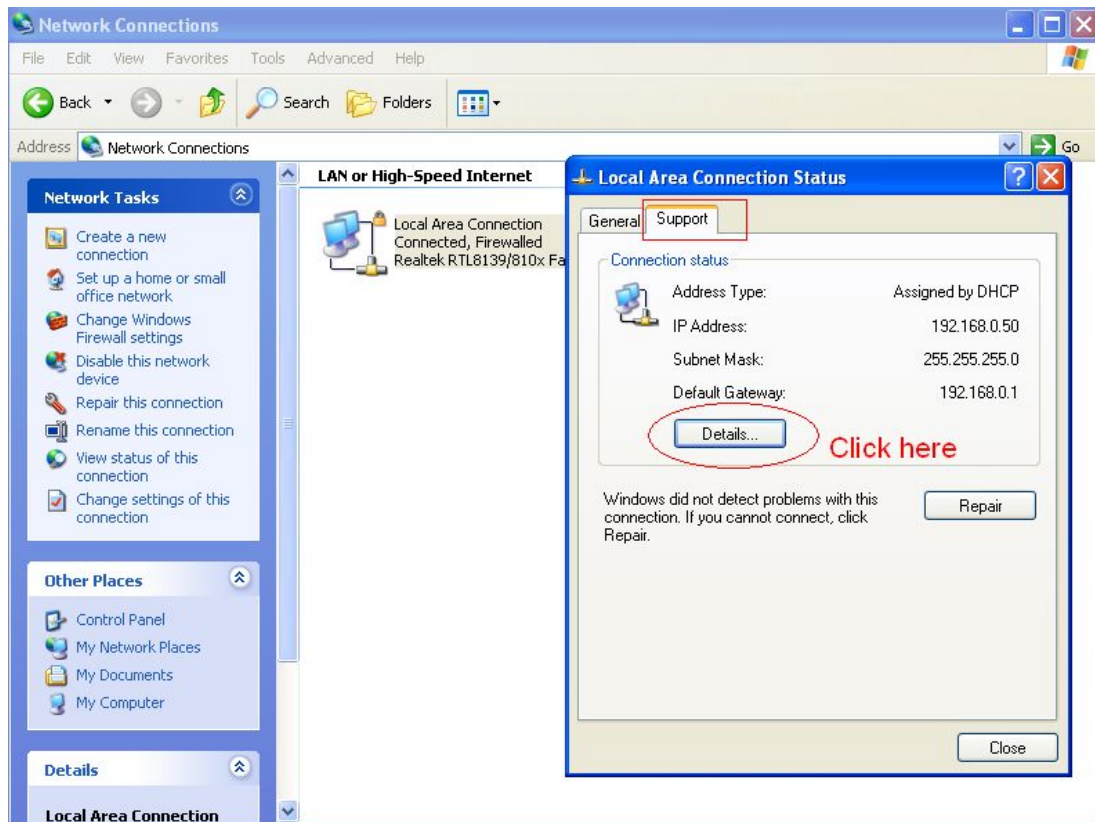

Figure 4.20

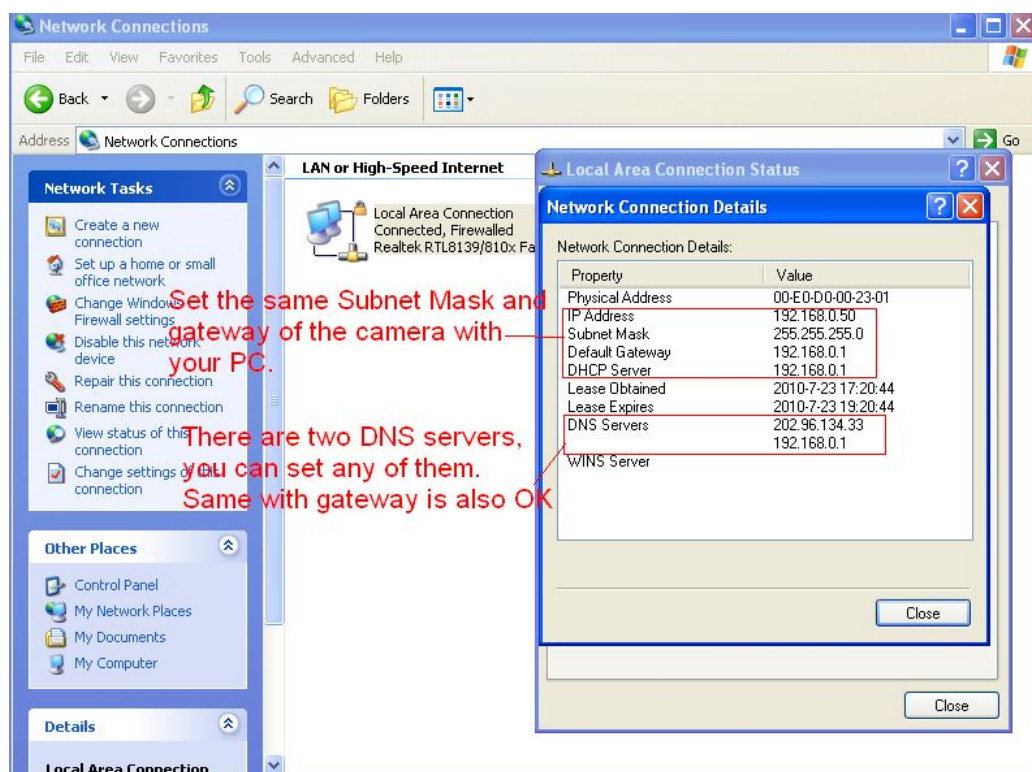

Figure 4.21

If you don't know the DNS server, you can use the same settings as the Default Gateway.

4.3.2 Wireless Settings

Step 1: Choose “Settings” on the top of the camera interface, and go to the “Network” panel on the left side of the screen, then click “Wireless Settings.”

Click the **Scan** button and the camera will detect all wireless networks around the area. It should also display your router in the list.

The screenshot shows the 'Wireless Settings' page. On the left sidebar, 'Wireless Settings' is selected. The main area displays a 'Wireless Network List' table with columns for SSID, Encryption, and Signal Strength. A 'Scan' button is located above the table. Below the table, the page number '4' is shown, along with navigation arrows. Two red callout boxes provide instructions: one pointing to the 'Scan' button and another pointing to the page number '4'.

| SSID(Network Name) | Encryption | Signal Strength |
|--------------------|------------|-----------------|
| wjx | Unencrypt | |
| wangbarrytest | WPA/WPA | |
| NETGEAR19 | WPA2 | 📶 |
| TP-LINK_YF | WPA/WPA2 | 📶 |
| TP-LINK_gaw | WPA/WPA2 | 📶 |
| TP-LINK_jingyuan | WPA2 | 📶 |
| FAST_BD9A08 | Unencrypt | 📶 |
| TP-LINK_B18958 | Unencrypt | 📶 |
| cisco-8621 | WPA/WPA2 | 📶 |
| TP-LINK_wyy | WPA/WPA2 | 📶 |

Figure 4.22

Step 2: Click the SSID (name of your router) in the list, the corresponding information related to your network, such as the name and the encryption, will be filled into the relevant fields automatically.

You will only need to fill in the password of your network. Make sure that the SSID, Encryption and the password you filled in are exactly the same for your router.

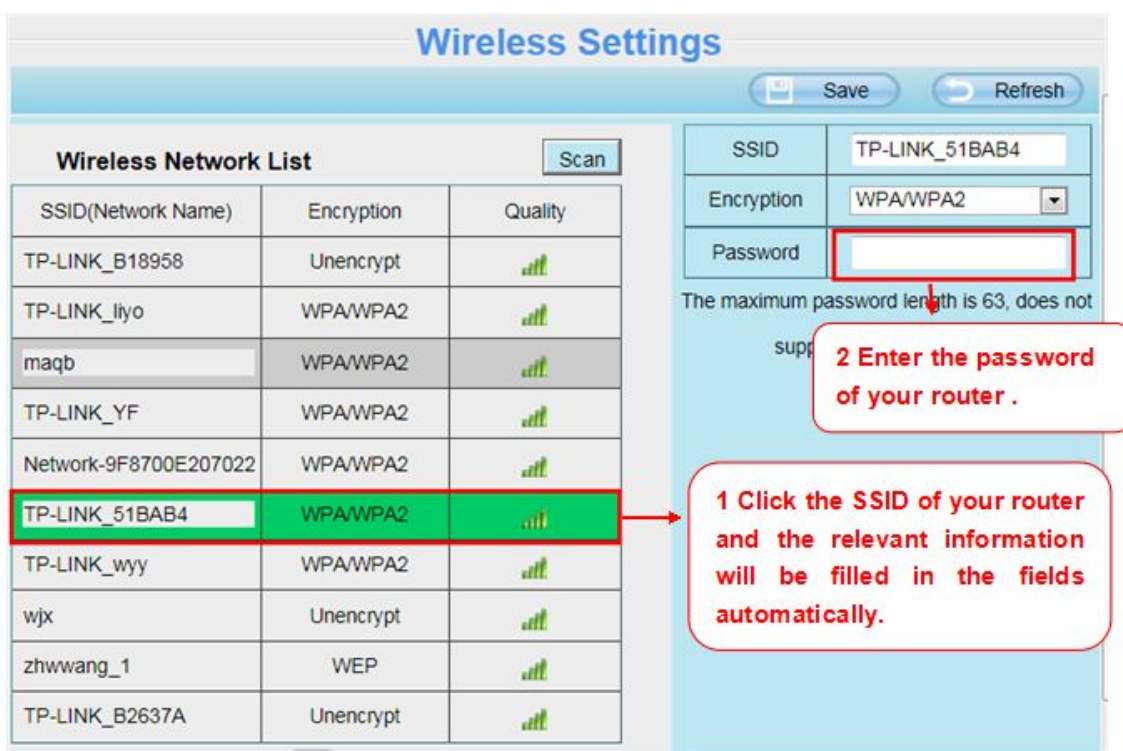

Figure 4.23

Step 3: Please click on the **Save** button after all settings have been entered and disconnect the network cable. Never shut down the power of the camera until the IP camera is able to connect to the wireless network.

The LAN IP address will disappear on the window of IP Camera Tool when the camera is configuring a wireless connection. Wait about 1 minute, the camera should obtain a wireless connection, and the LAN IP of the camera will show again on the window of the IP Camera Tool. The IP address may have changed after the camera receives a wireless connection; we recommend setting a static local IP address if this IP address changes by right clicking the camera in IP Camera Tools, setting a static IP, and pushing OK (see Figure4.36). Congratulations! You have set up the wireless connection of the camera successfully.

NOTE:

If you fail to make a wireless connection, please refer to your seller or contact us directly for assistance.

WPS (Wi-Fi Protected Set-up)

Step 01) Press and hold the WPS button for **two seconds**.

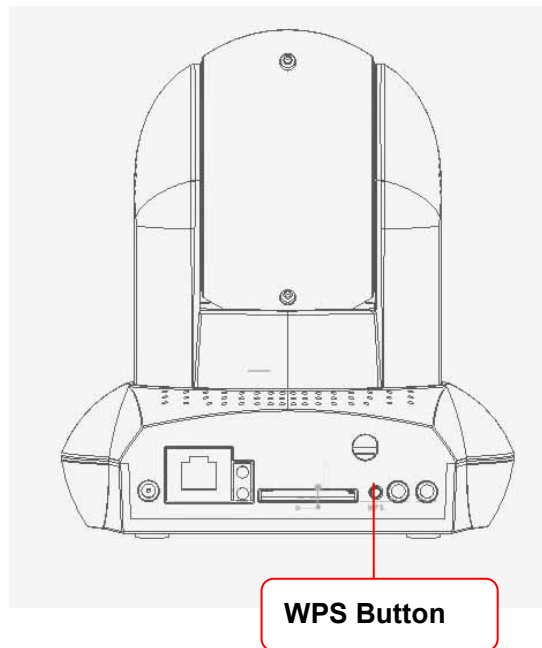

Step 02) Press the WPS button on your router **within 60 seconds**. The WPS button is usually on the back or side of your router. On some routers, you may need to log in to the web interface and click on an on-screen button to activate the WPS feature. If you are not sure where the WPS buttons is on your router, please refer to your router's User Manual.

The camera will automatically create a secure wireless connection to your router. If you have plugged in the network cable, please plug it out. The IP Camera Tool will search the camera's LAN IP. Make sure the PC and the camera share the same subnet.

NOTE:

The security mode of router cannot be WEP, or else the WPS settings may be failed.

4.3.3 PPPoE

If you are using a PPPoE connection, enable it and enter the User Name and Password for your PPPoE account.

The screenshot shows the 'PPPoE' configuration page in the camera's web interface. On the left sidebar, 'PPPoE' is highlighted with a red box. The main content area has a title 'PPPoE' and 'Save' and 'Refresh' buttons. Below the title, there is a checkbox labeled 'Use PPPoE' which is checked. There are two input fields: 'PPPoE account' and 'PPPoE password'. The 'PPPoE account' field has a validation message: 'The maximum length of the user name is 20, support numbers, letters and symbols @ . \$ * - _'. The 'PPPoE password' field has a validation message: 'The maximum password length is 12, including numbers, letters and symbols ~ ! @ # * () _ { } : " | < > ? ` ^ ' \ , . /'. At the bottom, there is a note: 'Note: Once you save your settings, the camera will restart.'

Figure 4.24

4.3.4 DDNS

FOSCAM camera has embedded a unique DDNS domain name when producing, and you can directly use the domain name, you can also use the third party domain name.

FOSCAM domain name

Here take test09.myfoscam.org for example. Go to option of **DDNS** on the **Settings->Network** panel, you can see the domain name.

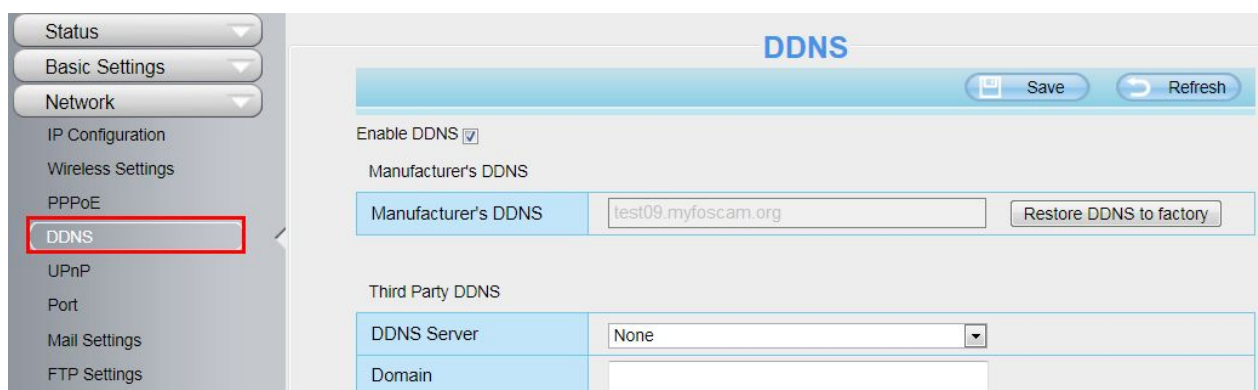

Figure 4.25

Now you can use [http:// Domain name + HTTP Port](http://Domain name + HTTP Port) to access the camera via internet.

Take hostname test09.myfoscam.org and HTTP Port NO. 800 for example, the accessing link of the camera via internet would be [http:// test09.myfoscam.org:800](http://test09.myfoscam.org:800)

Restore DDNS to factory: If you have configured Third Party DDNS successfully, but you want to use Manufacturer's DDNS again , here click this button and start Manufacturer's DDNS Service.

Third Party Domain Name Settings

User can also use third part DDNS, such as www.no-ip.com ,www.3322.com

Here take www.no-ip.com for example:

① **Step 1, Go to the website www.no-ip.com to create a free hostname**

Firstly: Login on www.no-ip.com and click No-IP Free to register.

Managed DNS Provider

[Sign Up](#) [Home](#) [Blog](#) [Support](#) [Contact Us](#) [Sign In](#)



[Services](#) [Why No-IP?](#) [Download](#) [Support](#)

Enhanced Dynamic DNS

more features, flexibility & control

Connect remotely to your computer, DVR, webcam or run your own web server or website on a dynamic IP address.
[What is Dynamic DNS?](#)

[Sign Up Now](#) Up to 25 Hostnames



Personal Use

Dynamic DNS allows you to monitor your home remotely via webcam, access your computer remotely, or even run your own server all on a dynamic IP address.

- ✔ Remote Access
- ✔ Webcam Monitoring
- ✔ Quick Installation
- ✔ Simple Domain Name

[Get Started](#)

Business Use

Trust our DNS experts with your web domains DNS management. Our Managed DNS will ensure your website is fast, reliable and always available.

- ✔ 100% Uptime Guaranteed
- ✔ Fast Redundant Websites
- ✔ Trusted Anycast Network
- ✔ 11 Points of Presence

[Get Started](#)

Figure 4.26

No-IP Free

No-IP Free is our entry level service. Use `yourname.no-ip.org` instead of a hard to remember IP address or URL. With No-IP Dynamic DNS, our free Dynamic Update Client keeps track of your changing IP address and updates your hostname, keeping your connection active.

[Sign Up Now](#) [More](#)

[Click here to register](#)





-  **Domain Registration**
Fast, simple and affordable Domain Registrations. 100% Uptime Guaranteed!
[Learn More](#)
-  **POP3 / IMAP Email**
Easily manage email accounts for your own domain and access your email from anywhere.
[Learn More](#)
-  **SSL Certificates**
Ensure your website visitors are safe and secure by purchasing an SSL Certificate.
[Learn More](#)

Figure 4.27

Please register an account step by step according to instructions on www.no-ip.com

After registration, please login your email which used to register. You will receive an email from website, please click the link to activate your ACCOUNT as indicated in email.

Secondly: Login the link with the registered username and password to create your domain name.

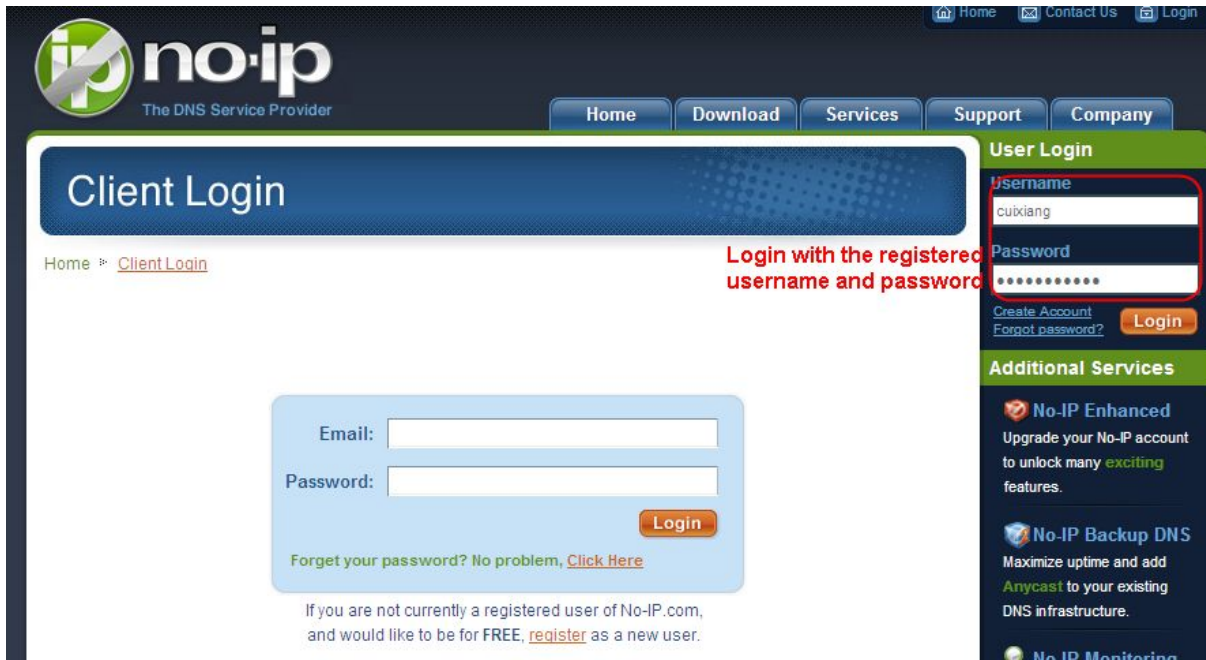

Figure 4.28

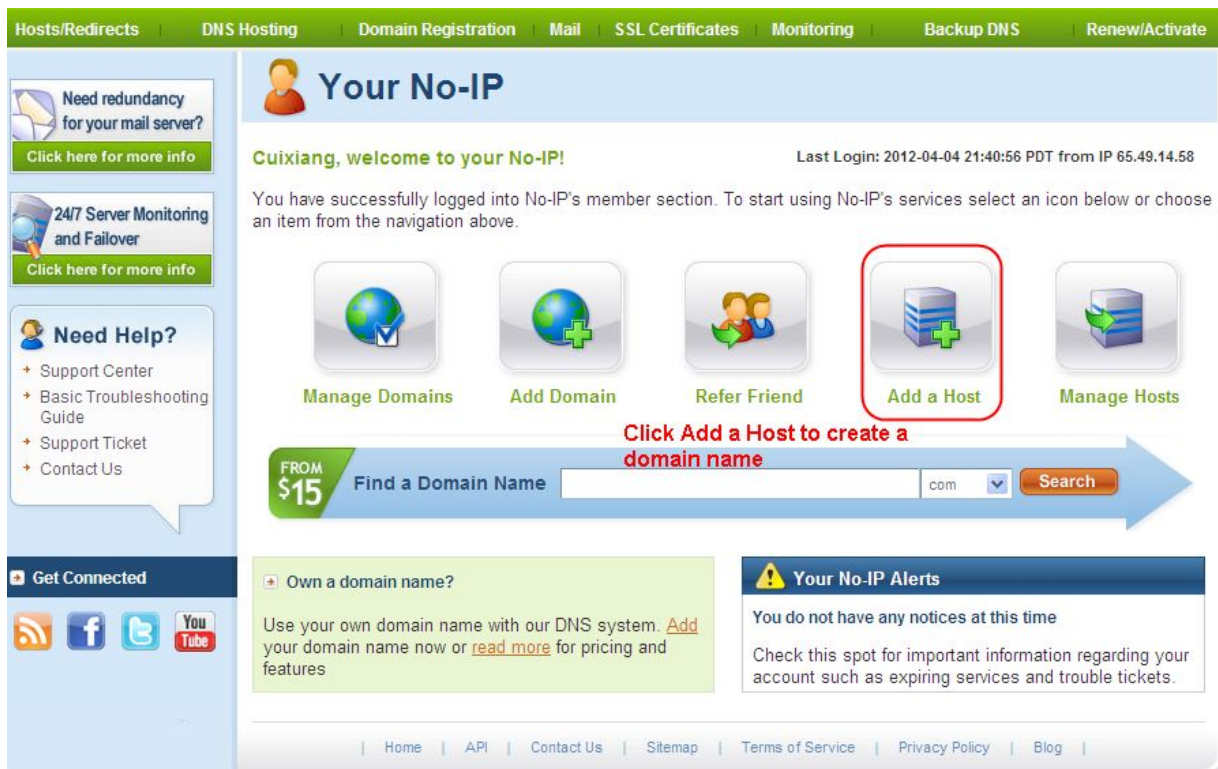

Figure 4.29

Please create the domain name step by step according to instructions on www.no-ip.com

Step 2, DO DDNS Service Settings within the Camera

Please set **DDNS Settings** within the camera by **hostname**, a **user name** and **password** you've got from www.no-ip.com

Take **hostname** ycxgwp.no-ip.info, user name foscam, password foscam2012 for example.

Firstly, goes to option of **DDNS Settings** on the administrator panel.

Secondly, select No-IP as a server..

Thirdly, fill foscam as DDNS user, fill password foscam2012 as DDNS password, fill ycxgwp.no-ip.info as DDNS domain and server URL, Then click save to make effect. The camera will restart and to take the DDNS settings effective.

Fourthly, after the restart, login the camera, and go to option of **Device Status** on the administrator panel, and check if the DDNS status is successful.

If failed, please double check if you have input the correct hostname, user name, and password, and try to redo the settings.

NOTE:

If you have set Third Party DDNS successfully ,the Foscam Domain Name will be invalid. The Third Party DDNS and the Foscam Domain Name cannot work at the same time, the last time you configured will take effect.

② Do port forwarding within the router

Example: The camera's LAN IP address is <http://192.168.1.110:88> , Media port no. is 9200.

Firstly, login the router, goes to the menu of **Port Forwarding** or **Port Trigger** (or named Virtue Server on some brands of router). **Take Linksys brand router as an example, Login the router, and goes to Applications & Gaming->Single Port Forwarding.**

Secondly, Create a new column by LAN IP address & HTTP Port No. of the camera within the router showed as below.

Figure 4.30

③ Use domain name to access the camera via internet

After the port forwarding is finished, you can use the **domain name+ http NO.** to access the camera via internet. Take hostname **ycxgwp.no-ip.info** and **http NO. 2000** for example, the accessing link of the camera via internet would be **http:// ycxgwp.no-ip.info:2000**

4.3.5 UPnP

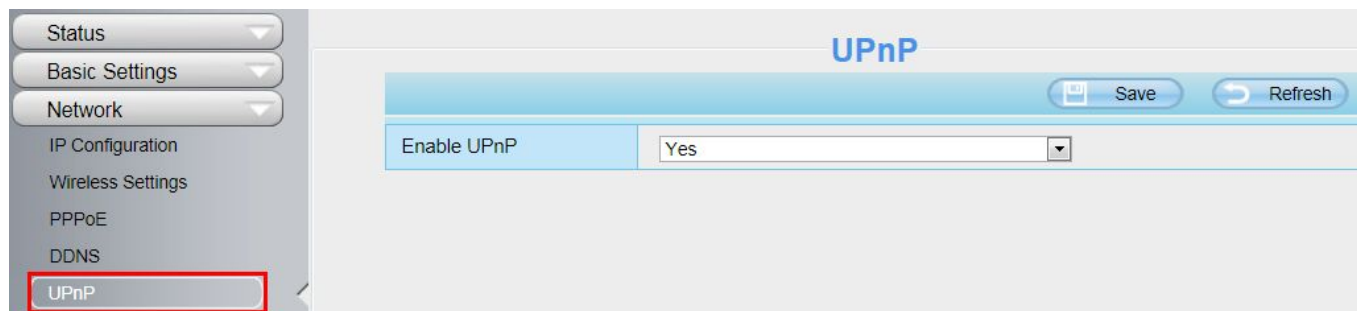

Figure 4.31

The default UPnP status is closed. You can enable UPnP, then the camera's software will be configured for port forwarding. Back to the "Device Status" panel, you can see the UPnP status:



Figure 4.32

The camera's software will be configured for port forwarding. There may be issues with your routers security settings, and sometimes may error. We recommend you configure port forwarding manually on your router .

4.3.6 Port

This camera supports HTTP Port / HTTPS Port/ ONVIF Port. HTTP Port is used to access the camera remotely. If you want to access the camera and view the video.

HTTP port : By default, the HTTP and Media port is set to 88. Also, they can be assigned with another port number between 1 and 65535. But make sure they can not be conflict with other existing ports like 25, 21.

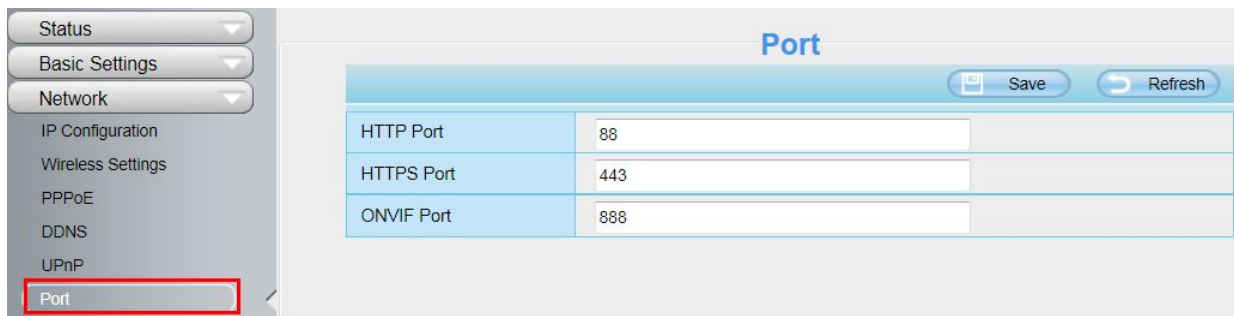

Figure 4.33

Another way to change the HTTP port NO.

Step 1: Open the IP Camera Tool, select the camera you would like to change the port of, right click on the IP address, and click on "Network Configuration", this brings up the network configuration box as shown in Figure 4.34 and 4.35.

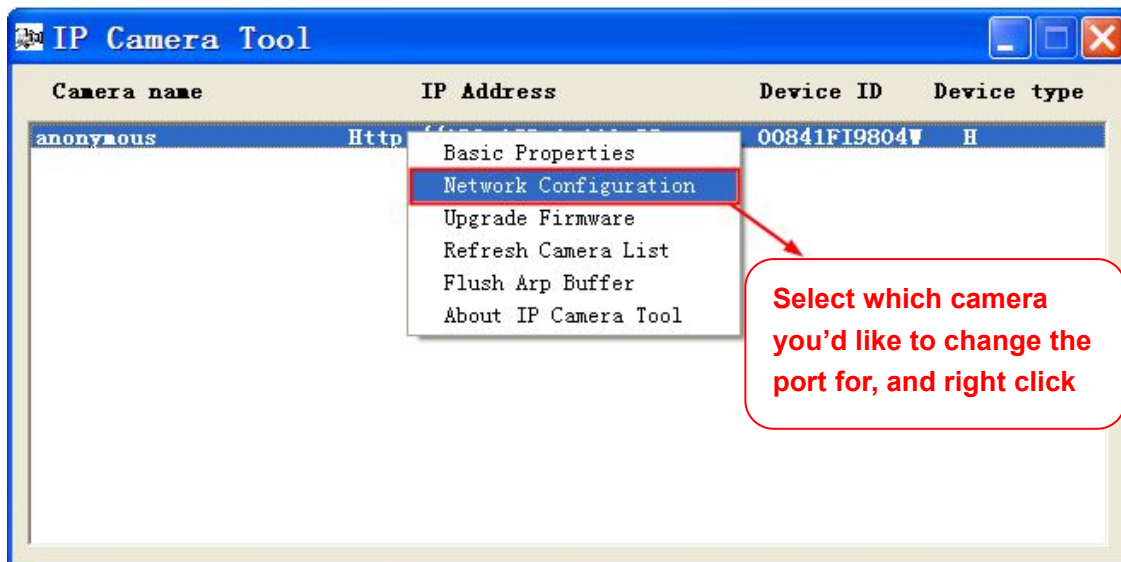

Figure 4.34

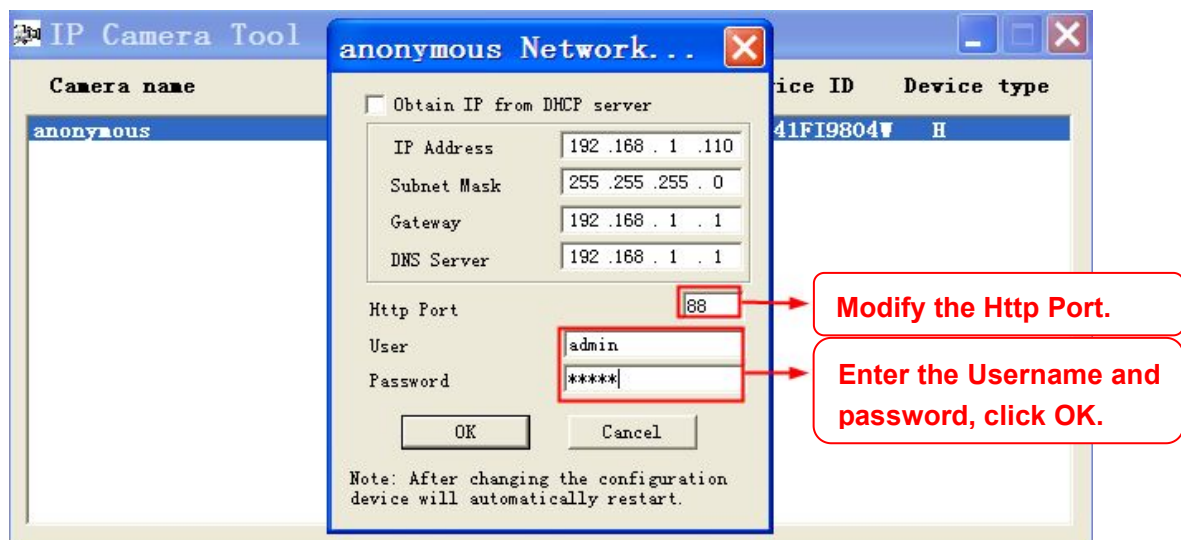

Figure 4.35

Step 2: Enter the username and password of the Administrator (default username is admin with a blank password), and click “OK” to apply changes.

Step 3: Wait around 10 seconds, you’ll see that the camera’s LAN IP address has changed. In our example it was changed to 2000, so we see http://192.168.1.110:2000 in IP Camera Tool. Also, the LAN IP address is now fixed at a static IP address of http://192.168.1.110:2000 . This IP address will not change even if the camera is powered off and back on, the camera will remain on this LAN IP address. This is very important that a static LAN IP address is set, or you may have problems later with remote access and seeing the camera remotely if the camera loses power and reconnects on a different LAN IP address. Make sure you set a static LAN IP address!



| Camera name | IP Address | Device ID | Device type |
|-------------|---------------------------|--------------|-------------|
| anonymous | Http://192.168.1.110:2000 | 00841FI9804W | H |

Figure 4.36

If the camera cannot be accessed, please make sure the port forwarding is succeed.

ONVIF port: By default, the ONVIF port is set to 888. Also, they can be assigned with another port number between 1 and 65535(except 0 and 65534). But make sure they can not be conflict with other existing ports.

HTTPS port: The default port is 443. You can use the url to access the camera: [https:// IP + HTTPS port.](https://IP+HTTPS+port)

RTSP function

RTSP URL [rtsp:// \[user name\]:password@IP:HTTP port number/videosream](rtsp://[user name]:password@IP:HTTP port number/videosream)

The part in the square brackets may be omitted.

user name & password:

The user name and password to access the camera. This part can be omitted.

IP:

WAN or LAN IP address.

Videostream:

Here support three mode: videoMain, videoSub and audio. When the network speed is bad, here you had better select videoSub. If you select audio, you can only hear the sound but cannot see the video.

For example:

IP: 192.168.1.11

HTTP Port number: 88

User name: admin

Password: 123

Here I can enter one of the following URLs in the VLC.

rtsp://admin:123@192.168.1.11:88/videoMain

rtsp:// @192.168.1.11:88/videoMain

rtsp://123@192.168.1.11:88/videoMain
 rtsp://admin@192.168.1.11:88/videoMain

Open the VLC, and go to Media(Open Network Stream option, then enter the URL into VLC.

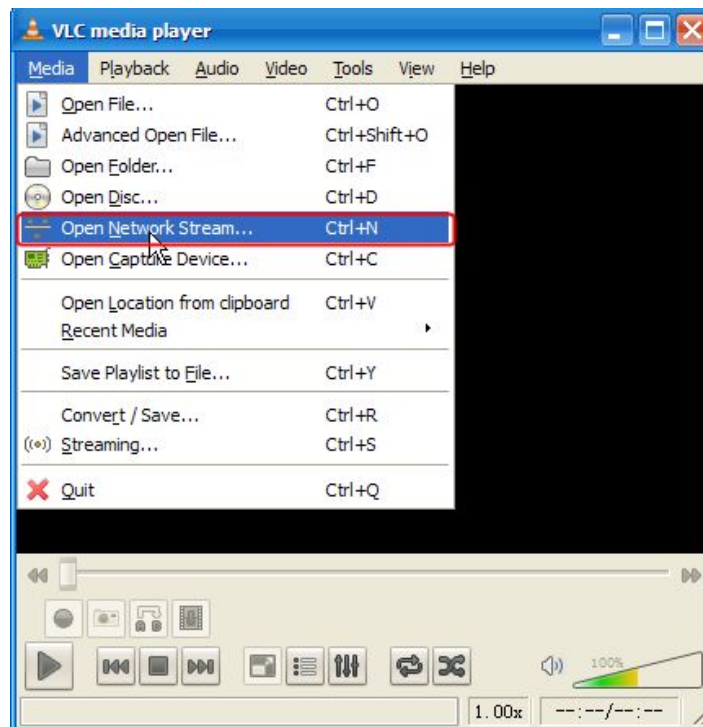

Figure 4.37

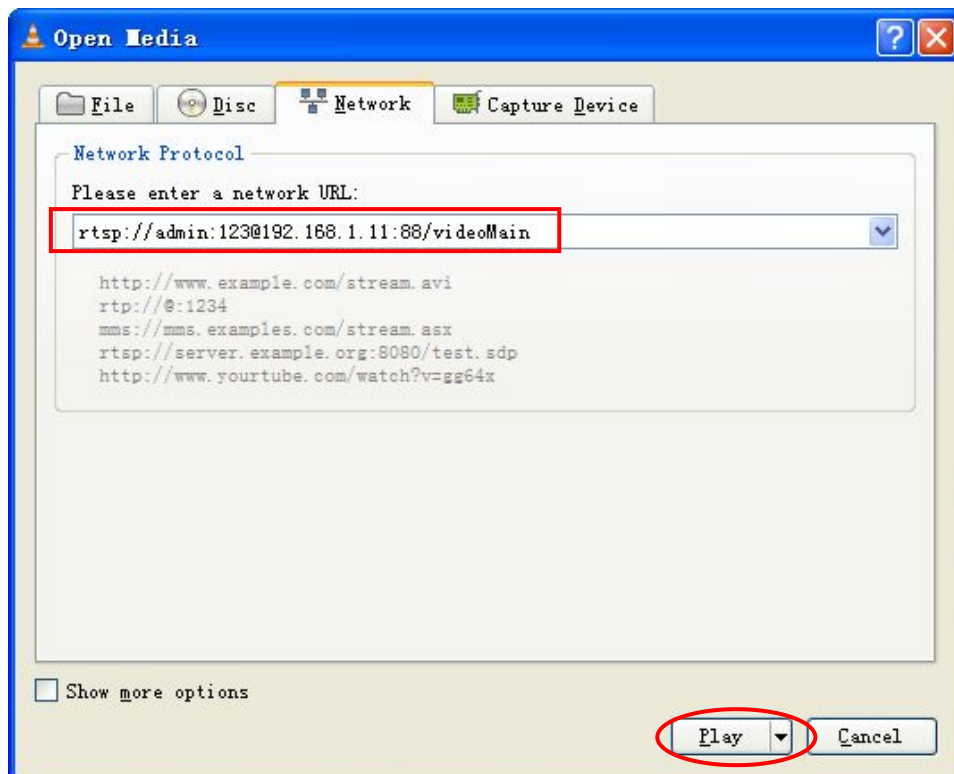

Figure 4.38

Sometimes you may need to enter the user name and password again. Click OK and you can see the real-time

preview.



Figure 4.39

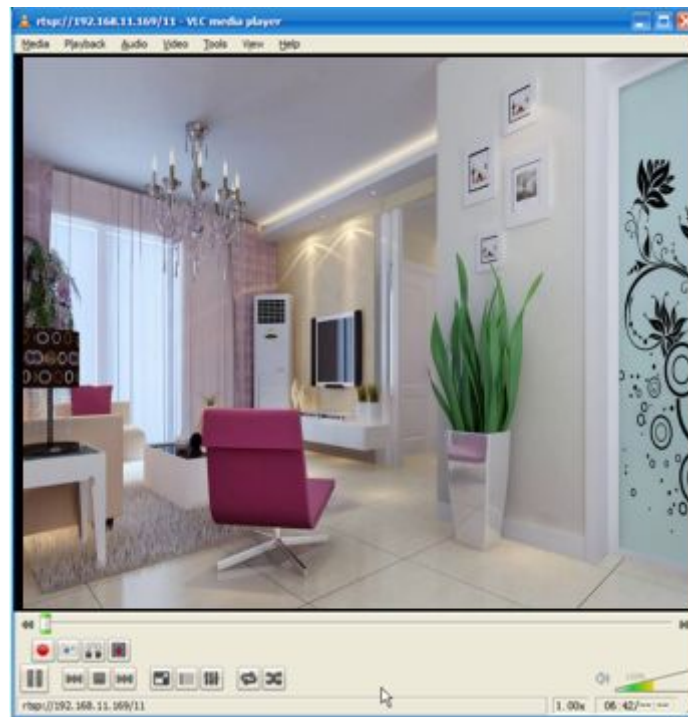

Figure 4.40

If you cannot play the video in the VLC player, please check the port mapping. You can read Quick Installation Guide about How to configure port forwarding.

NOTE:

If you modify the camera's username or password, you had better reboot the camera, or else the new username and password cannot take effect when you enter the authentication in the VLC.

4.3.7 Mail Settings

If you want the camera to send emails when motion has been detected, here Mail will need to be configured.

Mail Settings

Save Refresh

Enable

| | | |
|--------------------------|------------------|--|
| SMTP Server | smtp.gmail.com | SMTP server address supports English, numbers and @ _ . - |
| SMTP Port | 25 | |
| Transport Layer Security | STARTTLS | G-Mail only supports TLS at Port 465 and STARTTLS at Port 587 or 25. Hotmail only supports STARTTLS at Port 587 or 25. |
| Need Authentication | Yes | |
| SMTP Username | test123@gmai.com | The maximum length of the user name is 63, support numbers, letters and symbols @ _ . \$ * - |
| SMTP Password | | The maximum password length is 32, does not support the character & = |
| Sender E-mail | test123@gmai.com | Test |
| First Receiver | test@163.com | The maximum length of the receiver is 63, support numbers, letters and symbols @ _ . \$ * - |
| Second Receiver | tset@hotmail.com | |
| Third Receiver | | |
| Fourth Receiver | | |

Figure 4.41

1-----SMTP Server/ Port /Transport Layer Security Enter SMTP server for sender. **SMTP** port is usually set as 25. Some SMTP servers have their own port, such as 587 or 465, and Transport Layer Security usually is None. If you use Gmail, Transport Layer Security must be set to TLS or STARTTLS and SMTP Port must be set to 465 or 25 or 587, which port you choose should be decided by which Transport Layer Security you select.

2-----SMTP Username/ password ID account and password of the sender email address

3-----Sender E-mail Mailbox for sender must support SMTP

4----- Receiver Mailbox for receiver need not support SMTP,you can set 4 receivers

5-----Save Click Save to take effect

6-----Test Click Test to see if Mail has been successfully configured.

Click **Test** to see if Mail has been successfully configured.

Mail Settings

Save Refresh

Enable

SMTP Server: smtp.gmail.com
SMTP server address supports English, numbers and @ _ . -

SMTP Port: 25

Transport Layer Security: STARTTLS
G-Mail only supports TLS at Port 465 and STARTTLS at Port 587 or 25. Hotmail only supports STARTTLS at Port 587 or 25.

Need Authentication: Yes

SMTP Username: test123@gmail.com
The maximum length of the user name is 63, support numbers, letters and symbols @ _ . \$ * -

SMTP Password:
The maximum password length is 32, does not support the character & =

Sender E-mail: test123@gmail.com Test Success

First Receiver: test@163.com
The maximum length of the receiver is 63, support numbers, letters and symbols @ _ . \$ * -

Second Receiver: tset@hotmail.com

Third Receiver:

Fourth Receiver:

Test result

Figure 4.42

If the test success, you can see the **Success** behind the Test, at the same time the receivers will receive a test mail.

If the test fails with one of the following errors after clicking **Test**, **verify** that the information you entered is correct and again select **Test**.

- 1) Cannot connect to the server
- 2) Network Error. Please try later
- 3) Server Error
- 4) Incorrect user or password
- 5) The sender is denied by the server. Maybe the server need to authenticate the user, please check it and try again
- 6) The receiver is denied by the server. Maybe because of the anti-spam privacy of the server
- 7) The message is denied by the server. Maybe because of the anti-spam privacy of the server
- 8) The server does not support the authentication mode used by the device

4.3.8 FTP Settings

If you want to upload record files and images to your FTP server, you can set **FTP Settings**.

| FTP Settings | |
|-------------------------------------|--|
| FTP Server | ftp://192.168.1.103/dir Example:ftp://192.168.1.103/dir The maximum length of the address is 127, does not support the character & = |
| Port | 21 |
| FTP Mode | PORT |
| Username | test The maximum length of the user name is 63, support Simplified Chinese, numbers, letters and symbols _ @ \$ * - . # ! |
| Password | •••• The maximum password length is 63, including numbers, letters and symbols ~ ! @ # * () _ { } : " < > ? ^ ` - ; ' \ , . / |
| <input type="button" value="Test"/> | |

Figure 4.43

| FTP Settings | |
|-------------------------------------|---|
| FTP Server | ftp://ftp.mgenseal.com Example:ftp://192.168.1.103/dir The maximum length of the address is 127, does not support the character & = |
| Port | 21 |
| FTP Mode | PORT |
| Username | test The maximum length of the user name is 63, support Simplified Chinese, numbers, letters and symbols _ @ \$ * - . # ! |
| Password | •••• The maximum password length is 63, including numbers, letters and symbols ~ ! @ # * () _ { } : " < > ? ^ ` - ; ' \ , . / |
| <input type="button" value="Test"/> | |

Figure 4.44

FTP server: If your FTP server is located on the LAN, you can set as Figure 3.54.

If you have an FTP server which you can access on the internet, you can set as Figure 3.55.

Port: Default is port 21. If changed, external FTP client program must change the server connection port accordingly.

FTP Mode: Here supports two modes: PORT and PASV.

Username/password: The FTP account and password.

Click **Save** to take effect.

Click **Test** to see if FTP has been successfully configured.

4.3.9 P2P

Access the IP Camera by Smart Phone (Android or iOS operating system)

First of all, you need to open the P2P function of the IP Camera at “Settings-->Network-->P2P”.

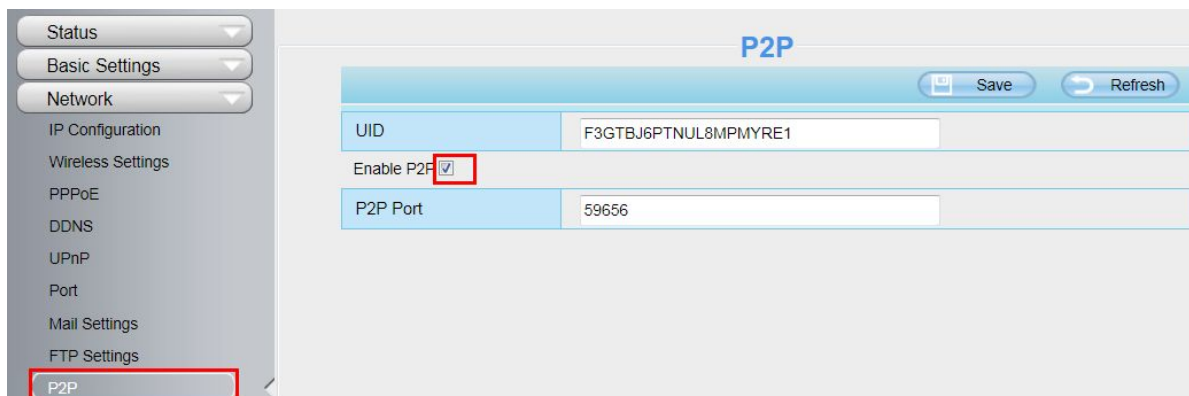

Figure 4.45

Search and install Foscam Viewer on Google Play for Android devices, search and install Foscam Viewer on APP Store for iOS devices.

If you want to know more details of the iOS APP or Android APP, see the *iOS App User Manual* or *Android App User Manual*.

4.4 Video

This section allows you to configure Video stream settings, On screen display and Snapshot settings.

4.4.1 Video Settings

There are two ways to set the stream video settings. They are main stream video settings and sub stream video settings.

The screenshot shows the 'Video Settings' page. On the left, a sidebar menu has 'Video Settings' selected. The main content area is titled 'Video Settings' and includes 'Save' and 'Refresh' buttons. It is divided into two sections:

Main stream video settings

| | |
|--------------------|------|
| Stream Type | 0 |
| Resolution | 720P |
| Bit Rate | 2M |
| Frame Rate | 30 |
| Key Frame Interval | 30 |
| Variable bitrate | Yes |

Sub stream video settings

| | |
|--------------------|--------------|
| Stream Type | 0 |
| Resolution | VGA(640*480) |
| Bit Rate | 512K |
| Frame Rate | 15 |
| Key Frame Interval | 45 |

Figure 4.46

Stream type: There are four types to identify different streams you have set.

Resolution: The camera supports two types: 720P, VGA. The higher the resolution is, the clearer video will become. But the code flux will become larger too, and it will take up more bandwidth.

Bit rate: Generally speaking, the larger the bit rate is, the clearer video will become. But the bit rate configuration should combine well with the network bandwidth. When the bandwidth is very narrow, and bit rate is large, that will lead to video can not play well.

Frame rate: Note that a larger frame size takes up more bandwidth. When the video format is 50Hz, the maximum frame rate is 25 fps. When the video format is 60Hz, the maximum frame rate is 30 fps. You should lower frame rate when the bandwidth is limited. Normally, when the frame rate above 15, you can achieve fluently video.

Key Frame Interval: The time between last key frame and next key frame. The shorter the duration, the more likely you will get a better video quality, but at the cost of higher network bandwidth consumption.

Variable Bitrate: The two options are Yes and NO. Select Yes the bit rate is variable, and the highest value isn't higher than Bit Rate Value (2Mbps). Select NO and the bit rate is constant with Bit Rate Value (2Mbps).

4.4.2 On Screen Display

This page is used to add timestamp and device name on the video.

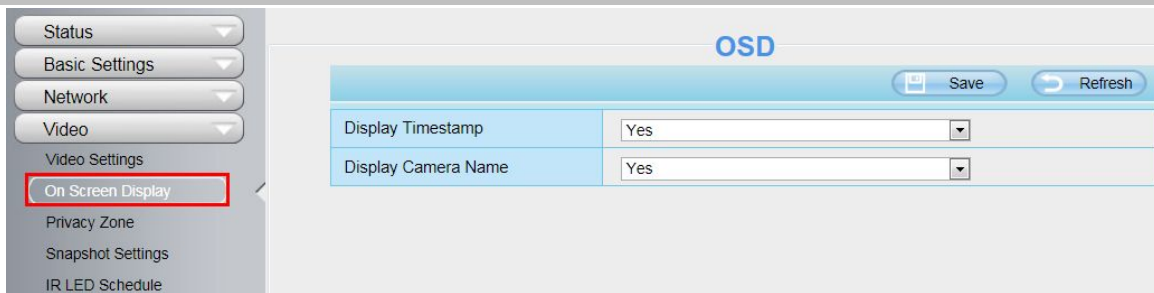

Figure 4.47

Display Timestamp: There are two options: Yes or NO. Select Yes and you can see the system date on the video,

Display Camera Name: There are two options: Yes or NO. Select Yes and you can see the device name on the video.

4.4.3 Privacy Zone

This page is used to set some mask as privacy zone on the video.

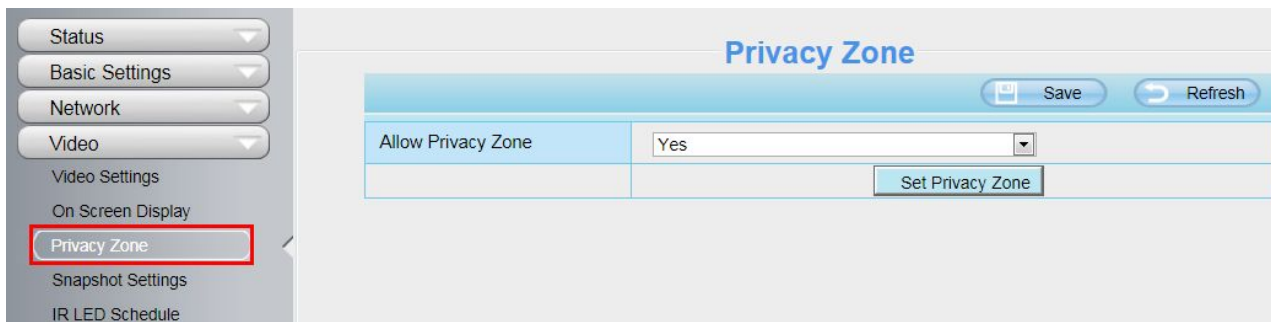

Figure 4.48

Allow Privacy Zone: There are two options: Yes or NO. Select Yes, then click “Set Privacy Zone” and draw a privacy area on the video, the privacy area will be black on the video.

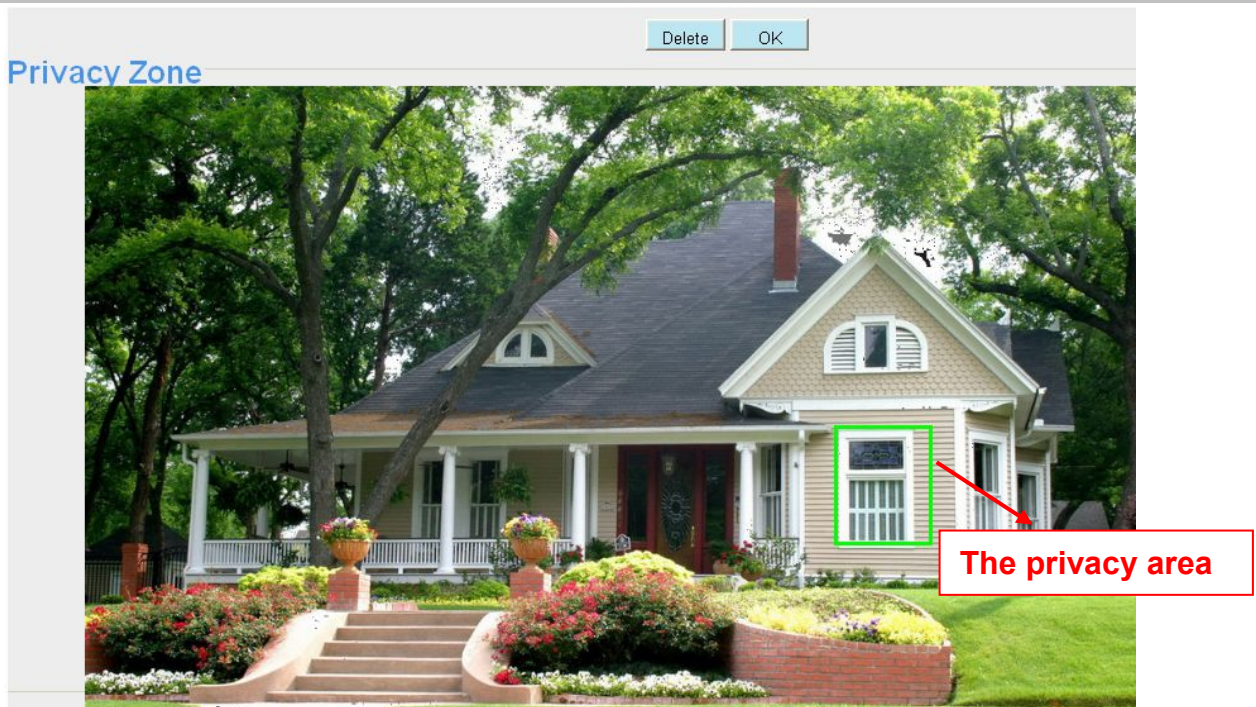

Figure 4.49

Click **OK** button and return to the Privacy Zone page, click Save to take effect.

Back to the surveillance window, you can see the mask area as the following picture:

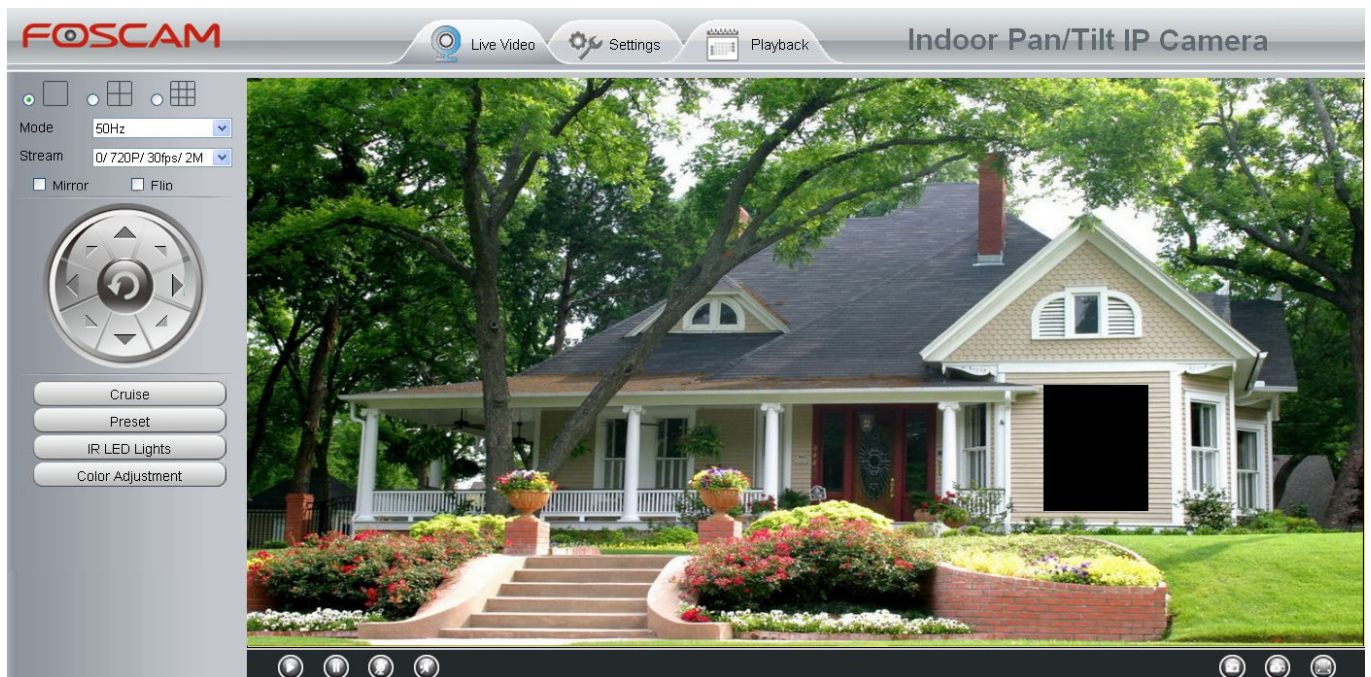

Figure 4.50

4.4.4 Snapshot Settings

On this page you can set the snapshot pictures' image quality and the storage path.

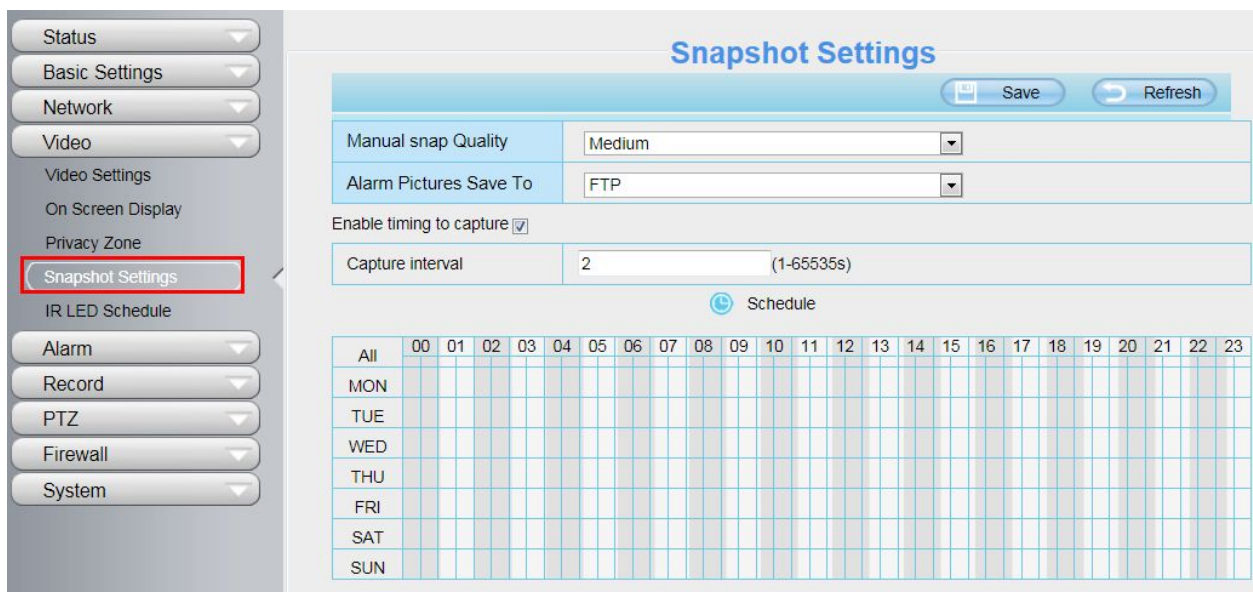

Figure 4.51

Manual snap Quality: Low, Middle and High. The higher the quality, the picture will be clearer.

Alarm Pictures Save To: FTP or SD Card. If you have done FTP and Alarm settings, when alarming, the camera will snap pictures to the FTP automatically. If select SD Card as the save path, make sure the camera has inserted in the SD card.

Enable timing to capture

To enable capture interval, follow the steps below:

1 Select Enable timing to capture

2 Capture interval:The interval time between two captures.

3 Select the capture time

- Capture anytime

Click the black button up the MON, you will see all time range turn red. When something moving in the detection area at anytime, the camera will capture.

- Specify an capture schedule

Click the week day words, the corresponding column will be selected. For example, click TUE, the all column of TUE turns to red, that means during Tuesday whole day, the camera will capture.

- Press the left mouse and drag it on the time boxes, you can select the serial area,

4 Click Save button to take effect.

4.4.5 IR LED Schedule

On this page you can set the schedule time for switching IR LED lights. When parameter Mode is set to the **Schedule** on the **Live Video** window, at these schedule time, the IR LED lights will be turned off.

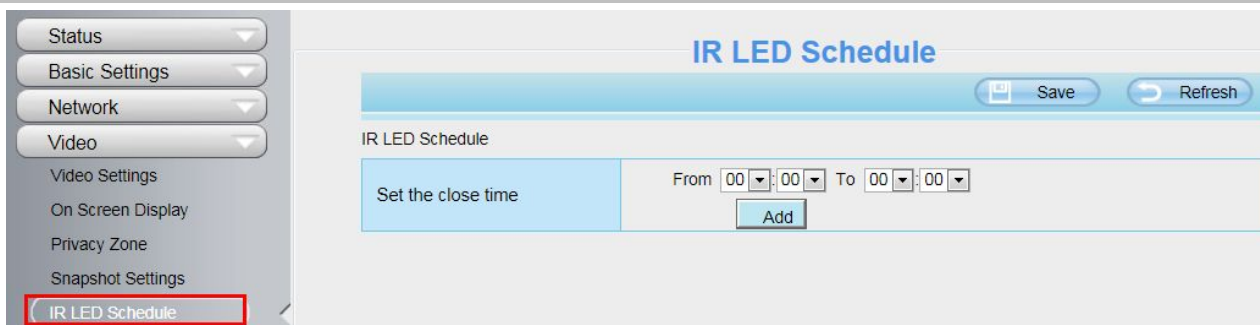

Figure 4.52

4.5 Alarm

IP Camera supports **Motion Detection Alarm**, when the motion has been detected, it will send emails or upload images to FTP.

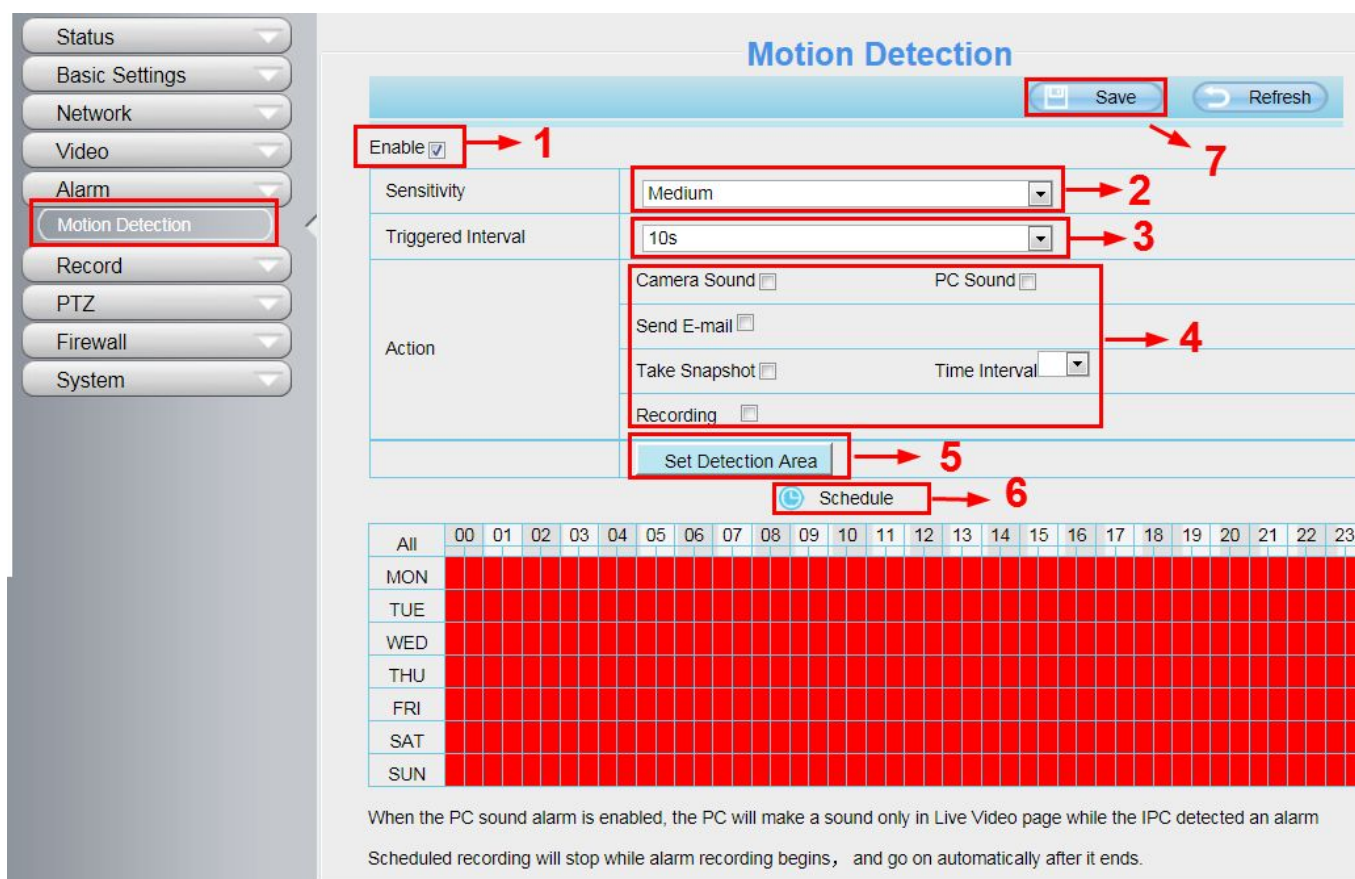

Figure 4.53

To enable motion detection, follow the steps below:

Step 01: Enable Motion detection

Step 02: Sensitivity---- It supports five modes: Lowest, Lower, Low, Medium and High. The higher the sensitivity, the camera will be more easily alarmed. Select one motion sensitivity.

Step 03: Trigger interval--- The interval time between two motion detections. Here supports

5s/6s/7s/8s/9s/10s/11s/12s/13s/14s/15s. Select one interval time.

Step 04: Select the alarm indicator

When the motion has been detected, the alarm status will turn to Detect alarm.

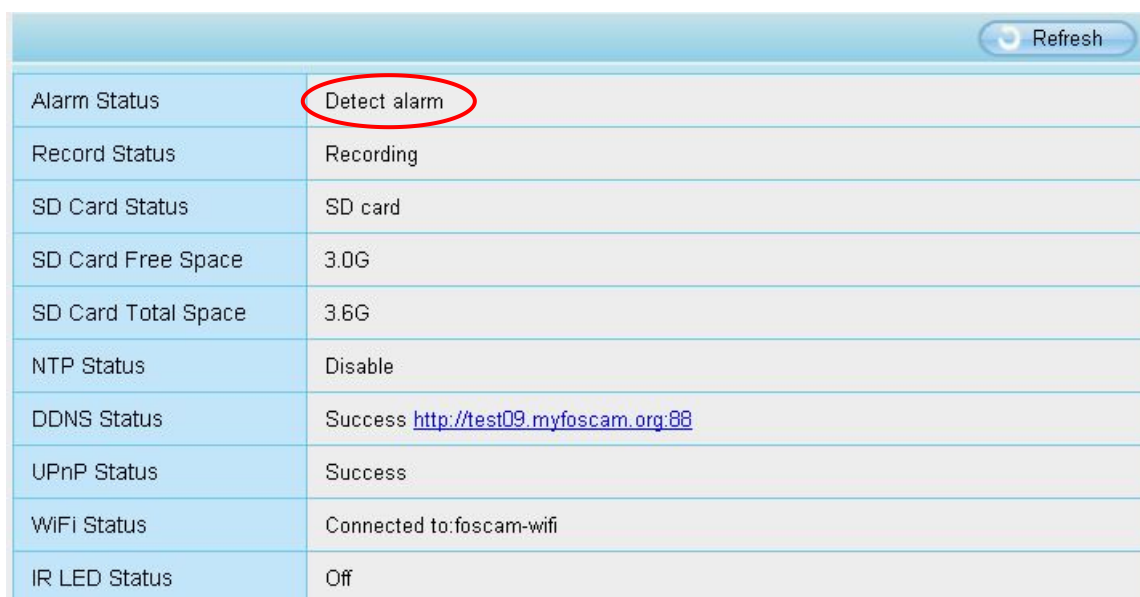

| Refresh | |
|---------------------|---|
| Alarm Status | Detect alarm |
| Record Status | Recording |
| SD Card Status | SD card |
| SD Card Free Space | 3.0G |
| SD Card Total Space | 3.6G |
| NTP Status | Disable |
| DDNS Status | Success http://test09.myfoscam.org:88 |
| UPnP Status | Success |
| WiFi Status | Connected to:foscam-wifi |
| IR LED Status | Off |

Figure 4.54

There are four alarm indicators:

A Camera Sound and PC Sound

If the camera has connected with a speaker or other audio output device, if you select Camera Sound or PC Sound, when the motion has been detected, the people around the camera will hear beep alarm sound.

B Send E-mail

If you want to receive alarm emails when motion is detected, you must select Send E-mail and set Mail Settings first.

C Take Snapshot

If you select this checkbox, when the motion has been detected, the camera will snap the live view window as a still picture and load it to the FTP. Make sure you have set FTP and set FTP as the storage path in Video->Snapshot settings panel.

Capture interval: The interval time between two pictures.

D Record

If you select this checkbox, when the motion has been detected, the camera will record automatically and store the record files to the SD Card. Make sure the camera has inserted SD card and you have set the SD card as the Alarm record files storage path, please go to **Record—> Storage location** page to verify this settings.

The default alarm record time is 30s and pre-alarm record time is 5s, please go to **Record—> Alarm Record** page and change the alarm time settings.

Step 05: Set detect area

Click set detect area and it pop up a window, then you can draw the detection area. Click **Back** button after settings. When something moving in the detection area, the camera will alarm.

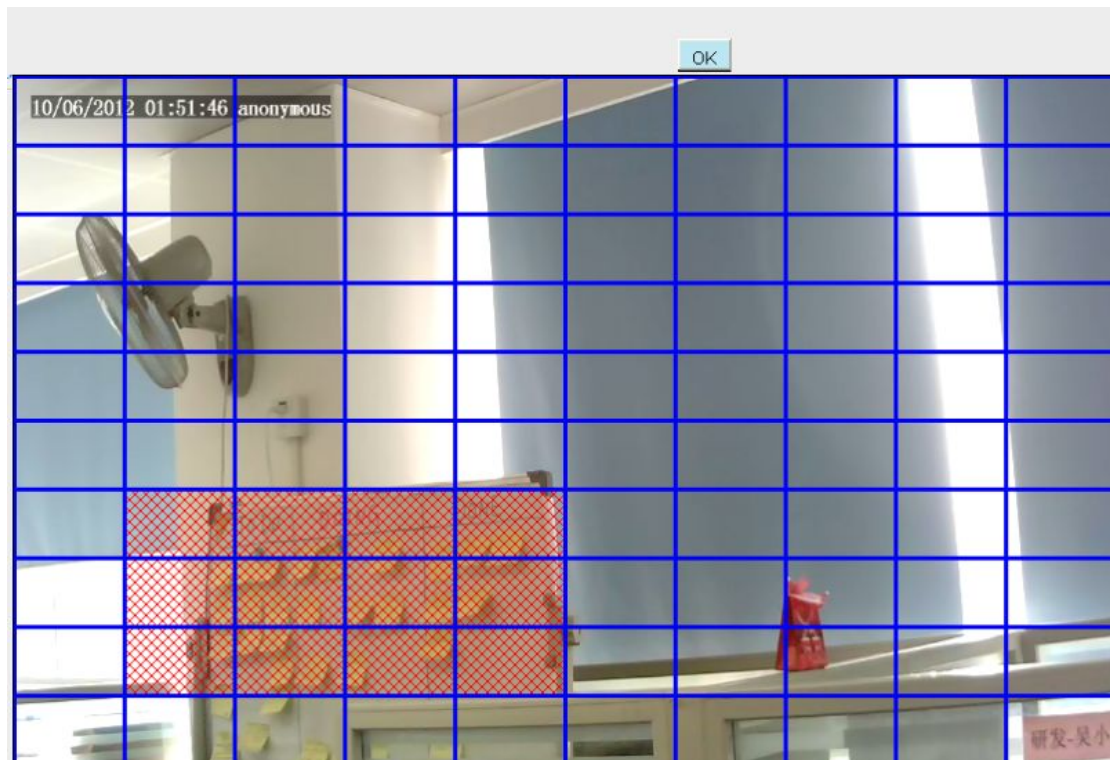

Figure 4.55

Step 06: Alarm Schedule

① Alarm anytime when motion is detected

Click the black button up the MON, you will see all time range turn red. When something moving in the detection area at anytime, the camera will alarm.

| | |
|--|--|
| Action | Ring <input type="checkbox"/> |
| | Send E-mail <input type="checkbox"/> |
| | Take Snapshot <input type="checkbox"/> Time Interval <input type="text" value="2s"/> |
| | Record <input type="checkbox"/> |
| <input type="button" value="Set Detection Area"/> | |
| Click this button and select all time range | |
| | 00 01 02 03 04 05 06 07 08 09 10 11 12 13 14 15 16 17 18 19 20 21 22 23 |
| MON | |
| TUE | |
| WED | |
| THU | |
| FRI | |
| SAT | |
| SUN | |

Figure 4.56

② Specify an alarm schedule

Click the week day words, the corresponding column will be selected. For example, click TUE, the all column of TUE turns to red, that means during Tuesday whole day, when something moving in the detection area, the camera will alarm.

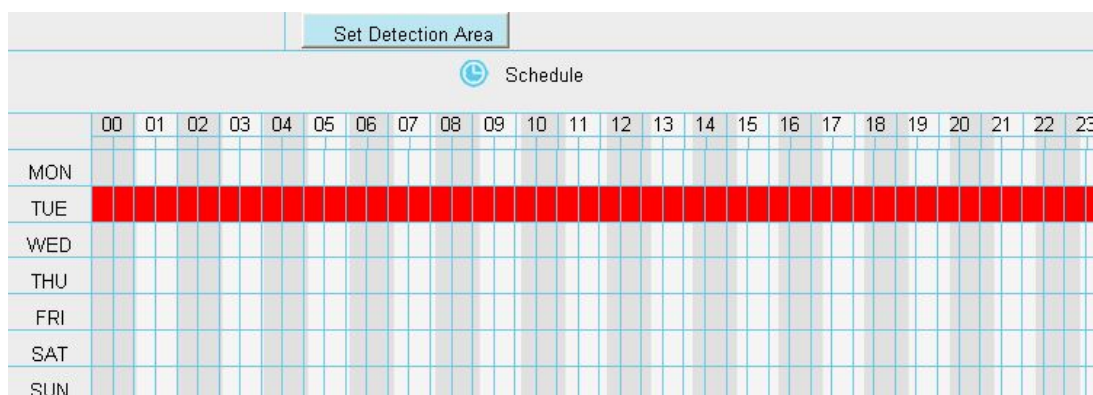

Figure 4.57

③ Press the left mouse and drag it on the time boxes, you can select the serial area.

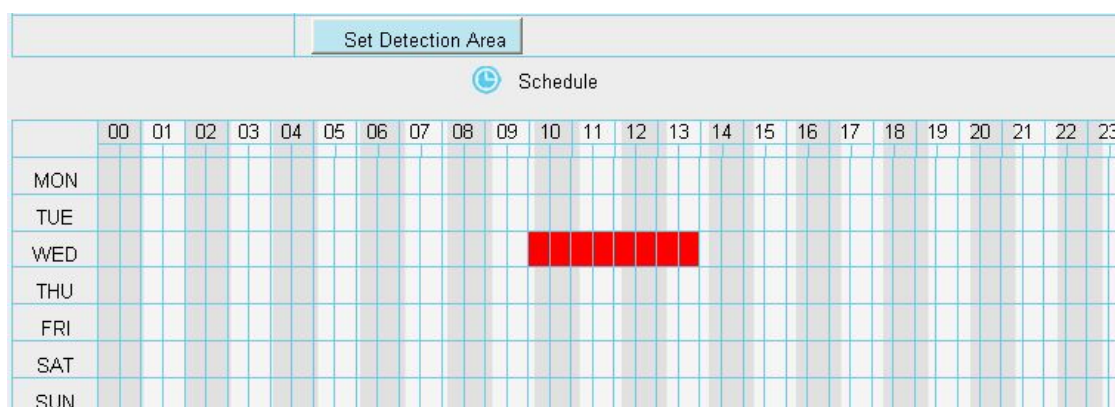

Figure 4.58

Step 07: Click Save button to take effect.

When the motion has been detected during the detection time in the detection area, the camera will alarm and adopt the corresponding alarm indicators.

NOTE:

You must set the detection area and detection schedule, or else there is no alarm anywhere and anytime.

4.6 Record

This section will allow you to change the record files storage path and the record time.

4.6.1 Storage Location

On this page you can change the alarm and manually recording storage path.

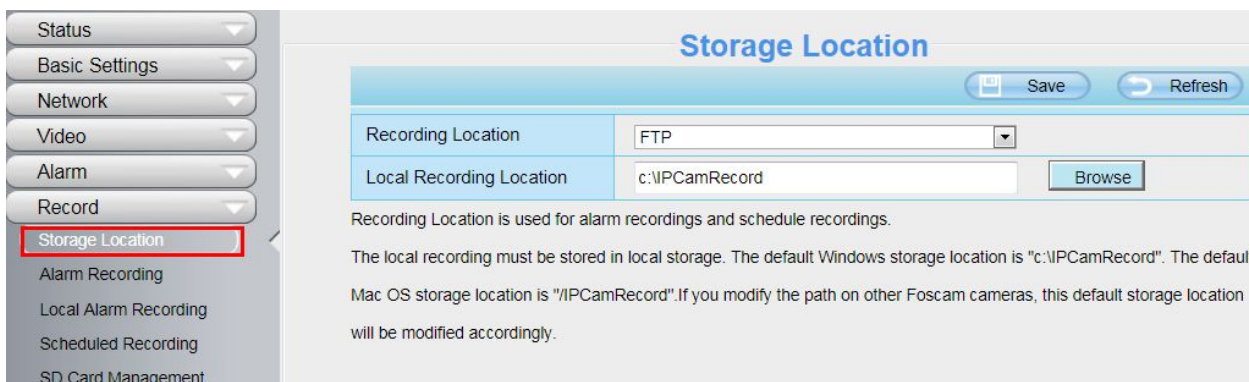

Figure 4.59

Recording Location: SD card. When the camera alarmed, it will store the alarm files to the SD card. Make sure the camera has been inserted the SD card. On this page, you can see the available space of the SD card.

Local Recording Location: For Windows OS, the location recording path is c:/ IPCamRecord, you can change another one. For MAC OS, the manual recording path is: / IPCamRecord.

4.6.2 Alarm Record

This page you can change the Pre-record time and Alarm record time.

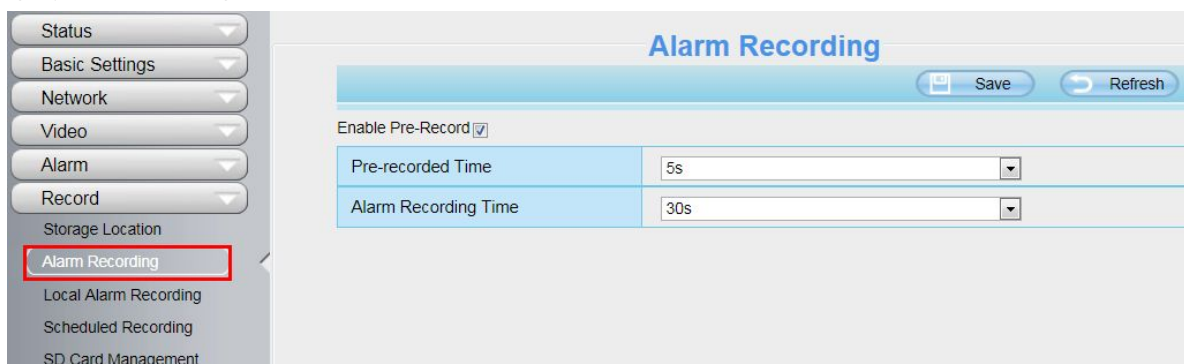

Figure 4.60

The default Pre-recorded time is 5s and the alarm record time is 30s, you can change another time, click Save button to take effect.

4.6.3 Local Alarm Record

This page you can enable the local alarm record and Local Alarm record time.

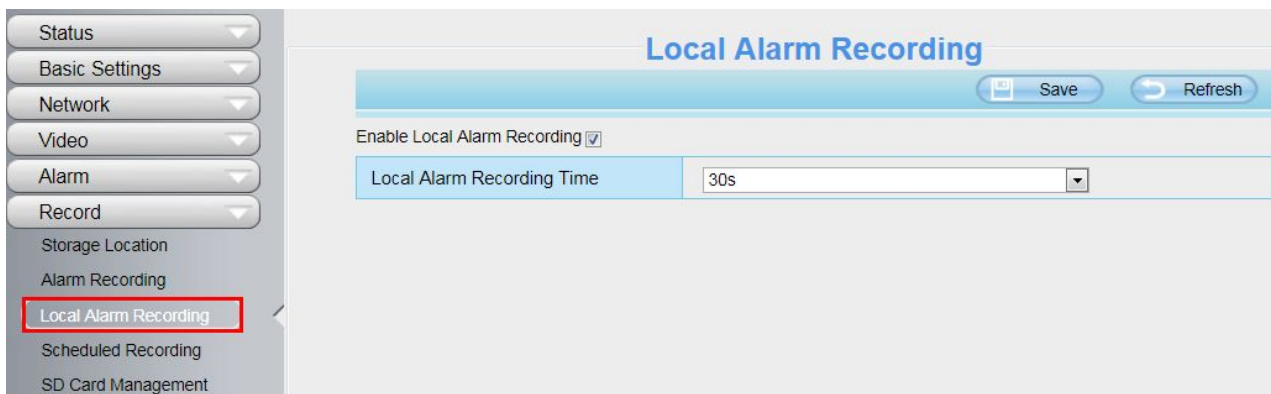

Figure 4.61

4.6.4 Schedule Recording

On the page you can configure the schedule record.

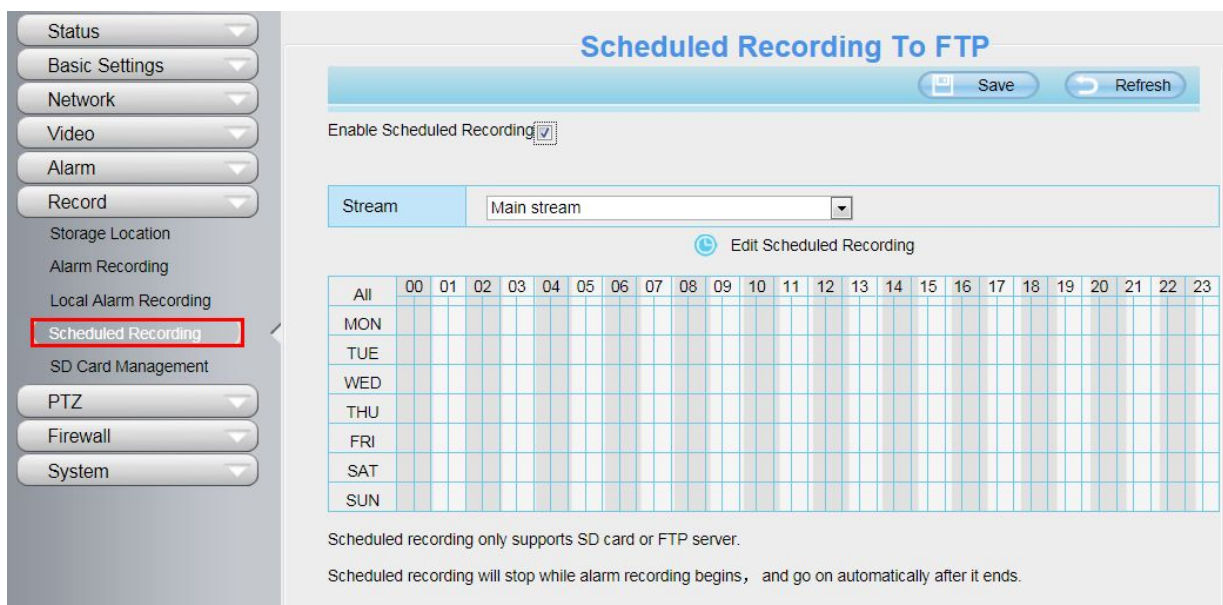

Figure 4.62

You can select the main stream or sub stream from the drop-down.

You can set the store path of the recording file on the **Storage Location** page.

Click **Save** button to take effect.

4.6.5 SD Card Management

This camera supports SD Card and the max size of SD card must be under 32G.

When you plug in the SD card during the camera work process, please reboot the camera again, or else the SD Card may be cannot work well.

This page you can check the SD card information.

| SD Card Management | | Refresh |
|---------------------|---------|--------------------|
| SD Card Status | SD card | SD Card Management |
| SD Card Free Space | 1.5GB | |
| SD Card Total Space | 14.6GB | |

Note: SD card management is only effective when access the IPC in LAN

Figure 4.63

Go to the **Settings**→**Status**→**Device Status** page, you can see the SD card status.

| Device Status | | Refresh |
|---------------------|---------------|---------|
| Alarm Status | No alarm | |
| Recording Status | Not Recording | |
| SD Card Status | SD card | |
| SD Card Free Space | 1.5GB | |
| SD Card Total Space | 14.6GB | |
| NTP Status | Disabled | |
| DDNS Status | Disabled | |
| UPnP Status | Failed | |
| WiFi Status | Not connected | |
| IR LED Status | Off | |

Figure 4.64

The default storage path of alarm record files is SD card, when the available size of SD card is less than 256M, the old record files will be deleted automatically.

4.7 PTZ

This page will allow you to change the pan/tilt speed and do cruise tracks settings.

4.7.1 Pan/Tilt Speed

There are five Pt speed types: very fast, fast, normal, slow and very slowly. Select the desired PTZ speed type and click save button .



Figure 4.65

4.7.2 Cruise Settings

This section explains how to add/ delete one cruise track.

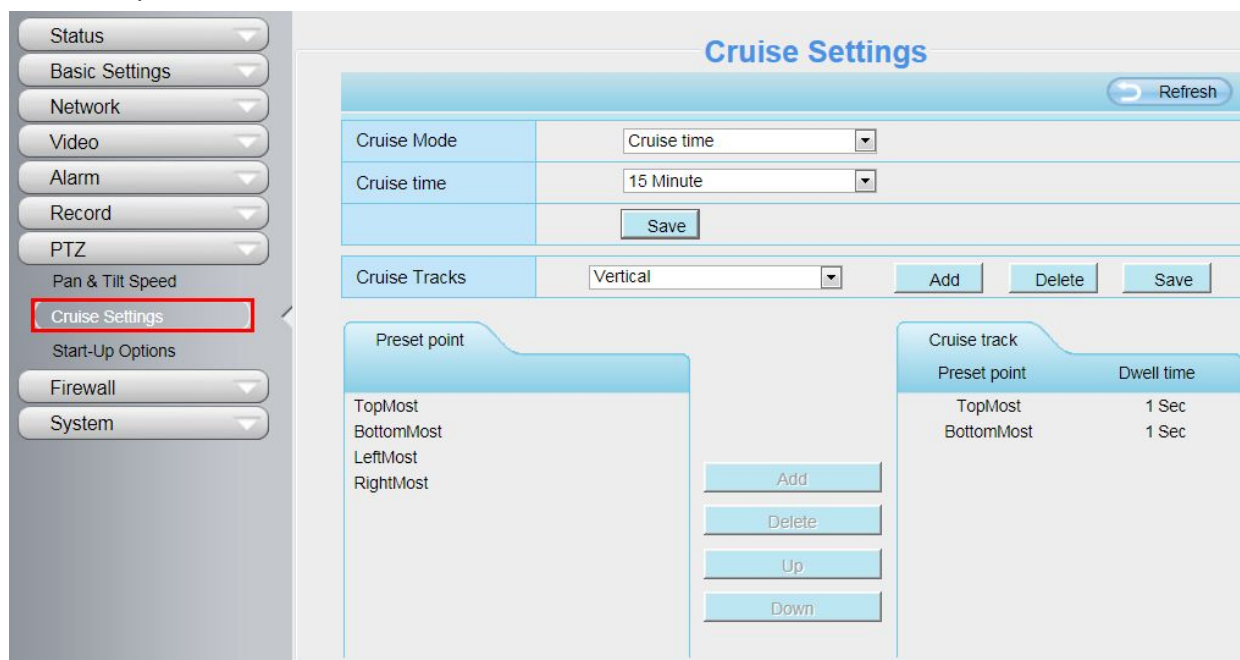

Figure 4.66

Setting the Cruise Mode

There are two cruise mode: Cruise time and Cruise Loops.

Cruise time: Select **Cruise time** from **Cruise Mode** drop-down, then you can set the **Cruise time** of the camera.

Cruise Loops: Select **Cruise Loops** from **Cruise Mode** drop-down, you can set the **Cruise Loops** of the camera.

Click **Save** to take effect.

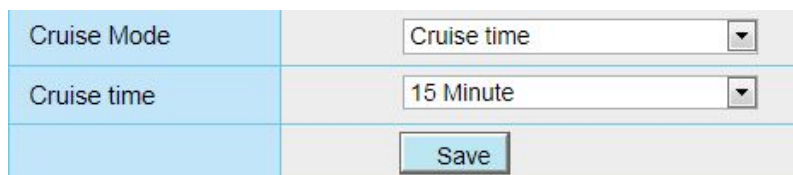

| | |
|--------------|---|
| Cruise Mode | <input type="text" value="Cruise Loops"/> |
| Cruise Loops | <input type="text"/> loops |
| | <input type="button" value="Save"/> |

Figure 4.67

Manage the Cruise Track

There are two default cruise tracks: Vertical and Horizontal.

Vertical: The camera will rotate from up to down

Horizontal: The camera will rotate from left to right.

Add: Add one cruise track, then click save button.

Delete: Select one cruise track and delete it.

Save: After you modify the **Dwell time**, you should click **Save** button to take effect.

Example: How to do add cruise tracks ?

Firstly, Click Add button and enter a descriptive name to identify the cruise track.

Secondly: On the lower left of the page, you can see all preset points you have added. Select one preset point and click Add button, you can see the preset point has been added to the cruise track on the cruise track page. You need to add two or more preset points to the cruise track.

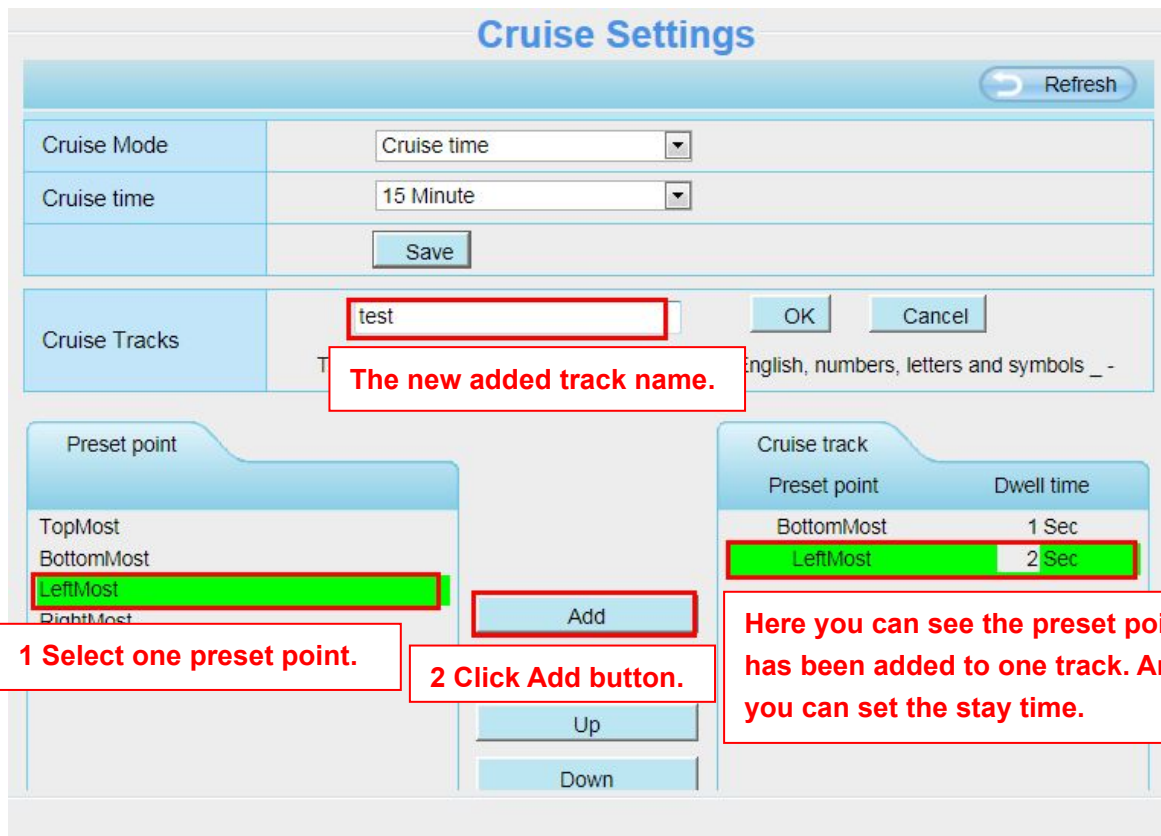

Figure 4.68

Thirdly: Click **OK** button and the cruise track will take effect.

You can add other cruise track as the same method.

For example: I have added three preset points to the “track 1”, that means : When I select the “track 1” on the surveillance window, the camera moves as the following track: upright then Right Most last downleft.

You can add preset on the left of the surveillance window.



Add the preset.

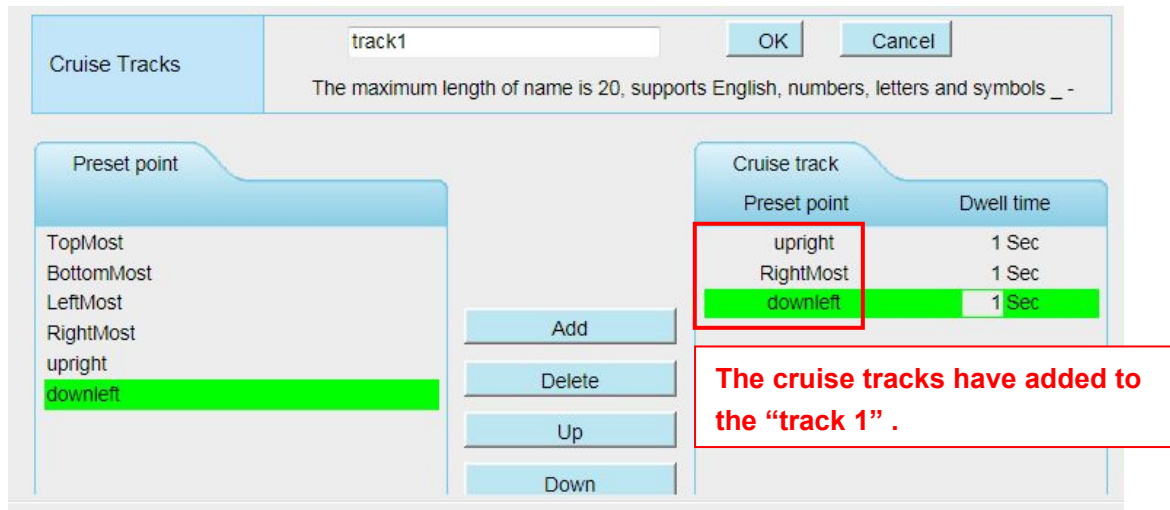

Figure 4.69

After add the cruise track, back to the surveillance window, click Cruise, here you can see all cruise tracks you have added.

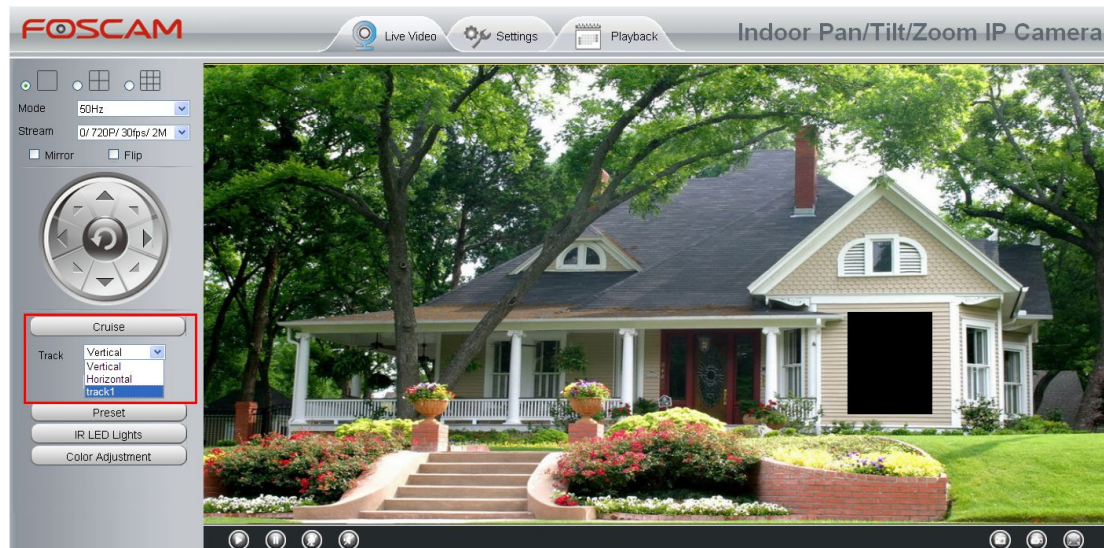

Figure 4.70

There are other buttons between the Preset points and Cruise track, you can use these buttons to adjust the order of preset points or add/delete one preset points in one cruise track.

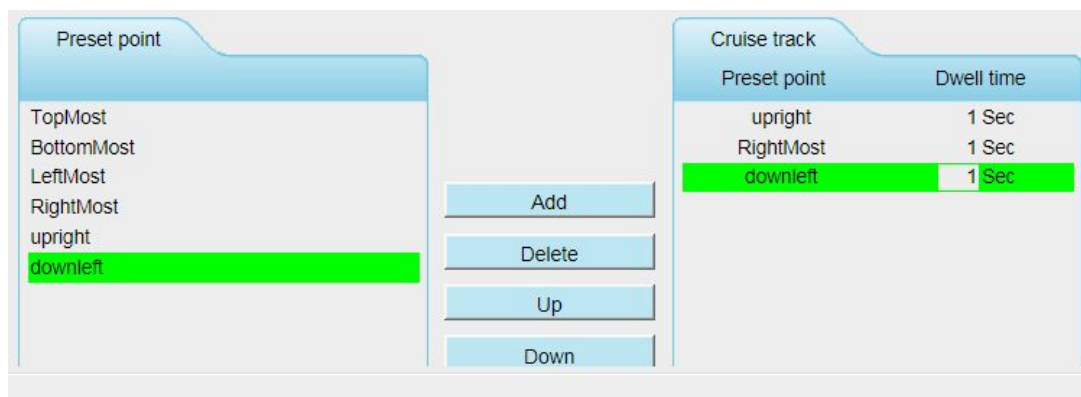

Figure 4.71

Add: Select one preset points and add it to the selected cruise track.

Delete: Select one preset points you have added to one cruise track, click delete.

Move up/ down: Select one cruise track, adjust the order of preset points in one cruise track.

Attention: Considering the life time and thermal issue of the motor, it's not recommend to do long-time cruise.

4.7.3 Start-Up Options

Here section will allow you to set the stop position after the camera reboots.

It supports three modes: Disable Start-Up, Go To Home Position and Go To Preset Position.

Disable Start-Up: When rebooting, the camera will not pan / tilt.

Go To Home Position: When rebooting, the camera will pa Providing Central Management Software to manage or monitor multi-cameras n / tilt and stops at center.

Go To Preset Position: Select one preset position and save it. When rebooting, the camera will pan/ tilt and stops at the preset position you have set.

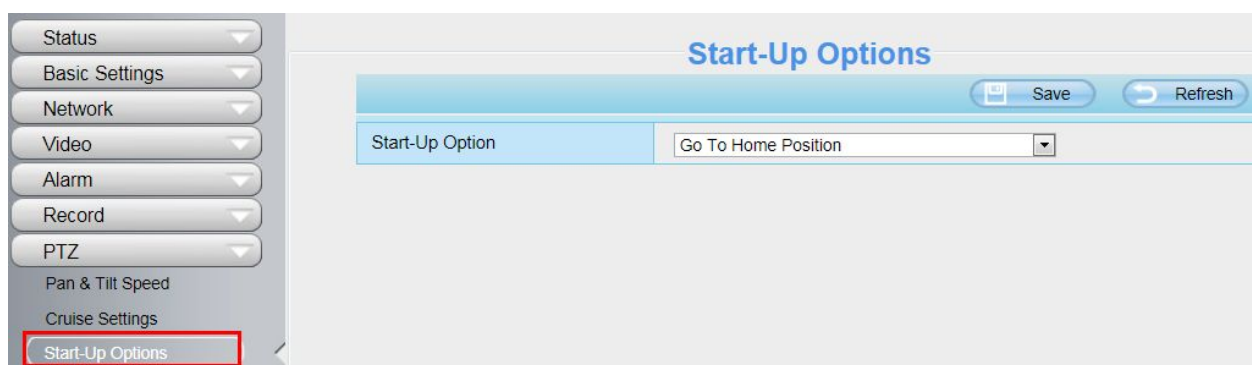

Figure 4.72

4.8 Firewall

This section explains how to control the access permission by checking the client PC's IP addresses. It is composed of the following columns: **Block access from these IP addresses** and **Only allow access from these IP addresses**.

Figure 4.73

Enable firewall, If you select **Only allow access from these IP addresses** and fill in 8 IP addresses at most, only those clients whose IP addresses listed in the **Only allow access from these IP addresses** can access the Network Camera. If you select **Block access from these IP addresses**, only those clients whose IP addresses are in the IP list cannot access the Network Camera.

Click **Save** to take effect.

4.9 System

In this panel, you can backup/restore your camera settings, upgrade the firmware to the latest version, restore the camera to default settings and reboot the device.

4.9.1 Back-up& Restore

Click **Back-up** to save all the parameters you have set. These parameters will be stored in a bin file for future use.

Click **Browse** and select the parameters file you have stored, then click **Submit** to restore the restore the parameters.

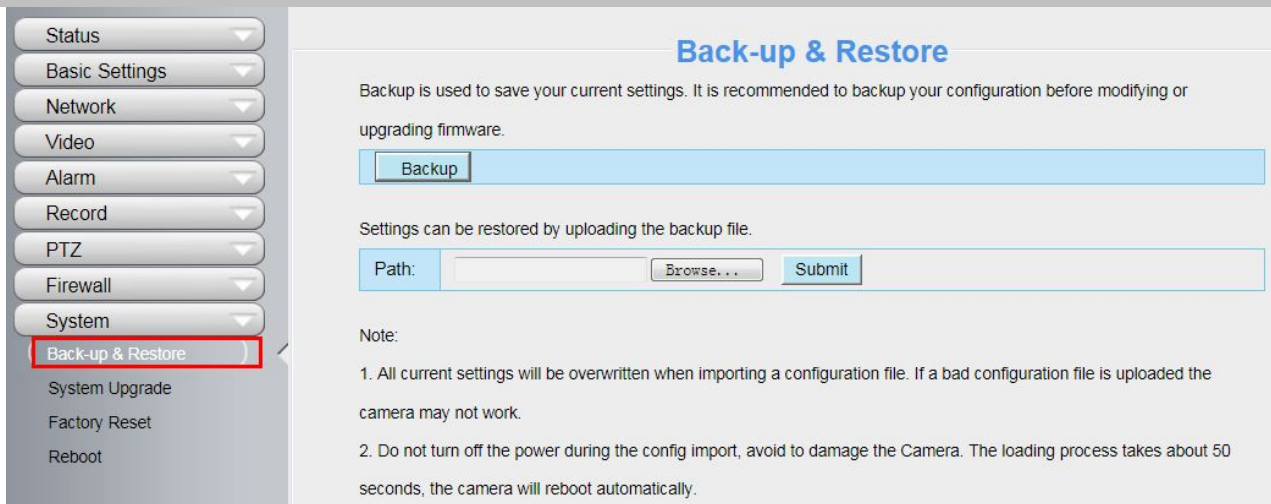

Figure 4.74

4.9.2 System Upgrade

Click “Download the latest firmware”, you will see the following screen. And click “save” to save the firmware on your computer locally.

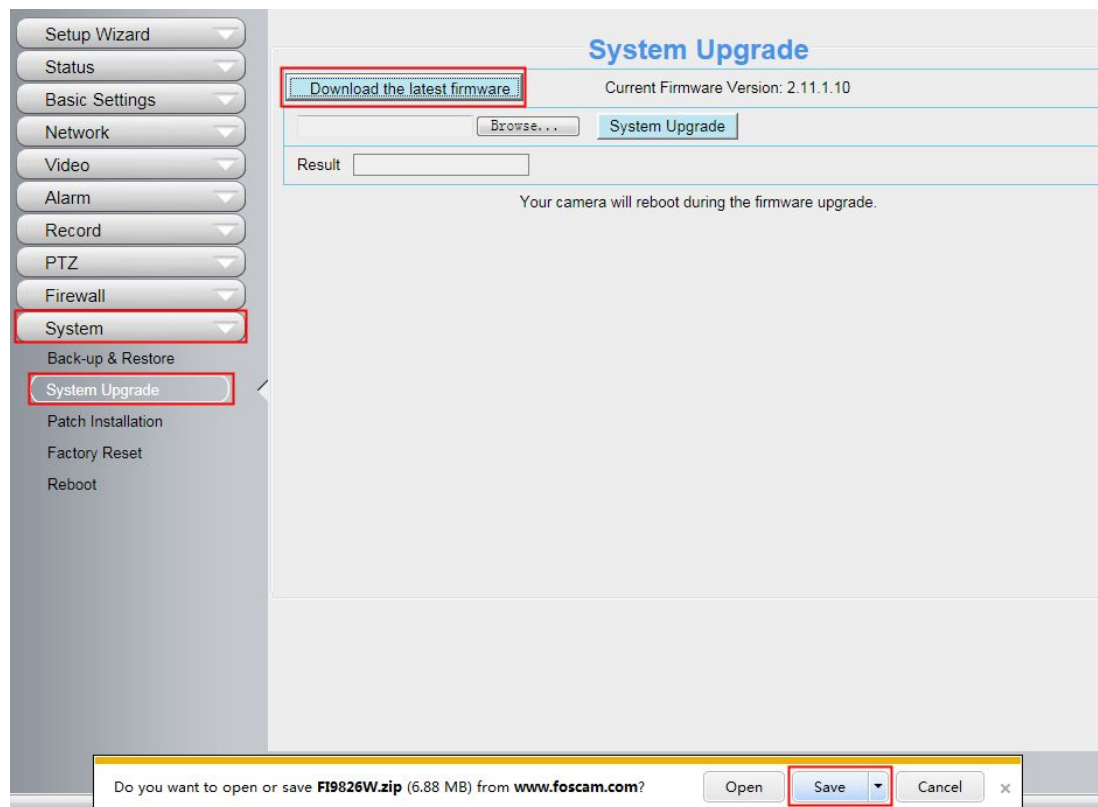

Figure 4.75

Your current firmware version will be displayed on your screen. You may go to the **Status → Device Information** page to check for the latest firmware versions available.

Click **Browse**, choose the correct bin file and then click **System upgrade**.

Don't shut down the power during upgrade. After upgrading, you can see the upgrade result.

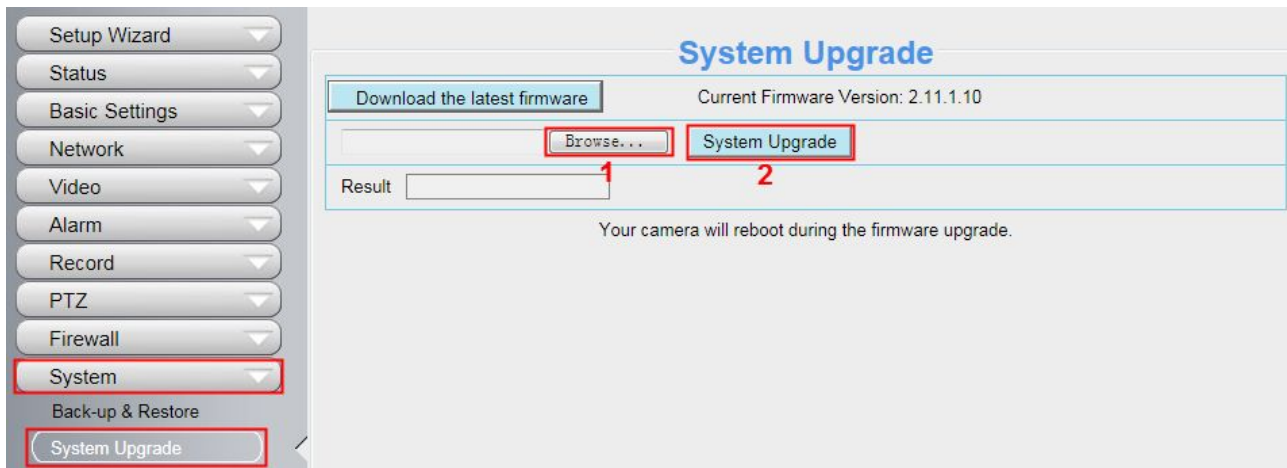

Figure 4.76

Upgrade Firmware by IP Camera Tool



Double click the IP Camera Tool shot icon, select the Camera IP that you want to upgrade the firmware. Then select Upgrade Firmware and enter the username and password, choose the firmware file, and upgrade.

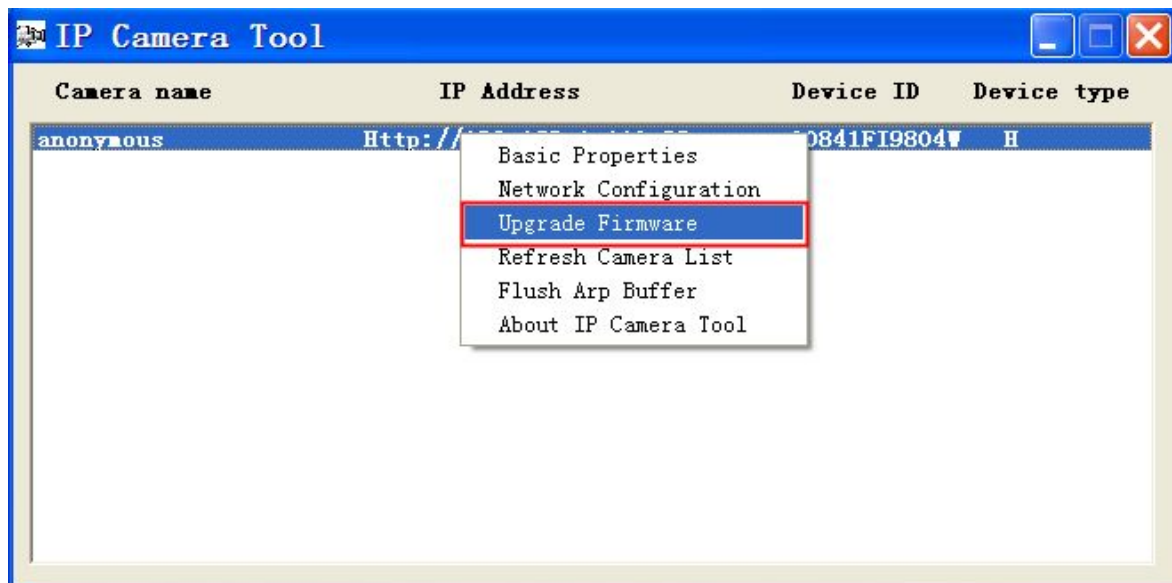

Figure 4.77

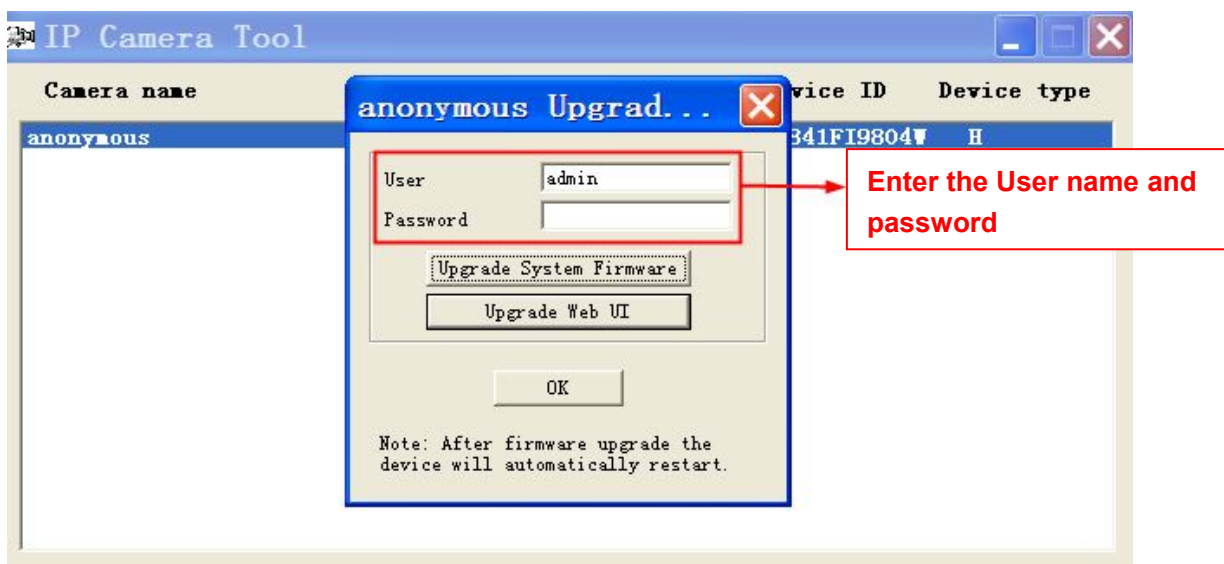

Figure 4.78

CAUTION: If your camera works well with the current firmware, we recommend not upgrading. Please don't upgrade the firmware unnecessarily. Your camera may be damaged if mis-configured during an upgrade.

NOTES:

- 1) Please ensure you have download the correct firmware package for your camera before upgrading. Read the upgrade documentation (readme.txt file) in the upgrade package before you upgrade.
- 2) Upon downloading the firmware check the sizes of the .bin files. They must match the size in the readme.txt file. If not, please download the firmware again until the sizes are the same. Your camera will not function correctly if a corrupt .bin file is used.
- 3) Normally, only Device WEB UI need to be upgrade, please do not try to upgrade the Device System Firmware.
- 4) Never shut down the power of the camera during upgrade until the IP camera restart and get connected.
- 5) After upgrade successfully, please uninstall the old plugin and re-install it, then reset the camera to the default factory settings before using the camera.

NOTE:

The firmware of FI9821P V2 can not be used in FI9821P. For the model of your device, please refer to the MAC stickers on bottom of your device.

4.9.3 Factory Reset

Click All reset and all parameters will return to factory settings if selected. This is similar to press the Reset button on the bottom of the camera.

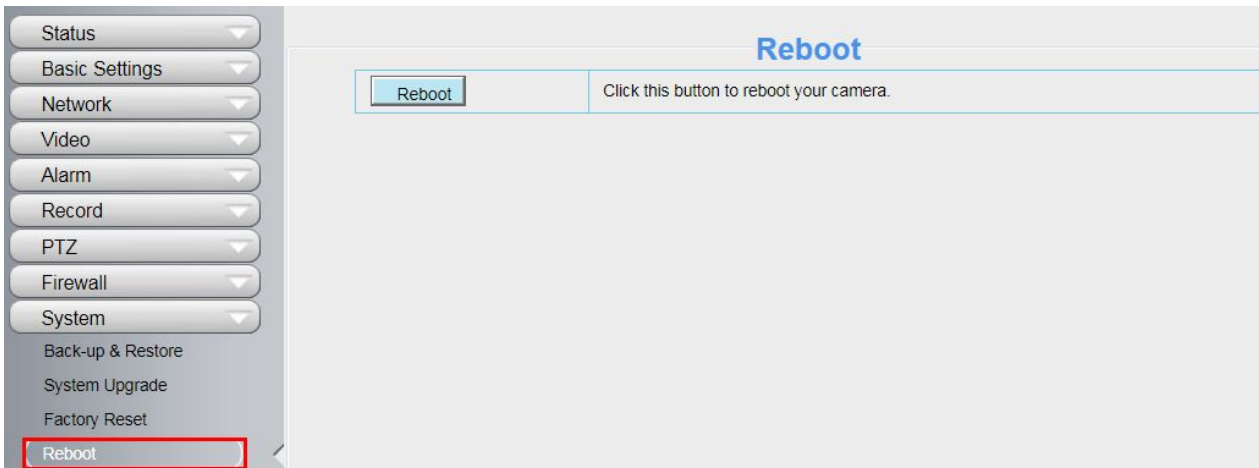

Figure 4.79

4.9.4 Reboot

Click Reboot System to reboot the camera. This is similar to unplugging the power to the camera.

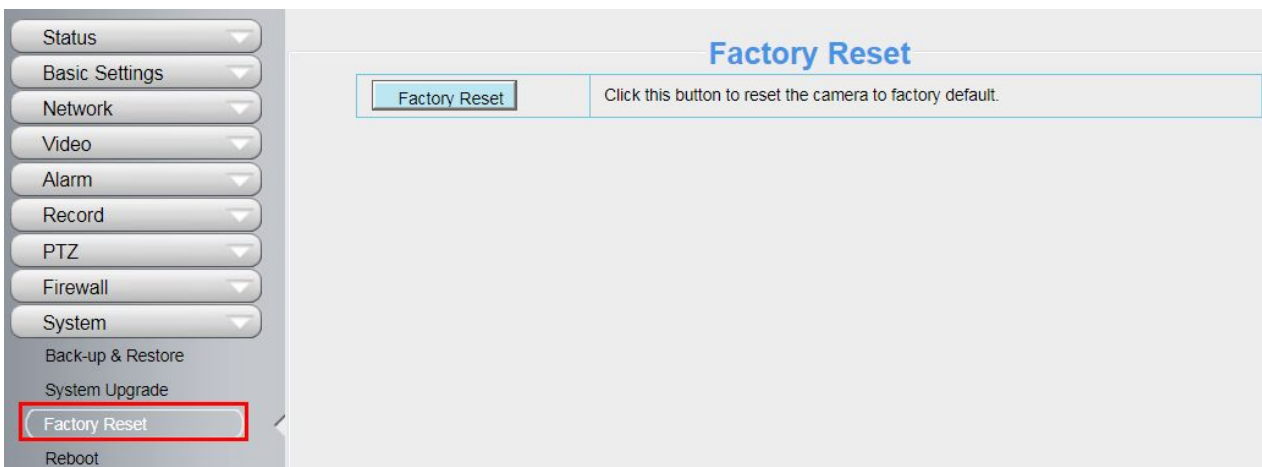
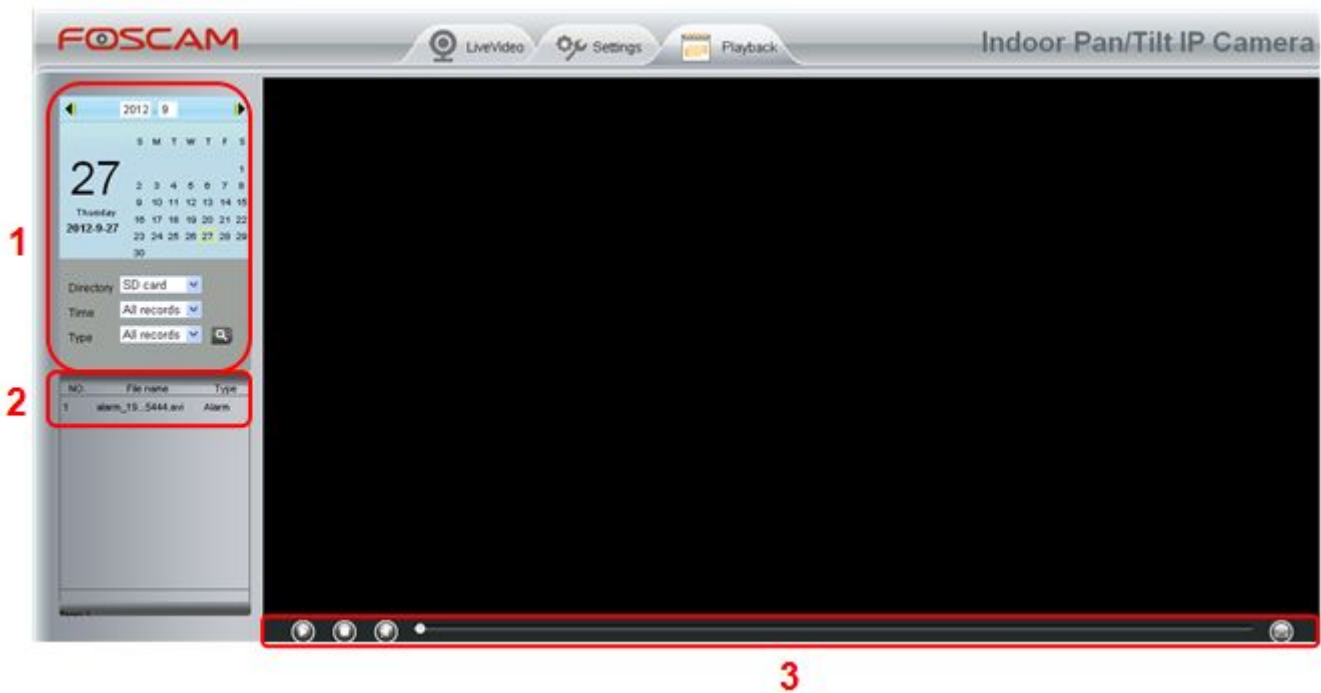

Figure 4.80

5 Playback

On this page you can view the record files stored in the SD card.



Section 1 Define the Record files time and Type

Directory : The storage path of record files

Time : Here supports three types: current day, current month and All records. Another way, select the time on the time&date manually.



Type : The type of records files, Here supports two types: Normal record, Alarm record and All records.



: Click this button to search all record files satisfy the conditions you selected.

Section 2 Search record files

On this panel you can see all record files satisfy the conditions you set.

Section 3 Play/Stop/Audio/Full screen buttons

Please select one record file before use these buttons.



Click this button to play the record files



Click this button to stop the record files



Open or stop audio



Click this button to make full screen, and double click left mouse to exit full screen.

6 Phone Apps

FOSCAM provides iOS App for iOS users, which helps to view and listen to your world anywhere..... anytime. Search and install **Foscam Viewer** on Google Play for Android devices, search and install **Foscam Viewer** on App Store for iOS devices.

If you would like to read more details on the Android App or iOS App, Please refer to the *Android App User Manual* or *iOS App User Manual* .

7 Appendix

7.1 Frequently Asked Questions

NOTE:

Any questions you would meet, please check Network connections firstly. Check the working status revealed by the indicators on the network server, hub, exchange and network card. If abnormal, check the network connections.

7.1.1 Install the add-on of Firefox browser, Google Chrome and IE Chrome.

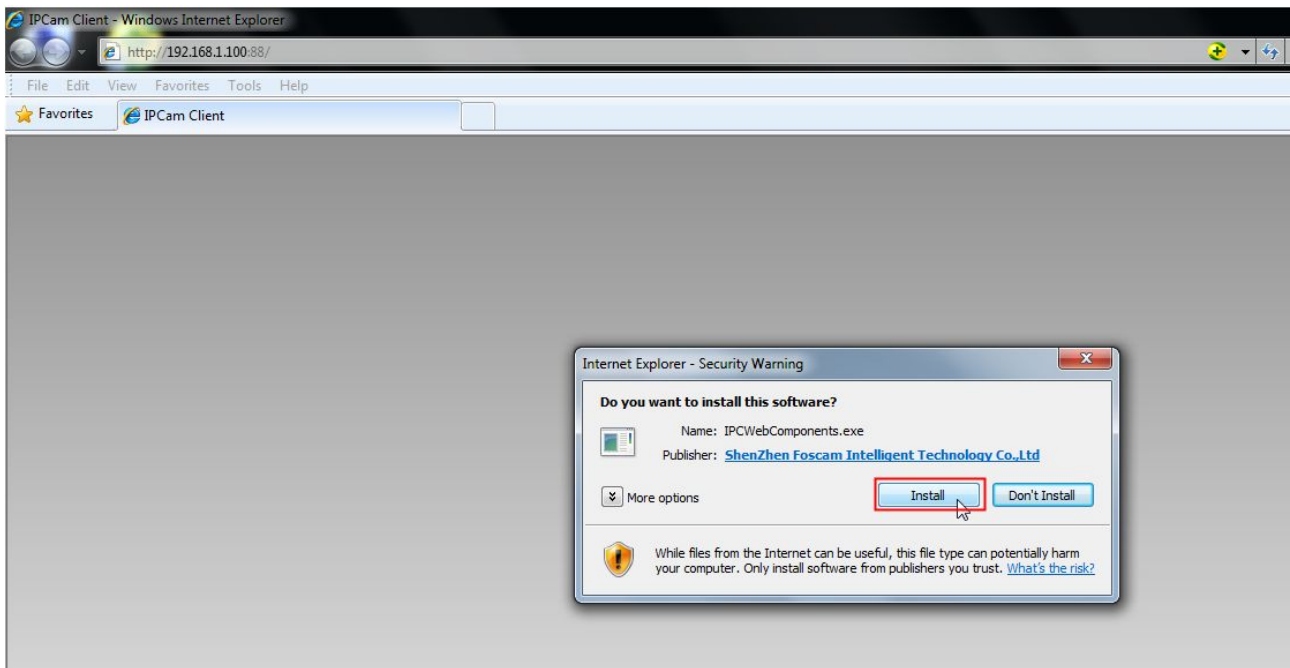

Figure 7.1

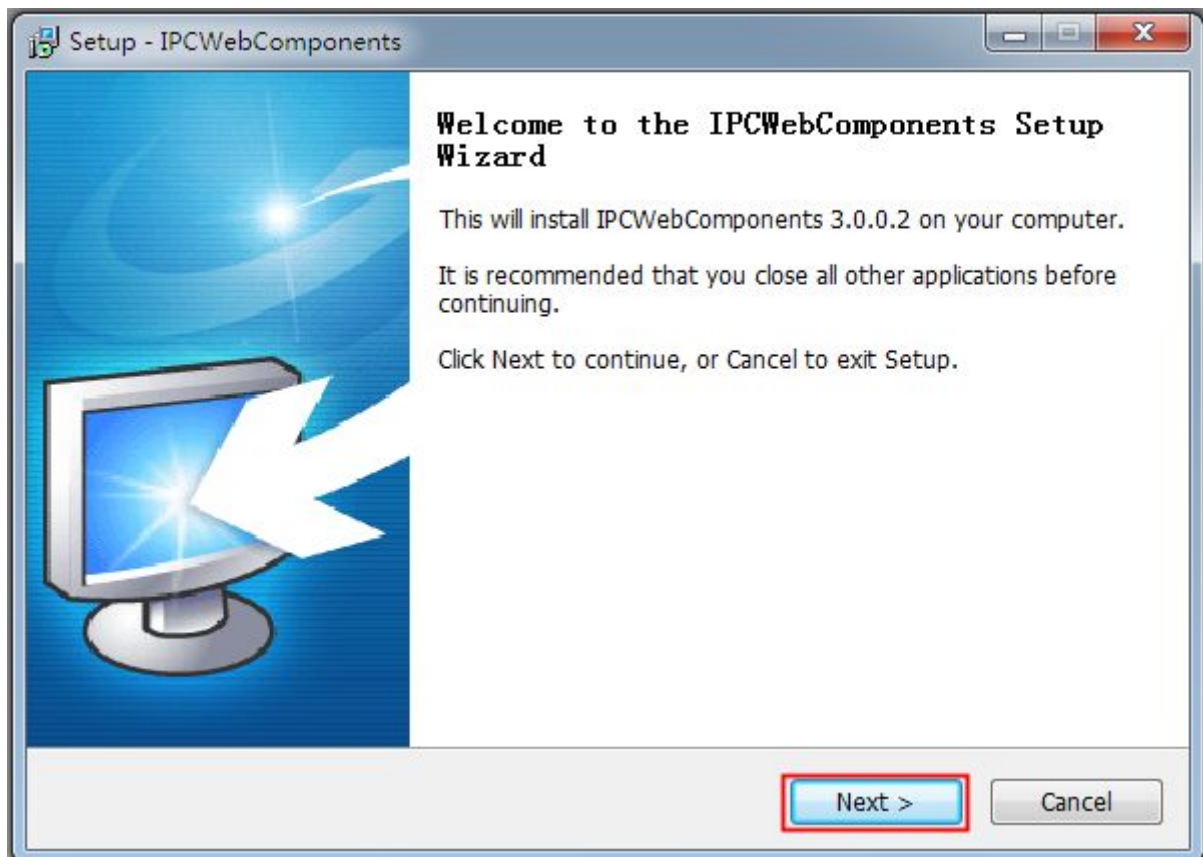

Figure 7.2

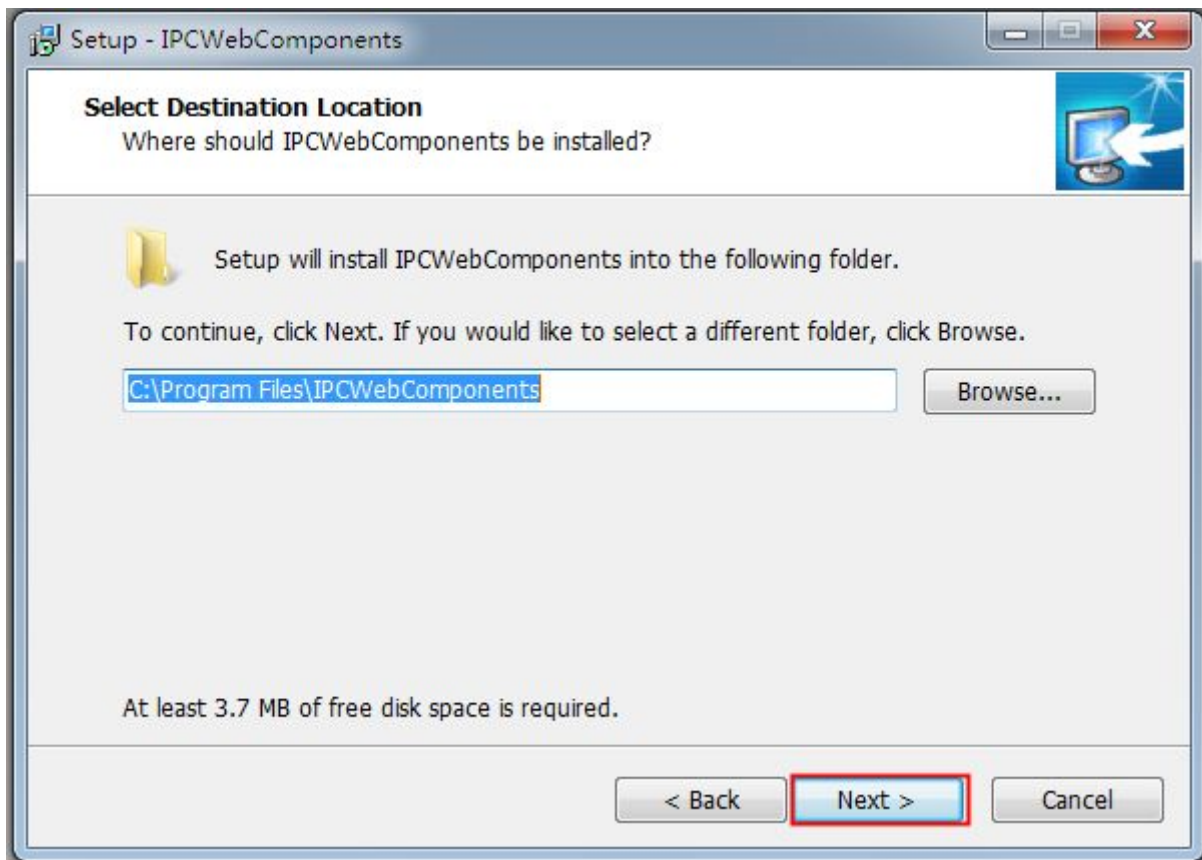

Figure 7.3

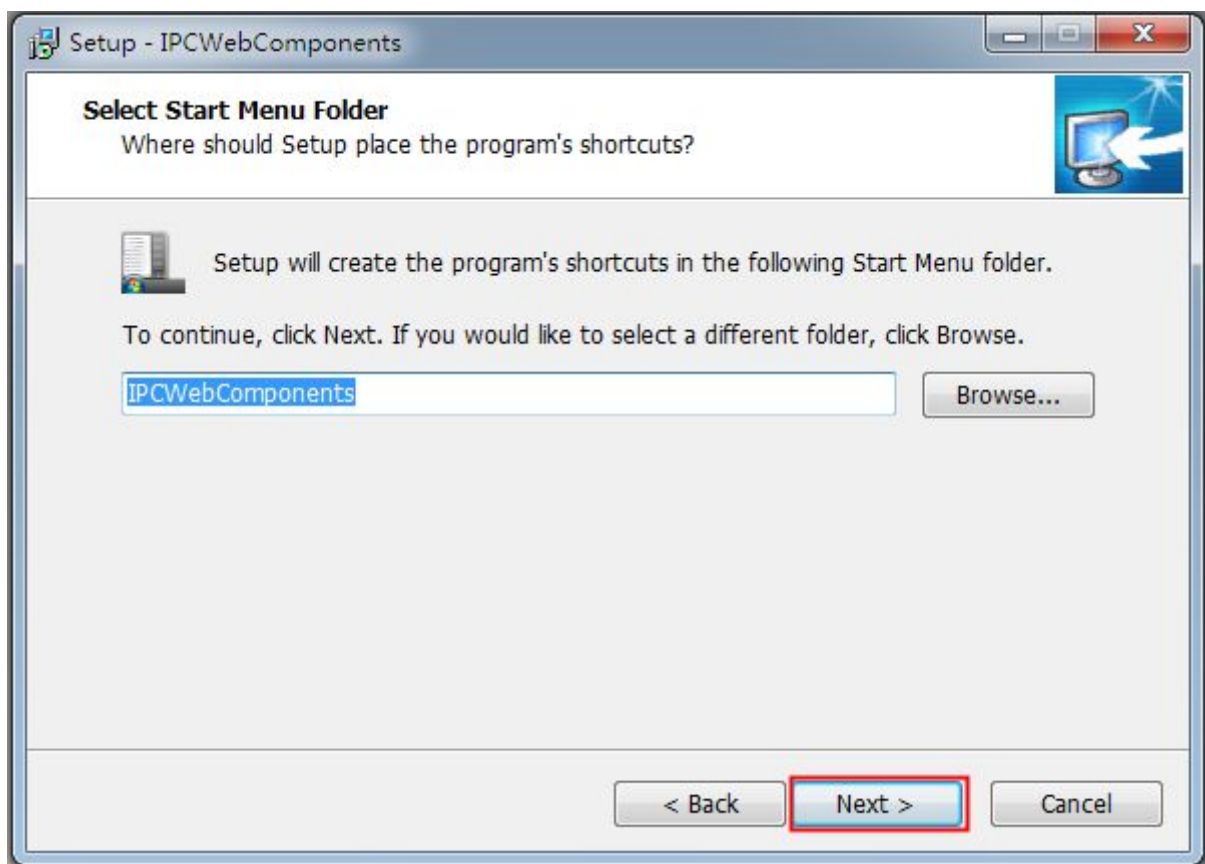

Figure 7.4

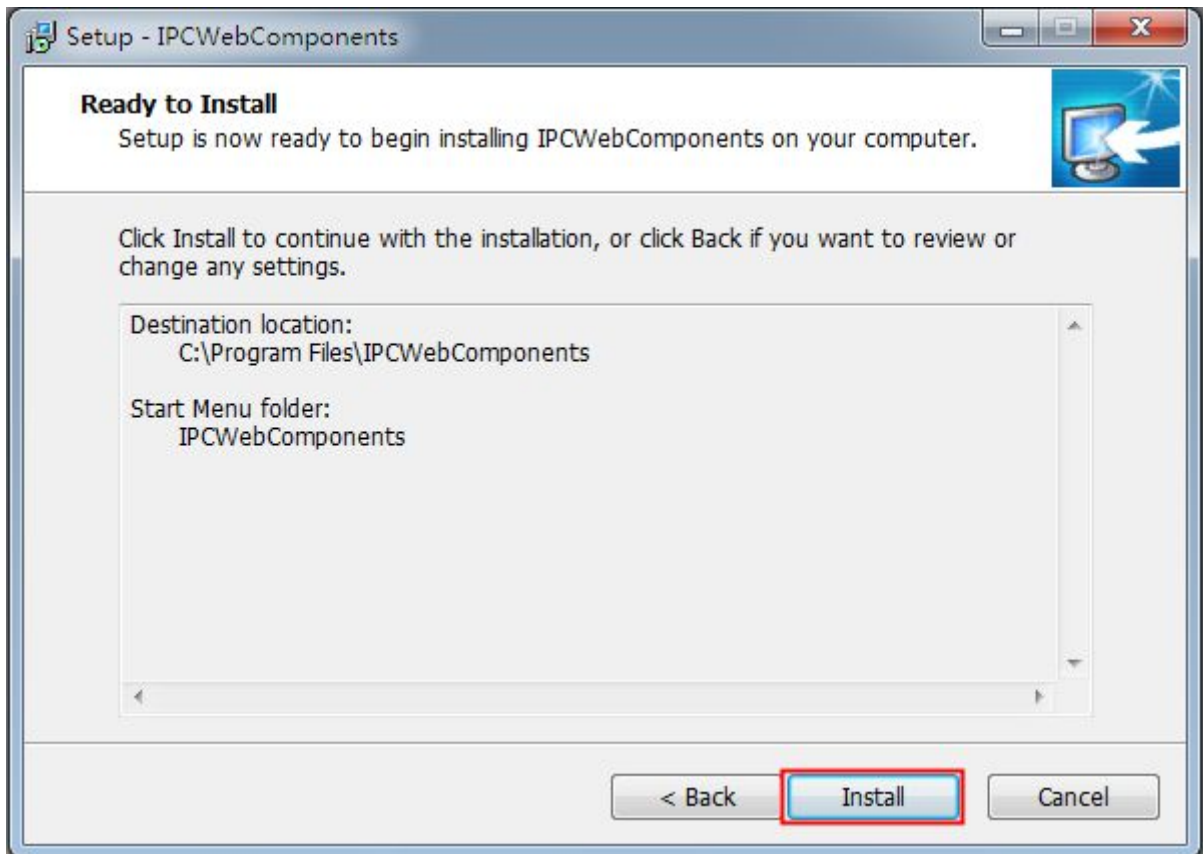

Figure 7.5

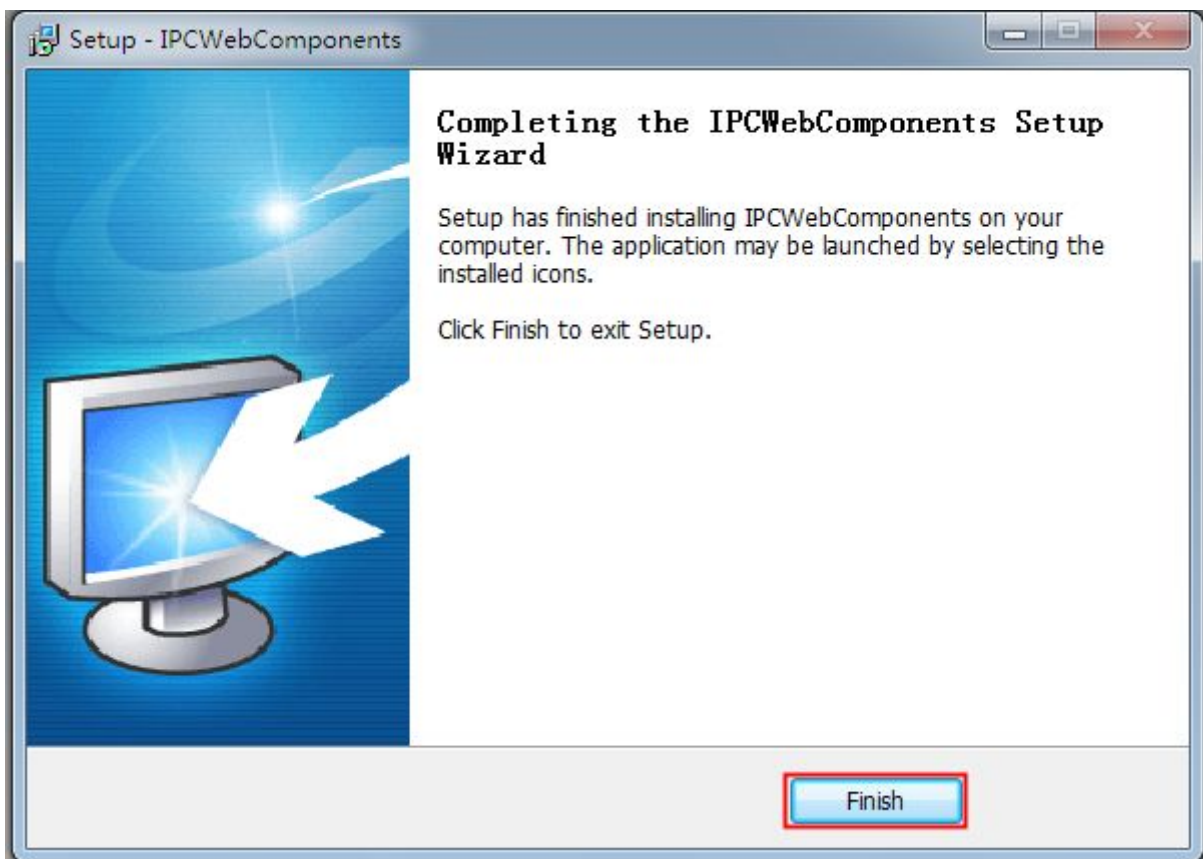

Figure 7.6

7.1.2 Uninstall the add-on of Firefox browser, Google Chrome and IE Chrome.

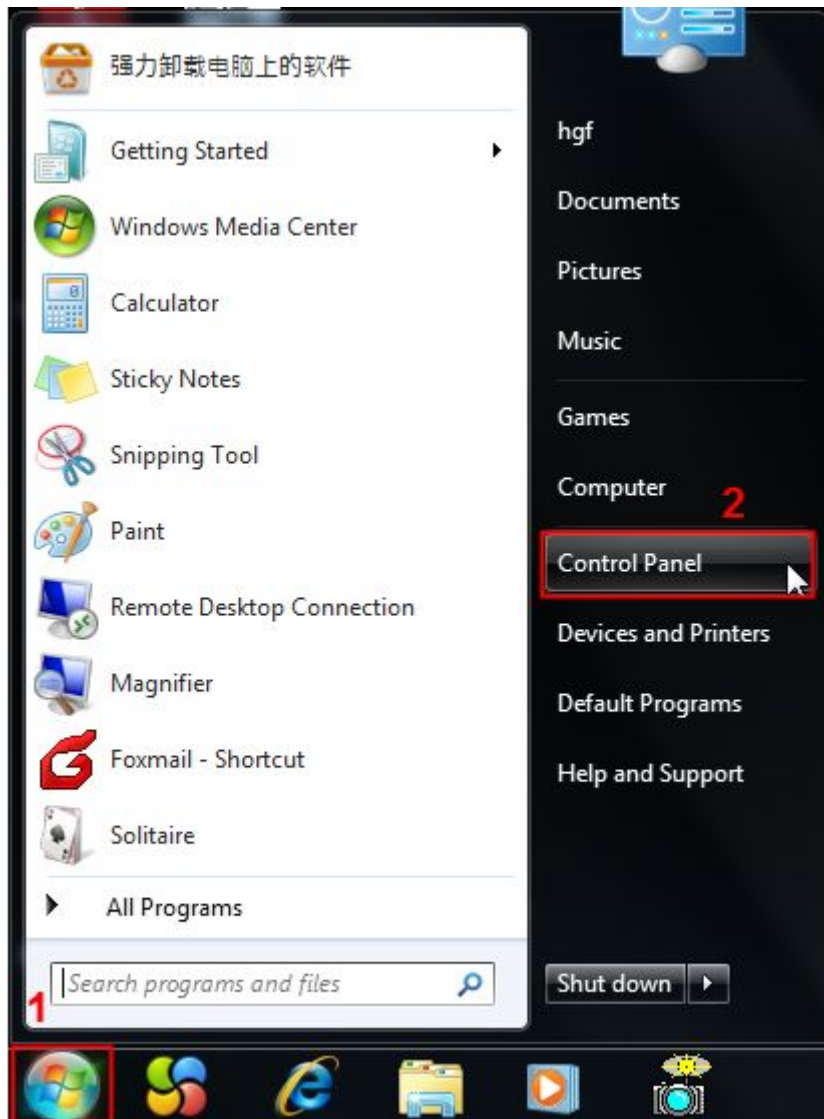

Figure 7.7

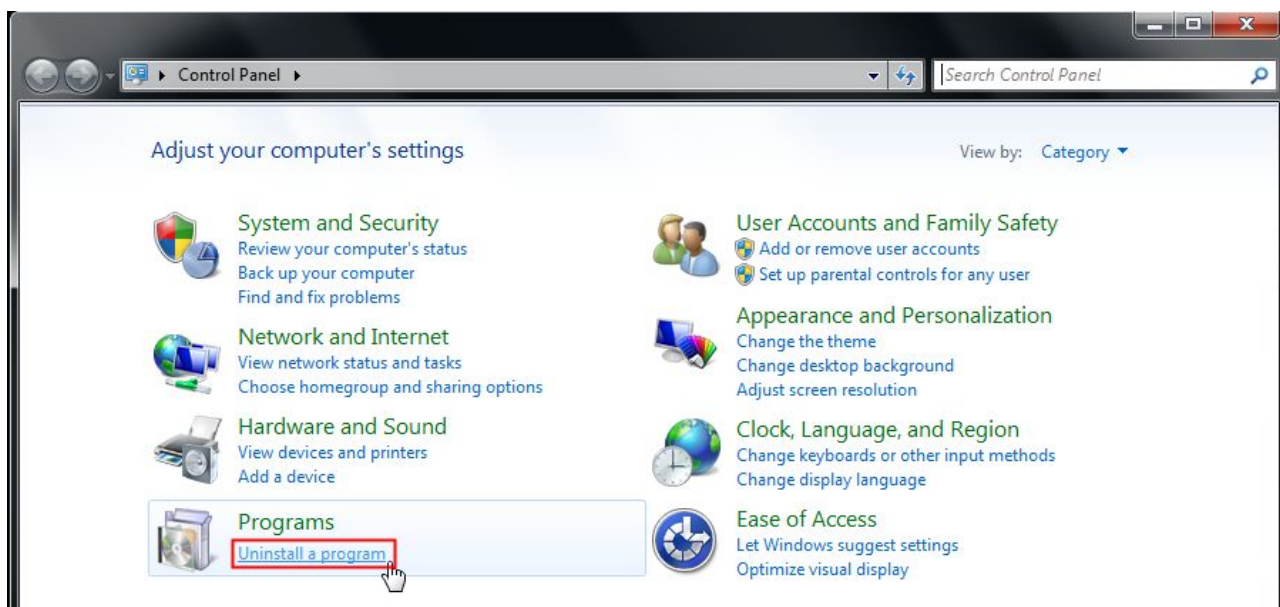

Figure 7.8

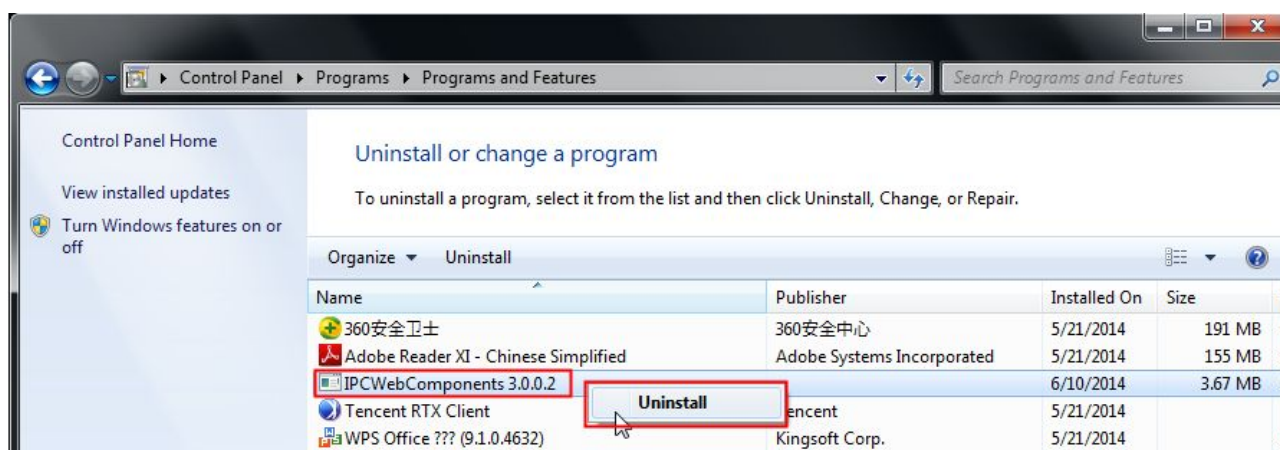

Figure 7.9

7.1.3 I have forgotten the administrator password

To reset the administrator username and password, press and hold down the RESET BUTTON for 5 seconds. Upon releasing the reset button, wait for 20 seconds, the camera will reboot and the username and password will return to the factory default administrator username and password. Please power on the camera before reset .

Default administrator username: **admin**

Default administrator password: **No password**

7.1.4 Camera can not record

Camera can not record when I click Record button or I can't change the manually record path.

When you use Windows7 or Vista, you may be not able to do manually record or change the record path because of the security settings of computer.

There are two ways to resolve this problem:

- (1) Please add the camera as a trusted site to resolve this issue. The steps are
IE browser → Tool → Internet Properties → Security → Trusted sites → Sites → Add
- (2) Open IE browser, then right click, select “Run as administrator”

7.1.5 Subnet doesn't match

Check whether your ipcamera in the same subnet of your computer. The step is Control Panel(Network Connections→Dbclick Local Area Connections → Choose General → Properties.(Figure 3.23/3.24) Check subnet mask, IP address and gateways. When you set IP address please make sure they are in the same subnet. Otherwise you can't access camera.

7.1.6 No Pictures Problems

The video streaming is transmitted by the ActiveX controller. If ActiveX controller isn't installed correctly you will see no video image. You can resolve this problem by this way:

Download ActiveX controller and set the safety property of IE in the PC when you view it first time: IE browser →Tool→Internet Proper→Security→Custom Level→ActiveX control and Plug-ins. Three options of front should be set to be “Enable”, The ActiveX programs read by the computer will be stored. As follows:

Enable: Download unsigned ActiveX controls

Enable: Initialize and script ActiveX controls not marked as safe

Enable: Run ActiveX controls and plug-ins

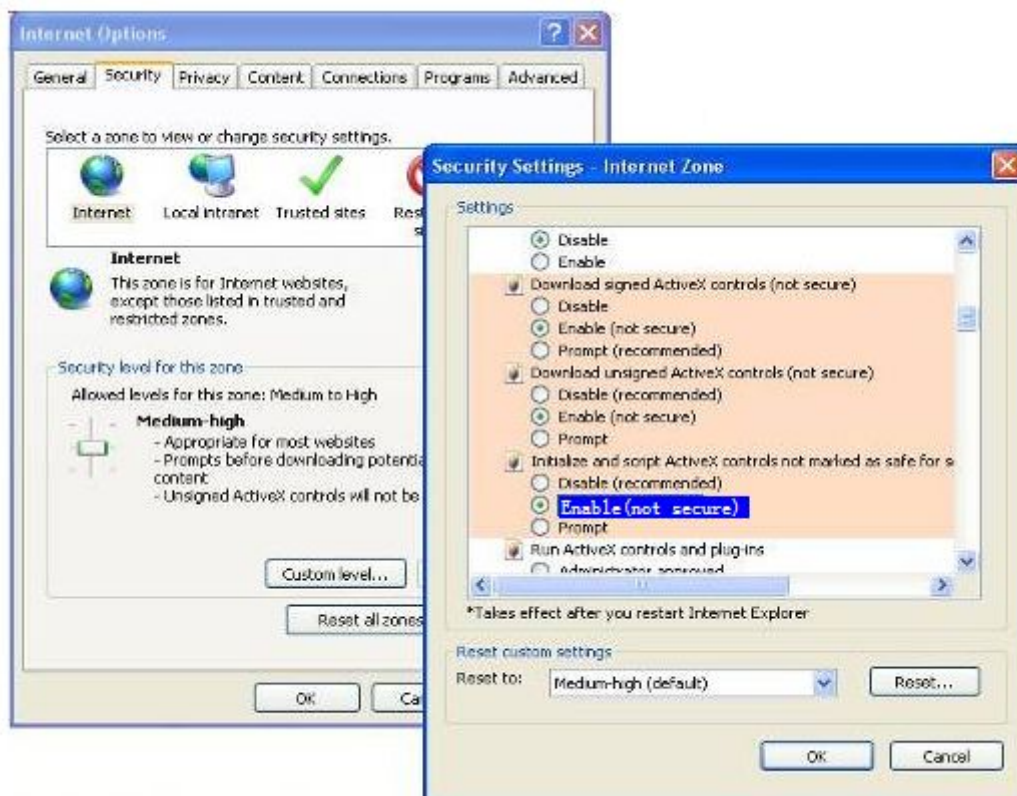

Figure 7.10

If you allow the ActiveX running, but still could not see living video. Please change another port number to try.

Don't use port 88.

| Port | |
|------------|-----|
| HTTP Port | 88 |
| HTTPS Port | 443 |
| ONVIF Port | 888 |

Figure7.11

NOTE:

Make sure that your firewall or anti-virus software does not block the camera or ActiveX. If you could not see video, please shut down firewall or anti-virus software to try again.

7.1.7 Can't access IP camera in internet

There are some reasons:

- 1、ActiveX controller is not installed correctly
- 2、The port which camera used is blocked by Firewall or Anti-virus software. Please change another port number and try again.
- 3、Port forwarding is not successful

Check these settings and make sure they are correct.

7.1.8 UPnP always failed

UPnP only contains port forwarding in our recent software. Sometimes, it may be failed to do port forwarding automatically because of firewall or anti-virus software. It also has much relation with router's security settings. So we recommend you do port forwarding manually. You can view your camera in internet successfully after you do port forwarding manually in your router.

7.1.9 Camera can not connect wireless

If your camera could not connect wireless after you set wireless settings and plug out the cable. Please check whether your settings are correct or not.

Normally, camera can't connect wireless mainly because of wrong settings.

Make sure broadcast your SSID; use the same encryption for router and camera.

7.1.10 Can't see other cameras listed

Can't see other cameras listed in multi-device when using remote access.

If you want to view all the cameras via the WAN, verify that each camera added in the multi-device settings can be accessed by using the DDNS name and port number. Use the DDNS domain name not the camera's LAN

IP. (For more details see: How to add cameras in WAN)

7.2 Default Parameters

Default network Parameters

IP address: obtain dynamically

Subnet mask: obtain dynamically

Gateway: obtain dynamically

DDNS: Embedded FOSCAM domain name

Username and password

Default username is admin with a blank password

7.3 Specifications

| ITEMS | | FI9821P |
|---------------------|--------------------|---|
| Image Sensor | Sensor | High Definition Color CMOS Sensor |
| | Display Resolution | 1280 x 720 (1Megapixel) |
| | Min. Illumination | 0 Lux (With IR Illuminator) |
| Lens | Lens Type | Glass Lens |
| | focal length | f:2.8mm |
| | Aperture | F:2.4 |
| | Angle of View | 70° |
| Video | Image Compression | H.264 |
| | Image Frame Rate | 30fps maximum, downward adjustable |
| | Resolution | 720P(1280x720), VGA(640 x 480), VGA(640 x 360), QVGA(320 x 240), QVGA(320 x 180) |
| | Stream | dual stream |
| | Image adjustment | The hue, brightness, contrast, saturation, sharpness are adjustable |
| | Flip image | flip and mirror |
| | Infrared mode | Automatic or manual |
| | Pan/Tilt Angle | Horizontal:300° & Vertical: 120° |
| | Night visibility | 11pcs IR-LEDs, night vision range up to 8 meters |
| Audio | Input/Output | Supports two-way audio Built-in Mic & Speaker 3.5mm audio jack for external Mic & Speaker |
| | Audio Compression | PCM/G.726 |
| | Ethernet | One 10/100Mbps RJ45 port |
| | Wireless Standard | IEEE802.11b/g/n |
| | Data Rate | IEEE802.11b: 11Mbps(Max.); IEEE802.11g: 54Mbps(Max.); IEEE802.11n: 150Mbps(Max.). |

| ITEMS | | FI9821P |
|----------------------------|-------------------------|---|
| Network | Wireless Security | WEP, WPA, WPA2 |
| | WPS | Supports WPS one button push wireless connection |
| | Remote Access | P2P, DDNS |
| | Network Protocol | IP, TCP, UDP, HTTP, HTTPS, SMTP, FTP, DHCP, DDNS, UPnP, RTSP, WPS |
| System Requirements | Operating System | Microsoft Windows 2000/XP, Vista, 7, 8; Mac OS iOS, Android |
| | Browser | Microsoft IE7 and above version or compatible browser; Mozilla Firefox; Google Chrome; Apple Safari. |
| Other Features | Motion Detection | Alarm via E-Mail, upload alarm snapshot to FTP |
| | Privacy Zone | Set privacy zone manually |
| | User Accounts | Three levels user role |
| | Firewall | Supports IP Filtering |
| | Storage | SD card and local storage |
| | Reset | Reset button is available |
| Power | Power Supply | DC 5V/2.0A |
| | Power Consumption | 8.0 Watts (Max.) |
| Physical | Dimension(LxWxH) | 117(L)*114(W)*129(H) mm |
| | Gross Weight | 680g |
| | Net Weight | 350g |
| Environment | Operating Temperature | -20° ~ 55°C (-4°F ~ 131°F) |
| | Operating Humidity | 20% ~ 85% non-condensing |
| | Storage Temperature | -20°C ~ 60° (-4°F ~ 140°F) |
| | Storage Humidity | 0% ~ 90% non-condensing |
| Certification | CE, FCC, RoHS | |
| Warranty | Limited 1-year warranty | |

Attention: Power adapter should be used between 0°C-40°C, and 5%-90% relative humidity.

7.4 CE & FCC

Electromagnetic Compatibility (EMC)

FCC Statement



This device complies with FCC Rules Part 15. Operation is subject to the following two conditions.

- This device may not cause harmful interference
- This device must accept any interference received, including interference that may cause undesired operation.

This equipment has been tested and found to comply with the limits for a Class B digital device, pursuant to Part 15 of the FCC Rules. These limits are designed to provide reasonable protection against harmful interference when the equipment is operated in a commercial environment. This equipment generates, uses, and can radiate radio frequency energy and, if not installed and used in accordance with the installation manual, may cause harmful interference to radio communications. Operation of this equipment in a residential area is like to cause harmful interference, in which case the user will be required to correct the interference at his own expense.

FCC Caution

Any changes or modification not expressly approved by the party responsible for compliance could void the user's authority to operate this equipment.

This equipment complies with FCC radiation exposure limits set forth for an uncontrolled environment. This equipment should be installed and operated with minimum distance 20cm between the radiator & your body.

This transmitter must not be co-located or operating in conjunction with any other antenna or transmitter.

CE Mark Warning



This is a Class B product. In a domestic environment, this product may cause radio interference, in which case the user may be required to take adequate measures.

8 Obtaining Technical Support

While we hope your experience with the IPCAM network camera is enjoyable and easy to use, you may experience some issues or have questions that this User's Guide has not answered. Please contact support via e-mail at support@foscam.us. You can also reach technical support at **1-800-930-0949** by following the automated instructions.

