

# FORD E-Transit 2022 ->

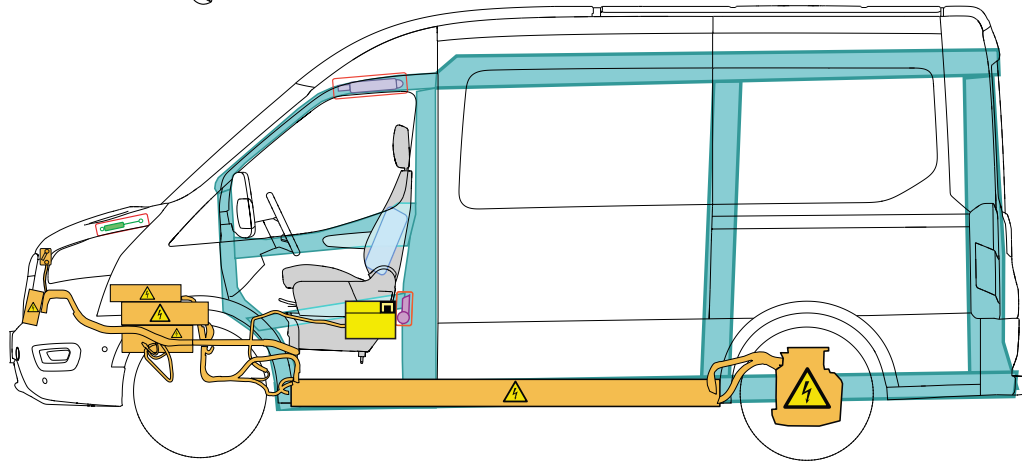

## Legend

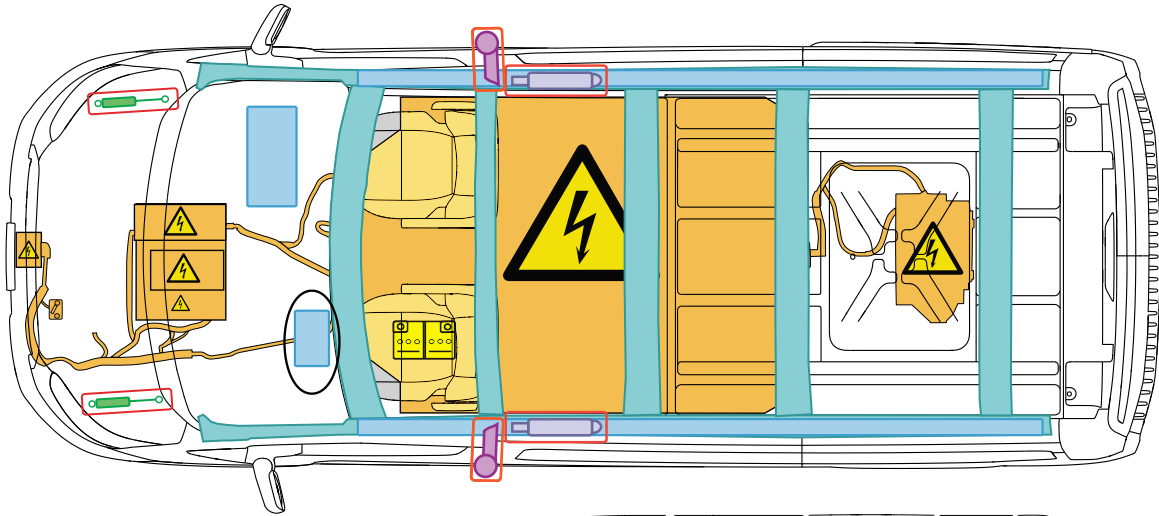
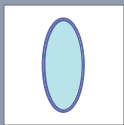

Airbag



Structural Reinforcements



Control unit

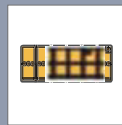

High-voltage battery



High-voltage disconnection point

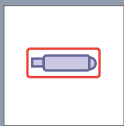

Gas generator

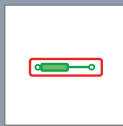

Gas filled spring device

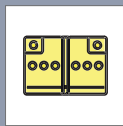

Battery

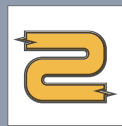

High-voltage wire / components



Fuel tank

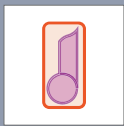

Seat belt tensioner



**1. Identification / recognition** **Page 3**

**2. Immobilization / stabilization / lifting** **Page 4**

**3. Disable direct hazards / safety regulations** **Page 6**

**4. Access to the occupants** **Page 10**

**5. Stored energy / liquids / gases / solids** **Page 11**

**6. In case of fire** **Page 12**

**7. In case of submersion** **Page 13**

**8. Towing / transportation / storage** **Page 14**

**9. Important additional information** **Page 19**

**10. Explanation of pictograms used** **Page 19**



## 1. Identification / recognition



1. Vehicle Identification Number (VIN)
2. Charging port and blue striping on front grill. E-Transit badging on left rear door.

### Vehicle Identification Number (VIN) Layout

The 8th position of the VIN identifies the vehicle's engine type as electric.

- K - BEV (battery electric vehicle), (Electric motor #1)

### Sample VIN

BEV - 1FTBW9CK2NKA00232



## 2. Immobilization / stabilization / lifting

### IMMOBILIZATION

**IMPORTANT!** Be careful to not damage the battery pack while stabilizing or lifting the vehicle.

1. Position Wheel And Tire Chocks to prevent vehicle movement.

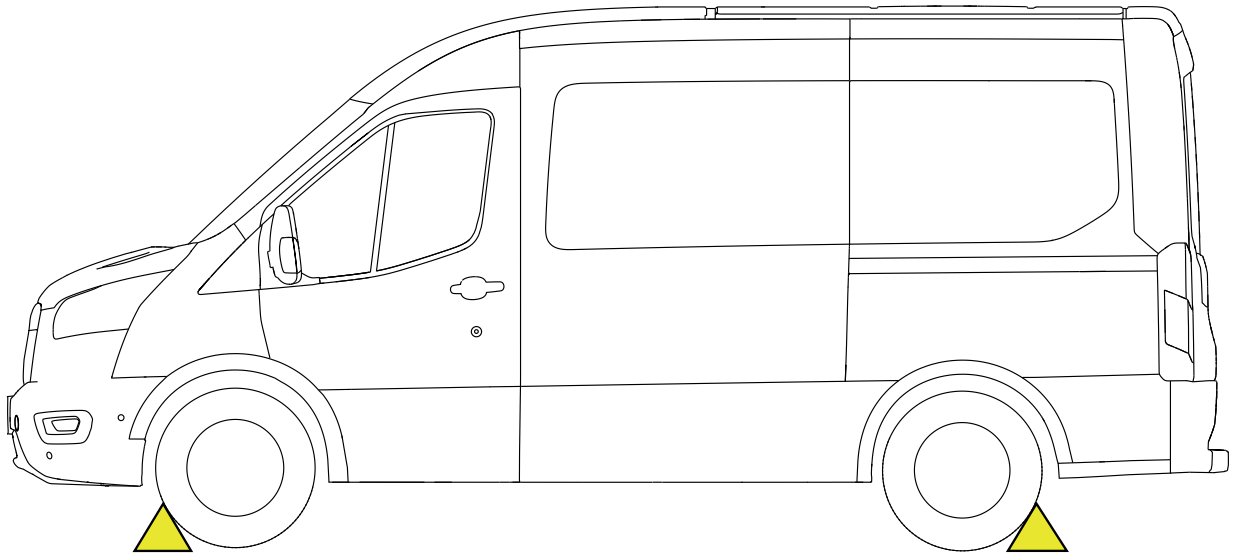

**NOTE:** The red warning lamp flashes during operation and illuminates when the parking brake is applied.

**NOTE:** You can apply the electric parking brake when the power is off.

**NOTE:** The electric parking brake could apply when you shift into park (P).

2. Put vehicle into Park position (1), ensure that the parking brake is engaged (2).



## STABILIZATION / LIFTING POINTS



### WARNING:

The vehicle should be lifted or manipulated only by personal that are properly trained and equipped. Use caution to ensure you never come into contact with the high voltage battery or other high voltage components while lifting or manipulating the vehicle.

The high voltage battery is located behind an underbody air shield under the vehicle. When lifting or stabilizing only use the designated lift areas, as shown.

## DO NOT USE THE HIGH VOLTAGE BATTERY TO LIFT OR STABILIZE

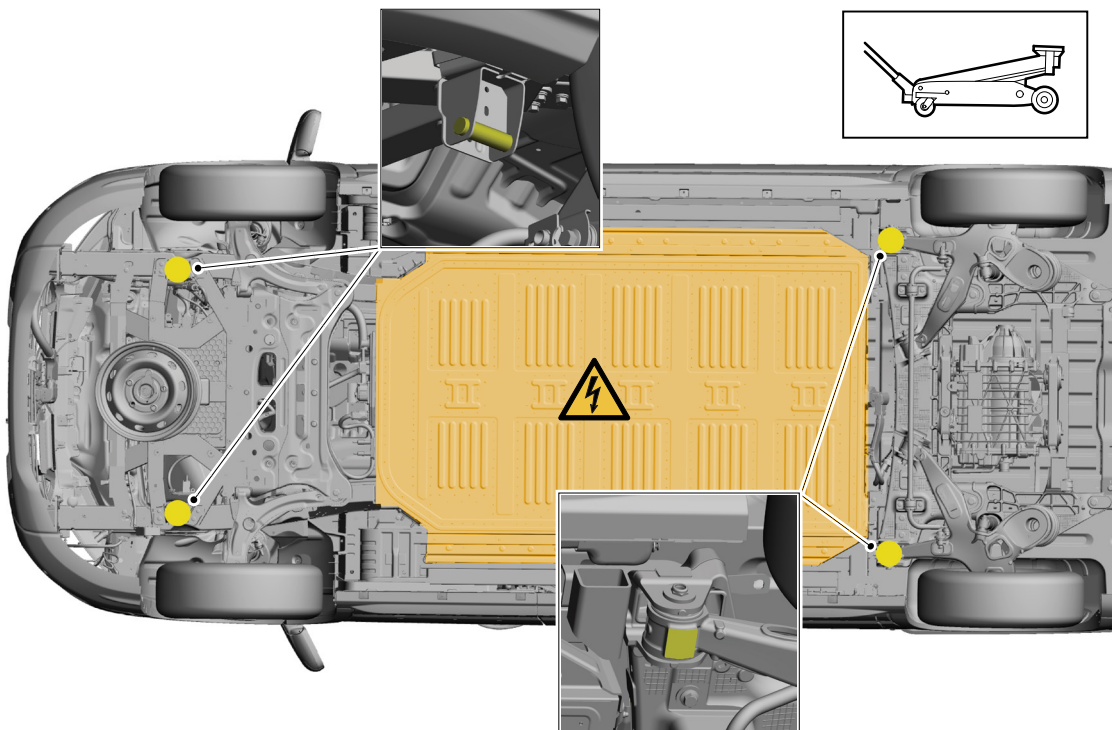

### Medium Wheelbase [MWB] - Van, Bus, Kombi

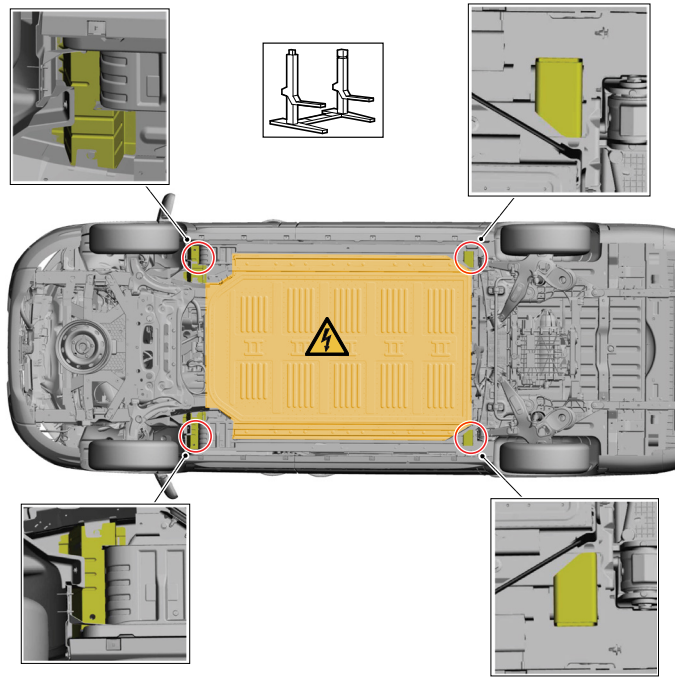

### Long Wheelbase [LWB] - Van, Bus, Kombi

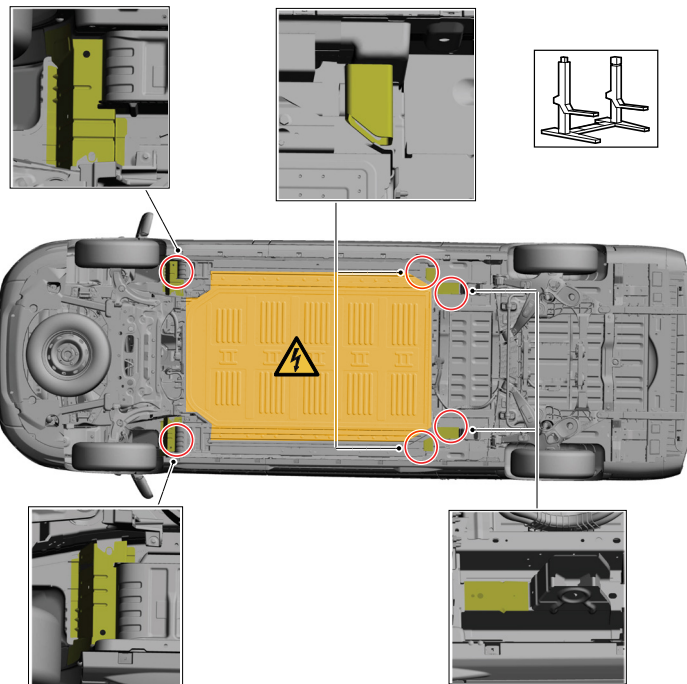



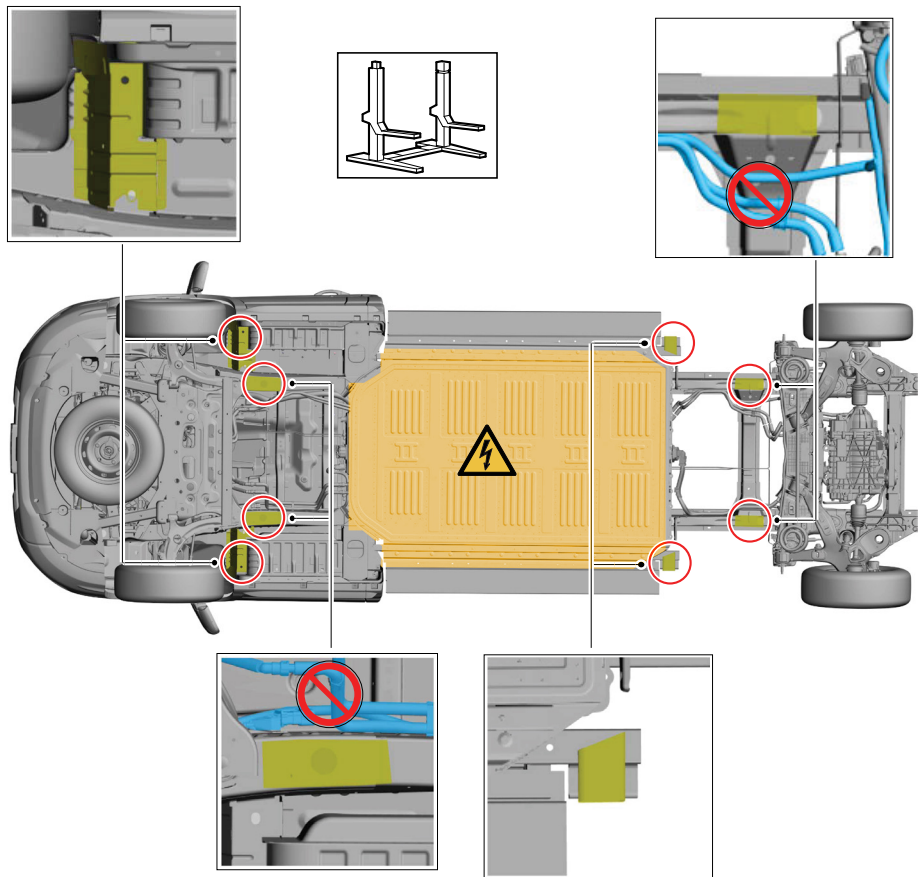





# Extra Long Wheelbase [LWB-EL] - Single Chassis Cab and Jumbo





### 3. Disable direct hazards / safety regulations

#### General Warnings for Extraction Procedures

-  **WARNING:**  
ALWAYS ASSUME THE VEHICLE'S HIGH VOLTAGE SYSTEM IS POWERED UP! Cutting, crushing, or touching High Voltage components can result in serious injury or death.
-  **WARNING:**  
Always use appropriate tools, such as a hydraulic cutter, and always wear appropriate personal protective equipment (PPE) when cutting. Failure to follow these instructions can result in serious injury or death. Pyrotechnic Device Health and Safety Precautions
-  **WARNING:**  
Pyrotechnic components are very hot immediately after deployment and might be covered with pyrotechnic residuals. Do not handle pyrotechnic components immediately after deployment. Always wear protective gloves, safety glasses and breathing protection to prevent skin contact and inhaling of pyrotechnic residuals. Failure to follow this instruction may result in serious personnel injury.
-  **WARNING:**  
Always carry a live airbag with the deployment door, trim cover or tear seam pointed away from the body. Do not place a live airbag down with the deployment door, trim cover or tear seam facing down. Failure to follow these instructions may result in serious personal injury in the event of an accidental deployment.
-  **WARNING:**  
Always carry a live Safety Canopy or side air curtain assembly with the tear seam pointed away from your body. Failure to follow this instruction may result in serious personal injury or death in the event of an accidental deployment.
-  **WARNING:**  
Never disassemble or tamper with seat belt deployable components, including pretensioners, load limiters and inflators. Never back probe deployable device electrical connectors. Tampering or back probing may cause an accidental deployment and result in personal injury or death.
-  **WARNING:**  
Never probe the electrical connectors on airbag, Safety Canopy or side air curtain assemblies. Failure to follow this instruction may result in the accidental deployment of these assemblies, which increases the risk of serious personal injury or death.
-  **WARNING:**  
Do not handle, move or change the original horizontal mounting position of the restraints control module (RCM) while the RCM is connected and the ignition switch is ON. Failure to follow this instruction may result in the accidental deployment of the Safety Canopy and cause serious personal injury or death.
-  **WARNING:**  
Service and handling of Pyrotechnic Components is restricted to qualified personnel. The required qualifications vary by region. Always observe local laws and legislative directives regarding Pyrotechnic Components service and handling. Failure to follow this instruction may result in serious personal injury or death.





**⚠ WARNING:**  
DEPOWERING THE HIGH VOLTAGE SYSTEM DOES NOT DISSIPATE VOLTAGE INSIDE THE BATTERY, THE BATTERY PACK REMAINS LIVE AND DANGEROUS. CONTACT WITH THE HIGH VOLTAGE BATTERY PACK INTERNALS MAY RESULT IN SERIOUS PERSONAL INJURY OR DEATH.

**⚠ WARNING:**  
ELECTRIC VEHICLES DAMAGED BY A CRASH MAY HAVE COMPROMISED HIGH VOLTAGE SAFETY SYSTEMS AND PRESENT A POTENTIAL HIGH VOLTAGE ELECTRICAL SHOCK HAZARD. EXERCISE CAUTION AND WEAR APPROPRIATE PERSONAL PROTECTIVE EQUIPMENT (PPE) INCLUDING HIGH VOLTAGE SAFETY GLOVES AND BOOTS. REMOVE ALL METALLIC JEWELRY, INCLUDING WATCHES AND RINGS. ISOLATE THE HIGH VOLTAGE SYSTEM AS DIRECTED BY THIS DOCUMENT. FAILURE TO FOLLOW THESE INSTRUCTIONS MAY RESULT IN SERIOUS PERSONAL INJURY OR DEATH.

### **Approaching a Damaged Vehicle**

**Disable the High Voltage electrical system using as many of the following steps as possible:**

Remove all jewelry such as watches, necklaces and earrings. Remove all metal objects that are conductors of electricity.

**PLEASE NOTE: The vehicle high voltage system could still be energized even if the ready light is not on. In accessory mode, the ready light is not present but the high voltage system is energized under normal operation.**

If necessary, apply the parking brake and/or block the wheels to prevent vehicle movement.

The vehicle has an electric parking brake. You operate it with a switch instead of a lever. The switch is on the center console or to the left hand side of the steering wheel, on the lower part of the instrument panel.

### **High Voltage System - Do Not Cut Zones**

If possible, depower the High Voltage system before attempting any removal procedure. Always assume the High Voltage cabling and components are powered up.

### **If The High Voltage Battery Case Has Been Ruptured**

Just like any other battery, hose down the area with LARGE amounts of water.



**NOTE: Perform as many of these steps as able to ensure the high voltage system is disabled.**

1. Ensure the vehicle transmission gear selector is in the PARK position. Check that the vehicle READY light is off to verify the high voltage system is disconnected. If the vehicle READY light is on, press the engine Start/Stop button to turn off the ignition.



3. Release the retainers and remove the LH front seat rear trim panel.

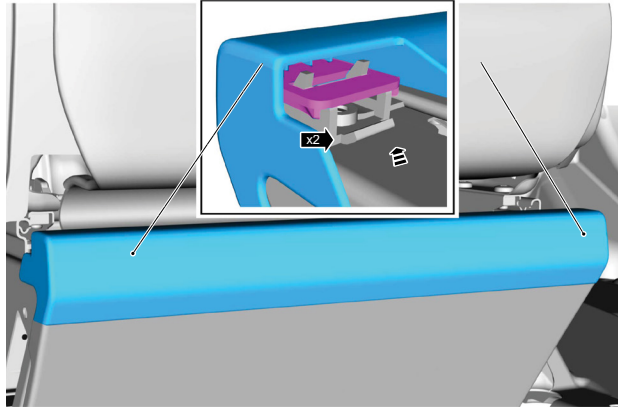

2. Raise and position the LH front seat forward.



4. Position the LH front seat backrest cover and release a retainer (1). Position the LH front seat backrest cover (2).

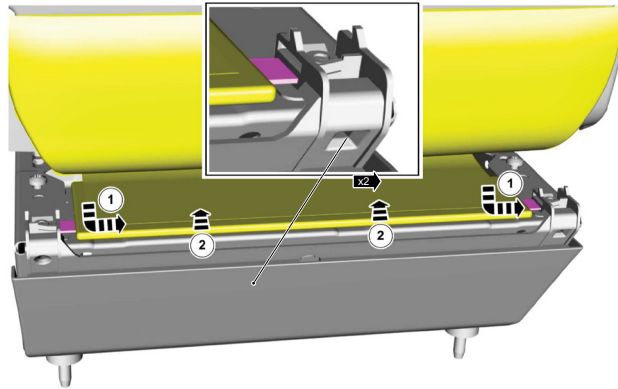

### Single Battery

5. If equipped, position the battery cover insulator (1). Remove the battery disconnect access cover (2).

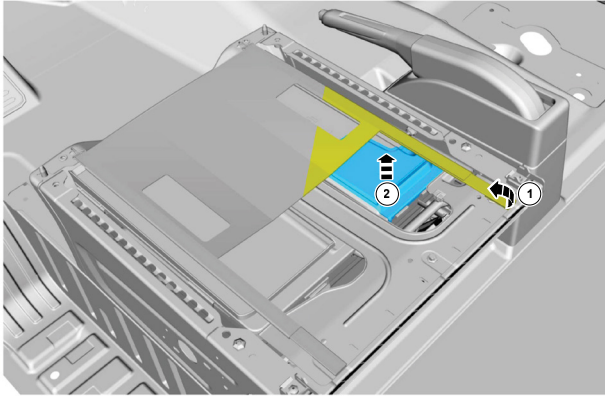

6. Remove the nut and position the battery cable. Torque 71 lb. in (8 Nm)

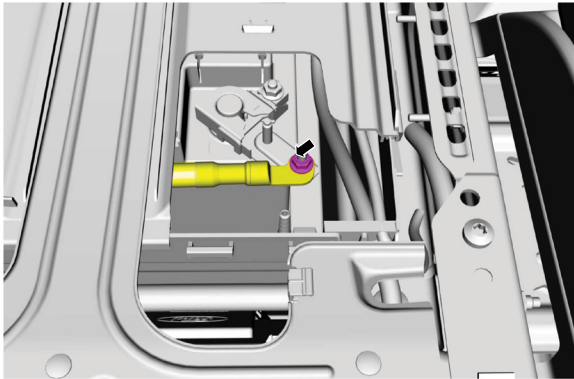

### Dual Battery

5. If equipped, position the battery cover insulator (1). Remove the battery disconnect access cover (2).

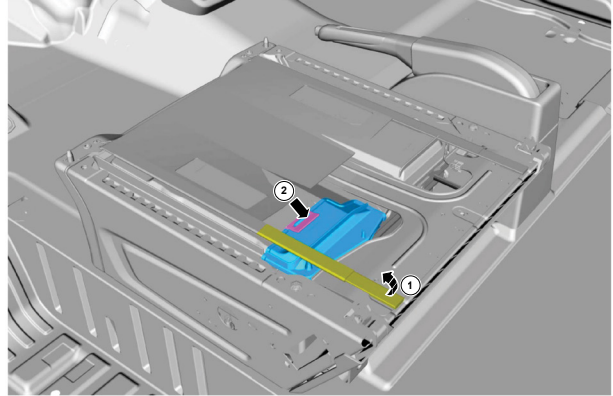

6. Remove the nut and position the battery cable. Torque 71 lb. in (8 Nm)

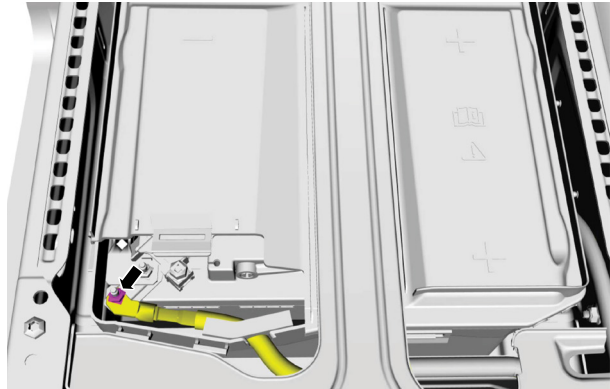

7. Detach the pin-type retainer and position the electrical connector and wiring harness aside.

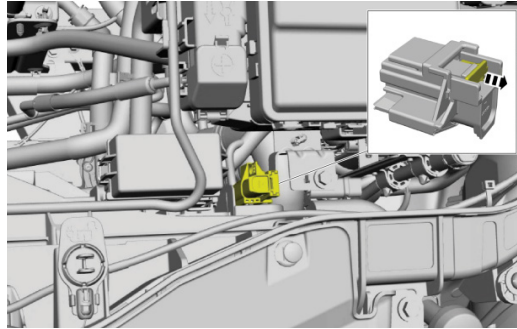

8. Release the Connector Position Assurance (CPA) clip.

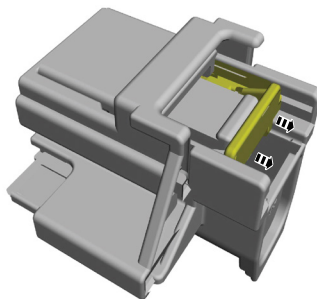

9. **NOTE:** The tab must be depressed prior to pushing the connector back in or damage to the connector may result.

Depress the tab while pulling the connector until the hole is completely visible on the top of the connector.

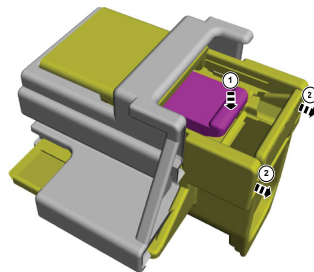

10. Insert a suitable tool inside the connector hole to prevent the connector from closing.

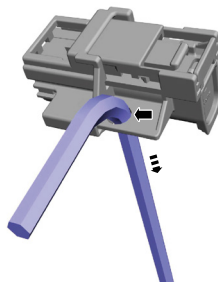









11. Wait a minimum of 5 minutes.



## 4. Access to the occupants

### General Warnings for Extraction Procedures

-  **WARNING:**  
ALWAYS ASSUME THE VEHICLE'S HIGH VOLTAGE SYSTEM IS POWERED UP! Cutting, crushing, or touching High Voltage components can result in serious injury or death.
-  **WARNING:**  
Always use appropriate tools, such as a hydraulic cutter, and always wear appropriate personal protective equipment (PPE) when cutting. Failure to follow these instructions can result in serious injury or death. Pyrotechnic Device Health and Safety Precautions
-  **WARNING:**  
Pyrotechnic components are very hot immediately after deployment and might be covered with pyrotechnic residuals. Do not handle pyrotechnic components immediately after deployment. Always wear protective gloves, safety glasses and breathing protection to prevent skin contact and inhaling of pyrotechnic residuals. Failure to follow this instruction may result in serious personnel injury.
-  **WARNING:**  
Always carry a live airbag with the deployment door, trim cover or tear seam pointed away from the body. Do not place a live airbag down with the deployment door, trim cover or tear seam facing down. Failure to follow these instructions may result in serious personal injury in the event of an accidental deployment.
-  **WARNING:**  
Always carry a live Safety Canopy or side air curtain assembly with the tear seam pointed away from your body. Failure to follow this instruction may result in serious personal injury or death in the event of an accidental deployment.
-  **WARNING:**  
Never disassemble or tamper with seat belt deployable components, including pretensioners, load limiters and inflators. Never back probe deployable device electrical connectors. Tampering or back probing may cause an accidental deployment and result in personal injury or death.
-  **WARNING:**  
Never probe the electrical connectors on airbag, Safety Canopy or side air curtain assemblies. Failure to follow this instruction may result in the accidental deployment of these assemblies, which increases the risk of serious personal injury or death.
-  **WARNING:**  
Do not handle, move or change the original horizontal mounting position of the restraints control module (RCM) while the RCM is connected and the ignition switch is ON. Failure to follow this instruction may result in the accidental deployment of the Safety Canopy and cause serious personal injury or death.
-  **WARNING:**  
Service and handling of Pyrotechnic Components is restricted to qualified personnel. The required qualifications vary by region. Always observe local laws and legislative directives regarding Pyrotechnic Components service and handling. Failure to follow this instruction may result in serious personal injury or death.



If occupant removal is necessary, always use caution when cutting near the vehicle High Voltage system components. Do not cut any of the High Voltage under vehicle or under hood cabling (all High Voltage cabling is orange). High voltage cabling runs underneath the vehicle, from the High Voltage battery under the left hand side of the vehicle to the underhood compartments. Refer to the diagram on page 1 for no cut zones.

**NOTE:** After a collision vehicle components may not function properly such as the steering wheel, power seats, and other electrical and mechanical components. If these components are not functioning properly and prevent access to occupants extraction may be required.

The illustration below shows the exterior and interior door handle positions and vehicle glass.

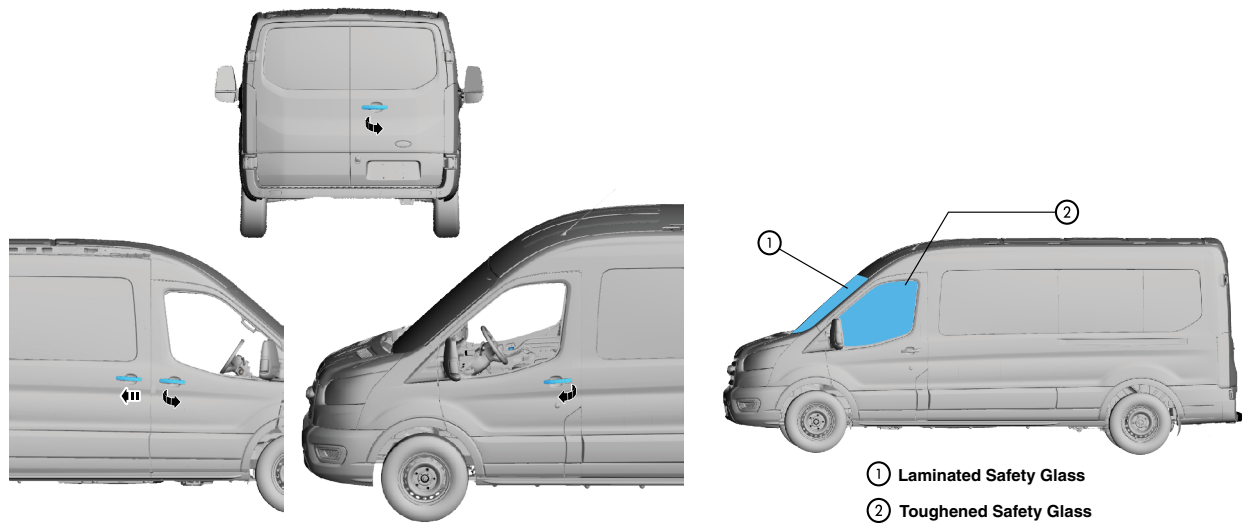

**5. Stored energy / liquids / gases / solids**

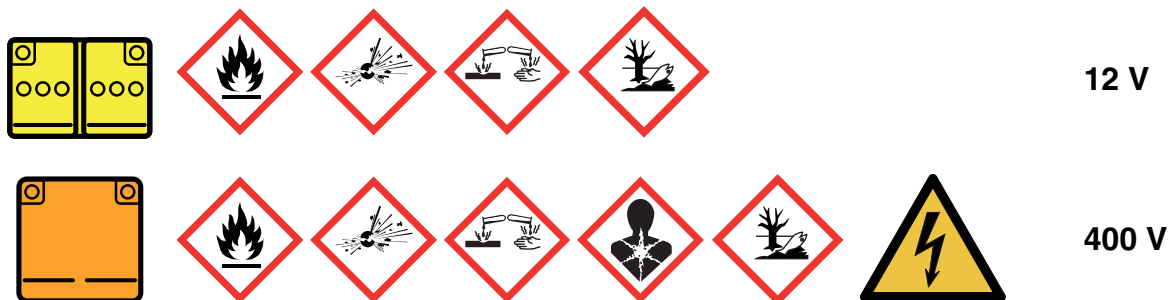

Refer to the vehicle overview illustration on Page 1, for location reference of the high voltage battery, 12V battery, and other vehicle component locations.



## 6. In case of fire



Follow Existing Training and Incident Commander Direction



### WARNING:

ELECTRIC VEHICLES WITH DAMAGED HIGH VOLTAGE BATTERIES REQUIRE SPECIAL HANDLING PRECAUTIONS. INSPECT THE VEHICLE CAREFULLY FOR LEAKING BATTERY FLUIDS, SPARKS, FLAMES, AND GURGLING OR BUBBLING SOUNDS. CONTACT EMERGENCY SERVICES IMMEDIATELY IF ANY OF THESE PROBLEMS ARE OBSERVED. FAILURE TO FOLLOW THESE INSTRUCTIONS MAY RESULT IN A VEHICLE FIRE AND PERSONAL INJURY OR DEATH.



### WARNING:

FIRES IN CRASH-DAMAGED ELECTRIC VEHICLES MAY EMIT TOXIC OR COMBUSTIBLE GASSES. SMALL AMOUNTS OF EYE, SKIN OR LUNG IRRITANTS MAY BE PRESENT. WEAR PERSONAL PROTECTIVE EQUIPMENT (PPE) AND SELF-CONTAINED BREATHING APPARATUS WHEN WORKING IN CLOSE PROXIMITY OR IN A CONFINED AREA, SUCH AS A TUNNEL OR GARAGE. VENTILATE THE VEHICLE INTERIOR BY OPENING VEHICLE WINDOWS OR DOORS. VENTILATE THE WORKING AREA. FAILURE TO FOLLOW THIS INSTRUCTION MAY RESULT IN SERIOUS PERSONAL INJURY OR DEATH.

If the vehicle is on fire, use a Class ABC powder-type extinguisher to contain and smother the flames. If water is being used, LARGE amounts of water is required to extinguish the flames. A fire-hydrant or dedicated fire hose can supply the needed amount. Water can cause some degree of arcing/shorting across the cell and/or battery terminals; it can also react with the electrolyte from the cells to generate additional combustible gas and other byproducts such as hydrofluoric acid. However, the cooling and smothering effects of flushing the affected article with large amounts of water and/or other fire suppression material is still beneficial for minimizing the severity of the event.

This guide provides only supplemental information as it pertains to these vehicles. The same rules apply when approaching any potential High Voltage situation. Always follow your High Voltage safety training. Some precautions to observe in a High Voltage situation include:

Wear the necessary PPEs such as High Voltage rubber gloves, face shield, insulated boots, protective raincoat and apron.

### Bring the following equipment:

Class ABC powder-type fire extinguisher.

A non-conductive object, about 1.5 m (5 ft) long, to safely push someone away from the vehicle if they accidentally come in contact with a damaged electric vehicle.





## 7. In case of submersion



### WARNING:

**DAMAGED ELECTRIC VEHICLES SUBMERGED IN WATER PRESENT A POTENTIAL HIGH VOLTAGE ELECTRICAL SHOCK HAZARD. EXERCISE CAUTION AND WEAR APPROPRIATE PERSONAL PROTECTIVE EQUIPMENT (PPE) INCLUDING HIGH VOLTAGE SAFETY GLOVES AND BOOTS. REMOVE ALL METALLIC JEWELRY, INCLUDING WATCHES AND RINGS. DO NOT ATTEMPT TO EXTRACT THE VEHICLE UNTIL THE HIGH VOLTAGE BATTERY HAS DISCHARGED INDICATED BY THE ABSENCE OF BUBBLING OR FIZZING. FAILURE TO FOLLOW THESE INSTRUCTIONS MAY RESULT IN SERIOUS PERSONAL INJURY OR DEATH.**

If the vehicle is submerged in water, varying degrees of arcing/shorting within the battery will take place. Do not touch any High Voltage components or orange cables while removing the occupant(s). Do not remove the vehicle until you are sure the High Voltage battery is completely discharged. A submerged High Voltage battery may produce a fizzing or bubbling reaction to the water. If fizzing or bubbling is observed, the High Voltage battery will be discharged when the fizzing or bubbling has completely stopped. The battery should still be treated as if it is not discharged.

Battery Electric and Hybrid vehicles when submerged should only be handled while wearing the appropriate Personal Protective Equipment (PPE) for water rescue and vehicle extraction.

Vehicles that have been submerged in water may have potential risk of a high voltage electrical battery fire therefore should be handled with increased caution.

Once the vehicle has been removed from the water proceed to the high voltage depower procedure, as outlined in section 3 of this document.

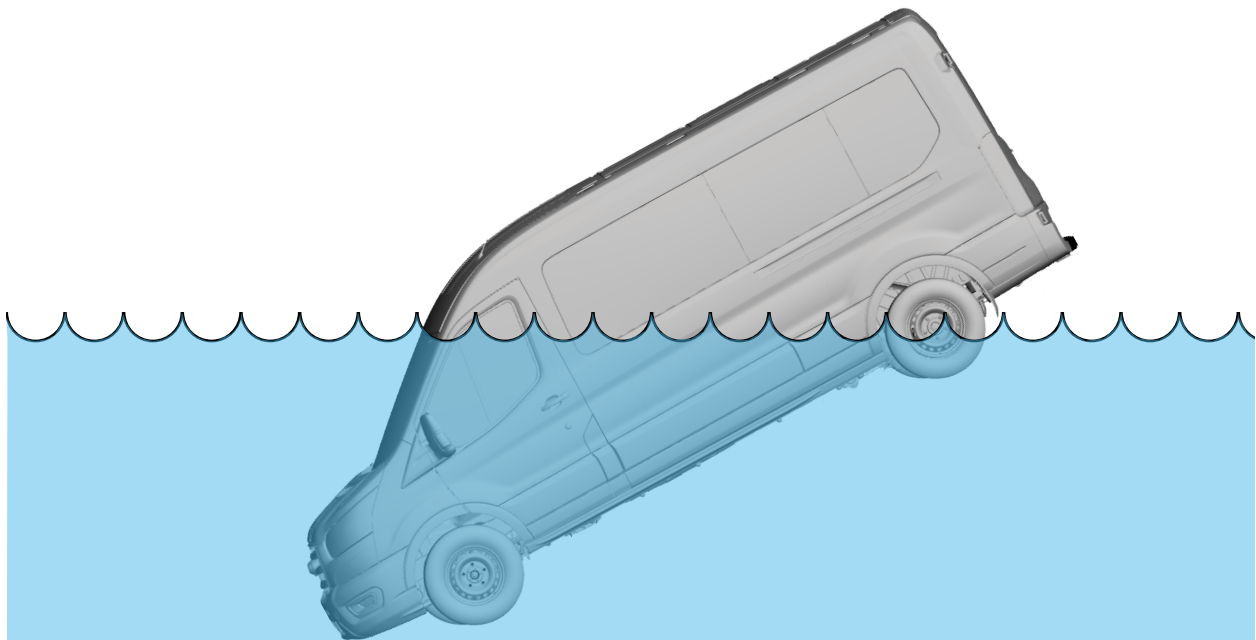

## 8. Towing / transportation / storage

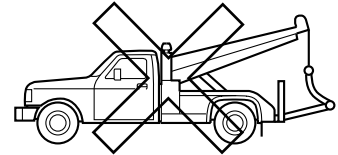
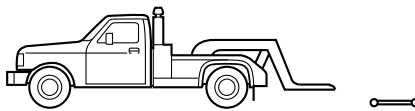
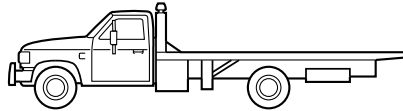
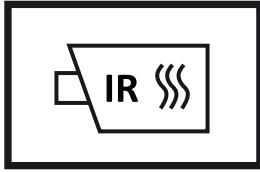

**NOTICE:** Do not attempt to pull / tow vehicle with wheels on the ground as this may cause the vehicle to generate electricity and can cause potential damage.

**NOTE:** Front-wheel and rear-wheel drive vehicles must have their designated drive wheels off the ground. Use tow dollies to prevent damage to the transmission.

**NOTE:** All-wheel or four-wheel drive vehicles require that all wheels be off the ground using a wheel lift and dollies or flatbed equipment.

### Moving Damaged Vehicles - Tow Truck Drivers

**IMPORTANT!** Be alert. There is a potential for delayed fire with damaged lithium-ion batteries.

**NOTICE:** Do not attempt to pull / tow vehicle with wheels on the ground as this may cause the vehicle to generate electricity and can cause potential damage.

Disconnect the 12 volt battery terminals to isolate the HV system. For additional information, refer to High Voltage System Depower procedures in this manual.

Rather than attempt to discharge a High Voltage battery, an emergency responder, tow truck operator, or storage facility manager should contact experts at the vehicle manufacturer.

Operators of tow trucks and vehicle storage facilities should make sure the damaged vehicle is kept in an open area instead of inside a garage or other enclosed building.

### Follow the guidelines in the Wrecker Towing Guide

If you detect leaking fluids, sparks, smoke, flames, increased temperature, gurgling, popping or hissing noises from the High Voltage battery compartment, ventilate the area and call 911.

Be alert. There is potential for delayed fire with damaged lithium-ion batteries.

Call an authorized Ford dealer or vehicle manufacturer representative, if necessary, to determine the additional steps to take to safely recover or transport the vehicle.



Always approach the vehicle from the sides to stay out of potential travel path. It may be difficult to determine if the vehicle is running due to lack of engine noise.

Place vehicle into park, set the parking brake, turn off the vehicle, activate the hazard lights, and remove the key fobs to a distance at least 16 feet from the vehicle until loading the vehicle for transport.

Refer to vehicle manual/recovery guide to locate proper attachment/connection points and transport method.

Avoid contact with orange High Voltage cabling and areas identified as High Voltage risk by warning labels.

### **Electric and Hybrid Electric Vehicle Considerations**

In the event of damage to or fire involving an electric vehicle:

Always assume the High Voltage battery and associated components are energized and fully charged. Exposed electrical components, wires, and High Voltage batteries present potential HV shock hazards. Venting/off-gassing High Voltage battery vapors are potentially toxic and flammable. Physical damage to the vehicle or High Voltage battery may result in immediate or delayed release of toxic and/or flammable gases and fire.

### **Damaged Vehicle Guidance and Storage**

#### **Damaged Vehicle Guidance for Ford Motor Company Electric and Hybrid-Electric Vehicles Equipped with High Voltage Batteries**

##### **(Towing and Recovery Operators and Vehicle Storage Facilities)**

#### **In the event of damage or fire involving an Electric Vehicle (EV) or Hybrid-Electric Vehicle (HEV):**

Always assume the High Voltage battery and associated components are energized and fully charged.

Exposed electrical components, wires and High Voltage batteries present potential High Voltage shock hazards.

Venting/off-gassing High Voltage battery vapors are potentially toxic and flammable.

Physical damage to the vehicle or High Voltage battery may result in immediate or delayed release of toxic and/or flammable gases and fire.



## **Identifying Vehicle for High Voltage System Disabling and Vehicle Shutdown**

Determine if the vehicle is an electric or hybrid-electric vehicle, and if it is, advise your dispatch and all other responders that an electric or hybrid-electric vehicle is involved.

To identify potential symptoms of a damaged High Voltage system, contact an authorized service center or vehicle manufacturer representative. Refer to the vehicle Owner Manual, Emergency Placard (included in the vehicle Owner Manual) and/or the Emergency Response Guide for appropriate contact information.

If you detect leaking fluids, sparks, smoke, flames, increased temperature, gurgling, popping or hissing noises from the High Voltage battery compartment, ventilate the passenger area (such as, roll down windows or open doors) and call 911.

## **Vehicle Recovery/Transportation**

Call an authorized service center or the vehicle manufacturer, if necessary, to determine additional steps that should be taken to safely recover or transport the vehicle.

Always approach the vehicle from the sides to stay out of potential travel path. It may be difficult to determine if the vehicle is running due to lack of engine noise.

Place vehicle into park (P), set the parking brake, turn off the vehicle, activate hazard lights, and remove the keys to a distance at least 5 m (16 ft) from the vehicle until loading the vehicle for transport.

Refer to the vehicle owner manual/recovery guide to locate proper attachment/connection points and transport method.

Avoid contact with orange High Voltage cabling and areas identified as High Voltage risk by warning labels.

## **Vehicle Storage**

Contact an authorized Ford or Lincoln Dealer as soon as possible as there may be additional steps necessary to secure, discharge, handle, and/or store the High Voltage battery and vehicle.

Do not store a severely damaged vehicle with a lithium-ion battery inside a structure or within 15 m (50 ft) of any structure or vehicle.

Make sure the passenger and cargo compartments remain ventilated.

Prior to placing vehicle in storage, and while located in storage area/tow lot, continue to inspect vehicle for leaking fluids, sparks, smoke, flames, gurgling or bubbling sounds from the High Voltage battery and call 911 if any of these are detected.

Maintain clear access to stored vehicles for monitoring and emergency response if needed.



For specific information and safety preparation regarding the High Voltage system, refer to [WWW.MOTORCRAFTSERVICE.COM](http://WWW.MOTORCRAFTSERVICE.COM), select quick guides for the appropriate vehicle emergency response guide.



**WARNING:**

**ELECTRIC VEHICLES DAMAGED BY A CRASH MAY HAVE COMPROMISED HIGH VOLTAGE SAFETY SYSTEMS AND PRESENT A POTENTIAL HIGH VOLTAGE ELECTRICAL SHOCK HAZARD. EXERCISE CAUTION AND WEAR APPROPRIATE PERSONAL PROTECTIVE EQUIPMENT (PPE) INCLUDING HIGH VOLTAGE SAFETY GLOVES AND BOOTS. REMOVE ALL METALLIC JEWELRY, INCLUDING WATCHES AND RINGS. ISOLATE THE HIGH VOLTAGE SYSTEM AS DIRECTED BY THE FORD EMERGENCY RESPONSE GUIDE FOR THE VEHICLE. FAILURE TO FOLLOW THESE INSTRUCTIONS MAY RESULT IN SERIOUS PERSONAL INJURY OR DEATH.**



**WARNING:**

**DAMAGED ELECTRIC VEHICLES SUBMERGED IN WATER PRESENT A POTENTIAL HIGH VOLTAGE ELECTRICAL SHOCK HAZARD. EXERCISE CAUTION AND WEAR APPROPRIATE PERSONAL PROTECTIVE EQUIPMENT (PPE) INCLUDING HIGH VOLTAGE SAFETY GLOVES AND BOOTS. REMOVE ALL METALLIC JEWELRY, INCLUDING WATCHES AND RINGS. DO NOT ATTEMPT TO EXTRACT THE VEHICLE UNTIL THE HIGH VOLTAGE BATTERY HAS DISCHARGED INDICATED BY THE ABSENCE OF BUBBLING OR FIZZING. FAILURE TO FOLLOW THESE INSTRUCTIONS MAY RESULT IN SERIOUS PERSONAL INJURY OR DEATH.**



**WARNING:**

**FIRES IN CRASH-DAMAGED ELECTRIC VEHICLES MAY EMIT TOXIC OR COMBUSTIBLE GASSES. SMALL AMOUNTS OF EYE, SKIN OR LUNG IRRITANTS MAY BE PRESENT. WEAR PERSONAL PROTECTIVE EQUIPMENT (PPE) AND SELF-CONTAINED BREATHING APPARATUS WHEN WORKING IN CLOSE PROXIMITY OR IN A CONFINED AREA, SUCH AS A TUNNEL OR GARAGE. VENTILATE THE VEHICLE INTERIOR BY OPENING VEHICLE WINDOWS OR DOORS. VENTILATE THE WORKING AREA. FAILURE TO FOLLOW THIS INSTRUCTION MAY RESULT IN SERIOUS PERSONAL INJURY OR DEATH.**



**WARNING:**

**ELECTRIC VEHICLES WITH DAMAGED HIGH VOLTAGE BATTERIES REQUIRE SPECIAL HANDLING PRECAUTIONS. INSPECT THE VEHICLE CAREFULLY FOR LEAKING BATTERY FLUIDS, SPARKS, FLAMES, AND GURGLING OR BUBBLING SOUNDS. CONTACT EMERGENCY SERVICES IMMEDIATELY IF ANY OF THESE PROBLEMS ARE OBSERVED. FAILURE TO FOLLOW THESE INSTRUCTIONS MAY RESULT IN A VEHICLE FIRE AND PERSONAL INJURY OR DEATH. DAMAGED BATTERY ELECTRIC VEHICLE STORAGE PLACARD**



If the vehicle and/or battery High Voltage system is damaged, place a sign indicating that it is a battery electric vehicle with potentially dangerous High Voltage. See example below:

DO NOT TOUCH!

WARNING: BATTERY ELECTRIC  
VEHICLE WITH POSSIBLE HIGH  
VOLTAGE SYSTEM DAMAGE.



WARNING: BATTERY ELECTRIC  
VEHICLE WITH POSSIBLE HIGH  
VOLTAGE SYSTEM DAMAGE.

DO NOT TOUCH!



## 9. Important additional information

For specific information and safety preparation regarding the High Voltage system, refer to: <https://www.motorcraftservice.com>, select quick guides for the appropriate vehicle emergency response guide.

© Copyright 2021, Ford Motor Company. All rights reserved. This document may be reproduced in its entirety and distributed for emergency responder use only. It may not be excerpted for any purpose.

## 10. Explanation of pictograms used



Flammable



Explosive



Corrosives



Hazardous  
to the  
human health



Environmental  
hazard



Use water  
to extinguish  
the fire



Use ABC  
powder to  
extinguish  
the fire



General  
warning



Warning,  
Electricity



Use infrared thermometer /  
Thermal Infrared camera

