

Service Manual

THE FISHER

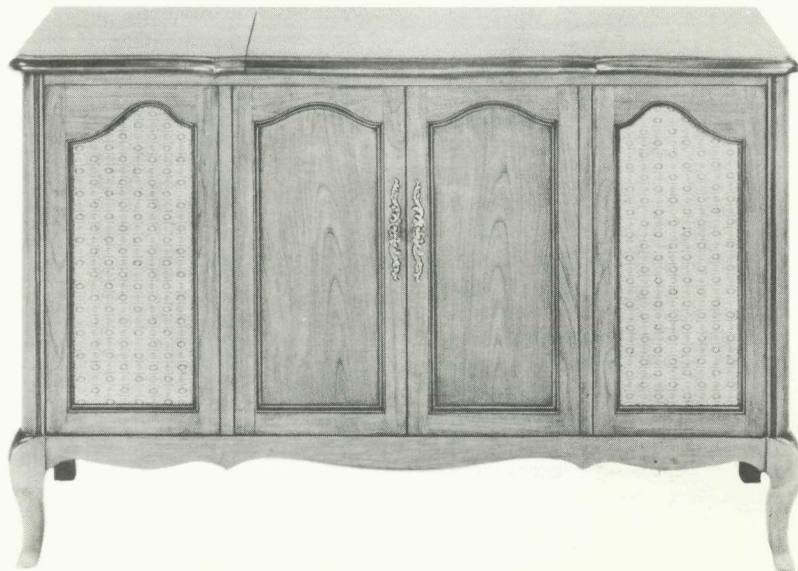

Philharmonic V

MODEL P-290

CHASSIS SERIAL NUMBERS
FROM 30001 to 39999 INCLUSIVE

\$1.00

PARTS DESCRIPTION LIST

MAIN CHASSIS

Symbol	Description	Part No.
C5	Capacitor, AM FM Variable	C953-115
C17	Capacitor, Ceramic Trimmer	C662-123
C19, 20	Capacitor, Electrolytic, 50uf, 3V	C50283-1
C28	Capacitor, Ceramic Trimmer	C662-123
C39	Capacitor, Ceramic, 5pF, $\pm .5$ pF, N150, 500V	CC20PJ050D5
C42	Capacitor, Ceramic, 10pF, $\pm .5$ pF, NPO, 500V	CC20CJ100D5
C62	Capacitor, Electrolytic, 4-Section: A — 20 uf, 350V B — 20uf, 350V C — 40uf, 350V D — 40uf, 350V	C50180-45
C67	Capacitor, Electrolytic, 10uF, 350V	C644-146
C75	Capacitor, Electrolytic, 100uf, 250V	C836-122
C77	Capacitor, Electrolytic, 8uf, 50V	C629-138
C78	Capacitor, Molded, .01uf, 20%, 600V	C2747
C79	Capacitor, Electrolytic, 8uf, 50V	C629-138
C80	Capacitor, Molded, .01uf, 20%, 600V	C2747
C81	Capacitor, Electrolytic, 100uf, 250V	C836-122
CR1	Diode, Silicon, Type 1112	V1112
CR4, 5	Rectifier, Silicon Power	SR50472
F1	Fusé, 2 Amp., Slo-Blo	F643-154
I1, 2, 3, 4	Lamp, #47	I50009-1
L1	Antenna, AM Loop	L50210-36
L2	Coil, FM Antenna	L818-113
L3	Choke, RF, 1.5 Microhenry	L50066-4
L4	Transformer, AM RF	L50210-35
L5	Choke, RF	L629-180
L6	Coil, FM RF	L953-119
L7	Choke, RF, .68 Microhenry	L50066-1
L8	Coil Assembly, FM Oscillator	A5953-116
L9	Coil, AM Oscillator	L50210-28
L10	Choke, RF, .2 Microhenry	L50066-21
L11	Choke, RF, 3.3 Microhenry	L50066-8
PC1, 2	Printed Circuit, Tone Control	PC50187-9
R41, 42	Potentiometer, 500K Dual Volume	R50160-160
R46	Potentiometer, 500K Balance	R50160-161
R48, 50	Potentiometer, 500K Dual Treble	R50160-159
R54, 55	Potentiometer, 500K Dual Bass	R50160-159
R80	Resistor, Glass, 3.3K, 10%, 7W,	RPG7W332K
R84	Resistor, Glass, 560, 10%, 3W	RPG3W561K
R85	Resistor, Composition, 330, 10%, 1W	RC30BF331K
R87	Potentiometer, Wirewound, 500, Hum Adj.	R50353-1
R94, 95	Resistor, Variable, 500K	R50150-6
S1	Switch, Selector	S1193-114
S2	Switch, Power	part of R41, 42
T1, 2	Transformer, Output	T992-116-1
T3	Transformer, Power	T1023-115
Z1	Transformer, FM IF	ZZ662-117
Z2	Transformer, AM IF	ZZ2984
Z3	Transformer, FM IF	ZZ2987
Z4	Transformer, AM IF	ZZ2984
Z5	Coil, FM Limiter	ZZ50210-6
Z6	Transformer, FM, Ratio Detector	ZZ50210-9
I1, 2, 3	Lamp, Dial, Type 1847 (Clear)	I5009-7
I4	Lamp, Pilot, Type 1845 (Red)	I5009-9
I5	StereoScan Indicator Assembly	I50621-1

—	Dial Glass	N1023-107
—	Dipole Assembly	AS50227-3
—	Brass Escutcheon	A537-118
—	45 RPM Spindle	A50412-6
—	Knob	E50324
—	Jewel, Green	I50162-4
—	Phono Cartridge	G50429
—	Automatic Turntable, Garrard Model AT-6	RC956-105

MULTIPLEX SECTION CAPACITORS

10% tolerance for all fixed capacitors, unless otherwise noted or marked GMV (guaranteed minimum value). All capacitors not marked uF are pF (uuf).

Symbol	Description	Part No.
C1	Mylar, .027 uF, 5%, 100V	C50B574-6
C2	Polystyrene, 180, 5%, 500V	C50B634-1
C3	Polystyrene, 4700, 5%, 125V	C50B634-21
C4	Polystyrene, 220, 5%, 500V	C50B634-2
C5	Polystyrene, 4700, 5%, 125V	C50B634-21
C6	Ceramic, .02 uF, +80, -20%, 500V	C50089-4
C7	Ceramic, 2200, 20%, 1000V	C50183-10
C8	Ceramic, 100, 20%, 1000V	C50183-9
C9	Ceramic, 1200, 10%, 1000V	C50183-8
C10	Ceramic, 68, 10% NPO, 1000V	C50070-46
C11	Mica, 4700, 5%, 300V	C50332-7
C12	Ceramic, 5000, 20%, 500 V	C50089-1

NOTE: For all other capacitors in multiplex section, see layout of printed circuit board.

RESISTORS

Symbol	Description	Part No.
R1	Dep. Carbon, 2.2M, 5%, 1/3W	R33DC225J
R2	Dep. Carbon, 10K, 5%, 1/3W	R33DC103J
R3	Dep. Carbon, 1K, 5%, 1/3W	R33DC102J
R4	Potentiometer, 5K Separation Control	R50150-11
R5	Dep. Carbon, 3.9K, 5%, 1/3W	R33DC392J
R6	Composition, 10M, 10%, 1/2W	RC20BF106K
R7	Dep. Carbon, 220K, 5%, 1/3W	R33DC224J
R8	Dep. Carbon, 100K	R12DC104J
R9	Dep. Carbon, 1.5M, 5%, 1/3W	R33DC155J
R10	Dep. Carbon, 47K, 5%, 1/3W	R33DC473J
R11	Dep. Carbon, 68K	R12DC683J
R12	Dep. Carbon, 150, 5%, 1/3W	R33DC151J
R13,14,15	Composition, 33K, 10%, 1W	RC30BF333K

NOTE: For all other resistors in multiplex section, see layout of printed circuit board.

MISCELLANEOUS

Symbol	Description	Part No.
CR1	Diode, Type 1112	V1112
L1	Coil, 20 uH	L503342
Z1	Transformer, 19 kc	ZZ50210-34
Z2	Transformer, 38 kc	ZZ50210-54

ALIGNMENT INSTRUCTIONS • MULTIPLEX SECTION

GENERAL

The preferred alignment procedure, described in Table 1 below, makes use of a multiplex generator with an RF output. For optimum performance, it is desirable to align the multiplex unit while it is connected to the tuner with which it will be used. Before aligning the multiplex section, it is wise to check the alignment of the IF stages, since poor IF alignment can make proper multiplex operation impossible.

The procedure in Table 1 is based upon the use of a FISHER Model 300 multiplex generator. An alternate procedure, for use with MPX generators having no RF output, is given in Table 2.

TEST EQUIPMENT REQUIRED: MULTIPLEX GENERATOR, AC VACUUM TUBE VOLTMETER (RMS PREFERRED), 100 KC OSCILLOSCOPE WITH EXTERNAL SWEEP FACILITIES.

NOTE: USE HEX ALIGNMENT TOOL ONLY FOR ADJUSTING COIL SLUGS

TABLE 1

STEPS	GENERATOR		R F DEVIATION	INDICATOR TYPE AND CONNECTION	ALIGNMENT	
	CONNECTION	MODULATION			ADJUST	INDICATION
1	Multiplex generator RF output to antenna terminals	19 kc pilot only	± 7.5 kc	VTVM to TP 1	Z1 top and bottom	Maximum reading on VTVM
2	19 kc output of generator to oscilloscope horizontal input; generator not connected to MPX section	————	————	Vertical input of oscilloscope for external sweep	Z2	Set frequency of free-running oscillator as close as possible to 38 kc. Lissajous pattern (see figure 1, on schematic) should be as slow-moving as possible.
3	Same as Step 1	Composite MPX; 1000 cps on left channel only	± 75 kc	VTVM and oscilloscope vertical input to right channel output lug (terminal 1R)	Z1 top	Maximum reading on VTVM; clean 1000 cps sine wave on oscilloscope
4	Same as Step 1	Composite MPX; 1000 cps on right channel only	± 75 kc	Same as Step 3	MPX separation control (R4)	Minimum reading on VTVM should be at least 33 db below reading obtained in Step 3
5	Same as Step 1	Same as Step 4	± 75 kc	VTVM and oscilloscope vertical input to right channel output lug (terminal 1S)	————	Same VTVM reading as obtained in Step 3 ± 2 db; clean 1000 cps sine wave on oscilloscope
6	Same as Step 1	Composite MPX; 1000 cps on left channel only	± 75 kc	Same as Step 5	MPX separation control (R4), if necessary*	Minimum reading on VTVM should be at least 33 db below reading obtained in Step 5.

* If adjustment is required, adjust for best compromise readings in Steps 4 and 6.

ALTERNATE ALIGNMENT PROCEDURE For multiplex generators without an RF output

In this procedure, it is necessary to disconnect the ratio detector from the multiplex unit before proceeding. Place a 12K resistor in series with the generator and MPX input, and place a 180 pF capacitor from the hot side of the input to ground. This forms a low-pass filter which simulates the effect of the tuner on the multiplex signal.

NOTE: USE HEX ALIGNMENT TOOL ONLY FOR ADJUSTING COIL SLUGS

TABLE 2

STEPS	GENERATOR			INDICATOR TYPE AND CONNECTION	ALIGNMENT	
	CONNECTION	AUDIO	LEVEL		ADJUST	INDICATION
1	Composite output of MPX generator to input of MPX demodulator (Point 1)	19 kc pilot only	100 mV RMS (280 MV P-P)	AC VTVM to TP 1	Z1 top and bottom	Maximum reading on VTVM
2	19 kc output of generator to oscilloscope horizontal input; generator not connected to MPX section	————	————	Oscilloscope vertical input to TP 2	Z2	Set frequency of free-running oscillator as close as possible to 38 kc. Lissajous pattern (see figure 1, on schematic) should be as slow-moving as possible.
3	Same as Step 1	1000 cps on left channel only	0.7 V RMS (3.92 V P-P)	AC VTVM and oscilloscope vertical input to left channel output lug (terminal 1R)	Z1 top	Maximum reading on VTVM; clean 1000 cps sine wave on oscilloscope
4	Same as Step 1	1000 cps on right channel only	0.7 V RMS (3.92 V P-P)	Same as Step 3	MPX separation control (R4)	Minimum reading on VTVM should be at least 33 db below reading obtained in Step 3
5	Same as Step 1	Same as Step 4	0.7 V RMS (3.92 V P-P)	VTVM and oscilloscope vertical input to right channel output lug (terminal 1S)	————	Same VTVM reading as obtained in Step 3 ± 2 db; clean 1000 cps sine wave on oscilloscope
6	Same as Step 1	1000 cps on left channel only	0.7 V RMS (3.92 V P-P)	Same as Step 5	MPX separation control (R4), if necessary*	Minimum reading on VTVM should be at least 33 db below reading obtained in Step 5.

* If adjustment is required, adjust for best compromise readings in Steps 4 and 6.

ALIGNMENT INSTRUCTIONS

Read These Instructions With Extreme Care Before Attempting Alignment.

CHASSIS: Turn the station selector completely counterclockwise, without forcing. Dial pointer should be at zero index mark on logging scale. If not, reset the dial pointer. Disconnect the external antennas and the antenna link. Set Ferrite Loop to normal position, parallel to rear panel. When using an oscilloscope for alignment, set the output level controls for no overload, as shown by the proper waveform shape. Connect loads to main output and turn volume control to minimum.

SIGNAL GENERATORS: The signal generator equipment must be able to supply the following: FM RF modulated 30% (± 22.5 KC deviation) at 400 cps; AM RF modulated 30% at 400 cps;

AM IF with 30KC sweep for AM bandwidth adjustment.

INDICATOR: DC VTVM, AC VTVM, and scope for alignment.

ALIGNMENT: Allow the chassis and test instruments to warm up for at least fifteen minutes. Adjust the line voltage for 117 volts AC, 50-60 cycles. Use fully insulated tools: a small screwdriver for all trimming capacitors; a K-Tran tool for Z1, Z2, Z3, Z4; a hex tool for L1, L2, L5, L6, L10, Z6 and Z5. For AM alignment, short AVC lead to ground.

NOTE: For calibrating both the AM and FM, use as low an output voltage as possible from your signal generator.

AM ALIGNMENT

STEPS	CHASSIS			SIGNAL GENERATOR			INDICATOR		ALIGNMENT	
	AM BANDWIDTH	SELECTOR	STATION SELECTOR	COUPLING	FREQ.	MOD.	TYPE	CONNECTION	ADJUST	INDICATION
1	SHARP	AM	Point of no signal and no interference	AM Gen. connected to ungrounded tube shield over V3	455 KC	30% AM at 400 cps	AC VTVM	to Ch. B Rec. Output	Z2, Z4, top and bottom	Maximum voltage
2	BROAD	AM	Point of no signal and no interference	AM Gen. connected to ungrounded tube shield over V3	455 KC	30 KC sweep	Scope	to Ch. B Rec. Output	Z4 Bottom	Adjust slightly for symmetrical curve
3	SHARP	AM	600 KC	AM Gen. connected thru 220-uuf to the AM antenna terminal. Disconnect link between terminals.	600 KC	30% AM at 400 cps	AC VTVM	to Ch. B Rec. Output	L10, L5, L1	Maximum voltage
4	SHARP	AM	1400 KC	AM Gen. connected thru 220-uuf to the AM antenna terminal. Disconnect link between terminals.	1400 KC	30% AM at 400 cps	AC VTVM	to Ch. B Rec. Output	C7H, C7E, C7D	Maximum voltage
5	Repeat steps 3 and 4 for proper dial calibration and maximum output.									
6		FM	Point of no signal and no interference	FM Gen. connected to ungrounded tube shield of V1	10.7 MC	None	DC VTVM	to test point 3	Z1, Z3, Z5 and Z6, top	Maximum negative voltage
7		FM	Point of no signal and no interference	FM Gen. connected to ungrounded tube shield of V1	10.7 MC	None	Connect hot lead of DC VTVM to MPX output, ground to junction of resistors (47K) connected in series from TSP3 to GND.		Z6, top	Zero reading on zero center scale
8		FM	90 MC	FM Gen. connected thru two 120-ohm carbon resistors in series with lead to antenna terminals DISTANCE.	90 MC	30% FM (22.5 KC Dev.) at 400 cps	DC VTVM	to TSP3 and scope to Ch. A. Rec. output	L9, L6 and L2	Check for sine waveform and adjust for maximum negative voltage
9		FM	106 MC	FM Gen. connected thru two 120-ohm carbon resistors in series with lead to antenna terminals DISTANCE.	106 MC	30% FM (22.5 KC Dev.) at 400 cps	DC VTVM	to TSP3 and scope to Ch. A. Rec. output	C25, C20	Check for sine waveform and adjust for maximum negative voltage.
10	Repeat steps 8 and 9 for proper dial calibration and maximum output.									

NOTE: For final calibration, use lowest possible generator voltage.

FM ALIGNMENT

SCHEMATIC DIAGRAM

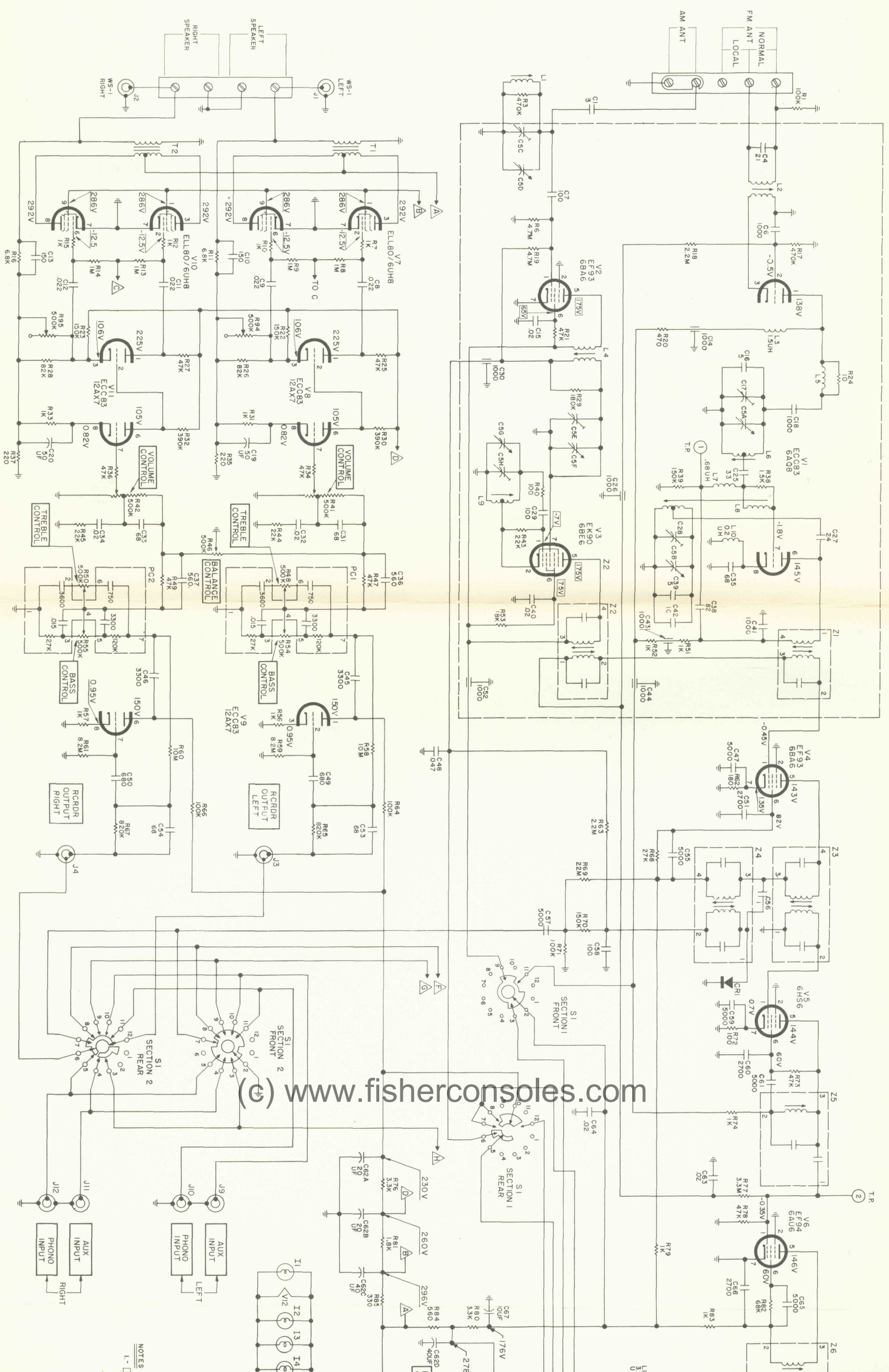

(C) www.fisherconsoles.com

NOTES
1 -

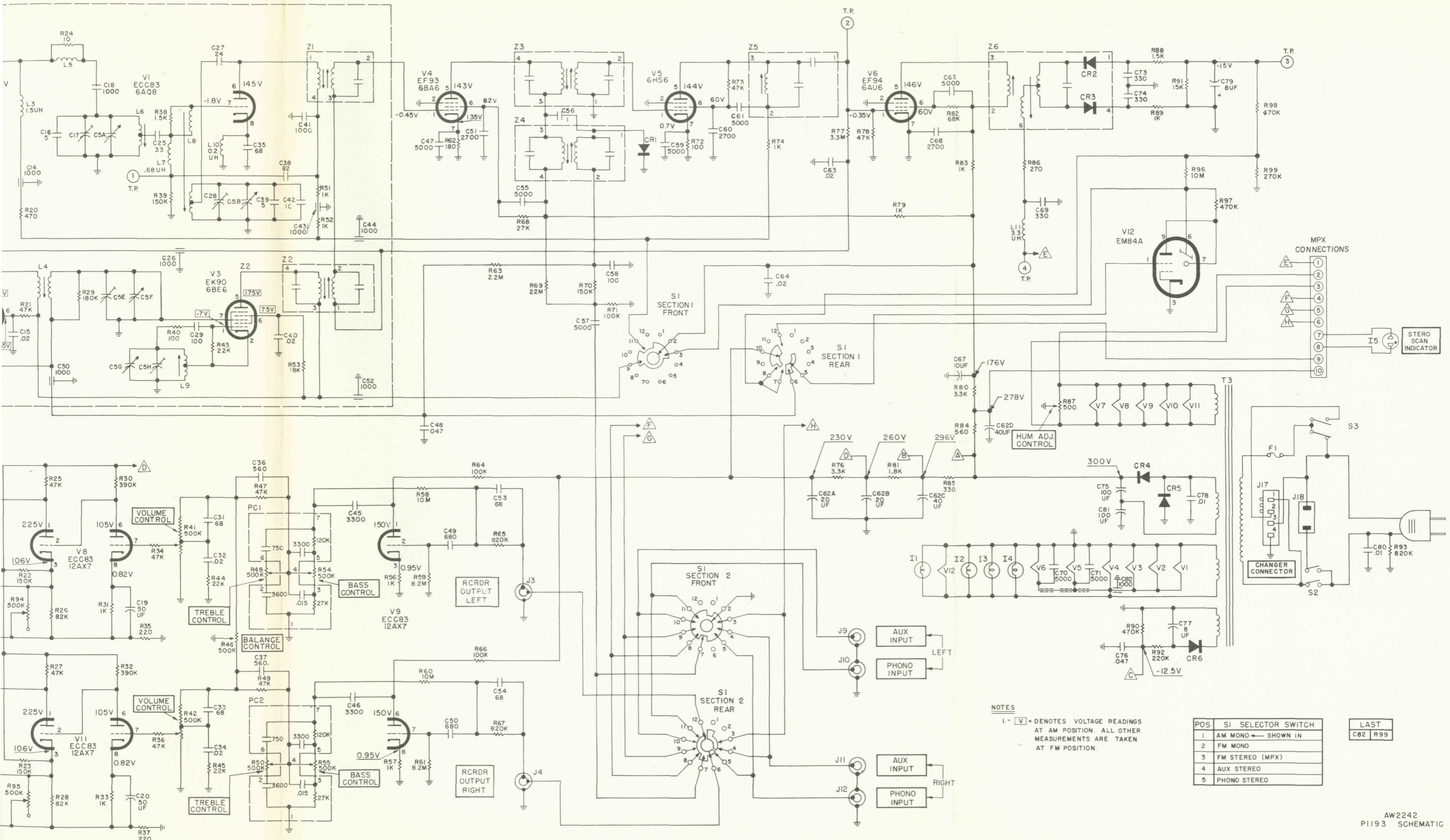

NOTES
 1. - [V] = DENOTES VOLTAGE READINGS AT AM POSITION. ALL OTHER MEASUREMENTS ARE TAKEN AT FM POSITION.

POS	SI SELECTOR SWITCH
1	AM MONO ← SHOWN IN
2	FM MONO
3	FM STEREO (MPX)
4	AUX STEREO
5	PHONO STEREO

LAST
C82 R99

SCHEMATIC DIAGRAM • MULTIPLEX SECTION

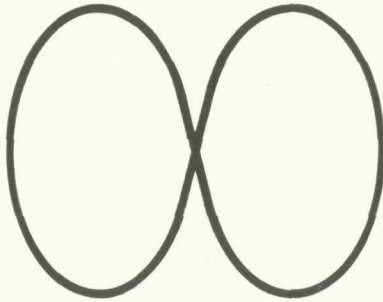
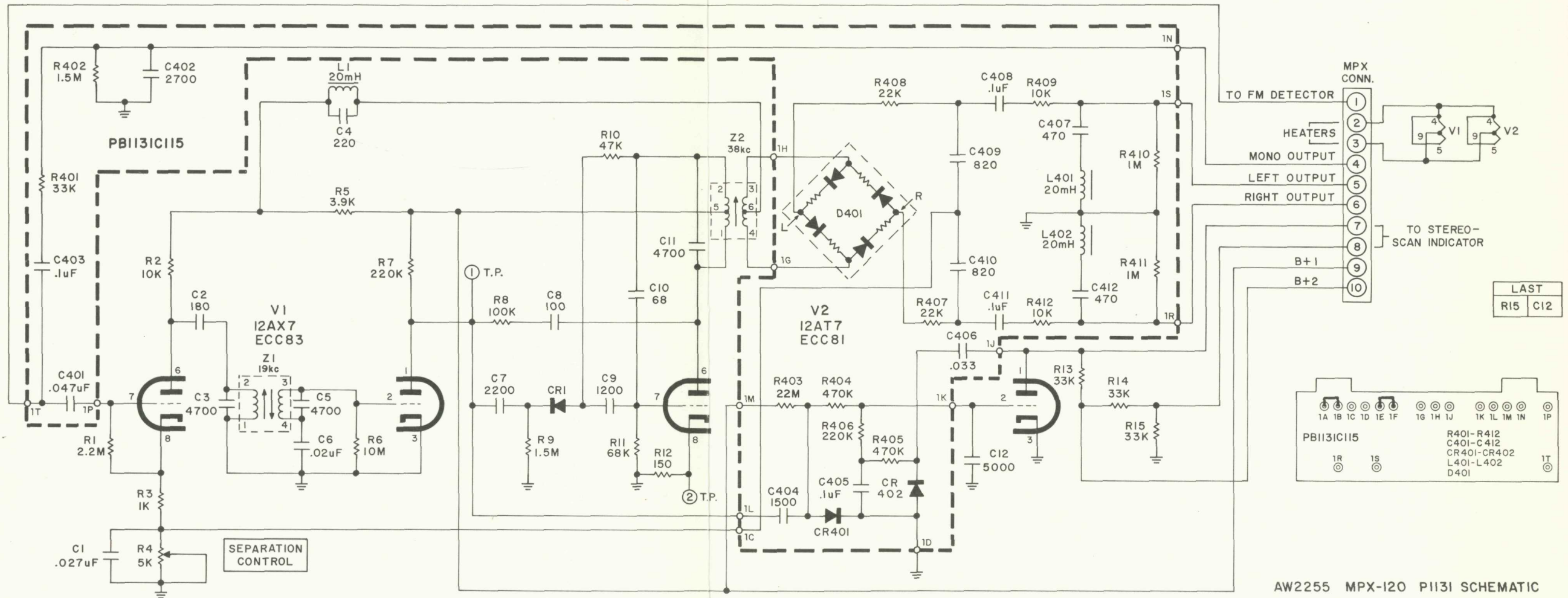
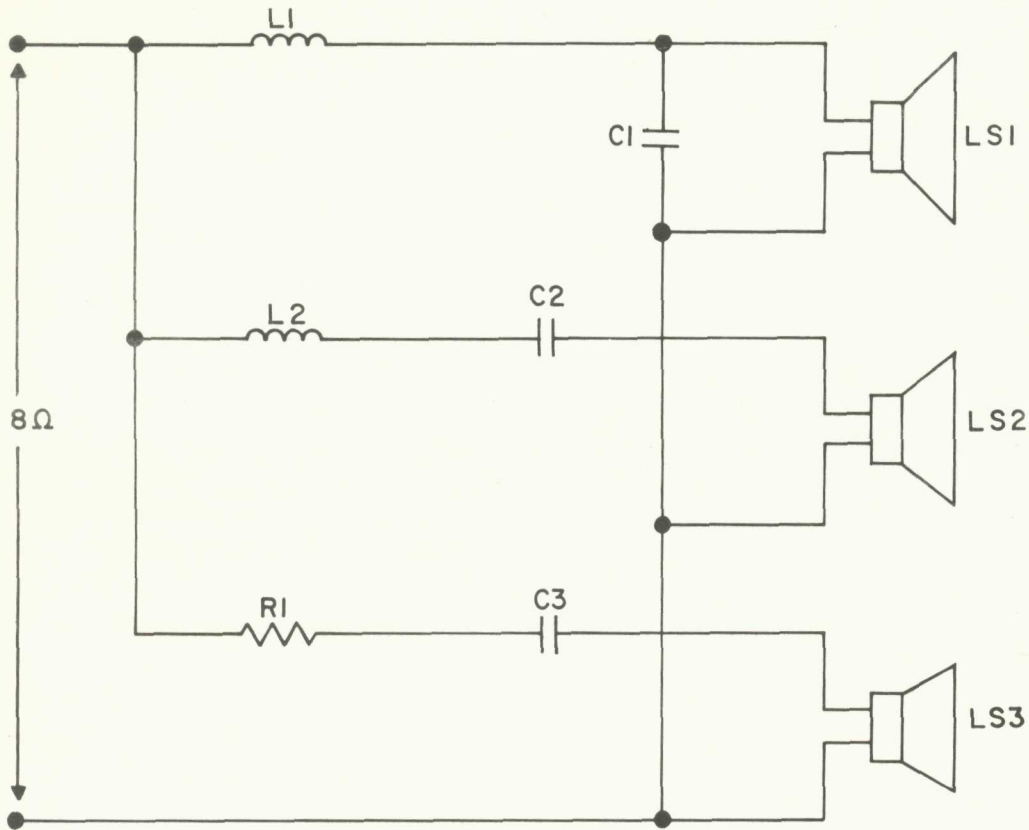

FIGURE 1. Lissajous Pattern For MPX Oscillator Alignment.

SCHEMATIC DIAGRAM • SPEAKER SYSTEMS



INS 234

PARTS DESCRIPTION LIST • SPEAKER SYSTEMS

Symbol	Description	Part No.
C1	Capacitor, 100uf, 15V	C3100
C2	Capacitor, 25uf, 25V	C325
C3	Capacitor, 3 uf, 25V	C303
L1	Coil	L215
L2	Coil	L210
LS1	Speaker, Woofer, 8"	W133
LS2	Speaker, Midrange, 4" x 6"	M132
LS3	Speaker, Tweeter, 2 1/2"	T129
R1	Resistor, 4.7 Ohms	R404.7

TUBE LAYOUT

CHASSIS 29-T

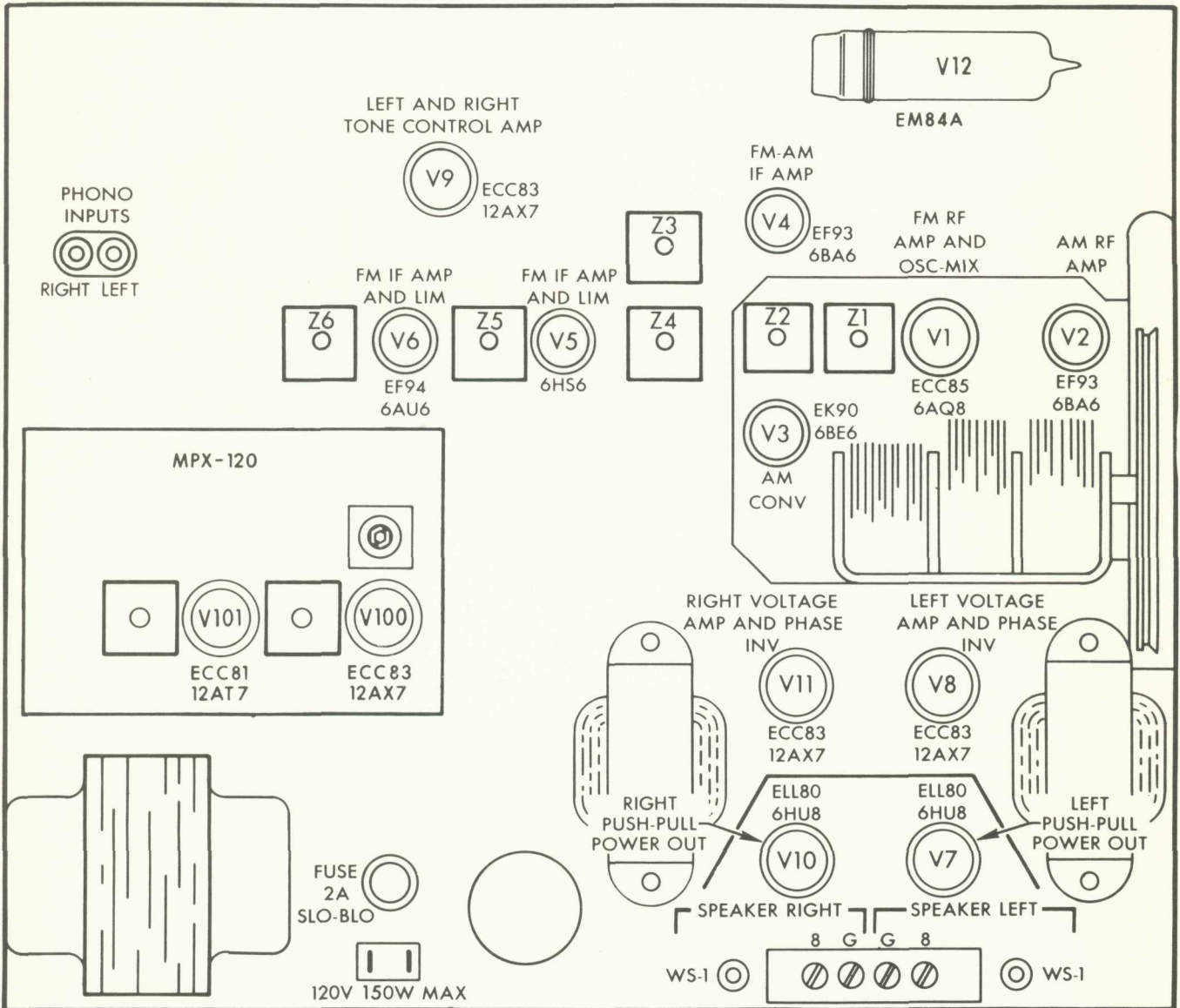

IN5231

SERVICE NOTES



FISHER RADIO CORPORATION • NEW YORK



N1161-700

© 1964 FISHER RADIO CORPORATION

PRINTED IN U S A

M12C-104

(c) www.fisherconsoles.com