

HiFi ENGINE®

For more Hi-Fi manuals and set-up information
please visit www.hifiengine.com

OPERATING INSTRUCTIONS AND WARRANTY

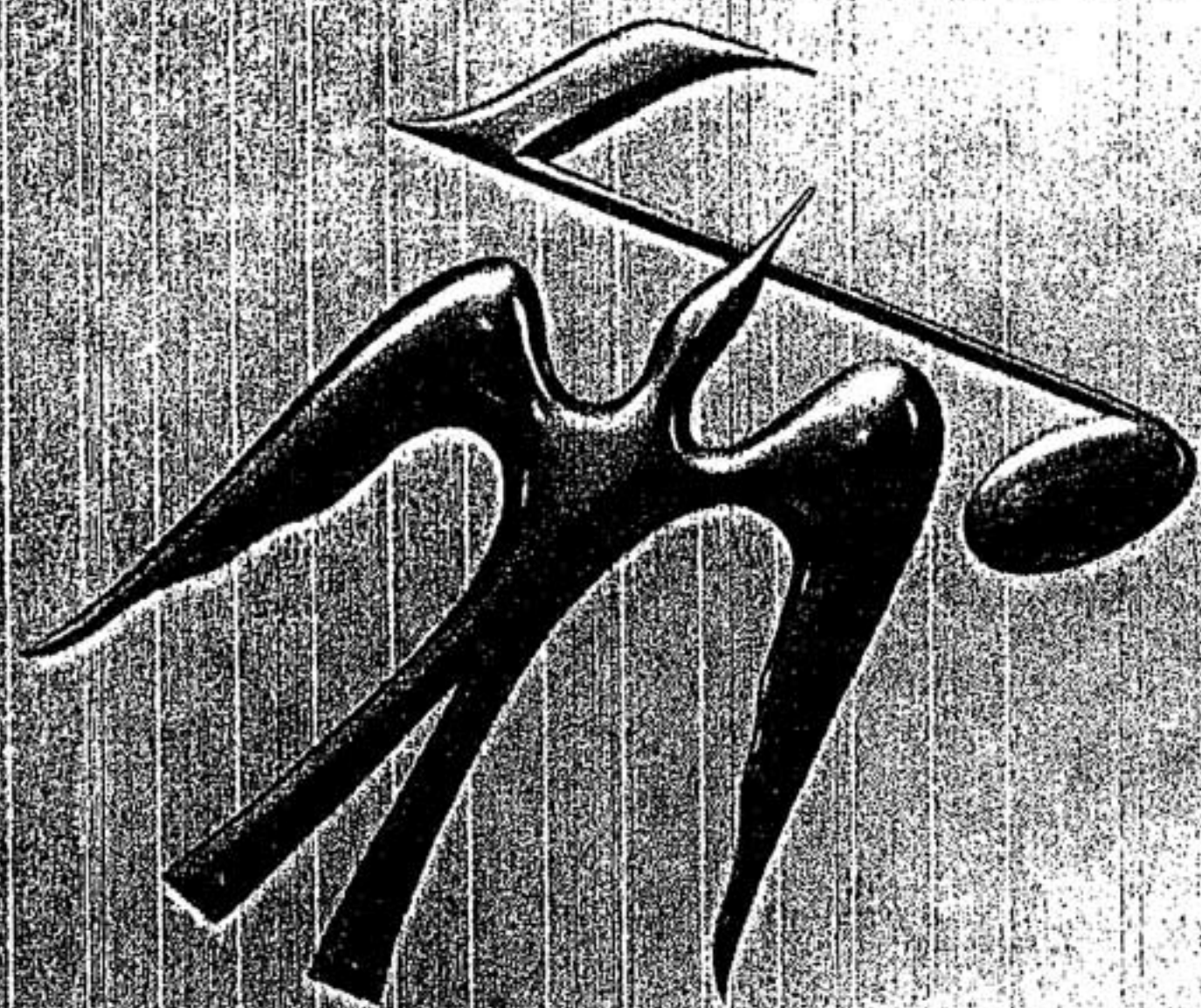

THE FISHER

KX-200

STEREOPHONIC

Master Control-Amplifier

PRICE \$1.00

WORLD LEADER IN HIGH FIDELITY

Congratulations!

WITH your purchase of a FISHER instrument you have completed a chain of events that began many months ago, in our research laboratories. For it is there that the basic concept of the equipment you have just acquired came into being—its appearance, its functions, its quality of performance, its convenience of use.

But the end step—your purchase—is merely a beginning. A door has now opened, for you and your family, on virtually unlimited years of musical enjoyment. Recognizing that one of the keys to pleasurable ownership is reliability, we have designed this instrument to give long and trouble-free service. In fact, instruments we made over twenty-three years ago are still in use today.

Remember always that we want this equipment to give you the best performance of which it is capable. Should you at any time need our assistance toward that objective, please write me personally.

AN IMPORTANT SUGGESTION

Many hours have been spent by our engineers and technical writers to create this instruction book for your guidance and enjoyment. If you want the *most* out of your FISHER, there is only one way to obtain it. With the equipment before you, please read this booklet carefully. It will be time well spent!

Avery Fisher Founder and President

Fisher Firsts - Milestones In the History of High Fidelity Reproduction

- | | | | | | |
|------|--|------|--|------|---|
| 1937 | First high-fidelity sound systems featuring a beam-power amplifier, inverse feedback, acoustic speaker compartments (infinite baffle and bass reflex) and magnetic cartridges. | 1954 | First low-cost electronic Mixer-Fader. | 1959 | First high-compliance plus high-efficiency free-piston speaker system. |
| 1937 | First exclusively high fidelity TRF tuner, featuring broad-tuning 20,000 cycle fidelity. | 1954 | First moderately-priced, professional FM Tuner with TWO meters. | 1960 | First to use MicroRay for FM tuning and as a Recording Audio Level Indicator. |
| 1937 | First two-unit high fidelity system with separate speaker enclosure. | 1955 | First Peak Power Indicator in high fidelity. | 1960 | First complete stereo FM-AM receiver with 60-watt power amplifier and new 7591 output tubes. |
| 1938 | First coaxial speaker system. | 1955 | First Master Audio Control Chassis with five-position mixing facilities. | 1960 | Smithsonian Institution, Washington, D.C., accepts for its collection America's first commercially manufactured high fidelity radio-phonograph, made by Avery Fisher in 1937. |
| 1938 | First high fidelity tuner with amplified AVC. | 1955 | First correctly equalized, direct tape-head master audio controls and self-powered preamplifier. | 1960 | First reverberation device, for use in high fidelity equipment — The Fisher Dynamic Spacexpander. |
| 1939 | First 3-Way Speaker in a high fidelity system. | 1956 | First to use Power Monitor in a home amplifier. | 1960 | First stereo tuner with MicroTune. |
| 1939 | First Center-of-Channel Tuning Indicator. | 1956 | First All-Transistorized Preamplifier-Equalizer. | 1960 | First FM tuner with six IF stages. |
| 1945 | First Preamplifier-Equalizer with selective phonograph equalization. | 1956 | First dual dynamic limiters in an FM tuner for home use. | 1960 | First FM tuner with five limiters. |
| 1948 | First Dynamic Range Expander with feedback. | 1956 | First Performance Monitor in a high quality amplifier for home use. | 1960 | First front panel antenna selector switch, 72-300 ohm, Local-Distant positions. |
| 1949 | First FM-AM Tuner with variable AFC. | 1956 | First FM-AM tuner with TWO meters. | 1961 | First Multiplex units with Stereo Beacon and automatic switching, mono to stereo. |
| 1952 | First 50-Watt, all-triode amplifier. | 1956 | First complete graphic response curve indicator for bass and treble. | 1961 | First complete receivers with Multiplex. |
| 1952 | First self-powered Master Audio Control. | 1957 | First Golden Cascade FM Tuner. | 1961 | First FM-Stereo-Multiplex tuners with Stereo Beam. |
| 1953 | First self-powered, electronic sharp-cut-off filter system for high fidelity use. | 1957 | First MicroRay Tuning Indicator. | 1961 | First loudspeaker system with frameless woofer cone, eliminating all parasitic resonance. |
| 1953 | First Universal Horn-Type Speaker Enclosure for any room location and any speaker. | 1958 | First Stereophonic Radio-Phonograph with Magnetic Stereo Cartridge. | | |
| 1953 | First FM-AM Receiver with a Cascade Front End. | 1959 | First high-quality Stereo Remote Control System. | | |
| | | 1959 | First complete Stereophonic FM-AM Receiver (FM-AM tuner, audio control, 40-watt amplifier). | | |



THE FISHER KX-200
STEREOPHONIC
Master Control-Amplifier

WE WOULD LIKE to congratulate you on having constructed one of the finest stereophonic control-amplifiers in existence. While building the *KX-200*, you no doubt noticed the high quality parts which went into it — the heavy-duty transformers, the mylar capacitors, the gold-band, low noise resistors and silicon diodes. This consistent use of the best available parts will contribute to many years of trouble-free music listening, provided, of course, that the *KX-200* is installed and operated properly. This last is quite important, for the *KX-200*, like any other precision electronic instrument, will deliver its full capabilities only when it is allowed to do so by the user. It is for this reason that we urge you to **READ THIS BOOKLET CAREFULLY** — before attempting to operate your *KX-200*. It will be time well spent.

INSTALLING THE KX-200

THE *KX-200* operates on 105-120 volts, at 50 to 60 cycles. Two auxiliary power outlets are provided on the rear panel for connection of the power cord from the record player, tuner, or other

associated equipment. The *KX-200* should be mounted on a horizontal surface *only* and should be provided with adequate space around the chassis to assure proper ventilation. If it is mounted in a custom installation, the rear of the enclosure should be left *open* and *at least* four inches above and two inches to each side of the chassis should be left free for the circulation of air. The *KX-200* should never be placed directly above, or in contact with, other heat-producing equipment.

Loudspeakers

Placement of loudspeakers has a significant effect on the sound quality of a high fidelity system. Most speakers will give better results in the bass range when placed in a corner, although there are exceptions to this rule. Speakers should generally be placed along a wall in such a position that no large objects block the sound path between the speaker and the listening area. In a stereo system the speakers should be approximately equidistant from the listening area. The distance between the speakers should be approximately two-thirds the

TABLE OF CONTENTS

	PAGE
INSTALLING THE KX-200	1
OPERATING THE KX-200	4
FOR THE MAN IN A HURRY	5
CUSTOM INSTALLATION	8
FOR THE TECHNICALLY-MINDED	11
TECHNICAL SPECIFICATIONS	11

distance separating the speakers from the listening area. It has been found that the aural effect of stereophonic sound is enhanced when two identical speaker systems are used. Although these principles can serve as a general starting point in placing your loudspeakers, we strongly recommend that you experiment with several different arrangements before deciding on a final placement. The unpredictable effects resulting from furniture arrangement and irregularities in room dimensions may make unorthodox placement of the loudspeakers necessary.

After the initial location of the loudspeakers has been decided upon, make the following connections:

ONE SPEAKER: If you are using only one speaker temporarily, connect it between the X and Y lugs on the rear panel under the CENTER CHANNEL SPEAKER bracket. Turn the Center Speaker Level switch on the front panel to the MAX position.

TWO SPEAKERS: Connect the speaker on your left (as viewed from the listening area) to the terminal lugs on the chassis top marked LEFT SPEAKER. After determining the impedance of your speaker, connect one speaker lead to the COM lug and the other lead to the lug which matches the speaker impedance rating. The speaker on your right should be connected to the RIGHT SPEAKER terminal strip, between the COM lug and the "4", "8" or "16" lug, depending on the impedance of the speaker. Ordinary power cord or heavy-duty TV antenna twinlead up to 50 feet in length may be used for these connections.

CAUTION: The COM lug should never be connected to the chassis ground, to the 4-ohm speaker lug or to the chassis ground of other associated equipment. The 4-ohm lug on either speaker terminal strip should be used for *all* ground connections.

THREE SPEAKERS: The stereo effect can be greatly enhanced by using a three-speaker system. In such a system the left and right speakers are placed more than 12 feet apart, and a center channel speaker is placed directly between them. The center channel speaker should

COM IS NEGATIVE OR BLACK SPEAKER WIRE.

be connected to the X and Y lugs on the rear panel of the *KX-200*, and should be of the same, or comparable, type as the left and right speakers. The resulting "wide stage" effect will add a great deal to the realism inherent in stereophonic sound.

Speaker Phasing

After the *KX-200* and associated equipment are placed in operation, the speaker systems must be properly phased, so that they "push" and "pull" in unison rather than in opposition. This is done by playing a monophonic record with prominent bass material and turning the Mode Selector to MONO PHONO. Reverse the leads to one of the speaker systems several times, and compare the sound output. When the two speaker systems are correctly phased, you should detect a definite improvement in the bass response and a more constant sound level as you move between the two speaker locations. If you are using a center speaker, it should be phased by the same method.

Record Players

Magnetic or ceramic cartridges may be played through the *KX-200*. The MAG 1 and MAG 2 jacks are used for magnetic cartridges. The Channel A cable from the record player should be connected to the MAG 2 jack on the top panel. The Channel B cable should be connected to the MAG 2 jack on the rear panel. An additional record player employing a magnetic cartridge can be connected to the MAG 1 jacks in the same manner.

Most ceramic cartridges are intended for use with the high level inputs, AUX 1 or AUX 2. Some ceramic cartridges have been designed specifically for use with magnetic cartridge inputs. Such cartridges should be connected to the MAG 1 or MAG 2 jacks.

Tuners

Tuners are connected to the TUNER input jacks, one on the rear panel and one on the chassis top.

MONOPHONIC FM TUNER:

Connect the main output of the tuner to the Channel A TUNER jack on the top panel of the *KX-200*.

FM-AM STEREO TUNER:

1 — Connect the main FM output of the tuner to the Channel A TUNER jack on the top panel.

2 — Connect the main AM output of the tuner to the Channel B TUNER jack on the rear panel.

STEREO FM MULTIPLEX TUNER OR MULTIPLEX ADAPTOR:

1 — Connect the Channel A or Left output of the tuner or adaptor to the Channel A TUNER jack on the top panel of the *KX-200*.

2 — Connect the Channel B or Right output of the tuner or adaptor to the Channel B TUNER jack on the rear panel.

Tape Recorder

Special connections are provided on the *KX-200* for use with a tape recorder. Connect your tape recorder as follows:

THREE-HEAD STEREO RECORDER (Separate record and playback heads):

1 — Connect the Channel A (or Left) output of the tape recorder to the Channel A MON jack on the top panel of the *KX-200*.

2 — Connect the Channel B (or Right) output of the tape recorder to the Channel B MON jack on the rear panel of the *KX-200*.

3 — Connect the Channel A (or Left) input of the tape recorder to the top panel jack marked REC A on the *KX-200*.

4 — Connect the Channel B (or Right) input of the tape recorder to the jack on the top panel of the *KX-200* marked REC B.

TWO-HEAD STEREO RECORDER (Common record and playback head):

1 — Connect the Channel A (or Left) output of the tape recorder to the Channel A AUX 1 jack on the top panel. (If the AUX 1 jacks are already in use, substitute the AUX 2 jacks for these connections.)

2 — Connect the Channel B (or Right) output of the tape recorder to the Channel B AUX 1 jack on the rear panel.

A SHORT OPERATING GUIDE FOR 'THE MAN IN A HURRY'

STEREO MASTER
CONTROL AMPLIFIER

MODEL KX-200

T H E F I S H E R

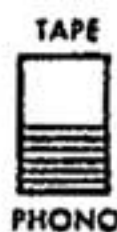

EQUALIZATION

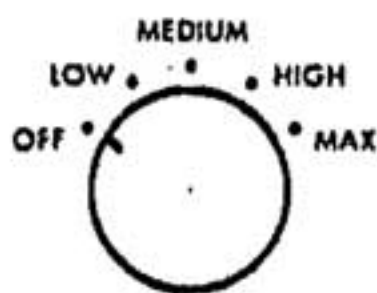

CENTER SPEAKER LEVEL



HIGH FILTER



TAPE MONITOR

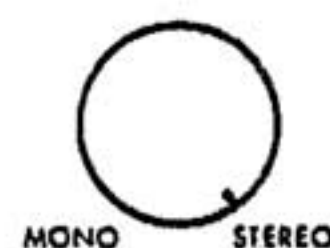

STEREO DIMENSION



LOUDNESS CONTOUR

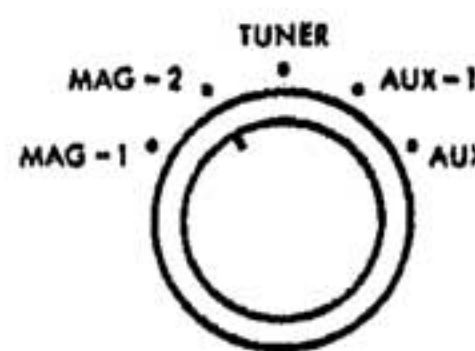

INPUT SELECTOR

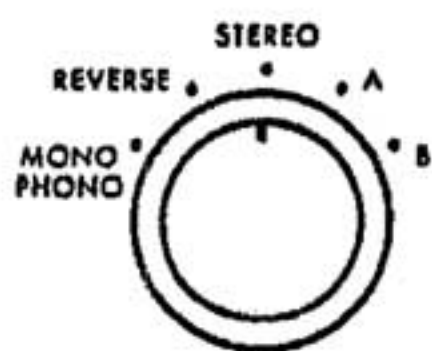

MODE SELECTOR

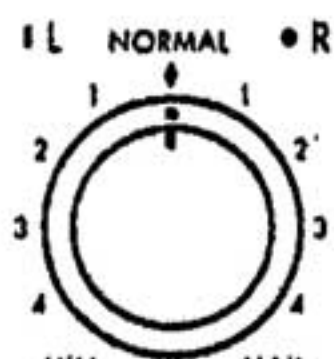

BASS

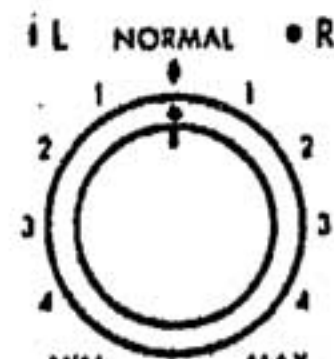

TREBLE

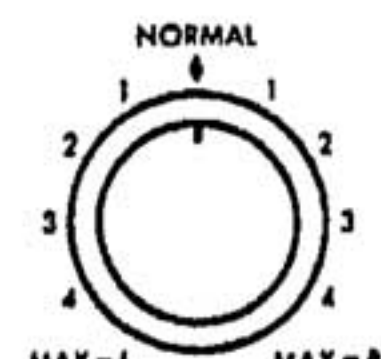

BALANCE

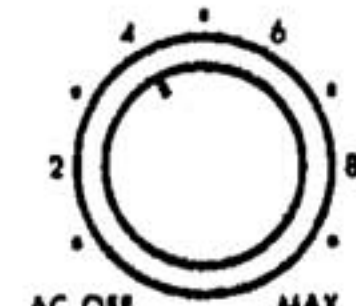

MASTER VOLUME

STEP 2

Set **INPUT SELECTOR** to program source you wish to hear.

MAG 2 to play records on a player connected to the **MAG 2** jacks.

TUNER to listen to a radio broadcast.

STEP 3

Set **MODE SELECTOR** to type of operation desired.

MONO PHONO to play monophonic records with a stereo cartridge.

STEREO to listen to *all* stereo program material.

A for any monophonic program source connected to Channel A.

B for any monophonic program source connected to Channel B.

STEP 1

Set all switches and controls as shown. Turn on power by turning **MASTER VOLUME** control slightly clockwise until it clicks. Adjust later for volume.

3—Connect the Channel A (or Left) input of the tape recorder to the REC A jack on the top chassis of the *KX-200*.

4—Connect the Channel B (or Right) tape recorder input to the REC B jack on the rear panel of the *KX-200*.

MONOPHONIC RECORDER: Connect the single input of the tape recorder to the REC A jack on the top panel of the *KX-200*. If the recorder has separate record and playback heads, connect the tape recorder output to the MON jack on the top panel. (Turn the Stereo Dimension control to MONO for playback from both speakers.) If the recorder employs a single record-playback head, connect the output to the Channel A AUX 1 jack.

Tape Decks

A tape deck is the tape transport mechanism without the electronic preamplifiers found in tape recorders. Such tape decks may be played through the *KX-200*, by connecting the Channel A (or Left) output cable from the deck to the Channel A MAG 1 jack on the top chassis. The Channel B (or Right) output cable from the tape deck should be connected to the Channel B MAG 1 jack on the rear panel. When using the tape deck, the Equalization switch on the front panel should be placed in the TAPE position.

System Grounding

If you wish to ground the tone arm and motor casing of your record player in order to reduce hum, connect the ground wire from the record player to the terminal lug marked "4" on either the Left Speaker or the Right Speaker terminal strip.

OPERATING THE KX-200

Power Switch and Master Volume

Power to the *KX-200* is turned off at the extreme counterclockwise position. The Master Volume control regulates the total volume of

sound from both speaker systems, thus making it unnecessary to balance the channels each time you change the volume.

Loudness Contour Switch

As the over-all volume of sound is reduced, our hearing efficiency drops off more rapidly at the extreme ends of the tonal spectrum (deep bass and upper treble). The Loudness switch automatically compensates for this natural relative hearing loss.

Input Selector

MAG 1: Selects a tape deck or an additional record player connected to the MAG 1 jacks.

MAG 2: Selects a record player or tape deck connected to the MAG 2 jacks.

TUNER: Selects a tuner or multiplex adaptor for all types of radio listening.

AUX 1: Selects any component connected to the AUX 1 jacks.

AUX 2: Selects any component connected to the AUX 2 jacks.

Mode Selector

MONO PHONO: This position is used for playing all monophonic records with a stereo cartridge and for all other program sources when it is desired to blend the signals from Channels A and B and send this blended signal to both the left and right speaker systems.

REVERSE: Sends the Channel A signal to the right speaker system and the Channel B signal to the left speaker system. Since *normal* operation is just the opposite of this, the REVERSE position should only be used if the channels are reversed at the program source through error.

STEREO: This position is normally used for *all* stereo programs. The Channel A signal is directed to the left speaker system and the Channel B signal to the right speaker system.

A: The signal from any component connected to a Channel A input

can be heard through both speaker systems when this position is selected.

B: Any component connected to a Channel B input can be heard through both speaker systems with the Mode Selector in this position.

Balance

This control is used to equalize the sound levels from both speaker systems to achieve the optimum stereo effect. If the Channel A and Channel B inputs are exactly balanced, you will hear equal sound levels from the left and right speakers with the control in the NORMAL position. If, however, there is an imbalance in the program levels, you can re-balance the sound levels by turning the Balance control either clockwise (to increase the sound level on the right and decrease the sound level on the left) or counterclockwise (to increase the left and decrease the right). The Balance control is not a volume control since the same over-all volume is maintained as it is adjusted. With the Balance control fully counterclockwise, only the left speaker will be heard; with the control fully clockwise, only the right speaker will be in operation.

Bass and Treble

The Bass controls increase or decrease the amount of bass tones heard in the sound output. With the Bass controls in the NORMAL position, the bass tones will sound exactly as they were recorded at the program source. If you wish to increase the bass emphasis because of a bass deficiency in the record, tape or radio broadcast you have selected, simply turn the Bass controls the desired amount toward the MAX position. To decrease the prominence of the bass tones, turn the Bass controls toward MIN. Normally, the Bass controls for left and right speaker systems rotate together, but if you wish to adjust the Bass separately for each channel, hold one of the knobs while turning the other.

The Treble controls adjust the intensity of the treble tone heard in the sound output. As with the Bass controls, the NORMAL position will result in the same degree of treble tone as exists in the program

source. The relative amount of treble tone can be increased, resulting in a more brilliant and crisp sound, by turning the Treble controls toward MAX; and it can be decreased, resulting in a more mellow and intimate tone, by turning the control toward MIN. The Treble controls may also be adjusted individually for each channel by holding one knob while rotating the other.

Equalization Switch

The Equalization switch is effective *only* when the Input Selector switch is turned to the MAG 1 or MAG 2 position. In the PHONO position, it provides RIAA equalization, which has been used by all record manufacturers since 1955 for both monophonic and stereo discs. The TAPE position provides standard NAB equalization for a tape deck connected to the MAG 1 or MAG 2 jacks on the rear panel.

High Filter

The High Filter is a sharp cut-off circuit designed to remove annoying record scratch, hiss and other high frequency noise without dulling the treble portion of the musical signal.

Stereo Dimension

The Stereo Dimension control permits the blending of varying proportions of each of the two channels, thus decreasing the separation or apparent "distance" between the two channels. This is especially important when the program source appears to have an exaggerated separation between the two channels, resulting in a "ping-pong" effect; or when the speakers must be placed far apart in the listening room, causing a "hole-in-the-middle" effect. With the control in the STEREO position, the full channel separation of the program source is maintained. As the control is rotated toward MONO, the separation is decreased until, at MONO, the two channels are completely blended, resulting in a monophonic signal.

Tape Monitor

Tape recordings can be played through the *KX-200* by placing the

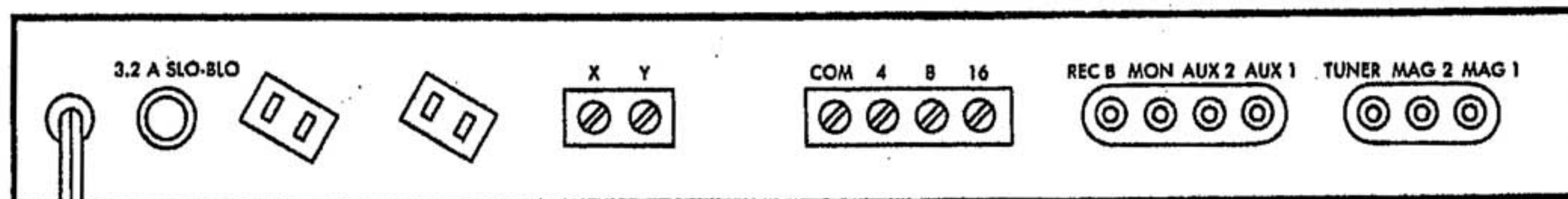
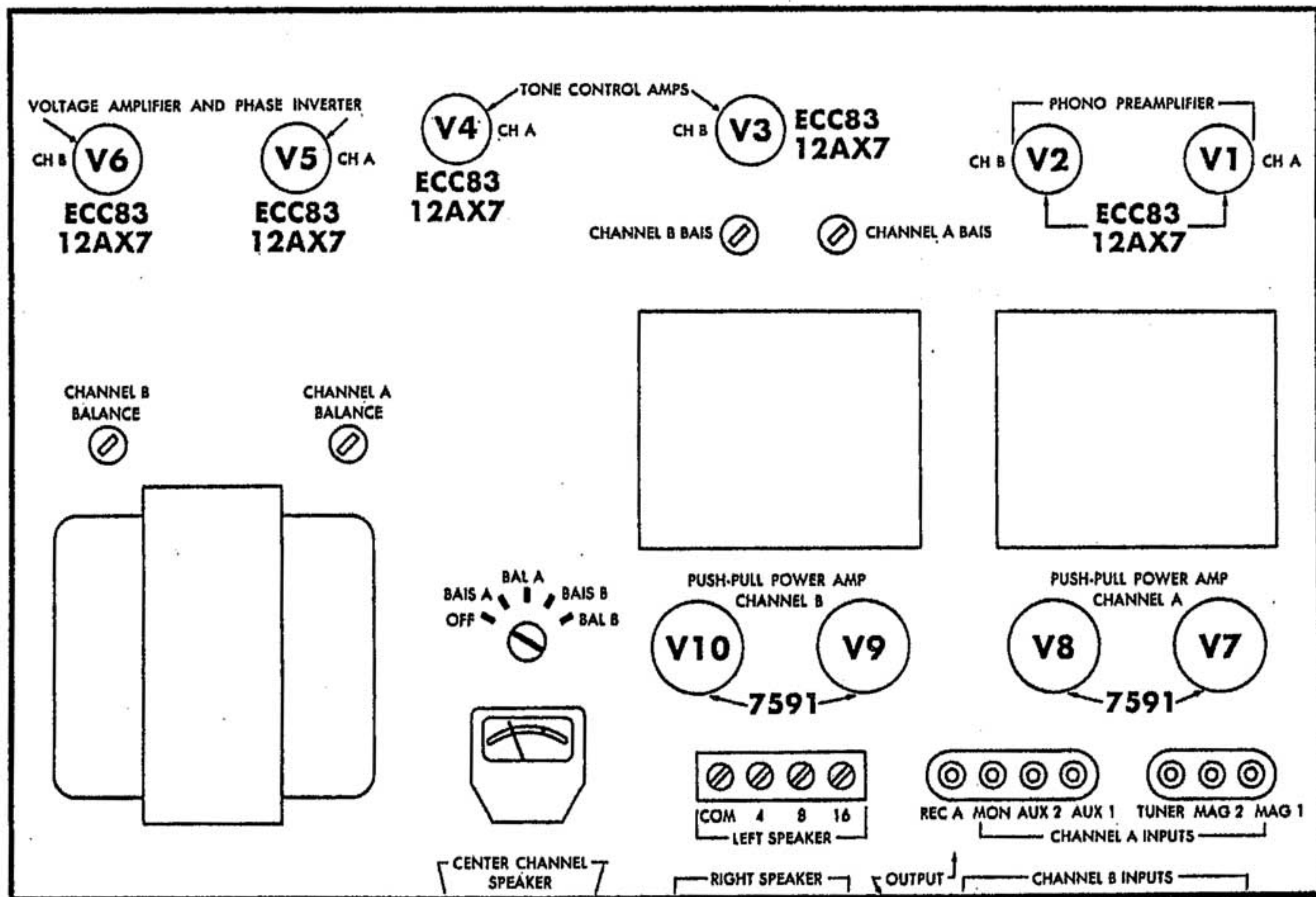

AW 1977

X-BLACK Y-RED COM-BLACK

FIGURE 1. Tube layout and rear panel of the KX-200.

Tape Monitor switch in the ON position. In addition, tapes can be compared with the input signal *while making a recording* (on tape machines with separate recording and playback heads) by switching between the OFF and ON position. *Be sure to return the switch to the OFF position when not using the tape recorder or the KX-200 will be completely inoperative.*

Center Speaker Level

If you are using a center channel speaker (as described on page 2), the Center Speaker Level switch should be adjusted so that the sound from the center speaker fills the center of the stereophonic sound pattern without reducing channel separation. In most cases, the best effect will be obtained with the center speaker at a somewhat lower volume than the left and right speakers. If you desire to place the center channel speaker in a remote location in another room of your home, you can adjust the sound level of the speaker independently of the two channel speakers with the Center Speaker Level switch. The Master Volume control will be effective for all three speakers. If the center channel facilities are not used, the Center Speaker Level switch should be left in the OFF position.

Bias and Balance Adjustments

Although the output tubes used in the *KX-200* are extremely stable and will normally require little attention, it is advisable to check the bias and balance occasionally to insure optimum operation. We suggest the following schedule:

- 1 — Check immediately after replacing an output tube.
- 2 — Check 30 days after initial construction and after any subsequent replacement of one or more output tubes.
- 3 — Check annually.

To make this check, simply turn the Master Volume control counter-clockwise for minimum volume. Then turn (with a screwdriver) the Meter switch on the top chassis to the Bias and Balance positions for

each channel. If the meter does not show a reading within the appropriate red band, adjust the corresponding control on the top chassis of the amplifier. Recheck all readings after making an adjustment.

CUSTOM INSTALLATION

TWO SPECIAL CUSTOM CABINETS, designed to accommodate the *KX-200*, are available from your FISHER dealer. These are the Model MC-2 metal cabinet, and Model 10-U wood cabinet. Both are attractively designed to enhance room decor. The *KX-200* may also be mounted in your own custom cabinet. Directions and illustrations are provided in this section.

Because adequate ventilation is an *absolute essential* for trouble-free operation, never install the *KX-200* in a totally enclosed space, or too close to other heat-producing equipment. Also, do not install the *KX-200* in a vertical position. If the *KX-200* is mounted in a custom installation, the back of the equipment cabinet should be left open and a space of 4 inches above and 2 inches to each side of the *KX-200* should be provided in the enclosure for the amplifier.

The *KX-200* may be installed in two ways: with cleats, to raise it above the shelf of the cabinet to provide ventilation; or, without cleats, in which case cutouts must be made in the cabinet shelf. The two types of installation follow.

Installing With Cleats

- 1 — Obtain a strip of wood $\frac{3}{4}$ inches square and 25 inches long. Cut this strip in half to form two $12\frac{1}{2}$ inch cleats.
- 2 — Fasten the two cleats to the top of the mounting board with wood screws, in the positions shown in Fig. 2. Then locate and drill three $\frac{1}{4}$ -inch holes through the mounting board and cleats as indicated.
- 3 — Saw a cutout through the front panel of your cabinet ($4\frac{1}{2}$ by $14\frac{3}{4}$) as shown in Fig. 3. The bottom edge of the cutout should be on a level with the top of the two cleats.

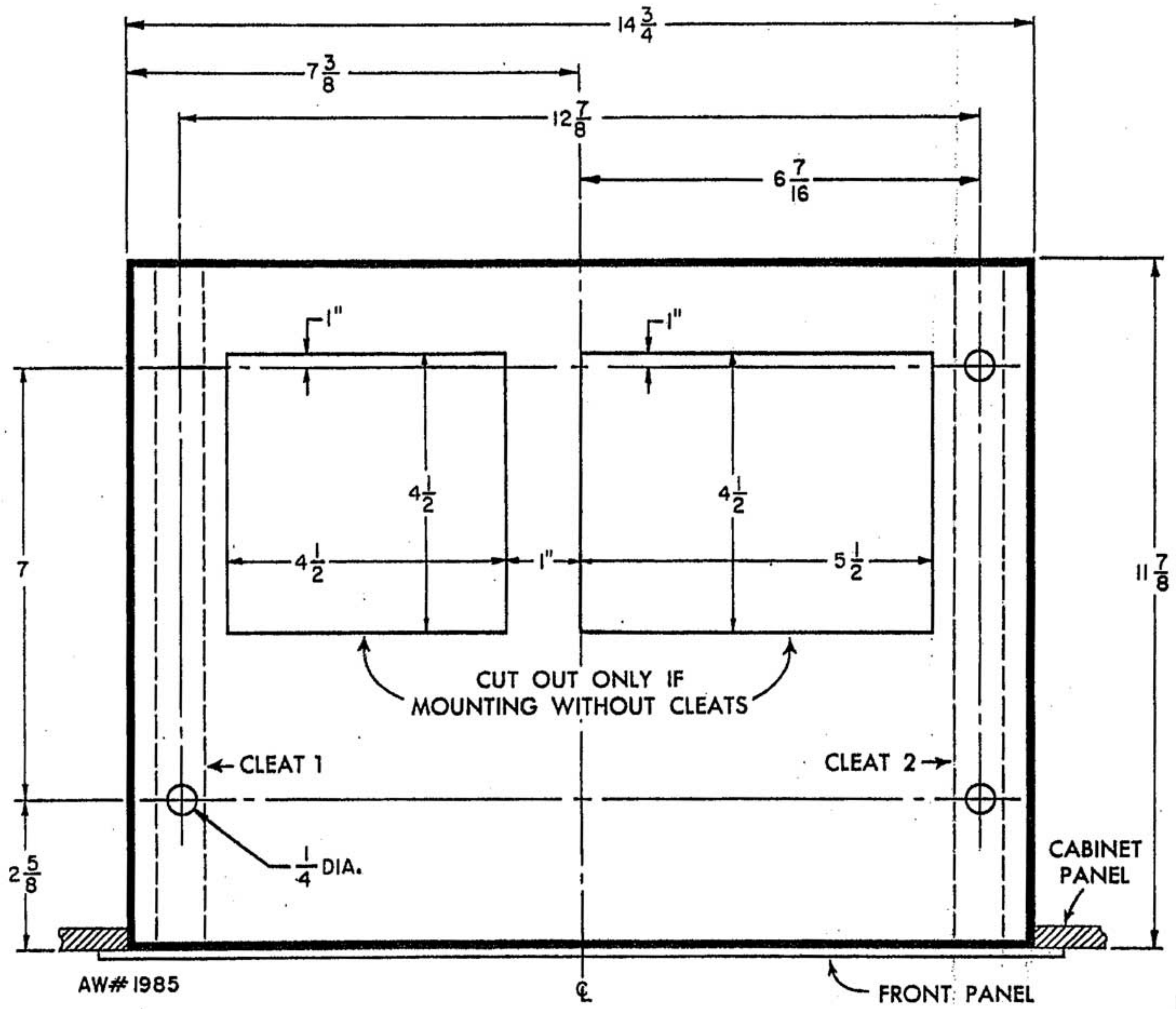

FIGURE 2. Top view of custom installation.

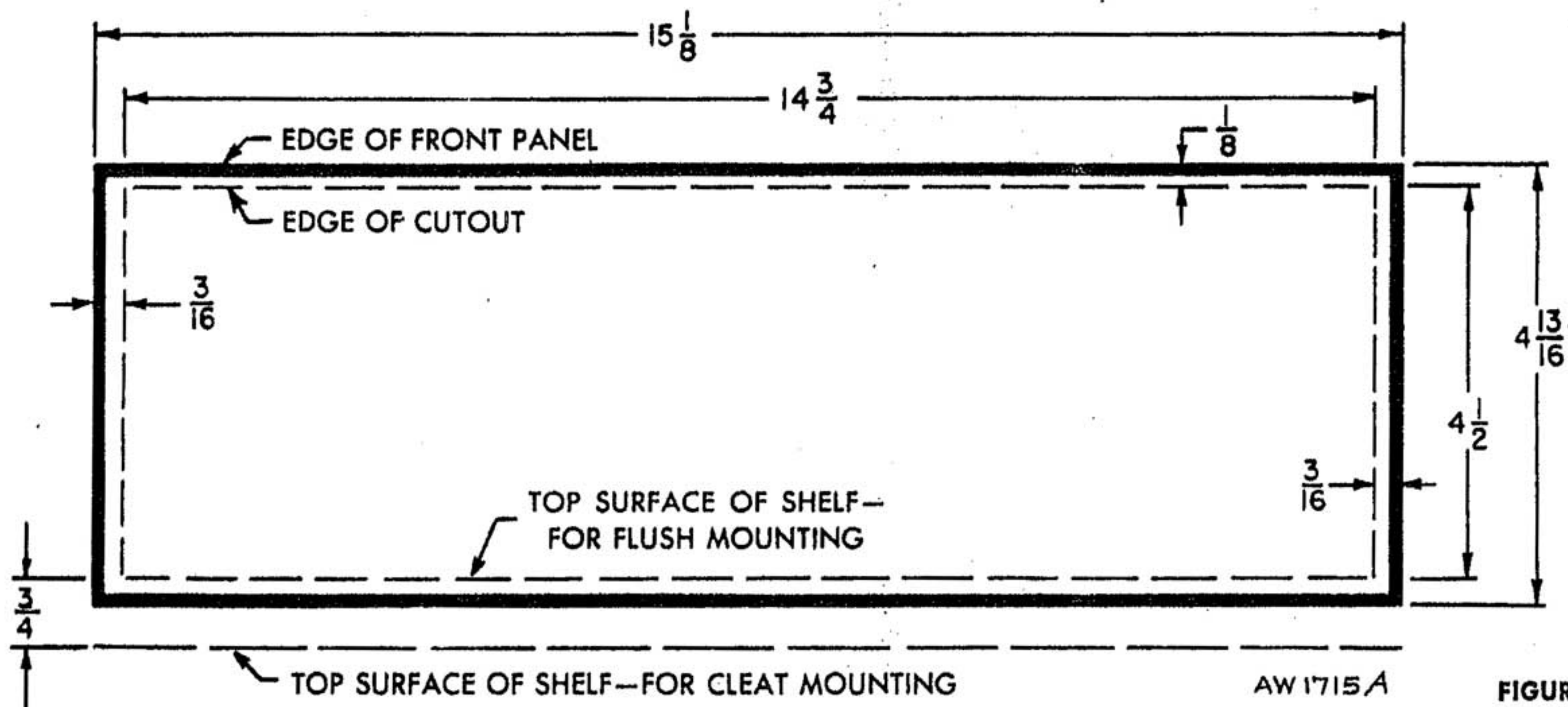

FIGURE 3. Front panel cutout.

4—Remove the four plastic feet from the *KX-200* and insert the chassis through the *front* of the panel cutout. Slide the chassis into the cabinet until the back of the control panel is tight against the panel of the cabinet.

5—Insert the three $1\frac{1}{2}$ inch screws supplied in the accessories bag through the holes in the bottom of the mounting board and fasten the chassis into place.

CAUTION: Do not insert a screw through the hole in the bottom plate closest to the output tubes.

Installing Without Cleats

1—Cutouts must be made in the mounting board beneath the ventilation holes in the bottom cover of the *KX-200*, as shown in Fig. 2. The back of the cabinet must remain open.

2—Locate and drill three $\frac{1}{4}$ -inch holes in the mounting board as shown in Fig. 2.

3—Saw a rectangular cutout through the front panel of the cabinet ($4\frac{1}{2}$ by $14\frac{3}{4}$) as shown in Fig. 3. Note that the bottom edge of the cutout is flush with the top of the mounting board.

4—Remove the four plastic feet from the *KX-200* and insert the chassis through the *front* of the panel cutout. Slide the chassis in all the way until the back of the front panel fits tightly against the panel of the cabinet.

5—Insert the three 1-inch screws supplied in the accessories bag through the holes in the bottom of the mounting board and fasten the chassis into place.

CAUTION: Do not insert a screw through the hole in the bottom plate closest to the output tubes.

FOR THE TECHNICALLY-MINDED

YOUR *KX-200* is not just another typical amplifier kit — with reduced features and performance characteristics to keep the price tag low and the construction time at a minimum. Instead, it represents the long-standing Fisher “no compromise” approach to component design. In appearance, in flexibility of controls and in performance, it matches comparable Fisher factory-wired units — high standards, indeed, for any amplifier to meet. Conservative design principles were used throughout to assure complete stability under all speaker loads. A high margin of reserve power is provided by the power supply, enabling the *KX-200* to deliver full rated power from both channels simultaneously. The power supply includes four long-life silicon diodes, in two separate full-wave rectifier circuits — one of which provides DC filament voltage for all but the push-pull power output tubes.

V1 and V2 are dual-triode phono preamplifiers, using feedback equalization for low-level magnetic cartridges and for tape decks. The input impedance of 47K ohms matches practically all high quality magnetic cartridges. These stages are followed by the tone control and High Filter amplifiers (V3 and V4). Feedback is used around each stage to reduce internal noise and distortion. In addition, tape monitor facilities are included before the tone controls to permit adjustment of tonal characteristics during tape playback. V5 and V6 are also dual-triodes, each utilized as a voltage amplifier and direct-coupled phase inverter.

The push-pull output stages employ 7591 power tubes with fixed bias for a conservative rating of 40 watts of Music Power per channel. The main feedback loop measures 22 db, and extends over three amplifier stages from the secondary of each output transformer. Each channel employs seven additional feedback loops to reduce noise and distortion to the vanishing point. Both the careful design and the high quality of the components are your best guarantee of long, pleasurable, and trouble-free service.

TECHNICAL SPECIFICATIONS

Music Power Output (IHFM standard, both channels)	80 watts
RMS Power Output (both channels)	70 watts
Harmonic Distortion (at rated RMS power)	0.4%
IM Distortion (60 and 7000 cps at 4:1, RMS rated output)	0.8%
Frequency Response Over-all Power amplifier	20-20,000 cps \pm 1 db 10-110,000 cps, +0, -1 db
Hum and Noise With Master Volume control at min.	93 db below RMS rated output
High Level Input (450 mv reference level)	79 db below RMS rated output
Low Level Input (6 mv reference level)	65 db below RMS rated output
Channel Separation (at 1 kc)	Better than 50 db
Feedback Factor	22 db
Sensitivity Low Level inputs High Level inputs	3.5 mv for RMS rated output 350 mv for RMS rated output
High Filter	12 db per octave above 5 kc
Bass Control Range	30 db total
Treble Control Range	32 db total
Damping Factor	10
Power Consumption (at 105-120 volts, 50/60 cycles)	200 watts

Warranty To Owner

THE FISHER equipment you purchased was carefully tested and inspected before leaving our laboratories. If properly installed and operated in accordance with the instructions furnished, it should give you the finest results of which it is capable. This equipment is unconditionally guaranteed against all defects in material and workmanship for ninety days from date of sale to the original purchaser. Any part of the equipment which under normal installation and use, discloses such a defect, will be adjusted or replaced by the dealer from whom purchased. To protect your warranty, be sure to mail this card *within 10 days* from date of purchase.

FOR WARRANTY SERVICE, CONSULT YOUR DEALER



Please complete and return this
WARRANTY CARD

PLEASE PRINT

USER'S LAST NAME		FIRST NAME	INITIAL
USER'S HOME ADDRESS			
CITY		STATE	
DATE OF PURCHASE • •	MODEL NO.	SERIAL NO.	

Name of Dealer _____

City _____ State _____

I heard of the FISHER through Friend Dealer Advertising

If purchased because of advertising,
please give name of publication: _____

I chose THE FISHER because: _____

What I think of my FISHER equipment: _____

I also own these additional hi-fi units and speakers: _____

Please send copies of your literature to:

Name _____

Address _____

**WARRANTY VOID UNLESS COMPLETED AND RETURNED
WITHIN 10 DAYS AFTER DATE OF PURCHASE**



BUSINESS REPLY CARD
 FIRST CLASS PERMIT No. 45377, NEW YORK, N. Y.



The Man Behind the Product

AVERY FISHER
Founder and President,
Fisher Radio Corporation

TWENTY-FOUR YEARS AGO, Avery Fisher introduced America's first high fidelity radio-phonograph. That instrument attained instant recognition, for it opened a new era in the faithful reproduction of records and broadcasts. Some of its features were so basic that they are used in all high fidelity equipment to this day. One of these models is now in the permanent collection of the Smithsonian Institution as an example of the earliest high fidelity instruments commercially available in this country.

The engineering achievements of Avery Fisher and the world-wide reputation of his products have been the subject of descriptive and biographical articles in *Fortune*, *Time*, *Pageant*, *The New York Times*, *Life*, *Coronet*, *High Fidelity*, *Esquire*, *The Atlantic*, and other publications. Benefit concerts for the National Symphony Orchestra in Washington and the Philadelphia Orchestra, demonstrating recording techniques, and the great advances in the art of music reproduction, used FISHER high fidelity instruments both for recording and playback, to the enthralled audiences. FISHER equipment formed the key part of the high fidelity demonstration at the American National Exposition in Moscow, July 1959. FISHER FM and FM-AM tuners are the most widely used by broadcast stations for monitoring and relay work, and by research organizations—under conditions where absolute reliability and maximum sensitivity are a 'must.'

The FISHER instrument you have just purchased was designed to give you many years of pride and enjoyment. If you should desire information or assistance on the installation or performance of your FISHER, please write directly to Avery Fisher, President, Fisher Radio Corporation, Long Island City 1, New York.

FISHER RADIO CORPORATION

21-21 44th Drive

Long Island City 1, N. Y.

