

OPERATING INSTRUCTIONS AND WARRANTY



# THE FISHER

## Custom Electra V

MODEL E46

STEREOPHONIC RADIO-PHONOGRAPH

WORLD LEADER IN HIGH FIDELITY

### RECORD CHANGER CAUTION

The Record Changer furnished with this equipment has been designed to play up to ten records continuously. However, stacking this changer to its full capacity may exceed the allowable stylus pressure, which is extremely critical when stereo cartridges are used. The pickup arm has been adjusted at the factory for optimum stylus pressure with a maximum of five records. It is recommended that not more than this number be stacked on the changer for the best sound reproduction.

[www.fisherconsoles.com](http://www.fisherconsoles.com)



## Congratulations!

WITH your purchase of a FISHER instrument you have completed a chain of events that began many months ago, in our research laboratories. For it is there that the basic concept of the equipment you have acquired came into being—its appearance, its functions, its quality of performance.

But the end step—your purchase—is merely a beginning. For you and your family, it will provide years of musical pleasure. The FISHER is from its inception designed to give long and trouble-free service. Some of the instruments we made twenty-three years ago are still in use today!

It is our continuing desire that your FISHER give you always the best performance of which it is capable. If you need our assistance at any time toward that objective, please keep in mind that we are always at your service.

### IN CLOSING —

Many hours have been spent by our engineers and technical writers to create this instruction book for your guidance and enjoyment. If you want the most out of your FISHER, there is only *one* way to obtain it. With the equipment before you, *please read this booklet carefully*. It will be time well-spent.

Avery Fisher

## Fisher Firsts

### Milestones In Audio History

- 1937 America's first high fidelity sound systems. Featured a beam-power amplifier, inverse feedback, acoustic speaker compartments (infinite baffle and bass reflex) and magnetic cartridges.
- 1937 First exclusively high fidelity TRF tuner, featuring broad-tuning 20,000 cycle fidelity.
- 1937 First two-unit high fidelity system with separate speaker enclosure.
- 1938 First coaxial speaker system.
- 1939 First Dynamic Range Expander.
- 1939 First 3-Way Speaker in a high fidelity system.
- 1939 First Center-of-Channel Tuning Indicator.
- 1945 First Preamplifier-Equalizer with selective phonograph equalization.
- 1948 First Dynamic Range Expander with feedback.
- 1949 First FM-AM Tuner with variable AFC.
- 1952 First 50-Watt, all-triode amplifier.
- 1952 First self-powered Master Audio Control.
- 1953 First self-powered, electronic sharp-cut-off filter system for high fidelity use.
- 1953 First Universal Horn-Type Speaker Enclosure for any room location and any speaker.
- 1953 First FM-AM Receiver with a Cascode Front End.
- 1954 First low-cost electronic Mixer-Fader.
- 1954 First moderately-priced, professional FM Tuner with TWO meters.
- 1955 First Master Audio Control Chassis with five-position mixing facilities.
- 1956 First to incorporate Power Monitor in a home amplifier.
- 1956 First All-Transistorized Preamplifier-Equalizer.
- 1956 First dual dynamic limiters in an FM tuner for home use.
- 1956 First FM-AM tuner with TWO meters.
- 1956 First complete graphic response curve indicator for bass and treble.
- 1957 First Golden Cascode FM Tuner.
- 1957 First MicroRay Tuning Indicator.
- 1958 First Stereophonic Radio-Phonograph with Magnetic Stereo Cartridge.
- 1959 First high-quality Stereo Remote Control System.
- 1959 First complete Stereophonic FM-AM Receiver (FM-AM tuner, audio control, 40-watt amplifier.)
- 1960 First complete stereophonic FM-AM receiver with 60-watt power amplifier.
- 1960 First stereophonic receiver to use the new, revolutionary Type-7591 power output tube. (Featured in the FISHER 800.)
- 1960 Smithsonian Institution, Washington, D.C., accepts for its collection America's first commercially manufactured high fidelity radio-phonograph, made by Avery Fisher in 1937.
- 1960 First reverberation device for use in high fidelity equipment. The Fisher Dynamic Spacexpander.
- 1960 First FM tuner with Microtune.
- 1960 First FM tuner with six I.F. stages.

(TABLE OF CONTENTS ON NEXT PAGE)

## THE FISHER CUSTOM ELECTRA V MODEL E46

### Stereophonic Radio-Phonograph

Advanced electronic engineering has been combined with old-world cabinet craftsmanship to create the new FISHER Custom *Electra* — a musical instrument that meets the most exacting criteria. Each unit in the *Electra* has been designed to meet the laboratory standards that distinguish all FISHER components. The unusually sensitive tuning sections can be used separately for the reception of monophonic FM or AM broadcasts, or simultaneously to receive FM-AM stereophonic broadcasts. The renowned Garrard Record Changer, containing a professional magnetic cartridge with a diamond stylus, will faithfully convey every musical nuance of your most treasured stereophonic or monophonic record selections. Located on the operating panel of the *Electra* are eight controls which will enable you to select any program source instantly, and adjust the volume and tonal characteristics of sound to your most critical listening tastes. Special connections are provided for the FISHER *Spacexpander* and the MPX-70 multiplex adaptor, and a new Automatic Shutoff switch has been included which will turn off the entire *Electra* automatically, after the last record has been played. Thirty-six watts of music power, free of all audible distortion, is supplied by a dual-channel Power Amplifier which can reproduce the most complex symphonic passage as easily as the softest notes of an oboe. Lastly, two acoustically-balanced speaker enclosures, each containing a three-way speaker system, provide the full orchestral sweep that only stereophonic sound makes possible.

Flawless circuitry, the use of costly, durable materials, and unhurried manufacture — essential ingredients that are often lost in mass production — all of these will contribute to years of trouble-free operation and your greater listening pleasure. These are the qualities that have for over two decades won for the FISHER a world-wide reputation.

### A NOTE ON STEREOPHONIC SOUND

The development of stereophonic sound has brought us close to achieving "Concert Hall" realism in the home. This dual-channel system offers a distinct advantage over monophonic (single-channel) systems by virtue of two important



audio characteristics: the dimensions of *direction* and *depth*. These live sound qualities are for the most part missing in monophonic systems because recordings are made and reproduced over a single channel. This is somewhat analogous to listening to music with one ear. Stereophonic recording techniques, however, utilize two separate banks of microphones which are positioned in the left and right sections of the orchestra. In this arrangement, the microphones receive the musical sounds in much the same manner as the two ears of a listener. The sound picked up by each bank of microphones is then fed to independent channels and recorded on disks or tape, or transmitted over separate channels of a stereophonic broadcast.

To reproduce a stereophonic recording or broadcast in the home, two separate sound channels are required. The stereophonic sound output of a record player, tape recorder or tuner is fed to two separate amplifier channels, which in turn drive two separate speaker systems. Thus, instruments located on the left and right sides of the orchestra are heard predominantly in the left and right speakers, respectively; while instruments located in the center appear to be heard mid-way between the two speaker systems. The result is a startling sense of *presence* heretofore realized only at a live orchestral performance.

## TABLE OF CONTENTS

	PAGE
INSTALLING THE ELECTRA	2
HOW TO USE THE CONTROLS	3
THE FM AND AM ANTENNAS	7
SERVICE NOTES	8

## INSTALLING THE ELECTRA

The Electra operates on *AC only*. Connect the power cable extending from the back of the cabinet to a wall outlet supplying 105 to 120 volts AC, at 50 to 60 cycles. Maximum power consumption is 165 watts. (Where line voltage is too high or too low, a step-down or step-up transformer will be necessary. For 50-cycle current, a special adaptor pulley is required for the Record Changer turntable. In each case, see your FISHER dealer).

Note: We suggest you read the information in this booklet carefully. Proper installation together with a good knowledge of the controls are essential for deriving the fullest enjoyment from your FISHER.

## The Record Changer . . .

During transit, the Record Changer is held in place with screws which are fastened to the base beneath the metal rim. These screws are identified by white tags and should be removed first. When this is done, the Changer will ride freely on springs which act as shock absorbers. Depress each side of the Changer to determine whether it rides freely on its spring mounts. If it does not move downward and back under hand pressure, consult your FISHER dealer.

To remove the V-Guard, simply grasp the "V" of the stylus assembly between the tips of the thumb and forefinger; pull gently to

remove the stylus assembly. To replace the V-Guard, grasp the "V" of the stylus assembly with the stylus point down, and slip into the cavity as far as it will go.

## The Antennas . . .

The *Electra* is equipped with two antennas, one to receive FM broadcasts and one for AM broadcasts. These should provide good reception in all cases except extreme fringe areas, or where special local conditions result in high signal loss. (Buildings constructed of steel girders, for example, can cause a loss of signal strength.) If reception is weak or poor, see the instructions on page 7 to rectify the condition.

## HOW TO USE THE CONTROLS

The operation of all controls is explained in this section. Referring to Figure 1 while reading will be helpful. If you wish to connect additional components to the sound system of the *Electra*, such as a Tape Recorder, for example, full information is provided on page 5. Before attempting to operate the Record Changer, read the instruction booklet accompanying this unit.

## AC and Volume . . .

The AC Switch, which supplies power to the *Electra*, is combined with the Volume Control. Turning this switch slightly clockwise until it clicks, turns on the power and lights the dial scale. Note: Make certain automatic shutoff switch is in the off position.

The Volume Control is used to adjust the level of sound for both channels. Turning this control in a clockwise direction will increase the volume simultaneously at both speaker systems.

Note: Although only stereophonic programs require the use of two speaker systems to achieve the necessary sound separation, the two speaker systems of the *Electra* are in operation for monophonic programs as well. This use of both systems provides a superior monophonic effect.

## Selector Switch . . .

This eight-position switch selects the program you wish to hear, whether a radio broadcast, a record selection, or some other program source you may have connected to the sound system of the *Electra*. The positions have the following functions:

PHONO MONO: Use this position to play

regular LP or 45 RPM records on the Record Changer. The stereophonic cartridge in the Tone Arm will accommodate monophonic as well as stereophonic records. In addition, all verticle rumble and noise characteristics of LP monophonic records will be completely eliminated, resulting in superior monophonic sound.

NOTE: To play 78 RPM records, a special cartridge is required. You can obtain one from your FISHER dealer.

PHONO STEREO: Play all stereophonic records in this position.

FM: This position selects the FM tuner for reception of FM broadcasts.

AM: This position selects the AM Tuner for reception of AM broadcasts.

FM-AM: In this position both Tuners are selected for the reception of a stereophonic FM-AM broadcast. The FM sound will be heard on the left speaker system; the AM on the right. (Consult your newspaper for the station to which each Tuner must be set.)

AUX MONO: Use this position to select any additional *monophonic* component you may have connected to the *Electra*—a monophonic tape recorder, record turntable, etc.



**MPX STEREO:** This position is used for the reception of FM multiplex stereo programs with the addition of the FISHER MPX-70 adaptor. A stereo tape recorder or other stereo sound source may be played through the *Electra* if multiplex reception is not desired.

### FM and AM Tuning . . .

The FM Tuning knob selects stations in the 87.5 to 108 megacycle band, while the AM Tuning knob selects stations in the 535 to 1620 kilocycle band. Turning either knob will move

the corresponding pointer along the dial scale to the station you wish to hear. A *logging scale*, numbering 0 to 100 is included on the dial glass between the FM and AM scales. By using this scale as a reference, you can tune in your favorite stations more easily — the numerical order is linear, and the gradations are equal.

### Bass and Treble Controls . . .

These controls permit you to adjust the tonal qualities of sound to your personal listening requirements. The Bass Control varies the intensity of the low frequency bass tones, while the Treble Control varies the intensity of the high frequency treble tones. Each Control varies the tones for both channels simultaneously. To increase or decrease bass or treble intensity, turn these knobs toward MAX or MIN, as desired.

To listen to program material exactly as it originates from a broadcasting studio, set these controls to NORMAL. This is "flat" position, and is equivalent to RIAA equalization. If you leave these controls at NORMAL while playing an LP or stereophonic record, RIAA equalization will be provided automatically. (A Tape Recorder is provided with NARTB equalization within its own circuitry. Leaving the Bass and Treble Controls in NORMAL position will maintain this equalization.) It should be remembered, however, that these controls may be set to any position dictated by personal listening preferences.

### Balance Control . . .

This control enables you to obtain equal sound levels from each speaker system. Balanced separation is important when you are listening to stereophonic program material, since each section of an orchestra must be heard in its true perspective; that is, neither section should come through any louder than it normally would in relation to the other.

With the Balance Control pointing to NORMAL, the volume at the left and right speaker systems should be the same. However, any slight imbalance that may exist — due to record characteristics, differences in room acoustics etc. — can be corrected with this control. Simply turn the knob slightly toward MAX A or MAX B to increase the volume at the left or right

speaker systems, as required. You can also use this control when you are listening to monophonic program material, since both speaker systems are also in use. In this case, of course, balanced sound output is not very critical.

It should be pointed out that the Balance Control is *not* a volume control; for, as the level of sound is increased on one speaker system, it is decreased on the other, maintaining approximately the same overall sound output. (NOTE: you can cut off the sound at either loudspeaker system by moving the control to its extreme MAX A or MAX B position.)

### Automatic Shutoff . . .

In order to use the automatic shutoff feature, the AC Power switch on the control panel must first be turned ON. Then by turning the Automatic Shutoff switch to ON, the entire *Electra* will be turned off after the last record has been played, and will be turned on again as soon as the Changer is once more put in operation. This feature may be defeated by turning the switch to OFF. *Be sure to leave this switch OFF when not using the Record Changer, or the Electra will be inoperative.*

## CONNECTING ADDITIONAL COMPONENTS TO THE SOUND SYSTEM OF THE ELECTRA

In addition to listening to radio broadcasts and playing the Record Changer, you can connect other program sources to the sound system of the *Electra*. These can include the sound from your TV set, the FISHER *Spacexpander* and MPX-70 multiplex adaptor, or a stereo tape recorder (if multiplex reception is not desired). The information that follows describes how to connect additional equipment, and also gives the necessary control settings for proper operation. The input and output jacks to which connections are made are located on the Tuner and Amplifier chassis, as illustrated in Figures 2 and 3.

### Tape Recorder . . .

A monophonic tape recorder may be played through the *Electra* by connecting the recorder output to the AUX MONO jack on the Tuner-Control chassis. You can record a program from the *Electra* by connecting the tape recorder input jack to the Channel A or B RCRDR OUTPUT jack on the same chassis.

A stereo tape recorder may be used if the MPX-70 multiplex adaptor is not installed in your *Electra*. In this case, connect the MPX INPUT jacks on the *Electra* to the recorder outputs, and the RCRDR OUTPUT jacks on the *Electra* to the recorder inputs. Be sure you do not reverse the channels when making these connections. To play back your tapes through the sound system of the *Electra*, turn the Selector switch to MPX STEREO.

### Multiplex Stereo . . .

FM multiplex is a new method of transmitting stereo broadcasts over a single FM station. In

order to receive multiplex programs in stereo sound, the FISHER MPX-70 must be added to the *Electra*. Without the addition of the MPX-70, you will hear multiplex programs monophonically, just as ordinary FM broadcasts. To install the MPX-70, simply follow these four steps:

- 1 — Mount the MPX-70 with the four screws provided.
- 2 — Connect the MPX OUTPUT on the Tuner-Control chassis of the *Electra* (see Figure 2) to the INPUT jack of the MPX-70 with the three-foot cable supplied.
- 3 — Connect the Channel A and Channel B OUTPUT jacks of the MPX-70 to the corresponding MPX INPUT jacks on the Tuner-Control chassis of the *Electra*. Two cables are supplied for this purpose.
- 4 — The power cable of the MPX-70 should be connected to the special MPX CONNECTOR jack on the Tuner chassis.

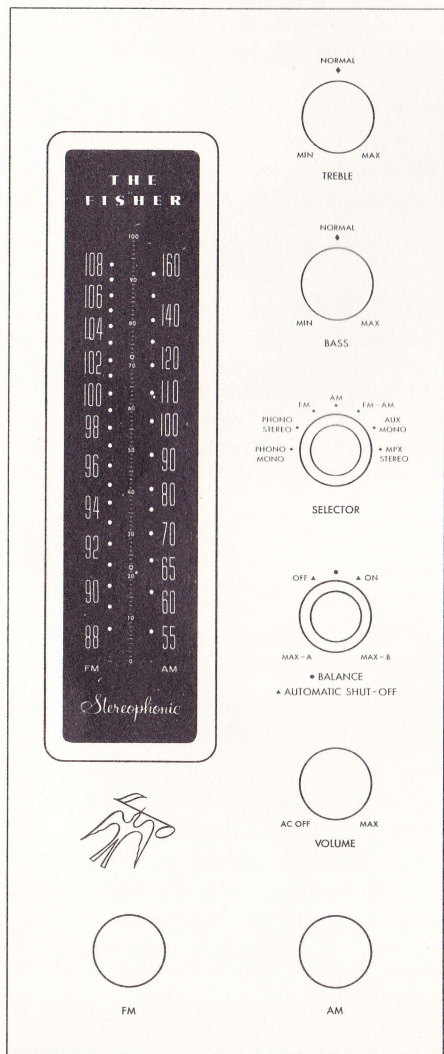
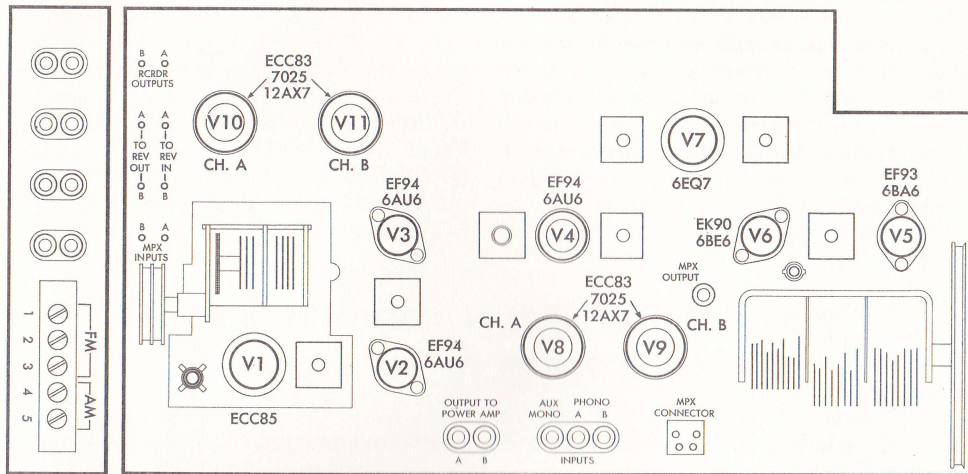

Figure 1. Front Panel Of The Electra.





AW # 1905

Figure 2. Rear View Of The Tuner-Control Chassis.

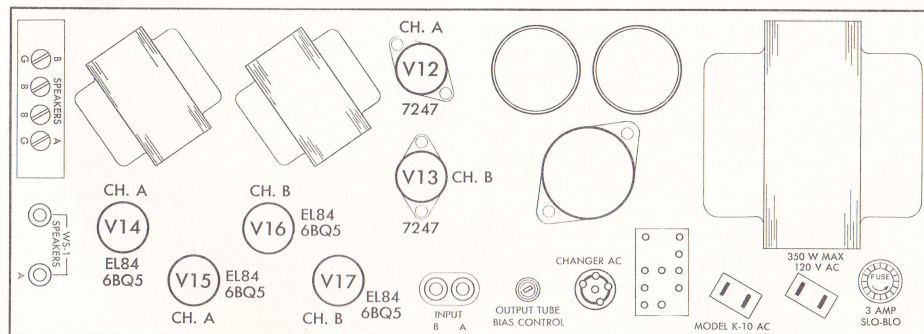

AW # 1903

Figure 3. Top View Of The Power Amplifier Chassis.

## TV Sound . . .

Because television receivers differ widely in circuit design, it is advisable to consult your serviceman before attempting to connect the sound output of your TV set to the sound system of the *Electra*. However, once the method of connection had been determined, the cable from the TV set should be connected to the AUX MONO input jack on the side of the Tuner chassis. Set the Selector Switch to AUX MONO and adjust the audio controls as desired.

## WS-1 Speakers . . .

Jacks are provided on the Amplifier chassis of the *Electra* for the connection of two FISHER WS-1 Speakers as adjuncts to the two speaker systems. With the addition of the WS-1 system, the stereophonic as well as monophonic sound pattern can be augmented to a startling degree. Simply connect the WS-1 cables to the WS-1 jacks. Place the speaker connected to the A jack on the left side of the room, and the speaker connected to the B jack on the right

side of the room, (as viewed from the listening area.)

## Spacexpander . . .

Special *Spacexpander* jacks are located on the Tuner-Control chassis for the connection of this revolutionary new reverberation device. Remove the jumper plugs before installing the *Spacexpander* and store in a safe place for possible future use. Then make the following connections:

- 1 — TO REV OUT A jack on the *Electra* to the Channel A Output jack on the *Spacexpander*.
- 2 — TO REV OUT B jack on the *Electra* to the Channel B Output jack on the *Spacexpander*.
- 3 — TO REV IN A jack on the *Electra* to the Channel A Input jack on the *Spacexpander*.
- 4 — TO REV IN B jack on the *Electra* to the Channel B Input jack on the *Spacexpander*.

NOTE: If the *Spacexpander* is not connected to these jacks, the jumper plugs must be inserted, or the *Electra* will be inoperative.

## THE FM AND AM ANTENNAS

Separate FM and AM antennas are supplied with the *Electra* for the two types of radio reception. These antennas should be adequate in all cases except extreme fringe area conditions. If reception is weak, the connection of a roof antenna may be necessary to increase the strength of the radio signals. The following information refers to the Antenna Terminal strip at the rear of the Tuner chassis (see Figure 2).

### FM Antenna . . .

A folded dipole antenna for FM reception is stapled to the rear of the cabinet along the edges. The leads from this antenna are connected to FM terminals 2 and 3. To increase

signal strength, remove these two leads and connect the leads from a roof antenna in their place (see Fig. 4). Consult your serviceman about a proper FM antenna for your area.

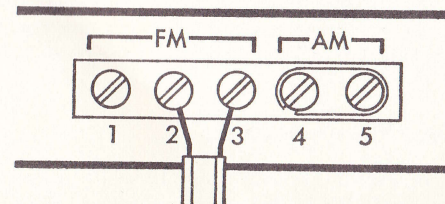

Figure 4. Antenna connections (dipole or roof type) for normal or fringe signal areas.

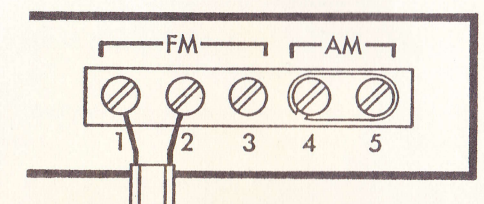

Figure 5. FM Antenna connections for strong signal areas.



NOTE: In areas where reception is too strong, the signal may overload the Tuner input circuit. To cut down on excessive signal strength, transfer the leads of the FM antenna to FM Terminals 1 and 2. (See Fig. 5.)

### AM Antenna . . .

The built-in Ferrite Loop Antenna that provides AM reception is connected to the AM Tuner when the metal link connects AM Terminals 4 and 5. If reception is weak on some stations because of fringe area conditions, a roof antenna will provide greater signal

strength. Disconnect the link from Terminal 4 and connect the AM roof antenna to this terminal, as shown in Fig. 6.

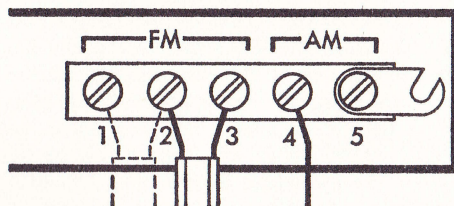

Figure 6. AM Roof Antenna connections (link disconnected.)



## SERVICE NOTES

### Bias Adjust Control . . .

The control on the Power Amplifier chassis marked OUTPUT TUBE BIAS ADJUST is used to maintain the proper operating voltage on the power output tubes. The procedure for the adjustment of this control is contained in the Service Manual for the *Electra*. This control should be adjusted only by a qualified service man.

### Cleaning the Dial Glass . . .

The dial glass can be removed for cleaning purposes by following these simple steps:

- 1—Remove all of the control knobs from the front panel by pulling them up.
- 2—Remove the screws from the wooden panel, then lift off the panel.
- 3—Loosen the screws that retain the clips to the dial glass, swing the clips aside, then lift off the glass. (When you replace the dial glass, make certain it is set in the same position it

occupied before removal.)

4—Remove dust with a dry cloth. For more thorough cleaning, use a soap and water solution *only*. If you use any stronger cleaning agent, you may damage the markings on the glass.

### At Your Service . . .

It is our desire that THE FISHER operates to your complete satisfaction. We solicit your correspondence on any special problems that may arise. After you have had an opportunity to familiarize yourself with THE FISHER, we would appreciate hearing from you concerning how it is meeting with your requirements.

### Your Fisher Dealer . . .

Be sure to consult your FISHER dealer promptly if any defect is indicated. Your FISHER dealer stands ready to assist you at any time.

## Warranty To Owner

**THE FISHER** equipment you purchased was carefully tested and inspected before leaving our laboratories. If properly installed and operated in accordance with the instructions furnished, it should give you the finest results of which it is capable. This equipment is unconditionally guaranteed against all defects in material and workmanship for ninety days from date of sale to the original purchaser. Any part of the equipment which under normal installation and use, discloses such a defect, will be adjusted or replaced by the dealer from whom purchased. This guarantee is void if the equipment has been altered, or if the purchaser has failed to return the Warranty Card *within 10 days*.

**FOR WARRANTY SERVICE, CONSULT YOUR DEALER**



## The Man Behind the Product

AVERY FISHER  
Founder and President,  
Fisher Radio Corporation

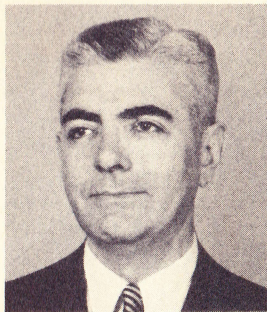

**T**WENTY-THREE YEARS AGO, Avery Fisher introduced America's first high fidelity radio-phonograph. That instrument attained instant recognition, for it opened a new era in the faithful reproduction of records and broadcasts. Some of its features were so basic that they are used in all high fidelity equipment to this day. One of these models is now in the permanent collection of the Smithsonian Institution as an example of the earliest high fidelity instruments commercially available in this country.

The engineering achievements of Avery Fisher and the world-wide reputation of his products have been the subject of descriptive and biographical articles in *Fortune*, *Time*, *Pageant*, *The New York Times*, *Life*, *Coronet*, *High Fidelity*, *Esquire*, *The Atlantic*, and other publications. Benefit concerts for the National Symphony Orchestra in Washington and the Philadelphia Orchestra, demonstrating recording techniques, and the great advances in the art of music reproduction, used FISHER high fidelity instruments both for recording and playback, to the enthralled audiences. FISHER equipment formed the key part of the high fidelity demonstration at the American National Exposition in Moscow, July 1959. FISHER FM and FM-AM tuners are the most widely used by broadcast stations for monitoring and relay work, and by research organizations—under conditions where absolute reliability and maximum sensitivity are a 'must.'

The FISHER instrument you have just purchased was designed to give you many years of pride and enjoyment. If you should desire information or assistance on the performance of your FISHER, please do not hesitate to write directly to Avery Fisher, President, Fisher Radio Corporation, Long Island City 1, New York.

The adjustment of this control is contained in the Service Manual for the *Electra*. This control should be adjusted only by a qualified service man.

### Cleaning the Dial Glass . . .

The dial glass can be removed for cleaning purposes by following these simple steps:

- 1—Remove all of the control knobs from the front panel by pulling them up.
- 2—Remove the screws from the wooden panel; then lift off the panel.

- 3—Loosen the screws that retain the clips to the dial glass, swing the clips aside, then lift off the glass. (When you replace the dial glass, make certain it is set in the same position it

### At Your Service . . .

It is our desire that THE FISHER operates to your complete satisfaction. We solicit your correspondence on any special problems that may arise. After you have had an opportunity to familiarize yourself with THE FISHER, we would appreciate hearing from you concerning how it is meeting with your requirements.

### Your Fisher Dealer . . .

Be sure to consult your FISHER dealer promptly if any defect is indicated. Your FISHER dealer stands ready to assist you at