



# THE FISHER

30-Watt

## AUDIO AMPLIFIER

INSTALLATION AND  
OPERATING INSTRUCTIONS

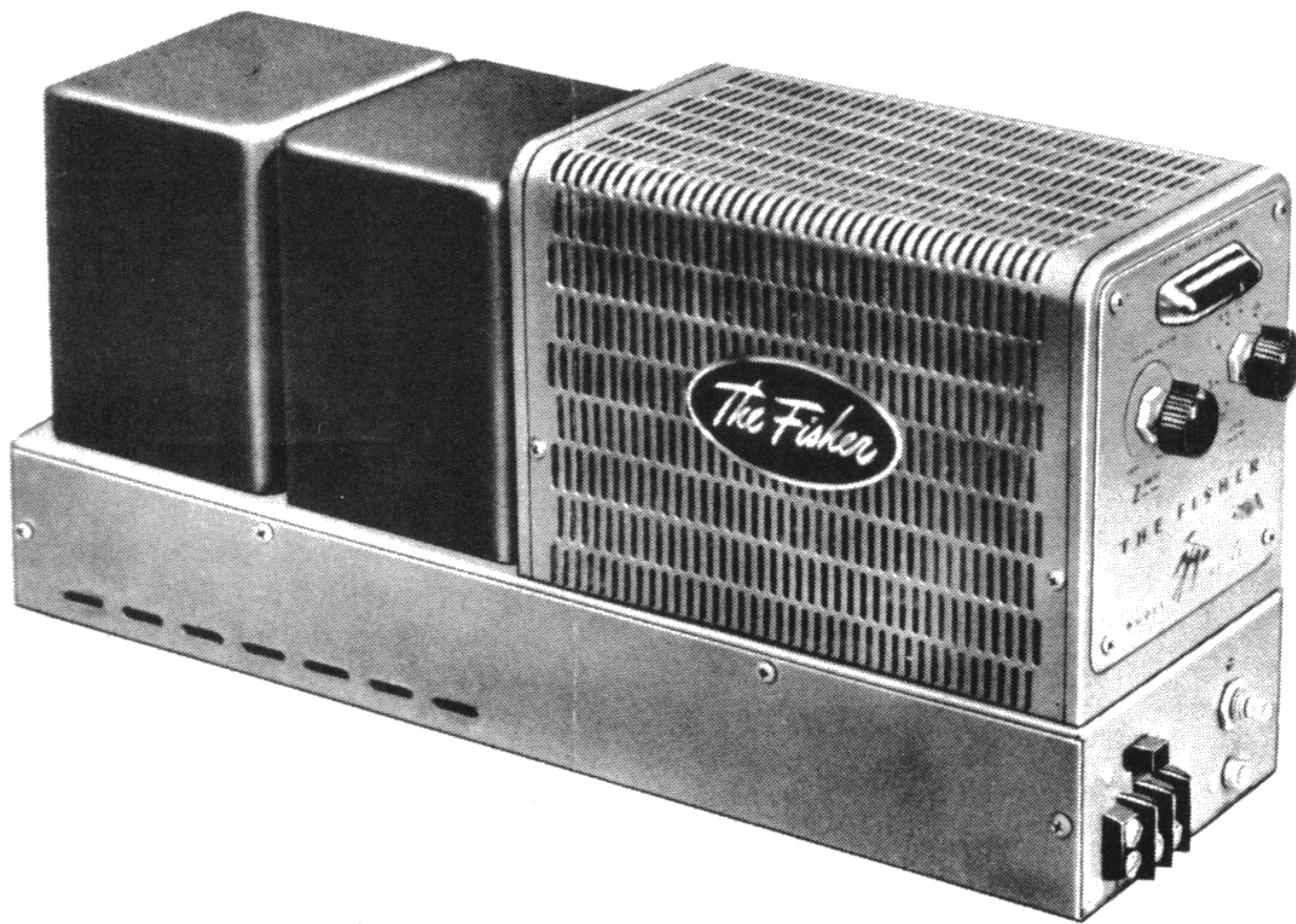

MODEL 80-AZ

PRICE: \$1.00

FISHER RADIO CORPORATION • NEW YORK



# THE FISHER



## 30-Watt AUDIO AMPLIFIER

MODEL 80-AZ

### GENERAL INFORMATION

THE FISHER Audio Amplifier, Model 80-AZ, will meet the requirements of the most exacting user. Complete fidelity of reproduction and absence of listener fatigue are a direct result of the extremely low harmonic and intermodulation distortion at all power levels, as well as excellent transient response, wide frequency range and good linearity. Hum and noise are virtually non-measurable, thus allowing operation at all listening levels without the distraction of extraneous noise. The great reserve power handling capacity of the Model 80-AZ makes it capable of reproducing the complete dynamic range even of a full symphony orchestra. All components in this compact unit have been selected for long life and installed with maximum accessibility in mind, for easy servicing.

The Model 80-AZ has three separate feedback loops, resulting in low internal impedance, extremely low distortion and excellent transient response. Two type EL-37 tubes, connected as tetrodes, are employed in the power stage. The unique cathode feedback circuit offers all the advantages of triode performance, together with efficiency of tetrodes. The carefully designed output transformer consists of fifteen interleaved windings in conjunction with a grain-oriented steel core, assuring the finest results.

THE FISHER Model 80-AZ may be used directly with an FM-AM tuner, such as THE FISHER Model 80-T, a crystal phonograph cartridge or any other device which is capable of producing a one-volt signal. Where magnetic phonograph cartridges, microphones or similar low-level devices are employed, pre-amplification is necessary. Especially suited to these latter applications is THE FISHER Master Audio Control, Series 80-C, available as a companion unit to THE FISHER Model 80-AZ.

### SPECIFICATIONS

**HIGH OUTPUT**, with less than  $\frac{1}{2}\%$  distortion at 30 watts (less than 0.15% at 25 watts; less than 0.05% at 10 watts.)

**INTERMODULATION DISTORTION** less than  $\frac{1}{2}\%$  at 25 watts and less than 0.2% at 10 watts; see FIGURE 1.

**FREQUENCY RESPONSE** is uniform within 0.1 db from 20-20,000 cycles and is within 1 db from 10-50,000 cycles; see FIGURE 2.

**POWER OUTPUT** is constant within 1 db at 30 watts from 15-35,000 cycles; see FIGURE 3.

**HUM AND NOISE** level is better than 95 db below full output.

**FIGURE 1. INTERMODULATION DISTORTION**  
(MEASURED AT 60/3000 CYCLES, AT 4 TO 1)

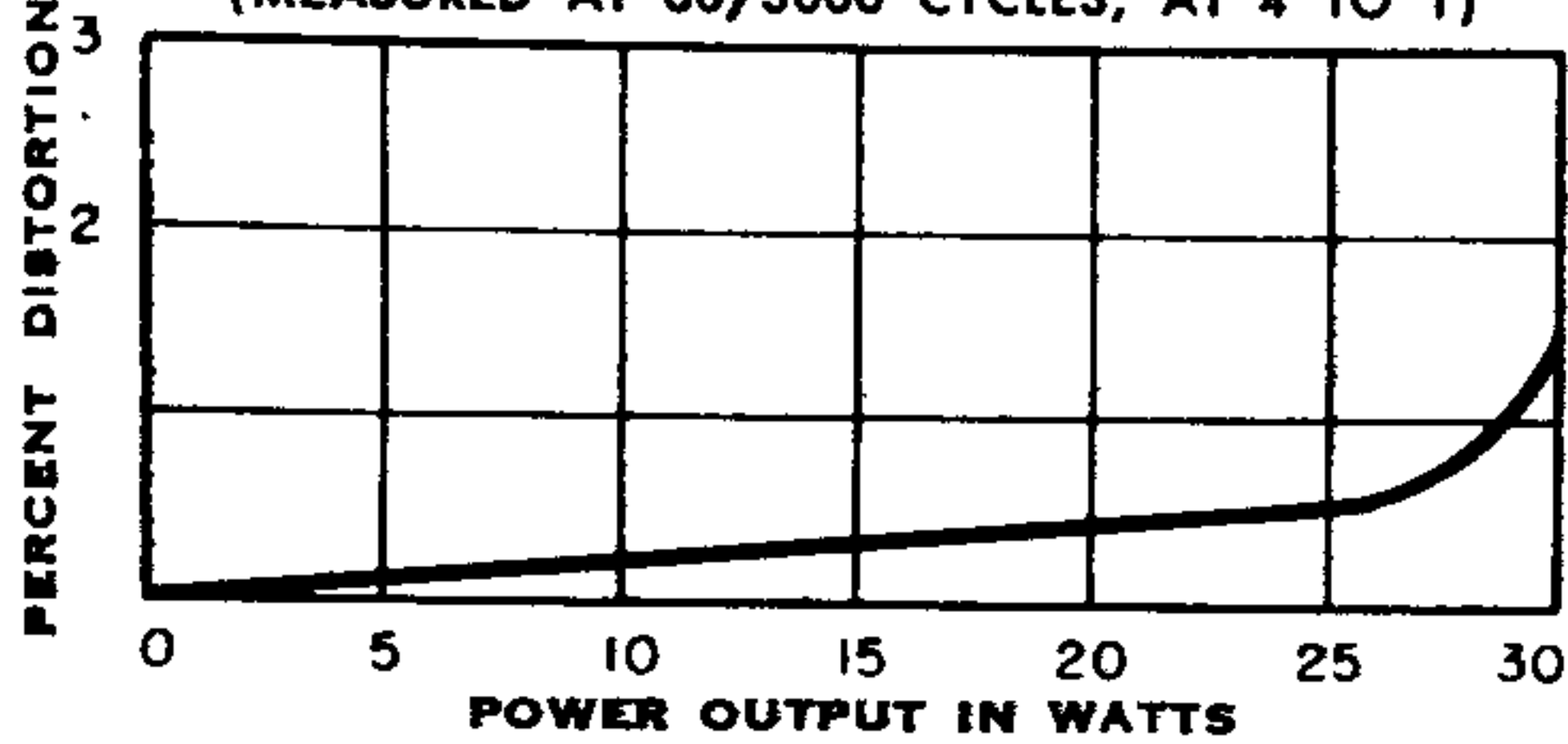

**FIGURE 2. FREQUENCY RESPONSE**

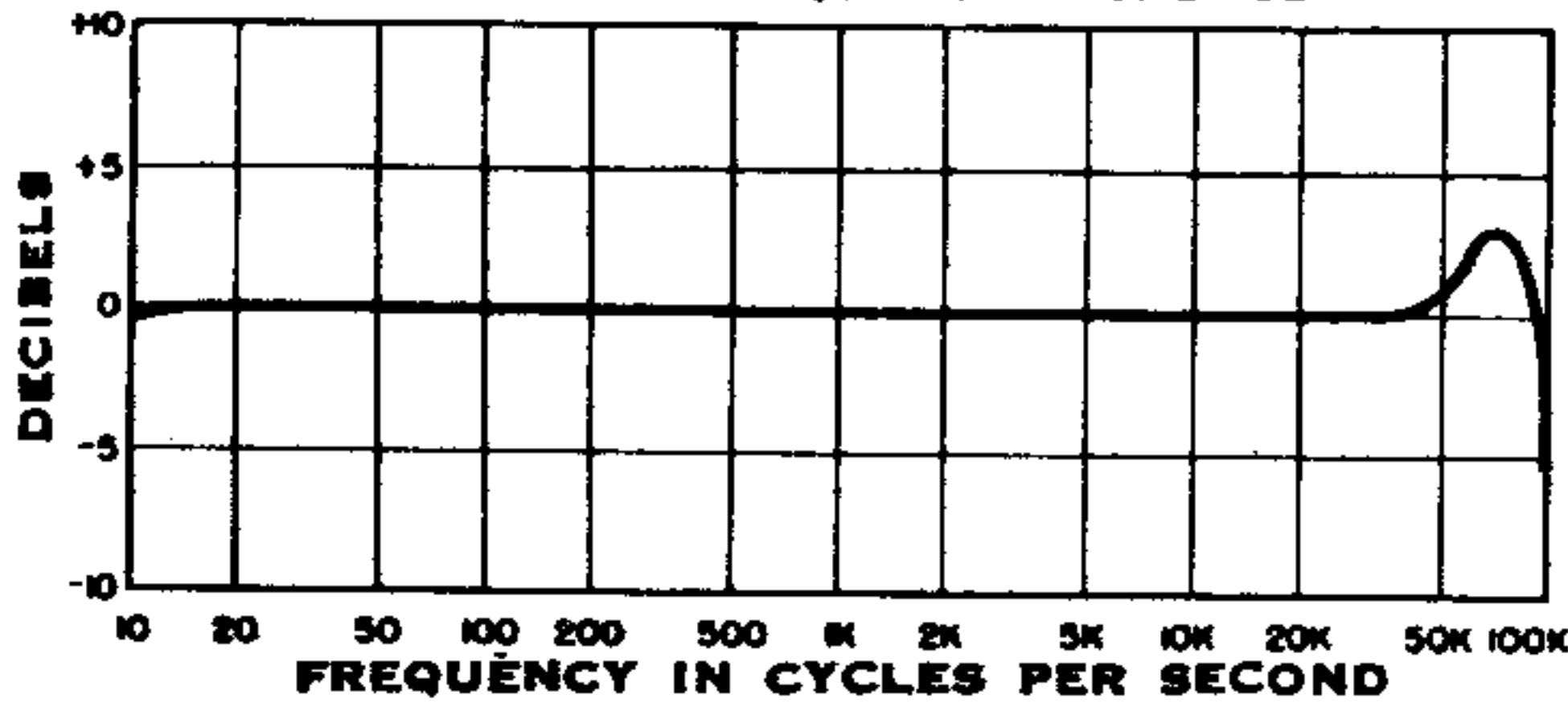

**FIGURE 3. POWER RESPONSE**  
(MEASURED AT 25 AND 30 WATTS OUTPUT)

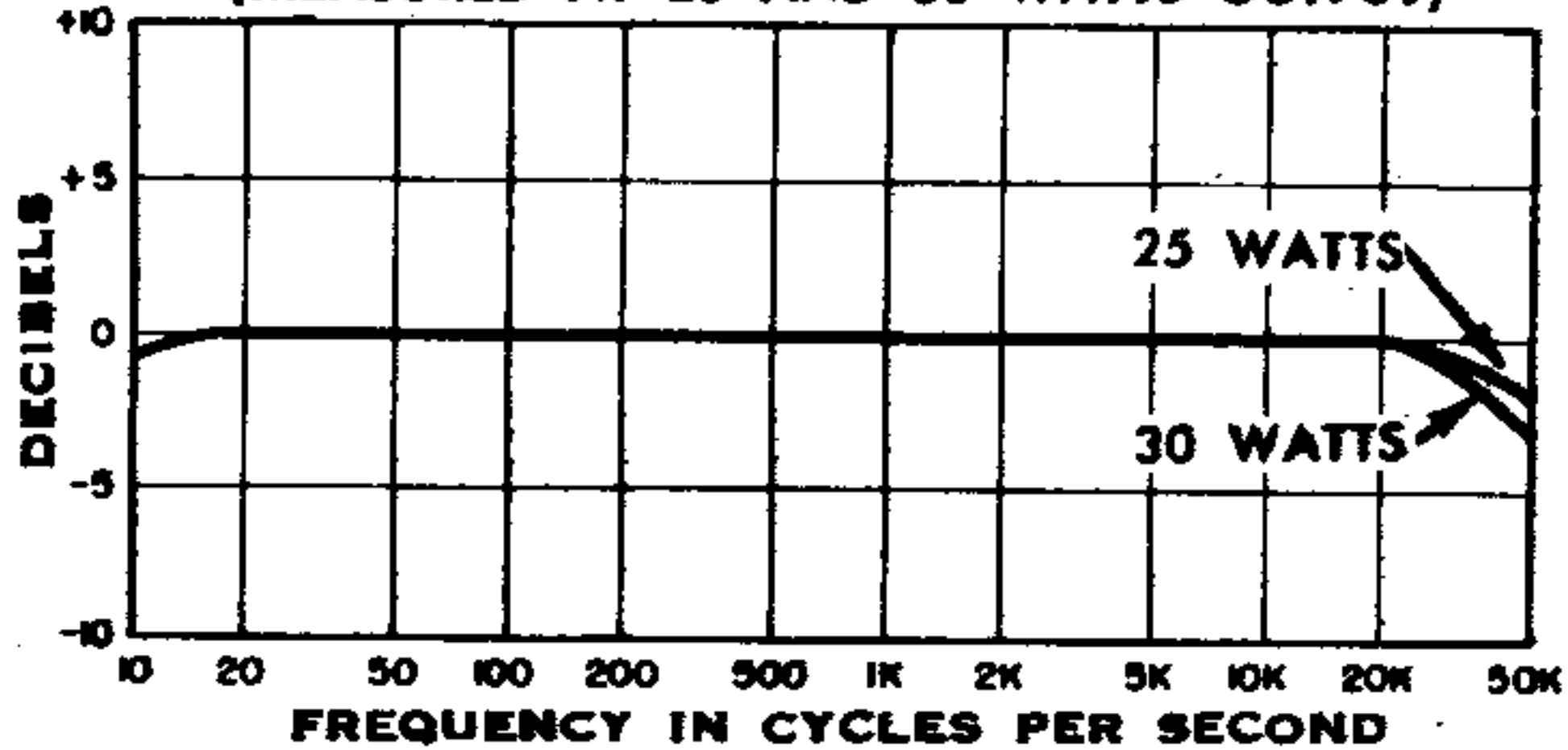

**FIGURE 4. PHASE RESPONSE CHARACTERISTIC**

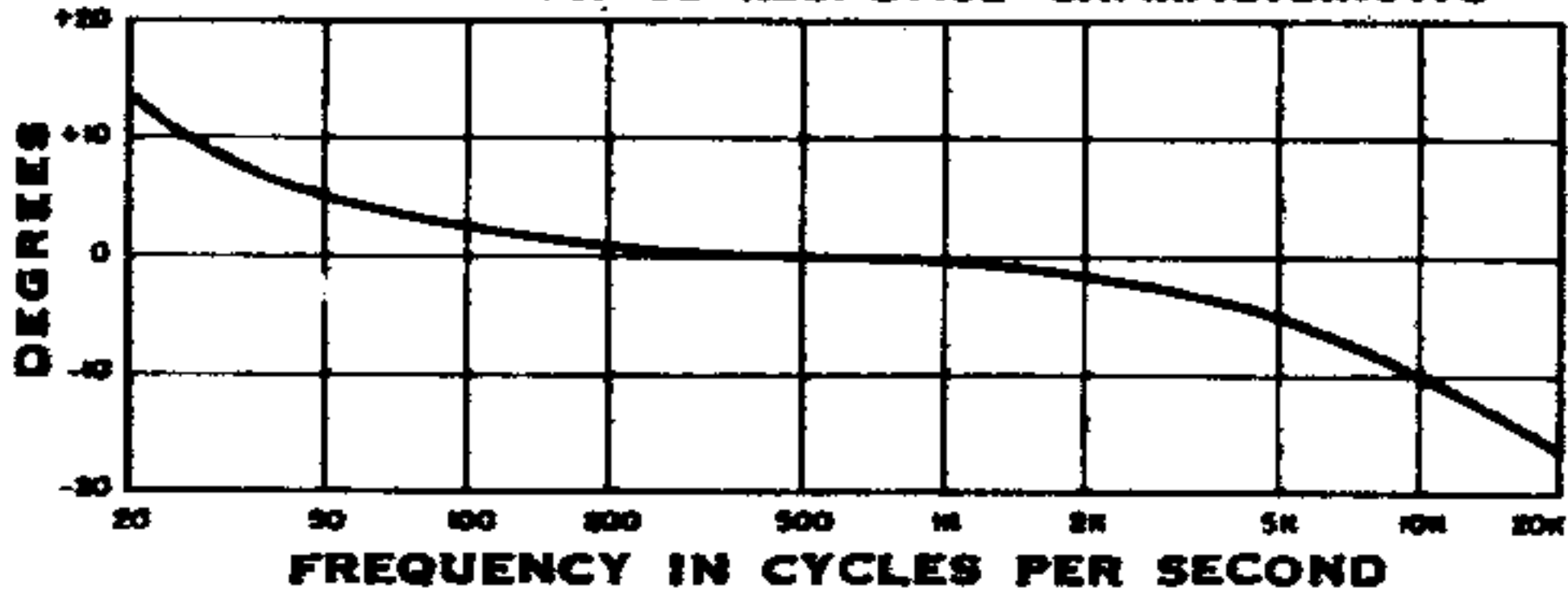

**FIGURE 5. LINEARITY RESPONSE — INPUT VS. OUTPUT**

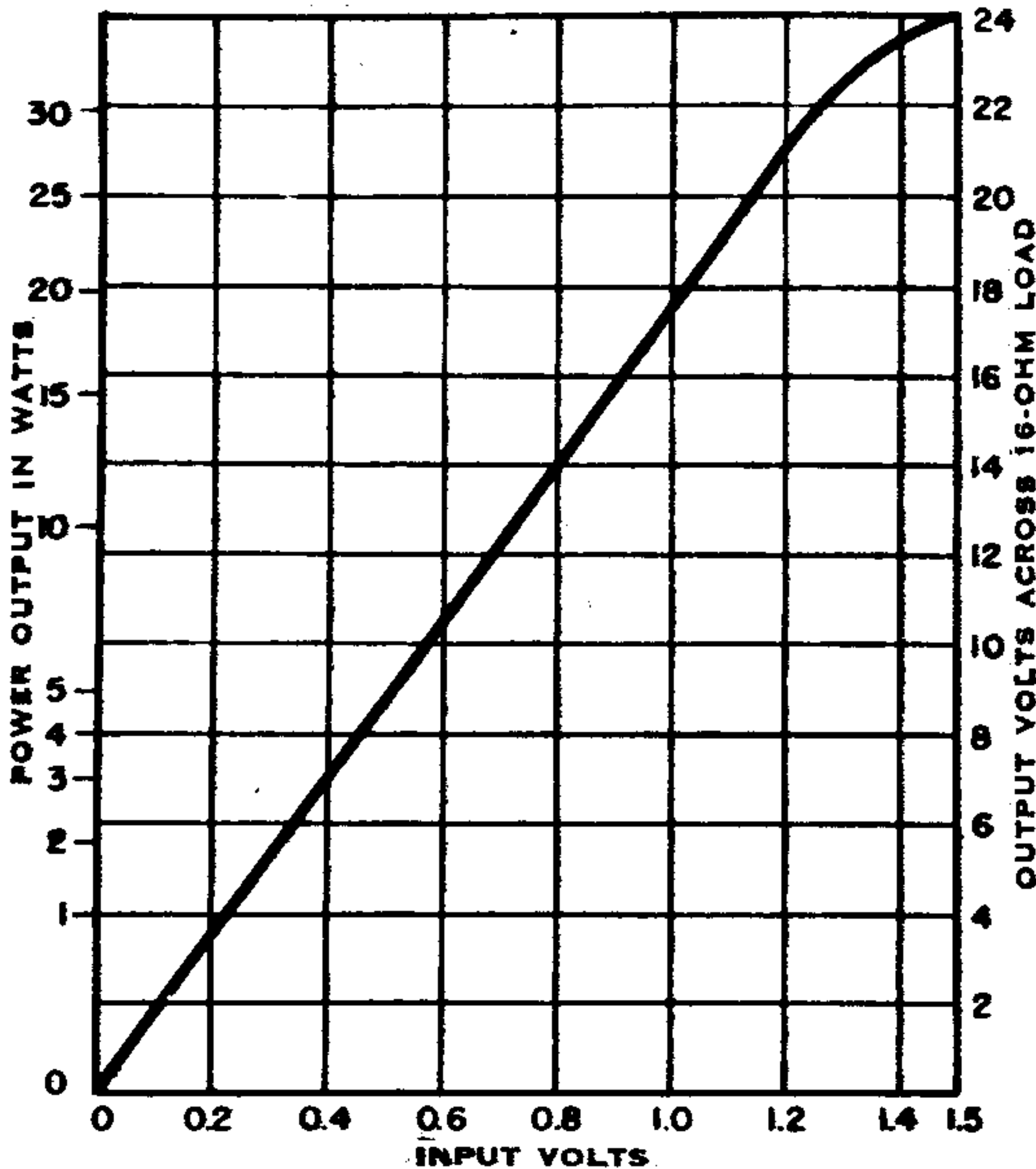

INTERNAL IMPEDANCE with Z-MATIC Control counterclockwise is 0.61 ohms for 16-ohm operation, giving a damping factor of 26.

PHASE SHIFT is less than  $15^\circ$  at 20 cycles and less than  $18^\circ$  at 20,000 cycles; see FIGURE 4.

LINEARITY RESPONSE (input versus output) is plotted in FIGURE 5.

The entire amplifier and power supply are built on one compact, steel chassis, thus simplifying installation. Handsome, professional styling includes a two-tone baked enamel brown metallic finish, a brushed-brass control panel and an attractive perforated cover which protects the tubes and adds to the overall distinguished appearance of this amplifier.

TUBE COMPLEMENT: 1-12AT7 (Voltage Amplifier/Phase Inverter,) 1-12AU7 (Push-pull Driver,) EL-37 (Power Output,) 1-5V4G (Rectifier,) 1-NE-51 (Voltage Regulator.)

OUTPUT IMPEDANCES: 4, 8 and 16 ohms. Instantly accessible fuse.

SIZE:  $4\frac{1}{4}$ " deep,  $15\frac{1}{2}$ " wide,  $6\frac{7}{8}$ " high.

SHIPPING WEIGHT: 22 pounds.

### THE FISHER Z-MATIC CONTROL

The loudspeaker system has long been recognized as one of the most important limiting factors in the faithful reproduction of high fidelity sound. Where a loudspeaker bears the typical specification — "Voice Coil Impedance: 16 ohms" — it should be noted that this specification really applies only to a *limited portion* of the total frequency range. The reason is that a speaker voice coil impedance actually varies quite markedly, and according to the particular point of the audible spectrum involved. Thus, a typical 12" speaker rated at 15 ohms actually has that 15-ohm impedance at 400 cycles. At 35 cycles the voice coil impedance could be anywhere from 60 to 90 ohms, and at 10,000 cycles from 30 to 50 ohms. See FIGURE 6.

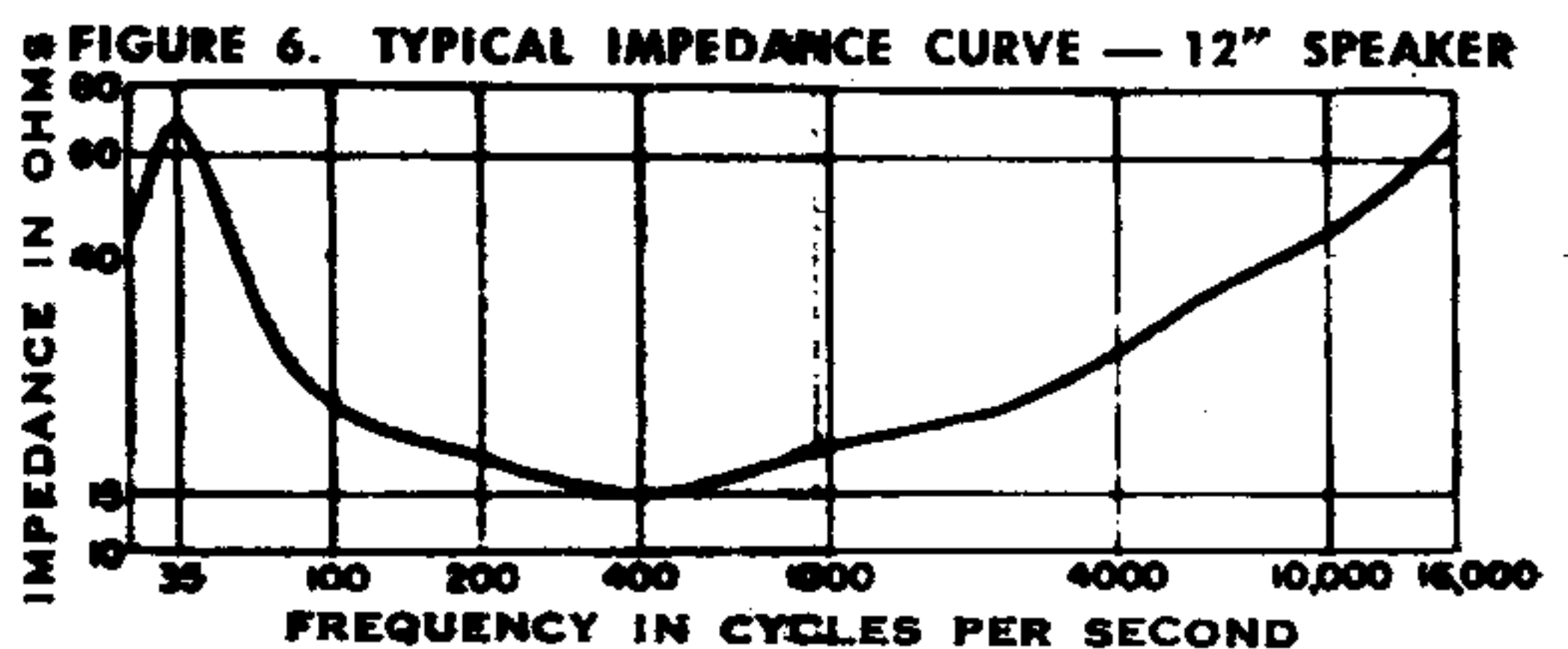

The steep rise in voice coil impedance in the 40-to-100 cycle region is particularly serious, for it is exactly in this portion of the audible spectrum that we need a good impedance match between voice coil and amplifier in order to reproduce with full richness such instruments as the tympanum, bass viol, cello, organ, and the bottom octave of the piano. The rise in voice coil impedance at the high end decreases treble response.

All typical amplifiers of better quality built today have not taken the above impedance matching problem into account. Thus, although the electrical characteristics of the signal up to the voice coil may have a uniform response, this is



promptly affected by the impedance variations of the loudspeaker system. Although the VOLTAGE delivered to the loudspeaker remains constant regardless of frequency, the POWER absorbed by the loudspeaker will *not* be constant because power is a function of both the applied voltage *and* the load resistance.

As an example, let us assume that a 440-cycle tone (Middle A on the piano) is introduced to the loudspeaker. At this frequency the voice coil impedance is actually 16 ohms, as specified by the speaker manufacturer. Let us assume further that the voltage reaching the voice coil is 4 volts. Under these conditions electrical power will be 1 watt. Let us now attempt to reproduce an organ tone 3 octaves lower (55 cps) and of equal intensity. The impedance of the loudspeaker at this frequency would in this case be about 64 ohms (and in many cases loudspeakers have even higher voice coil impedances as one approaches their resonant frequency.) Inasmuch as power, for a constant voltage, varies inversely with the load impedance, the result is that only  $\frac{1}{4}$  of 1 watt of power will actually be absorbed and utilized by the speaker on the aforementioned organ tone.

It therefore follows that the ideal goal is to produce an amplifier containing special circuits that recognize the non-uniform impedance of loudspeakers and provide the means of eliminating this inherent mismatch. We are proud to announce that this long-sought-after goal has now been reached in FISHER Amplifiers. These special circuits are what comprise THE FISHER Z-Matic Control.

THE FISHER Z-Matic circuits will not only supply *constant* power to a loudspeaker *regardless* of its load impedance but, further, will at the mere turn of a control knob provide *additional* compensation to balance the deficiencies of the loudspeaker or its enclosure.

#### WHAT THE FISHER Z-MATIC CONTROL DOES

The unusual circuitry of THE FISHER Z-Matic Control *automatically* corrects the impedance mismatch condition described earlier. The Z-Matic Control is continuously variable and can be set at any desired point to suit the requirements of the particular program being reproduced, as affected by the existing speaker

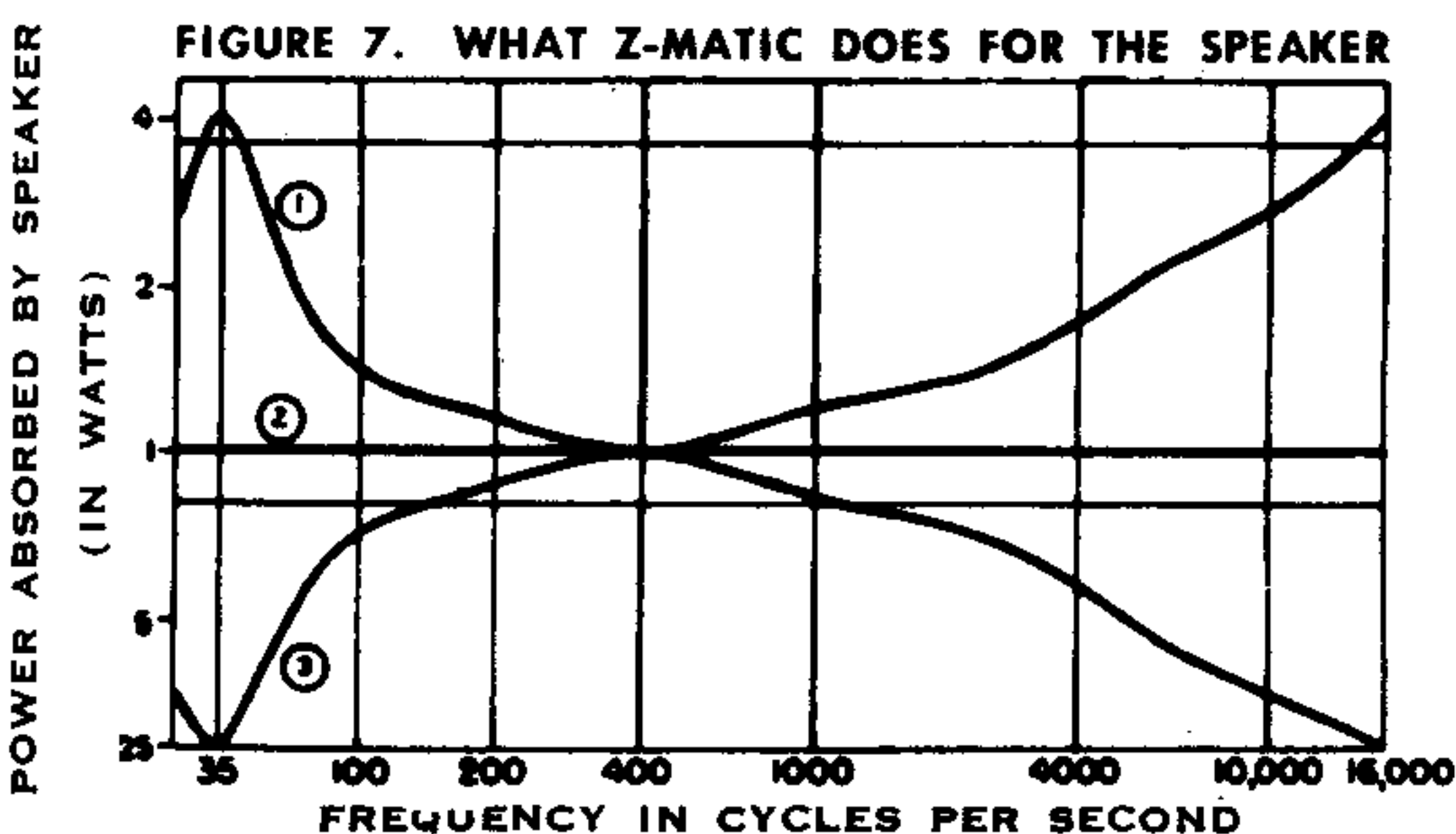

- WITH Z-MATIC CONTROL AT:
- 1: MAXIMUM SETTING
  - 2: MID-POSITION
  - 3: MINIMUM SETTING (OPERATING AS A CONVENTIONAL AMPLIFIER)

system, speaker enclosure — in fact, the entire electrical and acoustical system. See FIGURE 7.

The Z-Matic Control *automatically* makes the corrections for varying load impedance *to the exact degree desired by the user* to meet his particular acoustic and environmental conditions. The results are truly revolutionary and thrilling to hear, for Z-Matic opens a wide, new door on high fidelity sound reproduction.

**IMPORTANT NOTE:** THE FISHER Z-Matic Control does what an ordinary Bass Tone Control, or Loudness Balance Control, *cannot* do. The Z-Matic Control restores to full intensity only *those* tonal frequencies that suffered attenuation because of speaker system characteristics. For this reason, no "barrel" bass is created. Proof of this desirable achievement is instantly apparent on listening to the male speaking voice, the most usual source of "barrel" bass.

### THE FISHER PEAK POWER INDICATOR

The problem of adequate power necessary to reproduce the full dynamic range of music and speech has long occupied the study of audio engineers and hobbyists alike. Very often, loudspeakers capable of handling thirty or more watts are driven by amplifiers rated at only ten or twelve watts. Conversely, and with more serious consequences, a high-powered amplifier is often used in combination with loudspeakers whose voice-coil wattage ratings may be considerably below the full power output of the amplifier. Such a combination often results in permanent and irreparable damage to the loudspeaker. THE FISHER PEAK POWER INDICATOR eliminates the possibility of such damage. The user can, at a glance, determine the peak power being absorbed by the voice-coil of the loudspeaker. Peak power, in this case, refers to the instantaneous power. By means of a simple control and visual indicator, it is possible to make certain that this power never exceeds the specified maximum rating of the loudspeaker.

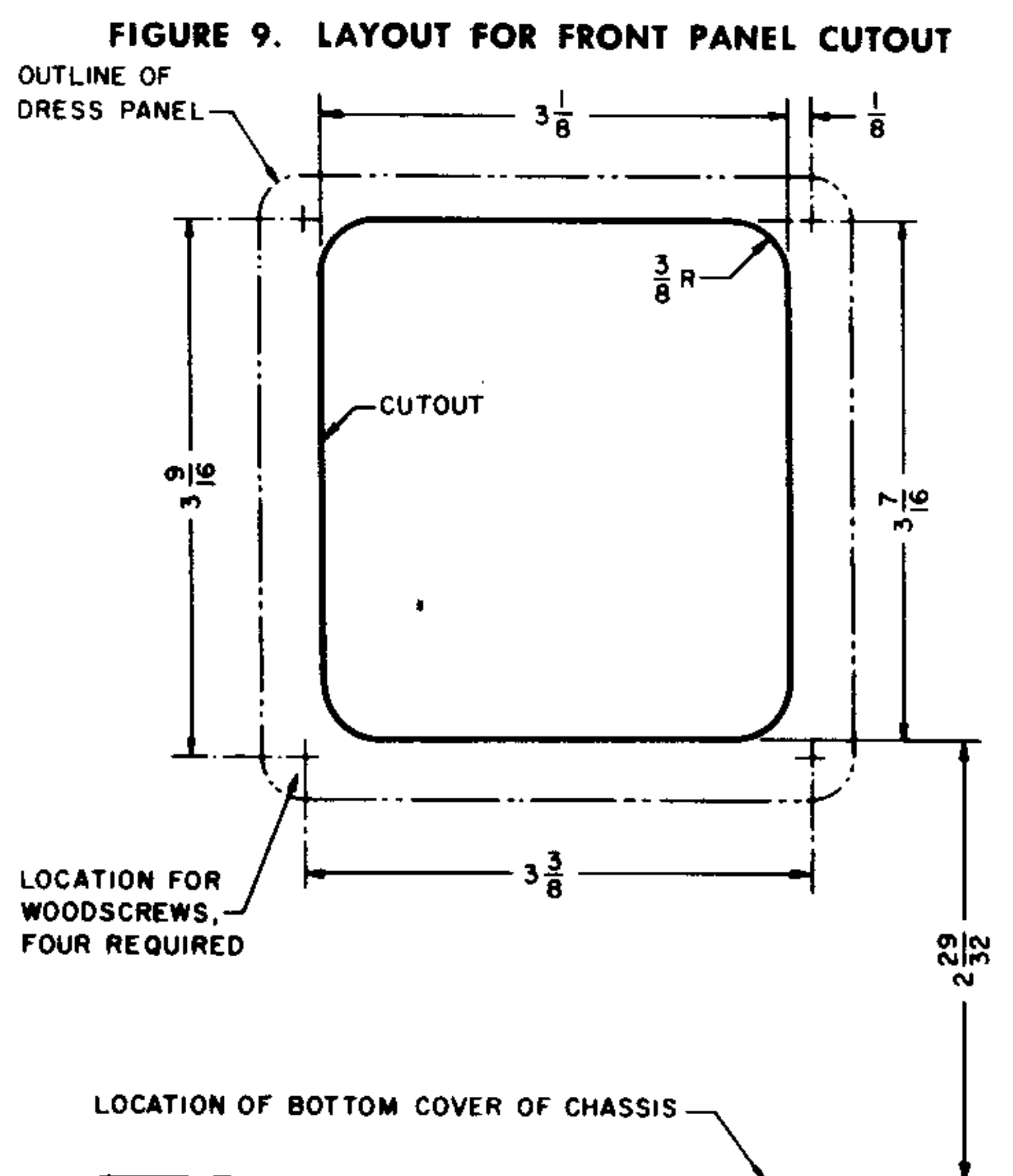

## INSTALLATION

Since THE FISHER Model 80-AZ is designed for use as a basic amplifier it can be installed wherever there is adequate ventilation. Chassis mounting dimensions are shown in FIGURE 8. THE FISHER Model 80-AZ power line cord should be connected to an auxiliary AC receptacle working off a master switch. Thus the amplifier is turned on together with the tuner or preamplifier used. An auxiliary AC receptacle is located on the rear apron of the chassis for connection of the power cord of any auxiliary equipment such as a tuner or record changer. The power from this receptacle should never exceed 350 watts. THE FISHER Model 80-AZ requires 170 watts at 105-125 volts, 50-60 cycles AC.

FIGURE 8.

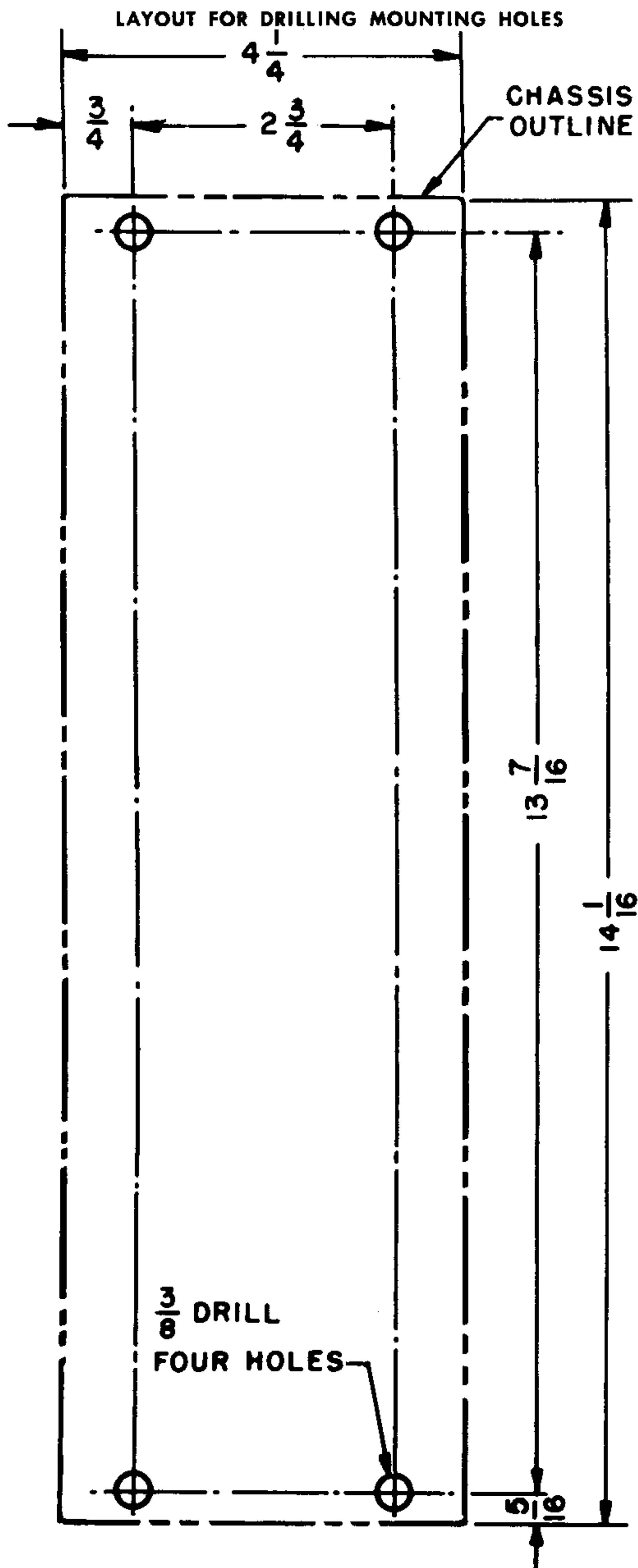

If THE FISHER Model 80-AZ is to be mounted in a cabinet behind a panel, access to the Z-MATIC Control and PEAK POWER INDICATOR may be had as follows:

1. Remove the four brass Phillips Head screws from the brass designation panel.
2. Carefully move the brass panel together with its controls and indicator away from the front of the amplifier chassis.
3. Orient the chassis in its final location behind the panel. (The long dimension of the chassis can be oriented either from front to back or from left to right in the cabinet.) Make a cut-out in the wood or metal mounting panel in accordance with FIGURE 9.
4. Pass the brass panel through the cut-out from the rear and screw it to the mounting panel by means of suitable #4 wood screws (or machine screws, where a metal panel is used.)
5. You may find it desirable to separate the chassis from the brass designation plate by a distance greater than the existing wiring permits. In this case, simply extend the wires by splicing in suitable lengths of #20 gauge insulated hook-up wire. Solder and tape all connections.

## OUTPUT CONNECTION

Connect your loudspeaker to the appropriate terminals on the OUTPUT Terminal Strip of The Model 80-AZ, using any twin-lead cable. (The OUTPUT Terminal Strip is marked "GND", 4, 8, 16.) The "GND" terminal must not be used as part of the basic ground of the entire electrical system. Select the proper nominal matching impedance for the speaker system being used (4, 8 or 16 ohms) by setting the IMPEDANCE Switch to the appropriate position.

## INPUT CONNECTION

Connection to the INPUT of the Model 80-AZ is made by means of a standard RETMA phono plug supplied with the equipment. If the signal source is approximately one volt, the LEVEL ADJUSTMENT control should be rotated fully clockwise. For signal sources in excess of one volt, turn the LEVEL ADJUSTMENT correspondingly lower (counterclockwise) depending on the maximum voltage of the signal source. When using THE FISHER Master Audio Control as a preamplifier, set the LEVEL ADJUSTMENT of the Model 80-AZ to maximum (clockwise.)

## HOW TO ACHIEVE MAXIMUM ENJOYMENT OF THE FISHER Z-MATIC CONTROL

When the Z-Matic Control is set at minimum, the amplifier will operate in the conventional manner, producing constant voltage regardless of load.

Let us now arbitrarily set the Control with the dot at the top. In this vicinity constant power will be fed to the loudspeaker regardless of variations in speaker impedance. High quality speaker systems with good overall efficiency will



perform best when the Control is in this position. Where optimum speaker systems and speaker enclosures are not available, the acoustic shortcomings of the system can be overcome in great measure by rotating the Z-Matic Control toward maximum, according to the needs of the situation. Any rotation past the top position produces increasing multiplication of the electrical factors necessary to overcome the deficiencies of the speaker system and speaker enclosure.

The Z-Matic effect will, of course, be most apparent in the maximum position and, in many cases, represents the closest approach to truly uniform response in terms of *audible power*, which is after all the ultimate criterion.

It should be noted that the three positions described are arbitrary, for the purposes of the discussion. There are an infinite number of intermediate positions available, according to your tastes and needs. May we suggest that you experiment with the Control to familiarize yourself with its tremendous possibilities for increasing the enjoyment of your equipment.

**IMPORTANT NOTE:** With some speakers, rotating the Z-MATIC Control may result in an overall volume change. This condition is caused by a slight mismatch between speaker and amplifier. (A nominal 16-ohm voice coil may not be exactly 16 ohms at mid-frequencies. As long as the change in volume is not severe, the Z-Matic circuit will operate effectively.

### HOW TO USE THE FISHER PEAK POWER INDICATOR

When the PEAK POWER Control is set to the OFF position, the indicator light will not operate at any time. If your speaker is rated at thirty watts or more, or if you do not desire to have the Indicator illuminate on power peaks, set the Control in the OFF position.

For speaker protection, with speakers having peak wattage ratings below thirty watts, set the PEAK POWER Control to a point *just below* the rating of the speaker. In adjusting the Level or Volume Control of your system, *never* exceed that setting which causes the indicator to just barely light for the *loudest* passages of music. When the light flashes, the amount of power instantaneously absorbed by the loudspeaker will then be equal to the value shown by the setting of the Control. Values of instantaneous peak power are greatly dependent upon the total wave-shape or harmonic content of the particular program material being played. For example, a sinusoidal (single tone) wave-shape will result in peak power considerably lower than a complex signal approaching a square-wave shape. THE FISHER PEAK POWER INDICATOR calibration is based upon purely sinusoidal wave-shapes. Average power is generally about 10 db (1/10) lower than peak power calculated in this manner, with typical program material. For example, when listening to an average level of two watts in a room, the PEAK POWER INDICATOR may show peaks of as great as twenty watts or more. It is this established fact which results in the need for relatively high-powered audio amplifiers for faithful musical reproduction.

It is also possible with the aid of the PEAK POWER INDICATOR to determine the peak power for a given volume setting. With the Control turned fully clockwise to the OFF position, and with the music playing at the desired listening level, slowly rotate the Control counterclockwise until the Indicator light just barely flashes when the loudest passages of music are played. The reading of the Control then indicates the maximum instantaneous power being absorbed by the loudspeaker for that particular volume setting.

### POWERSCOPE CALIBRATION INSTRUCTIONS

The PowerScope PEAK POWER INDICATOR has been accurately calibrated at the factory. Should readjustment be necessary at any time, follow this simple procedure for correct calibration:

1. Remove the bottom cover.
2. Set the slider arm of the Calibration Control (located on the terminal board adjacent to the neon regulator bulb) for maximum resistance (to the end of the Control that has no lead.)
3. Turn on the amplifier and allow sufficient time for warm-up.
4. Set the PowerScope Control to minimum (.25 watts. Set the Z-MATIC Control to the OFF position. The PEAK POWER INDICATOR will light even with no signal applied.)
5. Turn off the amplifier and move the slider arm of the Calibration Control a small amount in the direction of less resistance.
6. Turn on the amplifier and check for absence of POWER INDICATOR illumination under no-signal conditions. It may be necessary to repeat step 4 in several small increments to make certain that an accurate calibration is obtained. The optimum calibration occurs at that point where the PEAK POWER INDICATOR just remains unlit with no signal applied.

The PEAK POWER INDICATOR of the FISHER Model 80-AZ is now accurately calibrated over the entire range of the PowerScope Control.

### PHASE INVERTER BALANCE ADJUSTMENT

The phase inverter balance adjustment potentiometer R-6 is on the top surface of the chassis. This potentiometer has been carefully pre-set at our factory. Adjustment is required only when components in the phase inverter circuit are replaced and should never be attempted unless a low distortion audio generator, and a wave analyzer or distortion analyzer, are available. If this adjustment becomes necessary, proceed as follows:

1. Connect the audio generator to the amplifier INPUT.
2. Disconnect the speaker and connect a 16-ohm, 20-watt resistor to "GND and "16"
3. Switch IMPEDANCE SELECTOR to "16".
4. Rotate Z-MATIC Control fully counterclockwise.
5. Connect the wave analyzer or distortion analyzer across the 16-ohm resistor.

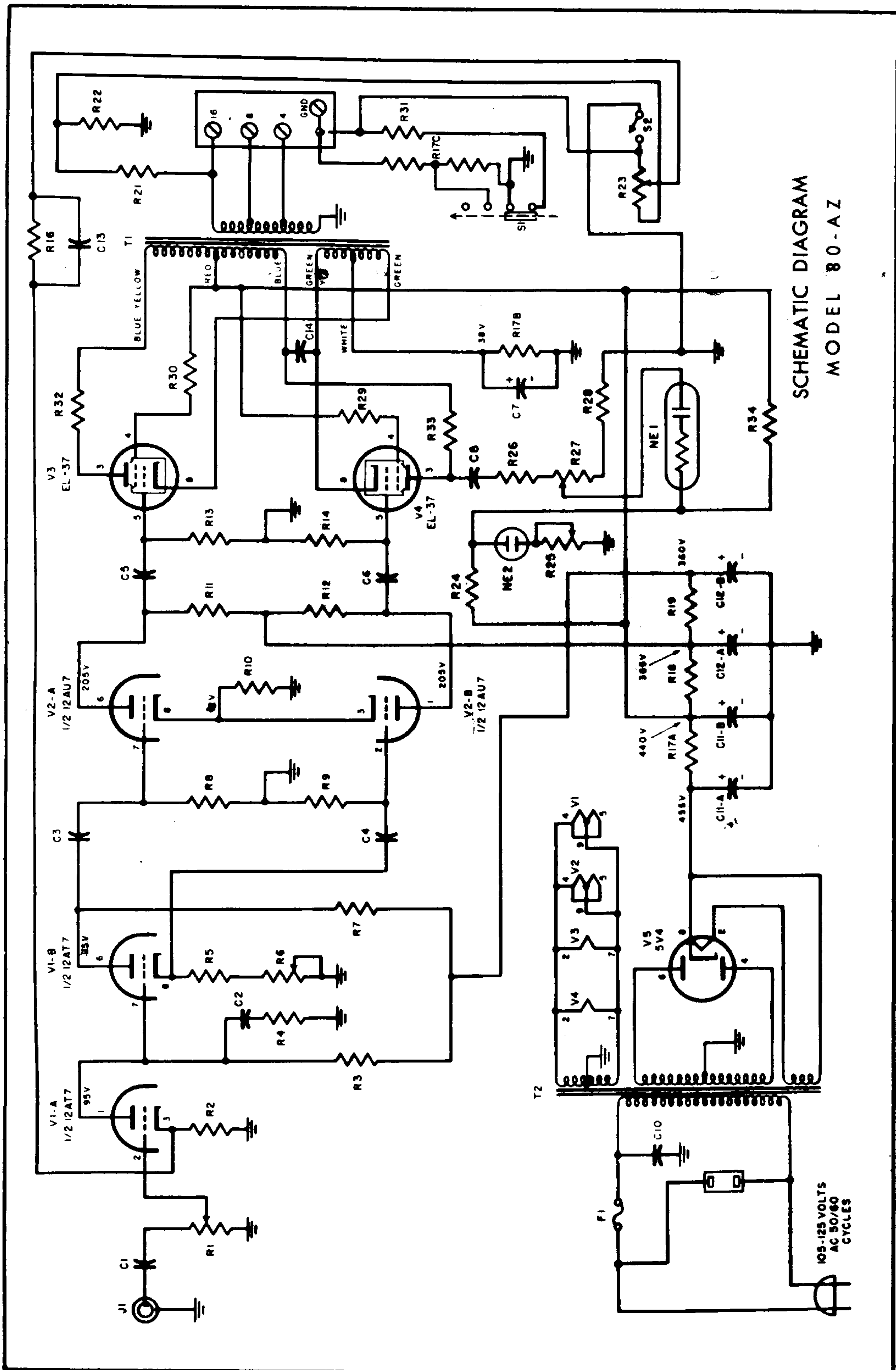

SCHEMATIC DIAGRAM  
MODEL 80-AZ

6. Set the audio generator to 1000 cycles and adjust the attenuator so that the amplifier produces 20 watts output (17.85 volts RMS) across the 16-ohm resistor.
7. Tune the wave analyzer to the second harmonic of 1000 cycles or, if a distortion analyzer is used, tune it for minimum reading at 1000 cycles.
8. With extreme care adjust the phase inverter balance control for minimum distortion.

### AT YOUR SERVICE

It is the constant desire of Fisher Radio Corporation to have your FISHER equipment give you its best possible performance. Toward that ob-

jective, we solicit your correspondence on any special problems that may arise. After you have had an opportunity to familiarize yourself with THE FISHER equipment you purchased, we would appreciate your letting us know how it is meeting your requirements.

**SPECIAL NOTE:** To maintain your equipment at peak performance, may we suggest that you avail yourself of the facilities and factory trained personnel at our Service Department.

### FISHER RADIO CORPORATION

21-21 Forty-fourth Drive  
Long Island City 1, N. Y.

## PARTS DESCRIPTION LIST

Symbol	Description	Part No.
C-1	Capacitor: .22 mfd; 200 V	C-69P224V2
C-2	Capacitor, Ceramic: 300 mmfd, 10%, 500 V	CC-21GP301K5
C-3, C-4	Capacitor: .022 mfd; 400 V	C-68P223M4
C-5, C-6	Capacitor: .1 mfd; 400 V	C-68P104M4
C-7	Capacitor, Electrolytic: 50 mfd; 50 V	C-508-115
C-8	Capacitor: .047 mfd; 600 V	C-68P473M6
C-10	Capacitor: .01 mfd; 600 V	C-2747
C-11A, B	Capacitor, Electrolytic: Each section 40 mfd; 500 V	C-522-114
C-12A, B	Capacitor, Electrolytic: Each section 40 mfd; 450 V	C-1798
C-13	Capacitor, Ceramic: 420 mmfd; 500 V	CC21GP421K5
C-14	Capacitor, Ceramic: 500 mmfd; 1500 V	C-508-122
F-1	Fuse, 3 Amperes	F-3000
NE-1	Power Indicator	I-557-120
NE-2	Regulator, Neon	V-NE-51
R-1	Potentiometer, Composition: 500,000 ohms	R-2815-9
R-2	Resistor, Composition: 1500 ohms, 10%; 1/2 W	RC-20BF152K
R-3	Resistor, Composition: 220,000 ohms, 10%; 1/2 W	RC-20BF224K
R-4, R-19	Resistor, Composition: 10,000 ohms, 10%; 1/2 W	RC-20BF103K
R-5	Resistor, Composition: 68,000 ohms, 10%; 1/2 W	RC-20BF683K
R-6	Potentiometer, Composition: 50,000 ohms	R-50000-5
R-7	Resistor, Composition: 100,000 ohms, 10%; 1/2 W	RC-20BF104K
R-8, R-9	Resistor, Composition: 470,000 ohms, 10%; 1/2 W	RC-20BF474K
R-10	Resistor, Composition: 4700 ohms, 10%; 1/2 W	RC-20BF472K
R-11, R-12	Resistor, Composition: 150,000 ohms, 10%; 1/2 W	RC-20BF154K
R-13, R-14	Resistor, Composition: 470,000 ohms, 10%; 1/2 W	RC-20BF474K
R-16	Resistor, Composition: 2200 ohms, 10%; 1/2 W	RC-20BF222K
R-17A, B, C	Resistor, Wirewound: 100 ohms; 5W and 352 ohms tapped at 350 and 351 ohms; 10W	R-557-128
R-18	Resistor, Composition: 10,000 ohms, 10%; 1 W	RC-30BF403K
R-21	Resistor, Composition: 2200 ohms, 10%; 1/2 W	RC-20BF222K
R-22	Resistor, Composition: 330 ohms, 10%; 1/2 W	RC-20BF331K
R-23	Potentiometer 1000 ohms	R-557-126
R-24	Resistor, Composition: 820,000 ohms, 10%; 1/2 W	RC-20BF824K
R-25	Potentiometer, Printed Circuit: 30,000 ohms	R-557-137
R-26	Resistor, Composition: 100,000 10%; 1/2 W	RC-20BF104K
R-27	Potentiometer: 100,000 ohms	R-557-121
R-28	Resistor, Composition: 6800 ohms, 10%; 1/2 W	RC-20BF682K
R-29, R-30	Resistor, Composition: 68 ohms, 10%, 1/2 W	RC-20BF680K
R-31	Resistor, Wire Wound: 0.82 ohms; 5 W	R-557-140
R-32, R-33	Resistor, Composition: 10 ohms, 10%, 1/2 W	RC-20BF100K
R-34	Resistor, Composition: 2.2 megohms, 10%, 1/2 W	RC-20BF225K
S-1	Switch, Slide: DPDT	S-505-117
S-2	Switch, SPST; part of R-23	
T-1	Transformer, Output	T-557-122
T-2	Transformer, Power	T-557-123

### MISCELLANEOUS PARTS

Dress Panel	A-557-113
Knob	E-557-127
THE FISHER Decal	N-557-132