

Service Manual

THE FISHER®

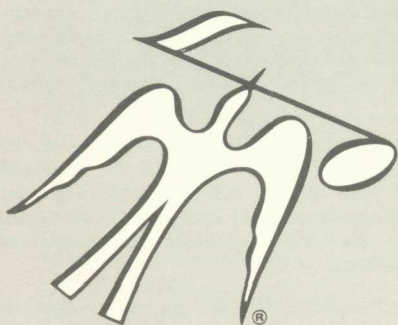
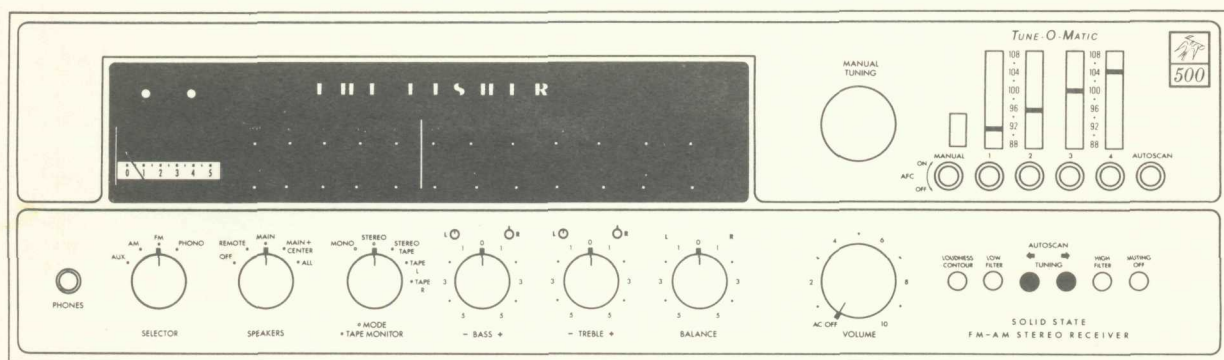

500-TX™

CHASSIS SERIAL NUMBERS
BEGINNING 10001

PRICE \$1.00

FISHER RADIO CORPORATION • 11-40 45th ROAD • LONG ISLAND CITY, N.Y. 11101

(c) www.fisherconsoles.com

REQUIRED TEST EQUIPMENT

The following equipment is required to completely test and align modern high-fidelity amplifiers, tuners, and receivers.

Line Voltage Autotransformer or Voltage Regulator
DC Vacuum Tube Voltohmmeter
Accurately Calibrated AC Vacuum Tube Voltmeter
Oscilloscope ((Flat to 100 kHz Minimum)
Low-Distortion Audio (Sine Wave) Generator
Intermodulation Distortion Analyzer
Harmonic Distortion Analyzer
2 – Load resistors, 8-Ohms, 100 Watt (Minimum Rating)
AM/FM Signal Generator

10.7 MHz Sweep Generator
Multiplex Generator (preferably with RF output – FISHER 300)
455 kHz Sweep Generator
Ferrite Test Loop Stick
2 – Full Range Speakers for Listening Tests
Stereo Source – Turntable, Tape Recorder, etc.
Soldering Iron with Small Tip, Fully Insulated from AC Line
Suction Desoldering Tool

CAUTION: This precision high-fidelity instrument should be serviced only by qualified personnel, trained in the repair of transistor equipment and printed circuitry.

Many of these items are included only as a reminder – they are normal procedures for experienced technicians. Shortcuts may be taken, but these often cause additional damage to transistors, circuit components, or printed circuit boards.

SOLDERING: A well-tinned, hot, clean soldering iron tip will make soldering easier, without causing damage to the printed circuit board or the components mounted on it. Regular use of a sponge cleaner will maintain a clean soldering surface. The heat available at the tip, (not the wattage of the iron) is important. Some 50-watt irons reach temperatures of 1,000° F, while others will hardly melt solder. Small-diameter tips should be used for single solder connections, pyramid and chisel tips for large areas.

Always disconnect the AC power cord from the line when soldering. Turning the power switch OFF is not sufficient. Power-line leakage paths, through the heating element of the iron, may destroy transistors.

PARTS REMOVAL: If a part is not being returned for in-warranty factory replacement, it may be cut in half (with diagonal cutting pliers) to make removal easier. Multiple terminal parts, such as IF transformers, or electrolytic capacitors, should be removed using special de-soldering tips made especially for this purpose. Removing solder from terminals, reduces the possibility of breaking the printed circuit board when the part is removed.

ACCIDENTAL SHORTS: A clean working area, free of metal particles, screws, etc., is an important preventive in avoiding servicing problems. Screws, removed from the chassis during servicing, should be stored in a box until needed. While a set is operating, it takes only an instant for a base-to-collector short to destroy a transistor (and others direct-coupled to it). In the time it takes for a dropped machine screw, washer, or screwdriver, to contact a pair of socket terminals (or terminal and chassis), a transistor can be ruined.

SOLID-STATE DEVICES: Integrated Circuits contain the equivalent of many circuit parts, including transistors, diodes, resistors, and capacitors. The preferred troubleshooting procedure requires isolating the trouble to one stage using AC signal tracing methods. Once the suspected stage is located, the DC voltages at the input and output leads are measured to give an accurate indication of the operating conditions of the IC. DO NOT use an ohmmeter to check continuity with the IC mounted on the printed circuit board. Forward biasing the internal junctions within the IC may burn out the transistors. Do not replace a defective IC until all external resistors, capacitors, and transformers are checked first, to prevent the replacement IC from failing immediately due to a defect in the connecting components. Solder and unsolder each lead separately using a pliers or other heat sink on the lead to prevent damage from excessive heat. Check that the leads are

connected to the correct locations on the printed circuit board before turning the set on.

Whenever possible, a transistor tester should be used to determine the condition of a transistor or diode. Ohmmeter checks do not provide conclusive data, and may even destroy the junction(s) within the device.

Never attempt to repair a transistor power amplifier module until the power supply filter-capacitors are fully discharged.

If an output or driver transistor becomes defective (opens or shorts), always check ALL direct-coupled transistors and diodes in that channel. In addition, check the bias pot., and other parts in the bias network, before installing replacement transistors. All output and driver transistors in one channel may be destroyed if the bias network is defective. After parts replacement, always check the bias adjustment for specified idling current.

In some applications, replacement of transistors must be made from the same beta group as the original type. The beta group is indicated by a colored marking on the transistor. Be sure to include this information when ordering replacement transistors.

When mounting a replacement power transistor, be sure the bottom of the flange, mica insulator, and the surface of the heat sink, are free of foreign matter. Dust and grit will prevent flat contact, reducing heat transfer to the heat sink. Metallic particles can puncture the insulator, cause a short, and destroy the transistor.

Silicone grease must be used between the transistor and the mica insulator, and between the mica and the heat sink, for best heat transfer. Use Dow-Corning DC-3, or an equivalent compound made for power transistor heat conduction.

Use care when making connections to speakers and output terminals. To reduce the possibility of shorts, lugs should be used on the exposed ends, or stranded wire should be tinned to prevent frayed wire ends. Current in the speakers and output circuitry is quite high – poor contacts, or small sized wire, can cause significant power losses in the system. For wire lengths greater than 30 feet, 16 AWG, or heavier, should be used.

VOLTAGE MEASUREMENTS: All voltages are measured with the line voltage adjusted to 120 volts. All measured voltages are $\pm 10\%$. DC voltages are measured to ground with a VTVM, with no signal input unless otherwise noted. AC signal voltages are measured under the conditions specified on the schematic.

ALIGNMENT PROCEDURES: DO NOT attempt realignment unless the required test equipment is available, and the alignment procedure is thoroughly understood.

BECAUSE ITS PRODUCTS ARE SUBJECT TO CONTINUOUS IMPROVEMENT, FISHER RADIO CORPORATION RESERVES THE RIGHT TO MODIFY ANY DESIGN OR SPECIFICATION WITHOUT NOTICE AND WITHOUT INCURRING ANY OBLIGATION.

SERVICE PROCEDURES

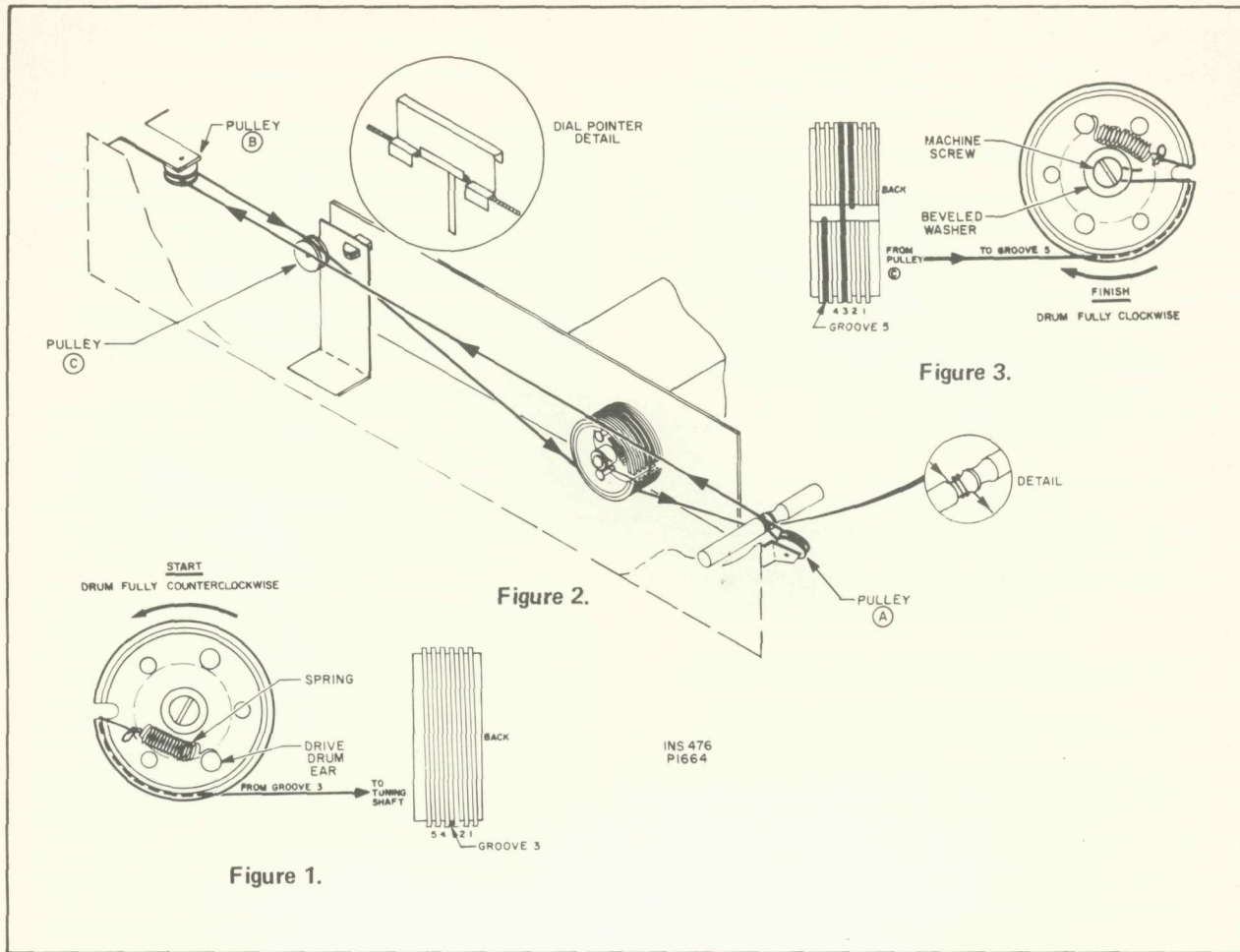

DIAL STRINGING

- (1) Remove dress panel. Refer to REMOVING DRESS PANEL procedure.
- (2) Remove dial pointer.
- (3) Remove dial glass assembly. Refer to REMOVING DIAL GLASS ASSEMBLY procedure.
- (4) Rotate the tuning capacitor drive-drum to its maximum CCW position. Loosen the machine screw in the center of the drive-drum and remove the old dial cord.
- (5) Tie end of new dial cord to one end of dial spring. Fasten spring to bottom right ear inside drive-drum. See Figure 1.
- (6) Run the dial cord through the slot in the rim of the drive-drum and set in the underside of groove 3.
- (7) Pull dial cord taut and wrap 2 turns CCW around tuning shaft. See Figure 2.
- (8) Guide the dial cord under and around pulley "A", across to the left side, around pulley "B", and over pulley "C". Keep dial cord taut during this procedure.
- (9) Rotate the drive-drum to its maximum CW position, allowing the cord to wind onto the drive-drum. Keep the dial cord taut during this procedure.
- (10) Guide the dial cord under the drive-drum and into groove 5. Bring the dial cord around groove 5 and into the slot in the drive-drum. See Figure 3.
- (11) With the machine screw loosened, place the cord under the beveled washer, pull the dial cord taut, and tighten the screw.

- (12) Turn the tuning shaft to rotate the drive-drum fully CCW and fully CW to distribute the tensioning along the dial cord.
- (13) Repeat steps (11) and (12) until dial spring is tensioned.
- (14) Remount the dial glass assembly using the three mounting screws removed previously.
- (15) Place the dial cord over and under the tabs on the rear of the dial pointer (see detail), and place the pointer on the top of the dial glass panel rail.
- (16) Turn the tuning shaft fully CCW. Slide the dial pointer to zero (0) calibration mark on the logging scale while holding tuning shaft fully CCW. Cement dial pointer to dial cord to prevent slippage. Allow cement to thoroughly dry.
- (17) Reinstall the dress panel and knobs. Reconnect all leads (removed previously) to their respective terminals.
- (18) Check dial calibration. Refer to FM FRONT END ALIGNMENT and AM RF ALIGNMENT.
- (19) Remount top cover removed previously.

CLEANING FRONT PANEL

WARNING: Use only plain lukewarm water for moistening a freshly laundered, soft lint-free cloth to clean the front control panel.

SERVICE PROCEDURES

REMOVING DRESS PANEL

- (1) Disconnect AC power cord.
- (2) Remove the screws which hold the top cover to the chassis. Remove the cover.
- (3) Gently pull the leads off the terminal pins behind the TUNE-O-MATIC dial assembly. Seventeen push-on terminal leads connect the panel-mounted dial assembly to the chassis circuitry and must be disconnected in order to remove the dress panel. Label each lead with its associated pin location to make replacement easier later.
- (4) Gently pull all knobs off the front dress panel control shafts. Remove the hex nuts from the shafts and remove panel by pulling forward over the shafts.
- (5) Reverse procedure for reassembly.

REPLACING DIAL LAMPS

- (1) Remove dress panel. Refer to REMOVING DRESS PANEL procedure.
- (2) Snap out the defective lamp from the spring clip. Place the new lamp in the socket making sure that the unpainted side of the lamp faces the edge of the dial glass.
- (3) Replace the front dress panel and secure with the hex nuts removed previously. Replace the knobs on the control shafts.
- (4) Reconnect the terminal leads (removed previously) to their respective terminal pins behind the TUNE-O-MATIC assembly.
- (5) Replace the top cover.

REMOVING DIAL GLASS ASSEMBLY

- (1) Remove dress panel. Refer to REMOVING DRESS PANEL procedure.
 - (2) Untwist the cable harness located behind the meter.
 - (3) Gently pull the six meter leads from the terminal pins on the connecting board and chassis. Label each lead with its associated pin location for easy replacement later.
 - (4) Gently pull the two pairs of dial lamp leads from the terminal pins on the connecting board and label each lead.
 - (5) Gently pull the two pairs of leads from the MUTING and STEREO BEACON lamp cartridges from the terminal pins on the connecting board and AM/FM IF, MPX board. Label each lead.
- NOTE:** These fourteen push-on terminal leads which connect the dial glass panel to the chassis must be disconnected in order to remove the dial glass panel.
- (6) Remove the left dial lamp to expose the screw holding the left side of the dial glass panel.
 - (7) Remove the three screws holding the dial glass panel. Remove the panel with the dial glass, right dial lamp, MUTING lamp, STEREO BEACON lamp, and meter attached by tilting out the bottom of the panel and sliding downward. Be careful to avoid deforming dial pointer.
 - (8) Reverse the procedure for reassembly.

REPLACING METER LAMPS

- NOTE:** The compartmented lamp assembly (FRC Part No. M21B605-2), mounted on the rear of the meter, contains the meter lamps and must be replaced as a complete unit.
- (1) Disconnect AC power cord.
 - (2) Remove the screws which hold the top cover to the chassis. Remove the cover.
 - (3) Untwist the cable harness located behind the meter.
 - (4) Gently pull the four meter lamp leads (top rear of meter) from the terminal pins on the connecting board and chassis. Label each lead with its associated pin location for reference when installing replacement lamp assembly.
 - (5) Pull the compartmented lamp assembly back against the springs and lift out.
 - (6) Lift the meter spring and insert the replacement lamp assembly. Allow the holes in the flange to engage the meter screws.
 - (7) Connect the four leads to the correct pins on the connecting board and chassis.
 - (8) Retwist the cable harness and replace top cover.

REPLACING METER

REPLACING MUTING OR STEREO BEACON LAMP

- (1) Remove dress panel. Refer to REMOVING DRESS PANEL procedure.
- (2) Remove the four screws holding the dial glass to the dial glass panel. Remove the dial glass.
- (3) Untwist the cable harness located behind the meter.
- (4) Gently pull the pair of leads of the MUTING or STEREO BEACON lamp cartridge from their respective terminal pins. Label each lead with its associated pin location for reference when installing replacement cartridge.
- (5) Remove the defective MUTING or STEREO BEACON lamp cartridge by pulling through dial glass panel.
- (6) Reverse the procedure for reassembly, using the replacement cartridge.

- (1) Remove dress panel. Refer to REMOVING DRESS PANEL procedure.
- (2) Remove dial glass assembly. Refer to REMOVING DIAL GLASS ASSEMBLY procedure.
- (3) Pull the compartmented lamp assembly back against the meter spring and lift off. Remove the spring from the panel.
- (4) Gently pry the meter off the dial glass panel, and scrape the residual adhesive from the panel.
- (5) Peel the backing from one side of the replacement adhesive mounting pad (FRC Part No. E51A165), and affix it to the replacement meter. Peel the backing from the remaining side of the adhesive pad, align the meter face over the dial panel cutout, and firmly press the meter to the back of the dial glass panel.
- (6) Remount the meter spring to panel. Lift the meter spring and insert the compartmented lamp assembly. Allow the holes in the flange to engage the meter screws.
- (7) Remount the dial glass assembly.
- (8) Reinstall the dress panel. Reconnect all leads (removed previously) to their respective terminal pins.
- (9) Check meter calibration. Refer to TUNING METER AND MUTING LEVEL ADJUSTMENTS procedure.
- (10) Remount top cover.

SERVICE PROCEDURES

REMOVING P.C. BOARDS

To remove a board from its nylon mounts, squeeze the loop of each mounting clip (using pliers), and lift each corner of the board. To remount the board, align the mounting holes over the clips, and press firmly.

SERVICING INTEGRATED CIRCUITS

Integrated Circuits are used in this unit to approach the theoretical maximum of AM suppression and noise limiting. These IC's contain the equivalent of many circuit parts, including transistors, diodes, resistors, and capacitors. These integrated circuits are high-reliability devices, requiring minimum servicing. In the unlikely event that an IC requires servicing, it should be serviced in the same way as a transistor.

The preferred troubleshooting procedure requires isolating the trouble to one stage using AC signal tracing methods. Once the suspected stage is located, the integrated circuit can be checked by measuring the DC voltages at the input and output leads of the IC using a DC VTVM. These DC voltage measurements give the most accurate indications of the operating conditions of the integrated circuit.

WARNING: Do not use an ohmmeter to check continuity with the IC mounted on the printed circuit board. Forward biasing the internal junctions within the IC may burn out the transistors.

When replacing an integrated circuit, the following precautions should be observed:

- (1) Do not replace a defective IC until the cause of the trouble is found. All external resistors, capacitors, and transformers should be checked first, to prevent the replacement integrated circuit from failing immediately due to a trouble in the connecting components.
- (2) Solder and unsolder each lead separately using a pliers or other heat sink on the lead to prevent damage from excessive heat.
- (3) Check that the leads of the replacement IC are connected to the correct locations on the printed circuit board before turning the set on.

FUSES

EXPORT CHASSIS ONLY:

Additional safety fuses are used in the transformer secondary circuits of this receiver, to provide increased protection. For fuse type and rating, refer to MAIN CHASSIS schematic.

For added safety, the power amplifier module in this receiver is individually fused. For fuse type and rating, refer to POWER AMPLIFIER MODULE schematic.

POWER AMPLIFIER CENTER VOLTAGE TEST

NOTE: Allow set to warm up at least 30 minutes before making measurements or adjustments.

Turn VOLUME control to minimum. Set SPEAKERS switch to MAIN.

- (1) Connect an 8-ohm load resistor across the LEFT SPEAKERS MAIN terminals. In parallel with the load resistor, connect the input leads of a DC VTVM. Meter should read 0 volt ($\pm 100\text{mV}$).
- (2) Remove the 8-ohm load resistor. Meter should read 0 volt ($\pm 100\text{mV}$).
- (3) Repeat the preceding steps for right channel.

POWER AMPLIFIER IDLING CURRENT ADJUSTMENT

NOTE: Allow set to warm up at least 30 minutes before making measurements or adjustments.

WARNING: Before using the DC VTVM in the following procedure, make sure the DC VTVM is isolated from the power line, and there is no ground connection between the DC VTVM and other test equipment.

Turn VOLUME control to minimum.

- (1) Connect ground lead of DC VTVM to pin 8C on left channel of predriver/driver board. Connect probe of DC VTVM to pin 8Z on predriver/driver board.
- (2) Adjust pot. R815 (OUTPUT BIAS ADJUST) for DC VTVM reading of 15 mV.
- (3) Connect ground lead of DC VTVM to pin 8J on right channel of predriver/driver board. Connect probe of DC VTVM to pin 8Q on predriver/driver board.
- (4) Adjust pot. R816 for DC VTVM reading of 15 mV.

POWER OUTPUT MEASUREMENT

The output amplifier of this unit is designed to deliver its full-rated power with program material (voice or music) into 8-ohm loads for an indefinite period of time. When a constant audio tone is used as a signal to measure the maximum continuous RMS power output, the following precautions must be taken:

- (1) Measure the power output of one channel at a time.
- (2) Limit the measurement period to 10 minutes with a load resistance of 8 ohms.
- (3) Use a load resistor with a power rating of at least 100 watts.

WARNING: If the power output of both channels is measured simultaneously, use a load of 8 ohms per channel and limit measurements to a period not longer than 5 minutes.

NOTE: This unit uses a high temperature cutout switch to protect the amplifier against damage resulting from overheating. The switch disables the amplifier by eliminating drive signal in the audio control amplifier. When the amplifier cools to normal operating temperature, the cutout switch automatically resets.

HARMONIC DISTORTION TEST

Set SELECTOR switch to AUX, SPEAKERS switch to MAIN, and MODE/TAPE MONITOR switch to STEREO. Set

SERVICE PROCEDURES

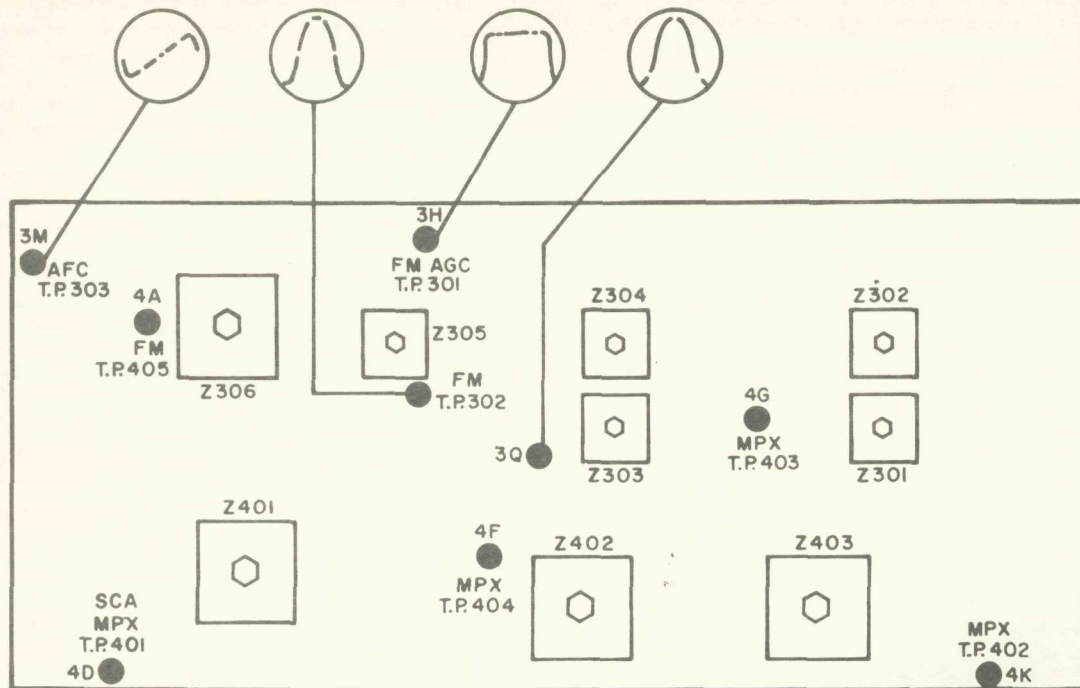

Figure 4. AM-FM IF, MPX, Meter, Muting Board Alignment Location.

BASS, TREBLE, and BALANCE controls to their center (flat) positions.

- (1) Connect an 8-ohm, 100-watt resistor across the LEFT SPEAKERS MAIN terminals. In parallel with the load resistor, connect the input leads of an accurately calibrated AC VTVM.
- (2) Connect a low-distortion audio sine-wave generator, set for 1,000 Hz, to the LEFT AUX IN jack.
- (3) Rotate VOLUME control to maximum.
- (4) Increase audio generator level for 60 watts output (21.9 V RMS across 8-ohm load). HD meter should read 0.5% or less.
- (5) Repeat preceding steps for right channel.

INTERMODULATION DISTORTION TEST

Set SELECTOR switch to AUX, SPEAKERS switch to MAIN, and MODE/TAPE MONITOR switch to STEREO. Set BASS, TREBLE, and BALANCE controls to their center (flat) positions.

- (1) Connect an 8-ohm, 100-watt resistor across the LEFT SPEAKERS MAIN terminals. In parallel with the load resistor, connect the input leads of an IM analyzer and the input leads of an accurately calibrated AC VTVM.
- (2) Connect IM-analyzer generator output to the LEFT AUX IN jack.
- (3) Rotate VOLUME control to maximum.
- (4) Increase IM-analyzer generator output for 60 watts output (17.9 V RMS across 8-ohm load). IM meter reading should be 0.8% or less.
- (5) Repeat preceding steps for right channel.

NOTE: If any of the preceding instructions differ from those in the IM-analyzer instruction manual, it is best to follow

those in the manual. If a load resistor of 100-watt (or higher) rating is built into the IM analyzer, a separate load resistor is not required.

FM IF AND DETECTOR ALIGNMENT

Depress MANUAL pushbutton, and turn AFC switch to OFF. Set MANUAL TUNING dial pointer to zero (0) calibration mark on the logging scale. Depress MUTING OFF pushbutton switch. Set SELECTOR switch to FM, and turn VOLUME control to minimum.

- (1) Disconnect capacitor C4 (0.02 μ F) and wire lead from Test Point 301 (pin 3H on AM/FM IF, MPX board). Connect scope vertical input to Test Point 301 (pin 3H). Connect scope ground lead to pin 3G.
- (2) Connect 10.7 MHz sweep generator to Test Point 751 (pin 7G on FM Front End board). Connect ground lead of generator to pin 7F. Set generator output level to approximately 10 mV output and adjust sweep to observe IF response curve.
- (3) Carefully adjust C775 and C780 (on FM Front End board) for maximum gain and symmetry (see Figure 5). Cover trimmer holes with tape after alignment.
- (4) Carefully adjust top core of IF transformer Z302 (on AM/FM IF, MPX board) for maximum gain and symmetry. Carefully adjust bottom core for symmetry and **minimum** amplitude.
- (5) Disconnect scope connections. Reconnect capacitor C4 and wire lead to Test Point 301 (pin 3H on AM/FM IF, MPX board) removed previously.
- (6) Connect scope vertical input to Test Point 302 (tip of resistor R332, 180k, on AM/FM IF, MPX board). Carefully adjust core of IF transformer Z305 for maximum gain and

SERVICE PROCEDURES

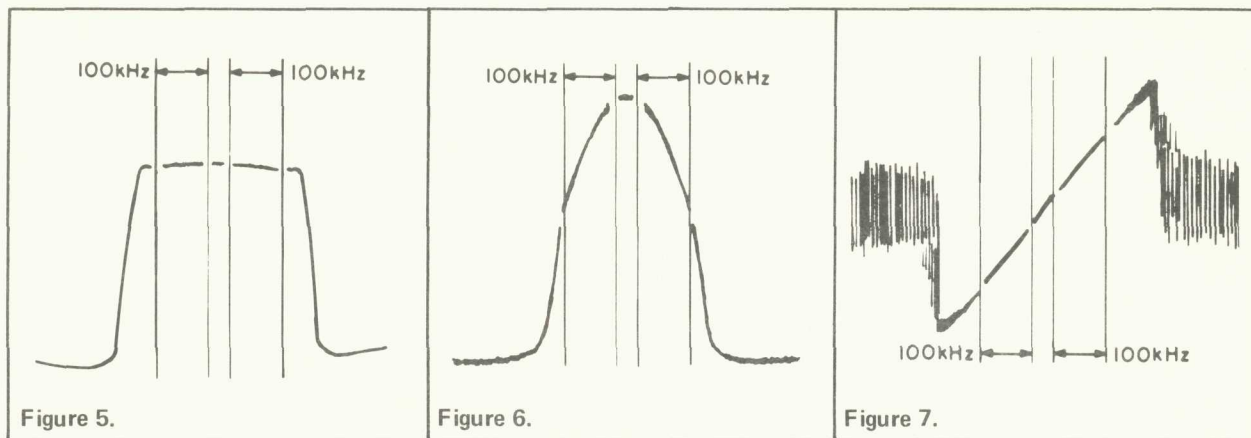

symmetry. Carefully adjust top and bottom core of Z304 for maximum gain and symmetry (see Figure 6). DO NOT READJUST Z302.

- (7) Connect scope vertical input to Test Point 303 (pin 3M on AM/FM IF, MPX board). Adjust generator level and sweep to observe detector "S" curve. Adjust bottom core of Z306 first, then top core for maximum gain and symmetry (see Figure 7). Reduce generator sweep to zero (sweep off).
- (8) Connect DC VTVM to Test Point 303 (pin 3M). Use most sensitive meter scale setting.
- (9) Slightly readjust top core of Z306 for zero (0) reading (within ± 0.1 volt) on DC VTVM.

- (9) Repeat alignment procedure at 90MHz and 106MHz until maximum gain is obtained and dial calibration is correct.

FM FRONT END ALIGNMENT

Depress MANUAL pushbutton, and turn AFC switch to OFF. Depress MUTING OFF pushbutton switch. Set SELECTOR switch to FM, and MODE/TAPE MONITOR switch to MONO. Turn VOLUME control to minimum.

- (1) Set MANUAL TUNING dial pointer to zero (0) calibration mark on the logging scale. If the dial pointer is not centered on the (0) at the extreme end of knob rotation, reposition the pointer assembly on the dial cord and cement the pointer in place to prevent slippage. Allow cement to thoroughly dry. **NOTE:** Repositioning dial pointer may require realignment of AM RF board for correct AM station calibration.
- (2) Connect an accurately calibrated DC VTVM to Test Point 701 (pin 7M on Muting board).
- (3) Set dial pointer to 2.3 on logging scale. Adjust R4 MANUAL TUNING pot. (fine adjustment) for 5.63V indication on DC VTVM. Disconnect DC VTVM from Test Point 701 (pin 7M).
- (4) Connect an FM generator to the FM ANTenna terminals. Use a 120-ohm composition resistor in series with each lead from the generator (see Figure 8).
- (5) Connect a scope and an AC VTVM to either the LEFT or RIGHT RCDR OUT jack.
- (6) Modulate FM generator with 400Hz, ± 75 kHz deviation. Set generator frequency to 90MHz. During alignment, adjust generator output as low as possible.
- (7) Align (oscillator coil) L754 first, then (RF transformers) L753, and L752, and (antenna coil) L751 for maximum indication on AC VTVM and oscilloscope.
- (8) Set generator frequency and dial pointer to 106MHz. Align (oscillator trimmer) C769 first, then (RF trimmers) C768, and C763, and (antenna trimmer) C754 for maximum indication on AC VTVM and oscilloscope.

TUNING METER AND MUTING LEVEL ADJUSTMENTS

NOTE: These adjustments should be performed after FM IF and RF alignment.

Depress MANUAL pushbutton, and turn AFC switch to OFF. Depress MUTING OFF pushbutton switch. Set SELECTOR switch to FM, and MODE/TAPE MONITOR switch to MONO. Turn VOLUME control to minimum.

- (1) Connect an FM generator to the FM ANTenna terminals. Use a 120-ohm composition resistor in series with each lead from the generator (see Figure 8).
- (2) Set MANUAL TUNING dial pointer to zero (0) calibration mark on logging scale. Set FM generator frequency to receiver frequency.
- (3) Connect a scope and an AC VTVM to either the LEFT or RIGHT RCDR OUT jack.
- (4) Modulate FM generator with 400 Hz, ± 75 kHz deviation.

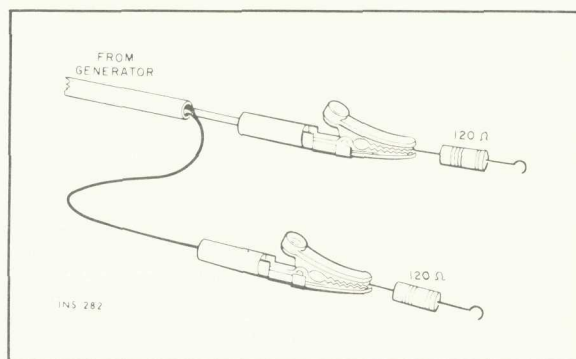

Figure 8. Connections To Provide 300-ohm Generator Output Impedance. Matching Resistors Reduce Generator Voltage by Half At Antenna Terminals.

SERVICE PROCEDURES

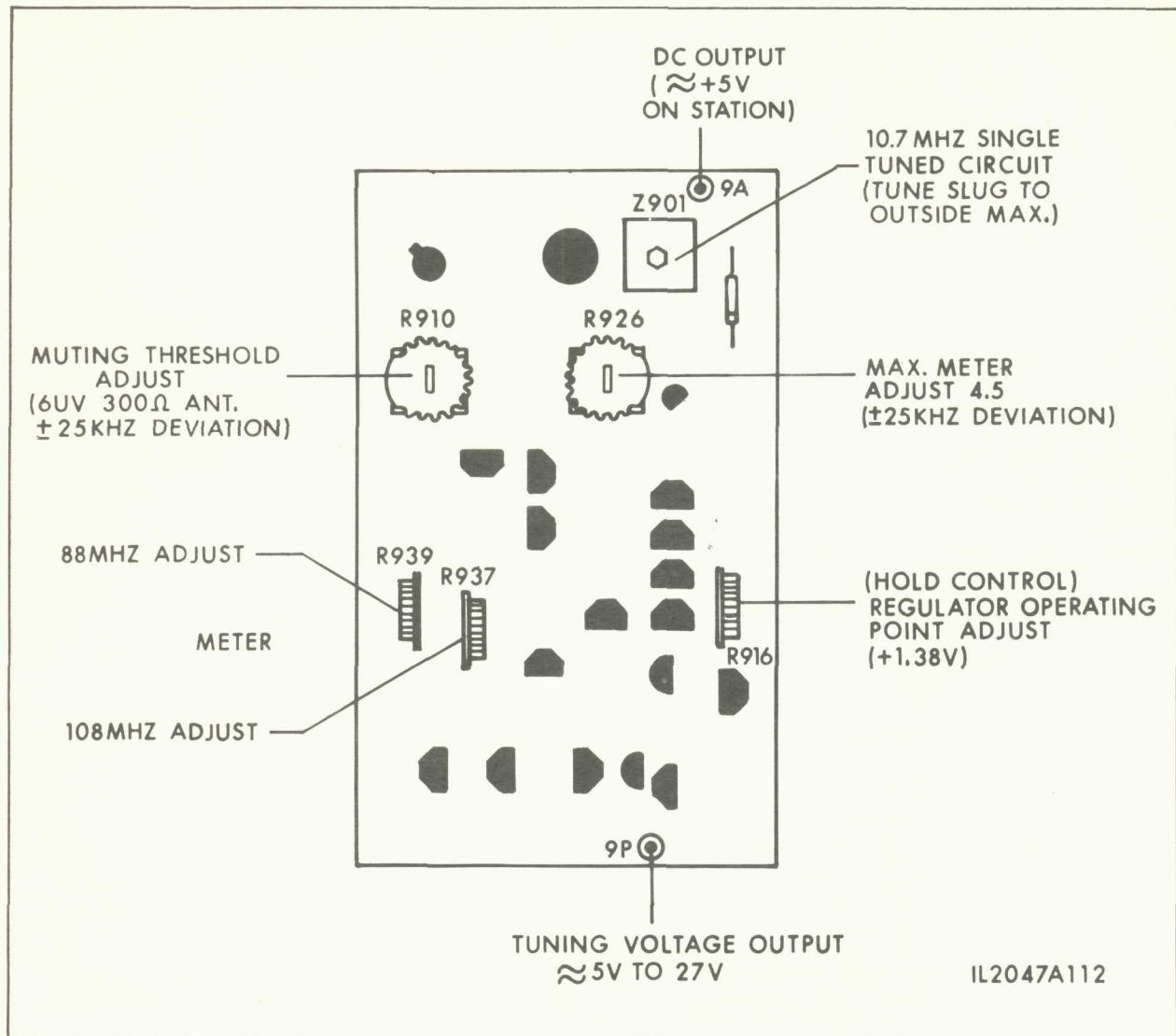

Figure 9. AUTOSCAN Board Alignment Location.

Set generator output to very low level (approximately 5uV) until noise interference is visible on sine wave. Adjust generator frequency to center noise interference on the positive and negative half cycles. See Figure 10.

(5) Set generator deviation to $\pm 25kHz$. Increase generator output to 1,000 uV. Adjust Z901 (on AUTOSCAN board) for maximum reading on front panel tuning meter.

(6) Increase generator output level to maximum (approximately 100mV) and set METER DEFLECTION ADJUST pot. R926 (on AUTOSCAN board) for front panel tuning meter indication of 4.5. Release MUTING OFF pushbutton switch to out position.

(7) Set generator output level as low as possible (to or near zero). Sine wave on scope should disappear. Slowly increase generator output level until sine wave reappears on scope. Generator output level should be 12 uV.

(8A) If output level setting is less than 12 uV, turn MUTING LEVEL pot. R910 (on AUTOSCAN board) counter-clockwise until signal disappears on scope, then set generator level to 12 uV and turn R910 slowly clockwise until signal reappears.

(8B) If output level setting is more than 12 uV, set output

level to 12 uV and turn R910 clockwise until signal reappears on scope.

(9) Repeat step (7) to check adjustment.

AUTOSCAN ADJUSTMENTS

Depress AUTOSCAN pushbutton. Set SELECTOR switch to FM, and turn VOLUME control to minimum. Depress MUTING OFF pushbutton.

(1) Connect DC VTVM to pin 9P (on AUTOSCAN board).
 (2) Press in and hold the right (upscale) AUTOSCAN TUNING pushbutton until pointer of frequency indicator moves to maximum position. DC VTVM should read +24V to +27V. Set 108 MHz ADJUST pot. R937 (on AUTOSCAN board) to center pointer on 108.

(3) Press in and hold the left (downscale) AUTOSCAN

SERVICE PROCEDURES

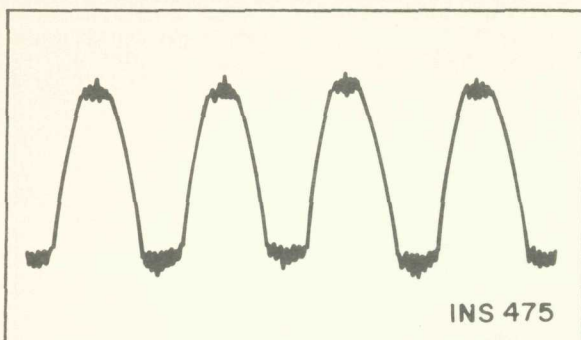

Figure 10.

TUNING pushbutton until pointer moves to minimum position. DC VTVM should read +3.5V to 5.5V. Set 88 MHz ADJUST pot. R939 (on AUTOSCAN board) to center pointer on zero (0) calibration mark (on 0-5 scale).

(4) Connect scope vertical input to either LEFT or RIGHT RC DR OUT jack. Disconnect DC VTVM from pin 9P and reconnect to pin 9V. Connect a second DC VTVM to pin 9A (on AUTOSCAN board).

(5) Connect an FM generator to the FM ANTenna terminals. Use a 120-ohm composition resistor in series with each lead from the generator (see Figure 8). Modulate generator with 400 Hz, ± 75 kHz deviation. Set generator frequency to 88 MHz, and output level to 1,000 μ V.

(6) Press in right (upscale) AUTOSCAN TUNING pushbutton momentarily (release immediately after pushing in). AUTOSCAN circuit should tune receiver to FM generator signal and sine wave should appear on scope.

(7) Carefully adjust HOLD CONTROL pot. R916 (on AUTOSCAN board) for maximum reading on second DC VTVM (+3.5V to 4.5V on pin 9A). Note that first DC VTVM should indicate 0 volt on pin 9V when second DC VTVM indicates maximum voltage on pin 9A. Signal trace on scope should be clean sine wave.

(8) Reduce FM signal generator output level to 15 μ V. Sine wave on scope should remain locked in.

(9) Press in left (downscale) AUTOSCAN TUNING pushbutton momentarily, to make signal disappear. Press in right (upscale) pushbutton momentarily. AUTOSCAN circuit should retune receiver to FM generator signal and sine wave should reappear on scope.

(10) Set FM signal generator frequency to 108 MHz, and output level to 1,000 μ V. Press in right (upscale) pushbutton until AUTOSCAN circuit tunes to generator frequency. Repeat steps (8) and (9).

AFC TEST

NOTE: FM IF, Detector, and Front End Alignment should be checked before starting this procedure.

Depress MANUAL pushbutton, and turn AFC switch to OFF. Depress MUTING OFF pushbutton switch. Set SELECTOR switch to FM, and MODE/TAPE MONITOR switch to MONO.

(1) Set MANUAL TUNING dial pointer to strong local station, for tuning meter reading of approximately 4.5.

(2) Detune slowly, downscale, until tuning meter indicates 2.5. Turn AFC switch to ON. Tuning meter should indicate between 4 and 5.

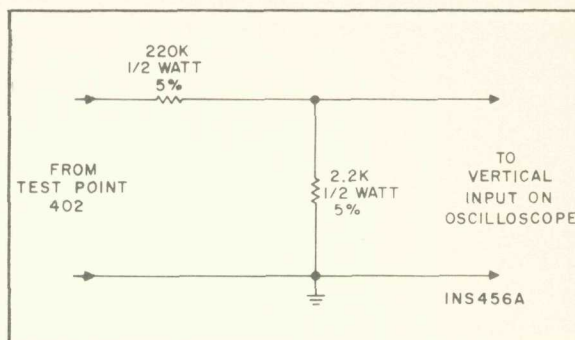

Figure 11. Voltage Divider Probe.

(3) Turn AFC switch to OFF. Carefully retune to station. Detune slowly, upscale, until tuning meter indicates 2.5. Turn AFC switch to ON. Tuning meter should indicate between 4 and 5.

MULTIPLEX ALIGNMENT

Two methods of aligning the multiplex decoder are given. The preferred procedure uses a multiplex generator with RF and 19 kHz outputs and with 1 kHz modulation, such as the FISHER 300 Multiplex Generator. This is the better method of alignment because the front end and IF stages are also checked through the use of this procedure. An alternate procedure for use with multiplex generators not having an RF output is also given.

PREFERRED ALIGNMENT PROCEDURE

NOTE: Check the alignment of the IF amplifier before aligning the multiplex decoder. Poor IF alignment can make proper MPX adjustment impossible.

Depress MANUAL pushbutton, and turn AFC switch to OFF. Depress MUTING OFF pushbutton switch. Set SELECTOR switch to FM, and MODE/TAPE MONITOR switch to STEREO. Turn VOLUME control to minimum.

(1) Connect RF output of multiplex generator to the FM ANTenna terminals. Use a 120-ohm composition resistor in series with each lead from the RF output (see Figure 8). Set MPX generator for external modulation with 19 kHz pilot carrier, ± 7.5 kHz deviation (10% pilot, no audio). Tune receiver to RF frequency of MPX generator.

(2) Connect DC VTVM to Test Point 403 (pin 4G on AM/FM IF, MPX board).

(3) Adjust cores of Z401 and Z402 (on AM/FM IF, MPX board) for maximum reading on DC VTVM.

(4) Connect output of audio generator, set for 1 kHz, to the external modulation input of MPX generator and to external sync input of an oscilloscope. Adjust audio generator level for composite signal ± 75 kHz deviation (10% pilot, 90% audio).

(5) Connect AC VTVM to LEFT RC DR OUT jack. Connect scope through voltage divider probe (see Figure 11) to Test Point 402 (4K on AM/FM IF, MPX board).

SERVICE PROCEDURES

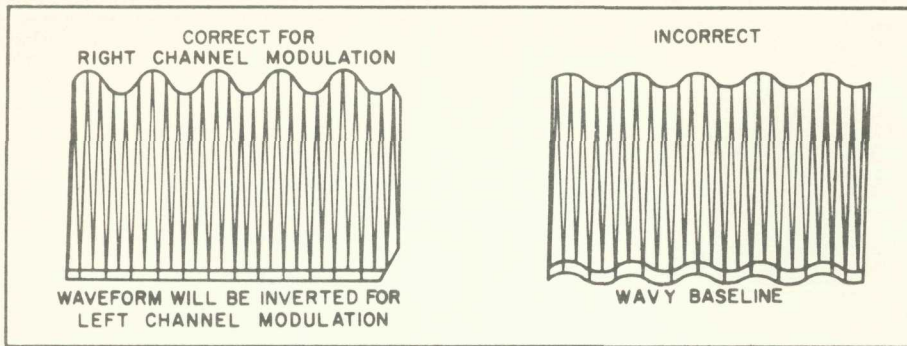

Figure 12. Waveform At Test Point 402

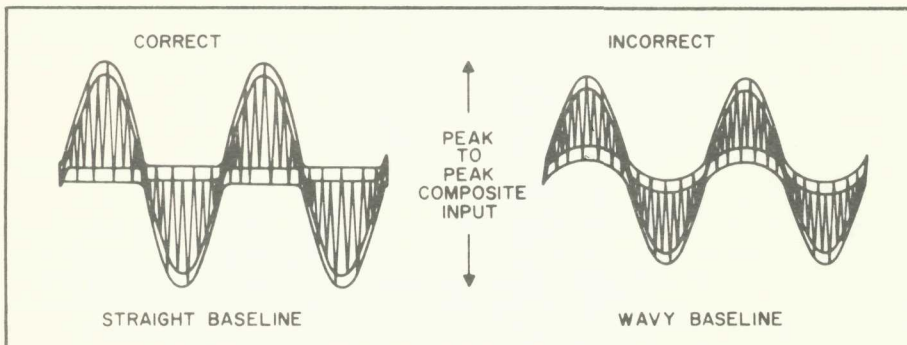

Figure 13. Composite Input To Multiplex Decoder

(6) Set R107 SEPARATION CONTROL (on preamplifier board) to mechanical center. Adjust core of Z403 (on AM/FM IF, MPX board) for maximum gain and as straight a base-line as possible on scope (see Figure 12). AC VTVM should read minimum.

(7) With MPX generator modulated on right channel only, connect AC VTVM to RIGHT RCDR OUT jack. Record reading on AC VTVM.

(8) Set MPX generator to modulate left channel only. Adjust R107 SEPARATION CONTROL (on preamplifier board) for minimum reading on AC VTVM; at least 35 dB below reading recorded in step (7). Record reading.

(9) Connect AC VTVM to LEFT RCDR OUT jack. Same reading ± 2 dB as recorded in step (7).

(10) Set MPX generator to modulate right channel only. Same reading ± 3 dB as recorded in step (8).

NOTE: If equal readings cannot be obtained in steps (8) and (10) Readjust Z402 slightly (on AM/FM IF, MPX board) and repeat steps (7) through (10).

Adjust pilot level for approximately 120 mV peak-to-peak input at pin 4A.

(4) Adjust cores of Z401 and Z402 (on AM/FM IF, MPX board) for maximum reading on DC VTVM.

(5) Connect output of audio generator, set for 1 kHz, to the external modulation input of MPX generator and to the external sync input of an oscilloscope. Adjust audio generator level for 1.2 volts peak-to-peak composite MPX input (10% pilot, 90% audio). See Figure 13. Modulate right channel only. Proceed with steps (5) through (10) of PREFERRED ALIGNMENT PROCEDURE.

(6) Reconnect the jumper lead going to pin 4A (on AM/FM IF, MPX board) removed previously.

AM IF ALIGNMENT

ALTERNATE ALIGNMENT PROCEDURE

Set SELECTOR switch to FM, and MODE/TAPE MONITOR switch to STEREO. Turn VOLUME control to minimum.

(1) Disconnect the jumper lead going to pin 4A (on AM/FM IF, MPX board) and connect the output of the multiplex generator through a 15k resistor to pin 4A.

(2) Connect DC VTVM to Test Point 403 (pin 4G on AM/FM IF, MPX board). Connect the vertical input of the scope to pin 4A.

(3) Set MPX generator for 19 kHz pilot carrier output only.

Set SELECTOR switch to AM, and MODE/TAPE MONITOR switch to MONO. Turn VOLUME control to minimum.

(1) Connect 455 kHz sweep generator to Test Point 502 (pin 5N on AM RF board). Use a 0.1 μ F capacitor in series with the generator lead. Connect generator ground to pin 5C.

(2) Connect vertical input of scope to Test Point 503 (pin 5R on AM RF board). Connect scope ground to pin 5J.

(3) Temporarily disconnect IF output lead from pin 5K. Adjust generator level and sweep to observe IF response curve. Set generator output as low as possible.

(4) Align top and bottom cores of Z503 (on AM RF board) for maximum gain and symmetry (see Figure 14). Reconnect

SERVICE PROCEDURES

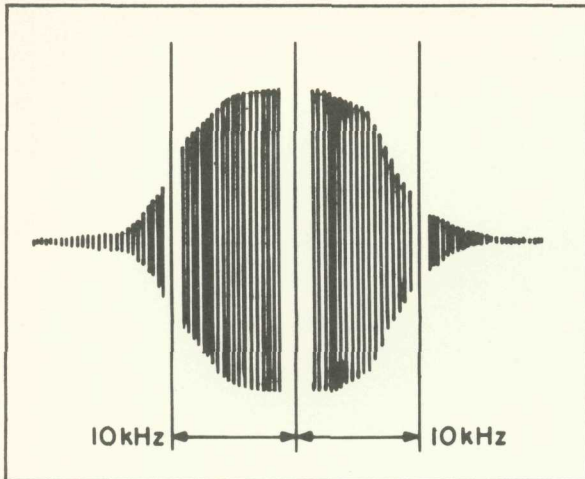

Figure 14.

IF output lead to pin 5K (removed previously).
 (5) Disconnect scope input and ground from AM RF board. Connect scope input to Test Point 306 (pin 3Q on AM/FM IF, MPX board). Connect scope ground to pin 3R.
 (6) Align top and bottom cores of Z301 and Z303 (on AM/FM IF, MPX board) for maximum gain and symmetry (see Figure 15).

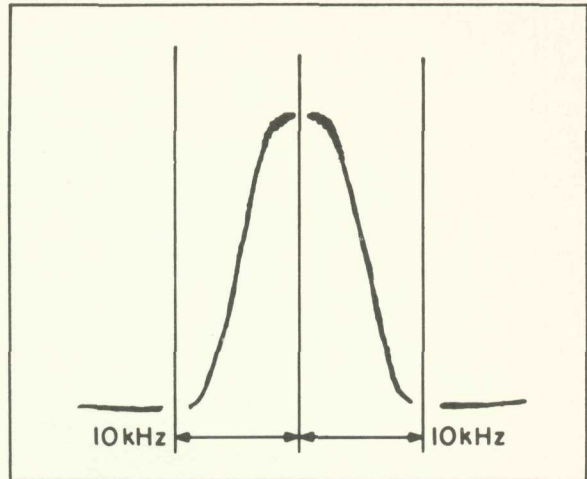

Figure 15.

AM RF ALIGNMENT

NOTE: AM IF alignment should be performed before starting this procedure.

Set SELECTOR switch to AM, and MODE/TAPE MONITOR switch to MONO. Turn VOLUME control to minimum.

(1) Set MANUAL TUNING dial pointer to zero (0) calibration mark on the logging scale. If the dial pointer does not coincide with the 0 at the extreme end of knob rotation, reposition the pointer assembly on the dial cord and cement the pointer in place to prevent slippage. Allow cement to thoroughly dry.

NOTE: Repositioning the dial pointer may require realignment of FM RF board for correct FM station calibration.

(1) Open the AM ANTenna GND link at the antenna terminals. Connect an AM generator to the AM ANTenna and GND terminals.

(3) Connect a scope and an AC VTVM to either the LEFT or RIGHT RCDR OUT jack.

(4) Set AM generator frequency and MANUAL TUNING dial pointer to 600 kHz. Use 30% modulation with 400 Hz. Set generator output as low as possible.

(5) Align oscillator coil Z502 (on AM RF board) for maximum reading on AC VTVM and maximum waveform amplitude and symmetry.

(6) Set AM generator frequency and MANUAL TUNING dial pointer to 1400 kHz. Adjust oscillator trimmer C535 (on AM RF board) for maximum reading on AC VTVM and maximum waveform amplitude and symmetry.

(7) Repeat alignment several times until maximum gain and symmetry are obtained. Keep generator output as low as possible during all adjustments.

(8) Reset AM generator frequency and MANUAL TUNING dial pointer to 600 kHz. Align mixer coil Z501 and RF coil L501 for maximum reading on AC VTVM, and clean sine wave on scope.

(9) Reset AM generator frequency and MANUAL TUNING dial pointer to 1400 kHz. Adjust mixer trimmer C534, and antenna trimmer C533 for maximum audio indication on AC VTVM and clean sine wave on scope.

(10) Repeat steps (8) and (9) several times until maximum gain is obtained. Keep generator output as low as possible during all adjustments.

(11) Set MANUAL TUNING dial pointer to approximately 600 kHz. Tune to local noise, or weak station for tuning meter reading of approximately 2.5. Place loop-end of Test Loop Stick (see Figure 16) near end of receiver antenna. Observe tuning meter. Place ferrite core-end of Test Loop Stick near end of receiver antenna. Observe tuning meter. If tuning meter reading decreases when loop-end, or rod-end of Test Loop Stick is brought near receiver antenna, antenna circuit is correctly aligned.

NOTE: Loop-end of Test Loop Stick decreases antenna inductance; rod-end of Test Loop Stick increases antenna inductance.

(12) Repeat step (11) at 1400 kHz.

(13) Close AM ANTenna GND link (opened previously).

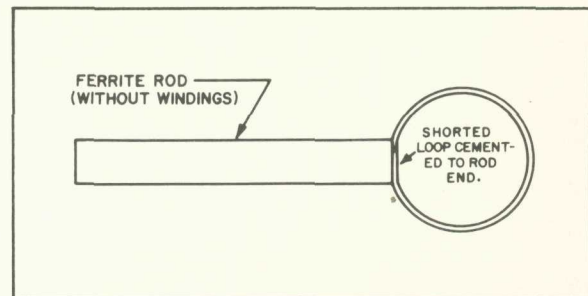
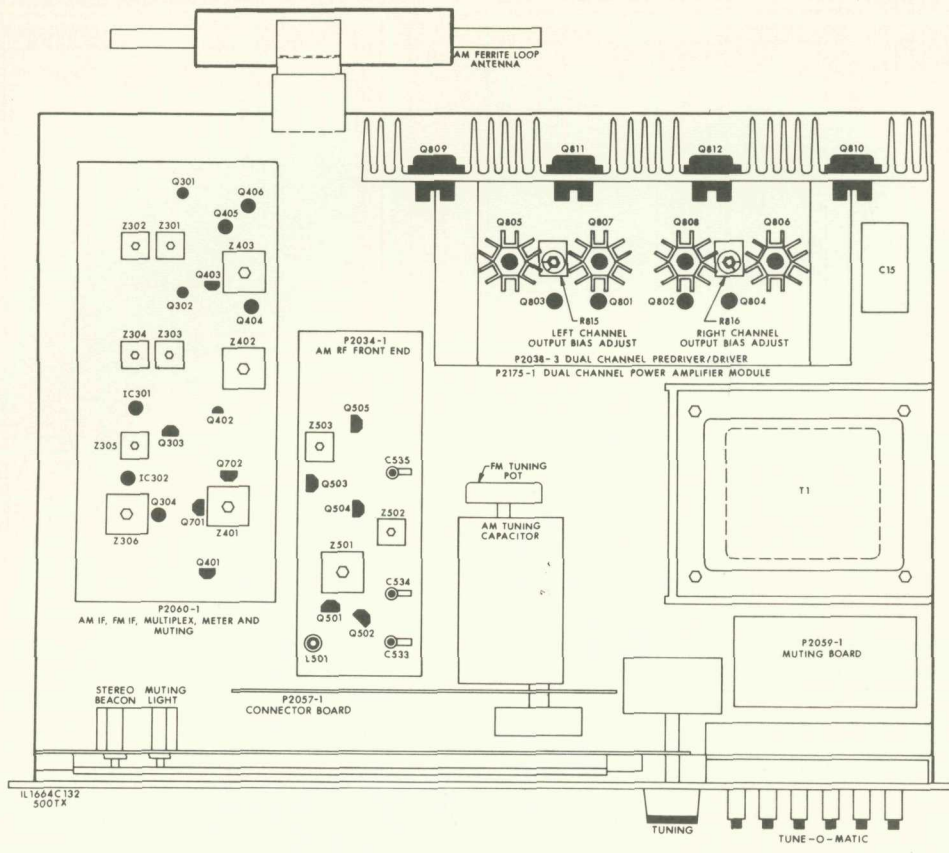

Figure 16. Test Loop Stick. Single (Shorted) Loop Of Wire Mounted On End Of Ferrite Rod. Loop Diameter, Wire Size, Or Ferrite Material Non-Critical.

CHASSIS LAYOUT

TOP



BOTTOM

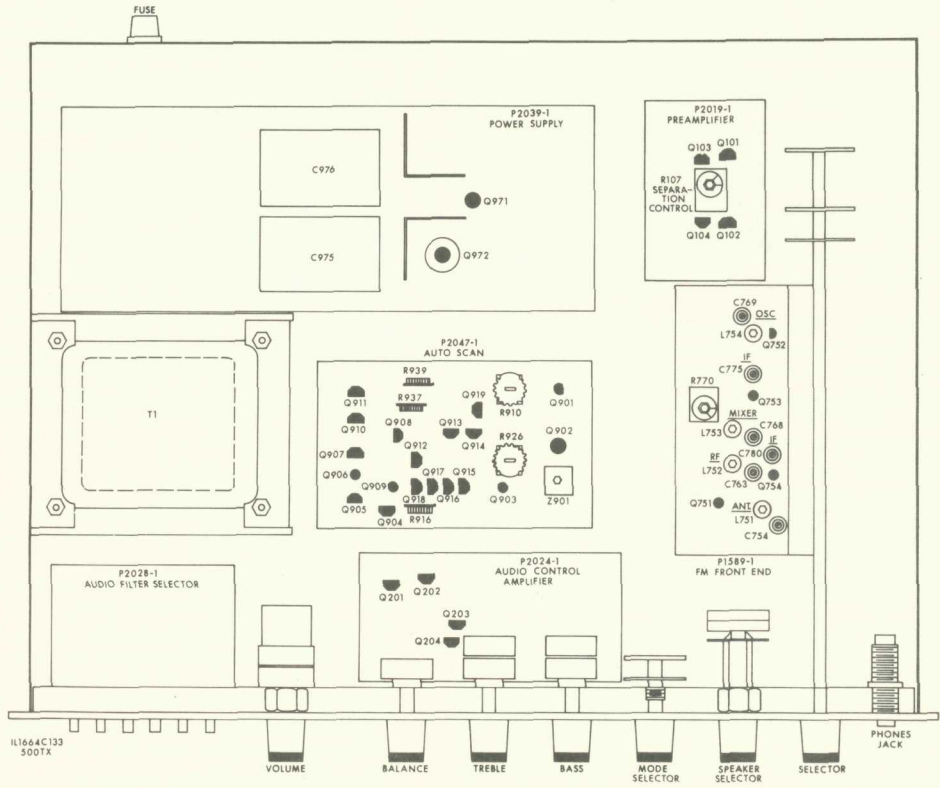

1589-1 FM RF

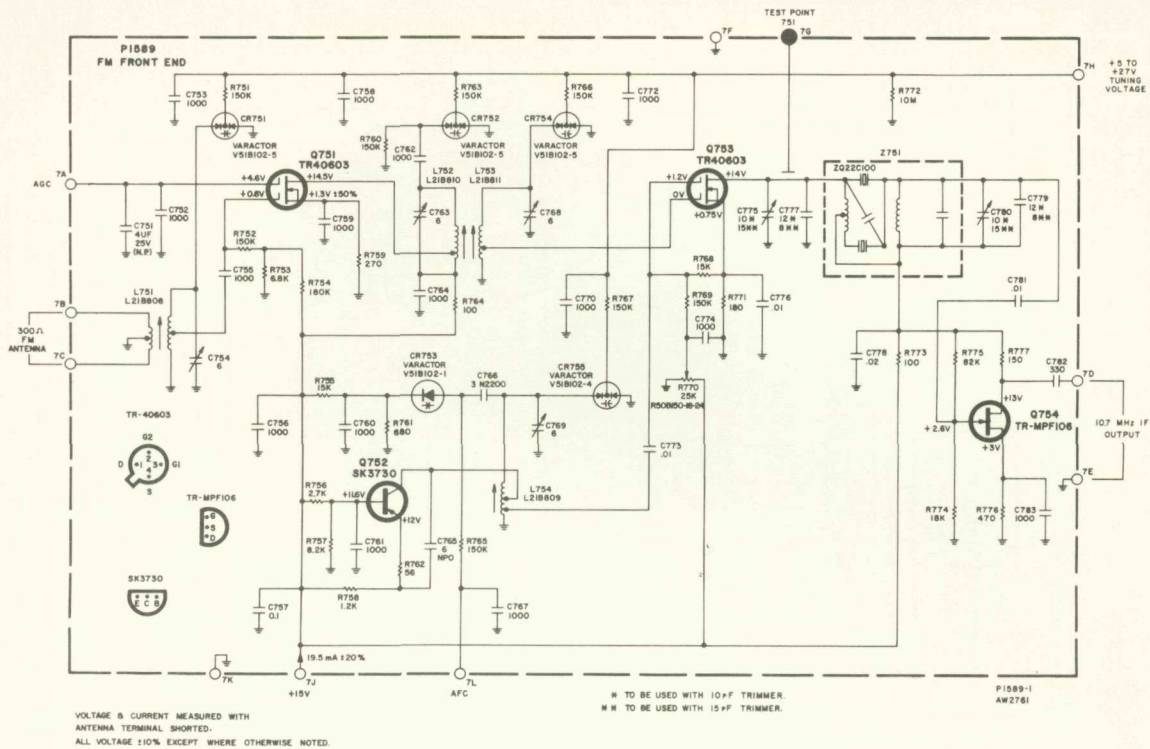

BOARD VIEWED FROM COMPONENT SIDE

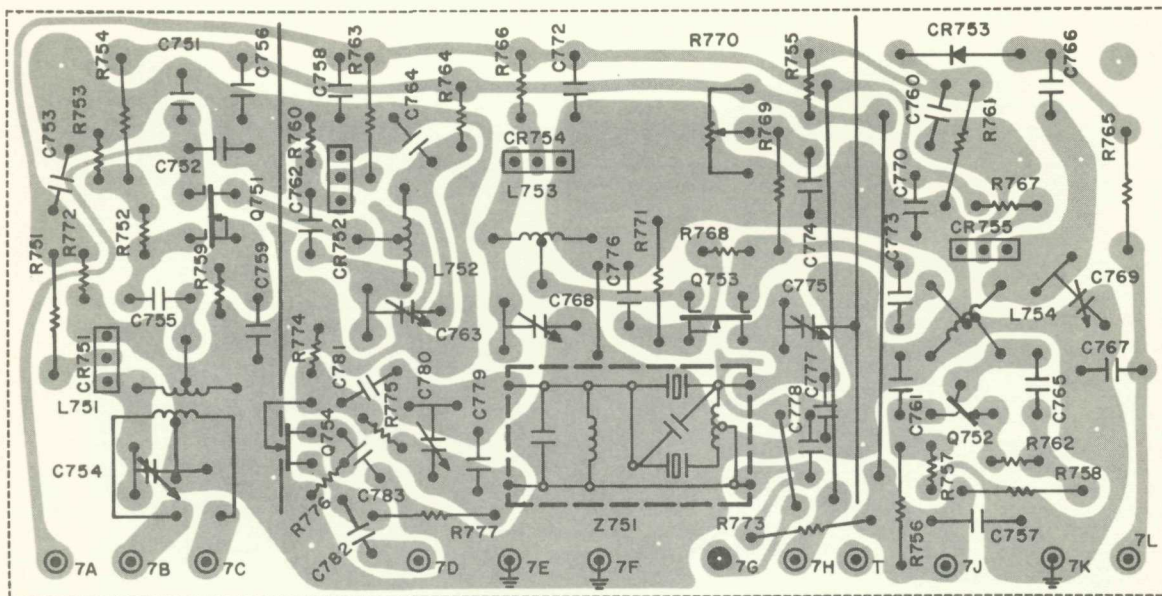

AGC FM ANTENNA 10.7 MHz IF OUTPUT TEST POINT 75 +5 TO 27V TUNING VOLTAGE +15V AFC

T=LUG USED FOR EASE IN WIRING

IL1589BIII
P1589

2034-1 AM RF

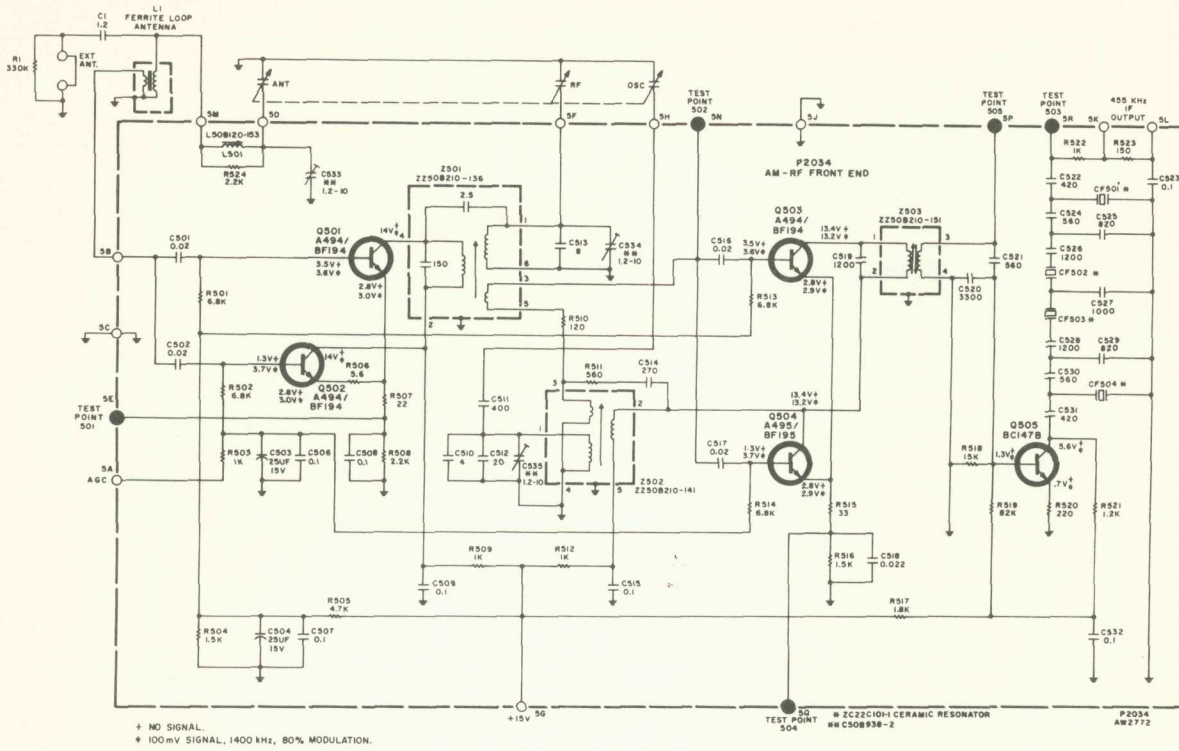

BOARD VIEWED FROM COMPONENT SIDE

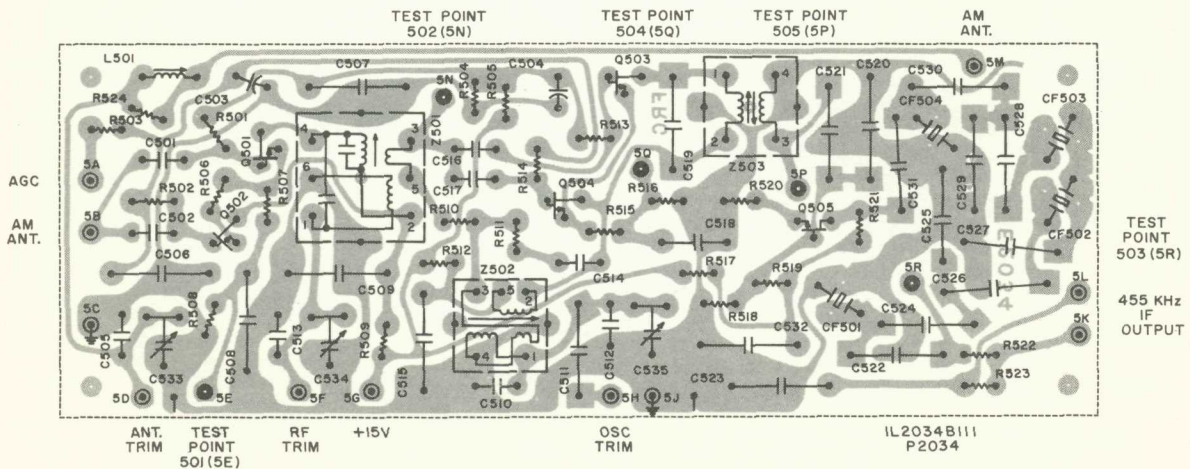

2057-1 CONNECTOR

BOARD VIEWED FROM COMPONENT SIDE

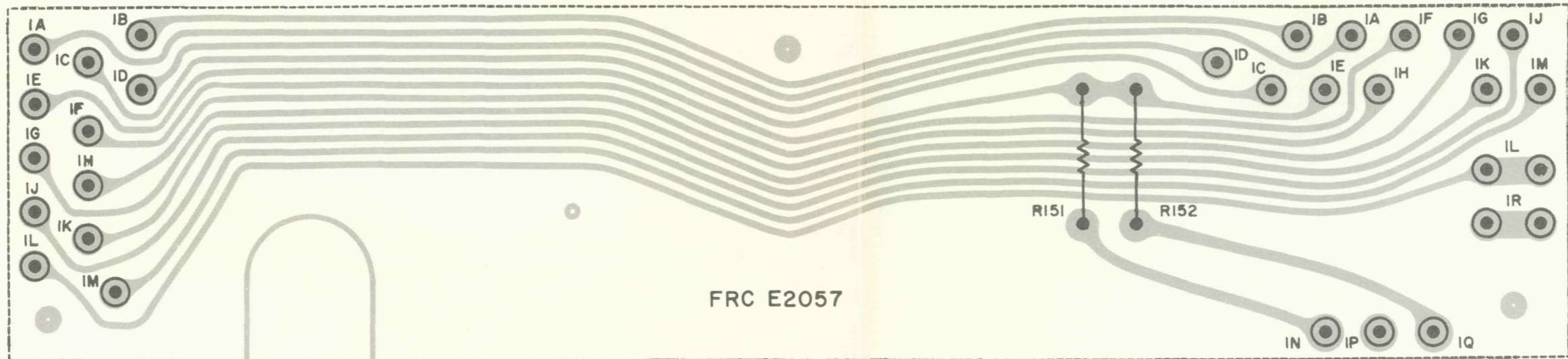

IL2057B111
P2057

2061-1 TERMINAL BOARD

BOARD VIEWED FROM COMPONENT SIDE

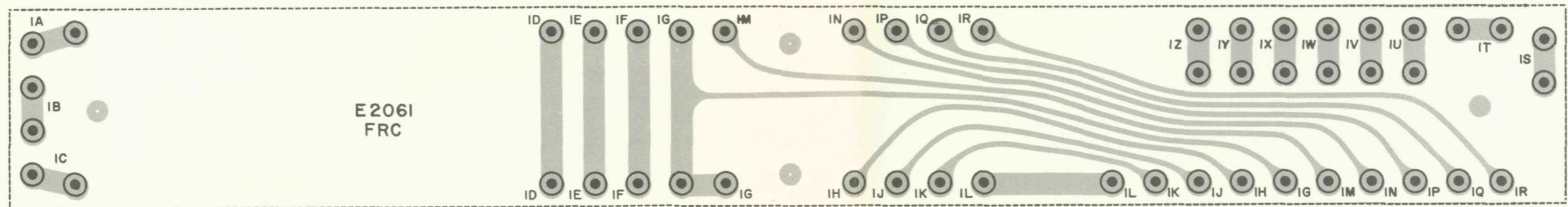

IL2061C111
P2061

2060-1 AM-FM IF, MPX, METER, MUTING

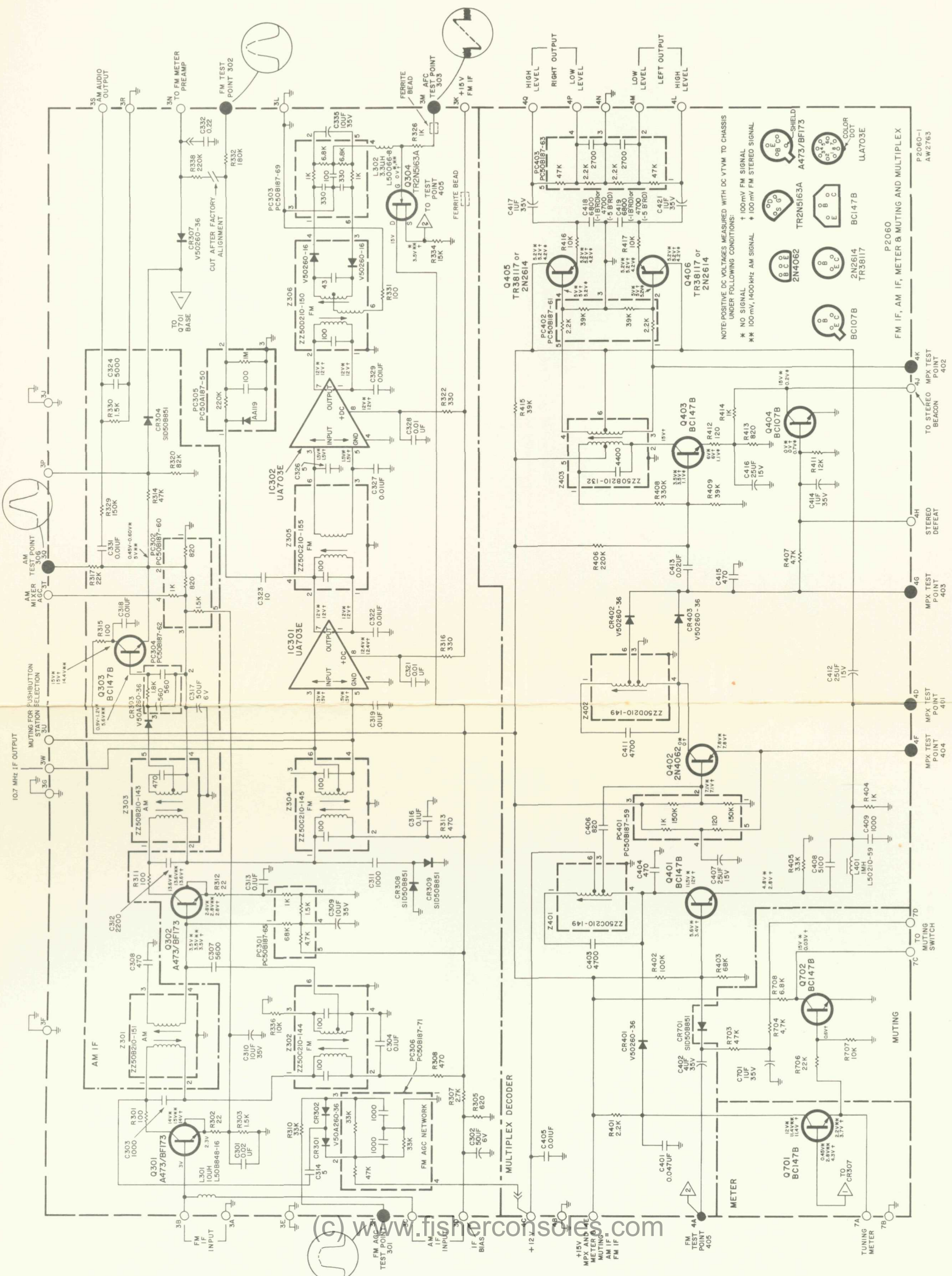

(c) www.fisherco.com

2060-1 AM-FM IF, MPX, METER, MUTING

BOARD VIEWED FROM COMPONENT SIDE

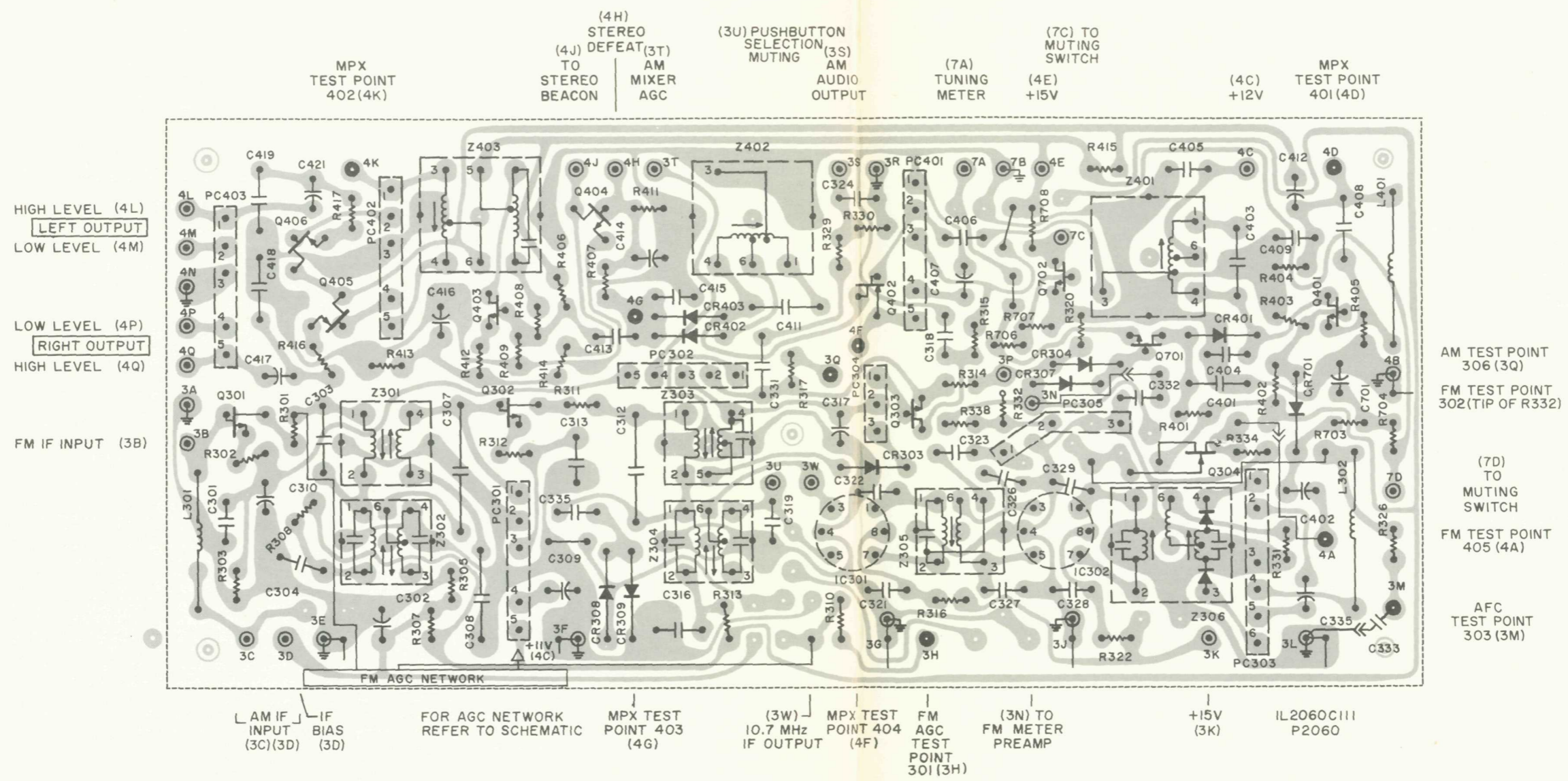

2059-1 MUTING

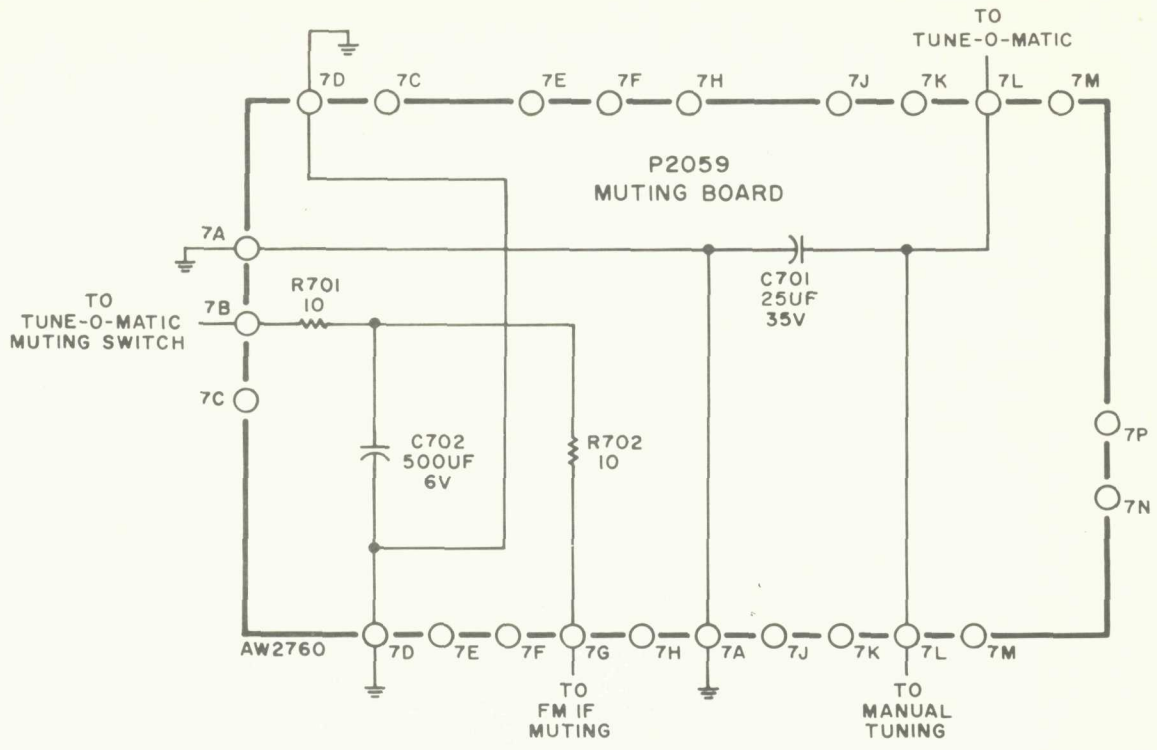

BOARD VIEWED FROM COMPONENT SIDE

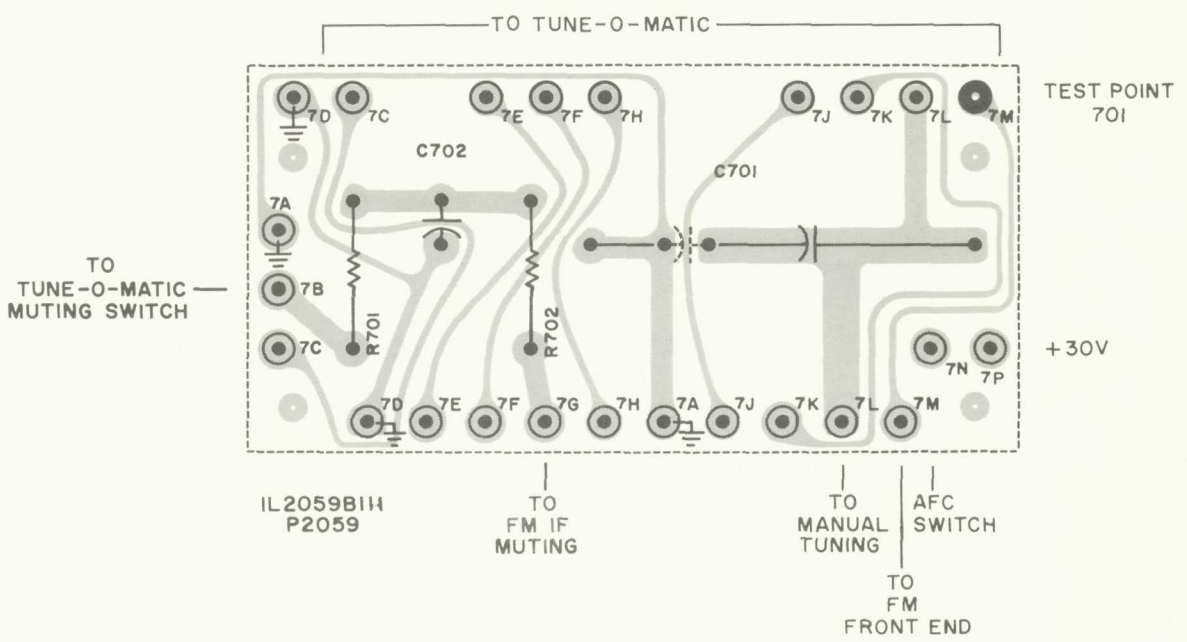

2047-1 AUTOSCAN

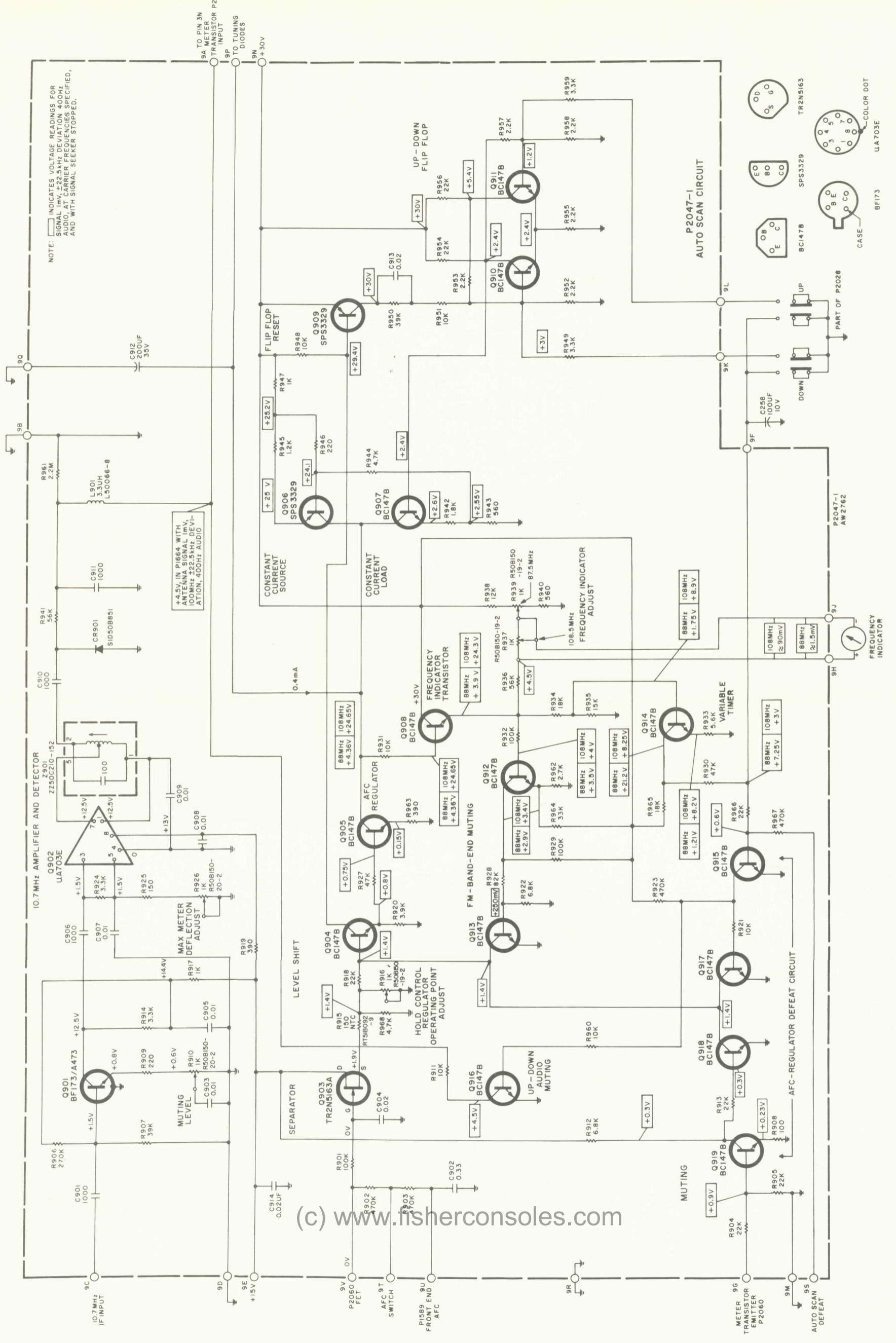

(c) www.fisherconsoles.com

BOARD VIEWED FROM COMPONENT SIDE

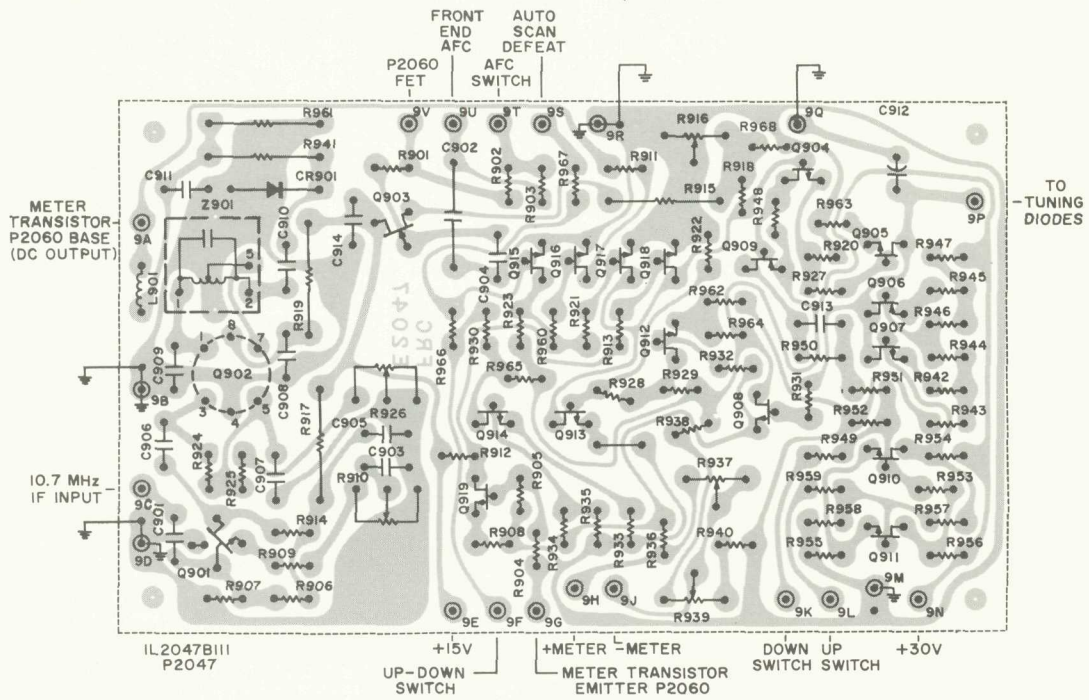

2019-4 PREAMPLIFIER

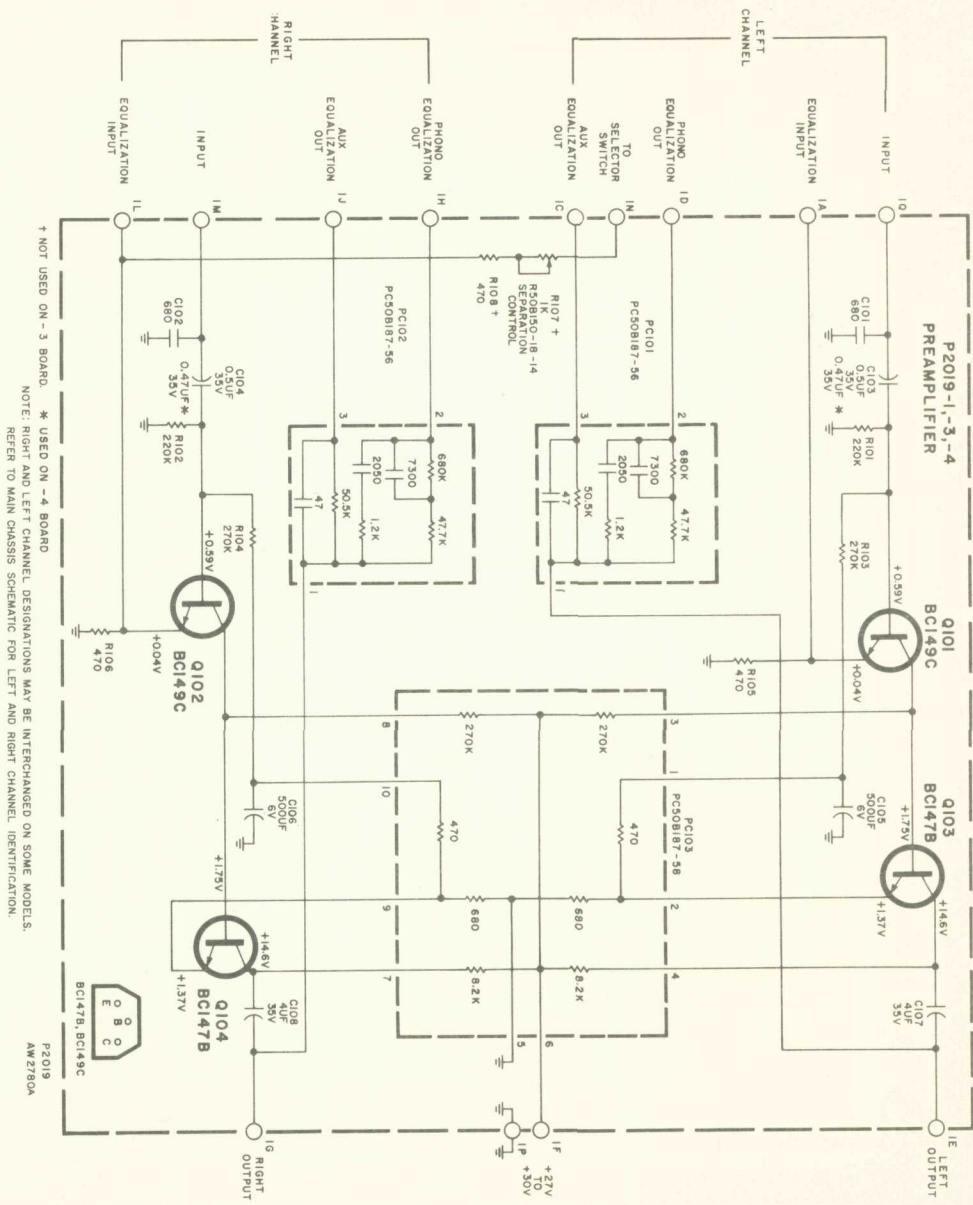

BOARD VIEWED FROM COMPONENT SIDE

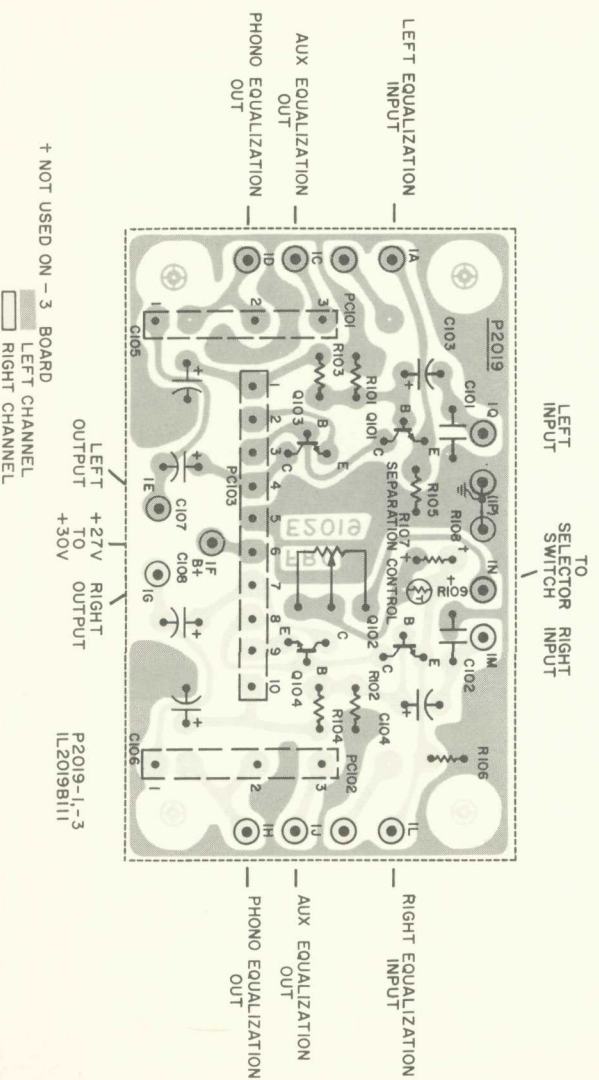

2024-1 AUDIO CONTROL AMPLIFIER

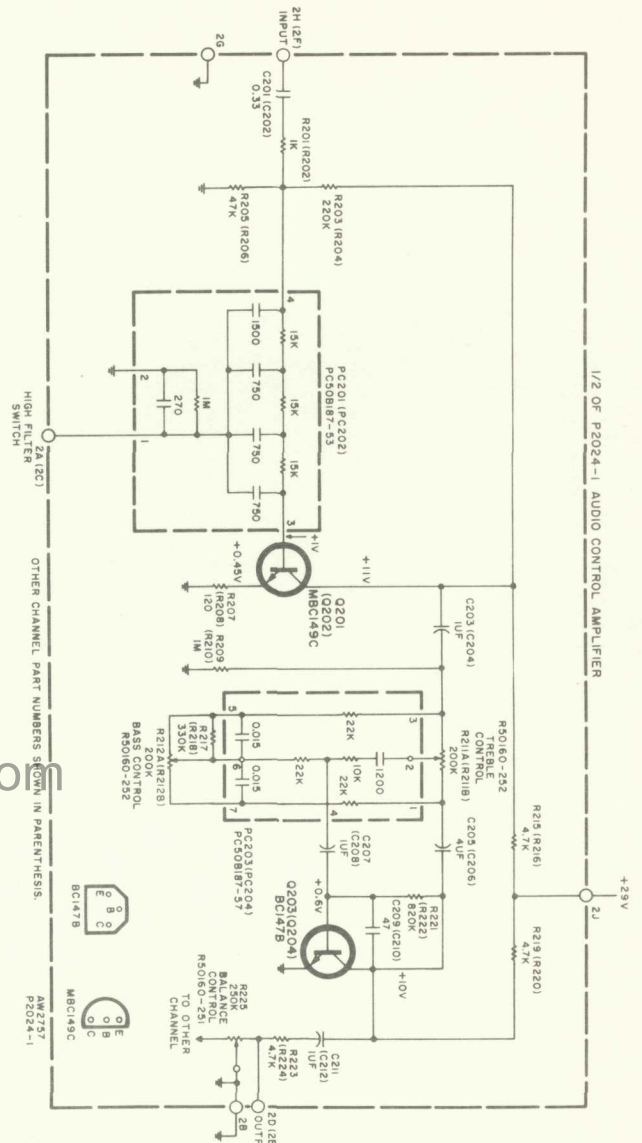

BOARD VIEWED FROM COMPONENT SIDE

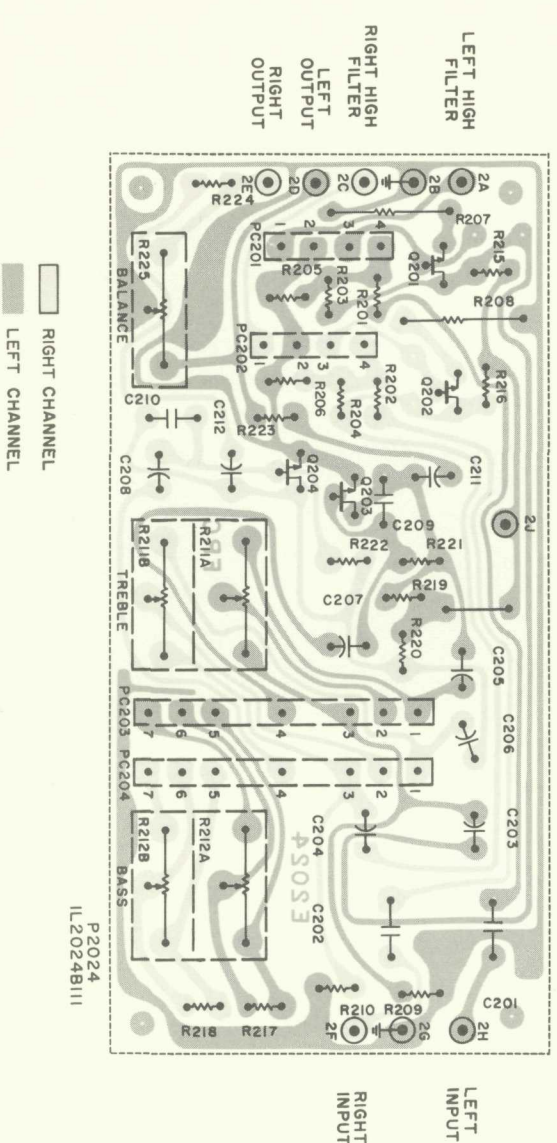

(c) www.fisherconsoles.com

2028-1 AUDIO FILTER SELECTOR

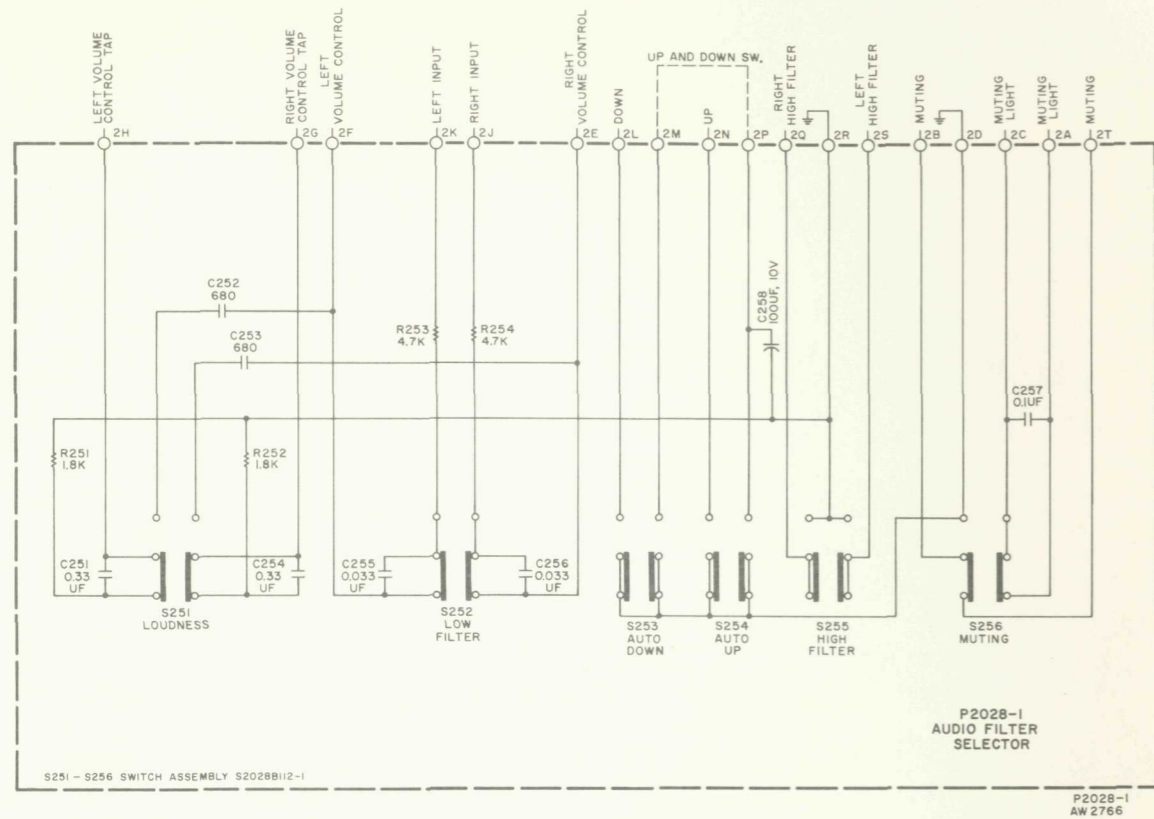

BOARD VIEWED FROM COMPONENT SIDE

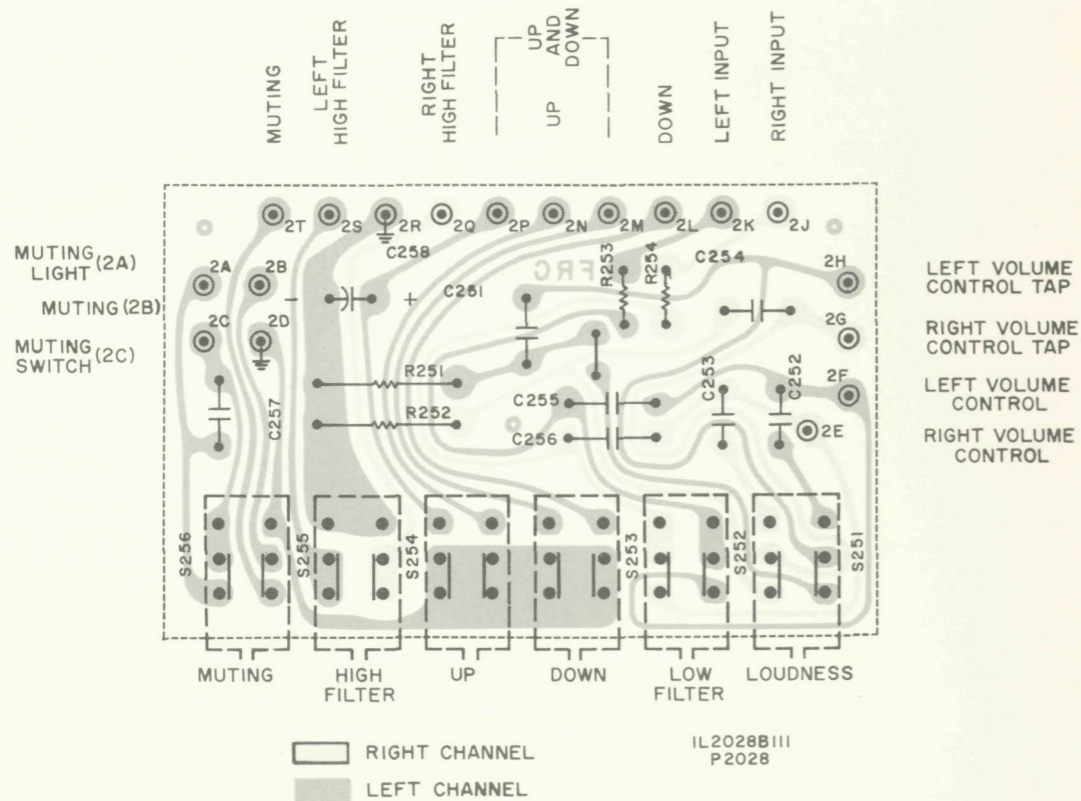

2175-1 POWER AMPLIFIER MODULE

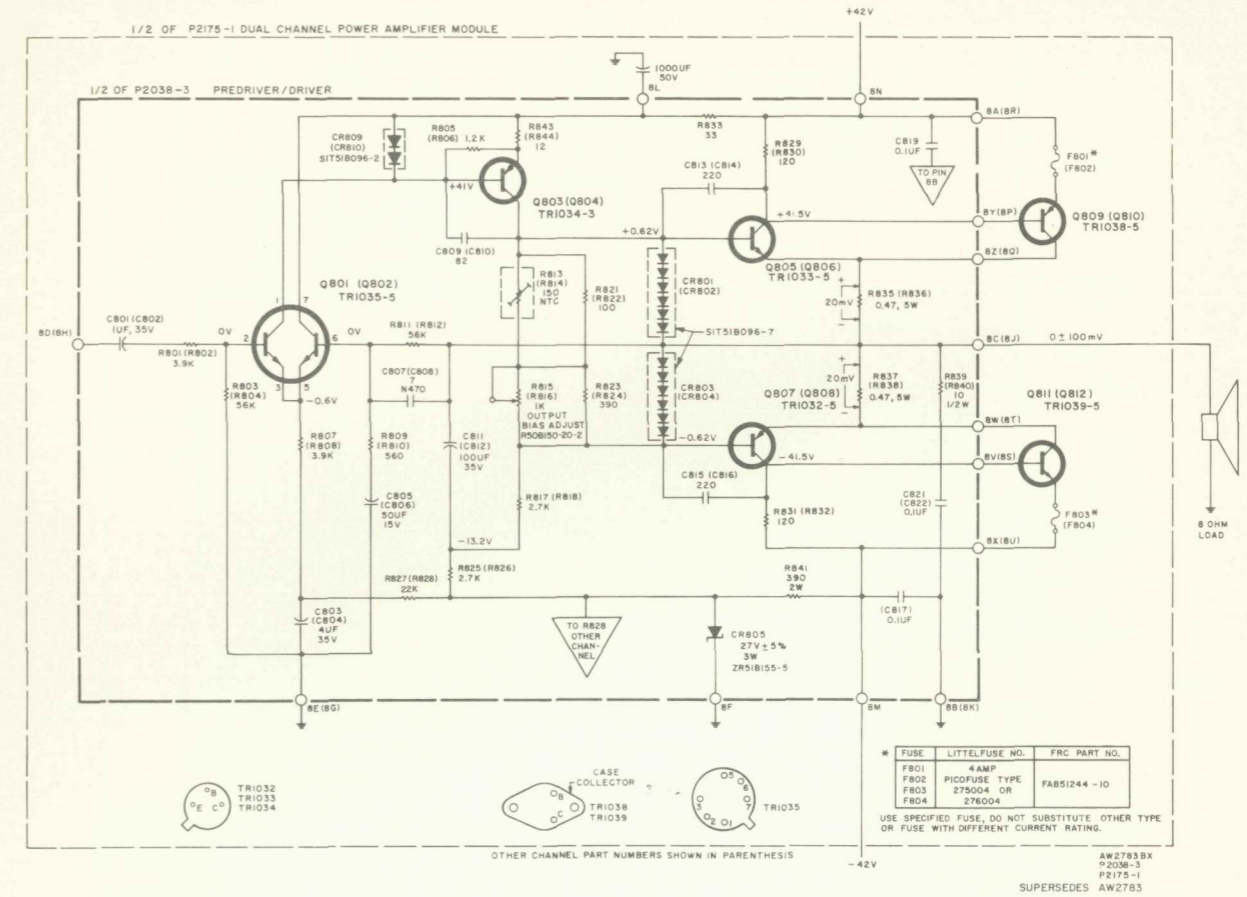

BOARD VIEWED FROM COMPONENT SIDE

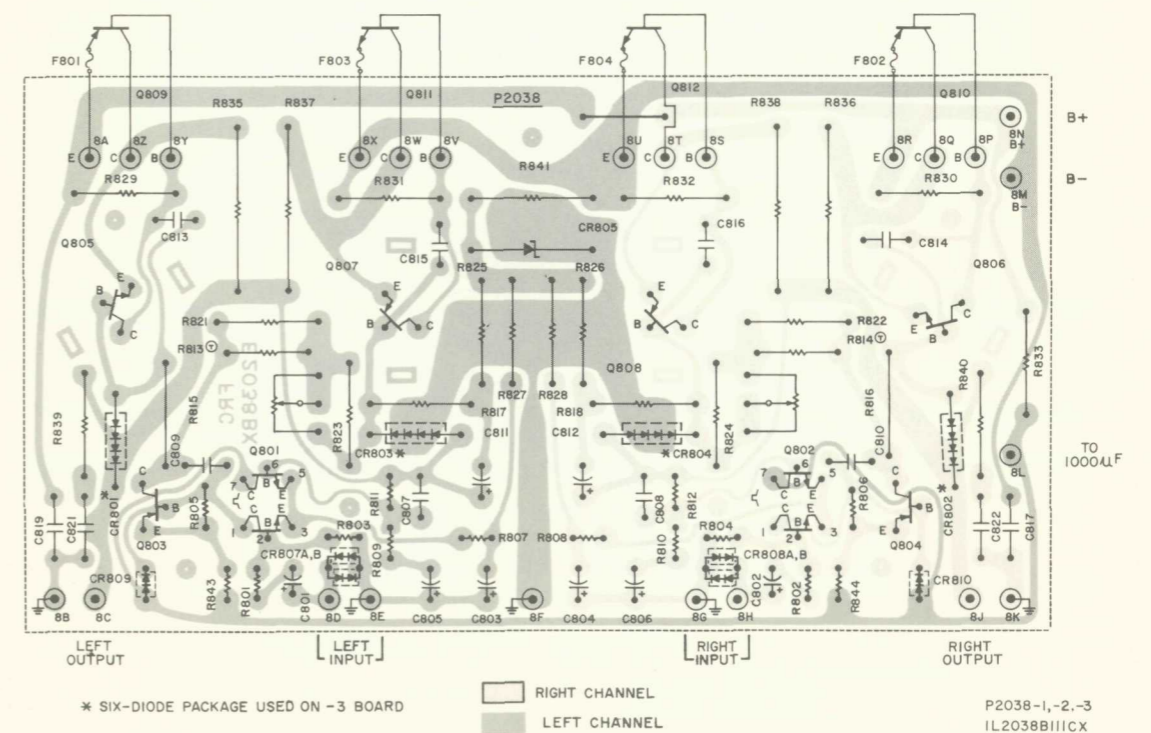

2039-1 POWER SUPPLY

SCHEMATIC SHOWN ON MAIN CHASSIS DIAGRAM

BOARD VIEWED FROM COMPONENT SIDE

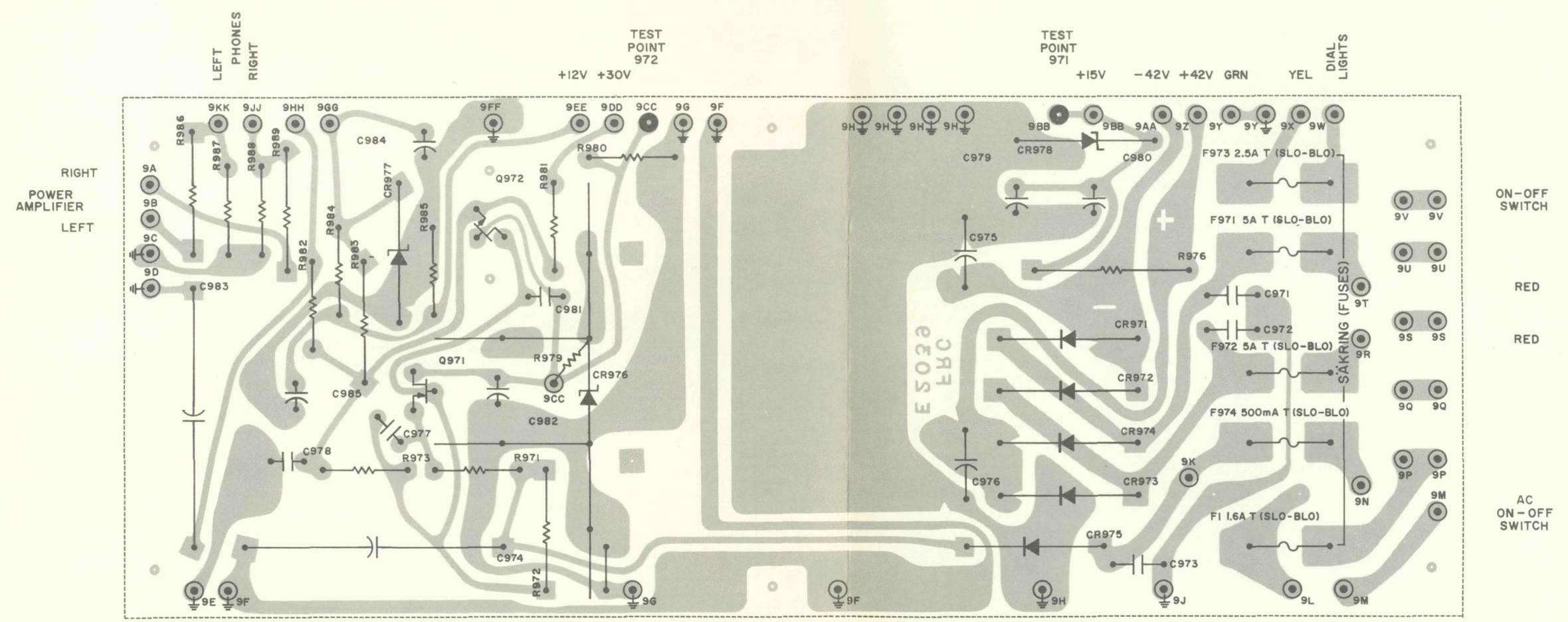

IL2039CIII-2 B
P2039

MAIN CHASSIS – TUNER SECTION

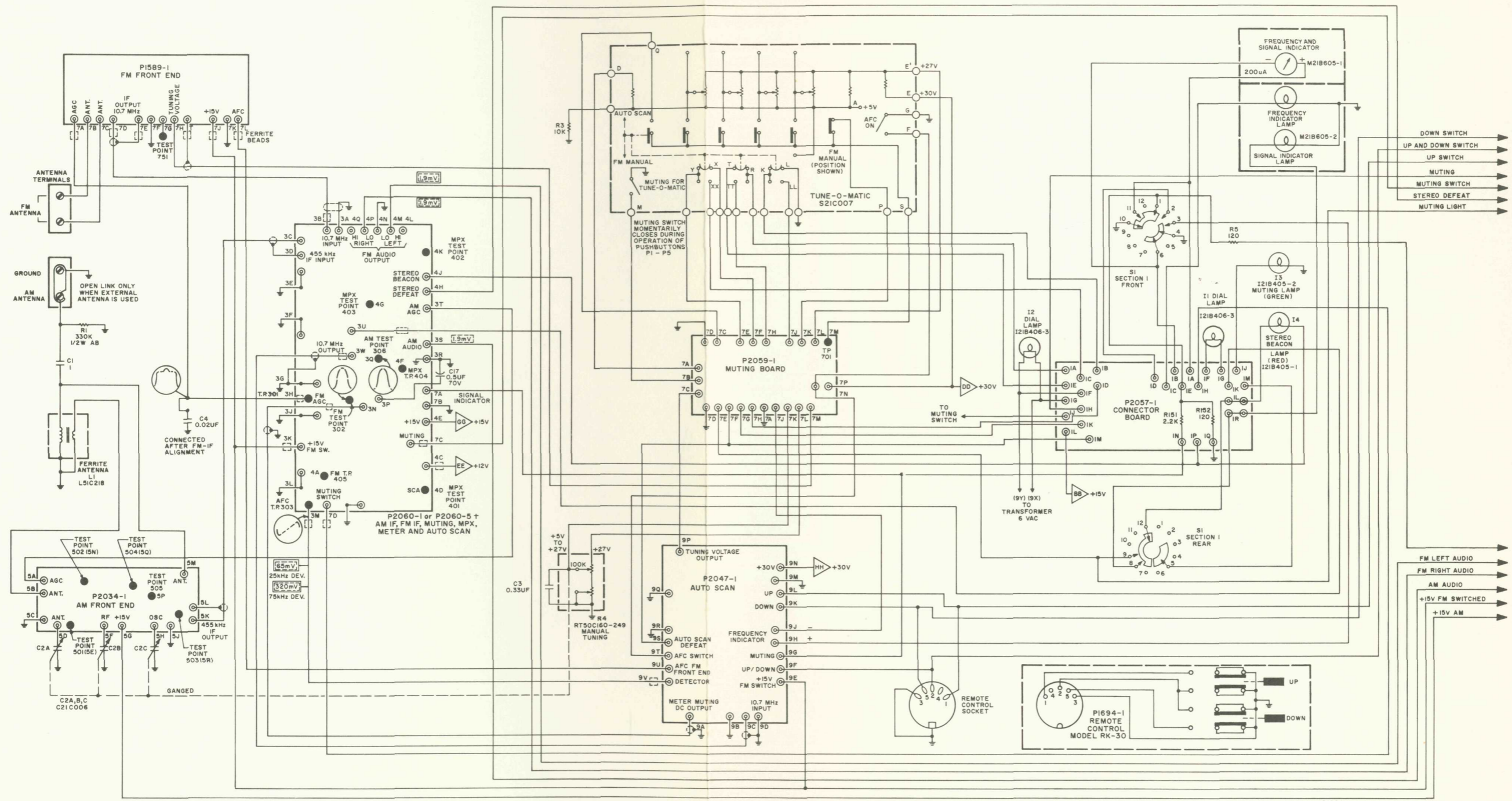

P1664
AW2764

MAIN CHASSIS — AMPLIFIER SECTION

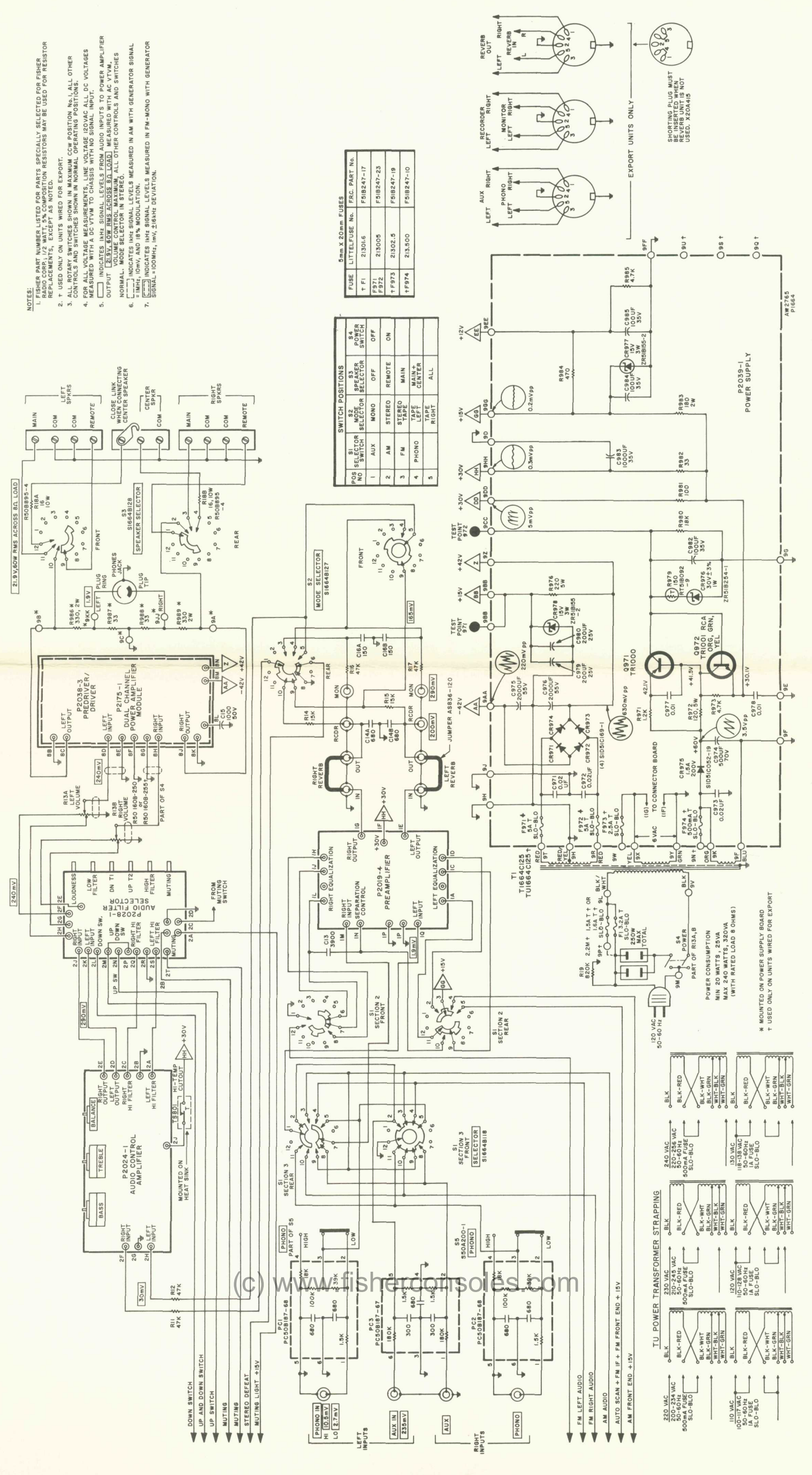

- NOTES:**
1. RESISTOR PART NUMBERS LISTED FOR PARTS ESPECIALLY SELECTED FOR FISHER RADIO CORP. 1/2 WATT, 5% COMPOSITION RESISTORS MAY BE USED FOR RESISTOR REPLACEMENTS, EXCEPT AS NOTED.
 2. † USED ONLY ON UNITS WIRED FOR EXPORT.
 3. ALL ROTARY SWITCHES SHOWN IN MAXIMUM CCW POSITION No.1, ALL OTHER CONTROLS AND SWITCHES SHOWN IN NORMAL OPERATING POSITIONS.
 4. FOR ALL VOLTAGE MEASUREMENTS, LINE VOLTAGE 120VAC ALL DC VOLTAGES MEASURED WITH A DC VTVM TO CHASSIS WITH NO SIGNAL INPUT.
 5. □ INDICATES INHz SIGNAL LEVELS FROM AUDIO INPUTS TO POWER AMPLIFIER OUTPUT. [REVERSE] INDICATES INHz SIGNAL LEVELS MEASURED WITH AC VTVM. [REVERSE] INDICATES INHz SIGNAL LEVELS MEASURED IN AM WITH GENERATOR SIGNAL NORMAL. MODE SELECTOR IN STEREO. ALL OTHER CONTROLS AND SWITCHES IN NORMAL POSITION.
 6. [REVERSE] INDICATES INHz SIGNAL LEVELS MEASURED IN AM WITH GENERATOR SIGNAL. [REVERSE] INDICATES INHz SIGNAL LEVELS MEASURED IN FM-MONO WITH GENERATOR SIGNAL.
 7. SIGNAL = 100mV, 1mV, 2.5mV DEVIATION.

5mm X 20mm FUSES

FUSE LITTLE FUSE No.	FRC. PART No.
T F1	21301-6
F971	21300-8
F972	21300-8
F973	21302-5
F974	21350-0

SWITCH POSITIONS

POS. NO.	S1 SELECTOR SWITCH	S2 MODE SELECTOR	S3 SPEAKER SELECTOR	S4 POWER SWITCH
1	AUX	MONO	OFF	OFF
2	AM	STEREO	REMOTE	ON
3	FM	STEREO	MAIN	
4	PHONO	TAPE	LEFT CENTER	
5		RIGHT	ALL	

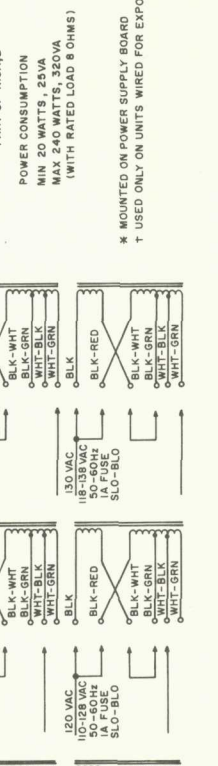
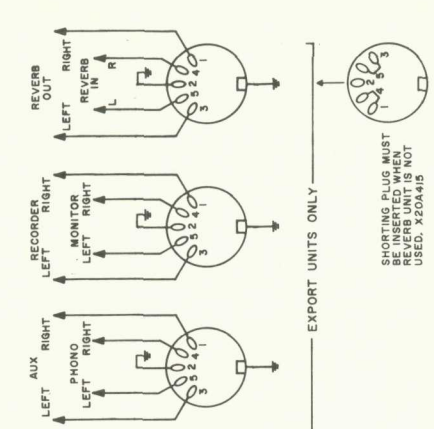

POWER CONSUMPTION
MIN 20 WATTS, 25VA
MAX 240 WATTS, 320VA
(WITH RATED LOAD 8 OHMS)

* MOUNTED ON POWER SUPPLY BOARD
† USED ONLY ON UNITS WIRED FOR EXPORT

Jerry - Very Important

OPERATION and CIRCUIT DESCRIPTION of the AUTO-SCAN CIRCUIT AS USED IN THE MODEL 500-TX

INTRODUCTION:

A first look at the AUTOSCAN circuit as used in the new 500-TX will leave the impression that we are dealing with a rather complex and complicated circuit.

The following step-by-step breakdown will, however, soon disclose the actual simplicity of the AUTOSCAN circuit. More than half the transistors used are operated as switches; they are either "ON" or "OFF" and this should make troubleshooting rather easy.

Full electronic automatic tuning has been made possible with the advent of variable capacitance diodes which we shall call shortly, "Tuning Diodes."

Tuning diodes if operated in the reverse bias mode, show a change of capacity as the reverse bias voltage changes (See Figure 1). We are now able to tune a FM front-end just as we did before with mechanical tuning capacitors, by means of a voltage variation.

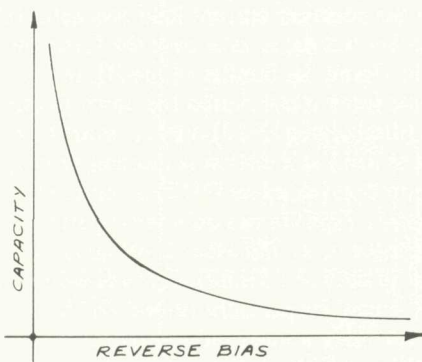

(FIGURE 1)

GENERATION OF TUNING VOLTAGE:

The generation and control of the tuning voltage is the function of the AUTOSCAN circuit. All that is needed is a tuning voltage ET, which may, at the flick

of a button be increased or decreased and maintain its value as soon as a station is locked in. A voltage increase and decrease may be achieved by slowly charging or discharging a capacitor through a resistor, as shown in Figure 2.

As can be observed, charge or discharge of C912 is achieved simply by opening or closing of switch 'S₁'. For approximately equal charge or discharge times, RL must be ½ R.

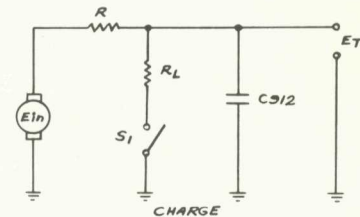

FIG. 2a

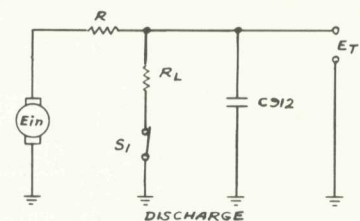

FIG. 2b

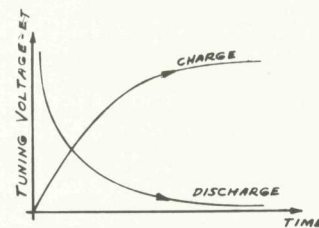

FIG. 2c

(FIGURE 2)

CONTROL OF TUNING VOLTAGE (AFC REGULATOR):

Observation of Figures 2a, 2b and 2c will give some indication as to how the tuning voltage ET can be kept constant, as soon as a station is reached. It appears that at the moment a station is tuned in, R_L should be disconnected and a device should be activated which shunts the exact current delivered by R and, therefore, prevents any further charge or discharge of C₉₁₂.

As Figure 3a shows, this is done with transistor Q905, which functions as a variable load resistor controlled by the ratio detector.

From Figure 3a it becomes clear that Q905 serves the most important control function in the AUTO-SCAN circuit. Since Q905 is controlled by the detector, it has the capability of providing whatever amount of charge or discharge from C₉₁₂ is required to tune the front end oscillator to the exact center of the station. Q905 provides, therefore, AFC action which, however, is by a factor of 1000 more efficient than what is presently used for AFC circuits. Therefore, we will find that the tuning accuracy of the

AUTOSCAN circuit can be matched only by manual tuners which have a very accurate center-of-channel meter. We also will find that annoying frequency drift of the front end and even the broadcast station itself will always be compensated for by the AUTOSCAN circuit.

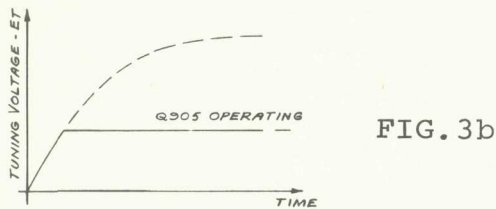
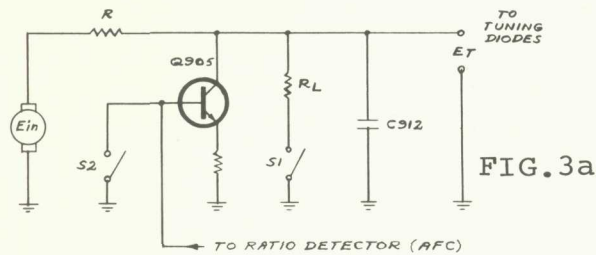

(FIGURE 3)

COMPLETE TUNING VOLTAGE REGULATION CIRCUIT (Q903-Q904-Q905):

The complete ET regulation circuit includes regulator transistor Q905, level shift transistor Q904, and separator transistor Q903.

The ratio detector in this circuit is designed to produce zero DC voltage output for optimum "On Station" operation. However, the optimum operation level for the regulator transistor Q905 is about 0.75V. Therefore, it is necessary to translate the zero detector level to the 0.75V level of the regulator. This is accomplished by the DC series-connection of transistors Q903, Q904, and Q905. Control R916 permits fine adjustment of the regulator's operating point and NTC resistor R915 compensates for the temperature coefficient of the regulator chain.

Q904 also provides the drive signal for the flip-flop reset stage, Q909, which will be discussed later.

CONSTANT CURRENT SOURCE AND CONSTANT CURRENT LOAD TRANSISTORS (Q906 & Q907)

Resistors R and RL in Figure 3 have been replaced with transistors which are providing a constant current source (Q906) and a constant current load (Q907) for the storage capacitor C912.

The reason for this modification is best explained with the aid of the time/tuning voltage graphs of Figure 4, where the letters 'A' and 'B' represent stations which require a certain tuning voltage level.

Figure 4a is a tuning time vs. tuning voltage graph for a capacitor (storage capacitor C912) charged or discharged through resistors. As can be seen, it takes

considerable more time for the AUTOSCAN to reach point 'B' with point 'A' as a starter, than point 'A' with point 'B' as the starting position. In short, there is a noticeable difference in tuning time required for up or down frequency operations.

Figure 4b represents tuning time vs. tuning voltage graphs for a storage capacitor (C912) charged with constant current and discharged through a load which draws constant current. It can be seen that now the tuning times from 'A' to 'B' and from 'B' to 'A' are equal.

In addition to providing equal up or down frequency tuning time, the current source transistor Q906 adjusts also the maximum level of the tuning voltage to about 27 volts and the current load transistor Q907 determines the lower limit of the tuning voltage, (about 5V).

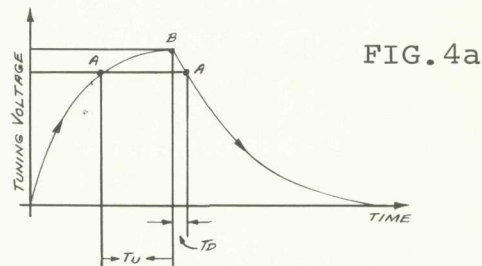

FIG. 4a

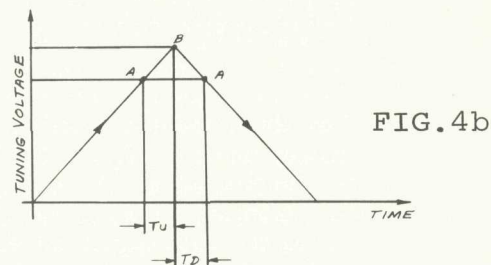

FIG. 4b

(FIGURE 4)

UP-DOWN FREQUENCY FLIP-FLOP TRANSISTORS (Q910-Q911) & FLIP-FLOP RESET TRANSISTOR Q909:

The function of the flip-flop circuit is to activate or deactivate the constant current load transistor (CCL) Q907; in other words, to take over the function of S1, as shown in Figure 3a. Similar to the RL in Figure 3, the CCL transistor is connected for down frequency operation (discharging C912) only. It must be disconnected as soon as a station is reached or if up frequency operation (charging C912) is required.

Generally, a flip-flop has only two operating modes. If one transistor is on, the other is off; and the reverse. There is no in between condition; for example, both transistors cannot be partially turned on. Another feature is that only a short pulse is required to change their operating state.

As the CCL transistor is operated from the collector of Q910, the "ON/OFF" state of this part of the circuit is of main interest.

As soon as the spring-loaded "Down Frequency" button is depressed, transistor Q910 will be turned "OFF". Its collector voltage will be raised sufficiently

to turn on, or activate, the CCL transistor Q907. If the "Down Frequency" pushbutton is released, Q910 will remain off or the CCL transistor remains activated until a station is tuned in. At this moment a short pulse is provided by the flip-flop reset transistor Q909, the flip-flop circuit changes its operating state and the CCL transistor is, as required, deactivated.

If we decide, before a station is reached, to reverse the direction of tuning, (Up Frequency) it is only necessary to depress the "Up Frequency" pushbutton. This will reset the flip-flop and deactivate the CCL transistor as required.

AFC REGULATOR DEFEAT CIRCUIT (Q912, Q913, Q914, Q915, Q917, Q918 & Q919)

The AFC regulator defeat circuit takes over the function of S2, shown in Figure 3a.

As Figure 5 shows, there exists a frequency region above and below the center frequency where the AFC regulator will always readjust the front-end to the center frequency. This region is called 'lock-in region.'

If tuning to another station is desired, it will be necessary to defeat the AFC regulator action for the time it takes the front end to be tuned to a frequency outside the lock-in region.

This is accomplished by the AFC regulator defeat circuit which, for better understanding, will be divided into three sections.

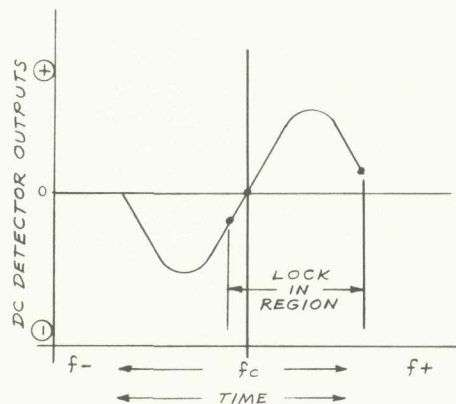

(FIGURE 5)

FIRST SECTION (Q914, Q915, Q917):

The first section is activated by depressing the Up-or-Down Frequency pushbuttons.

With either button depressed, the bias of Q915 is shorted to ground Q915 will, consequently, be turned off which brings Q917 into saturation ("ON"). With Q917 in saturation, the base of Q904 is effectively shorted to ground and both Q904 and the AFC regulator transistor are deactivated.

If the pushbuttons are released, the first section is deactivated as soon as Capacitor C258 is charged sufficiently to bias Q915 to "ON".

The charging time for capacitor C258 is longer at higher (108 MHz) than at lower frequencies (88 MHz). The reason for this will be explained later, together with the function of the variable timer.

The time constant, after the buttons are released, is of considerable importance for tuning to the next station. The user has to depress the Up or Down buttons for only a fraction of a second. The timer circuit will then ensure that the AFC regulator will remain defeated for the time required to tune the front end to the region where Section 2 will take over the AFC regulator defeat action.

SECOND SECTION (Q918, Q919)

The second section is operated from the DC voltage originating from the narrow-band indicator and muting circuit ZZ50C210-152.

Its function is to narrow the very wide lock-in region of the ratio detector so that closely spaced stations may be separated. Figure 6a and 6b.

Figure 6b indicates an overlap of variable timer and indicator operated defeat action. This overlap is very important to ensure safe operation with worst-case component tolerances.

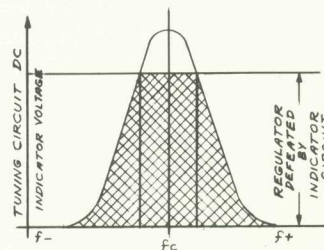

FIG. 6a

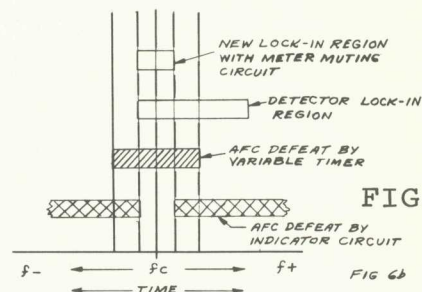

FIG. 6b

(FIGURE 6)

Section two operates as follows: After the indicator voltage drops below a predetermined value, Q919 is biased to "OFF"; then, Q918 will saturate and short the base of Q904 to ground. This deactivates Q904 as well as the AFC regulator. At the moment a station is tuned in, Q919 will be biased "ON". This will turn transistor Q918 "OFF" and AFC regulator path is open again.

In short, the AFC regulator defeat action has been started by the flick of the buttons, then taken over by the variable tuner and completed by the indicator circuit.

THIRD SECTION (Q913, Q912)

The function of the third section is to defeat the AFC regulator until the tuning voltage raises from zero to its minimum specified value.

Circuit Operations: After a predetermined tuning voltage level (4V) has been reached, this level will be reflected on the emitter of frequency indicator transistor Q908 and the base of Q912. The resulting voltage drop at the collector of Q912 turns Q913 off, and the regulator path is open.

VARIABLE TIMER CIRCUIT (Q914)

Based on the diode characteristics, the time required for tuning out of the lock-in region at 108 MHz is about three times longer compared to that at 88 MHz. See Figure 7a.

For proper AFC regulator defeat action it is, however, necessary to assure sufficient overlap of the timer and indicator circuit operation at all frequencies.

This is accomplished by variation of the turn on time of Q915 in the following manner: After the UP OR DOWN pushbuttons are depressed, capacitor C258 is charged from a variable voltage which changes inversely with the tuning voltage level. (Figure 7b).

The variable charge voltage for C258 is taken of the collector of transistor Q914 which functions as a DC phase inverter operated over the frequency indicator Q912 directly from the tuning voltage.

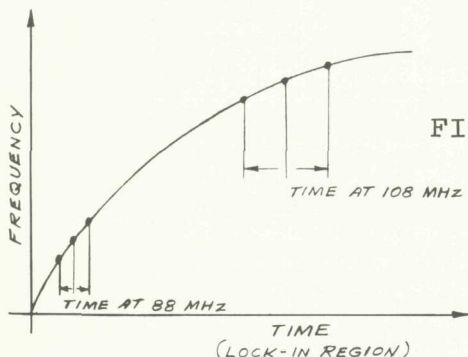

FIG. 7a

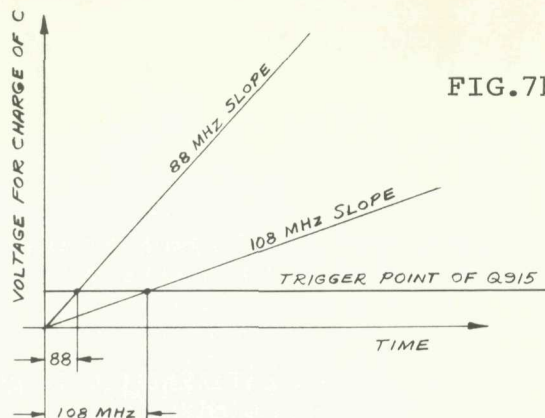

FIG. 7b

(FIGURE 7)

AUDIO MUTING CIRCUIT (Q916, 915)

The muting operation is very similar to the AFC regulator defeat operation. It is initiated by the UP OR DOWN frequency pushbuttons, taken over by the variable timer and completed by the narrow-band indicator and muting circuit. Since the receiver has already an audio muting circuit operated from the narrow-band circuit, only the addition of one transistor (Q916) will accomplish the variable-timer-muting. Transistor Q916 is connected to the input of the main-muting circuit at the base of the meter transistor Q701.

FREQUENCY INDICATOR CIRCUIT (Q908)

The tuning voltage is used for frequency indication together with an instrument calibrated in MHz.

The circuit uses an emitter follower to isolate the meter circuit from the tuning voltage. The meter itself is connected in a bridge configuration. Control R937 permits meter adjustment at 108 MHz and control R939 at 88 MHz.

