32" HD Digital LED TV



Instruction Manual

Read all of the instructions before using this TV and keep the manual in a safe place for future reference.

1	IMPORTANT INFORMATION		2
2	PREFACE		4
3	SAFETY PRECAUTIONS		4
4	IN THE CARTON		6
5	FRONT/BACK CONNECTIONS OF TV		7
6	TV INSTALLATION DRAWINGS	Power Cord Connection	8
		Antenna Connection	8
		AV Connection	9
		YPbPr(component) Connection	9
		VGA(PC) Connection	10
		COAXIAL Connection	10
		HDMI Connection	11
		USB Function	11
7	REMOTE CONTROL	Remote control instructions	12
		Remote control setup	14
8	MENU OPERATION	Basic Operations	15
		Picture Menu Options	17
		Audio Menu Options	17
		Time Menu Options	18
		Setup Menu Options	18
		Lock Menu Options	19
		Channel Menu Options	21
9	MEDIA MENU	Photo Menu	23
10	TROUBLESHOOTING		24
11	MAINTAINING		24
12	SPECIFICATIONS		25



The lightning flash with arrowhead symbol, within an equilateral triangle, is intended to alert the user to the presence of un-insulated dangerous voltage within the products enclosure that may be of sufficient magnitude to constitute a risk of electric to persons.



The exclamation point within an equilateral triangle is intended to alert the user to the presence of important operating and maintenance (servicing) instructions in the literature accompanying the appliance.

CAUTION: USE OF ANY CONTROLS, ADJUSTMENTS, OR PROCEDURES OTHER THAN THOSE SPECIFIED HEREIN MAY RESULT IN HAZARDOUS RADIATION EXPOSURE.

CAUTION: These servicing instructions are for use by qualified service personnel only. To reduce the risk of electric shock, do not perform any servicing other than that contained in the operating instructions unless you are qualified to do so.

Refer to service manual for servicing instructions.



Please note that changes or modifications not expressly approved by the party responsible for compliance could void the user's authority to operate the equipment.

This device complies with Part 15 of the FCC Rules. Operation is subject to the following two conditions: (1) this device may not cause harmful interference, and (2) this device must accept any interference received, including interference that may cause undesired operation.

“Warning: Changes or modifications to this unit not expressly approved by the party responsible for compliance could void the user's authority to operate the equipment.”

“NOTE: This equipment has been tested and found to comply with the limits for a Class B digital device, pursuant to Part 15 of the FCC Rules. These limits are designed to provide reasonable protection against harmful interference in a residential installation. This equipment generates, uses and can radiate radio frequency energy and, if not installed and used in accordance with the instructions, may cause harmful interference to radio communications.

However, there is no guarantee that interference will not occur in a particular installation. If this equipment does cause harmful interference to radio or television reception, which can be determined by turning the equipment off and on, the user is encouraged to try to correct the interference by one or more of the following measures:

- Reorient or relocate the receiving antenna.
- Increase the separation between the equipment and receiver.
- Connect the equipment into an outlet on a circuit different from that to which the receiver is connected.
- Consult the dealer or an experienced radio/TV technician for help.

Important Safety Instructions

Note:

1. Read these instructions.
2. Keep these instructions.
3. Heed all warnings.
4. Follow all instructions.
5. Do not use near water.
6. Clean only with dry cloth.
7. Do not block any ventilation openings. Install in accordance with the manufacturer's instructions.
8. Do not install near any heat sources such as radiators, heat registers, stoves, or other apparatus (including amplifiers) that produce heat.
9. Do not defeat the safety purpose of the polarized or grounding-type plug. A polarized plug has two blades with one wider than the other. A grounding type plug has two blades and a third grounding prong. The wide blade or the third prong are provided for your safety. If the provided plug does not fit into your outlet, consult an electrician for replacement of the obsolete outlet.
10. Protect the power cord from being walked on or pinched particularly at plugs, convenience receptacles, and the point where they exit from the apparatus.
11. Only use attachments / accessories specified by the manufacturer.
12. Use only with the cart, stand, tripod, bracket, or table specified by the manufacturer, or sold with the apparatus. When a cart is used, use caution when moving the cart / apparatus combination to avoid injury from tip-over.



13. Unplug this apparatus during lightning storms or when unused for long periods of time.
14. Refer all servicing to qualified service personnel. Servicing is required when the apparatus has been damaged in any way, such as power-supply cord or plug is damaged, liquid has been spilled or objects have fallen into the apparatus, the apparatus has been exposed to rain or moisture, does not operate normally, or has been dropped.
15. Apparatus shall not be exposed to dripping or splashing and that no objects filled with liquids, such as vases, shall be placed on the apparatus.
16. WARNING: To reduce the risk of fire or electric shock, do not expose this apparatus to rain or moisture.
17. Mains plug or appliance coupler is used as the disconnect device, shall be readily operable.

WARNING: The battery (battery or batteries or battery pack) shall not be exposed to excessive heat such as sunshine, fire or the like.



This equipment is a Class II or double insulated electrical appliance. It has been designed in such a way that it does not require a safety connection to electrical earth.



ENERGY STAR® Qualification.

This ELEMENT product has earned the ENERGY STAR® for meeting U.S. Federal energy efficiency guidelines as set by the Department of Energy and Environmental protection agency.

The ENERGY STAR® program exists to provide energy saving guidelines and help promote energy efficient products and practices. Changes to certain features, settings and functions of this TV can change and/or increase its power consumption.

Home Mode is the mode in which the product qualifies for ENERGY STAR® .

Standard Mode optimizes the video effects when use at a retail showroom or demo environment. This mode the video setting may increase energy consumption beyond the limits required for ENERGY STAR® qualification.

2. PREFACE

Thank you for buying this TV! Please read this manual thoroughly before operating the TV.

Make sure the TV was not damaged in transit. Should the TV be damaged, do not install it and contact your dealer. Check that you have all the accessories according to the model.

3. SAFETY PRECAUTIONS



Put the TV on a stable surface.

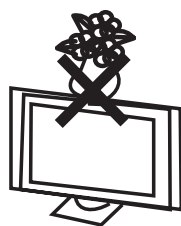

Do not place any material on the TV.

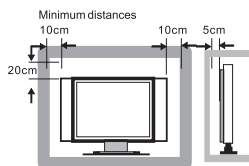

Do not use the TV with fixtures other than those provided or suggested by the manufacturer.



Do not block or cover the ventilation openings on the TV.
If you have a wall mount, check that it is steady.



Power cord and cables must be properly placed and protected to prevent people from stepping on them and causing the TV to fall.

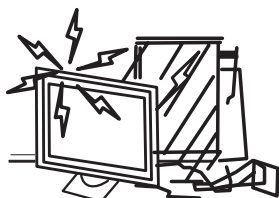

Keep the TV dry and away from humidity.

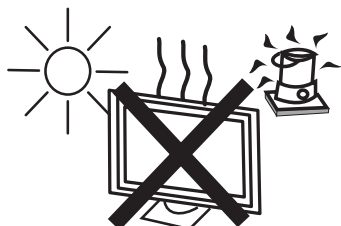

Keep the TV away from heat sources.



Unplug the TV before cleaning it. Do not use solvent or liquid to clean the TV.

Only clean the TV with a soft and dry cloth.

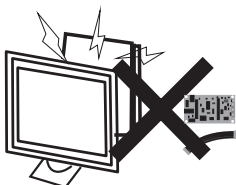

In case of troubleshooting, do not use spare parts other than those suggested by the manufacturer. Using inadequate spare parts can lead to electric shocks, short-circuits, fire, or other incidents.



Unplug the TV during lightning storms or when unused for long periods of time.

4. IN THE CARTON



LED TV SET



Remote Control

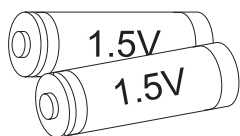

AAA Batteries

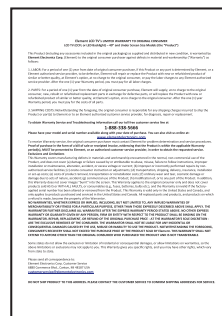

Warranty Card

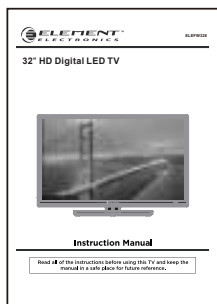

USER'S MANUAL



Quick Start Guide



Remote Control Guide



Attaching Table-Top Stand

5. FRONT/BACK CONNECTIONS OF TV

Front View

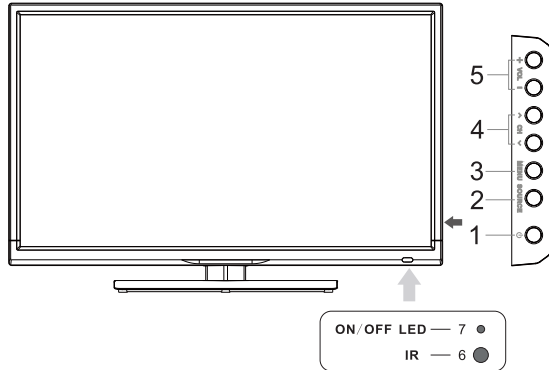

1. Press ⏻ button to turn the TV on or off.
2. Press SOURCE to select the input source.
3. Press MENU to bring up the main menu on the screen.
4. Press CH Δ or CH ∇ to scan through channels.
5. Press VOL+ or VOL- to increase or decrease the volume.
6. REMOTE SENSOR: Infrared sensor for the remote control.
7. POWER INDICATOR: Shows red in standby mode. Shows blue when your TV is turned on.

Back View and Control Connections

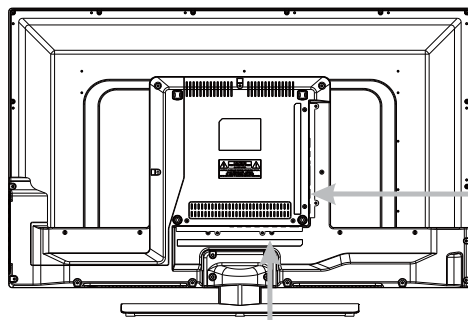

1. EARPHONE Connect a stereo headphone for private listening.
2. COAXIAL out: Connect the COAXIAL receiver.
3. AV: Connect the Video and Audio output.
4. Component IN: Connect the YPbPr output.
5. HDMI 1/ HDMI 2/ HDMI 3: Connect the HDMI output jack of DVD.
6. PC AUDIO: Connect the Audio output jack of PC.
VGA(PC): Connect the PC-RGB output jack of PC.
7. RF IN: Connect the antenna.
8. USB: Connect to the external drive.
Output power 5V --- 0.5A.

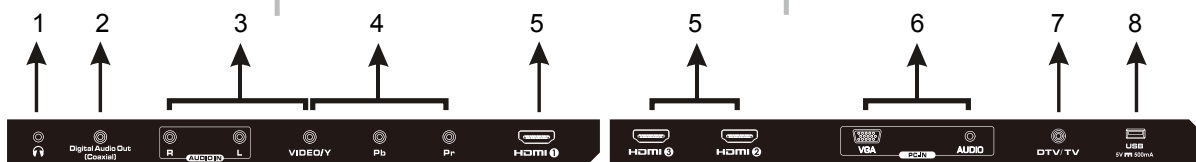

6. TV INSTALLATION DRAWINGS

Power Cord Connection

- Connect the power cord correctly as shown.
- Press the Power button of your LED TV to turn on the LED TV. The power indicator on the front panel lights up in blue.

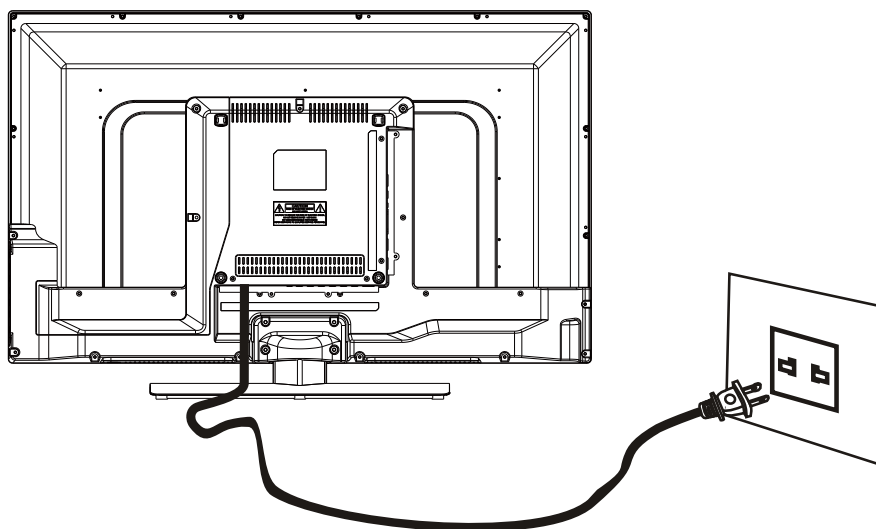

Antenna Connection

To ensure good picture and sound, TV antenna system needs to be installed. The antenna system as shown can be sourced from TV equipment shops, which will provide service for correct installation and connection. After installation, insert the 75-ohm antenna plug into the antenna jack as shown.

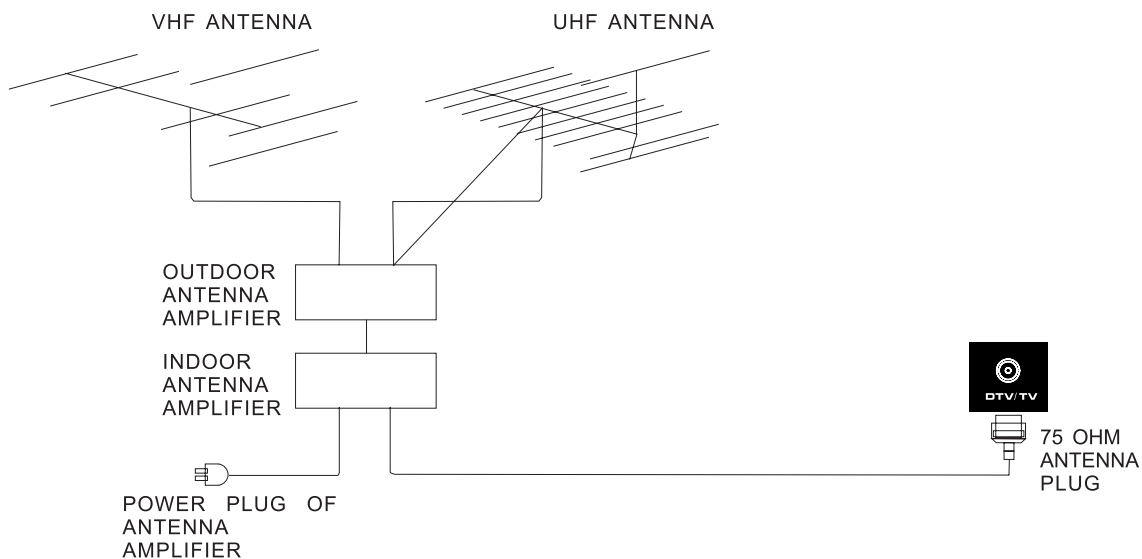

AV Connection

Connect the VIDEO and AUDIO output jack of the DVD or VCR to the VIDEO and AUDIO jacks on the set using the RCA cable. Match the jack colors: Video is green, Audio left is white, and Audio right is red. Select the AV input source using the SOURCE button on the remote control.

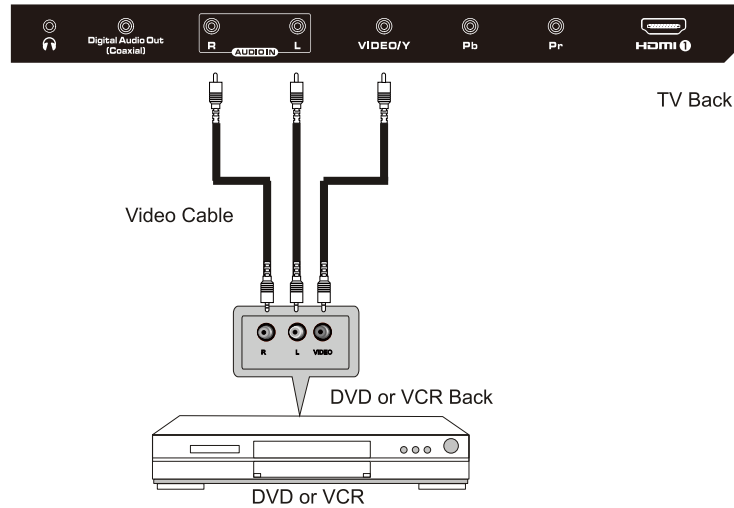

YPbPr(Component) Connection

Connect the YPbPr output of the DVD or VCR to the YPbPr input on the set. The picture quality is improved; compared to connecting a regular VCR to the video input. Connect the Audio output of the DVD or VCR to the Audio input jacks on the set using the RCA cable.

Match the jacks colors :Y is green, Pb is blue, Pr is red, Audio left is white and Audio right is red. Select component input source using the SOURCE button on the remote control.

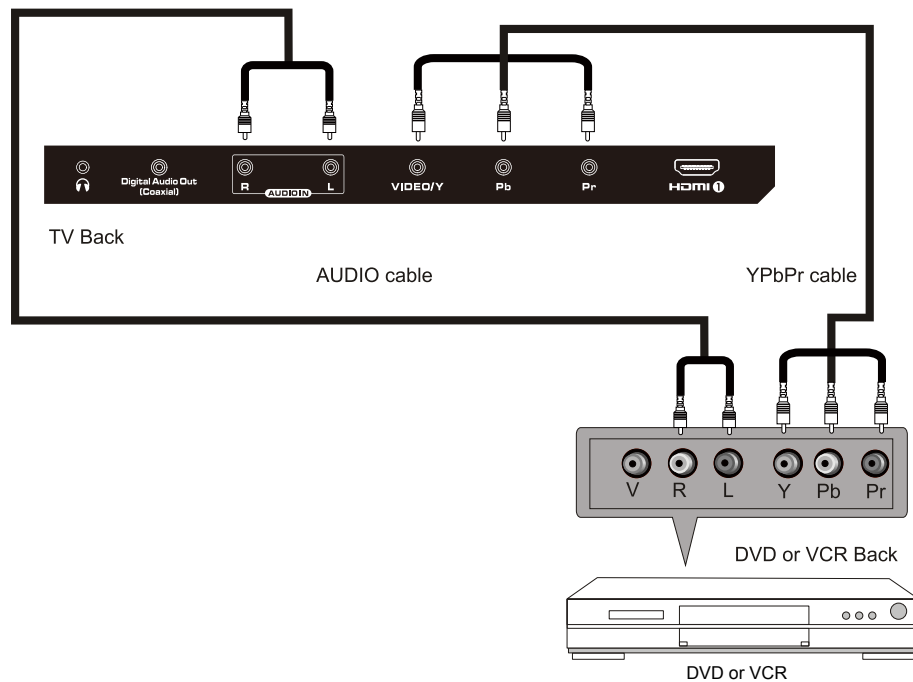

VGA(PC) Connection

Connect the RGB output of the PC to the VGA(PC) jack on the set. Connect the AUDIO output of the PC to the PC AUDIO jack on the set. Select the VGA input source using the SOURCE button on the remote control

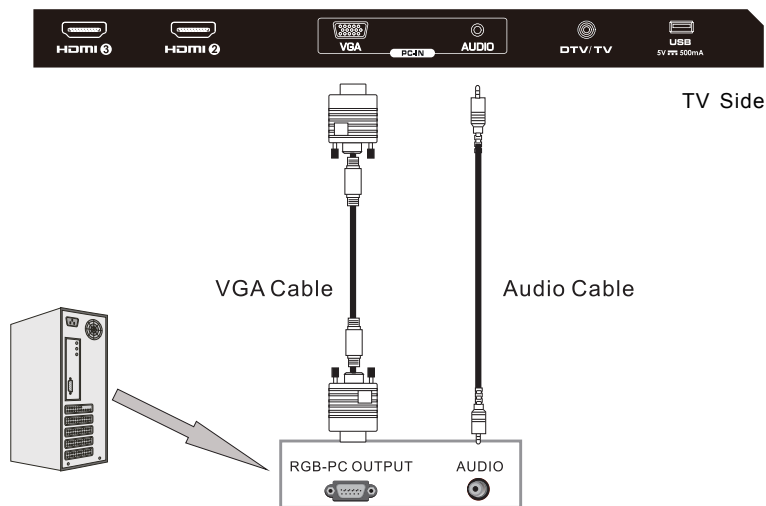

COAXIAL Connection

Connect to Audio Amplifier device to the Coaxial output jack on the TV.

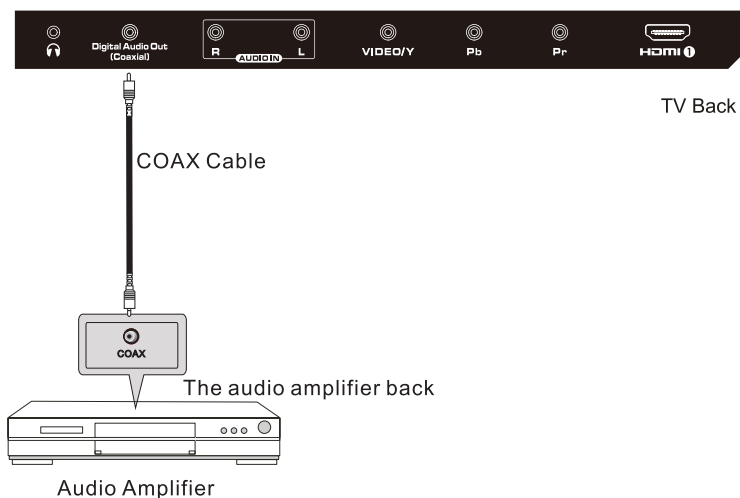

HDMI Connection

HDMI plug which replaces the HDMI connection allows transfer of all audio/video/control signals through one cable only. These signals are transferred in digital.

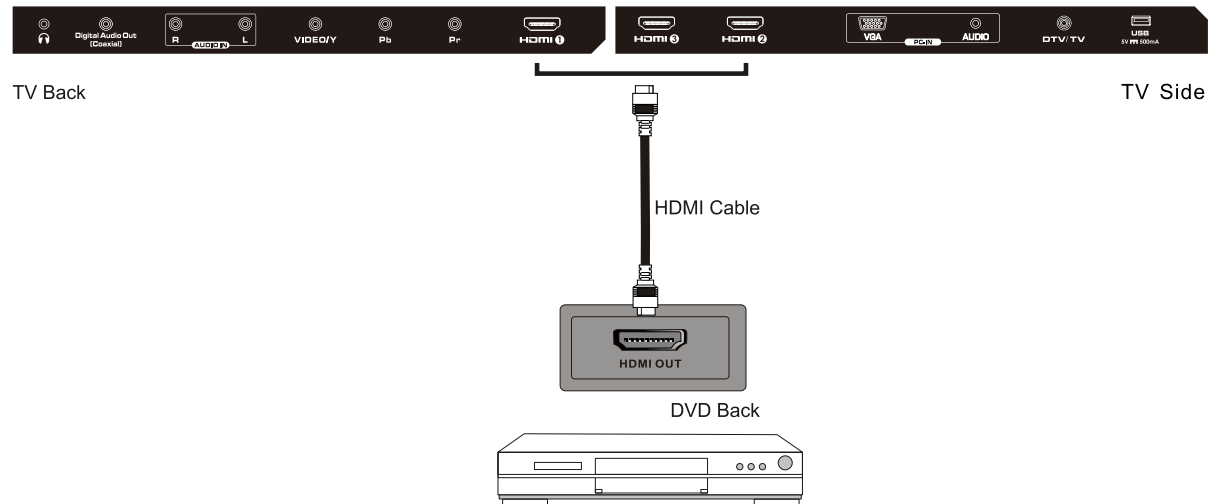

USB Function

Insert the USB flash, drive to the USB port, select USB input source via the SOURCE button on the remote control.



Wall Mounting

The TV is provided with mounting holes for a VESA approved wall mounting bracket (NOT SUPPLIED). Remove the screws holding the base to the base bracket and lift the base away (do not remove the base mounting brackets). Mount the VESA bracket using 4 x M5 x 8 isometric threaded screws (not supplied). Do not use screws longer than 12mm; damage will occur to the internal parts.







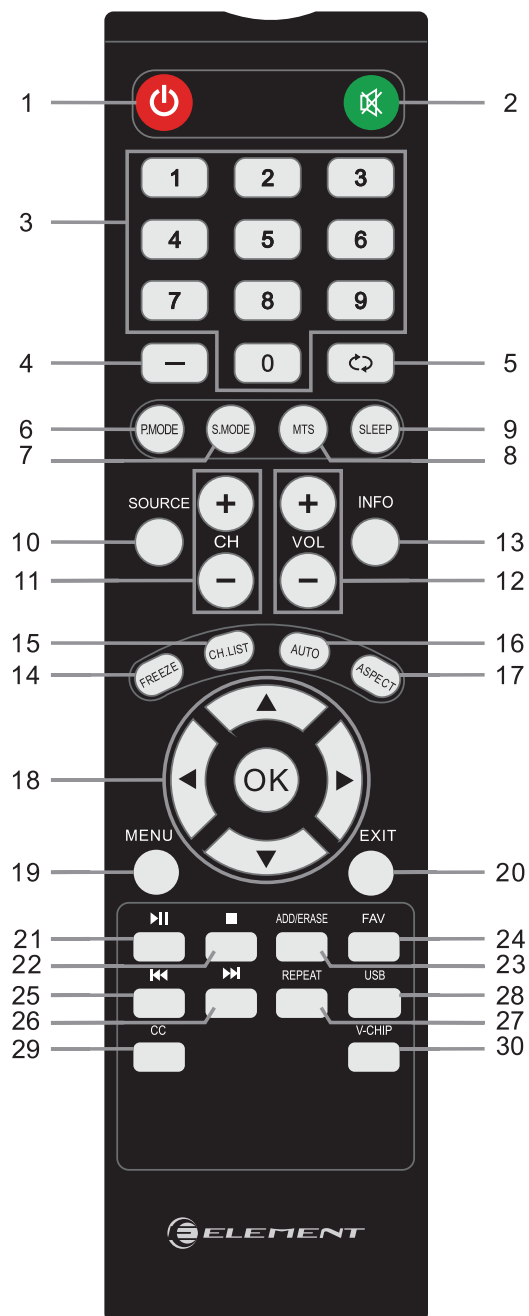





Caution: Your new TV is heavy; please consult with a professional wallmount installer to perform this installation.

7. REMOTE CONTROL

Remote Control Instructions



Note: The picture of remote controller is only for reference and is subject to the real one.

- 1  : Turn the LED TV ON or OFF.
- 2  : Press to mute the sound. Press again or press Vol+ to un-mute the TV.
- 3 **NUMBER BUTTONS**: Press 0-9 to directly change the TV channel.
- 4 **-**: Press this button to enter a program number for multiple program channel such as 2-1, etc.
- 5  : Return to the previous channel viewed.
- 6 **P.MODE**: Press repeatedly to cycle through the available video picture modes.
- 7 **S.MODE**: Press to cycle through the different sound settings.
- 8 **MTS**: Choose Mono, stereo or sap for analog TV input. Choose English, French or Spanish for DTV input.
- 9 **SLEEP**: Sleep button, setting TV power off time.
- 10 **SOURCE**: Press SOURCE to display the OSD input source, press   to select an input source, and then press OK to confirm.
- 11 **CH+/CH-**: Press to scan through channels.
- 12 **VOL+/VOL-**: Press to increase / decrease the sound level.
- 13 **INFO**: Press to display the source and channel's information.
- 14 **FREEZE**: Freeze picture for TV.
- 15 **CH.LIST**: Press to display the TV program list.
- 16 **AUTO**: Automatically adjust the Horizontal/Vertical position in PC(VGA) mode.
- 17 **ASPECT**: Press to select Aspect Ratio. (As follow Wide, Cinema, Zoom, Normal, Point to Point, etc)
(Note: This function when play DTV HD signal is not available)
- 18 **THUMBSTICK**( /  /  /  / **OK**): Allows you to navigate the on-screen menus and adjust the system settings to your preference.
- 19 **MENU**: Display the main TV menu.
- 20 **EXIT**: Press the Exit to exit operation.
- 21  : Press to playback or pause the program.
- 22  : Press to stop media play.
- 23 **ADD/ERASE**: Add or Erase favorite channels.
- 24 **FAV**: Press to display the favorite list in TV mode.
- 25  : Press to return to previous chapter or track.
- 26  : Press to skip to next chapter or track.
- 27 **REPEAT**: In USB source, press to repeat All or None.
- 28 **USB**: Press to enter the USB source.
- 29 **CC**: Press to display the closed caption.
- 30 **V-CHIP**: Press to enter the V-CHIP menu.

Remote Control Setup

1. Open the cover.
2. Use two AAA size batteries. When inserting the batteries, make sure correct polarities “+” and “-” marks on the batteries line up correctly with compartment markings.
3. Replace the battery cover.

To prevent battery leakage which may result in bodily injury or damage to the remote:

1. Install all batteries correctly, and as marked on the remote control.
2. Do not mix old and new batteries, and do not mix alkaline, standard (carbon-zinc) or rechargeable (ni-cad, ni-mh, etc.) Batteries.
3. Remove batteries when the remote is not used for a long period of time.

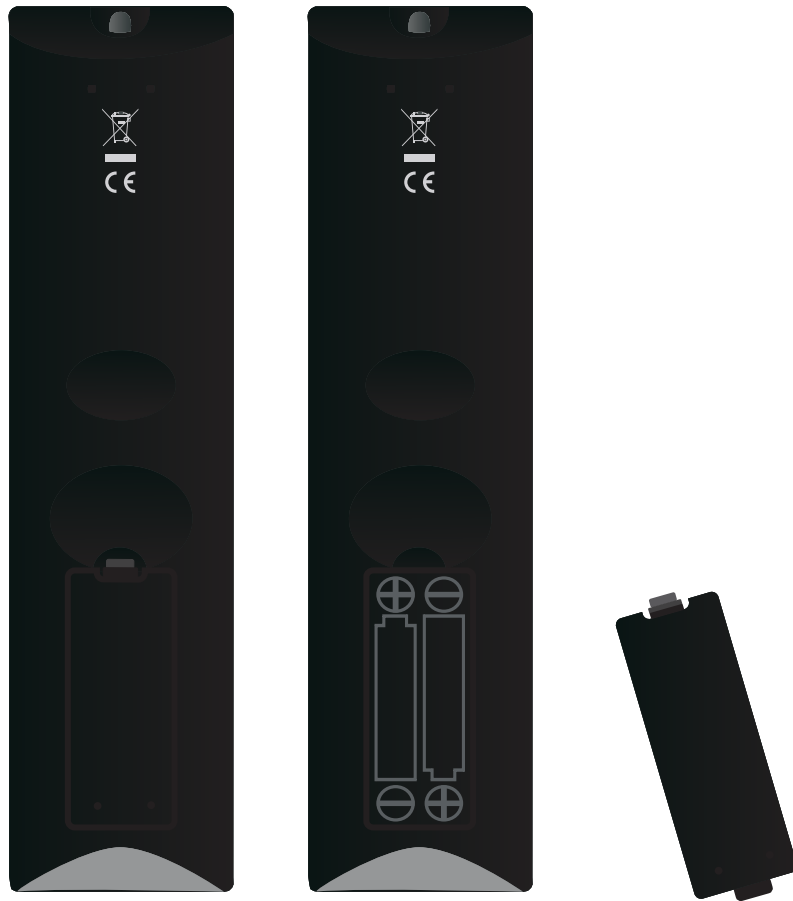

8. MENU OPERATION

Basic Operations

Press ▲/▼ button to select your desired mode, then press **OK** to enter.

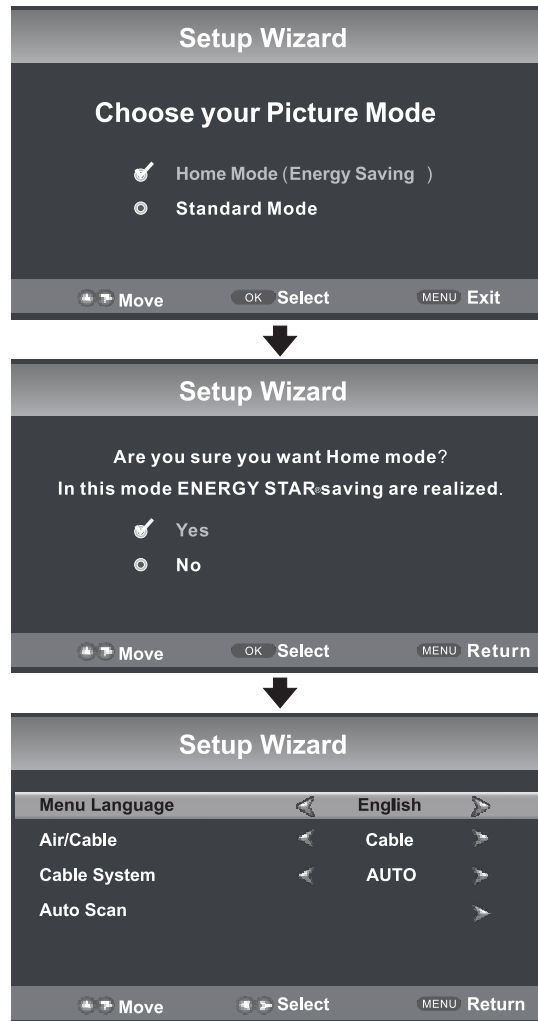

Select Your Onscreen Language Preference

Note: If using your LED TV for the first time, you should select the language which will be used for displaying menus and information boxes.

- Press ▲/▼ button to select Menu Language.
- Press ◀/▶ button to select your desired language.
- When you are satisfied with your choice, press ▲/▼ button to select the Auto Scan, press ▶ button to search channel.

Volume Adjustment

1. Press VOL +/- to adjust the volume.
2. If you want to switch the sound off, press the MUTE , press again to resume.

Navigating the Onscreen Display

- Press the MENU button to display the main menu.
- Use ▲/▼ buttons to navigate and select the available menus.



Choosing a TV Channel

1. Press the CH▲/CH▼ at the bottom of the panel or CH+/CH- on the remote control to scan through channels.
2. Enter the channel number with the 0-9 remote keys, then press 'OK' to confirm.

Selecting Input Source

You can display the input screen menu by pressing SOURCE on the remote control or SOURCE at the bottom of the panel, press ▲/▼ button to select, press "OK" to confirm.

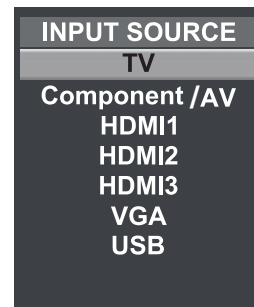

Picture Menu Options

Press the MENU at the bottom of the panel or on the remote control and then use ▲/▼ to move the PICTURE menu, press ► or OK to enter (see picture below).

NOTE: Adjust the parameters of the picture, the Picture Mode is automatically converted to User Mode.

Picture Mode

Select the type of picture which best corresponds to your viewing preferences by selecting Picture Mode in the PICTURE menu. You may select the picture mode directly by pressing the P.MODE button on the remote control.

Contrast

Press ▲/▼ and then use ◀/▶ to adjust the contrast of the picture.

Brightness

Press ▲/▼ and then use ◀/▶ to adjust the brightness of the picture.

Color

Press ▲/▼ and then use ◀/▶ to adjust the color of the picture.

Tint

Press ▲/▼ and then use ◀/▶ to adjust the tint of the picture.

Sharpness

Press ▲/▼ and then use ◀/▶ to adjust the sharpness of the picture.

Color Temp.

Press ▲/▼ and then use ◀/▶ to select Normal, Warm, Cool.

Blue Screen

Press ▲/▼ and then use ◀/▶ to select On or Off.

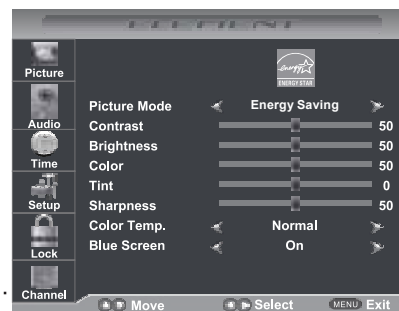

Audio Menu Options

Press the MENU at the bottom of the panel or on the remote control and then use ▲/▼ to move the AUDIO menu, press ► or OK to enter (see picture below).

NOTE: Adjust the parameters of the sound, the Sound Mode is automatically converted to User Mode.

Sound Mode

Press ▲/▼ and then use ◀/▶ to select Standard, Music, Movie or User.

Bass

Press ▲/▼ and then use ◀/▶ increase or decrease the level of the lower-pitched sounds.

Treble

Press ▲/▼ and then use ◀/▶ to increase or decrease the level of higher-pitched sounds.

Balance

Press ▲/▼ and then use ◀/▶ to adjust the audio output between left and right speakers.

Surround Sound

Press ◀/▶ to switch surround sound On or Off.

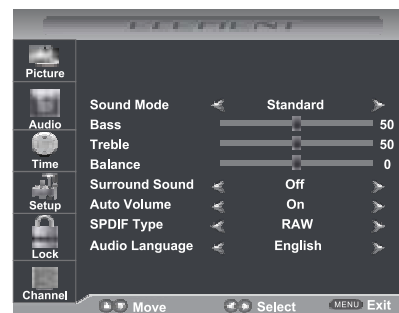

Auto Volume

Press ◀/▶ to switch auto volume control On or Off. This function allows volume to be controlled automatically.

SPDIF Type

Press ◀/▶ to select between PCM or RAW.

Audio Language

Press ◀/▶ to select audio languages among: English, French, Spanish.

Time Menu Options

Press the MENU at the bottom of the panel or on the remote control and then use ▲/▼ to move the TIME menu, press ▶ or OK to enter (see picture below).

Sleep Timer

Press ▲/▼ and then use ◀/▶ to set up the sleep timer among: Off, 5min, 10min, 15min, 30min, 45min, 60min, 90min, 120min, 180min or 240min.

Time Zone

Press ▲/▼ and then use ◀/▶ to set up the time zone among: Pacific, Alaska, Hawaii, Eastern, Central or Mountain.

Daylight Saving Time

Press ▲/▼ and then use ◀/▶ to set up the daylight saving time On or Off.

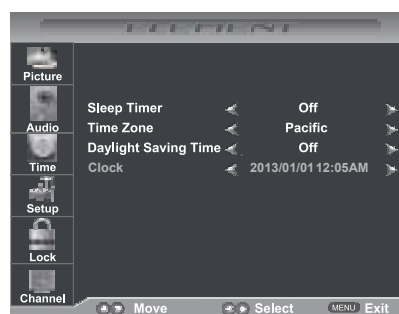

Setup Menu Options

Press the MENU at the bottom of the panel or on the remote control and then use ▲/▼ to move the SETUP menu, press ▶ or OK to enter (see picture below).

Menu Language

Press ▲/▼ and then use ◀/▶ to select menu language among: English, Français or Español.

Transparency

Press ▲/▼ and then use ◀/▶ to turn on or off the transparency function.

Zoom Mode

Press ▲/▼ and then use ◀/▶ to select the zoom mode among: Wide, Zoom, Cinema, Normal or Just Scan.

Noise Reduction

Press ▲/▼ and then use ◀/▶ to select the noise reduction mode among: Weak, Middle, Strong, Off.

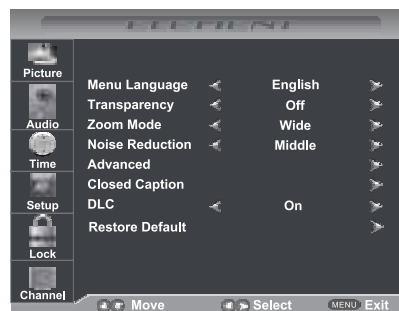

Advanced

Press ▲/▼ and then use ▶ to select the advanced options between H-POS, V-POS, Clock, Phase, Auto (only used in VGA source mode.)

H-POS

Press ▲/▼ and then use ◀/▶ to adjust the H-POS of the picture.

V-POS

Press ▲/▼ and then use ◀/▶ to adjust the V-POS of the picture.

Clock

Press ▲/▼ and then use ◀/▶ to adjust the Clock of the picture.

Phase

Press ▲/▼ and then use ◀/▶ to adjust the Phase of the picture.

Auto

Press ▲/▼ and then use ▶ to adjust the picture.

Closed Caption

Press ▲/▼ and then use ▶ button to enter into the following menu.

CC Mode

Allows you to select the CC Mode among: Off, On or CC on Mute.

Basic Selection

Allows you to select the basic selection among: CC1, CC2, CC3, CC4, Text1, Text2, Text3 and Text4.

Advanced Selection

Press ▲/▼ and then use ◀/▶ to select the advanced selection among: Service1, Service2, Service3, Service4, Service5 or Service6.

OPTION

Press ▲/▼ and then use ▶ to enter into the following menu.

Press ▲/▼ and then use ◀/▶ to select.

DLC

Press ▲/▼ and then use ◀/▶ to dynamic luminance control On or Off.

Restore Default

Select "Restore Default", press ▶ or OK, and it will display "Are you sure?", Select "Yes" to select the factory default settings.

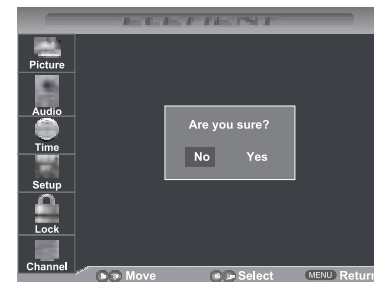
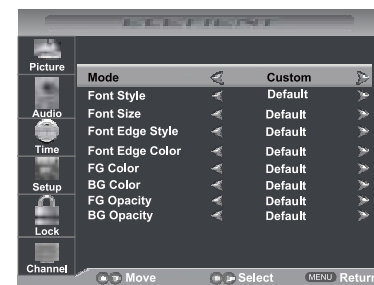

Lock Menu Options

Press the MENU at the bottom of the panel or on the remote control and then use ▲/▼ to move the LOCK menu, press ▶ or OK to enter (see picture below).

Use the numeric keys to input 4-digital password, then the screen will display the junior menu. After settings, press MENU button to exit.

NOTE:The factory password is 0000.

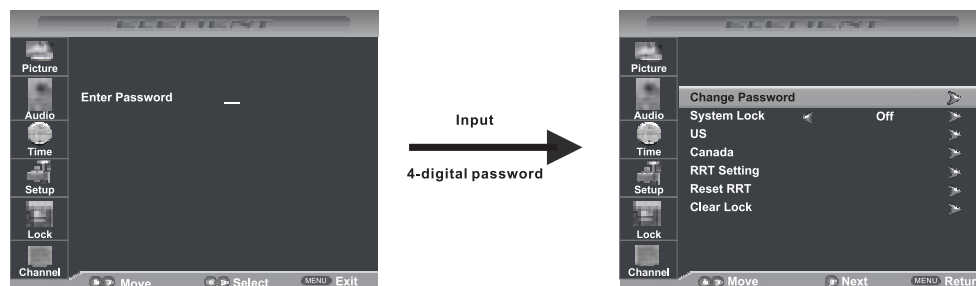

Change Password

Use ▼ button to select the “Change Password” item, then press ► button to enter into the following menu. Input the new 4-digital password and input it again to confirm.



System Lock

Allows you to turn on or off the system lock. If you turn off the system lock, then the following items(US, Canada, RRT Setting and Reset RRT) will unable to use.

US

Use ▼ button to highlight the “US” item, then press ► button to enter into the following menu.



TV(Rating)

Press ▼/▲ button to select TV Rating, then press OK button to adjust. A sub-menu will appear as below.

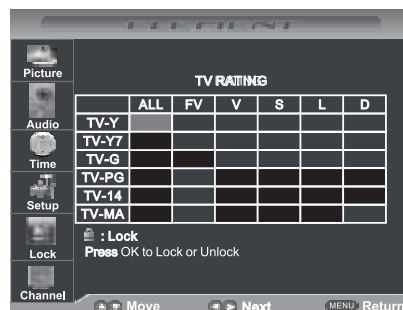

MPAA(Rating)

Press ◀/▶ button to select Rating among: N/A,G,PG,PG-13, R,NC-17 and X.

Canada

Use ▼ button to highlight the “Canada” item, then press ► button to enter into the following menu.

Canada English

Use ◀/▶ buttons to select among: E, C, C8+, G, PG, 14+ and 18+.

Canada French

Use ◀/▶ buttons to select among: E, G, 8ans+, 13ans+, 16ans+ and 18ans+



RRT Setting

Rating Region Table setting.

Reset RRT

Allows you to reset the RRT setting.

Clear Lock

Clear the system lock settings.

Information

Motion Picture Association of America (MPAA) Rating System

Grade		Meaning
G	General Audiences	Content not offensive to most viewers
PG	Parental Guidance Suggested	Content is such that parents may not want their children to view the program
PG-13	Parental Guidance Strongly Cautioned	Program is inappropriate for preteens, with a greater degree of offensive material suggested than a PG rated program
R	Restricted viewing	Not for children under 17, Strong element of sex and/or violence
NC-17	No Children Under age 17	Not for children under 17 under any circumstances. Strong sexual content
X	Hard Core Films	Same as NC-17 rating
N/A	No Rating	MPAA Not Rated

TV Parental Guideline Rating System

Grade		Meaning
TV-Y	Young Children	Content not offensive to most viewers
TV-Y7	Children 7 and over	Considered suitable for children over 7, may contain Fantasy Violence Scenes
TV-G	Parental Audience	Considered suitable for all audiences; children may watch unattended
TV-PG	Parental Guidance	Suggested Unsuitable for younger children, may contain; Suggestive Dialogue, Bad Language, Sex, and Violence Scenes
TV-14	Parents Strongly Cautioned	Unsuitable for children under 14, may contain: Strong Dialogue, Bad Language, Sex, and Violence Scenes
TV-MA	Mature Audience Only	Adults only, may contain Strong Dialogue, Bad Language, Sex, and Violent Scenes

Canadian Rating:

Canadian English is used throughout all English-speaking Canada (C, C8+, G, PG, 14+, 18+). Canadian French is used in Quebec (G, 8 ans+, 13 ans+, 16 ans+, 18 ans+)

Note: The V-Chip will automatically block certain categories that are “more restrictive”. If you block TV-Y category, then TV-Y7 will be automatically blocked. Similarly, if you block TV-G category, then all the categories in the “young adult” will be blocked (TV-G, TV-PG, TV-14, and TV-MA).

Channel Menu Options

Press the MENU at the bottom of the panel or on the remote control and then use ▲/▼ to move the CHANNEL menu. Press ► or OK to enter (see picture below).

Air/Cable

Allows you to select antenna between Air and Cable.



Auto Scan

Use ▼ button to highlight “Auto Scan”, then press ► button to enter into the following menu.

If you select “Air” as input signal in Antenna item, you can press ► button to search the channels automatically.

The receivable channels will be stored automatically. When searching channels, press MENU to stop.

If you select “Cable” as input signal in Antenna item, allows you to select Cable System among: AUTO, STD, IRC and HRC. Use ▼ button to highlight the “Start to Scan”, then press ► button to search the channels automatically. The receivable channels will be stored automatically. When searching channels, press MENU to stop.

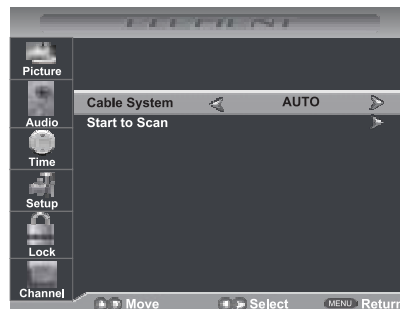

Favorite

Allows you to add these channels which you desired as the favorite channels.

Use ▲/▼ button to highlight the “Favorite” item, then press ► button to enter into the following menu.

Use ▲/▼ button to highlight the desired item, then press OK button to add or remove the highlighted channel as favorite.

Show / Hide

Allows you to show or hide the channels.

Use ▲/▼ button to highlight the “Show / Hide” item, then press ► button to enter into the following menu.

Use ▲/▼ button to highlight the desired item, then press OK button to show or hide the highlighted channel.

Channel No.

Display the number of current channel.

Channel Label

Display the label of current channel.

DTV Signal:

Display the quality of current DTV signal.

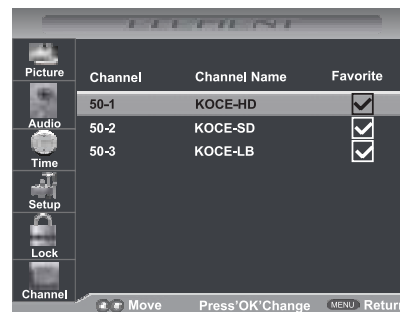

9. MEDIA MENU

Note: Before operating USB menu, plug in USB device, then press **SOURCE** button to set the Input Source to USB.

Photo Menu

Press ◀/▶ button to select Photo in the main menu.

Press ▲/▼ button to select drive disk you want to watch, then press **OK** button to enter.

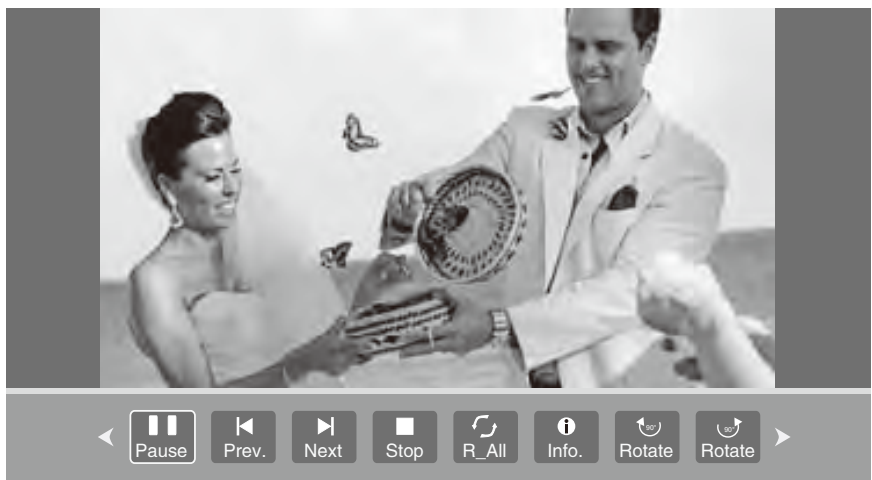
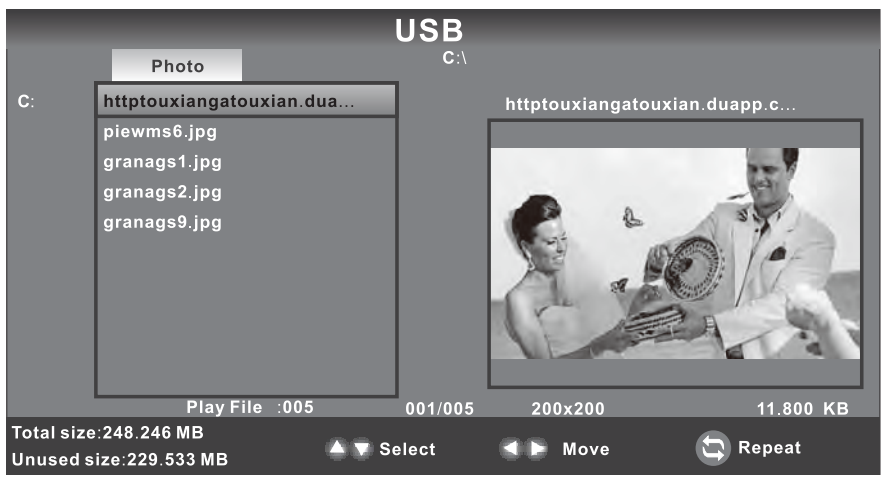

10. TROUBLESHOOTING

Please check if you can solve problems by troubleshooting yourself.

Troubleshooting	Control
No signal	Please check that all cables are correctly plugged in.
No color shades	Adjust the contrast, the color and the brightness.
Stain on the screen	May be the result from a lighting signal from car, motor, neon light and other electrical devices or appliances.
Double or multiple display image	May be the result of an electrical wave disturb from other TV, Computer and Game machine or Radio.
Snow on the screen	The cables of the antenna are not correctly plugged in.
The remote control does not work	Please check the batteries order and alignment. Check that the IR of the remote control is not hidden by something.
"Zip" made noise on TV cover	Even if the display image is correct, the noise may come from an unsteady fixation of the panel.
No sound	Make sure that you have not press the MUTE button of the remote control.

11. MAINTAINING

- Do not use your TV in areas that are too hot or too cold, because the cabinet may warp or the screen may malfunction. Your TV works best in temperatures that are comfortable to you.
- Storage temperatures are 32° to 122°F (0° to 50°C).
- Working temperatures are 32° to 104°F (0° to 40°C).
- Do not place your TV in direct sunlight or near a heat source.

12. SPECIFICATIONS

This manual is only for your reference, any change to the design and specification will not be advised.

Screen Size		31.5 Inch
Display Type		DLED
Resolution(Pixel)		1366X768
Aspect Ratio		16:9
Input Power		120V~, 60Hz
Power Consumption		65W
TV System		ATSC/NTSC
Video Input Format		PAL/NTSC
Audio Output Power		L / R 2X8W
SUPPORT	ANTENNA	YES
	AV-IN	YES
	YPbPr - IN	YES
	HDMI - IN	YES
	VGA(PC) - IN	YES
	VGA(PC) AUDIO - IN	YES
	SCART - IN	--
	SCART - OUT	--
	AUDIO - OUT	--
	S-VIDEO - IN	--
	COAXIAL - OUT	YES
	COMMON INTERFACE	--
	USB	YES
DVD	Disc Physical Format	--
	DVD Video Output Format	--
TV Dimensions	W/Stand(LxWxH-inches)	29.13*8.07*19.37inches
	W/O Stand(LxWxH-inches)	29.13*3.35*17.64inches
	Wall-mount	7.87*7.87 VESA(inches)
	Wall-mount Screw size	M5*8
Weight	Net (lbs.)	12.13
	Gross (lbs.)	15.43



This product contains electrical or electronic materials. The presence of these materials may, if not disposed of properly, have potential adverse effects on the environment and human health.

Presence of this label on the product means it should not be disposed of as unsorted waste and must be collected separately. As a consumer, you are responsible for ensuring that this product is disposed of properly. To find out how to properly dispose of this product, please go to www.elementelectronics.com and click on Sustainability.

HDMI™

This TV incorporates High-Definition Multimedia Interface (HDMI™) technology. HDMI, the HDMI logo and High-Definition Multimedia Interface are trademarks or registered trademarks of HDMI Licensing LLC.