

---

## 50" FHD Digital LED TV



### **INSTRUCTION MANUAL**

---

Please read all the instructions carefully before using this TV,  
and keep the manual for future reference.





<b>Important Safety Instructions</b>	<b>2</b>
<b>Additional Safety Information</b>	<b>3</b>
<b>Preparations</b>	<b>4</b>
What is Included	4
Front View	5
Rear View	6
Wall Mounting	6
Remote Control	7
<b>Connecting External Devices</b>	<b>9</b>
<b>Operating Your TV</b>	<b>10</b>
Turning On/Off Your TV	10
Setup Wizard	10
Selecting The Input Source	11
Channel Selection	11
Volume Adjustment	11
<b>Customizing TV Settings</b>	<b>12</b>
Navigating the On-screen Display	12
Picture Settings	13
Audio Settings	14
Time Settings	15
Setup Menu	16
Lock Settings	17
Parental Control	18
Channel Settings	20
<b>USB Multimedia</b>	<b>21</b>
Viewing Pictures	21
<b>Troubleshooting</b>	<b>22</b>
<b>FCC Notes</b>	<b>25</b>
<b>Specifications</b>	<b>25</b>

## IMPORTANT SAFETY INSTRUCTIONS

- **Read these instructions** – All the safety and operating instructions should be read before this product is operated.
- **Keep these instructions** – The safety and operating instructions should be retained for future reference.
- **Heed all warnings** – All warnings on the appliance and in the operating instructions should be adhered to.
- **Follow all instructions** – All operating and use instructions should be followed.
- **Do not use this apparatus near water** – The appliance should not be used near water or moisture – for example, in a wet basement or near a swimming pool, and the like.
- Clean only with dry cloth.
- **Do not block any ventilation openings.** Install in accordance with the manufacturer's instructions.
- **Do not install near any heat sources** such as radiators, heat registers, stoves, or other apparatus (including amplifiers) that produce heat.
- **Do not defeat the safety purpose of the polarized or grounding-type plug.** A polarized plug has two blades with one wider than the other. A grounding-type plug has two blades and a third grounding prong. The wide blade or the third prong are provided for your safety. If the provided plug does not fit into your outlet, consult an electrician for replacement of the obsolete outlet.
- Protect the power cord from being walked on or pinched particularly at plugs, convenience receptacles, and the point where they exit from the apparatus.
- Only use attachments/accessories specified by the manufacturer.
- Use only with the cart, stand, tripod, bracket, or table specified by the manufacturer, or sold with the apparatus. When a cart is used, use caution when moving the cart/apparatus combination to avoid injury from tip-over.



- Unplug this apparatus during lightning storms or when unused for long periods of time.

- Refer all servicing to qualified service personnel. Servicing is required when the apparatus has been damaged in any way, such as the power-supply cord or plug is damaged, liquid has been spilled or objects have fallen into the apparatus, the apparatus has been exposed to rain or moisture, does not operate normally, or has been dropped.
- Please keep the unit in a well-ventilated environment.

**WARNING:** To reduce the risk of fire or electric shock, do not expose this apparatus to rain or moisture. The apparatus should not be exposed to dripping or splashing. Objects filled with liquids, such as vases should not be placed on apparatus.

**WARNING:** The batteries shall not be exposed to excessive heat such as sunshine, fire or the like.

**WARNING:** The main plug is used as disconnect device, the disconnect device shall remain readily operable.

**WARNING:** To reduce the risk of electric shock, do not remove cover (or back) as there are no user-serviceable parts inside. Refer servicing to qualified personnel.



This lightning flash with arrowhead symbol within an equilateral triangle is intended to alert the user to the presence of non-insulated "dangerous voltage" within the product's enclosure that may be of sufficient magnitude to constitute a risk of electric shock.



The exclamation point within an equilateral triangle is intended to alert the user to the presence of important operating and maintenance instructions in the literature accompanying the appliance.



This equipment is a Class II or double insulated electrical appliance. It has been designed in such a way that it does not require a safety connection to electrical earth.

## **ADDITIONAL SAFETY INFORMATION**

---

To ensure reliable and safe operation of this equipment, please read carefully all the instructions in this user guide, especially the safety information below.

### **Electrical Safety**

- The TV set should only be connected to a main power supply with voltage that matches the label at the rear of the product.
- To prevent overload, do not share the same power supply socket with too many other electronic components.
- Do not place any connecting wires where they may be stepped on or tripped over.
- Do not place heavy items on them, which may damage the leads.
- Hold the main plug, not the wires, when removing from a socket.
- During a thunderstorm, or when not using the television for extended period of time, turn off the power switch on the back of the television.
- Do not allow water or moisture to enter the TV or power adapter. Do NOT use in wet, moist areas, such as bathrooms, steamy kitchens or near swimming pools.
- Pull the plug out immediately, and seek professional help if the main plug or cable is damaged, liquid is spilled onto the set, if accidentally exposed to water or moisture, if anything accidentally penetrates the ventilation slots or if the set does not work normally.
- Do not remove the safety covers. There are no user serviceable parts inside. Trying to service the unit yourself is dangerous and may invalidate the product's warranty. Qualified personnel must only service this apparatus.
- To avoid battery leakage, remove exhausted batteries from the remote control, or when not using for long period.
- Do not break open or throw exhausted batteries on a fire.
- Do not mix old and new batteries.
- Do not mix Alkaline, Standard (Carbon-Zinc) or Rechargeable (Nickel Cadmium) or (Nickel Metal Hydride) batteries.

### **Physical Safety**

- Do not block ventilation slots in the back cover. You may place the TV in a cabinet, but ensure at least 5cm (2") clearance all around.
- Do not tap or shake the TV screen, or you may damage the internal circuits. Take good care of the remote control.
- To clean the TV use a soft dry cloth. Do not use solvents or petroleum based fluids.
- Do not install near any heat sources such as radiators, heat registers, stoves or other apparatus (including amplifiers) that produce heat.
- Do not defeat the safety purpose of the polarized or grounding-type plug. A polarized plug has two blades with one wider than the other. A grounding type plug has two blades and a third grounding prong, the wide blade, or the third prong is provided for your safety. If the provided plug does not fit into your outlet, consult an electrician for replacement of the obsolete outlet.
- Protect the power cord from being walked on or pinched particularly at plugs.
- Unplug the apparatus during lightning storms or when unused for long periods.
- Refer all servicing to a qualified service personnel. Servicing is required when the apparatus has been damaged in any way, such as power-supply cord or plug is damaged, liquid has been spilled, or objects have fallen into the apparatus, has been exposed to rain or moisture, does not operate normally, or has been dropped.

# PREPARATIONS

---

## What is Included?

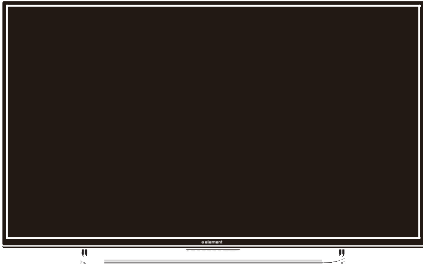

**TV Set**

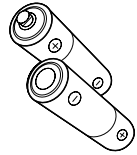

**Remote Control with Batteries**



**User Manual**





**Quick Start Guide**

## PREPARATIONS

---

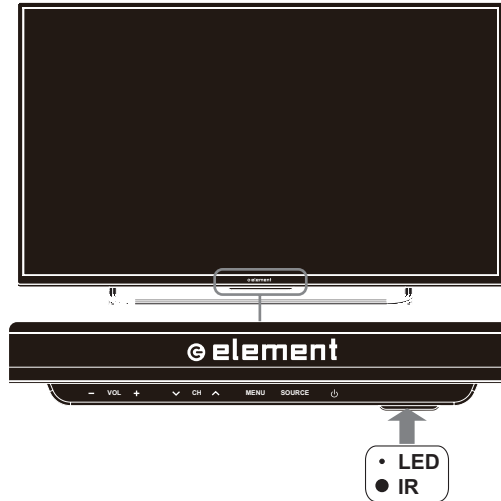
### Front View



-  Switch the TV between On / Standby mode.
- **SOURCE**  
Press to select among different input signal sources.
- **MENU**  
Display the OSD (on screen display) menu.
- **CH ^/∨**  
Press to select a channel.
- **VOL +/-**  
Press to adjust the volume.
- **LED**  
The LED light indicates when the TV is activated.
- **IR**  
Infrared Receiver.

## PREPARATIONS

### Rear View

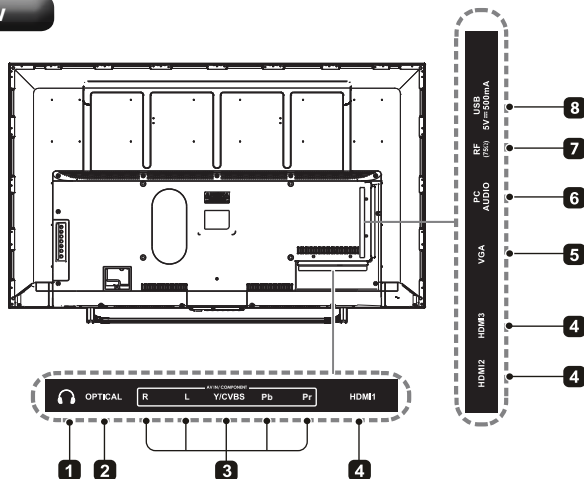

- 1. Headphone Socket**  
Connect to the Headphones.
- 2. Optical Output**  
Connect a digital sound system to this jack.
- 3. COMPONENT/ AV Input**  
Connect to the composite VIDEO and AUDIO (L/R) output sockets on external video devices. Connect to AV devices with component (Y/Pb/Pr) video output sockets.
- 4. HDMI Inputs**  
Connect to a High-Definition (HD) signal output device.
- 5. VGA Input**  
Connect to a computer or other devices with a VGA interface.
- 6. PC AUDIO Input**  
Connect to a computer audio output.
- 7. Antenna Input (75Ω VHF/UHF)**  
Connect to the antenna (75Ω VHF/UHF) socket with the RF coaxial cable.
- 8. USB Port**  
Connect to a USB storage device to play photo files. (USB mode)

### Wall Mounting

The TV is provided with mounting holes for a VESA approved wall mounting bracket (Not Supplied). Remove the screws holding the base to the base bracket and lift the base away (do not remove the base mounting brackets). Mount the VESA bracket using 4\*M6\*12 isometric threaded screws (Not Supplied).

#### WARNING

Never place a television set in an unstable location. A television set may fall, causing serious personal injury or death. Many injuries, particularly to children, can be avoided by taking simple precautions such as:

- Using cabinets or stands recommended by the manufacturer of the television set.
  - Only using furniture that can safely support the television set.
  - Ensuring the television set is not overhanging the edge of the supporting furniture.
  - Not placing the television set on tall furniture (for example, cupboards or bookcases) without anchoring both the furniture and the television set to a suitable support.
  - Not placing the television set on cloth or other materials that may be located between the television set and supporting furniture.
  - Educating children about the dangers of climbing on furniture to reach the television set or its controls.
- If your existing television set is being retained and relocated, the same considerations as above should be applied.



Your new TV is heavy, please consult with professional wall mount installer to perform this installation.



## PREPARATIONS

### Remote Control

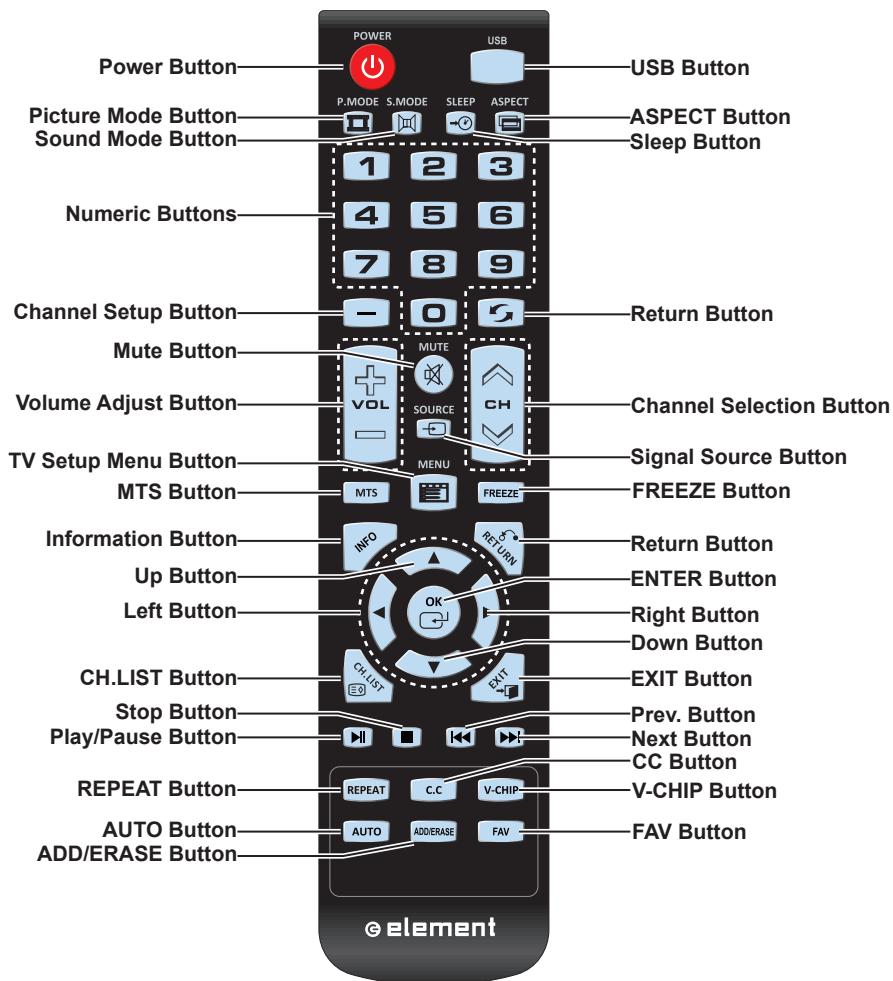







- If there is light around the TV, the remote control may fail or work abnormally.
- Please remove the batteries from the remote control when not in use for a long period time.
- Actual function for remote control keys prevails.
- To prevent battery leakage which may result in bodily injury or damage to the remote:

1. Install all batteries correctly, and as marked on the remote control.
2. Do not mix old and new batteries and do not mix alkaline, standard (carbon-zinc) or rechargeable (ni-cad, ni-mh, etc.) batteries.

## PREPARATIONS

### Remote Control

TV Operation	
	Switch the TV between on and standby mode.
<b>USB</b>	Access into the USB directly.
<b>P.MODE</b>	Select picture mode: Dynamic/Movie/Natural/User/Standard.
<b>S.MODE</b>	Select sound mode: Standard/Music/Movie/User.
<b>SLEEP</b>	Set the TV sleep timer: off/5/10.../180/240 min.
<b>ASPECT</b>	Select the aspect ratio settings:Normal/Wide/Zoom/Cinema/Just Scan(only for HDMI Source)/Dot To Dot(only for VGA Source).
<b>0~9</b>	Select a program (ATV/DTV mode)
—	Enter multiple program channel number , such as 2-1.
	Return to previous viewing channel.
<b>VOL+/-</b>	Adjust the volume.
<b>CH ^ / v</b>	Select a channel.
	Mute and restore your TV sound.
<b>SOURCE</b>	Select among the different input signal sources: TV/AV/Component/HDMI1/HDMI2/HDMI3/VGA/USB.
<b>MENU</b>	Display the OSD 'on screen display' menu.
<b>MTS</b>	Switch among different audio channels: STEREO/MONO/SAP.
<b>FREEZE</b>	Freeze the picture.
<b>INFO</b>	Display the present screen information such as the current channel and input source.
<b>RETURN</b>	Return to previous menu.
	Allows you to navigate the OSD menus and adjust the system settings to your preference.
<b>OK</b>	Confirm the selection in the OSD 'on screen display' menus.
<b>CH.LIST</b>	Display program list.
<b>EXIT</b>	Exit the OSD 'on screen display' menu.
<b>CC</b>	Closed Caption selection: Off/On/CC on Mute.
<b>V-CHIP</b>	Set up parental control.
<b>AUTO</b>	Automatically adjust the Horizontal/Vertical position in PC (VGA) mode.
<b>ADD/ERASE</b>	Add or delete Favorite channels.
<b>FAV</b>	Display the favorite channel list.

USB Operation	
	Press to pause or resume the playback.
	Press to stop the playback and clear the existing memory.
	Press to skip between chapters.
<b>REPEAT</b>	Press repeatedly to select the repeat mode.

# CONNECTING EXTERNAL DEVICES

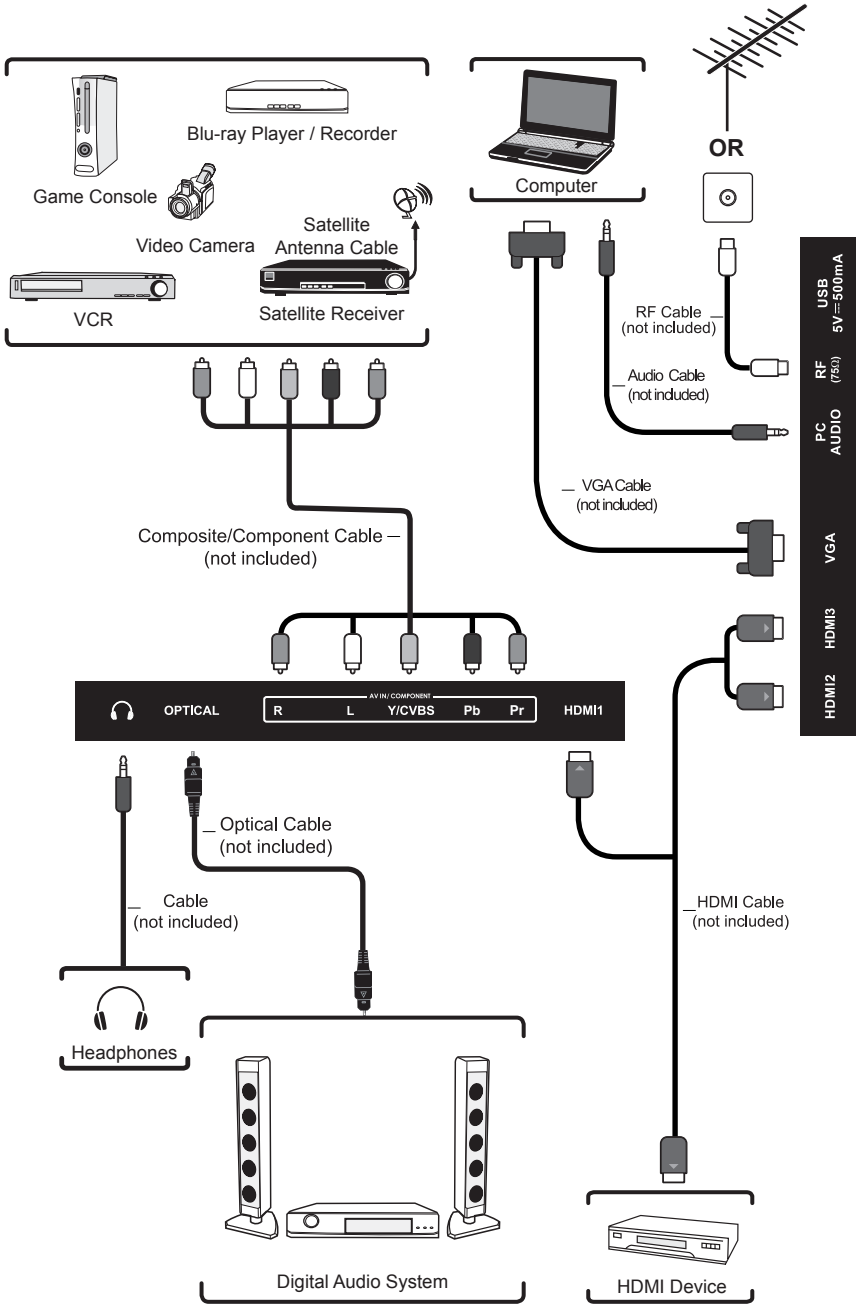

## OPERATING YOUR TV





### Turning On/Off Your TV

- Connect the power cord to the power socket after you have completed all the physical connections. At this stage, the TV will enter Standby Mode and the red LED indicator will illuminate.
- In Standby Mode, press the  button on the main unit or on the remote control to turn the TV on. The red LED indicator will turn blue.



The **POWER** button on the main unit or on the remote control can only switch the TV into standby. To completely turn off the TV, please disconnect the power cord from the power socket.

### Setup Wizard

- Press the  /  /  /  buttons to select your desired mode and press **OK** button to confirm.



<b>Menu Language</b>	Select your desired language to be displayed on the menu. The default on-screen menu language is set as English.
<b>Air/Cable</b>	Select antenna between Air and Cable.
<b>Cable System</b>	Select Cable system: Auto, STD, IRC, HRC.
<b>Auto Scan</b>	Search and store the available channels automatically.

## OPERATING YOUR TV

---

### Selecting The Input Source

- Press the **SOURCE** button on the main unit or on the remote control to display the Input Source list.
- Press the **▲/▼** buttons to select your desired input source among: TV/Component&AV/HDMI1/HDMI2/HDMI3/VGA/USB and then press **OK** button to confirm.

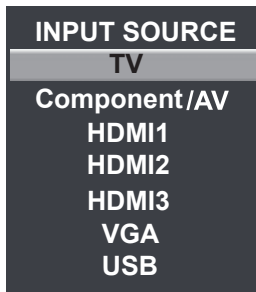

### Channel Selection

- Press the **CH<sup>^</sup>/CH<sup>v</sup>** buttons on the main unit or on the remote control repeatedly to select the channel.
- Press the **0-9** buttons on the remote control to select the channel directly.



- 
- Press "4", and then press **OK** button to select channel 4.
  - Press "4" and "5", and then press **OK** button to select channel 45.
  - Press "1", "2" and "3", and then press **OK** button to select channel 123.
- 

### Volume Adjustment

- Press the **VOL+/-** buttons on the main unit or on the remote control to adjust the volume.
- If you wish to switch the sound off, press the **MUTE** button again or the **VOL+** button to resume the sound.

# CUSTOMIZING TV SETTINGS

## Navigating the On-screen Display

- Press the **MENU** button to display the main menu.
- Press the **▲/▼** buttons to navigate and select the available menus.



## CUSTOMIZING TV SETTINGS

### Picture Settings

- Press the **MENU** button on the main unit or on the remote control then press the **▲/▼** buttons to select **PICTURE** menu and then press the **▶** or the **OK** button to enter.
- Press the **▲/▼** buttons to select the following picture options and then press the **◀/▶** buttons to adjust each option's setting.

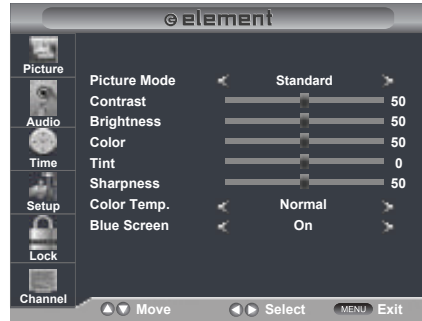



<b>Picture Mode</b>	Cycle among picture modes: Standard/Dynamic/Movie/Natural/User.  <b>Alternative:</b> you may press the <b>P.MODE</b> button to select the picture mode directly.
<b>Contrast</b>	Adjust the difference between light and dark levels in the pictures. <i>(For User mode)</i>
<b>Brightness</b>	Increase or decrease the amount of white in the picture. <i>(For User mode)</i>
<b>Color</b>	Control the color intensity. <i>(For User mode)</i>
<b>Tint</b>	Adjust the balance between red and green levels.
<b>Sharpness</b>	Adjust the level of crispness in the edges between light and dark areas of the picture. <i>(For User mode)</i>
<b>Color Temperature</b>	Cycle among color temperature: Cool/Normal/Warm.
<b>Blue Screen</b>	Allow the blue background to turn <b>On/Off</b> during weak or no signal conditions.

## CUSTOMIZING TV SETTINGS

### Audio Settings

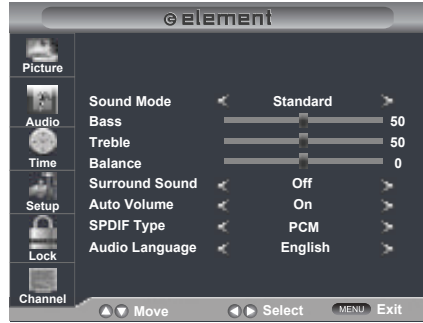
- Press the **MENU** button on the main unit or on the remote control then press the **▲/▼** buttons to select **AUDIO** menu and then press the **▶** or the **OK** button to enter.
- Press the **▲/▼** buttons to select the following audio options and then press the **◀/▶** buttons to adjust each option's setting.



<b>Sound Mode</b>	<p>Allow the selection of an audio-enhancement technique: Standard/Music/Movie/User.</p> <p> <b>Alternative:</b> You may press the <b>S.MODE</b> button to select the Sound mode directly.</p>
<b>Bass</b>	Control the relative intensity of lower-pitched sounds. <i>(For User mode)</i>
<b>Treble</b>	Control the relative intensity of higher-pitched sounds. <i>(For User mode)</i>
<b>Balance</b>	Adjust the audio output between the left and the right speakers.
<b>Surround Sound</b>	Provide an enhanced listening experience.
<b>Auto Volume</b>	Volume levels are automatically controlled.
<b>SPDIF Mode</b>	Select the digital audio output mode between RAW/PCM.
<b>Audio Language</b>	Select audio language among: English, French, Spanish.



## CUSTOMIZING TV SETTINGS

### Time Settings

- Press the **MENU** button on the main unit or on the remote control then press the **▲/▼** buttons to select **TIME** menu and then press the **▶** or the **OK** button to enter.
- Press the **▲/▼** buttons to select the following time options and then press the **◀/▶** button to adjust each option's setting.



<p><b>Sleep Timer</b></p>	<p>Select a period of time after which the TV automatically switches to standby mode: off/5/10/.../180/240 min.</p> <p> <b>Alternative:</b> You may press the <b>SLEEP</b> button repeatedly to select the number of minutes directly.</p>
<p><b>Time Zone</b></p>	<p>Select a Time Zone among: Pacific/Alaska/Hawaii/Eastern/Central/Mountain/Atlantic or Newfoundland.</p>
<p><b>Daylight Saving Time</b></p>	<p>Select to turn <b>On/Off</b> daylight saving time.</p>

## CUSTOMIZING TV SETTINGS

### Setup Menu

- Press the **MENU** button on the main unit or on the remote control then press the **▲/▼** buttons to select **SETUP** menu and then press the **▶** or the **OK** button to enter.
- Press the **▲/▼** buttons to select the following setup options and then press the **◀/▶** buttons to adjust each option's setting.

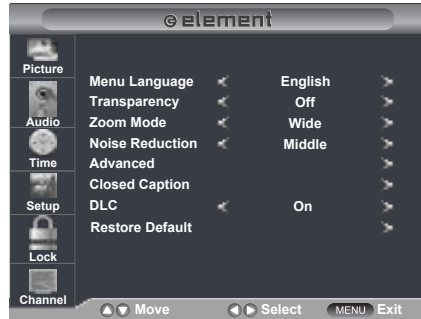

<b>Menu Language</b>	Select menu language among: English, Français or Español. The default on-screen menu language is English.	
<b>Transparency</b>	Select to turn <b>On/Off</b> transparency function.	
<b>Zoom Mode</b>	Select zoom mode among: Normal/Wide/Zoom/Cinema/Just Scan(only for HDMI Source)/Dot To Dot(only for VGA Source).	
<b>Noise Reduction</b>	Reduce the noise level of the connected device: Off/Weak/Middle/Strong.	
<b>Advanced</b>	Adjust the PC desktop content. (VGA source mode only)	
<b>Closed Caption</b>	Allows you to turn closed captioning of audio on or off, select analog or digital modes, or personalize the captioning style.	
	CC Mode	Select CC mode among: CC On, CC Off or CC on Mute.
	Basic Selection	Select analog mode among: CC1, CC2, CC3, CC4, Text1, Text2, Text3, Text4.
	Advanced Selection	Select digital mode among: Service1~6.
	Option	Personalize the captioning style, such as the size and color of the digital caption.
<b>DLC</b>	Select to turn <b>On/Off</b> the dynamic luminance control.	
<b>Restore Default</b>	Restore the TV to factory default settings. (Except the lock settings)	



## CUSTOMIZING TV SETTINGS

### Lock Settings

- Press the **MENU** button on the main unit or on the remote control and then press the **▲/▼** buttons to select **LOCK** menu.
- Use the **0-9** buttons to input 4-digit password to enter the **LOCK** menu.
- Press the **▲/▼** buttons to select the following options and then press the **◀/▶** buttons to adjust each option's setting.

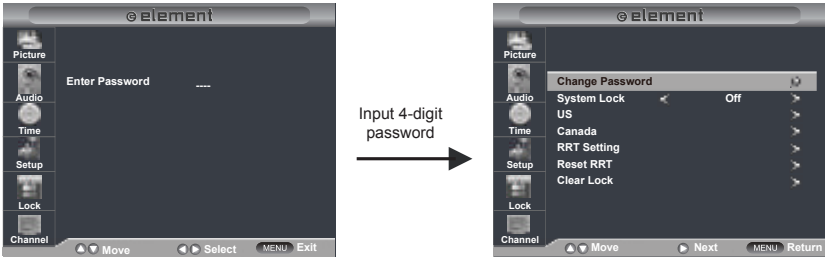

The default password is "0000".

<b>Change Password</b>	Use <b>0-9</b> buttons to input the old password and then input the new 4-digit password. Re-enter new password for confirmation.		
	<b>System Lock</b>	Select to turn <b>On/Off</b> system lock. The following options (US, Canada, RRT Setting and Reset RRT) will only be accessible when you turn the system lock on.	
<b>US</b>	TV	TV RATING: Press <b>OK</b> button to lock or unlock TV rating.	
	MPAA	Select MPAA rating among: N/A,G, PG, PG-13, R, NC-17,or X.	
<b>Canada</b>	Canada English	Select MPAA rating for English-speaking Canada among: E, C, C8+, G, PG, 14+, 18+.	
	Canada French	Select MPAA rating for Quebec Canada among: E, G, 8 ans+, 13 ans+, 16 ans+, 18 ans+.	
<b>RRT Setting</b>	Set Rating Region Table.		
<b>Reset RRT</b>	Select to reset the RRT setting.		
<b>Clear Lock</b>	Clear all lock settings.		

## CUSTOMIZING TV SETTINGS

---

### Parental Control

Press the **MENU** button on the main unit or on the remote control and then press the **▲/▼** buttons to select **LOCK** menu. Use the **0-9** buttons to input 4-digit password to enter the **LOCK** menu. If used, this option feature can "block" undesirable programming from appearing on the TV. Parental Control offers the user a wide variety of options and settings that restrict or "block" the programming that can appear on the TV. Parental Control allows the user the capability of defining which program rating they consider acceptable to the younger more sensitive viewer. It can be preset and turned either on or off by the user who specifies the secret 4-number code, the password. The number of hours blocked are specified. General audiences and children blocks should be both programmed into the TV's memory. Viewer ratings are specified for both TV and the motion picture Industry; both rating systems should be used, for complete coverage. The ratings are based on the ages of children.

#### Overview

To ensure complete coverage for all TV programs, (movies and regular TV shows) choose a rating for MPAA, from the selections below, as well as ratings from the TV Parental Guidelines Rating Systems below, using the Age Block option for General Audiences, and for children. In addition to those, you may wish to add additional restrictions from the content block menu, and submenus examples below.

#### Things to Consider before Setting up Parental Control

Determine which rating you consider acceptable to the viewer. (For example, if you choose TV-PG, more restrictive ratings will be automatically blocked; the viewer will not be able to see: TV-PG, TV-14, or TV-MA rated programming.) Do you want to block the auxiliary video source entirely? (Blocks the signal sent by the equipment, such as VCR, connected to the TV Audio/Video Input Jacks) Or leave unblocked, then choose allowable ratings. Block program "Content" based on individual parameters such as: Strong Dialog, Bad Language, Sex Scenes, Violence Scenes, or Fantasy. Violent Scenes; in Content Blk option. Select a secret password, in the Set Password option, using the numbers keys on the remote control. Do not forget the password, it is the only way you can access the Parental Control menu and change rating selections, or turn Parental Control off. Do you want the Parental Control to be active at all times? If not, you can turn it on or off with the Lock On/Off option.

- You can set different Parental Control viewing restrictions for general audiences and for children, both can be active at the same time.
- Simply specifying one content block such as Sex Scenes, will not automatically restrict the programming that appears from the video sources.
- Even if you choose to leave the AUX Inputs unblocked, the ratings you specify will automatically restrict the programming that appears from the video sources.
- You can not disable Parental Control by disconnecting the TV from power. Block hours will be automatically reset to the original block time setting specified if power is disconnected.

## CUSTOMIZING TV SETTINGS

### Motion Picture Association of America (MPAA) Rating System

	Grade	Meaning
<b>G</b>	General Audiences	Content not offensive to most viewers.
<b>PG</b>	Parental Guidance Suggested	Content is such that parents may not want their children to view the program.
<b>PG-13</b>	Parents Strongly Cautioned	Program is inappropriate for pre-teens, with a greater degree of offensive material suggested than a PG rated program.
<b>R</b>	Restricted	Not for children under 17, strong element of sex and/or violence.
<b>NC-17</b>	No children under age 17	Not for children under 17 under any circumstances. Strong sexual content.
<b>X</b>	Hard Core Films	Same as NC-17 rating.
<b>No Rating</b>	No Rating	MPAA Not Rated

### TV Parental Guideline Rating System

	Grade	Meaning
<b>TV-Y</b>	All Children	Content not offensive to most viewers.
<b>TV-Y7</b>	Directed to Older Children	Considered suitable for children over 7, may contain fantasy violence scenes.
<b>TV-G</b>	General Audience	Considered suitable for all audience; children may watch unattended.
<b>TV-PG</b>	Parental Guidance Suggested	Suggested unsuitable for younger children, may contain suggestive language, bad language, sex and violence scenes.
<b>TV-14</b>	Parents Strongly Cautioned	unsuitable for children under 14, may contain strong language, bad language, sex and violence scenes.
<b>TV-MA</b>	Mature Audience Only	Adults only, may contain strong language, bad language, sex and violence scenes.

#### **Canadian Rating:**

- *Canadian English is used throughout all English-speaking Canada (C, C8+,G, PG,14+, 18+).*
- *Canadian French is used in Quebec (G,8 ans+, 13 ans+,16 ans+, 18 ans+).*





The V-Chip will automatically block certain categories that are "more restrictive". If you block TV-Y category, then TV-Y7 will be automatically blocked. Similarly, if you block TV-G category, then all the categories in the "young adult" will be blocked (TV-G, TV-PG, TV-14, and TV-MA).

# CUSTOMIZING TV SETTINGS

## Channel Settings

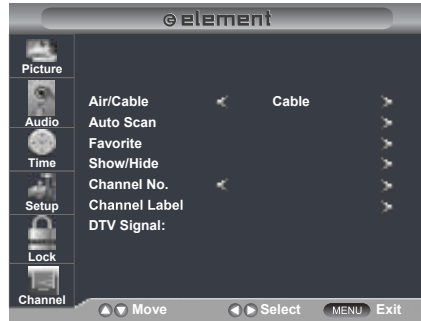
- Press the **MENU** button on the main unit or on the remote control and then press the **▲/▼** buttons to select **CHANNEL** menu.
- Press **▲/▼** buttons to select the following channel options and then press the **◀/▶** buttons to adjust each option's setting.



<b>Air/Cable</b>	Select antenna between Air and Cable.
<b>Auto Scan</b>	<p>Find and store all available channels automatically.</p> <ul style="list-style-type: none"> <li>• Allows you to select cable system among Auto/STD/IRC/HRC before going to auto scan if you choose <b>Cable</b> as input signal.</li> </ul>  <ul style="list-style-type: none"> <li>• It will go straight to auto scan if you choose <b>Air</b> as input signal.</li> </ul> 
<b>Favorite</b>	Set the selected channel as one of the favorite programs.
<b>Show/Hide</b>	Show/Hide the selected channel.
<b>Channel No.</b>	Display the current channel number.
<b>Channel Label</b>	Display the current channel label.
<b>DTV Signal</b>	Display the quality of current DTV signal.

## USB MULTIMEDIA

### Viewing Pictures

- Press the **SOURCE** button on the main unit or on the remote control then press the **▲/▼** buttons to select the **USB** mode and then press **OK** button.
- Press the **▲/▼** buttons to select **PHOTO** and then press **OK** button.



File format supported: JPEG.

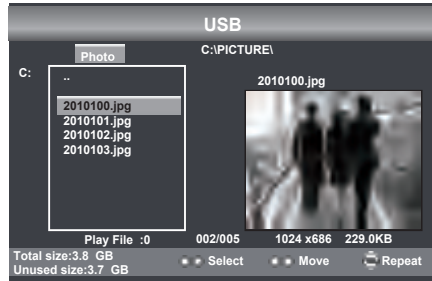

### Operation Tips

	Press to start or pause the photo playback.
	Press to stop photo playback.
	Press to play the previous track or view the previous photo.
	Press to play the next track or view the next photo.
<b>REPEAT</b>	Press to select different repeat mode.

## TROUBLESHOOTING

If your TV does not operate normally or cannot be turned on, please check the following troubleshooting questions. Remember also to check any other connected electronic device, such as DVD or blu-ray player to pinpoint the problem. If the TV still fails to operate normally, please contact technical support (Refer to Warranty page).

SYMPTOM	POSSIBLE CAUSE	REMEDY
Dead. No LED lit	No power to the TV.	<ul style="list-style-type: none"><li>• Check all connections to the TV's AC socket.</li></ul>
Dead. No LED lit red	Set in standby mode.	<ul style="list-style-type: none"><li>• Press either the Power button or the Standby button on the remote control.</li></ul>
Blue screen	No signal.	<ul style="list-style-type: none"><li>• Press the SOURCE button to select the correct source.</li></ul>
	Incorrect source selected.	
Noisy, snowy, ghosting picture (TV)	Poor antenna signal.	<ul style="list-style-type: none"><li>• If using an indoor antenna, try adjusting the antenna position. Check antenna connections.</li></ul>
No sound	Sound "Mute".	<ul style="list-style-type: none"><li>• Turn sound "Mute" off.</li></ul>
	Volume set too low.	<ul style="list-style-type: none"><li>• Check volume settings.</li></ul>
	External leads not connected "if used".	<ul style="list-style-type: none"><li>• Check that all external leads are connected properly.</li></ul>



## TROUBLESHOOTING

Before contacting the service technician, perform the following simple checks. If any problem still persists, unplug the LED TV and call for assistance.

PROBLEM	POSSIBLE SOLUTIONS
No sound and picture	<ul style="list-style-type: none"> <li>• Check that the main plug has been connected to a wall outlet.</li> <li>• Check that you have pressed the POWER on the front of the TV set.</li> <li>• Check the picture contrast and the brightness setting.</li> </ul>
Red LED indicator lights	<ul style="list-style-type: none"> <li>• Set in standby mode. Press either the Power button or the Standby button on the remote control.</li> </ul>
Normal picture but no sound	<ul style="list-style-type: none"> <li>• Check the volume.</li> <li>• Sound muted? Press the MUTE button.</li> <li>• Try another channel, the problem may be with the broadcast.</li> <li>• Are the audio cables installed properly?</li> </ul>
The remote control does not work	<ul style="list-style-type: none"> <li>• Check to see if there are any objects between the TV and remote control causing obstruction.</li> <li>• Are batteries installed with correct polarity (+/-)?</li> <li>• Correct remote operating mode set: TV, VCR, etc?</li> <li>• Install new batteries.</li> </ul>
Power suddenly turns off	<ul style="list-style-type: none"> <li>• Is the sleep timer set?</li> <li>• Check the power connection, power may be interrupted.</li> <li>• No broadcast on the station tuned.</li> </ul>
Picture appears slowly after switching on	<ul style="list-style-type: none"> <li>• This is normal, the image is muted during the product start up process. Please contact a service provider if the picture has not appeared after 5 minutes.</li> </ul>
Poor color or picture	<ul style="list-style-type: none"> <li>• Adjust the color in Menu option.</li> <li>• Keep a sufficient distance between the product and the VCR.</li> <li>• Try another channel, the problem may be with the broadcast.</li> <li>• Are the VIDEO cables installed properly?</li> <li>• Activate any function to restore the brightness of the picture.</li> </ul>
Horizontal/vertical bars or picture shaking	<ul style="list-style-type: none"> <li>• Check for local interference, such as an electrical appliance or power tool.</li> </ul>
Blue screen	<ul style="list-style-type: none"> <li>• Press the SOURCE button to select correct source.</li> </ul>
Poor reception on some channels	<ul style="list-style-type: none"> <li>• Station or cable experiencing problems. Tune to another station.</li> <li>• Station signal is weak, reorient antenna for better reception.</li> <li>• Check for sources of possible interference.</li> </ul>
Lines or streaks in pictures	<ul style="list-style-type: none"> <li>• Check the antenna (change the direction of the antenna).</li> </ul>
No output from one of the speakers	<ul style="list-style-type: none"> <li>• Adjust balance in the Menu option.</li> </ul>

## TROUBLESHOOTING

---

Note: When there is a problem in VGA mode ( only when VGA mode is applied).

PROBLEM	POSSIBLE SOLUTIONS
The signal is out of range	<ul style="list-style-type: none"><li>• Adjust resolution, horizontal or vertical frequency.</li><li>• Check whether the signal cable is connected or loose.</li><li>• Check the input source.</li></ul>
Vertical bar or strip on the background, horizontal noise and incorrect position	<ul style="list-style-type: none"><li>• Set the auto configure or adjust clock, phase, or H/V position.</li></ul>
Screen color is unstable or is a single color	<ul style="list-style-type: none"><li>• Check the signal cable.</li><li>• Reinstall the PC video card.</li></ul>

### Maintenance

Early malfunction can be prevented. Careful and regular cleaning can extend the amount of time you will have with your new TV. Be sure to turn the power off and unplug the power cord before you begin any cleaning.

Do not use your TV in areas that are too hot or too cold, because the cabinet may warp or the screen may malfunction. Your TV works best in temperatures that are comfortable to you.

Storage temperatures are 32° to 122°F(0° to 50°C).

Working temperatures are 32° to 95°F(0° to 35°C).

Do not place your TV in direct sunlight or near a heat source.

-minimum 5cm distances around the apparatus for sufficient ventilation;

-the ventilation should not be impeded by covering the ventilation openings with items, such as newspapers, table-cloths, curtains, etc.;

-no naked flame sources, such as lighted candles, should be placed on the apparatus;

-attention should be drawn to the environmental aspects of battery disposal.

### Clean the screen

A great tip to dust off your screen: wet a soft cloth in a mixture of lukewarm water and a little fabric softener or dish washing detergent. Wring the cloth until it's almost dry, and then use to wipe the screen.

Make sure the excess water is off the screen, then let air-dry before you turn on the TV.

### Cleaning the cabinet

To remove dirt or dust, wipe the cabinet with a soft, dry, line-free cloth. Please be sure not to use a wet cloth.



- "Warning: Changes or modifications to this unit not expressly approved by the party responsible for compliance could void the user's authority to operate the equipment."

- "NOTE: This equipment has been tested and found to comply with the limits for a Class B digital device, pursuant to Part 15 of the FCC Rules. These limits are designed to provide reasonable protection against harmful interference in a residential installation. This equipment generates, uses and can radiate radio frequency energy and, if not installed and used in accordance with the instructions, may cause harmful interference to radio communications.

However, there is no guarantee that interference will not occur in a particular installation. If this equipment does cause harmful interference to radio or television reception, which can be determined by turning the equipment off and on, the user is encouraged to try to correct the interference by one or more of the following measures:

- Reorient or relocate the receiving antenna.
- Increase the separation between the equipment and receiver.
- Connect the equipment into an outlet on a circuit different from that to which the receiver is connected.
- Consult the dealer or an experienced radio/TV technician for help."

Please send all correspondence to:  
Element TV Company, LP. Customer Service  
15930 Valley Blvd., City of Industry, CA 91744  
customerservice@elementelectronics.com

## SPECIFICATIONS

Panel Size	49.5 inches diagonally
Display Type	LED
Panel Technology	TFT
Panel 60 Hz Vs. 120 Hz	60 Hz
Display Resolution	1080P
HDMI & Component Support	Up to 1080P
Panel Resolution	1920 x1080
Aspect Ratio	16:9
Contrast Ratio-Panel	1000:1
Brightness (Centre Typ.) Cd/M <sup>2</sup>	170~250
Response Time (G To G)	8.5 ms
Lamp Life (Typ. Hours)	20,000 hours
Horizontal Viewing Angle (At CR>10)	178
Vertical Viewing Angle (At CR>10)	178
TV System	ATSC/NTSC
Channel Range	VHF/UHF

*Design and specifications are subjects to change without prior notice.*



This product contains electrical or electronic materials. The presence of these materials may, if not disposed of properly, have potential adverse effects on the environment and human health. Presence of this label on the product means it should not be disposed of as unsorted waste and must be collected separately. As a consumer, you are responsible for ensuring that this product is disposed of properly.



39063482