

# TCS3000 Series Toroidal Conductivity Sensor

## Product Instructions

### Introduction

Modern conductivity measurement devices include a class of sensors which use an electrodeless system to determine the conductivity of a fluid. Electrodeless probes function by first exciting a toroid with an AC voltage to produce a magnetic flux in the core. This flux then produces an alternating current flow in the fluid, which passes as a loop through the center of the core. A second toroid then acts as a sensor by using the fluid's current to produce a magnetic flux in its core which, in turn creates current flow in its windings. The current flow in the fluid and subsequently the detector toroid's windings, depends on the conductivity of the solution, thereby giving an accurate measurement without contacting the fluid directly.

Your Electrodeless Conductivity Sensor provides a very linear voltage output signal versus the conductivity of the solution within which it is placed. The overall output is proportional to the excitation signal driven into the driver toroid, the amount of gain provided by the output signal amplifier, and the conductivity of the medium being measured. Thus, calibration must be done with a known conductivity solution and the electronics.

### Mechanical Installation

Your toroidal sensor can be installed in 2 ways:

1. Submersion mount: Mount sensor into rigid or flexible conduit using a 3/4" NPT coupling and attaching to the 3/4" NPT threads near the sensor's cable. Be sure to seal conduit to avoid fluid build up in conduit.

2. In-Line mount:

a. Plumb flow cell FC95C into line. Flow cell FC95C is provided with 2" slip fittings. For threaded connection install a 2" slip x NPT female adapter (CPVC SCH 80).

b. Install o-ring into FC95C as shown in FIG. 1

c. Install TCS-3020 toroidal sensor into FC95C. Match notch on flange of sensor with tab of flow cell as show in FIG. 2.

d. Install nut onto threads of flow cell and turn clockwise. **DO NOT USE TEFLON TAPE OR SEALANT ON THREADS!**

Parts covered by this product data sheet include:  
TCS3000, TCS3020

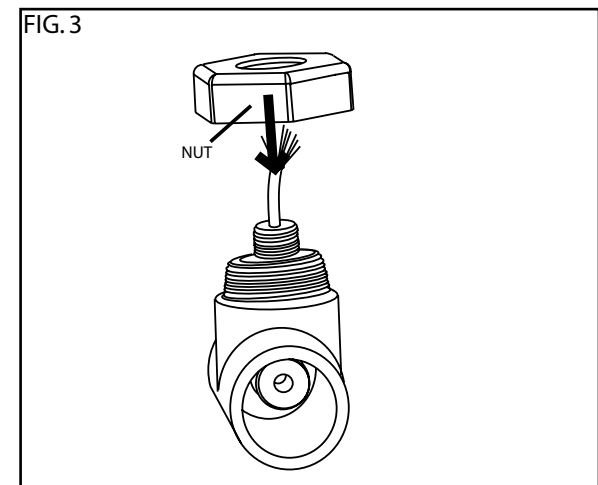
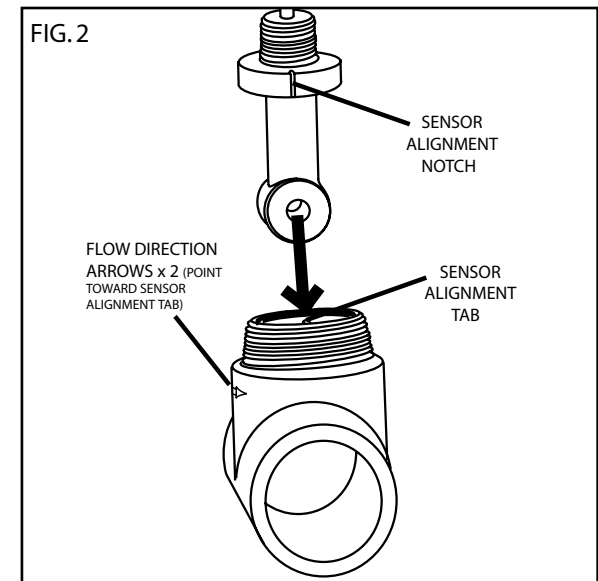
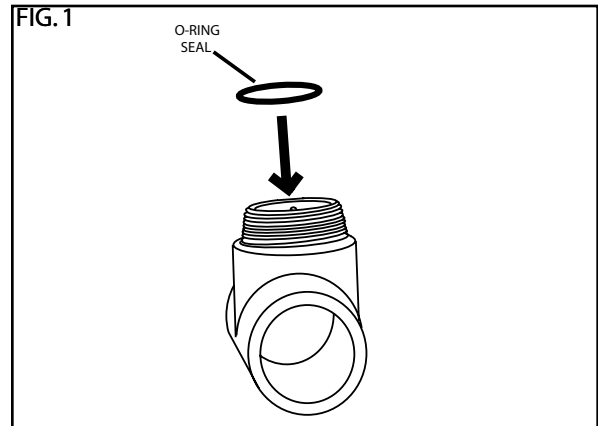

## Sensor Wiring

The probe has 9 total leads (see FIG. 4).

The driver toroid is connected to the red and black leads with the red shrink tubing around them. When using the probe with various controllers, it is important that the red lead be connected to an AC DRIVER or VOLTAGE IN position while the black lead is connected to a GROUND or DRIVER RETURN line.

The detector toroid is connected to the white and black leads with the white shrink tubing around them. The white lead is typically connected to the SIGNAL IN location and the black lead is connected to a GROUND or SIGNAL RETURN line.

The temperature element is connected to the green and black leads with the green shrink tubing around them. Connect these to the TEMPERATURE INPUT locations. The polarity is not important.

The 3 bare leads, which supply individual pair shielding throughout the cable, should typically be connected to a ground or drain line. Note: The shield leads are not connected to one another, they are all individual shields for the three bundles of wires.

Refer to your controller manual for specific wiring details.

## Cable Considerations

The cable uses PVC to protect the wires during use. If the cable comes in contact with the working fluid, the temperature and pressure ratings must be adjusted to allow for the lower temperature limits of the cable. *The cable can withstand 105 deg C (DRY) but should only be subjected to 70 deg C when immersed in a fluid.* The jacket becomes significantly weakened by liquid (raising the possibility of shorting) and all attempts should be made to keep the cable out of the fluid environment. Do not run cable in the same conduit with any other A.C. power wiring nor routed close to any high current demanding equipment. Seal conduit to avoid build-up of moisture. Do not cut cable. Shorter or longer cables can be provided.

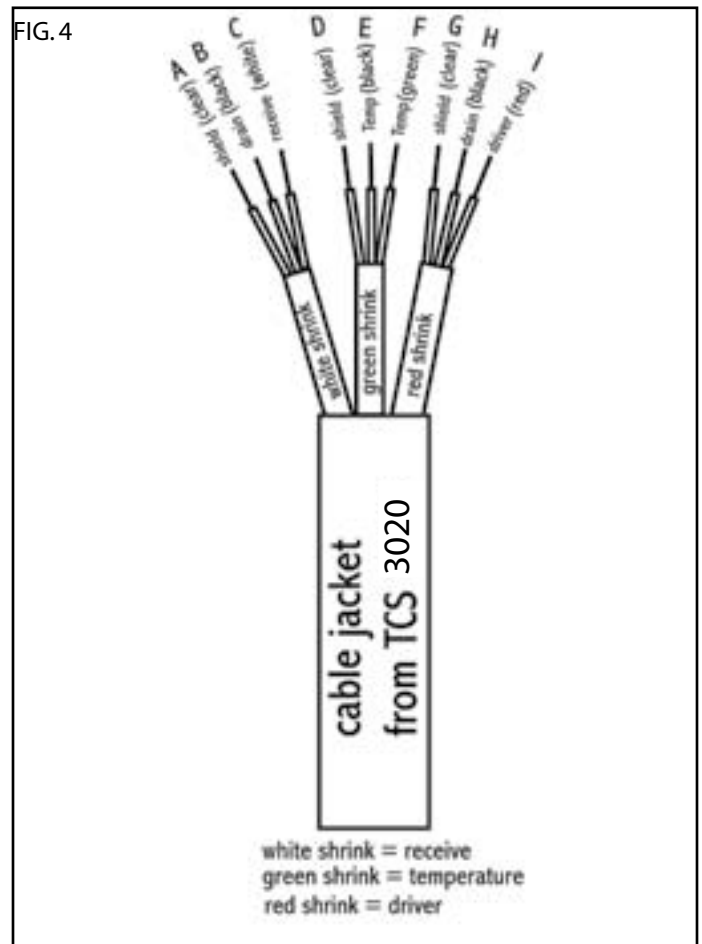

## Sensor Calibration

After the sensor is properly connected, the system should be calibrated. The typical calibration procedure uses a "low" and a "high" known standard conductivity solution. The "low" solution is often DI water or air and is used to calibrate the zero point of the controller. Plotting these two points will create a straight line, which can be used to find the conductivity value of any solution in the range. Make sure probe is immersed in the calibration fluid such that the toroids are totally submerged. A sample plot is provided in FIG. 5 to show the approximate values, which will be encountered during calibration. *Note: The values in the plot are arbitrary, each probe will require unique linear equation values.*

If the sensor is to be used in a submersion application, calibrate the sensor in a large glass or plastic beaker with all sides of the sensor at least one inch away from the wall (FIG. 6). If the production installation is a pipe (plastic or metal), calibration should be performed in a similar pipe arrangement. All Electrodeless (Toroidal) sensors have a wall effect, which must be taken into account during calibration. If the non-conductive (plastic) wall is within 1 inch of the sensor, the sensor's reading will be reduced due to the insulator interaction with the current path. If the sensor is within 1 inch of a conductive (metal) wall, the sensor's reading will be increased due to the shorting effect of the conducting wall. These wall effects can be calibrated out of the system by simulating the application's mounting configuration. A plot showing the effects of insulating and conducting walls on the output can be seen in FIG. 7. During calibration and production installation (especially in a submersion environment), it is important to dislodge any air bubbles, paying special attention to the center hole of the toroids. Also make sure toroids are totally covered with fluid when calibrating (FIG. 6).

Please refer to your controller's manual for specific calibration instructions.

## Sensor Maintenance

The major advantage of the Electrodeless (Toroidal) Sensor is almost no maintenance is required. The only maintenance required during normal operational life of the sensor is to prevent the toroidal opening from being plugged with debris. Use a soft brush or rag to remove any debris in the core opening. If that does not work, try a mild detergent or weak acid (5-10% HCl).

Parts covered by this product data sheet include:  
TCS3000, TCS3020

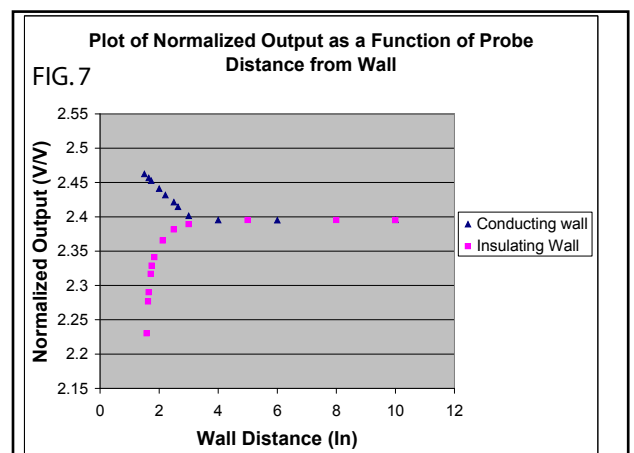
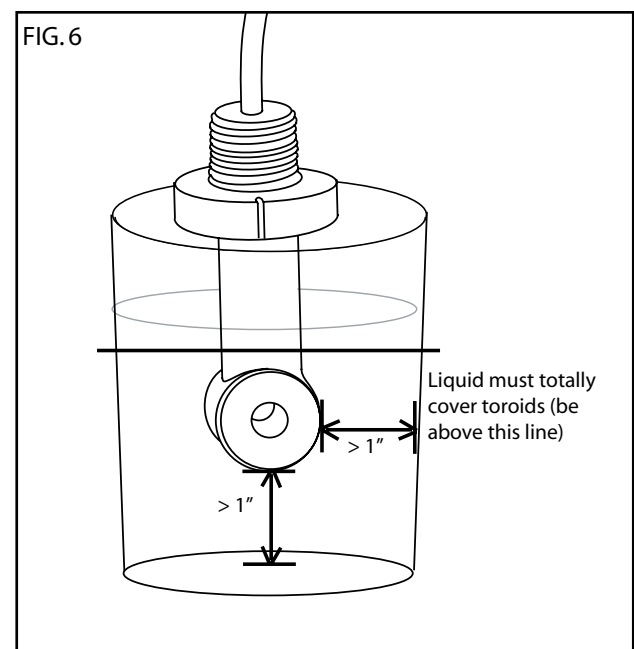
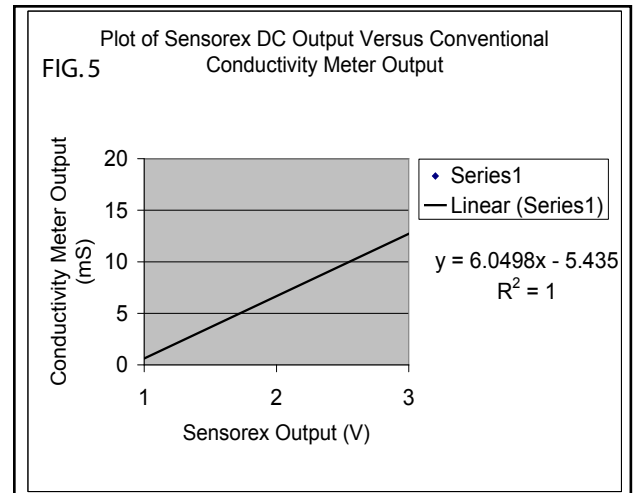

## Sensor Troubleshooting

If your sensor is not reading as expected check resistance of leads as shown in FIG. 8. Check temperature leads as shown in FIG 9 (Pt100 RTD and Pt1000 RTD are only shown).

## Sensor Specifications

Installation Type:	Submersion via 3/4" NPT or in-line via FC95C flow cell
Conductivity Range:	500-2,000,000 uS
Maximum Temperature:	
Sensor:	100 deg C
Flow cell:	100C
Cable:	105 deg C (Dry) 70 deg C (wet)
Maximum Pressure:	100 psig
Wetted Materials:	
Sensor:	Noryl
Flow cell:	CPVC
O-ring:	Viton
Temperature Compensation:	via Pt100 or Pt1000RTD

FIG. 8

SHRINK COLOR	WIRE COLOR	RESISTANCE
RED	RED	0.5 OHMS
RED	BLACK	>20 MEGOHMS (OPEN)
RED	CLEAR	
WHITE	WHITE	0.5 OHMS
WHITE	BLACK	> 20 MEGOHMS (OPEN)
WHITE	CLEAR	
GREEN	GREEN	109 or 1090 OHMS**
GREEN	BLACK	>20 MEGOHMS (OPEN)
GREEN	CLEAR	

FIG. 9

RTD TYPE	TEMP. (deg C/deg F)	RESISTANCE(Ohms)
100 Ohm RTD	18/64.4	106.9
100 Ohm RTD	19/66.2	107.3
100 Ohm RTD	20/68	107.7
100 Ohm RTD	21/69.8	108.1
100 Ohm RTD	22/71.6	108.4
100 Ohm RTD	23/73.4	108.9
100 Ohm RTD	24/75.2	109.2
100 Ohm RTD	25/77.0	109.6
100 Ohm RTD	26/78.8	110.0
100 Ohm RTD	27/80.6	110.4
*	*	*

Note: There is approximately 0.4 Ohm change /Deg C for Pt100 RTD and approximately 3.9Ohm/ Deg C for Pt1000RTD.