

Description

Very cost effective design to meet international requirements. No exposed metal parts which are, or could become, current-carrying except for terminals. R-type TO CBE to EN 60934.

- Manual reset, cycling trip free mechanism
- Extremely small and lightweight
- UL, CSA, VDE and EN 60934 (IEC 60934) approved

Typical applications

Battery chargers, consumer products, power supplies, motors.

Ordering information

Type No.

1658 single pole thermal circuit breaker

Threadneck design

G21 manual reset type, 3/8"-27 threadneck

A00 auto reset type, without threadneck

Hardware

00 no hardware

01 one PAL nut Y306 671 01, bulk

02 one PAL nut Y306 671 01,
one knurled nut Y307 117 02, bulk

Terminals

P10 blade terminals A6.3-0.8 (QC .250)

P13 blade terminals A6.3-0.8 (QC .250), 90°

Current ratings

5...30 A

1658 - G21 - 02 - P10 - 5 A Ordering example

* Screws and lock washers bulk shipped

Packaging unit: minimum order quantity 250 pieces

Preferred types

| Preferred types | Standard current ratings (A) | | | | | | | | | | | |
|------------------|------------------------------|---|---|---|---|----|----|----|----|----|----|----|
| | 5 | 6 | 7 | 8 | 9 | 10 | 12 | 15 | 16 | 20 | 25 | 30 |
| 1658-G21-02-P10- | x | x | x | x | x | x | x | x | x | x | x | x |
| 1658-G21-02-P13- | x | x | x | x | x | x | x | x | x | | | |
| 1658-A00-00-P10- | x | x | x | x | x | x | x | x | x | | | |

Standard current ratings and typical voltage drop values

| Current rating (A) | voltage drop values (mV) | Current rating (A) | voltage drop values (mV) |
|--------------------|--------------------------|--------------------|--------------------------|
| 5 | ≤ 250 | 12 | ≤ 250 |
| 6 | ≤ 250 | 15 | ≤ 250 |
| 7 | ≤ 250 | 16 | ≤ 250 |
| 8 | ≤ 250 | 20 | ≤ 250 |
| 9 | ≤ 250 | 25 | ≤ 250 |
| 10 | ≤ 250 | 30 | ≤ 250 |



1658-...

Technical data

For further details please see chapter: Technical Information

| | | | |
|---|---|----------------|---|
| Voltage rating | AC 240 V; DC 28 V | | |
| Current ratings | 5...30 A | | |
| Typical life | AC + DC | 5...16 A | 1,000 operations at 2 x I _N , inductive |
| | | 17...25 A | 1,000 operations at 2 x I _N , resistive |
| Behaviour at rated switching capacity (EN 60934; test sequence D) | operat. | I _N | U _N |
| | 40 | 5...16 A | AC 240 V 6 x I _N ind |
| | 40 | 5...16 A | DC 28 V 4 x I _N ind |
| | 40 | 17...25 A | AC 240 V 120 A resistive |
| | 40 | 17...25 A | DC 28 V 120 A resistive |
| Ambient temperature | -20...+60 °C (-4...+140 °F), ≤ 7 A max. +40 °C (+104 °F) | | |
| Insulation co-ordination (IEC 60664 and 60664 A) | rated impulse withstand voltage | 2.5 kV | pollution degree 2 reinforced insulation in operating area |
| Dielectric strength (IEC 60664 and 60664A) | test voltage | operating area | AC 3,000 V |
| Insulation resistance | > 100 MΩ (DC 500 V) | | |
| Interrupting capacity I _{cn} | 5...7 A | 180 A | |
| | 8...30 A | 200 A | |
| Interrupting capacity (UL 1077/EN 60934 PC1) | I _N | U _N | |
| | 5...16 A | AC 240 V | 2,000 A |
| | 5...30 A | AC 120 V | 2,000 A |
| | 5...30 A | DC 32 V | 2,500 A |
| | 5...30 A | DC 28 V | 2,000 A (1658-A..) |
| Degree of protection (IEC 60529/DIN 40050) | operating area IP40 terminal area IP00 | | |
| Vibration | 8 g (57-500 Hz) ± 0.61 mm (10-57 Hz), to IEC 60068-2-6, test Fc, 10 frequency cycles/axis | | |
| Shock | 30 g (11 ms) to IEC 60068-2-27, test Ea | | |
| Corrosion | 96 hours at 5 % salt mist, to IEC 60068-2-11, test Ka | | |
| Humidity | 240 hours at 95 % RH to IEC 60068-2-78, test Cab | | |
| Mass | approx. 16 g | | |

Dimensions

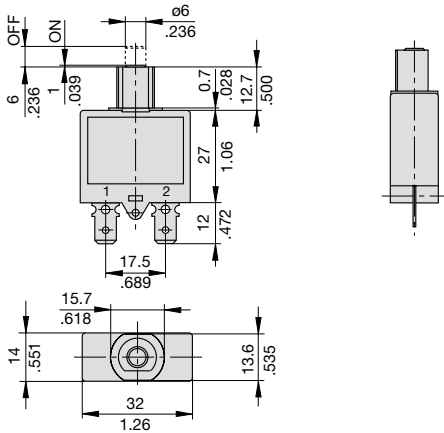

A00



G21 tightening torque max. 0.8 Nm
3/8-27UNS-2A

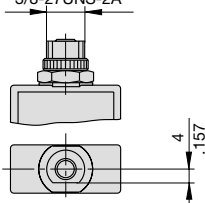

See ordering information for mounting hardware.

Terminal design

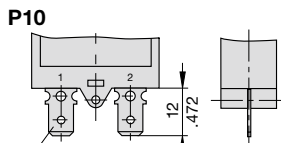

blade terminals DIN 46244-A6.3-0.8
(QC .250)

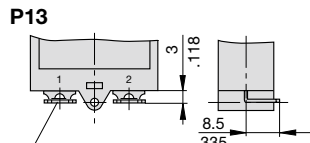

blade terminals DIN 46244-A6.3-0.8 (QC .250)
angled 90°

Installation drawing

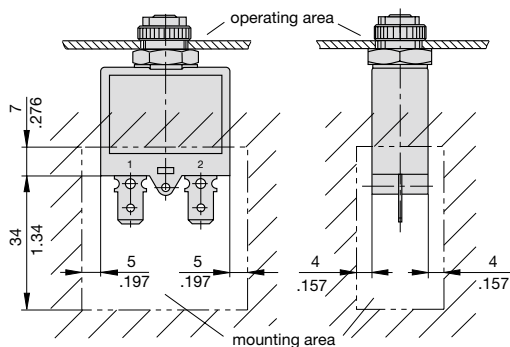

Internal connection diagram

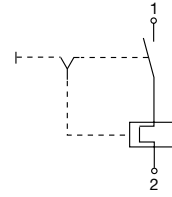

Typical time/current characteristics

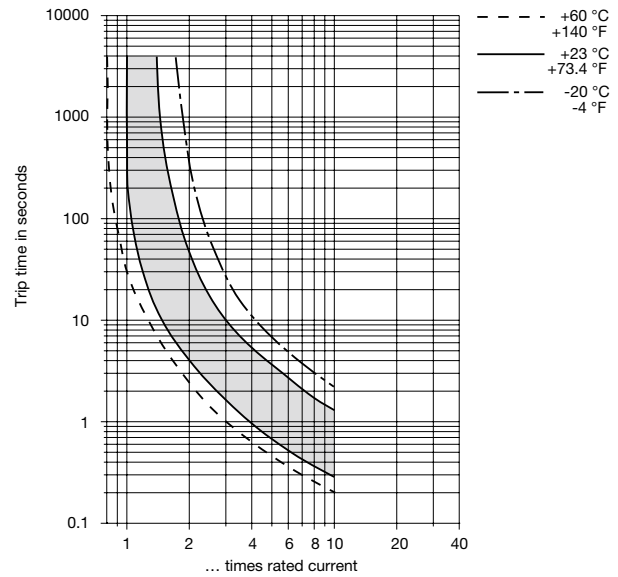

The time/current characteristic curve depends on the ambient temperature prevailing. In order to eliminate nuisance tripping, please multiply the circuit breaker current ratings by the derating factor shown below. See also section Technical information.

| Ambient temp. °F | -4 | +14 | +32 | +73.4 | +104 | +122 | +140 |
|----------------------------|------|------|------|-------|------|------|------|
| Ambient temp. °C | -20 | -10 | 0 | +23 | +40 | +50 | +60 |
| Derating factor $I_N > 7A$ | 0.83 | 0.85 | 0.9 | 1 | 1.1 | 1.18 | 1.25 |
| Derating factor $I_N < 7A$ | 0.74 | 0.76 | 0.82 | 1 | 1.23 | - | - |

This is a metric design and millimeter dimensions take precedence ($\frac{mm}{inch}$)

Accessories

PAL nut 3/8", 27-thread
Y 306 671 01

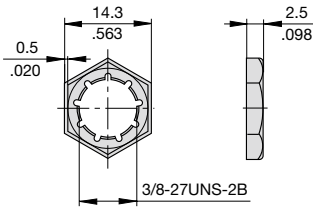

Knurled nut 3/8", 27-thread plastic (standard)
Y 307 117 02

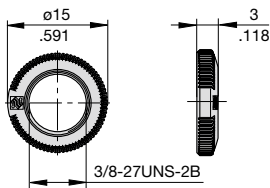

Knurled nut 3/8", 27-thread nickel-plated brass
Y 300 190 03

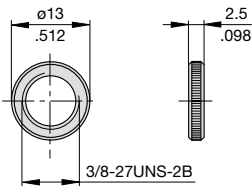

Hex nut 3/8", 27-thread nickel-plated brass
Y 300 192 01

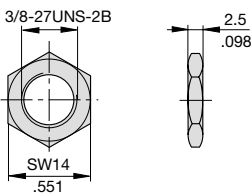

Press to Reset Plate for 3/8" thread, aluminium
Y 301 059 02

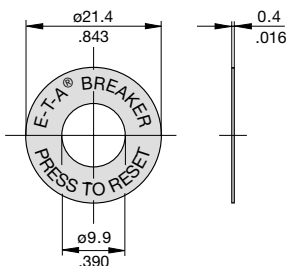

Reset button seal for 3/8", 27-thread, short
X 201 285 01 (IP64)

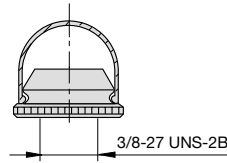

Reset button seal for 3/8", 27-thread, long
X 200 799 01 (IP64)

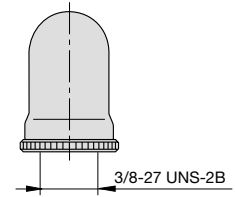

Panel cut out

1658-3/8-27 UNS-2A

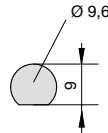

Approvals

| Authority | Standard | Rated voltage | Current ratings |
|---------------|--|---|--|
| 1658-G | | | |
| VDE | IEC/EN 60934 | AC 240 V DC 28 V | 5 A...25 A 5 A...25 A |
| UL | UL 1077 CSA C22.2 No 235 UL 1500 Ignition Protected | AC 250 V AC 240 V AC 125 V DC 32 V | 5 A...15 A 5 A...16 A 5 A...30 A 5 A...30 A |
| CSA | CSA C22.2 No 235 | AC 250 V AC 240 V AC 125 V DC 32 V | 5 A...15 A 5 A...16 A 5 A...30 A 5 A...30 A |
| 1658-A | | | |
| VDE | IEC/EN 60934 | AC 240 V DC 28 V | 5 A...25 A 5 A...25 A |
| UL | UL 1077 | AC 125 V DC 28 V | 5 A...30 A 5 A...30 A |

This is a metric design and millimeter dimensions take precedence ($\frac{mm}{inch}$)

All dimensions without tolerances are for reference only. In the interest of improved design, performance and cost effectiveness the right to make changes in these specifications without notice is reserved. Product markings may not be exactly as the ordering codes. Errors and omissions excepted.

