



**Class 1**

ISO 9001 CERTIFIED

---

607 NW 27th Ave  
Ocala, FL 34475  
Phone: (352) 629-5020 or 800-533-3569  
Fax: (352)-629-2902

SUITABLE FOR EXTERNAL DISTRIBUTION

## TECHNICAL PRODUCT DATASHEET

### Total Pressure Governor TPG

P/N 117155



 607 NW 27th Ave Ocala, FL 34475 Ph: 352-629-5020 or 1-800-533-3569 Fax: 352-629-2902 or 1-800-520-3473	<b>TECHNICAL DATA SHEET</b>			<b>PAGE</b>	<b>1 OF 34</b>	
	<b>PRODUCT GROUP</b>	THROTTLE CONTROL	<b>P/N</b>	117155	<b>DATE</b>	8/28/2017
	<b>PRODUCT</b>	<b>TOTAL PRESSURE GOVERNOR (TPG)</b>			<b>REV</b>	2.03
					<b>BY</b>	<b>AMS/GMC</b>

<b>1.</b>	<b>REVISION LOG .....</b>	<b>3</b>
<b>2.</b>	<b>SYSTEM OVERVIEW .....</b>	<b>4</b>
2.1.	SYSTEM PART NUMBERS .....	4
2.2.	HARNESS DETAIL (P/N 117666 AND P/N 117683) .....	4
<b>3.</b>	<b>TOTAL PRESSURE GOVERNOR OVERVIEW .....</b>	<b>6</b>
3.1.	DISPLAY .....	7
3.2.	INTERLOCK STATUS INDICATORS .....	7
3.3.	CONTROL SWITCHES .....	7
3.3.1.	<i>IDLE</i> .....	7
3.3.2.	<i>MENU/SILENCE</i> .....	7
3.3.3.	<i>PRESET</i> .....	7
3.3.4.	<i>MODE</i> .....	7
3.3.5.	<i>INC</i> .....	7
3.3.6.	<i>DEC</i> .....	7
3.4.	MODE INDICATOR .....	7
3.5.	BATTERY VOLTAGE MONITOR .....	8
3.6.	COOLANT TEMPERATURE MONITOR .....	8
3.7.	OIL PRESSURE MONITOR .....	8
<b>4.</b>	<b>OPERATION .....</b>	<b>9</b>
4.1.	INITIALIZATION .....	9
4.2.	OPERATING MODE SELECTION .....	9
4.2.1.	<i>Throttle mode</i> .....	9
4.2.2.	<i>Pressure mode</i> .....	10
4.3.	REQUIRED INTERLOCKING .....	12
4.4.	PRESET SWITCH OPERATION .....	12
4.5.	IDLE SWITCH OPERATION .....	13
4.6.	MENU/SILENCE SWITCH OPERATION .....	13
4.6.1.	<i>Viewing the engine and pump related items</i> .....	13
4.6.2.	<i>Silencing the alarm</i> .....	13
4.7.	STATUS AND WARNING MESSAGES .....	14
<b>5.</b>	<b>GOVERNOR CONTROL SETUP MENU .....</b>	<b>15</b>
5.1.	ENGINE COMPATIBILITY .....	15
5.2.	ENTER THE SETUP MENU .....	15
5.2.1.	<i>UNITS (unit of measure configuration)</i> .....	19
5.2.2.	<i>PRESET RPM (throttle preset configuration)</i> .....	19
5.2.3.	<i>HI-IDLE (high idle configuration)</i> .....	19
5.2.4.	<i>PRESET PSI (pressure preset configuration)</i> .....	19
5.2.5.	<i>BRIGHT (display brightness)</i> .....	19
5.2.6.	<i>DISPLAY TEST</i> .....	19
5.2.7.	<i>ROUND PSI (configure rounding of the pressure value)</i> .....	19
5.2.8.	<i>ALERT TONE (configure alert tones)</i> .....	19
5.2.9.	<i>SENSITIVITY (pressure sensitivity configuration)</i> .....	20
5.2.10.	<i>SENSOR CAL (pressure sensor calibration)</i> .....	20
5.2.11.	<i>1<sup>st</sup> MODE (first active mode configuration)</i> .....	20
5.2.12.	<i>AUTO MODE (pressure mode automatically entered on pump engagement)</i> .....	20
5.2.13.	<i>COMM STATUS (view the CAN communication status)</i> .....	20
5.2.14.	<i>CONTROL (engine control message type)</i> .....	20
5.2.15.	<i>RPM<sub>idle</sub> (idle RPM value)</i> .....	21

 607 NW 27th Ave Ocala, FL 34475 Ph: 352-629-5020 or 1-800-533-3569 Fax: 352-629-2902 or 1-800-520-3473	<b>TECHNICAL DATA SHEET</b>			<b>PAGE</b>	<b>2 OF 34</b>	
	<b>PRODUCT GROUP</b>	THROTTLE CONTROL	<b>P/N</b>	117155	<b>DATE</b>	8/28/2017
	<b>PRODUCT</b>	<b>TOTAL PRESSURE GOVERNOR (TPG)</b>			<b>REV</b>	2.03
					<b>BY</b>	<b>AMS/GMC</b>

5.2.16.	RPMmaxi (maximum RPM value).....	21
5.2.17.	SourceID (CAN message source identification).....	21
5.2.18.	TSC1 RAMP (TSC1/PGN0 control mode RPM ramp speed).....	21
5.2.19.	DISPLAY (primary display in pressure mode).....	21
5.2.20.	PSI TIME-OUT (pressure time out).....	21
5.2.21.	ALLOW PRESET (allow RPM preset use when pressure is detected).....	22
5.2.22.	WARNINGS (data monitor warning configuration).....	23
A.	WARN °F (User defined engine temperature high warning - Yellow LED).....	23
B.	CRIT °F (User defined engine temperature high critical - Red LED).....	23
C.	WARN PSI (User defined oil pressure low warning - Yellow LED).....	23
D.	CRIT PSI (User defined oil pressure low critical - Red LED).....	23
5.2.23.	XDUCR (discharge pressure transducer range).....	23
5.2.24.	FACTORY DFLT (Set factory defaults).....	23
5.2.25.	POC ASSERT (Power On Cycle assertion).....	23
5.2.26.	GOV GAIN (RPM change per step).....	23
5.2.27.	PRESS GAIN (PSI change per step).....	23
5.2.28.	DITHER (Engine handshake).....	24
5.2.29.	LAG ΔPSI (Pressure lag).....	24
5.2.30.	PUMP HOURS.....	24
5.2.31.	BCM1 VER (Body Control Message 1 version).....	24
5.2.32.	SCANIA MODE? (Scania governor type) (Prior to software version 7.xx).....	24
5.2.33.	SCANIA MODE? (Scania governor type) (Available software version 7.xx).....	24
5.2.34.	SCANIA CONTROL TYPE? (Scania governor type) (Available software version 7.xx).....	24
5.2.35.	VOLVO CONTROL MODE? (Volvo governor type) (Available software version 7.xx).....	24
5.2.36.	IDLE STEPS (Analog control idle).....	25
5.2.37.	OKAY2PUMP (Okay to pump interlock source).....	25
5.2.38.	SPN 3350 (TSC1 – SPN 3350).....	26
5.2.39.	SPN 696 (Engine Requested Speed Control Condition).....	26
5.2.40.	TSC1 MODE? (Available software version 7.xx).....	26
5.2.41.	HI IDLE MODE.....	26
5.2.42.	BUS INTLKS (Bus message control of throttle ready interlock).....	26
5.2.43.	VOLTS (Voltage display calibration).....	27
5.2.44.	SMOOTHING (Pressure display averaging).....	27
5.2.45.	ENGINE ID (Source ID of received engine messages).....	27
<b>6.</b>	<b>SPECIAL FUNCTION PASSWORDS (SEE SECTION 5.2 FOR PROCEDURE ON ENTERING PASSWORDS).....</b>	<b>28</b>
6.1.	SETTING CONTROL MESSAGE TRANSMISSION REQUIREMENTS.....	28
6.2.	SETTING CONTROL FOR SPECIFIC ENGINE TYPES.....	28
6.3.	CONFIGURING TRANSMISSION OF HYDRAULIC PRESSURE GOVERNOR MESSAGE.....	28
<b>7.</b>	<b>CONFIGURATION.....</b>	<b>30</b>
7.1.	CONFIGURE THE UNIT OF MEASURE.....	30
7.2.	SELECT PRESSURE TRANSDUCER RANGE (300 PSI, 600 PSI).....	30
7.3.	ZERO CALIBRATE THE PRESSURE TRANSDUCER.....	31
7.4.	CONFIGURE THE ENGINE CONTROL METHOD.....	31
7.5.	CONFIGURE THE IDLE VOLTAGE AND GAIN SETTING USING AUTO SCALE.....	32
<b>8.</b>	<b>MOUNTING &amp; INSTALLATION.....</b>	<b>33</b>
8.1.	PANEL CUTOUT DIMENSIONS.....	33
<b>9.</b>	<b>CONNECTOR DESCRIPTION.....</b>	<b>34</b>
9.1.	TPG CONNECTORS.....	34
9.2.	PRESSURE SENSOR CONNECTOR.....	34

 607 NW 27th Ave Ocala, FL 34475 Ph: 352-629-5020 or 1-800-533-3569 Fax : 352-629-2902 or 1-800-520-3473	<b>TECHNICAL DATA SHEET</b>			<b>PAGE</b>	<b>3 OF 34</b>	
	<b>PRODUCT GROUP</b>	THROTTLE CONTROL	<b>P/N</b>	117155	<b>DATE</b>	8/28/2017
	<b>PRODUCT</b>	<b>TOTAL PRESSURE GOVERNOR (TPG)</b>			<b>REV</b>	2.03
					<b>BY</b>	<b>AMS/GMC</b>

## 10. MODULE OPERATING PARAMETERS ..... 35

### 1. Revision Log

Rev	Date	Changes
1.00	3/4/2008	Initial revision
1.10	5/2/2008	Update connector description section. Update kit and optional part numbers.
1.20	3/24/2010	Added "Okay to pump" configuration information and detail.
1.21	4/13/2010	Revised wording in overview section 3.
1.22	3/2/2012	Added new feature listing for software versions 3.8 and 3.9
1.23	3/28/2012	Added error message for Throttle interlock to section 4.6
1.24	8/8/2012	Added note to harness detail section regarding early versions of TPG with black Deutsch connector Added section 4.6 concerning Menu/Silence button operation and viewable information
1.25	1/15/2013	Corrected display wording in section 7.3 and added range for 600 PSI transducer
1.26	3/4/2015	Expanded range of Idle RPM setting based on version 4.6 software.
2.00	8/12/2016	Updated Manual to include updated Software (7.xx) required for Hardware Version F and greater.
2.01	9/12/2016	Corrected page numbers and edited CAN specification to reflect MAX baud rate of 500.
2.02	8/21/2017	Added listing for TSC1 MODE in level 5 Menu and SCANIA-3 in Scania options
2.03	8/28/2017	Added Ford F-Series notification

 607 NW 27th Ave Ocala, FL 34475 Ph: 352-629-5020 or 1-800-533-3569 Fax: 352-629-2902 or 1-800-520-3473	<b>TECHNICAL DATA SHEET</b>			<b>PAGE</b>	<b>4 OF 34</b>	
	<b>PRODUCT GROUP</b>	THROTTLE CONTROL	<b>P/N</b>	117155	<b>DATE</b>	8/28/2017
	<b>PRODUCT</b>	<b>TOTAL PRESSURE GOVERNOR (TPG)</b>			<b>REV</b>	2.03
					<b>BY</b>	<b>AMS/GMC</b>

## 2. System Overview

### 2.1. System part numbers

Total Pressure Governor (TPG) system kit 117690

Kit includes

Total Pressure Governor (TPG)	QTY-1	117155
TPG main system harness	QTY-1	117666
Transducer 0-300 PSI	QTY-1	113557
Quick reference guide	QTY-1	117685

Optional items

TPG analog signal harness (analog control option)	117683
Transducer 0-600 PSI	117179

Documentation (available from Class 1's website - [www.class1.com](http://www.class1.com))

TPG system Manual (this manual)	117684
Engine compatibility guide	117686

### 2.2. Harness detail (p/n 117666 and p/n 117683)

The main system harness (p/n 117666) is comprised of a pair of harnesses: the power/communication harness (depicted below in blue) and the signals harness (depicted below in green).

When the analog signal control option is desired instead of the standard CAN control option then the analog control option harness is also required (p/n 117683). This harness is actually a set of wires and pins which must be inserted into connector C1 (depicted below with a red dashed line).

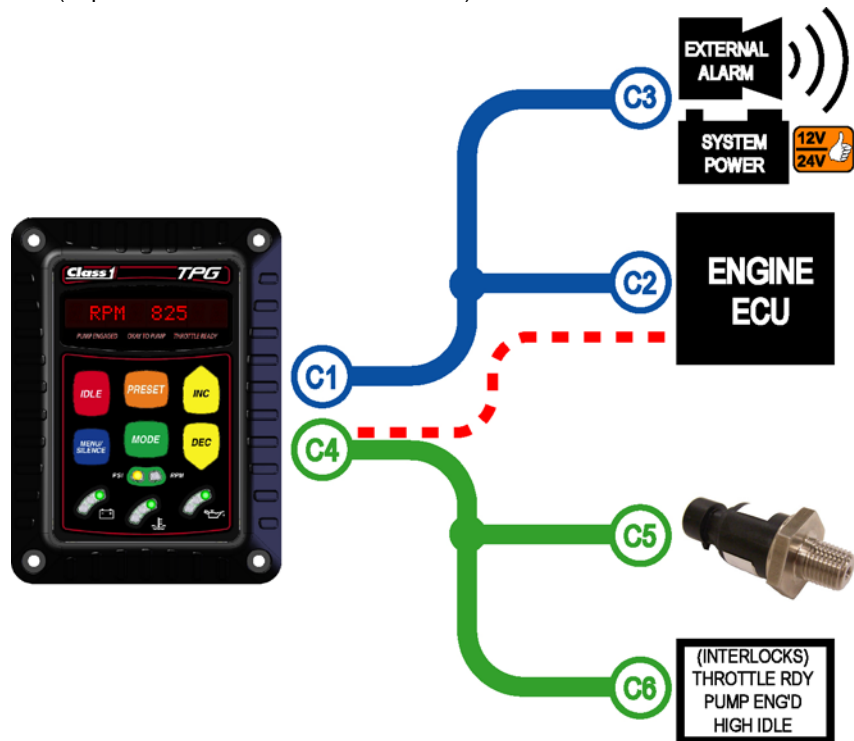



Figure 1. Harness nomenclature.

 <p>607 NW 27th Ave Ocala, FL 34475 Ph: 352-629-5020 or 1-800-533-3569 Fax: 352-629-2902 or 1-800-520-3473</p>	<b>TECHNICAL DATA SHEET</b>			PAGE	5 OF 34	
	PRODUCT GROUP	THROTTLE CONTROL	P/N	117155	DATE	8/28/2017
	PRODUCT	TOTAL PRESSURE GOVERNOR (TPG)			REV	2.03
					BY	AMS/GMC



Early versions of the TPG governor utilized a Black 12 position Deutsch connector instead of the grey connector. The wiring between these two is slightly different and the pin-out needs to be verified before replacing an older unit with a new one.

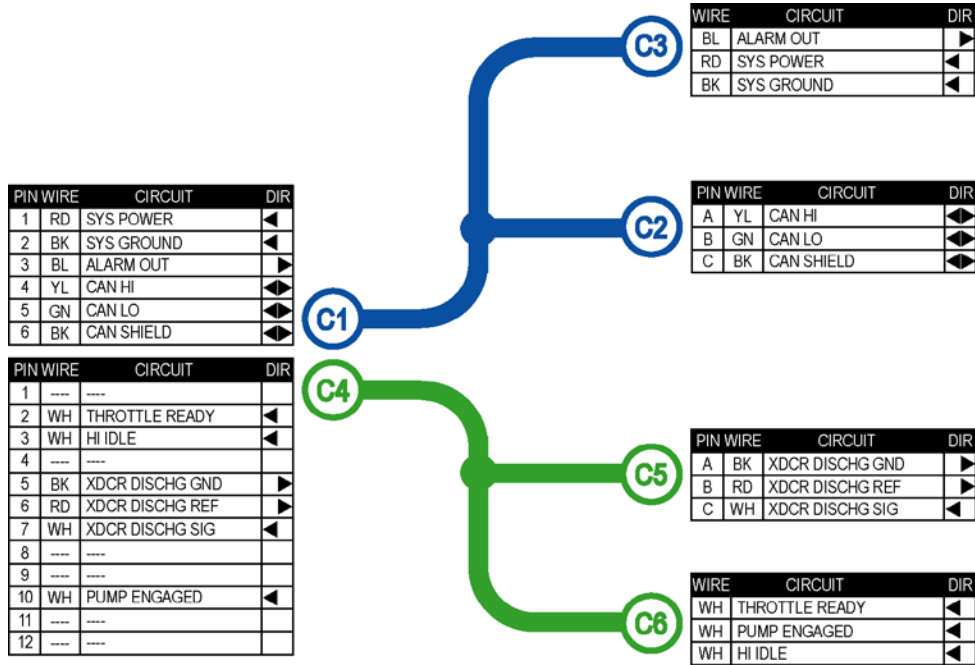

Figure 2. Harness wiring detail - p/n 117666.

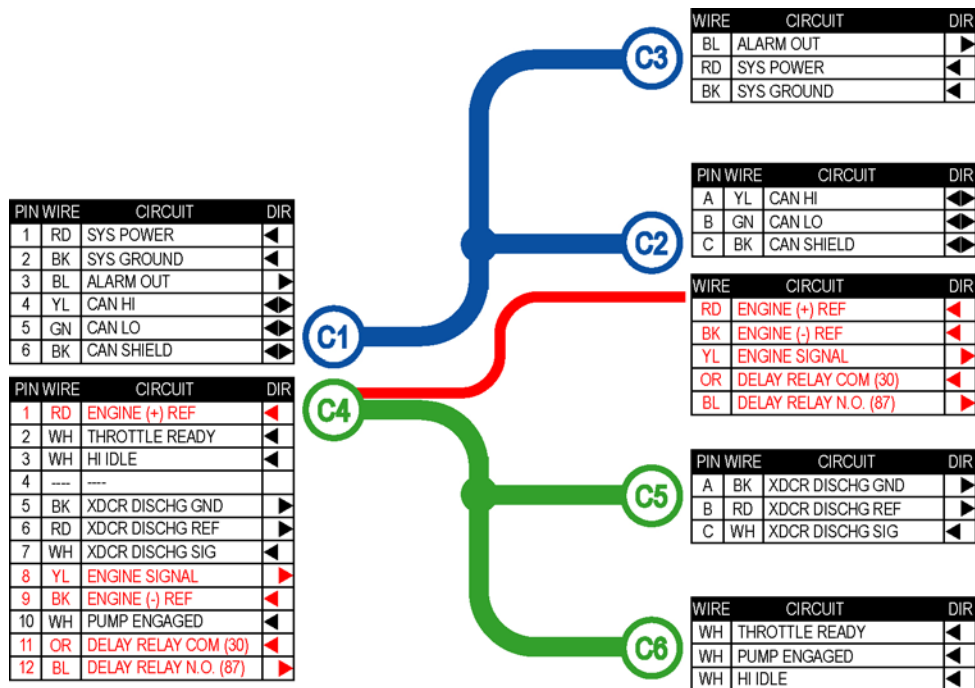



Figure 3. Harness wiring detail - p/n 117666 with analog option harness p/n 117683 (red).

 607 NW 27th Ave Ocala, FL 34475 Ph: 352-629-5020 or 1-800-533-3569 Fax: 352-629-2902 or 1-800-520-3473	<b>TECHNICAL DATA SHEET</b>			<b>PAGE</b>	<b>6 OF 34</b>	
	<b>PRODUCT GROUP</b>	THROTTLE CONTROL	<b>P/N</b>	117155	<b>DATE</b>	8/28/2017
	<b>PRODUCT</b>	<b>TOTAL PRESSURE GOVERNOR (TPG)</b>			<b>REV</b>	2.03
					<b>BY</b>	<b>AMS/GMC</b>

### 3. Total Pressure Governor Overview

The Total Pressure Governor (TPG) p/n 117155 is an SAE J1939 Controller Area Network (CAN) device that controls engine speed using data communications directly to the engine ECU or with an analog control signal. By operating on the J1939 network, the governor is able to monitor engine RPM and other pertinent data directly from the engine ECU. Engine information is available directly so that NFPA required instrumentation is delivered through a single unit saving panel space and delivering engine specific warnings as determined by each engine manufacturer.

Control algorithms are optimized to take advantage of the J1939 CAN data to yield crisp and accurate control of engine and subsequently pump speed and pressure output.

On units with starting with software version 7.xx the Governor when first installed and powered will step through a CAN Auto BUAD rate detection sequence. Once the Governor determines which BAUD rate the CAN bus is running on it will save it to memory.

For engines that may not support the data link control, an analog output signal is available to provide precise control of the engine speed and pressure.

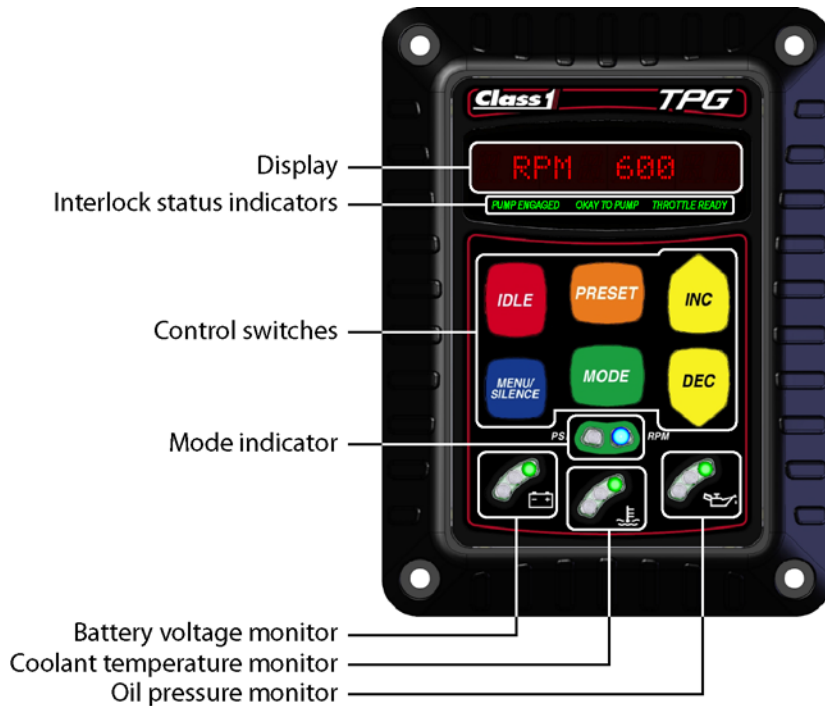



Figure 4. TPG controls and indicators.

 607 NW 27th Ave Ocala, FL 34475 Ph: 352-629-5020 or 1-800-533-3569 Fax: 352-629-2902 or 1-800-520-3473	<b>TECHNICAL DATA SHEET</b>			<b>PAGE</b>	<b>7 OF 34</b>	
	<b>PRODUCT GROUP</b>	THROTTLE CONTROL	<b>P/N</b>	117155	<b>DATE</b>	8/28/2017
	<b>PRODUCT</b>	<b>TOTAL PRESSURE GOVERNOR (TPG)</b>			<b>REV</b>	2.03
					<b>BY</b>	<b>AMS/GMC</b>

### 3.1. Display

The display shows the pertinent governor information: engine RPM, set pressure, warning and information messages.

### 3.2. Interlock status indicators

Backlit text indicates the status of the three (3) interlocks: *pump engaged*, *okay to pump*, and *throttle ready*. *Throttle ready* and *pump engaged* are physical inputs into the TPG's 12 pin connector (pins 2 and 10 respectively). *Okay to pump* interlock status can be configured to become active when both the *throttle ready* and *pump engaged* interlocks are present (default) or when the TPG's pin 4 physical input is active (see section 5.2.37).

### 3.3. Control switches

The six (6) control switches are color coded and labeled for easy identification.

#### 3.3.1. IDLE

The IDLE switch (red) forces the governor to **idle mode** (standby). Pressing and holding this button for one second while in rpm or pressure mode will cause the engine to ramp down to its idle position.

#### 3.3.2. MENU/SILENCE

The MENU/SILENCE switch (blue) is used to silence the alarm, cycle through the display items, and enter the setup menu.

#### 3.3.3. PRESET

The PRESET switch (orange) sets the governor to the configured preset engine RPM while in **throttle mode**, or preset pressure while in **pressure mode**.

#### 3.3.4. MODE

The MODE switch (green) sets the governor to either **throttle mode** (RPM) or **pressure mode** (PSI). The correct interlocks must be present for the system to begin governor operation: throttle ready for RPM mode, throttle ready, pump engaged, and okay to pump for PSI mode.

#### 3.3.5. INC

The INC [increase] switch (yellow) is used to increase the engine RPM or pressure set point.

#### 3.3.6. DEC

The DEC [decrease] switch (yellow) is used to decrease the engine RPM or pressure set point.

### 3.4. Mode indicator

The mode indicator consists of two (2) LEDs to show the governor's current operating mode. The PSI LED (yellow) indicates the governor is operating in **pressure mode** and the RPM LED (blue) indicates the governor is operating in **throttle mode**. When both LEDs are OFF the governor is in **idle mode** (standby).



 607 NW 27th Ave Ocala, FL 34475 Ph: 352-629-5020 or 1-800-533-3569 Fax: 352-629-2902 or 1-800-520-3473	<b>TECHNICAL DATA SHEET</b>			<b>PAGE</b>	<b>8 OF 34</b>	
	<b>PRODUCT GROUP</b>	THROTTLE CONTROL	<b>P/N</b>	117155	<b>DATE</b>	8/28/2017
	<b>PRODUCT</b>	<b>TOTAL PRESSURE GOVERNOR (TPG)</b>			<b>REV</b>	2.03
					<b>BY</b>	<b>AMS/GMC</b>

### 3.5. Battery voltage monitor

The battery voltage monitor is comprised of three (3) LEDs (green, yellow, and red). The active LED color indicates the current system voltage's range as measured by the power and ground inputs pins. The alarm will activate when the voltage monitor is in condition RED.



- GREEN 12.5VDC and higher
- YELLOW 12.4VDC to 11.9VDC
- RED 11.8VDC and lower

### 3.6. Coolant temperature monitor

The coolant temperature monitor is comprised of three (3) LEDs (green, yellow, and red). The active LED color indicates the status of the coolant temperature as reported by the J1939 network data messages (DM1). The coolant temperature status can also be set to react to user desired points (see section 5.2.22). The alarm will activate when the coolant temperature monitor is in condition RED.



- GREEN No active error reported by engine for coolant temperature
- YELLOW Coolant temperature high WARNING – SPN 110, FMI 16
- RED Coolant temperature high CRITICAL – SPN 110, FMI 0

### 3.7. Oil pressure monitor

The oil pressure monitor is comprised of three (3) LEDs (green, yellow, and red). The active LED color indicates the status of the oil pressure as reported by the J1939 network data messages (DM1). The oil pressure status can also be set to react to user desired points (see section 5.2.22). The alarm will activate when the oil monitor is in condition RED.



- GREEN No active error reported by engine for oil pressure
- YELLOW Oil pressure low WARNING – SPN 100, FMI 18
- RED Oil pressure low CRITICAL – SPN 100, FMI 1

 607 NW 27th Ave Ocala, FL 34475 Ph: 352-629-5020 or 1-800-533-3569 Fax: 352-629-2902 or 1-800-520-3473	<b>TECHNICAL DATA SHEET</b>			PAGE	9 OF 34	
	PRODUCT GROUP	THROTTLE CONTROL	P/N	117155	DATE	8/28/2017
	PRODUCT	TOTAL PRESSURE GOVERNOR (TPG)			REV	2.03
					BY	AMS/GMC

## 4. Operation

### 4.1. Initialization

The TPG has a five (5) second power initialization cycle and during this time the display will show:



The display shows “-Class 1 TPG-” for 1 second.



The display shows the software version number for 1 second.



The display shows “Initializing” for 3 seconds.



The TPG begins normal operation by displaying the engine RPM.

### 4.2. Operating mode selection

The TPG has two operating modes: **throttle mode** (RPM) and **pressure mode** (PSI).



Press the **MODE** switch to select an operating mode. An operating mode will only be activated if the required interlock(s) are in place (see section 4.3).

There is no variation in engine RPM or pump pressure when changing between **throttle mode** and **pressure mode**.



**Pressure mode is the desired operating mode because it offers protection from pressure changes that could injure personnel.**

### Attention Ford F-Series Customers

While pumping or operating in split shaft/PTO mode, do not press the accelerator pedal or brake pedal. If the accelerator pedal or brake pedal is pressed while in split shaft/PTO mode, the engine will return to curb idle and control of the remote throttle or governor will be lost. This will cause the pump to be reduced to idle and water pressure will be reduced.

**For complete details please reference service bulletin SB-143 at [www.haleproducts.com](http://www.haleproducts.com).**

#### 4.2.1. Throttle mode

**Throttle mode** (RPM) maintains a set engine RPM and will not deviate until the operator changes the RPM with the TPG’s control switches. (*Proper interlocking is required for normal operation – refer to Required Interlocking section 4.3*)

**Throttle mode** is typically used when...

- priming the pump
- the water supply pressure stability is questionable
- connected to a stand pipe
- acting as a relay pumper

 607 NW 27th Ave Ocala, FL 34475 Ph: 352-629-5020 or 1-800-533-3569 Fax: 352-629-2902 or 1-800-520-3473	<b>TECHNICAL DATA SHEET</b>			<b>PAGE</b>	<b>10 OF 34</b>	
	<b>PRODUCT GROUP</b>	THROTTLE CONTROL	<b>P/N</b>	117155	<b>DATE</b>	8/28/2017
	<b>PRODUCT</b>	<b>TOTAL PRESSURE GOVERNOR (TPG)</b>			<b>REV</b>	2.03
					<b>BY</b>	<b>AMS/GMC</b>



**MODE**

Press the **MODE** switch to select **throttle mode**. The display will momentarily show "GOV=THROTTLE" and the RPM mode indicator LED will illuminate blue.

**INC**

**DEC**

Press the **INC** switch to increase or the **DEC** switch to decrease the engine RPM set point.

**PRESET**

Press the **PRESET** switch to set the engine speed to the configured preset RPM - as long as the pump pressure is less than 10 PSI (see section 4.4). Configure the **throttle mode** preset through the Setup Menu (see section 5.2.1).

**IDLE**

Press the **IDLE** switch at any time to set the TPG back to standby. The display will momentarily show "IDLE" and both mode indicator LEDs will be off (see section 4.5).

#### 4.2.2. Pressure mode

**Pressure mode** (PSI) maintains a set pump pressure by monitoring the pressure transducer and modifying the pump speed by adjusting the engine RPM. The operator can modify the set pump pressure with the TPG's control switches. (*Proper interlocking is required for normal operation – refer to Required Interlocking section 4.3*)



**Pressure mode** (PSI) affords the most safety to the operator by not allowing potentially hazardous pressure spikes. The TPG will maintain the set pump pressure even when discharge lines are actively opened and closed as long as the water supply is sufficient. The TPG will automatically increase engine speed when pump pressure has decreased due to discharge lines being opened. The increase in engine speed will return the pump pressure to the desired set pressure (and vice-versa when discharge lines are closed).



**MODE**

Press the **MODE** switch to select **pressure mode**. The display will momentarily show "GOV=PRESSURE" and the PSI mode indicator LED will illuminate yellow. It may be necessary to press the **MODE** switch twice depending on the configured first mode (see section 5.2.5).

**INC**

**DEC**

Press the **INC** switch to increase or the **DEC** switch to decrease the pressure set point.

**PRESET**

Press the **PRESET** switch to set the pump pressure to the configured preset. The TPG will adjust the engine RPM to maintain the preset pressure value (see section 4.4). Configure the **pressure mode** preset through the Setup Menu (see section 5.2.4).

**IDLE**

Press the **IDLE** switch at any time to set the TPG back to standby. The display will momentarily show "IDLE" and both mode indicator LEDs will be off (see section 4.5).

There are four control properties which can be modified to improve **pressure mode** performance: pressure sensitivity, PSI time-out, PSI increase step, pressure lag, and PSI gain.

CONTROL PROPERTY	DESCRIPTION	DEFAULT	SECTION
------------------	-------------	---------	---------

 607 NW 27th Ave Ocala, FL 34475 Ph: 352-629-5020 or 1-800-533-3569 Fax : 352-629-2902 or 1-800-520-3473	<b>TECHNICAL DATA SHEET</b>			<b>PAGE</b>	<b>11 OF 34</b>	
	<b>PRODUCT GROUP</b>	THROTTLE CONTROL	<b>P/N</b>	117155	<b>DATE</b>	8/28/2017
	<b>PRODUCT</b>	<b>TOTAL PRESSURE GOVERNOR (TPG)</b>			<b>REV</b>	2.03
					<b>BY</b>	<b>AMS/GMC</b>

<b>Pressure sensitivity</b>	Controls how much difference between the set pressure and actual pressure that is allowed before the TPG actively adjusts the engine RPM to bring the pump pressure back to the set pressure.	6 PSI	5.2.9
<b>Pressure time-out</b>	When the pressure drops below 30 PSI for the number of seconds configured the engine RPM will be reduced to idle, the alarm will sound and the OPERATOR CMD warning will be shown in the display window (see section 4.7).	5 SEC	5.2.14
<b>Pressure Gain</b>	The pressure change requested with each <b>INC</b> or <b>DEC</b> switch press. (Note: Prior to Version 7.xx software default was 3 PSI)	5 PSI	5.2.14
<b>Pressure lag</b>	While the increase button is held, controls how much pressure change between the desired pressure and actual pressure can occur before the engine RPM is adjusted to maintain desired pressure.	5 PSI	5.2.29

 607 NW 27th Ave Ocala, FL 34475 Ph: 352-629-5020 or 1-800-533-3569 Fax: 352-629-2902 or 1-800-520-3473	<b>TECHNICAL DATA SHEET</b>			PAGE	12 OF 34	
	PRODUCT GROUP	THROTTLE CONTROL	P/N	117155	DATE	8/28/2017
	PRODUCT	TOTAL PRESSURE GOVERNOR (TPG)			REV	2.03
					BY	AMS/GMC

### 4.3. Required interlocking

The TPG requires interlocks before engine control operations are permitted. The TPG provides two interlock inputs that allow easy separation of pumping operations and throttle/high idle operations through two inputs dedicated as system interlocks: *THROTTLE READY* (pin 2 of the 12-pin Deutsch connector) and *PUMP ENGAGED* (pin 10 of the 12-pin Deutsch connector).

A third interlock input (pin 4 of the 12-pin Deutsch connector) may be configured to control OKAY TO PUMP (menu level 5, see section 5.2).

These interlock inputs are activated when system power is applied (positive polarity).



**The OEM is responsible for creating safe and effective interlocking routines.**

The TPG utilizes back lit text below the main display to indicate interlock status.

#### THROTTLE READY interlock



Apply system power to pin 2 of the 12-pin Deutsch connector (through OEM interlocking). THROTTLE READY text illuminates green.

The TPG will operate in **throttle mode** (RPM) only.

#### PUMP ENGAGED interlock



Apply system power to pin 10 of the 12-pin Deutsch connector (through OEM interlocking). PUMP ENGAGED text illuminates green.

The TPG will not operate in any mode until the THROTTLE READY interlock is applied.

#### OKAY TO PUMP



When THROTTLE READY and PUMP ENGAGED interlocks are applied the OKAY TO PUMP text illuminates green (default), unless the OKAY TO PUMP interlock has been configured to function with pin 4, then the OKAY TO PUMP text only illuminates when pin 4 of the 12-pin Deutsch connector has system power applied (through OEM interlocking).

The TPG will operate in **throttle mode** (RPM) or **pressure mode** (PSI).

### 4.4. PRESET switch operation



The **PRESET** switch brings the discharge pressure (or engine RPM, in throttle mode) to the configured preset point (see section 5.2.2 and 5.2.4).

Using the **PRESET** switch is a method of smoothly and expeditiously attaining water pressure and flow, but it is not intended to be the initial attack pressure. Attack pressures and flows should be determined by the actual fire status and manually achieved for best operation.

**PRESET** is an operational convenience and needs to be considered as a fixed point (higher or lower than the current point) that can be achieved with a single switch press.

*Note: Initiating pumping operations is simplified by bringing the pump to a preset pressure with a single switch press. Consequently, securing or regaining control operations can be aided by returning to this fixed pressure point with a single switch press.*

 607 NW 27th Ave Ocala, FL 34475 Ph: 352-629-5020 or 1-800-533-3569 Fax: 352-629-2902 or 1-800-520-3473	<b>TECHNICAL DATA SHEET</b>			<b>PAGE</b>	<b>13 OF 34</b>	
	<b>PRODUCT GROUP</b>	THROTTLE CONTROL	<b>P/N</b>	117155	<b>DATE</b>	8/28/2017
	<b>PRODUCT</b>	<b>TOTAL PRESSURE GOVERNOR (TPG)</b>			<b>REV</b>	2.03
					<b>BY</b>	<b>AMS/GMC</b>

#### 4.5. IDLE switch operation



Press and hold the **IDLE** switch for one second to release engine RPM control back to the engine ECU. The engine RPM will promptly go to its configured curb idle (see section 5.2.15).

*Note: In view of the fact that driveline stress can be induced by quick changes in engine speed, depending on rpm and torque load, the engine speed is ramped to idle over a short duration to minimize the effect of driveline kick.*

#### 4.6. MENU/SILENCE switch operation

The MENU/SILENCE switch allows viewing (within the info center display) of the status of engine and pump related items (section 4.6.1) and silencing of an active alarm (section 4.6.2).

##### 4.6.1. Viewing the engine and pump related items



Press the MENU/SILENCE switch to cycle through the engine and pump related display items (see below).

DISPLAY ITEM	FORMAT	SOURCE
<b>TPG alarm status (when active)</b>	ALARM XXX	Alarm status
<b>Pump Discharge Pressure</b>	PUMP XXX PSI	Current pump discharge pressure
<b>Battery voltage</b>	BAT XX.X Vdc	Input voltage at pins 1(+) and 12 (-) of the black 12-pin connector.
<b>Engine oil pressure</b>	OIL XX PSI	SAE J1939 CAN message – PGN 65263
<b>Engine coolant temperature</b>	COOLANT XXX°F	SAE J1939 CAN message – PGN 65262
<b>Engine oil temperature</b>	OIL TMP XXX°F	SAE J1939 CAN message – PGN 65262
<b>Transmission oil temperature</b>	TRANS XXX°F	SAE J1939 CAN message – PGN 65272
<b>Engine fuel rate</b>	FUEL X.X G/h	SAE J1939 CAN message – PGN 65266
<b>Pump hours</b>	PUMP XX.Xh	Internal timer based on pump engaged interlock
<b>Engine hours</b>	ENGINE XXXXh	SAE J1939 CAN message – PGN 65253

**Note: Not all above items may be displayed if the engine is not broadcasting the particular message on the J1939 CAN data bus.**

##### 4.6.2. Silencing the alarm

The active alarm can be silenced by pressing and holding the MENU/SILENCE switch for **one second**. The info center display will show **ALARM SIL=10** to indicate that the alarm has been silenced for the standard time of 10 minutes. **Continue** holding the MENU/SILENCE switch to increase the silenced time frame to 15 or 20 minutes.



Press and hold the MENU/SILENCE switch for **one second** to silence the alarm for the standard time (10 minutes).

**Continue** holding the MENU/SILENCE switch to increase the alarm silence time (15 or 20 minutes).

- *The alarm silenced time frame is reset to the standard 10 minutes once all alarm conditions have been cleared.*

 607 NW 27th Ave Ocala, FL 34475 Ph: 352-629-5020 or 1-800-533-3569 Fax : 352-629-2902 or 1-800-520-3473	<b>TECHNICAL DATA SHEET</b>			<b>PAGE</b>	<b>14 OF 34</b>	
	<b>PRODUCT GROUP</b>	THROTTLE CONTROL	<b>P/N</b>	117155	<b>DATE</b>	8/28/2017
	<b>PRODUCT</b>	<b>TOTAL PRESSURE GOVERNOR (TPG)</b>			<b>REV</b>	2.03
					<b>BY</b>	<b>AMS/GMC</b>

- The alarm will remain silenced for the selected time frame even if another alarm condition becomes active.

#### 4.7. Status and warning messages

The table below details the TPG's status and warning messages.

- These codes will flash on the display while the error/warning is active.
- Multiple errors/warnings may be sequenced on the display.
- Press and hold the **MENU/SILENCE** switch for one second to silence the active alarm.

ERROR CODE	DESCRIPTION
<b>SENSOR FAIL</b>	Signal voltage from pressure sensor is less than +0.30VDC or greater than +4.90VDC (Note: Used with software prior to version 7.xx)
<b>DIS TXDCR LO</b>	Signal voltage from pressure sensor is less than +0.30VDC (Note: Only available with software version 7.xx)
<b>DIS TXDCR HI</b>	Signal voltage from pressure sensor is greater than +4.90VDC (Note: Only available with software version 7.xx)
<b>LOW PRESSURE</b>	Pump pressure is less than 15 PSI during pressure mode operation
<b>OPERATOR CMD</b>	Pump pressure was greater than 50 PSI, but has dropped to below 30 PSI
<b>Δ RPM LIMIT</b>	Engine speed change of greater than 200 RPM does not yield increase in PSI
<b>WATER SUPPLY</b>	PSI decreased while RPM was increased (while in pressure mode)
<b>Δ PSI LIMIT</b>	PSI increased 50 PSI over set pressure point
<b>NO COMM DATA</b>	Not receiving CAN communication data from engine ECU
<b>CHECK ENGINE</b>	Received CHECK ENGINE warning from engine ECU via CAN message
<b>STOP ENGINE</b>	Received STOP ENGINE warning from engine ECU via CAN message
<b>OUTPUT FAIL</b>	Output signal voltage differs from expected (calculated) value (no longer displayed in version 3.2 and above)
<b>SELECT MODE?</b>	Increase or Decrease request when no active mode (PSI/RPM) selected
<b>SWITCH FAIL</b>	Switch panel reporting an improper switch combination
<b>THROT INTLK?</b>	Throttle ready interlock is not present when mode button is pressed
<b>POS ECU REF</b>	ECU Positive Reference missing from engine ECU. (Note: Only used in analog engine type and software version 7.08 and greater)
<b>NEG ECU REF</b>	ECU Negative Reference missing from engine ECU. (Note: Only used in analog engine type and software version 7.08 and greater)



 607 NW 27th Ave Ocala, FL 34475 Ph: 352-629-5020 or 1-800-533-3569 Fax: 352-629-2902 or 1-800-520-3473	<b>TECHNICAL DATA SHEET</b>			<b>PAGE</b>	<b>15 OF 34</b>	
	<b>PRODUCT GROUP</b>	THROTTLE CONTROL	<b>P/N</b>	117155	<b>DATE</b>	8/28/2017
	<b>PRODUCT</b>	<b>TOTAL PRESSURE GOVERNOR (TPG)</b>			<b>REV</b>	2.03
					<b>BY</b>	<b>AMS/GMC</b>

## 5. Governor Control Setup Menu

### 5.1. Engine compatibility

The factory default settings of the TPG make it “out of the box” ready to operate a Cummins engine programmed with the Emergency Vehicle Calibration. Typically, for the default configuration no values will require modification, other than changing the desired engine rpm, high-idle rpm and pump pressure preset values.

The governor is capable of controlling any engine that allows J1939 PGN0 (Torque Speed Control) messages from a unique source address. These engines include various Detroit Diesel DDEC engines, Mercedes Benz (MBE) engines, Volvo, and others. Programming of the source address or other parameters on the engine ECM may be required. The Scania engine allows control by proprietary J1939 messages and is supported by the TPG. In cases where an engine does not support data link control, the TPG can be configured to control the engine with an analog signal coupled to the engine remote PTO throttle input.

Contact Class 1 or visit our website ([www.class1.com](http://www.class1.com)) for a complete engine compatibility list.

### 5.2. Enter the setup menu

The setup menu allows access to the configuration and calibration screens. There are 5 set up menus available: *menu level 1 (basic setup menu), menu level 2, menu level 3, menu level 4 (factory menu), and menu level 5 (restricted)*. All configurations and calibrations are saved in non-volatile memory and will not be lost with power disruptions.

#### Standard menu level access

The standard menu level access method allows entry into menu levels 1, 2, or 3 only. Use the Direct menu level access method to enter menu level 4 or 5. Once a menu level has been selected, subsequent menu access will always enter that menu level and a system re-power is required to reset the first entry menu level.



Display shows **MENU 04 SECS** and begins counting down. Continue holding **IDLE** and **MENU** until the display shows **\*SETUP MENU\*** (4 seconds) and then release the switches. (If menu level 2 or menu level 3 is desired continue to hold the switches until the display shows the desired menu level then release).



Press the **MENU** switch to cycle through the available setup menu items.



Press the **INC** or **DEC** switches to modify the current menu item.



Press the **PRESET** switch to store the configured menu item. The display will show **---STORED---**.



Press the **MODE** switch to exit the setup menu. The display will show **--EXITMENU--** and then resume normal operation.

#### Direct menu level access



Enter a password while at idle to direct access a menu level.  
 INC, DEC, DEC, INC, DEC, DEC, DEC, INC = menulevel 1  
 INC, DEC, DEC, INC, DEC, DEC, INC, DEC = menulevel 2  
 INC, DEC, DEC, INC, DEC, DEC, INC, INC = menulevel 3  
 INC, DEC, DEC, INC, DEC, INC, DEC, DEC = menulevel 4 (factory)  
 INC, INC, DEC, INC, DEC, INC, DEC, INC = menulevel 5 (restricted)



 607 NW 27th Ave Ocala, FL 34475 Ph: 352-629-5020 or 1-800-533-3569 Fax: 352-629-2902 or 1-800-520-3473	<b>TECHNICAL DATA SHEET</b>			<b>PAGE</b>	<b>16 OF 34</b>	
	<b>PRODUCT GROUP</b>	THROTTLE CONTROL	<b>P/N</b>	117155	<b>DATE</b>	8/28/2017
	<b>PRODUCT</b>	<b>TOTAL PRESSURE GOVERNOR (TPG)</b>			<b>REV</b>	2.03
					<b>BY</b>	<b>AMS/GMC</b>

### Menu items in menu levels 1, 2, and 3

MENU ITEM	DESCRIPTION	DEFAULT	MENU LEVEL
<b>UNITS</b>	Configures units of measure	PSI / °F	1
<b>PRESET RPM</b>	Configures the throttle mode (RPM) preset (900 – 1400) <i>(Not available with message type ANLG)</i>	1000	1*
<b>HI-IDLE</b>	Configures the high idle RPM preset (900-1400) <i>(Not available with message type ANLG)</i>	1100	1*
<b>PRESET PSI</b>	Configures the pressure mode (PSI) preset (90 – 130)	90	1
<b>BRIGHT</b>	Configures the display's brightness level (1-15)	15	1
<b>DISPLAY TEST</b>	Tests all of the pixels of the main display	N/A	1
<b>ROUND PSI</b>	Configures the rounding of the pressure value	N	1
<b>ALERT TONE</b>	Alert tones are indicated by a double chirp of the alarm output and do not indicate alarm conditions. Enable/disable the alert tones.	Y	2
<b>SENSITIVITY</b>	Configures the pressure sensitivity window (4 – 12)	+/- 6 PSI	2
<b>-SENSOR CAL-</b>	Calibrates the zero point of the pressure sensor	142 COUNTS	2
<b>1ST MODE</b>	Configures the first mode active when the MODE switch is pressed (interlocks permitting)	PSI	2
<b>AUTO MODE</b>	Configures if governor automatically enters into psi mode upon pump engagement. <i>(Only available when 1<sup>st</sup> mode menu item is set to PSI and menu level was 3 or greater)</i>	NO	3*
<b>COMM STATUS</b>	Allows viewing of CAN messages per second and received errors <i>( Only available prior to software 7.xx.)</i>	N/A	2
<b>CONTROL</b>	Configure control mode and message for engine	CFPG (Cummins)	3
<b>IDLE RPM</b>	Configure / adjust the idle rpm <i>(Not available with message type ANLG if software prior to version 7.xx)</i>	700	3*
<b>MAXIMUM RPM</b>	Configure / adjust the maximum rpm commanded by governor <i>(Not available with message type ANLG or CFPG if software prior to version 7.xx)</i>	2200	3*
<b>SOURCE ID</b>	Configure the CAN source ID for the TPG <i>(only available with message type PGN0 or SCAN)</i>	7	3*
<b>TSC1 RAMP</b>	Configure the RPM ramp speed of TSC1/PGN0 control mode <i>(only available with message type PGN0)</i>	0	3*
<b>DISPLAY</b>	Configure primary display while in pressure mode (rpm or pressure) <i>(Was RPM prior to software version 7.xx)</i>	PSI	3
<b>PSI TIME-OUT</b>	Configures the amount of seconds the TPG will wait after pressure has dropped below 30 PSI before dropping to IDLE mode	5	3
<b>ALLOW PRESET</b>	Configure enable/disable rpm preset if pump is under pressure	NO	3
<b>WARNINGS</b>	Configures source of the panel warning LED's (data bus or user defined)	Bus	3
<b>WARN °F</b>	Configure the yellow (warning) engine temp setpoint <i>(only available when WARNINGS is set to Ustr)</i>	-	3*
<b>CRIT °F</b>	Configure the red (critical) engine temp setpoint <i>(only available when WARNINGS is set to Ustr)</i>	-	3*
<b>WARN PSI</b>	Configure the yellow (warning) oil pressure setpoint <i>(only available when WARNINGS is set to Ustr)</i>	-	3*

 607 NW 27th Ave Ocala, FL 34475 Ph: 352-629-5020 or 1-800-533-3569 Fax: 352-629-2902 or 1-800-520-3473	<b>TECHNICAL DATA SHEET</b>			<b>PAGE</b>	<b>17 OF 34</b>	
	<b>PRODUCT GROUP</b>	THROTTLE CONTROL	<b>P/N</b>	117155	<b>DATE</b>	8/28/2017
	<b>PRODUCT</b>	<b>TOTAL PRESSURE GOVERNOR (TPG)</b>			<b>REV</b>	2.03
					<b>BY</b>	<b>AMS/GMC</b>

MENU ITEM	DESCRIPTION	DEFAULT	MENU LEVEL
<b>CRIT PSI</b>	Configure the red (critical) oil pressure setpoint <i>(only available when WARNINGS is set to Usr)</i>	-	3*
<b>XDCR</b>	Configures transducer type (300 or 600 psi) (300 default)	300	3
<b>CanBAUD</b>	Allows CAN BAUD rate selection 125, 250, and 500 <i>( Only available on software 7.xx or greater.)</i> <i>Version 7.12 changed default to 500</i>	500	3
<b>FACTORY DFLT</b>	Returns all menu parameters to the factory default state (Cummins Control – message type CFPG)	N/A	3

\* Option dependent on other menu selections made

#### Menu items in menu level 4

MENU ITEM	DESCRIPTION	DEFAULT	MENU LEVEL
<b>POC ASSERT</b>	Configures when idle offset is asserted (with power on cycle or mode switch) <i>(Only available with message type ANLG)</i>	NO	4*
<b>GOV GAIN</b>	Configures the RPM change requested per INC or DEC switch press <i>(Only available with message type ANLG)</i>	15	4*
<b>PRESS GAIN</b>	Configures the pressure change requested per INC or DEC switch press <i>(Was 3 PSI prior to software version 7.xx)</i>	5 PSI	4
<b>DITHER</b>	Configure the engine handshake <i>(Only available with message type PGN0)</i>	NO	4*
<b>LAG (<math>\Delta</math>PSI)</b>	Controls the response of the pressure increase when the INC button is held while in pressure mode. <i>(Not available with message type ANLG)</i>	5 PSI	4*
<b>PUMP HOURS</b>	Set/reset the number of pump hours	N/A	4
<b>BCM1 VER</b>	Configures the Scania BCM version <i>(Only available with message type SCAN)</i>	1	4*
<b>SCANIA MODE</b>	Configures the Scania engine control type: NORMAL or STIFF <i>(Only available with message type SCAN)</i>	NORMAL	4*
<b>IDLE STEPS</b>	Configures the idle offset voltage for analog control mode <i>(Only available with message type ANLG)</i>	32	4*

\* Option dependent on other menu selections made

#### Menu items in menu level 5

MENU ITEM	DESCRIPTION	DEFAULT	MENU LEVEL
<b>OK2PUMP</b>	Configure the "okay to pump" interlock source	NORM	5
<b>SPN 3350</b>	Configure the PGN0 control purpose <i>(only available with message type PGN0)</i>	P32	5*
<b>SPN 696</b>	Configure the Engine Requested Speed Control Condition <i>(only available with message type PGN0)</i>	3	5*
<b>HIDLE MODE</b>	Configure the high idle mode	1	5
<b>BUS INTLKS</b>	Configure the bus interlocks	N	5
<b>VOLTS</b>	Calibrate the battery voltage display (+0.0 to +0.5 volts)	+0.0 volts	5

 607 NW 27th Ave Ocala, FL 34475 Ph: 352-629-5020 or 1-800-533-3569 Fax : 352-629-2902 or 1-800-520-3473	<b>TECHNICAL DATA SHEET</b>			<b>PAGE</b>	<b>18 OF 34</b>	
	<b>PRODUCT GROUP</b>	THROTTLE CONTROL	<b>P/N</b>	117155	<b>DATE</b>	8/28/2017
	<b>PRODUCT</b>	<b>TOTAL PRESSURE GOVERNOR (TPG)</b>			<b>REV</b>	2.03
					<b>BY</b>	<b>AMS/GMC</b>

<b>TSC1 MODE</b>	Set Special TSC1 control modes <i>(only available with message type PGN0)</i>	NORMAL	5
<b>SMOOTHING</b>	Configure pressure averaging (smoothing – NO, LO, HI) <i>(Was LO prior to software version 7.xx)</i>	NO	5
<b>ENGINE ID</b>	Configure the CAN source ID where the TPG receives its engine information from. Normally this will always be address 0 unless some kind of interface module is used between the engine and TPG	0	5
<b>DIR PRESET</b>	Configures if Governor automatically enter Presets if the interlock are made on startup. If the interlocks are active and no mode is selected and the option is turned on. Pressing the preset button will force the unit to go to the RPM or PSI preset without selecting a mode.	N	5
<b>PSET MIN</b>	Min PSI limit that the Governor needs to see before PSI Preset will operate.	25	5
<b>NUDGE LIMIT</b>	RPM Limit that the engine can drift before the Governor will adjust the RPM back to the target RPM. <i>(Only available with message type CFPG and software version 7.xx)</i>	15	5

\* Option dependent on other menu selections made

 607 NW 27th Ave Ocala, FL 34475 Ph: 352-629-5020 or 1-800-533-3569 Fax: 352-629-2902 or 1-800-520-3473	<b>TECHNICAL DATA SHEET</b>			<b>PAGE</b>	<b>19 OF 34</b>	
	<b>PRODUCT GROUP</b>	THROTTLE CONTROL	<b>P/N</b>	117155	<b>DATE</b>	8/28/2017
	<b>PRODUCT</b>	<b>TOTAL PRESSURE GOVERNOR (TPG)</b>			<b>REV</b>	2.03
					<b>BY</b>	<b>AMS/GMC</b>

### 5.2.1. UNITS (unit of measure configuration)

This menu item allows configuration of the display units of measure. Use the INC and DEC keys to select the desired units of measure. The options include PSI/°F, kPa/°C, bar/°C.

*Range = PSI / °F, kPa / °C, bar / °C* *[default = PSI / °F]*

### 5.2.2. PRESET RPM (throttle preset configuration)

This menu item allows configuration of the throttle mode preset. The display will show **PSETrpm XXXX**. Use the **INC** and **DEC** switches to adjust the RPM value desired for the throttle mode preset.

*Range = 900 RPM to 1400 RPM (in 25 RPM steps).* *[default = 1000 RPM]*

### 5.2.3. HI-IDLE (high idle configuration)

This menu item allows configuration of the high idle (fast idle) setpoint. The display will show **Hi-Idle= XXX**. Use the **INC** and **DEC** switches to adjust the RPM value desired for the high idle setpoint.

*Range = 900 RPM to 1400 RPM (in 10 RPM steps).* *[default = 1100 RPM]*

### 5.2.4. PRESET PSI (pressure preset configuration)

This menu item allows configuration of the pressure mode preset. The display will show **PSETpsi XXX**. Use the **INC** and **DEC** switches to adjust the PSI value desired for the pressure mode preset.

*Range = 90 PSI to 130 PSI (in 5 PSI steps)* *[default = 90 PSI]*

### 5.2.5. BRIGHT (display brightness)

This menu item allows configuration the display's brightness level. The display will show **BRIGHTNESS=X**. Use the **INC** and **DEC** switches to adjust the value desired display brightness.

*Range = 1 to 15 (1 is dimmest setting)* *[default = 15]*

### 5.2.6. DISPLAY TEST

This menu item allows testing of all of the pixels of the main display and all of the LEDs. The display will show **DISPLAY TEST**. Use the **INC** or **DEC** switch to turn on all of the LEDs and pixels in the display.

### 5.2.7. ROUND PSI (configure rounding of the pressure value)

This menu item allows enabling/disabling of the "round to nearest 5" of the pressure value. The display will show **ROUND PSI: X**. Use the **INC** and **DEC** switches to select **Y** (yes) or **N** (no).

*Round PSI = Y (round to nearest 5) or N (don't round).* *[default = N]*

### 5.2.8. ALERT TONE (configure alert tones)

This menu item allows enabling/disabling of the alert tones. The alert tones are sounded through the external alarm output (pin 3 of the 6-pin connector). The display will show **ALERT TONE:X**. Use the **INC** and **DEC** switches to select **Y** (yes, enabled) or **N** (no, disabled).

*Range = Y (Alert tones ON) or N (Alert tones OFF).* *[default = Y]*

 607 NW 27th Ave Ocala, FL 34475 Ph: 352-629-5020 or 1-800-533-3569 Fax: 352-629-2902 or 1-800-520-3473	<b>TECHNICAL DATA SHEET</b>			<b>PAGE</b>	<b>20 OF 34</b>	
	<b>PRODUCT GROUP</b>	THROTTLE CONTROL	<b>P/N</b>	117155	<b>DATE</b>	8/28/2017
	<b>PRODUCT</b>	<b>TOTAL PRESSURE GOVERNOR (TPG)</b>			<b>REV</b>	2.03
					<b>BY</b>	<b>AMS/GMC</b>

### 5.2.9. **SENSITIVITY (pressure sensitivity configuration)**

This menu item allows configuration of the pressure mode sensitivity window. This window dictates how much pressure difference must occur before the TPG adjusts the engine RPM to maintain the desired set pressure. The display will show **GOV± XX PSI**. Use the **INC** and **DEC** switches to adjust the PSI value desired for the pressure mode sensitivity.

*Range = 4 PSI to 12 PSI (in 1 PSI steps). [default = 6 PSI]*

### 5.2.10. **SENSOR CAL (pressure sensor calibration)**

This menu item allows calibration of the pressure sensor. The display will show **-SENSOR CAL-**. See section 7.3 for the calibration procedure.

### 5.2.11. **1<sup>st</sup> MODE (first active mode configuration)**

This menu item allows configuration of the governor mode active when the **MODE** switch is first pressed. The display will show **1<sup>st</sup> MODE=XXX**. Use the **INC** and **DEC** switches to select the desired mode (PSI or RPM). Proper interlocks must be established for the configured 1<sup>st</sup> mode to become active during operation.

*Range = RPM (throttle mode) or PSI (pressure mode). [default = PSI]*

### 5.2.12. **AUTO MODE (pressure mode automatically entered on pump engagement)**

This menu item allows configuration of automatically entering pressure mode when pump engagement occurs (**AUTO MODE?:Y**). Note that this option will only be available if the 1<sup>st</sup> mode parameter (section 5.2.11) is set to pressure mode (PSI). When this parameter is enabled, the governor will be put in pressure mode when the pump is changed from a disengaged to an engaged position (interlocks permitting). Thereafter, when a user selects the IDLE (standby) mode, the governor will remain in standby mode until a new mode is selected.

*Range = Y1 (Automode ON, Throttle Ready first then Pump Engaged),  
 Y2 (Automode ON, Pump Engaged first then Throttle Ready),  
 Y3 (Automode ON, OK to PUMP (note if only selectable if OK to Pump Interlock is set to PIN 4),  
 N (Automode OFF). [default = N]*

### 5.2.13. **COMM STATUS (view the CAN communication status)**

This menu item allows viewing of the number of CAN messages per second and received errors. This menu item is only available when the CAN message type is set to CFPG.

The display will show **COMM STATUS**. Use the **INC** and **DEC** switches to toggle between message per second and received errors (NOTE: Only available prior to software version 7.xx).

### 5.2.14. **CONTROL (engine control message type)**

This menu item allows configuration of the CAN or ANALOG control message type.

CFPG – Cummins **F**ire **P**ressure **G**overnor, uses Cummins proprietary control message to control engine speed.

MERC – Uses Mercedes control commands for PSM module equipped vehicles.

PGN0 – Uses J1939, PGN0 – Torque Speed Control message to control engine speed.

SCAN – SCANia, uses the Scania bodywork control message 1.

ANLG – Uses analog voltage signal to control remote throttle input on engine.

PWM – Uses pulse width modulation control signal (12-85%, 400 Hz).

VLVO – Uses Volvo specific PTO control commands for Volvo FE/FL series engines running through a Volvo bodybuilder control module. This method should not be used when the TPG is directly connected to the engine CAN bus. Volvo FM/FH series engines should use the standard PGN0 control mode and set the Engine ID variable to the address of the body builder module.

The display will show **CONTROL=XXXX**. Use the **INC** and **DEC** switches to adjust the control message type.

*Range = CFPG, MERC, PGN0, SCAN, ANLG, PWM, VLVO [default = CFPG]*

 607 NW 27th Ave Ocala, FL 34475 Ph: 352-629-5020 or 1-800-533-3569 Fax: 352-629-2902 or 1-800-520-3473	<b>TECHNICAL DATA SHEET</b>			<b>PAGE</b>	<b>21 OF 34</b>	
	<b>PRODUCT GROUP</b>	THROTTLE CONTROL	<b>P/N</b>	117155	<b>DATE</b>	8/28/2017
	<b>PRODUCT</b>	<b>TOTAL PRESSURE GOVERNOR (TPG)</b>			<b>REV</b>	2.03
					<b>BY</b>	<b>AMS/GMC</b>

### 5.2.15. RPMidle (idle RPM value)

This menu item allows configuration of the idle RPM.

The display will show **RPMidle=XXXX**. Use the **INC** and **DEC** switches to adjust the RPM value desired for idle.

*Note: cannot be adjusted below the engine's curb idle speed.*

*Range = 600 RPM to 1000 RPM (in 5 RPM steps). [default = 700 RPM]*

### 5.2.16. RPMmaxi (maximum RPM value)

This menu item allows configuration of the maximum RPM that will be commanded when in PGN0 or SCANia mode. The display will show **RPMmaxi=XXXX**. Use the **INC** and **DEC** switches to adjust the maximum RPM value desired. *This value cannot be adjusted above maximum governed speed.*

*Note: When control type is configured for Volvo (VLVO) or MAN the minimum value can be set down to 1500 RPM.*

*Range = 1900 RPM to 2500 RPM (in 25 RPM steps). [default = 2200 RPM]*

*Software Version 7.xx Range 1400 RPM to 2500 RPM [default = 2200 RPM]*

*Software Version 7.12 Range 1400 RPM to 3500 RPM [default = 2200 RPM]*

### 5.2.17. SourceID (CAN message source identification)

This menu item allows configuration of the CAN source message ID number.

The display will show **SourceID=X**. Use the **INC** and **DEC** switches to adjust the CAN source message ID.

*Range = 0 – 255. [default = 7]*

### 5.2.18. TSC1 RAMP (TSC1/PGN0 control mode RPM ramp speed)

This menu item allows configuration of the engine RPM ramp speed in TSC1/PGN0 control mode.

The display will show **TSC1 RAMP: X**. Use the **INC** and **DEC** switches to adjust the ramp speed.

*Range = 0 – 40. [default = 0]*

### 5.2.19. DISPLAY (primary display in pressure mode)

This menu item allow configuration of the display data while operating in pressure mode. The display can show either engine speed (**DISPLAY: RPM**), or pump pressure (**DISPLAY: PSI**). The pump pressure will be displayed in the correct units of measure (psi, kPa, or bar) selected by the user.

*Note: The pressure display cannot be used as the master pressure gauge per NFPA 1901.*

*Range = RPM or PSI. [default = RPM]*

### 5.2.20. PSI TIME-OUT (pressure time out)

This menu item allows configuration of the low pressure time out. When the TPG is governing in pressure mode and the pressure falls below 30 PSI the TPG will wait the configured number of seconds to allow the pressure to rise before dropping to IDLE.

The display will show **PSI TIME-OUT**. Use the **INC** and **DEC** switches to adjust the value desired for the pressure time out.

*Range = 3 seconds to 10 seconds (in 1 second steps). [default = 5 seconds]*

 607 NW 27th Ave Ocala, FL 34475 Ph: 352-629-5020 or 1-800-533-3569 Fax : 352-629-2902 or 1-800-520-3473	<b>TECHNICAL DATA SHEET</b>			<b>PAGE</b>	<b>22 OF 34</b>	
	<b>PRODUCT GROUP</b>	THROTTLE CONTROL	<b>P/N</b>	117155	<b>DATE</b>	8/28/2017
	<b>PRODUCT</b>	<b>TOTAL PRESSURE GOVERNOR (TPG)</b>			<b>REV</b>	2.03
					<b>BY</b>	<b>AMS/GMC</b>

**5.2.21. ALLOW PRESET (allow RPM preset use when pressure is detected)**

This menu item allows enabling/disabling of throttle mode preset usage when pump pressure over 10 PSI is detected.

The display will show **PRESET RPM=X**. Use the **INC** and **DEC** switches to select **Y** (yes, enabled) or **N** (no, disabled).

*Range = Y (enabled) or N (disabled).*

*[default = N]*

 607 NW 27th Ave Ocala, FL 34475 Ph: 352-629-5020 or 1-800-533-3569 Fax: 352-629-2902 or 1-800-520-3473	<b>TECHNICAL DATA SHEET</b>			<b>PAGE</b>	<b>23 OF 34</b>	
	<b>PRODUCT GROUP</b>	THROTTLE CONTROL	<b>P/N</b>	117155	<b>DATE</b>	8/28/2017
	<b>PRODUCT</b>	<b>TOTAL PRESSURE GOVERNOR (TPG)</b>			<b>REV</b>	2.03
					<b>BY</b>	<b>AMS/GMC</b>

### 5.2.22. **WARNINGS (data monitor warning configuration)**

This menu item allows configuration of the source for engine warnings. Warnings can be determined by engine diagnostic messages (DM1 messages) over the data bus (**Bus**), or at setpoints defined by the user based on J1939 oil pressure and engine temperature data (**Usr**).

The preferred and most accurate method is to use **Bus** warnings from the engine diagnostic system. Note that not all engines support this feature, contact Class1 customer support for more information.

*Range = Bus (bus controlled) or Usr (user configured). [default = Bus]*

When the **Usr** configuration is selected the following setpoints will be assigned next.

**A. WARN °F (USER DEFINED ENGINE TEMPERATURE HIGH WARNING - YELLOW LED)**

**B. CRIT °F (USER DEFINED ENGINE TEMPERATURE HIGH CRITICAL - RED LED)**

**C. WARN PSI (USER DEFINED OIL PRESSURE LOW WARNING - YELLOW LED)**

**D. CRIT PSI (USER DEFINED OIL PRESSURE LOW CRITICAL - RED LED)**

### 5.2.23. **XDUCR (discharge pressure transducer range)**

This menu item allows configuration the discharge pressure transducer's range (0 to 300 PSI, or 0 to 600 PSI).

The display will show **XDCR= XXXPSI**. Use the **INC** and **DEC** switches to adjust the value desired for the pressure change per button press.

*Range = 300 PSI or 600 PSI. [default = 300 PSI]*

### 5.2.24. **FACTORY DFLT (Set factory defaults)**

This menu item allows setting the TPG back to the factory defaults.

The display will show **FACTORY DFLT**. Press the **PRESET** switch to load the defaults.

*Refer to the menu level tables for the default values (section 5.2).*

### 5.2.25. **POC ASSERT (Power On Cycle assertion)**

This menu item allows enabling/disabling of the analog control signal idle voltage assertion at power-up. When the POC ASSERT is enabled the analog control signal will be set to the configured idle voltage at the start of the TPG's power cycle. If the POC ASSERT is disabled the analog control signal will be set to the minimum configured level at the start of the TPG's power cycle.

The display will show **POC ASSERT:X**. Use the **INC** and **DEC** switches to select **Y** or **N**.

*Range = Y (enabled) or N (disabled). [default = N]*

### 5.2.26. **GOV GAIN (RPM change per step)**

This menu item allows configuration of the RPM change per step. A larger number changes the RPM more with each **INC** or **DEC** switch press.

The display will show **GOV GAIN :XX**. Use the **INC** and **DEC** switches to adjust the value.

*Range = 0 to 35 [default = 15]*

### 5.2.27. **PRESS GAIN (PSI change per step)**

This menu item allows configuration of the psi change per step. A larger number changes the PSI more with each **INC** or **DEC** switch press.

The display will show **X PSI/STEP**. Use the **INC** and **DEC** switches to adjust the value.

*Range = 1 to 5 [default = 3 PSI/STEP]*

*Software version 7.xx Range = 1 to 5 [default = 5 PSI/STEP]*



 607 NW 27th Ave Ocala, FL 34475 Ph: 352-629-5020 or 1-800-533-3569 Fax : 352-629-2902 or 1-800-520-3473	<b>TECHNICAL DATA SHEET</b>			<b>PAGE</b>	<b>24 OF 34</b>	
	<b>PRODUCT GROUP</b>	THROTTLE CONTROL	<b>P/N</b>	117155	<b>DATE</b>	8/28/2017
	<b>PRODUCT</b>	<b>TOTAL PRESSURE GOVERNOR (TPG)</b>			<b>REV</b>	2.03
					<b>BY</b>	<b>AMS/GMC</b>

### 5.2.28. DITHER (Engine handshake)

This menu item allows enabling/disabling of engine handshake. When enabled, the TPG will vary the engine speed +/- 5 RPM around the desired engine speed. Some engines may require consistent RPM modification in order to maintain remote RPM control.

The display will show **DITHER=XX**. Use the **INC** and **DEC** switches to select **ON** or **OFF**.

*Range = ON (enabled) or OFF (disabled). [default = OFF]*

### 5.2.29. LAG ΔPSI (Pressure lag)

This menu item allows configuration of the pressure lag which defines the maximum allowable difference that the actual pressure is behind the commanded set-point before a “wait” (catch up) state is introduced while operating in pressure mode.

The display will show **LAG (ΔPSI)=X**. Use the **INC** and **DEC** switches to adjust the pressure lag value.

*Range = 1 PSI to 20 PSI (in 1 PSI steps). [default = 5 PSI]*

### 5.2.30. PUMP HOURS

This menu item allows setting/resetting of the total pump hours.

The display will show **PUMP X.Xh**. Use the **INC** and **DEC** switches to adjust the pump hours.

*Range = 0.0 to 999.9 hours (in 0.1 hour steps). [default = 0]*

### 5.2.31. BCM1 VER (Body Control Message 1 version)

This menu item allows configuration of the message configuration version transmitted in the Scania Body Control Message 1.

The display will show **BCM1 VER: X**. Use the **INC** and **DEC** switches to adjust the value.

*Range = 0 to 255. [default = 1]*

### 5.2.32. SCANIA MODE? (Scania governor type) (Prior to software version 7.xx)

This menu item allows configuration of the Scania requested governor type in the Body Control Message 1.

The display will show **MODE: XXXXXX**. Use the **INC** and **DEC** switches to adjust the value.

*Range = NORMAL or STIFF. [default = NORMAL]*

### 5.2.33. SCANIA MODE? (Scania governor type) (Available software version 7.xx)

This menu item allows configuration of the Scania requested governor type.

The display will show **MODE: XXXXXX**. Use the **INC** and **DEC** switches to adjust the value.

*Range = SCANIA-1(BCM) or SCANIA-2 or SCANIA-3 (BCI). [default = SCANIA-1]*

### 5.2.34. SCANIA CONTROL TYPE? (Scania governor type) (Available software version 7.xx)

This menu item allows configuration of the Scania requested governor type Body Control Message 1.

The display will show **MODE: XXXXXX**. Use the **INC** and **DEC** switches to adjust the value.

*Range = NORMAL or STIFF. [default = NORMAL]*

### 5.2.35. VOLVO CONTROL MODE? (Volvo governor type) (Available software version 7.xx)

This menu item allows configuration of the Volvo requested governor type.

The display will show **XX/XX**. Use the **INC** and **DEC** switches to adjust the value.

*Range = FE/FL or FH/FM. [default = FE/FL]*

 607 NW 27th Ave Ocala, FL 34475 Ph: 352-629-5020 or 1-800-533-3569 Fax : 352-629-2902 or 1-800-520-3473	<b>TECHNICAL DATA SHEET</b>			<b>PAGE</b>	<b>25 OF 34</b>	
	<b>PRODUCT GROUP</b>	THROTTLE CONTROL	<b>P/N</b>	117155	<b>DATE</b>	8/28/2017
	<b>PRODUCT</b>	<b>TOTAL PRESSURE GOVERNOR (TPG)</b>			<b>REV</b>	2.03
					<b>BY</b>	<b>AMS/GMC</b>

### 5.2.36. IDLE STEPS (Analog control idle)

This menu item allows the configuration of the analog control signal idle voltage.  
 The display will show **IdleSteps:XX**. Use the **INC** and **DEC** switches to adjust the value.

*Range = 0 to 60*

*[default = 32]*

### 5.2.37. OKAY2PUMP (Okay to pump interlock source)

This menu item allows the configuration of the “okay to pump” interlock source.

**NORM** – The OKAY TO PUMP text only illuminates when the **throttle ready** and **pump engaged** interlocks are active.

**PIN4** – The OKAY TO PUMP text only illuminates when pin 4 of the 12-pin Deutsch connector has power applied.

The display will show **OK2PUMP=X**. Use the **INC** and **DEC** switches to adjust the value.

*Range = NORM or PIN4*

*[default = NORM]*

*Note: Software version 7.xx if power is applied to the pin it will automatically configure and save to allow PKAY TO PUMP to work with PIN4.*

 607 NW 27th Ave Ocala, FL 34475 Ph: 352-629-5020 or 1-800-533-3569 Fax: 352-629-2902 or 1-800-520-3473	<b>TECHNICAL DATA SHEET</b>			<b>PAGE</b>	<b>26 OF 34</b>	
	<b>PRODUCT GROUP</b>	THROTTLE CONTROL	<b>P/N</b>	117155	<b>DATE</b>	8/28/2017
	<b>PRODUCT</b>	<b>TOTAL PRESSURE GOVERNOR (TPG)</b>			<b>REV</b>	2.03
					<b>BY</b>	<b>AMS/GMC</b>

### 5.2.38. SPN 3350 (TSC1 – SPN 3350)

This menu item allows configuration of the Torque Speed Control 1 (TSC1) control purpose message.

P03 – PTO governor control purpose.

P32 – Temporary power-train control purpose.

The display will show **SPN 3350:XXX**. Use the **INC** and **DEC** switches to adjust the CAN purpose.

*Range = P03 or P32.*

*[default = P32]*

### 5.2.39. SPN 696 (Engine Requested Speed Control Condition)

This menu item allows configuration of the CAN Engine Requested Speed Control Condition (SPN 696), as defined in SAE J1939 for the TSC1/PGN0 speed control command. Possible values are:

0 – Transient optimized for driveline disengaged and non-lockup conditions.

1 – Stability optimized for driveline disengaged and non-lockup conditions.

2 – Stability optimized for driveline engaged and/or and in lockup condition 1 (e.g. vehicle driveline).

3 – Stability optimized for driveline engaged and/or and in lockup condition 2 (e.g. PTO driveline).

The display will show **SPN 696:X**. Use the **INC** and **DEC** switches to adjust the Engine Requested Speed Control Condition.

*Range = 0 to 3.*

*[default = 3]*

### 5.2.40. TSC1 MODE? (Available software version 7.xx)

This menu item allows configuration of the TSC1 engine types.

The display will show **MODE: XXXXXX**. Use the **INC** and **DEC** switches to adjust the value.

NORMAL\_Engine = standard TSC1, no transmit at IDLE or without throttle ready interlock.

NORMAL\_Engine\_2 = standard TSC1, but transmits at idle without throttle ready interlock.

FAW\_Engine = special TSC1, transmits at idle without throttle ready interlock, always "speed control".

FAW\_Engine\_2 = special TSC1, transmits at idle without throttle ready interlock, standard "override disabled" and "speed control".

MAN\_Engine = special TSC1, no transmit at IDLE or without throttle ready interlock.

MAN\_Engine\_2 = special TSC1, but transmits at idle without throttle ready interlock.

*[default = NORMAL]*

### 5.2.41. HI IDLE MODE

This menu item allows configuration of the high idle mode.

1 – Normal.

2 – Only allow high idle if engine speed > 600 RPM, transmission is in neutral, and okay to pump interlock is OFF.

Forces the **throttle ready interlock** OFF when transmission is NOT in neutral or 4<sup>th</sup> gear.

The display will show **HIDLE MODE:X**. Use the **INC** and **DEC** switches to adjust the value.

*Range = 1 or 2.*

*[default = 1]*

### 5.2.42. BUS INTLKS (Bus message control of throttle ready interlock)

This menu item allows configuration of the bus interlocks.

N – Normal, **throttle ready interlock** ON with its physical input pin.

Y – Forces **throttle ready interlock** ON when transmission is in Neutral.

The display will show **BUS INTLKS:X**. Use the **INC** and **DEC** switches to adjust the value.

*Range = Y or N.*

*[default = N]*

 607 NW 27th Ave Ocala, FL 34475 Ph: 352-629-5020 or 1-800-533-3569 Fax : 352-629-2902 or 1-800-520-3473	<b>TECHNICAL DATA SHEET</b>			<b>PAGE</b>	<b>27 OF 34</b>	
	<b>PRODUCT GROUP</b>	THROTTLE CONTROL	<b>P/N</b>	117155	<b>DATE</b>	8/28/2017
	<b>PRODUCT</b>	<b>TOTAL PRESSURE GOVERNOR (TPG)</b>			<b>REV</b>	2.03
					<b>BY</b>	<b>AMS/GMC</b>

#### 5.2.43. VOLTS (Voltage display calibration)

This menu item allows calibration of the voltage display.

The display will show **VOLTS XX.X V**. Use the **INC** and **DEC** switches to adjust the voltage level.

*Range = voltage + 0.0 to voltage + 0.5* *[default = 0]*

#### 5.2.44. SMOOTHING (Pressure display averaging)

This menu item allows configuration of the smoothing (averaging) method of the pressure display.

NO – No averaging of pressure.

LO – Average of 4 pressure samples while within pressure stasis window.

HI – Average of 8 pressure samples while within pressure stasis window.

The display will show **SMOOTHING:XX**. Use the **INC** and **DEC** switches to adjust the value.

*Range = NO, LO, or HI* *[default = LO]*

*Range = NO, LO, or HI Software version 7.xx* *[default = NO]*

#### 5.2.45. ENGINE ID (Source ID of received engine messages)

This menu item allows configuration of the CAN source ID for engine messages received by the TPG.

The display will show **EngineID=X**. Use the **INC** and **DEC** switches to adjust the CAN engine source ID.

If the TPG continuously displays the NO COMM DATA message with the engine running and the CAN bus connected verify the setting of this parameter. Where the TPG is directly connected to the engine's CAN bus the address should usually be 0 but if there is a gateway module between the engine and TPG then this parameter needs to be set to the address from which the gateway module transmits.

*Range = 0 – 255.* *[default = 0]*

 607 NW 27th Ave Ocala, FL 34475 Ph: 352-629-5020 or 1-800-533-3569 Fax: 352-629-2902 or 1-800-520-3473	<b>TECHNICAL DATA SHEET</b>			<b>PAGE</b>	<b>28 OF 34</b>	
	<b>PRODUCT GROUP</b>	THROTTLE CONTROL	<b>P/N</b>	117155	<b>DATE</b>	8/28/2017
	<b>PRODUCT</b>	<b>TOTAL PRESSURE GOVERNOR (TPG)</b>			<b>REV</b>	2.03
					<b>BY</b>	<b>AMS/GMC</b>

## 6. Special Function Passwords (See section 5.2 for procedure on entering passwords)

### 6.1. Setting control message transmission requirements

#### **DEC, INC, INC, INC, DEC, DEC, DEC, DEC**

Engine control message is not transmitted when at idle (no mode selected) - displays message "NOTX AT IDLE" after password is entered. This can be useful if there is more than one device on a vehicle which is controlling the RPM externally over the CAN bus.

#### **DEC, INC, INC, INC, DEC, DEC, DEC, INC**

Engine control message is transmitted whenever the throttle interlock is active - displays message "TX AT IDLE" after password is entered. This was the standard operation for TPG version 3.2 and below and is the default on newer versions.

### 6.2. Setting control for specific engine types

#### **DEC, INC, DEC, INC, DEC, DEC, DEC, DEC**

NORMAL\_Engine = standard TSC1, no transmit at IDLE or without throttle ready interlock.  
 (Note: Only available prior to software version 7.xx. Has been moved to menu when selecting engine type)

#### **DEC, INC, DEC, INC, DEC, DEC, DEC, INC**

NORMAL\_Engine\_2 = standard TSC1, but transmits at idle without throttle ready interlock.  
 (Note: Only available prior to software version 7.xx. Has been moved to menu when selecting engine type)

#### **DEC, INC, DEC, INC, DEC, DEC, INC, DEC**

FAW\_Engine = special TSC1, transmits at idle without throttle ready interlock, always "speed control".  
 (Note: Only available prior to software version 7.xx. Has been moved to menu when selecting engine type)

#### **DEC, INC, DEC, INC, DEC, DEC, INC, INC**

FAW\_Engine\_2 = special TSC1, transmits at idle without throttle ready interlock, standard "override disabled" and "speed control".  
 (Note: Only available prior to software version 7.xx. Has been moved to menu when selecting engine type)

#### **DEC, INC, DEC, INC, DEC, INC, DEC, DEC**

MAN\_Engine = special TSC1, no transmit at IDLE or without throttle ready interlock.  
 (Note: Only available prior to software version 7.xx. Has been moved to menu when selecting engine type)

#### **DEC, INC, DEC, INC, DEC, INC, DEC, INC**

MAN\_Engine\_2 = special TSC1, but transmits at idle without throttle ready interlock.  
 (Note: Only available prior to software version 7.xx. Has been moved to menu when selecting engine type)

### 6.3. Configuring transmission of Hydraulic Pressure Governor message

#### **DEC, INC, INC, DEC, DEC, DEC, DEC, DEC**

Transmit HPG message (default) - displays message "HPG = ON" after password is entered.

#### **DEC, INC, INC, DEC, DEC, DEC, DEC, INC**

Don't transmit HPG message - displays message "HPG = OFF" after password is entered.

#### **DEC, INC, INC, DEC, INC, DEC, DEC, DEC**

HPG message transmits mode normally - displays message "HPG MODE = NOR" after password is entered.

#### **DEC, INC, INC, DEC, INC, DEC, DEC, INC**

HPG message transmits PSI mode always - displays message "HPG MODE = PSI" after password is entered.

 607 NW 27th Ave Ocala, FL 34475 Ph: 352-629-5020 or 1-800-533-3569 Fax : 352-629-2902 or 1-800-520-3473	<b>TECHNICAL DATA SHEET</b>			<b>PAGE</b>	<b>29 OF 34</b>	
	<b>PRODUCT GROUP</b>	THROTTLE CONTROL	<b>P/N</b>	117155	<b>DATE</b>	8/28/2017
	<b>PRODUCT</b>	<b>TOTAL PRESSURE GOVERNOR (TPG)</b>			<b>REV</b>	2.03
					<b>BY</b>	<b>AMS/GMC</b>

**DEC, INC, INC, INC, DEC, INC, DEC, DEC**

Reset Factory Defaults (Only available software version 7.xx).

**DEC, INC, INC, INC, DEC, INC, INC, DEC**

Reset Auto BAUD Rate Detection (Only available software version 7.xx).







 607 NW 27th Ave Ocala, FL 34475 Ph: 352-629-5020 or 1-800-533-3569 Fax: 352-629-2902 or 1-800-520-3473	<b>TECHNICAL DATA SHEET</b>			<b>PAGE</b>	<b>30 OF 34</b>	
	<b>PRODUCT GROUP</b>	THROTTLE CONTROL	<b>P/N</b>	117155	<b>DATE</b>	8/28/2017
	<b>PRODUCT</b>	<b>TOTAL PRESSURE GOVERNOR (TPG)</b>			<b>REV</b>	2.03
					<b>BY</b>	<b>AMS/GMC</b>

## 7. Configuration

### 7.1. Configure the unit of measure

The TPG can be configured for English (PSI, °F) or Metric (kPa or bar, °C) units of measure.







Follow the sequence below to set the TPG's unit of measure.

-  +  Display shows **MENU 04 SECS** and begins counting down. Continue holding IDLE and MENU until the display shows **\*SETUP MENU\*** (4 seconds).
-  **ONCE** The display shows the menu item: **UNITS: XXX°X**.
-  **ONCE** Press the INC switch to select the desired unit of measure: PSI/°F, kPa/°C, or bar/°C.
-  **ONCE** Press the PRESET switch once. The display shows **---STORED---**. The unit of measure has been saved.
-  **ONCE** Press the IDLE switch once. The display shows **—EXITMENU—** and then restarts normal operation.

### 7.2. Select pressure transducer range (300 PSI, 600 PSI)

Normally the default 300 PSI transducer is sufficient for most pump applications but if a higher pump pressure range is required the TPG can be programmed to use a 600 PSI transducer.

Follow the sequence below to select the desired pressure transducer range.







-  +  or  Enter menu level 3 by pressing and holding the IDLE switch while entering the following password:  
**INC, DEC, DEC, INC, DEC, DEC, INC, INC**
-  Toggle the MENU/SILENCE switch until the display shows **XDCR= XXX**.  
*(XXX = 300 or 600)*
-  Press the INC switch to select the desired pressure transducer range (300 or 600).
-  **ONCE** Press the PRESET switch once. The display shows **--- STORED---**. The pressure transducer range has been saved.
-  **ONCE** Press the IDLE switch once. The display shows **—EXITMENU—** and then restarts normal operation.

 607 NW 27th Ave Ocala, FL 34475 Ph: 352-629-5020 or 1-800-533-3569 Fax: 352-629-2902 or 1-800-520-3473	<b>TECHNICAL DATA SHEET</b>			PAGE	31 OF 34	
	PRODUCT GROUP	THROTTLE CONTROL	P/N	117155	DATE	8/28/2017
	PRODUCT	TOTAL PRESSURE GOVERNOR (TPG)			REV	2.03
					BY	AMS/GMC

### 7.3. Zero calibrate the pressure transducer

The pressure indicated by the TPG may not show '0' when the pump discharge pressure is actually zero due to ambient pressure and altitude at your locale.









Follow the sequence below to zero calibrate the pressure transducer.

-  +  Display shows **MENU 04 SECS** and begins counting down. Continue holding IDLE and MENU until the display shows **\*SETUP MENU\*** (4 seconds) and then **MENU LEVEL 2** (2 seconds).
-  **3 times** The display shows the menu item: **-SENSOR CAL-**.
-  **ONCE** Press the INC switch once. The display shows **SEN zero=XXX**.
-  + **HOLD** Press the INC switch and hold. The display shows **SEN live=XXX**. Verify the value is between 130 and 155 for a 300 PSI transducer and 100 and 140 for a 600 PSI transducer. Release the INC switch. The display will show **DIS:ZERO=XXX**.
-  **ONCE** Press the PRESET switch once. The display shows **NEW ZERO=XXX**. Verify the value is between 130 and 155 for a 300 PSI transducer and 100 and 140 for a 600 PSI transducer. .
-  **ONCE** Press the IDLE switch once. The display shows **—EXITMENU—** and then restarts normal operation.

### 7.4. Configure the engine control method

The TPG has 4 engine control methods to cover several engine types and configuration.

- CFPG – Cummins Fire Pressure Governor, uses Cummins proprietary control message to control engine speed.
- MERC – Uses Mercedes control commands for PSM module equipped vehicles.
- PGN0 – Uses J1939, PGN0 – Torque Speed Control message to control engine speed.
- SCAN – SCANIA, uses the Scania bodywork control message 1.
- ANLG – Uses analog voltage signal to control remote throttle input on engine.
- PWM – Uses pulse width modulation control signal (12-85%, 400 Hz).
- VLVO – Uses Volvo specific PTO control commands for Volvo FE/FL series engines running through a bodybuilder module.

-  +  or  Enter menu level 3 by pressing and holding the IDLE switch while entering the following password.
- INC, DEC, DEC, INC, DEC, DEC, INC, INC**
-  **ONCE** The display shows the menu item: **CONTROL=XXXX** (CFPG, MERC, PGN0, SCAN, ANLG, PWM)
-  OR  Select the desired engine control method: CFPG, PGN0, SCAN, or ANLG
-  **ONCE** Press the PRESET switch once. The display shows **---STORED---**. The engine control method has been saved.
-  **ONCE** Press the IDLE switch once. The display shows **—EXITMENU—** and then restarts normal operation.



 607 NW 27th Ave Ocala, FL 34475 Ph: 352-629-5020 or 1-800-533-3569 Fax: 352-629-2902 or 1-800-520-3473	<b>TECHNICAL DATA SHEET</b>			<b>PAGE</b>	<b>32 OF 34</b>	
	<b>PRODUCT GROUP</b>	THROTTLE CONTROL	<b>P/N</b>	117155	<b>DATE</b>	8/28/2017
	<b>PRODUCT</b>	<b>TOTAL PRESSURE GOVERNOR (TPG)</b>			<b>REV</b>	2.03
					<b>BY</b>	<b>AMS/GMC</b>

### 7.5. Configure the IDLE voltage and GAIN setting using Auto Scale

A TPG set to Analog control mode (see section 5.2.14) may use the Auto Scale configure method to automatically set the IDLE voltage (5.2.33) and GAIN setting (**Error! Reference source not found.**).

The engine must be running and the interlocks (as defined in section 4.3) must be enabled when running the Auto Scale mode.



**The TPG will actively control the engine RPM during Auto Scale. Make certain that all operational precautions are observed and a trained operator is present.**

Enter the Auto Scale mode by pressing and holding the IDLE switch while entering the following password.



**INC, DEC, DEC, DEC, INC, DEC, DEC, DEC**

The display shows: **MODE = START**



Press the MODE button to start the Auto Scale.

The display shows: **IDLE SET = X.X** (where X.X is the current output voltage).

The TPG begins ramping the output voltage until it detects a change in RPM.

Once IDLE point is detected the display shows **FINDING GAIN**

The TPG then configures the GAIN setting required and the display shows **GAIN = XX** (where XX is the GAIN setting).

The Auto Scale mode completes by saving the IDLE and GAIN data and the display shows **STORING DATA**.

 607 NW 27th Ave Ocala, FL 34475 Ph: 352-629-5020 or 1-800-533-3569 Fax: 352-629-2902 or 1-800-520-3473	<b>TECHNICAL DATA SHEET</b>			<b>PAGE</b>	<b>33 OF 34</b>	
	<b>PRODUCT GROUP</b>	THROTTLE CONTROL	<b>P/N</b>	117155	<b>DATE</b>	8/28/2017
	<b>PRODUCT</b>	<b>TOTAL PRESSURE GOVERNOR (TPG)</b>			<b>REV</b>	2.03
					<b>BY</b>	<b>AMS/GMC</b>

## 8. Mounting & installation

### 8.1. Panel cutout dimensions

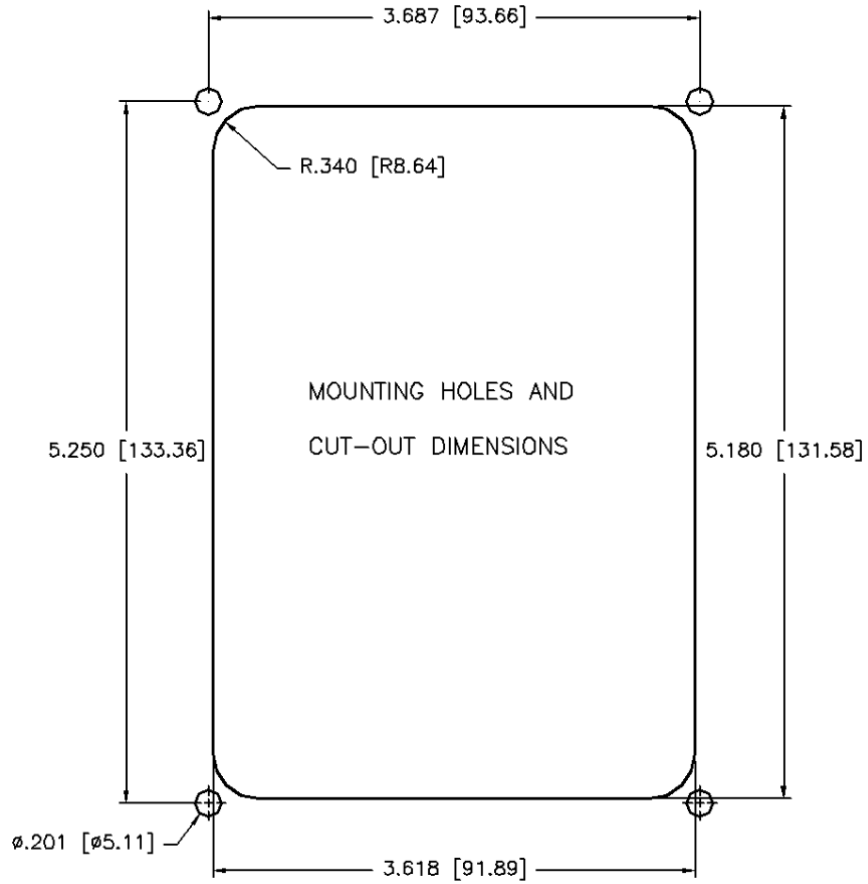



Figure 5. *Installation dimensions in inches [millimeters].*

 607 NW 27th Ave Ocala, FL 34475 Ph: 352-629-5020 or 1-800-533-3569 Fax: 352-629-2902 or 1-800-520-3473	<b>TECHNICAL DATA SHEET</b>			<b>PAGE</b>	<b>34 OF 34</b>	
	<b>PRODUCT GROUP</b>	THROTTLE CONTROL	<b>P/N</b>	117155	<b>DATE</b>	8/28/2017
	<b>PRODUCT</b>	<b>TOTAL PRESSURE GOVERNOR (TPG)</b>			<b>REV</b>	2.03
					<b>BY</b>	<b>AMS/GMC</b>

## 9. Connector Description

### 9.1. TPG connectors

The module has two connectors and the following definitions apply:

<b>Mating connector: Deutsch DT06-6SA GRAY</b>		
<b>Mating sockets: Deutsch 0462-201-16141</b>		
<b>Gold mating sockets: Deutsch 0462-201-1631</b>		
<b>Wedge lock: W6S Recommended wire gage: 16-18 AWG</b>		
PIN	CIRCUIT	DESCRIPTION
1	SUPPLY (+)	(INPUT) – battery voltage (+9VDC...+32VDC)
2	SUPPLY (-)	(INPUT) – battery ground
3	ALARM (-)	(OUTPUT) – alarm active (ground polarity, 250mA)
4	CAN HIGH	(DATA) – SAE J1939 CAN 2.0B, 125-500Kbits/s *
5	CAN LOW	(DATA) – SAE J1939 CAN 2.0B, 125-500Kbits/s *
6	CAN SHIELD	(DATA) – SAE J1939 CAN 2.0B, 125-500Kbits/s *

\* Gold pins recommended for CAN connections.

<b>Mating connector: Deutsch DT06-12SA GRAY</b>		
<b>Mating sockets: Deutsch 0462-201-16141</b>		
<b>Wedge lock: W12S Recommended wire gage: 16-18 AWG</b>		
PIN	CIRCUIT	DESCRIPTION
1	ENG REF (+)	(INPUT) – analog signal reference (+5VDC) *
2	THROT INTLK	(INPUT) – throttle ready interlock (positive polarity)
3	HI IDLE	(INPUT) – high idle enable (positive polarity)
4	OKAY TO PUMP	(INPUT) – okay to pump interlock (positive polarity) <sup>(1)</sup>
5	Sensor GND	(OUTPUT) – pressure sensor ground
6	Sensor REF	(OUTPUT) – pressure sensor supply (+5VDC)
7	Sensor SIGNAL	(INPUT) – pressure sensor signal (+0.5VDC to +4.5VDC)
8	ENG SIGNAL	(OUTPUT) – analog signal control (+0.5VDC to +4.5VDC) *
9	ENG REF (-)	(INPUT) – analog signal reference (ground) *
10	PUMP INTLK	(INPUT) – pump engaged interlock (positive polarity)
11	RELAY COM	(INPUT) – remote throttle (ground polarity) *
12	RELAY N.O.	(OUTPUT) – remote throttle activate (ground polarity) *

\* These pins and wires are available with the analog signal harness (p/n 117683)

<sup>1</sup> This input must be configured for operation – see section 5.2.37

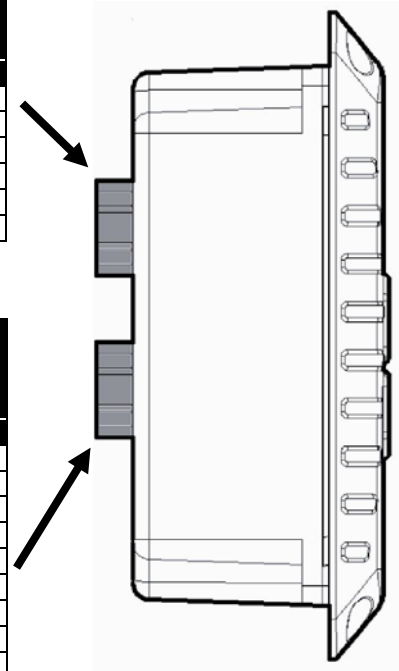

### 9.2. Pressure sensor connector

The pressure sensor has one connector and the following definitions apply:

<b>Mating connector: Packard 12078090</b>		
<b>Mating sockets: Packard 12089290</b>		
<b>Recommended wire gage: 16-18 AWG</b>		
PIN	CIRCUIT	DESCRIPTION
A	SUPPLY (-)	(INPUT) – pressure sensor ground
B	SUPPLY (+)	(INPUT) – pressure sensor supply (+5VDC)
C	Signal	(OUTPUT) – pressure sensor signal (+0.5VDC to +4.5VDC)

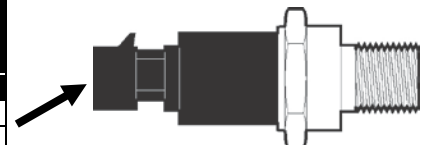

 607 NW 27th Ave Ocala, FL 34475 Ph: 352-629-5020 or 1-800-533-3569 Fax: 352-629-2902 or 1-800-520-3473	<b>TECHNICAL DATA SHEET</b>			<b>PAGE</b>	<b>35 OF 34</b>	
	<b>PRODUCT GROUP</b>	THROTTLE CONTROL	<b>P/N</b>	117155	<b>DATE</b>	8/28/2017
	<b>PRODUCT</b>	<b>TOTAL PRESSURE GOVERNOR (TPG)</b>			<b>REV</b>	2.03
					<b>BY</b>	<b>AMS/GMC</b>

## 10. Module Operating Parameters

Product category	Throttle Control
Voltage range	+9VDC...+32VDC
Power consumption	Logic supply+ input (pin 1 of the 6-pin Deutsch connector)
	@ 13.8VDC 350mA
	@ 27.6VDC 195mA
Output power	
Alarm	250mA (ground polarity)
Operational temperature range	-40°C...+85°C
Environmental range	IP 67
CAN specification	SAE CAN 2.0B J1939 , 125, 250, and 500 Kbits/second (engine, transmission)
Protection	Internal thermal fuse (1850mA on pin 1 of the 6-pin Deutsch connector) Reverse voltage protection (pins 1 and 2 of the 6-pin Deutsch connector) CAN buses protected to 24V ESD voltage protected to SAE J1113 specification for heavy duty trucks (24V) Transient voltage protected to SAE J1113 specification for heavy duty trucks (24V) Load dump voltage protected to SAE J1113 specification for heavy duty trucks (24V) Outputs protected for short circuit and thermal overload
Dimensions (W x H x D) in inches [mm]	4.437 [112.70] x 6.000 [152.39] x 2.250 [57.15]



Unit of IDEX Corporation  
 607 NW 27th Avenue  
 Ocala, FL 34475 U.S.A

Phone: 1.800.533.3569 • 352.629.5020

Fax: 1.800.520.3473 • 352.629.2902

www.class1.com