



Class 1

ISO 9001 CERTIFIED

607 NW 27th Ave
Ocala, FL 34475
Phone: (352) 629-5020 or 800-533-3569
Fax: (352)-629-2902

SUITABLE FOR EXTERNAL DISTRIBUTION

TECHNICAL PRODUCT DATASHEET

ES-KEY

High Density I/O Node
(SuperNode II)

P/N 119890 and P/N 119891 (with MODEM)



 <p>607 NW 27th Ave Ocala, FL 34475 Ph: 352-629-5020 or 1-800-533-3569 Fax: 352-629-2902 or 1-800-520-3473</p>	TECHNICAL DATA SHEET			PAGE	1 of 46	
	PRODUCT GROUP	ES-KEY	P/N	119890 and 119891 w/ MODEM	DATE	2-2-2015
	PRODUCT	High Density I/O Node (SuperNode II)			REV	1.60
					BY	AMS

- 1. REVISION LOG.....4**
- 2. NOTICE AND WARNING.....4**
- 3. MODULE OVERVIEW5**
 - 3.1. FEATURES 5
- 4. POSITIVE POLARITY SOLID STATE OUTPUTS6**
 - 4.1. CURRENT RATING 6
 - 4.2. DIGITAL CIRCUIT BREAKERS 6
 - 4.3. PULSE WIDTH MODULATION/CURRENT CONTROL 6
 - 4.4. OUTPUT FLASH CONTROL 6
 - 4.5. CIRCUIT ACTIVATION DETECTION/DIAGNOSTICS 6
- 5. GROUND POLARITY SOLID STATE OUTPUTS.....7**
 - 5.1. CURRENT RATING 7
- 6. DIGITAL INPUTS7**
- 7. DEVICE ADDRESS SELECTION7**
- 8. ES-KEY NETWORK DETAIL.....8**
 - 8.1. ADDING A SUPERNODE MODULE TO THE ES-KEY NETWORK DATABASE 8
 - 8.2. ASSIGNING A SUPERNODE MODULE AN ADDRESS IN THE ES-KEY NETWORK DATABASE 8
 - 8.3. NETWORK INPUT SPACE 9
 - 8.3.1. *Stop Engine and Check Engine Message network input space* 10
 - 8.3.2. *High Water Temperature network input space* 10
 - 8.3.3. *Low Oil Pressure network input space* 10
 - 8.3.4. *High temperature transmission Oil network input space* 10
 - 8.3.5. *Always ON network input space* 10
 - 8.3.6. *Neutral network input space* 10
 - 8.4. NETWORK OUTPUT SPACE 11
 - 8.4.1. *Configuring an output for open load detection* 12
 - 8.4.2. *Configuring an output with PWM*..... 12
 - 8.4.3. *Configuring an output with FLASH*..... 13
 - 8.5. SAVING FLASH AND OPEN LOAD FUNCTIONS IN THE SUPERNODE..... 14
- 9. SUPERNODE UTILITIES.....15**
 - 9.1. ADDING A SUPERNODE UTILITY MODULE TO THE ES-KEY NETWORK DATABASE 15
 - 9.2. CREATING A UTILITY IN THE SUPERNODE UTILITY MODULE 15
 - 9.3. SUPERNODE UTILITY NAMING SYNTAX..... 17
 - 9.4. SUPERNODE UTILITY NAMES AND FUNCTIONS..... 18
 - 9.5. PROGRAMMABLE DELAYS 18
 - 9.5.1. *Delay ON*..... 18
 - 9.5.2. *Delay OFF*..... 19
 - 9.5.3. *Delay OFF after transition*..... 19
 - 9.5.4. *Delay OFF after minutes* 19
 - 9.6. BI-STABLE TRIGGER 20
 - 9.6.1. *Standard bi-stable trigger*..... 20

 607 NW 27th Ave Ocala, FL 34475 Ph: 352-629-5020 or 1-800-533-3569 Fax: 352-629-2902 or 1-800-520-3473	TECHNICAL DATA SHEET			PAGE	2 of 46
	PRODUCT GROUP	ES-KEY	P/N	REV	DATE
			119890 and 119891 w/ MODEM	1.60	2-2-2015
	PRODUCT	High Density I/O Node (SuperNode II)		BY	AMS

9.6.2.	Power-up ON bi-stable.....	20
9.7.	TIMER FUNCTIONS	20
9.7.1.	Timer run	20
9.7.2.	Timer reset.....	20
9.7.3.	Timer trigger.....	21
9.8.	COUNTER FUNCTIONS.....	21
9.8.1.	Counter advance.....	21
9.8.2.	Counter reset	21
9.8.3.	Counter trigger	21
9.9.	VOLTAGE TRIP POINTS	22
9.9.1.	High voltage trip point.....	22
9.9.2.	Low voltage trip point.....	22
9.10.	FLASH RATE	22
9.11.	SEQUENCER FUNCTION	23
9.12.	OIL PRESSURE TRIP POINTS	23
9.12.1.	High oil pressure trip point	23
9.12.2.	Low oil pressure trip point	24
9.13.	ENGINE RPM TRIP POINTS	24
9.14.	WATER TEMPERATURE TRIP POINTS.....	24
9.14.1.	High water temperature trip point	24
9.14.2.	Low water temperature trip point	24
9.15.	TRANSMISSION HIGH TEMPERATURE TRIP POINT	25
9.16.	TRANSMISSION GEAR INDICATIONS.....	25
9.16.1.	Transmission reverse indication.....	25
9.16.2.	Transmission neutral indication.....	25
9.16.3.	Transmission park indication	25
9.16.4.	Transmission forward gear indication	25
9.17.	ENGINE WAIT TO START WARNING	26
9.18.	ENGINE WATER IN FUEL WARNING.....	26
9.19.	PARKING BRAKE INDICATION.....	26
9.20.	SERVICE BRAKE INDICATION	26
9.21.	VEHICLE SPEED TRIP POINT	26
9.22.	OUTPUT PWM CONTROL	26
9.23.	OUTPUT PWM DIMMING FUNCTION	27
9.24.	CHECK MODULE STATUS FUNCTION	27
9.25.	FLIP-FLOP FUNCTIONS	27
9.25.1.	Flip-Flop SET.....	27
9.25.2.	Flip-Flop RESET.....	28
10.	UTILITY MODULE	29
10.1.	ADDING A UTILITY MODULE TO THE ES-KEY NETWORK DATABASE.....	29
10.2.	UTILITY MODULE INPUT MEMORY SPACE FUNCTIONS	29
10.3.	UTILITY MODULE OUTPUT MEMORY SPACE FUNCTIONS	30
11.	UNIVERSAL SYSTEM MANAGER FUNCTIONS	31
11.1.	LOAD MANAGEMENT ENABLING AND FUNCTIONS	31
11.1.1.	Operating modes	31
11.1.2.	Stage switch (master switch).....	32
11.1.3.	Priority	32
11.1.4.	Sequence level.....	33
11.1.5.	High idle.....	33

 607 NW 27th Ave Ocala, FL 34475 Ph: 352-629-5020 or 1-800-533-3569 Fax: 352-629-2902 or 1-800-520-3473	TECHNICAL DATA SHEET			PAGE	3 of 46	
	PRODUCT GROUP	ES-KEY	P/N	119890 and 119891 w/ MODEM	DATE	2-2-2015
	PRODUCT	High Density I/O Node (SuperNode II)			REV	1.60
					BY	AMS

12.	DATA LOGGER FUNCTION	34
13.	MODEM FUNCTION (AVAILABLE WITH P/N 119891 ONLY).....	34
13.1.	MODEM WIRING	34
13.2.	MODEM USAGE	34
14.	SEAT BELT WARNING SYSTEM	35
14.1.	SEAT BELT WARNING ES-KEY SETUP INTERFACE	35
14.2.	SEAT AND BELT INPUT CONFIGURATION	35
14.3.	SEAT BELT WARNING DISPLAYS	36
14.4.	SEAT AND SEAT BELT DETECTION OVERVIEW	36
14.5.	SEQUENCE VIOLATION DURING POWER ON CYCLE	36
14.6.	“SEAT BOUNCE” ERROR VALIDATION.....	37
14.7.	SEAT BELT VIOLATION ALARM (SEATALARM).....	37
14.8.	OEM RESPONSIBILITY	37
14.9.	PARK BRAKE INPUT (PARKBRAKE).....	37
15.	CLIMATE CONTROL SYSTEM	37
15.1.	CLIMATE CONTROL SYSTEM FEATURES	37
15.2.	USING THE CLIMATE CONTROL SYSTEM	37
15.3.	CLIMATE CONTROL SYSTEM ES-KEY SETUP INTERFACE.....	38
15.4.	POWER OUTPUT (CCPOWER).....	38
15.5.	HEAT VALVE CONTROL OUTPUT (CCVALVE)	38
15.6.	AIR CONDITIONING CLUTCH OUTPUT (CCCLTCH).....	38
15.7.	FAN MOTOR SPEED OUTPUT (CCMOTOR AND CCMOTR2)	38
15.8.	TEMPERATURE SENSOR INPUTS	38
15.9.	AUTOMATIC MODE	38
15.10.	MANUAL MODE	38
16.	VEHICLE DATA RECORDER SYSTEM	39
16.1.	VEHICLE DATA RECORDER FEATURES	39
16.2.	MASTER SWITCH INPUT	39
16.3.	VEHICLE DATA RECORDER SOFTWARE	39
16.3.1.	<i>Vehicle Data Recorder configuration using the VDR Viewer II Data Management software</i>	<i>39</i>
16.3.2.	<i>Vehicle Data Recorder information retrieval</i>	<i>39</i>
16.4.	PASSWORDS	40
17.	USB PORT	41
18.	DIMENSIONS.....	42
19.	CONNECTOR DESCRIPTIONS	43
19.1.	OUTPUTS	43
19.2.	LOGIC POWER, COMMUNICATIONS, AND INPUTS	43
19.3.	DRIVER POWER	44
20.	DIAGNOSTIC LEDS	45
21.	TECHNICAL DETAILS	46

 607 NW 27th Ave Ocala, FL 34475 Ph: 352-629-5020 or 1-800-533-3569 Fax: 352-629-2902 or 1-800-520-3473	TECHNICAL DATA SHEET			PAGE	4 of 46	
	PRODUCT GROUP	ES-KEY	P/N	119890 and 119891 w/ MODEM	DATE	2-2-2015
	PRODUCT	High Density I/O Node (SuperNode II)			REV	1.60
					BY	AMS

1. Revision Log

Rev	Date	Approved	Changes
1.00	5-14-2010	AMS	Initial requirements
1.10	5-10-2012	AMS	Updated circuit breaker description. Updated Supernode Utility section. Added Standard Utility section. Added load management section.
1.20	5-13-2013	WCH	Added notice and warning.
1.30	2-6-2014	AMS	Added climate control, Seat Belt warning, VDR, and polarity selectable input configuration.
1.40	7-17-2014	AMS	Added seat/belt normally open/normally closed configuration. Added VDR park brake sources.
1.50	8-7-2014	WCH	Corrected polarity selectable input description on page 9.
1.60	2-2-2015	AMS	Added SB and Gxx SuperNode Utilities.

2. Notice and Warning

NOTICE AND WARNING

Class1 ES-Key System products are universal multiplexing devices intended for general commercial applications. They are not specifically designed for use in critical lifesaving or life supporting applications and do not qualify for 21 CFR or 510k requirements for medical device review.

Manufacturers that use Class 1 ES-Key System products for vehicles and other equipment should thoroughly test and validate programming and installation prior to delivery of vehicles and other equipment to ensure proper operation and performance of all hardware and software functions.

Manual operating redundancies should be included, especially when Class 1 ES-Key System products are used in connection with medical device or critical function applications.

Firmware for Class 1 ES-Key products should be promptly updated and upgraded as and when Class 1 makes firmware updates and upgrades available.

Class1 is not responsible or liable for failures and operating or performance issues that may result from failure to follow these recommendations. **Among other things, failure to follow these recommendations could lead to serious injury or death.**

 607 NW 27th Ave Ocala, FL 34475 Ph: 352-629-5020 or 1-800-533-3569 Fax: 352-629-2902 or 1-800-520-3473	TECHNICAL DATA SHEET			PAGE	5 of 46	
	PRODUCT GROUP	ES-KEY	P/N	119890 and 119891 w/ MODEM	DATE	2-2-2015
	PRODUCT	High Density I/O Node (SuperNode II)			REV	1.60
					BY	AMS

3. Module Overview

The ES-Key™ High Density I/O Node (Supernode II p/n 119890 and p/n 119891 with MODEM) consolidates functions of multiple ES-Key™ modules to reduce node count and simplify addressing. The Supernode II is well suited for applications where a centralized node location is required.

3.1. Features

- **18** positive polarity solid state outputs (13 Amps each) section 4
- **6** ground polarity solid state outputs (2 Amps each) section 5
- **24** positive/ground selectable polarity digital inputs section 6
- Digital Circuit Breakers on all positive polarity outputs section 4.2
- Output “open load” detection section 4.5
- Input and output LED status indicators section 20
- Output PWM control (*on certain outputs*) section 4.3
- Output FLASH control (*on certain outputs*) section 4.4
- Incorporated data logger (*for SuperNodes addressed 0*) section 12
- Incorporated Universal System Manager including load management functions (*for SuperNodes addressed 0*) section 11
- Programmable utilities (timers, delays, etc) section 9
- SAE J1939 CAN engine message reception and ES-Key I/O association section 8.3.1
- ES-Key MODEM for remote diagnostics (p/n 119891 only) section 13
- Integrated Seat Belt Warning system section 14
- Integrated Climate Control system section 15
- Integrated Vehicle Data Recorder system section 16
- USB port for database transfer and diagnostics section 17

 607 NW 27th Ave Ocala, FL 34475 Ph: 352-629-5020 or 1-800-533-3569 Fax: 352-629-2902 or 1-800-520-3473	TECHNICAL DATA SHEET			PAGE	6 of 46	
	PRODUCT GROUP	ES-KEY	P/N	119890 and 119891 w/ MODEM	DATE	2-2-2015
	PRODUCT	High Density I/O Node (SuperNode II)			REV	1.60
					BY	AMS

4. Positive Polarity Solid State Outputs

Positive polarity output channels (0 through 17) of the Supernode II utilize solid state, fully protected high-side drivers that feature current limitation and open load detection. These output drivers replace the requirement of a relay and circuit breaker.

Output	Max Current	Digital circuit breaker	PWM capable	Output "open load" detection	FLASH capable
0 - 7	13 Amps	YES	NO	YES	YES
8 - 9	13 Amps	YES	NO	YES	YES
10 - 17	13 Amps	YES	YES	NO	YES

4.1. Current Rating

Each of the eighteen (18) high current outputs is capable of supplying 13 Amps continuously at an ambient temperature of up to 85° Celsius (185° Fahrenheit).

4.2. Digital Circuit Breakers

Outputs 0 through 17 have a "digital circuit breaker" which causes the associated output to automatically turn OFF after approximately 2.5 seconds when its load exceeds 13.5 A (+5%, -0%). The output will attempt to turn ON and verify the load two more times at 5 second intervals. If the output is still overloaded it will remain OFF.

The "digital circuit breaker" feature can be reset (or reinitialized) by de-activating the output through the ES-Key™ network. When the output is turned back ON, the over current tests will be initiated.

When an output switch is in an over current situation, a fault is logged to the USM and data logger functions of the Supernode II.

4.3. Pulse Width Modulation/Current Control

Outputs 10 through 17 can be Pulse Width Modulated (PWM) to control loads at reduced power. PWM can also be used as a lighting dimming function. An output with its PWM function enabled will drive its load at 60% (default), 50%, 40%, 30%, 20%, or 10% duty cycle, 400 Hz (see section 8.4.2).

4.4. Output Flash Control

Outputs 0 through 17 can be flashed with two available rates (75ppm and 150ppm). Alternating flash patterns are also easily configured for use with "wig-wag" lights (see section 8.4.3).

4.5. Circuit Activation Detection/Diagnostics

Each of the outputs has an output LED associated. When an output is physically ON the corresponding output LED will be illuminated (see section 20).

Outputs 0 through 9 have "open load" detection circuitry. When an open load condition is detected the system will generate a network tag to indicate "open load" for the specific output. The tag can be used by the ES-Key network for diagnostics or indication (see section 8.4.1).

During an over current shutdown condition a tag will be active for the particular output (see section 8.3).

 607 NW 27th Ave Ocala, FL 34475 Ph: 352-629-5020 or 1-800-533-3569 Fax: 352-629-2902 or 1-800-520-3473	TECHNICAL DATA SHEET				PAGE	7 of 46
	PRODUCT GROUP	ES-KEY	P/N	119890 and 119891 w/ MODEM	DATE	2-2-2015
	PRODUCT	High Density I/O Node (SuperNode II)			REV	1.60
					BY	AMS

5. Ground Polarity Solid State Outputs

Ground polarity output channels (18 through 23) of the Supernode II utilize solid state, fully protected low-side drivers.

5.1. Current Rating

Each of the 8 low current outputs is capable of supplying 2 Amp continuously at an ambient temperature of up to 85° Celsius (185° Fahrenheit).

6. Digital Inputs

The Supernode II has twenty-four (24) digital inputs. Each of the inputs can be configured for either positive or ground polarity using ES-Key Pro's "settings" tab and selecting the desired polarity in the "Input Polarity" drop down box. The database must be transferred as a Flex File (Upload ALL) in order for the input polarity configuration to be updated and saved within the Supernode II.

- Inputs 0 through 7 are positive polarity by default.
- Inputs 8 through 23 are ground polarity by default.

Supernode II addresses 1-3 must be connected to the CAN bus with Supernode 0 in order for their input polarities to be configured. Supernode II address 0 will transmit CAN messages to the other SuperNodes after the Flex Transfer has been initiated in order to configure their outputs.

7. Device Address Selection

The Supernode II's physical address is selected by connecting one of the three addressing inputs to ground.

- Not using any pins sets the Supernode to address 0.
- Placing ground on pin 8 (40-pin connector) sets the Supernode to address 1.
- Placing ground on pin 37 (40-pin connector) sets the Supernode to address 2.
- Placing ground on pin 27 (40-pin connector) sets the Supernode to address 3.

PIN	ADDRESS				Database disabled
	0	1	2	3	
8	OPEN	GND	OPEN	OPEN	GND
37	OPEN	OPEN	GND	OPEN	GND
27	OPEN	OPEN	OPEN	GND	OPEN



Grounding pins 8 and 37 during power up will disable the network database. The database must be reloaded for the Supernode II to function.

 607 NW 27th Ave Ocala, FL 34475 Ph: 352-629-5020 or 1-800-533-3569 Fax: 352-629-2902 or 1-800-520-3473	TECHNICAL DATA SHEET			PAGE	8 of 46	
	PRODUCT GROUP	ES-KEY	P/N	119890 and 119891 w/ MODEM	DATE	2-2-2015
	PRODUCT	High Density I/O Node (SuperNode II)			REV	1.60
					BY	AMS

8. ES-Key Network Detail

8.1. Adding a Supernode Module to the ES-Key network database

An ES-Key network can contain up to four (4) SuperNodes and each must have a unique address (see section 7). Add a Supernode module to the ES-Key network by right-clicking on the “ES-Key Network” block, select “Add Device”, and select “Supernode Module”. The first Supernode added will be assigned address 0, the second will be assigned address 1, etc.

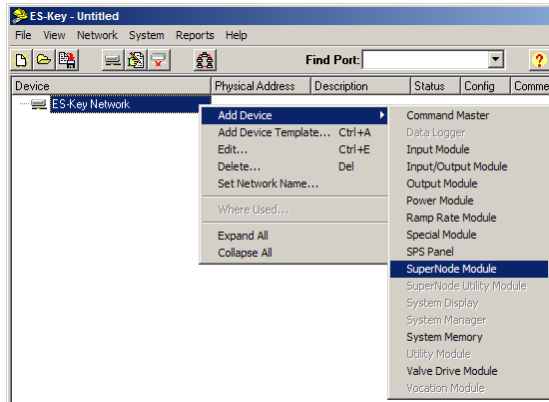

8.2. Assigning a Supernode Module an address in the ES-Key network database

A unique address (0-3) will be assigned automatically by the ES-Key Professional software, but the address can easily be changed in the network by double clicking on the “Supernode” to open the “Device Editor”, highlighting (clicking on) the desired Supernode, then open the “Device Address” drop down box and select the desired address. (The drop down box will only contain the unique addresses available).

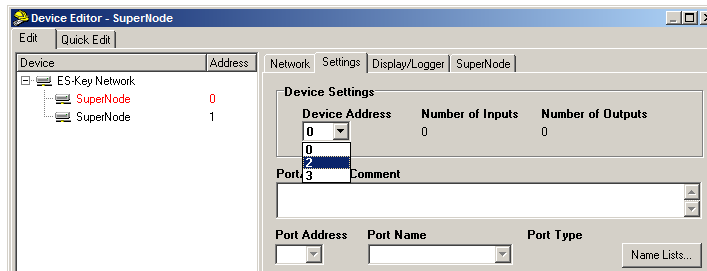

 607 NW 27th Ave Ocala, FL 34475 Ph: 352-629-5020 or 1-800-533-3569 Fax: 352-629-2902 or 1-800-520-3473	TECHNICAL DATA SHEET			PAGE	9 of 46	
	PRODUCT GROUP	ES-KEY	P/N	119890 and 119891 w/ MODEM	DATE	2-2-2015
	PRODUCT	High Density I/O Node (SuperNode II)			REV	1.60
					BY	AMS

8.3. Network input space

The Supernode can have up to 64 network inputs (0 through 63) assigned to the ES-Key network database. Use the ES-Key Professional software to add network inputs by double clicking on the “Supernode” to open the “Device Editor” and then pressing **CTRL+I** on the keyboard to create each input.

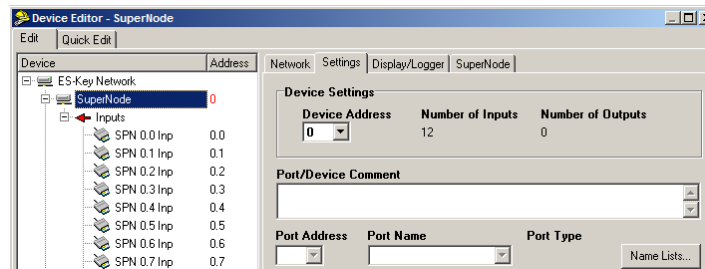

The first 24 inputs are the physical inputs which have a direct connection through the Supernode’s connector to the real world (0-23 are polarity selectable inputs). The remaining 40 inputs (24-63) are virtual inputs that relay information concerning the Supernode’s digital circuit breaker feedback states and engine message association.

Input	Description
0	Input 0 (polarity selectable)
1	Input 1 (polarity selectable)
2	Input 2 (polarity selectable)
3	Input 3 (polarity selectable)
4	Input 4 (polarity selectable)
5	Input 5 (polarity selectable)
6	Input 6 (polarity selectable)
7	Input 7 (polarity selectable)
8	Input 8 (polarity selectable)
9	Input 9 (polarity selectable)
10	Input 10 (polarity selectable)
11	Input 11 (polarity selectable)
12	Input 12 (polarity selectable)
13	Input 13 (polarity selectable)
14	Input 14 (polarity selectable)
15	Input 15 (polarity selectable)
16	Input 16 (polarity selectable)
17	Input 17 (polarity selectable)
18	Input 18 (polarity selectable)
19	Input 19 (polarity selectable)
20	Input 20 (polarity selectable)
21	Input 21 (polarity selectable)
22	Input 22 (polarity selectable)
23	Input 23 (polarity selectable)
24	J1939 stop engine
25	J1939 check engine
26	J1939 water temp HIGH
27	J1939 oil PSI LOW ⁽¹⁾
28	Trans temperature HIGH
29	Not defined
30	Always ON
31	Neutral

Input	Description
32	Output 0 OL feedback ⁽²⁾
33	Output 1 OL feedback ⁽²⁾
34	Output 2 OL feedback ⁽²⁾
35	Output 3 OL feedback ⁽²⁾
36	Output 4 OL feedback ⁽²⁾
37	Output 5 OL feedback ⁽²⁾
38	Output 6 OL feedback ⁽²⁾
39	Output 7 OL feedback ⁽²⁾
40	Output 8 OL feedback ⁽²⁾
41	Output 9 OL feedback ⁽²⁾
42	Output 0 OC feedback ⁽³⁾
43	Output 1 OC feedback ⁽³⁾
44	Output 2 OC feedback ⁽³⁾
45	Output 3 OC feedback ⁽³⁾
46	Output 4 OC feedback ⁽³⁾
47	Output 5 OC feedback ⁽³⁾
48	Output 6 OC feedback ⁽³⁾
49	Output 7 OC feedback ⁽³⁾
50	Output 8 OC feedback ⁽³⁾
51	Output 9 OC feedback ⁽³⁾
52	Not defined
53	Not defined
54	FLASH 75 BPM
55	FLASH 150 BPM
56	Output 10 OC feedback ⁽³⁾
57	Output 11 OC feedback ⁽³⁾
58	Output 12 OC feedback ⁽³⁾
59	Output 13 OC feedback ⁽³⁾
60	Output 14 OC feedback ⁽³⁾
61	Output 15 OC feedback ⁽³⁾
62	Output 16 OC feedback ⁽³⁾
63	Output 17 OC feedback ⁽³⁾

⁽¹⁾ Engine RPM must be greater than 600.

⁽²⁾ OL = open load.

⁽³⁾ OC = over current.

 607 NW 27th Ave Ocala, FL 34475 Ph: 352-629-5020 or 1-800-533-3569 Fax: 352-629-2902 or 1-800-520-3473	TECHNICAL DATA SHEET			PAGE	10 of 46	
	PRODUCT GROUP	ES-KEY	P/N	119890 and 119891 w/ MODEM	DATE	2-2-2015
	PRODUCT	High Density I/O Node (SuperNode II)			REV	1.60
					BY	AMS

8.3.1. Stop Engine and Check Engine Message network input space

The Supernode associates the check engine and stop engine lights that are broadcast in the SAE J1939 DM1 message to its ES-Key network input space.

A stop engine message causes the Supernode to activate input 24 of its network input space.

A check engine message causes the Supernode to activate input 25 of its network input space.

Stop/check engine is received from the engine control unit via SAE J1939 PGN 65226.

8.3.2. High Water Temperature network input space

The Supernode associates high water temperature (greater than 250 °F) into its ES-Key network input space.

A high water temperature causes the Supernode to activate input 26 of its network input space.

Engine water temperature is received from the engine control unit via SAE J1939 PGN 65262.

8.3.3. Low Oil Pressure network input space

The Supernode associates low oil pressure (less than 5 PSI) into its ES-Key network input space.

A low oil pressure causes the Supernode to activate input 27 of its network input space.

Engine oil pressure is received from the engine control unit via SAE J1939 PGN 65263.

8.3.4. High temperature transmission Oil network input space

The Supernode associates high temperature transmission Oil (greater than 220 °F) into its ES-Key network input space.

A high transmission Oil temperature causes the Supernode to activate input 28 of its network input space.

Engine oil pressure is received from the transmission control unit via SAE J1939 PGN 65272.

8.3.5. Always ON network input space

The Supernode's Always ON ES-Key network input space is activated one (1) second after the Supernode is powered ON. This network spaced remains ON until the Supernode is powered OFF.

8.3.6. Neutral network input space

The Supernode associates transmission in neutral into its ES-Key network input space.

Transmission in neutral causes the Supernode to activate input 31 of its network input space.

Transmission selected gear is received from the transmission control unit via SAE J1939 PGN 61445.

 607 NW 27th Ave Ocala, FL 34475 Ph: 352-629-5020 or 1-800-533-3569 Fax: 352-629-2902 or 1-800-520-3473	TECHNICAL DATA SHEET			PAGE	11 of 46	
	PRODUCT GROUP	ES-KEY	P/N	119890 and 119891 w/ MODEM	DATE	2-2-2015
	PRODUCT	High Density I/O Node (SuperNode II)			REV	1.60
					BY	AMS

8.4. Network output space

The Supernode can have up to 64 network outputs (0 through 63) assigned to the ES-Key network database. Use the ES-Key Professional software to add network outputs by double clicking on the "Supernode" to open the "Device Editor" and then pressing **CTRL+O** on the keyboard to create each output.

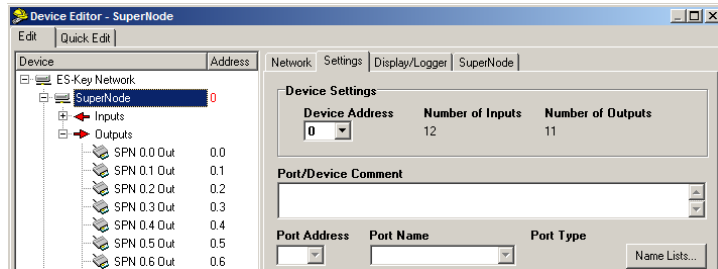

The first 24 outputs are the physical outputs which have a direct connection through the Supernode's connector to the real world (0-17 are the positive polarity outputs, 18-23 are the ground polarity outputs). The remaining 40 outputs (24-63) set the special functions of the physical outputs (flash, flash rate, PWM).

Output	Description
0	Output 0 (positive)
1	Output 1 (positive)
2	Output 2 (positive)
3	Output 3 (positive)
4	Output 4 (positive)
5	Output 5 (positive)
6	Output 6 (positive)
7	Output 7 (positive)
8	Output 8 (positive)
9	Output 9 (positive)
10	Output 10 (positive)
11	Output 11 (positive)
12	Output 12 (positive)
13	Output 13 (positive)
14	Output 14 (positive)
15	Output 15 (positive)
16	Output 16 (positive)
17	Output 17 (positive)
18	Output 18 (ground)
19	Output 19 (ground)
20	Output 20 (ground)
21	Output 21 (ground)
22	Output 22 (ground)
23	Output 23 (ground)
24	Bank 0 flash rate
25	Bank 1 flash rate
26	Low current test enable
27	PWM outputs set to 10% ⁽¹⁾
28	PWM outputs set to 20% ⁽¹⁾
29	PWM outputs set to 30% ⁽¹⁾
30	PWM outputs set to 40% ⁽¹⁾
31	PWM outputs set to 50% ⁽¹⁾

Output	Description
32	Flash output 0
33	Flash output 1
34	Flash output 2
35	Flash output 3
36	Flash output 4
37	Flash output 5
38	Flash output 6
39	Flash output 7
40	Flash output 8
41	Flash output 9
42	Not defined
43	Not defined
44	Not defined
45	Not defined
46	Not defined
47	Not defined
48	Flash output 10
49	Flash output 11
50	Flash output 12
51	Flash output 13
52	Flash output 14
53	Flash output 15
54	Flash output 16
55	Flash output 17
56	PWM output 10
57	PWM output 11
58	PWM output 12
59	PWM output 13
60	PWM output 14
61	PWM output 15
62	PWM output 16
63	PWM output 17

⁽¹⁾ These override the Supernode Utility output PWM control.

 607 NW 27th Ave Ocala, FL 34475 Ph: 352-629-5020 or 1-800-533-3569 Fax: 352-629-2902 or 1-800-520-3473	TECHNICAL DATA SHEET			PAGE	12 of 46	
	PRODUCT GROUP	ES-KEY	P/N	119890 and 119891 w/ MODEM	DATE	2-2-2015
	PRODUCT	High Density I/O Node (SuperNode II)			REV	1.60
					BY	AMS

8.4.1. Configuring an output for open load detection

Positive outputs 0 through 9 of the Supernode can be configured to check for open loads. This is a useful feature that can be incorporated into the ES-Key network to warn an operator that an output is not operating because of a dead lamp, etc. The open load detection method pulses the output on for a very short amount of time (less than a millisecond) to check the output's state.

Use the ES-Key Professional software to configure open load detection by double clicking on the "Supernode" to open the "Device Editor", then select the "Supernode" folder tab, and then check the box of the desired load under the "Low Current FB?" column.

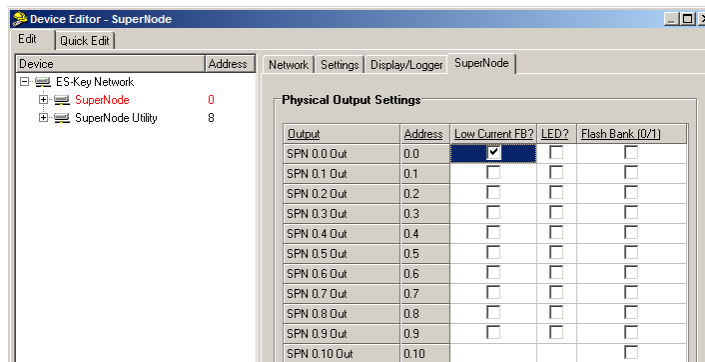

The open load detection can be set to look for incandescent or LED type lamps. If the output is attached to an LED type lamp then check the box next to the desired output under the "LED?" column.

The output(s) configured for open load detection will not begin testing for an open load until the Supernode's output 26 (low current test enable in the network output space) is activated. This output can be networked to a switch or a condition in the ES-Key database so that the checks only occur during vehicle power-up, etc.

The new data must be saved to the Supernode by using the ES-Key Professional software or the changes will not take affect (see section 8.5).

8.4.2. Configuring an output with PWM

Positive outputs 10 through 17 of the Supernode can be configured for Pulse Width Modulated operation (PWM). This feature drives the selected output at the configured duty cycle and can be used as a dimming feature for lamps. Outputs 56 through 63 of the Supernode's network output space control the PWM state of physical outputs 10 through 17. When an output's associated PWM output is turned ON then its physical output will be Pulse Width Modulated. The physical output spaces 10-17 take precedence over their associated PWM control space (56-63). For example, if output memory spaces 10 (physical output 10) and 56 (PWM output 10) are both ON then the physical output 10 will be ON solid.

The standard PWM duty cycle is 60% (when output memory spaces 27-31 are not active). Five other duty cycles (10%, 20%, 30%, 40%, and 50%) can also be selected by activating the associated output memory space (outputs 27-31). For example, if memory space output 29 is activated all active PWM outputs will be set to 30% duty cycle. In the event that more than one of the PWM output memory spaces (27-31) is active the lower output memory space number will take precedence (see section 8.4).

 607 NW 27th Ave Ocala, FL 34475 Ph: 352-629-5020 or 1-800-533-3569 Fax: 352-629-2902 or 1-800-520-3473	TECHNICAL DATA SHEET			PAGE	13 of 46	
	PRODUCT GROUP	ES-KEY	P/N	119890 and 119891 w/ MODEM	DATE	2-2-2015
	PRODUCT	High Density I/O Node (SuperNode II)			REV	1.60
					BY	AMS

8.4.3. Configuring an output with FLASH

All of the positive outputs (0 through 17) of the Supernode can be configured for FLASH operation. This feature flashes the selected output at the configured rate (75 or 150 pulses per minute). This is useful for setting up warning lights, wig-wags, etc.

A physical output will begin flashing when its associated flash output (32-41, 48-55) is activated in the SuperNode's network output space. For example, if output 33 is activated then physical output 1 will begin flashing.

An alternate flash can be set up by turning on the physical output along with its associated output in the SuperNode's network output space. By using this method along with the standard flash a wig-wag can be configured. For example, physical outputs 0 and 1 are connected to lamps where a wig-wag is desired. Turn on output 32, output 33, and output 1 in the SuperNode's network output space. Physical outputs 0 and 1 will now alternate flashing.

A. CONFIGURING THE OUTPUT FLASH RATE

The Supernode allows two different flash rates: 75 and 150 pulses per minute. The rates are controlled within the SuperNode's network output space 24 (bank 0) and 25 (bank 1). The two banks allow outputs to use different flash rates and be changed "on the fly" through ES-Key network associations. Activate a bank output to set the flash rate to 150 pulses per minute and de-activate a bank output to set the flash rate to 75 pulses per minute.

Use the ES-Key Professional software to set the output(s) to the desired bank by double clicking on the "Supernode" to open the "Device Editor", then highlight (click on) the "Outputs" section, then select the "Supernode" folder tab, and then check the box of the desired output under the "Flash Bank 0/1" column. Checking the box associates the output with bank 1 and clearing the box associates the output with bank 0.

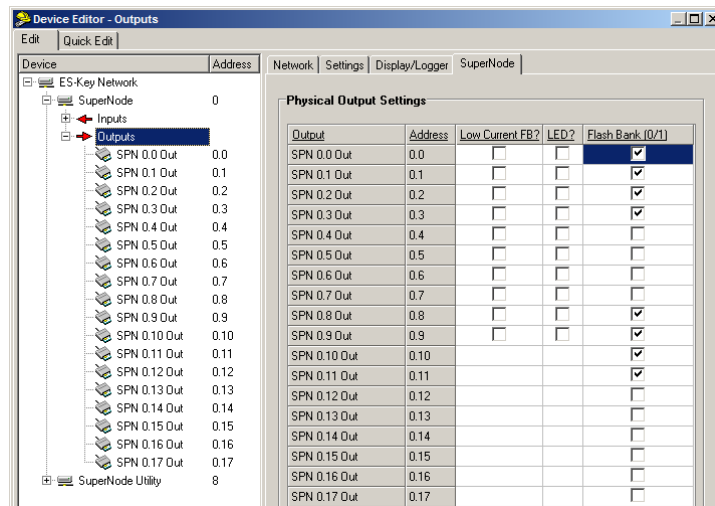

The new data must be saved to the Supernode by using the ES-Key Professional software or the changes will not take affect (see section 8.5).

NOTE: The physical output must be defined before the Flash Bank selection becomes available. Even if there is no multiplex equation connected to the actual port.

 607 NW 27th Ave Ocala, FL 34475 Ph: 352-629-5020 or 1-800-533-3569 Fax: 352-629-2902 or 1-800-520-3473	TECHNICAL DATA SHEET			PAGE	14 of 46
	PRODUCT GROUP	ES-KEY	P/N	119890 and 119891 w/ MODEM	DATE
PRODUCT	High Density I/O Node (SuperNode II)			REV	1.60
				BY	AMS

8.5. Saving flash and open load functions in the Supernode

Flash and open load detect functions will not be saved when performing a standard ES-Key database upload. The new data must be saved to the Supernode by using the "Upload to Supernode" command in the ES-Key Professional software.

Highlight (click on) Supernode, then in the top menu Select "Network", in the drop down box select "SuperNodes" in the new drop down box select "Upload to Supernode".

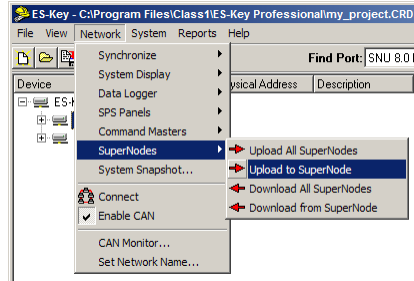

 607 NW 27th Ave Ocala, FL 34475 Ph: 352-629-5020 or 1-800-533-3569 Fax: 352-629-2902 or 1-800-520-3473	TECHNICAL DATA SHEET			PAGE	15 of 46
	PRODUCT GROUP	ES-KEY	P/N	119890 and 119891 w/ MODEM	DATE
PRODUCT	High Density I/O Node (SuperNode II)			REV	1.60
				BY	AMS

9. Supernode Utilities

9.1. Adding a Supernode Utility Module to the ES-Key network database

The Supernode contains many utilities for allowing unique operation. Section 9.4 contains a table which lists all of the Supernode Utilities available. These utilities are only available for a Supernode set to address 0.

The Supernode Utilities are available to the ES-Key network by adding a “Supernode Utility Module” with the ES-Key Professional software. The Supernode Utility Module is a virtual device that resides in the memory of the Supernode. A Supernode must be added to the network before a Supernode Utility Module can be added.

Add a Supernode Utility to the ES-Key network by right-clicking on “ES-Key Network”, select “Add Device”, and select “Supernode Utility Module”.

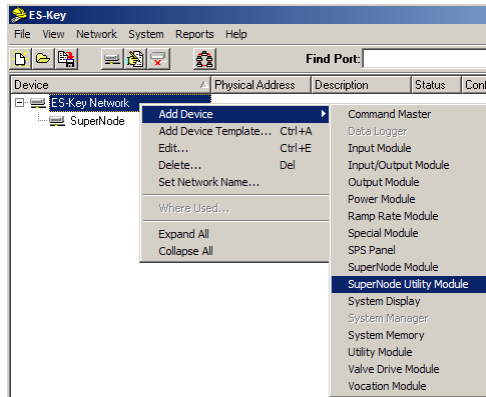

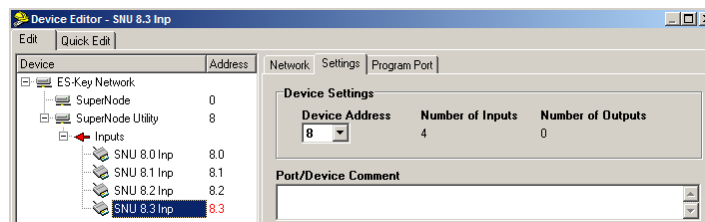

9.2. Creating a utility in the Supernode Utility Module

All Supernode utilities are added to the network input space of the Supernode Utility. You must first create the desired number of inputs (up to 32) to the Supernode Utility by double clicking on the “Supernode Utility” to open the “Device Editor” and then pressing **CTRL+I** on the keyboard to create each input.

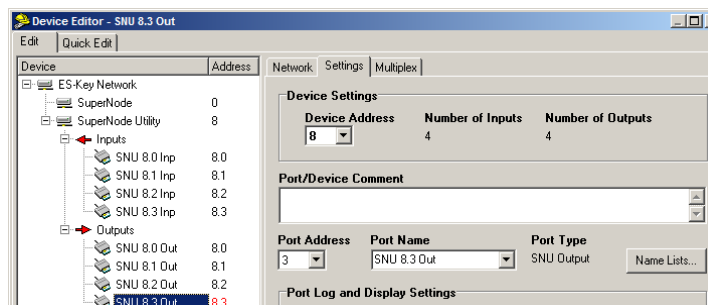

Add the desired number of outputs (up to 32) to the Supernode Utility by pressing **CTRL+O** on the keyboard to create each output.



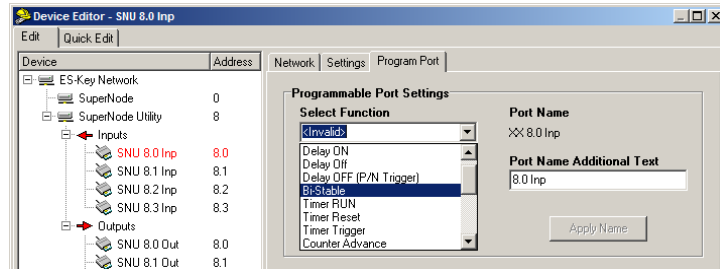

 607 NW 27th Ave Ocala, FL 34475 Ph: 352-629-5020 or 1-800-533-3569 Fax: 352-629-2902 or 1-800-520-3473	TECHNICAL DATA SHEET			PAGE	16 of 46	
	PRODUCT GROUP	ES-KEY	P/N	119890 and 119891 w/ MODEM	DATE	2-2-2015
	PRODUCT	High Density I/O Node (SuperNode II)			REV	1.60
					BY	AMS

Highlight (click on) the desired SuperNode Utility input and assign a special utility function by selecting the “Program Port” folder tab and then clicking on the down arrow to open the “Select Function” list box. Select the desired utility.

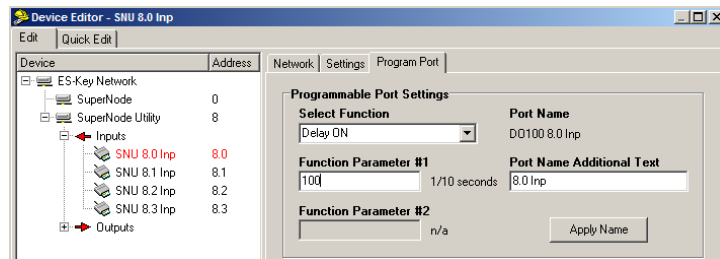

If the selected utility requires an additional parameter the “Function Parameter #1” text box will be enabled so that the value can be entered. Some utilities require an additional value to be entered into the “Function Parameter #2” text box (see section 9.4).



 607 NW 27th Ave Ocala, FL 34475 Ph: 352-629-5020 or 1-800-533-3569 Fax: 352-629-2902 or 1-800-520-3473	TECHNICAL DATA SHEET			PAGE	17 of 46	
	PRODUCT GROUP	ES-KEY	P/N	119890 and 119891 w/ MODEM	DATE	2-2-2015
	PRODUCT	High Density I/O Node (SuperNode II)			REV	1.60
					BY	AMS

9.3. Supernode Utility naming syntax

The ES-Key Professional software will automatically name the selected Supernode utility port with the correct syntax when using the “program port” tab. (*The details of the default syntax structure are found in each of the Supernode Utility description sections*).

The ES-Key professional software adds extra text to the core naming syntax, but this extra text can be personalized in the “Port Name Additional Text” box to make the Supernode utility port easier to identify. For example, below we have created a “Voltage Greater Than” trip point with a “Function Parameter 1” of 150 (15.0 volts), and the additional text was re-named “Voltage HI”.

The ES-Key Professional software only allows port names to be 16 characters long (including the core syntax) and truncates names that exceed 16 characters (spaces count as a character).

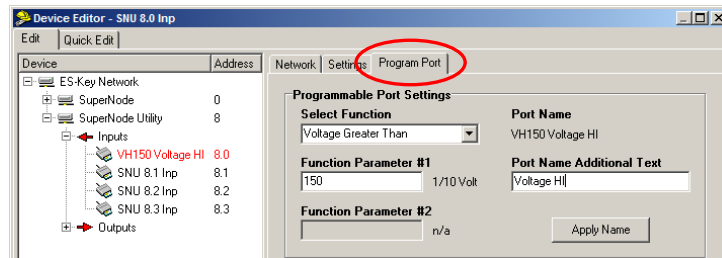

It is not mandatory to use the ES-Key Professional “program port” tab to create the naming syntax of a utility. A utility input can be manually named using the “settings” tab as long as the rules of the desired utility are followed. For example, below a coolant temperature high utility is created by manually naming utility port 8.0 **TH250**.

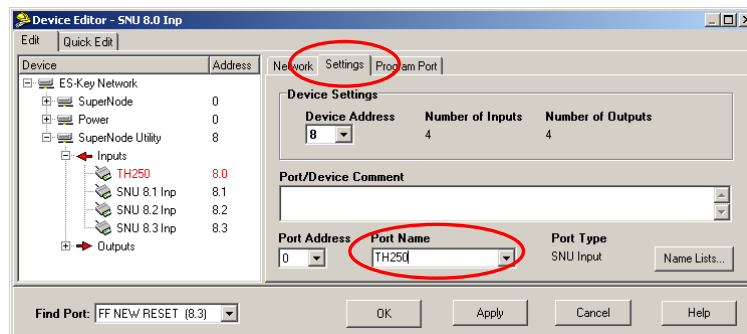

 607 NW 27th Ave Ocala, FL 34475 Ph: 352-629-5020 or 1-800-533-3569 Fax: 352-629-2902 or 1-800-520-3473	TECHNICAL DATA SHEET			PAGE	18 of 46
	PRODUCT GROUP	ES-KEY	P/N	REV	DATE
	PRODUCT	High Density I/O Node (SuperNode II)		1.60	2-2-2015
			119890 and 119891 w/ MODEM	BY	AMS

9.4. Supernode Utility names and functions

Function	Function Syntax	Function Parameter 1	Function Parameter 2	Example	Section
Delay ON seconds	DO	Time (1/10 seconds)	----	DO600	9.5.1
Delay OFF seconds	DF	Time (1/10 seconds)	----	DF30	9.5.2
Delay OFF after transition	DB	Time (1/10 seconds)	----	DB300	9.5.3
Delay OFF minutes	DM	Time (minutes)	----	DM10	9.5.4
Bi-stable trigger	BS	----	----	BS	9.6.1
Bi-stable trigger (default ON)	BO	----	----	BO	9.6.2
Timer run	TA	Timer number (0,1,2,3)	----	TA2	9.7.1
Timer reset	TR	Timer number (0,1,2,3)	----	TR1	9.7.2
Timer trigger	TT	Timer number (0,1,2,3)	Time (1/10 hours)	TT0,2	9.7.3
Counter advance	CA	Counter number (0,1,2,3)	----	CA1	9.8.1
Counter reset	CR	Counter number (0,1,2,3)	----	CR1	9.8.2
Counter trigger	CT	Counter number (0,1,2,3)	Trip count	CT1,500	9.8.3
Voltage greater than	VH	Trip voltage (1/10 volts)	----	VH140	9.9.1
Voltage less than	VL	Trip voltage (1/10 volts)	----	VL119	9.9.2
Flasher	F	Flash rate (1/4 second)	----	F4	9.10
Sequence	S	Sequencer number (0,1,2,3)	Number of steps (2-9)	S0,4	9.11
Oil pressure high	OH	Pressure in PSI	----	OH60	9.12.1
Oil pressure low	OL	Pressure in PSI	----	OL5	9.12.2
Engine RPM warning	R	RPM	----	R2200	9.13
Coolant temperature high	TH	Degrees in F	----	TH250	9.14.1
Coolant temperature low	TL	Degrees in F	----	TL75	9.14.2
Transmission temp HIGH	TX	Degrees in F	----	TX250	9.15
Transmission – reverse	RW	----	----	RW	9.16.1
Transmission – park	TP	----	----	TP	9.16.3
Transmission – neutral	N	----	----	N	9.16.2
Transmission - forward gear	G	Gear (01 to 99)	----	G09	9.16.4
Wait to start warning	WS	----	----	WS	9.17
Water in fuel warning	WF	----	----	WF	9.18
Park brake warning	PB	----	----	PB	9.19
Service Brake	SB	----	----	SB	
Vehicle speed warning	M	Miles per hour	----	M65	9.21
Set channel PWM	P	Channel (0-7, A=all)	PWM duty cycle	P3,75	9.22
Enable PWM dimming	PD	Channel (0-7, A=all)	----	PDA	9.23
Check module status	CM	Device type (0-F)	Device address (0-F)	CM10	9.24
Flip flop set	FFB	----	----	FFB	9.25.1
Flip flop reset	FFA	----	----	FFA	9.25.2

9.5. Programmable delays

The Supernode has four types of programmable delays: delay ON, delay OFF, delay OFF after transition, and delay OFF after number of minutes. A delay is created by using the ES-Key Professional software to name an input with the delay naming syntax in the Supernode Utility (SNU) space.

The delay naming syntax consists of DX####. The D indicates delay, X is the type of delay (O = ON, F = OFF, B = OFF after transition, M OFF after minutes), #### is the time of the delay in tenths of a second (101 = 10.1 seconds). For example, DO15 is a delay ON for 1.5 seconds.

9.5.1. Delay ON

Delay ON causes the designated Supernode Utility input to turn ON after the associated Supernode Utility output is activated and the designated delay time is met.

Example:

Supernode Utility input 2 is labeled **DO125** (delay ON after 12.5 seconds). When Supernode Utility output 2 is turned ON then DO125 (Supernode Utility input 2) will turn ON after 12.5 seconds.

Resolution: minimum 1 (0.1 seconds), maximum 9999 (999.9 seconds).

 607 NW 27th Ave Ocala, FL 34475 Ph: 352-629-5020 or 1-800-533-3569 Fax: 352-629-2902 or 1-800-520-3473	TECHNICAL DATA SHEET			PAGE	19 of 46	
	PRODUCT GROUP	ES-KEY	P/N	119890 and 119891 w/ MODEM	DATE	2-2-2015
	PRODUCT	High Density I/O Node (SuperNode II)			REV	1.60
					BY	AMS

9.5.2. Delay OFF

Delay OFF causes the designated Supernode Utility input to turn ON with the associated Supernode Utility output and then turn OFF after the designated delay time.

Example:

Supernode Utility input 2 is labeled **DF300** (delay OFF after 30.0 seconds). When Supernode Utility output 2 is turned ON then DF300 (Supernode Utility input 2) will turn ON and then turn OFF after 30.0 seconds.

Resolution: minimum 1 (0.1 seconds), maximum 9999 (999.9 seconds).

9.5.3. Delay OFF after transition

Delay OFF after transition causes the designated Supernode Utility input to turn ON after the associated Supernode Utility output is transitioned (ON to OFF or OFF to ON) and then turn OFF after designated delay time is met.

Example:

Supernode Utility input 2 is labeled **DB55** (delay OFF after transition after 5.5 seconds). When Supernode Utility output 2 is turned ON or OFF then DB55 (Supernode Utility input 2) will turn ON after 5.5 seconds.

Resolution: minimum 1 (0.1 seconds), maximum 9999 (999.9 seconds).

9.5.4. Delay OFF after minutes

Delay OFF after minutes causes the designated Supernode Utility (SNU) input to turn ON with the associated Supernode Utility (SNU) output and then turn OFF after the designated delay time.

Example:

Supernode Utility input 2 is labeled **DM60** (delay OFF after 60 minutes). When Supernode Utility output 2 is turned ON then DM60 (Supernode Utility input 2) will turn ON and then turn OFF after 60 minutes.

Resolution: minimum 1 minute, maximum 100 minutes.

 607 NW 27th Ave Ocala, FL 34475 Ph: 352-629-5020 or 1-800-533-3569 Fax: 352-629-2902 or 1-800-520-3473	TECHNICAL DATA SHEET			PAGE	20 of 46	
	PRODUCT GROUP	ES-KEY	P/N	119890 and 119891 w/ MODEM	DATE	2-2-2015
	PRODUCT	High Density I/O Node (SuperNode II)			REV	1.60
					BY	AMS

9.6. Bi-stable trigger

The Supernode has two bi-stable trigger functions (standard and power-up ON). The standard bi-stable trigger changes the state of a Supernode Utility input with the activation of the associated Supernode Utility output. The power-up bi-stable trigger turns ON when the Supernode is initialized and then acts the same as a standard bi-stable trigger. The naming syntax is BS (standard bi-stable) and BO (power-up ON bi-stable). Additional text should be added after the naming syntax to create unique identifiers.

9.6.1. Standard bi-stable trigger

A standard bi-stable trigger is created by using the ES-Key Professional software to name an input BS (bi-stable trigger naming syntax) in the Supernode Utility space.

Example:

Supernode Utility input 2 is labeled **BS Light1**. When Supernode Utility output 2 is turned ON then BS Light1 (Supernode Utility input 2) will change states.

9.6.2. Power-up ON bi-stable

A power-up ON bi-stable trigger is created by using the ES-Key Professional software to name an input BO (bi-stable power-up ON trigger naming syntax) in the Supernode Utility space.

Example:

Supernode Utility input 2 is labeled **BO Light2**. When Supernode Utility output 2 is turned ON then BO Light2 (Supernode Utility input 2) will change states.

9.7. Timer functions

The Supernode has four 1/10 hour timers. Each timer can be started/reset independently and can record a maximum of 16,666.6 hours. The timers only run when the vehicle power is applied and the associated timer run port is enabled. When the timer reaches the defined time limit its timer trigger will be activated.

The timer functions are created by using the ES-Key Professional software to name an input with the timer function naming syntax in the Supernode Utility (SNU) space.

9.7.1. Timer run

The timer run naming syntax consists of TA# (where TA = timer advance, and # = timer number 0, 1, 2, or 3).

Create a timer by naming a Supernode Utility input with TA#. When the associated Supernode Utility output is ON the timer will be advancing.

Example:

Supernode Utility input 2 is labeled **TA2** (timer advance number 2). When Supernode Utility output 2 is turned ON then timer 2 will be running.

9.7.2. Timer reset

The timer reset naming syntax consists of TR# (where TR = timer reset, and # = timer number 0, 1, 2, or 3). Create a timer reset function by naming a Supernode Utility input with TR#. When the associated Supernode Utility output is turned from OFF to ON the timer will be reset.

Example:

Supernode Utility input 3 is labeled **TR2** (timer reset number 2). When Supernode Utility output 3 is turned from OFF to ON then timer 2 will be reset. Reset only occurs at the transition from OFF to ON of the associated Supernode Utility output.

 607 NW 27th Ave Ocala, FL 34475 Ph: 352-629-5020 or 1-800-533-3569 Fax: 352-629-2902 or 1-800-520-3473	TECHNICAL DATA SHEET			PAGE	21 of 46	
	PRODUCT GROUP	ES-KEY	P/N	119890 and 119891 w/ MODEM	DATE	2-2-2015
	PRODUCT	High Density I/O Node (SuperNode II)			REV	1.60
					BY	AMS

9.7.3. Timer trigger

The timer trigger naming syntax consists of TT#,xxxx (where TT = timer trigger, # = timer number 0, 1, 2, or 3, and xxxx = trigger time). Create a timer trigger function by naming a Supernode Utility input with TT#,xxxx. When the associated timer has reached the designated time the Supernode Utility input will turn ON.

Example:

Supernode Utility input 4 is labeled **TT2,500** (timer trigger number 2 at 50.0 hours). When timer 2 reaches 50.0 hours the Supernode Utility input 4 will be turned ON.

Resolution: minimum 1 (0.1 hours), maximum 99999 (9999.9 hours).

9.8. Counter functions

The Supernode has four event counters. Each counter can be incremented, enabled, and reset independently and can record a maximum of 9999 events.

The counter functions are created by using the ES-Key Professional software to name an input with the counter function naming syntax in the Supernode Utility space.

9.8.1. Counter advance

The counter advance naming syntax consists of CA# (where CA = counter advance, and # = counter number 0, 1, 2, or 3). Create a counter by naming a Supernode Utility input with CA#. The counter will advance with the activation of the associated Supernode Utility output.

Example:

Supernode Utility input 2 is labeled **CA1** (counter advance number 1). When Supernode Utility output 2 is turned ON then counter 1 will increment once.

9.8.2. Counter reset

The counter reset naming syntax consists of CR# (where CR = counter reset, and # = counter number 0, 1, 2, or 3). Create a counter reset function by naming a Supernode Utility input with CR#. Turn the associated Supernode Utility output from OFF to ON to reset the counter.

Example:

Supernode Utility input 3 is labeled **CR1** (counter reset number 1). When Supernode Utility output 3 is toggled from OFF to ON then counter 1 will be reset. Reset only occurs at the transition from OFF to ON of the associated Supernode Utility output.

9.8.3. Counter trigger

The counter trigger naming syntax consists of CT#,xxxx (where CT = counter trigger, # = counter number 0, 1, 2, or 3, and xxxx = counter value). Create a counter trigger function by naming a Supernode Utility (SNU) input with CT#,xxxx. The Supernode Utility input set as the counter trigger will turn ON when the counter has reached the designated count value.

Example:

Supernode Utility input 4 is labeled **CT1,500** (counter trigger number 1 at 500 events). When counter 1 reaches 500 events the Supernode Utility input 4 will be turned ON.

Resolution: minimum 1 event, maximum 9999 events.

 607 NW 27th Ave Ocala, FL 34475 Ph: 352-629-5020 or 1-800-533-3569 Fax: 352-629-2902 or 1-800-520-3473	TECHNICAL DATA SHEET			PAGE	22 of 46	
	PRODUCT GROUP	ES-KEY	P/N	119890 and 119891 w/ MODEM	DATE	2-2-2015
	PRODUCT	High Density I/O Node (SuperNode II)			REV	1.60
					BY	AMS

9.9. Voltage trip points

The Supernode allows configuring of high and low voltage trip points. The voltage trip points are created by using the ES-Key Professional software to name an input with the voltage trip point naming syntax in the Supernode Utility space.

System voltage is evaluated from the voltage potential between pins 10 (supply +) and 20 (supply -).

Resolution: minimum 1 (0.1 volts), maximum 300 (30.0 volts).

9.9.1. High voltage trip point

The high voltage trip point naming syntax consists of VH### (where VH = voltage high, ### = voltage in tenths).

Create a high voltage trip point by naming a Supernode Utility input with VH###. The high voltage trip point Supernode Utility input will turn ON when the system voltage has exceeded the designated voltage level.

Example:

Supernode Utility input 2 is labeled **VH150** (voltage high at 15.0 volts), when the system voltage exceeds 15.0 volts the Supernode Utility input 2 will be turned on.

9.9.2. Low voltage trip point

The low voltage trip point naming syntax consists of VL### (where VL = voltage low, ### = voltage in tenths).

Create a low voltage trip point by naming a Supernode Utility input with VL###. The low voltage trip point Supernode Utility input will turn ON when the system voltage has dropped below the designated voltage level.

Example:

Supernode Utility input 2 is labeled **VL119** (voltage low at 11.9 volts). When the system voltage drops below 11.9 volts the Supernode Utility input 2 will be turned on.

9.10. Flash rate

The Supernode allows configuring of variable flash rates in ¼ second intervals. The flash rates are created by using the ES-Key Professional software to name an input with the flash rate naming syntax in the Supernode Utility space. The flash rate naming syntax consists of F### (where F = flash, and ### = rate in ¼ second increments). Create a flash rate by naming a Supernode Utility input with F###. The flash rate naming syntax is complete after a space is entered so other text can also be used to identify the input. For example, "F8 Warning Light" is a valid name.

The flash rate Supernode Utility input will flash at the designated rate when the associated Supernode Utility output is activated.

Example:

Supernode Utility input 2 is labeled **F8** (flash at rate 8). The Supernode Utility input 2 will toggle ON and OFF in 2 second intervals when Supernode Utility output 2 is activated.

Resolution: minimum 1 (0.25 seconds), maximum 9999 (2499.75 seconds).

[flash rate value X 0.25 = time in seconds - e.g. rate 8 X 0.25 = 2 seconds]

 607 NW 27th Ave Ocala, FL 34475 Ph: 352-629-5020 or 1-800-533-3569 Fax: 352-629-2902 or 1-800-520-3473	TECHNICAL DATA SHEET			PAGE	23 of 46
	PRODUCT GROUP	ES-KEY	P/N	119890 and 119891 w/ MODEM	DATE
PRODUCT	High Density I/O Node (SuperNode II)			REV	1.60
				BY	AMS

9.11. Sequencer function

A sequencer function is created by using the ES-Key Professional software to name an input with the sequencer naming syntax in the Supernode Utility space.

The sequencer naming syntax consists of S#,N (where S = sequence, # = number associated with the sequence [0-9], and N = the number of cycles to sequence through [2-9]).

Example:

Label Supernode Utility input 3 as **S0,4** (this states that sequence 0 has 4 steps to cycle through). Then create variable names **X1** and **X2** in the 2 successive inputs spaces (inputs 4 and 5). The three steps of the sequencer will be the inputs S0,4, X1, and X2. Create variables for the "sequencer control", and "sequencer force off" in the associated output space (in the below example named Seq 0 CONT and Seq 0 OFF). Toggling the Seq 0 CONT output causes the sequence to step, and turning Seq 0 OFF forces the configured inputs OFF and resets the sequence.

Resolution: minimum 2 steps, maximum 9 steps.

Inputs	S0,4	8.3	When Output 8.3 (in this example named 'Seq 0 CONT') is toggled from OFF to ON the input space sequences one step. The system initializes with the configured sequence steps all OFF			
	X1	8.4				
	X2	8.5	Seq 0 CONT (Output 8.3)	S0,4 (Input 8.3)	X1 (input 8.4)	X2 (input 8.5)
Outputs			First toggle	ON	OFF	OFF
Seq 0 CONT	8.3		Second toggle	OFF	ON	OFF
Seq 0 OFF	8.4		Third toggle	OFF	OFF	ON
			Fourth toggle	OFF	OFF	OFF
			Fifth toggle	ON	OFF	OFF

9.12. Oil pressure trip points

The Supernode allows configuring of high and low oil pressure trip points. The oil pressure trip points are created by using the ES-Key Professional software to name an input with the oil pressure trip point naming syntax in the Supernode Utility space. Engine oil pressure is received from the engine ECU via SAE J1939 PGN 65263.

Resolution: minimum 1 PSI, maximum 999 PSI.

9.12.1. High oil pressure trip point

The high oil pressure trip point naming syntax consists of OH### (where OH = oil pressure high, ### = pressure in PSI). Create a high oil pressure trip point by naming a Supernode Utility input with OH###. The high oil pressure trip point Supernode Utility input will turn ON when the system voltage exceeds the designated pressure level.

Example:

Supernode Utility input 2 is labeled **OH80** (oil pressure high when greater than 80 PSI). When the engine oil pressure exceeds 80 PSI the Supernode Utility input 2 will be turned ON.

 607 NW 27th Ave Ocala, FL 34475 Ph: 352-629-5020 or 1-800-533-3569 Fax: 352-629-2902 or 1-800-520-3473	TECHNICAL DATA SHEET			PAGE	24 of 46	
	PRODUCT GROUP	ES-KEY	P/N	119890 and 119891 w/ MODEM	DATE	2-2-2015
	PRODUCT	High Density I/O Node (SuperNode II)			REV	1.60
					BY	AMS

9.12.2. Low oil pressure trip point

The low oil pressure trip point naming syntax consists of OL### (where OL = oil pressure low, ### = pressure in PSI). Create a low oil pressure trip point by naming a Supernode Utility input with OL###. The low oil pressure trip point Supernode Utility input will turn ON when the engine oil pressure has dropped below the designated pressure level.

Example:

Supernode Utility input 2 is labeled **OL20** (oil pressure low when less than 20 PSI). When the engine oil pressure drops below 20 PSI the Supernode Utility input 2 will be turned ON.

9.13. Engine RPM trip points

The Supernode allows configuring of engine RPM trip points. The engine RPM trip points are created by using the ES-Key Professional software to name an input with the engine RPM trip point naming syntax in the Supernode Utility space. The engine RPM trip point naming syntax consists of R#X## (where R = engine RPM, #### = engine RPM). Create an engine RPM trip point by naming a Supernode Utility input with R####. The engine RPM trip point Supernode Utility input will turn ON when the engine RPM reaches or exceeds the designated RPM level. Engine RPM is received from the engine ECU via SAE J1939 PGN 61444.

Example:

Supernode Utility input 2 is labeled **R2200** (RPM trip when greater than 2200 RPM). When the engine RPM increases above 2200 RPM the Supernode Utility input 2 will be turned ON.

Resolution: minimum 1 RPM, maximum 9999 RPM.

9.14. Water temperature trip points

The Supernode allows configuring of high and low water temperature trip points. The water temperature trip points are created by using the ES-Key Professional software to name an input with the water temperature trip point naming syntax in the Supernode Utility space.

Engine water temperature is received from the engine ECU via SAE J1939 PGN 65262.

Resolution: minimum 1 °F, maximum 999 °F.

9.14.1. High water temperature trip point

The high water temperature trip point naming syntax consists of TH### (where TH = water temperature high, ### = temperature in °F). Create a high water temperature trip point by naming a Supernode Utility input with TH###.

The high water temperature trip point Supernode Utility input will turn ON when the engine water temperature exceeds the designated temperature level.

Example:

Supernode Utility input 2 is labeled **TH250** (water temperature high when greater than 250 °F). When the engine water temperature exceeds 250 °F the Supernode Utility input 2 will be turned ON.

9.14.2. Low water temperature trip point

The low water temperature trip point naming syntax consists of TL### (where TL = water temperature low, ### = temperature in °F). Create a low water temperature trip point by naming a Supernode Utility input with TL###.

The low water temperature trip point Supernode Utility input will turn ON when the engine water temperature is less than the designated temperature level.

Example:

Supernode Utility input 2 is labeled **TL65** (water temperature low when less than 65 °F). When the engine water temperature falls below 65 °F the Supernode Utility input 2 will be turned ON.

 607 NW 27th Ave Ocala, FL 34475 Ph: 352-629-5020 or 1-800-533-3569 Fax: 352-629-2902 or 1-800-520-3473	TECHNICAL DATA SHEET			PAGE	25 of 46
	PRODUCT GROUP	ES-KEY	P/N	REV	DATE
			119890 and 119891 w/ MODEM	1.60	2-2-2015
	PRODUCT	High Density I/O Node (SuperNode II)		BY	AMS

9.15. Transmission high temperature trip point

The Supernode allows configuring of high transmission temperature trip point. The transmission temperature trip point is created by using the ES-Key Professional software to name an input with the transmission temperature trip point naming syntax in the Supernode Utility space.

Transmission temperature is received from the transmission ECU via SAE J1939 PGN 65272.

The high transmission temperature trip point naming syntax consists of TX### (where TX = transmission temperature high, ### = temperature in °F). Create a high transmission temperature trip point by naming a Supernode Utility input with TX###. The high transmission temperature trip point Supernode Utility input will turn ON when the transmission temperature exceeds the designated temperature level.

Example:

Supernode Utility input 2 is labeled **TX250** (transmission temperature high when greater than 250 °F). When the transmission temperature exceeds 250 °F the Supernode Utility input 2 will be turned ON.

Resolution: minimum 1 °F, maximum 999 °F.

9.16. Transmission gear indications.

The Supernode has four transmission gear indications (reverse, neutral, park, and forward gear). Transmission gear indications are received from the transmission control unit via SAE J1939 PGN 61445.

9.16.1. Transmission reverse indication

The transmission reverse indication is created by using the ES-Key Professional software to name an input RW (reverse warning) in the Supernode Utility space.

Example:

Supernode Utility input 2 is labeled **RW** (reverse warning). When the transmission is in the reverse gear the Supernode Utility input 2 will be turned ON.

9.16.2. Transmission neutral indication

The transmission neutral indication is created by using the ES-Key Professional software to name an input N (neutral) in the Supernode Utility space.

Example:

Supernode Utility input 2 is labeled **N** (neutral). When the transmission is in the neutral gear the Supernode Utility input 2 will be turned ON.

9.16.3. Transmission park indication

The transmission park indication is created by using the ES-Key Professional software to name an input TP (transmission park) in the Supernode Utility space.

Example:

Supernode Utility input 2 is labeled **TP** (transmission park). When the transmission is in the park gear the Supernode Utility input 2 will be turned ON.

9.16.4. Transmission forward gear indication

The transmission forward gear indication is created by using the ES-Key Professional software to name an input G## (Gear) in the Supernode Utility space (where ## is the desired forward gear, 01 to 99).

Example:

Supernode Utility input 2 is labeled **G09** (transmission forward gear 9). When the transmission is in 9th gear the Supernode Utility input 2 will be turned ON.

 607 NW 27th Ave Ocala, FL 34475 Ph: 352-629-5020 or 1-800-533-3569 Fax: 352-629-2902 or 1-800-520-3473	TECHNICAL DATA SHEET			PAGE	26 of 46	
	PRODUCT GROUP	ES-KEY	P/N	119890 and 119891 w/ MODEM	DATE	2-2-2015
	PRODUCT	High Density I/O Node (SuperNode II)			REV	1.60
					BY	AMS

9.17. Engine wait to start warning

The engine wait to start warning is created by using the ES-Key Professional software to name an input WS (wait to start) in the Supernode Utility space.

Example:

Supernode Utility input 2 is labeled **WS** (wait to start). When the warning is received from the engine ECU via SAE J1939 PGN 65252 Supernode Utility input 2 will be turned ON.

9.18. Engine water in fuel warning

The engine water in fuel warning is created by using the ES-Key Professional software to name an input WF (water in fuel) in the Supernode Utility space.

Example:

Supernode Utility input 2 is labeled **WF** (water in fuel). When the warning is received from the engine ECU via SAE J1939 PGN 65279 Supernode Utility input 2 will be turned ON.

9.19. Parking Brake indication

The Park Brake indication is created by using the ES-Key Professional software to name an input PB (Park Brake) in the Supernode Utility space.

Example:

Supernode Utility input 2 is labeled **PB** (park brake). When the warning is received from the engine ECU via SAE J1939 PGN 65265 Supernode Utility input 2 will be turned ON.

9.20. Service Brake indication

The Service Brake indication is created by using the ES-Key Professional software to name an input SB (Service Brake) in the Supernode Utility space.

Example:

Supernode Utility input 2 is labeled **SB** (service brake). When the service brake (foot brake) status ON is received from the engine ECU via SAE J1939 PGN 65265 Supernode Utility input 2 will be turned ON.

9.21. Vehicle Speed trip point

A Vehicle Speed trip point is created by using the ES-Key Professional software to name an input M### (MPH) in the Supernode Utility space. The port becomes active when the vehicle speed exceeds the value in the ### place holder (mph).

Example:

Supernode Utility input 2 is labeled **M55** (speed greater than 55 MPH). When the vehicle speed received from the engine ECU via SAE J1939 PGN 65265 is greater than 55 MPH Supernode Utility input 2 will be turned ON.

Resolution: minimum 1 MPH, maximum 999 MPH.

9.22. Output PWM control

The Supernode allows individual control over the PWM value of outputs 10-17. A special PWM value is created by using the ES-Key Professional software to name an input P#,XXX in the Supernode Utility space where # is the desired output channel (0-7, or A for all) and the XXX is the desired PWM value in percent.

Note: if a PA,XXX is used then P#,XXX values cannot be used.

Example:

Supernode Utility input 2 is labeled **P3,35** (PWM channel 3 set to 35%). When the Supernode Utility output 2 is ON and Supernode Output Space 59 (PWM output 13) is ON then physical output 13 will be ON at 35% PWM dutycycle.

Resolution: minimum 1 % dutycycle, maximum 100 % dutycycle.

 607 NW 27th Ave Ocala, FL 34475 Ph: 352-629-5020 or 1-800-533-3569 Fax: 352-629-2902 or 1-800-520-3473	TECHNICAL DATA SHEET			PAGE	27 of 46	
	PRODUCT GROUP	ES-KEY	P/N	119890 and 119891 w/ MODEM	DATE	2-2-2015
	PRODUCT	High Density I/O Node (SuperNode II)			REV	1.60
					BY	AMS

9.23. Output PWM dimming function

The Supernode allows each PWM channel to ramp up and down to its PWM value. A PWM dim function is created by using the ES-Key Professional software to name an input PD# in the Supernode Utility (SNU) space where # is the desired output channel (0-7, or A for all). When this space is activated the associated PWM channel will ramp up to its PWM value in approximately six seconds when the PWM channel is turned ON and the associated PWM channel will ramp down from its PWM value to OFF in approximately six seconds when the PWM channel is turned OFF.

Note: if a PDA is used then PD# values cannot be used.

Example:

Supernode Utility input 2 is labeled **PD3** (PWM dimming for channel 3). When the Supernode Utility output 2 is ON and Supernode Output Space 59 (PWM output 13) is turned ON then physical output 13 will be ramp up to its PWM dutycycle value in approximately six seconds. If Supernode Utility output 2 is OFF then PWM dimming is not enabled.

9.24. Check module status function

The Supernode allows the status of a module to be verified. A check module status function is created by using the ES-Key Professional software to name an input **CM D A** in the Supernode Utility (SNU) space where **D** is the module type and **A** is the module address. When the designated module is offline the SNU input will be ON.

Example:

Supernode Utility input 2 is labeled **CM15** (check module device type 1 address 5). When Power Module address 5 is not transmitting on the CAN bus then Supernode Utility input 2 is ON.

Resolution:

Device Type	Description
1	Power Module
2	Input Module
3	Output Module
4	Input/Output Module
5	SPS Panel
6	Supernode
7	Special Module

Address	Description
0	Address 0
1	Address 1
2	Address 2
3	Address 3
4	Address 4
5	Address 5
6	Address 6
7	Address 7
8	Address 8
9	Address 9
A	Address 10
B	Address 11
C	Address 12
D	Address 13
E	Address 14
F	Address 15

9.25. Flip-Flop functions

The Supernode has two flip-flop trigger functions (SET and RESET). The naming syntax is FFA (Flip-Flop RESET) and FFB (Flip-Flop SET). The Supernode Utility input space named FFB is the flip-flop output and is controlled by the associated Supernode Utility outputs. Additional text should be added after the naming syntax to create unique identifiers.

9.25.1. Flip-Flop SET

Create a flip-flop SET by naming a Supernode Utility input with FFB. The flip-flop will turn ON with the activation of the associated Supernode Utility output.

Example:

Supernode Utility input 2 is labeled **FFB**. When Supernode Utility output 2 is turned ON then the flip-flop will turn ON (Supernode Utility input 2 turns ON).

 607 NW 27th Ave Ocala, FL 34475 Ph: 352-629-5020 or 1-800-533-3569 Fax: 352-629-2902 or 1-800-520-3473	TECHNICAL DATA SHEET			PAGE	28 of 46	
	PRODUCT GROUP	ES-KEY	P/N	119890 and 119891 w/ MODEM	DATE	2-2-2015
	PRODUCT	High Density I/O Node (SuperNode II)			REV	1.60
					BY	AMS

9.25.2. Flip-Flop RESET

Create a flip-flop RESET by naming a Supernode Utility input with FFA. The flip-flop will turn OFF with the activation of the associated Supernode Utility output.

Example:

Supernode Utility input 3 is labeled **FFA**. When Supernode Utility output 3 is turned ON then the flip-flop will turn OFF (Supernode Utility input 2 turns OFF).

 607 NW 27th Ave Ocala, FL 34475 Ph: 352-629-5020 or 1-800-533-3569 Fax: 352-629-2902 or 1-800-520-3473	TECHNICAL DATA SHEET			PAGE	29 of 46	
	PRODUCT GROUP	ES-KEY	P/N	119890 and 119891 w/ MODEM	DATE	2-2-2015
	PRODUCT	High Density I/O Node (SuperNode II)			REV	1.60
					BY	AMS

10. Utility Module

10.1. Adding a Utility Module to the ES-Key network database

The Supernode contains all of the standard utilities of the Universal System Manager (USM) for allowing unique operation. Section 10.2 contains a table which lists all of the Utilities available. These utilities are only available for a Supernode set to address 0.

The Utilities are available to the ES-Key network by adding a "Utility Module" with the ES-Key Professional software. The Utility Module is a virtual device that resides in the memory of the Supernode. A Supernode must be added to the network before a Utility Module can be added.

Add a Utility Module to the ES-Key network by right-clicking on "ES-Key Network", select "Add Device", and select "Utility Module". The Utility Module's input and output memory space is preloaded with most of the default functions.

10.2. Utility Module input memory space functions

The Utility module has 23 (0 through 12, 14 through 23) dedicated input memory space functions as described in the table below.

Function	Memory Space	Description
Flasher 2Hz	Input 0	Toggles at 2 Hz
Low voltage	Input 1	Turns ON when the voltage drops below 11.8V for more than 10 seconds
High idle request	Input 2	Turns ON when load management is enabled and voltage is 12.8V or less
System fault	Input 3	Turns ON when any system fault is reported
Toggle #1	Input 4	Toggles state based on output 4 (Toggle #1)
Toggle #2	Input 5	Toggles state based on output 5 (Toggle #2)
Delay #1 (3 seconds)	Input 6	Turns ON 3 seconds after output 6 (Delay #1) transitions from OFF to ON
1 second positive trigger	Input 7	Turns ON for 1 second after output 7 transitions from OFF to ON
1 second trigger	Input 8	Turns ON for 1 second after output 8 transitions from OFF to ON or ON to OFF
Delay #2 (5 seconds)	Input 9	Turns ON 5 seconds after output 9 (Delay #2) transitions from OFF to ON
Delay #3 (30 seconds)	Input 10	Turns ON 30 seconds after output 10 (Delay #3) transitions from OFF to ON
Delay #4 (5 seconds)	Input 11	Turns ON 5 seconds after output 11 (Delay #4) transitions from OFF to ON
8 second positive trigger	Input 12	Turns ON for 8 seconds after output 12 transitions from OFF to ON
Toggle #4	Input 14	Toggles state based on output 14 (Toggle #4)
Toggle #5	Input 15	Toggles state based on output 15 (Toggle #5)
Toggle #6	Input 16	Toggles state based on output 16 (Toggle #6)
Toggle #7	Input 17	Toggles state based on output 17 (Toggle #7)
Toggle #8	Input 18	Toggles state based on output 18 (Toggle #8)
Toggle #9	Input 19	Toggles state based on output 19 (Toggle #9)
Delay #5 (3 seconds)	Input 20	Turns ON 3 seconds after output 20 (Delay #5) transitions from OFF to ON
Delay #6 (5 seconds)	Input 21	Turns ON 5 seconds after output 21 (Delay #6) transitions from OFF to ON
Delay #7 (30 seconds)	Input 22	Turns ON 30 seconds after output 22 (Delay #7) transitions from OFF to ON
Delay #8 (600 seconds)	Input 23	Turns ON 600 seconds after output 23 (Delay #8) transitions from OFF to ON

Shaded inputs are related to load management functions.

 607 NW 27th Ave Ocala, FL 34475 Ph: 352-629-5020 or 1-800-533-3569 Fax: 352-629-2902 or 1-800-520-3473	TECHNICAL DATA SHEET			PAGE	30 of 46	
	PRODUCT GROUP	ES-KEY	P/N	119890 and 119891 w/ MODEM	DATE	2-2-2015
	PRODUCT	High Density I/O Node (SuperNode II)			REV	1.60
					BY	AMS

10.3. Utility Module output memory space functions

The Utility module has 24 (0 through 23) dedicated output memory space functions as described in the table below.

Function	Memory Space	Description
High idle cancel	Output 0	Forces a cancel of the high idle request (input 2)
Enable load management	Output 1	Enables all load management functions
Mode switch	Output 2	Enables secondary mode of the load management system
Stage switch	Output 3	Enables secondary stage of the load management system
Toggle #1	Output 4	Each OFF to ON transition changes the state of input 4 (Toggle #1)
Toggle #2	Output 5	Each OFF to ON transition changes the state of input 5 (Toggle #2)
Delay #1	Output 6	Each OFF to ON transition activates input 6 (Delay #1)
1 second positive trigger	Output 7	Each OFF to ON transition activates trigger of input 7 (1 second positive trigger)
1 second trigger	Output 8	Each OFF to ON transition activates trigger of input 8 (1 second trigger)
Delay #2 (5 seconds)	Output 9	Each OFF to ON transition activates input 9 (Delay #2)
Delay #3 (30 seconds)	Output 10	Each OFF to ON transition activates input 10 (Delay #3)
Delay #4 (5 seconds)	Output 11	Each OFF to ON transition activates input 11 (Delay #4)
8 second positive trigger	Output 12	Each OFF to ON transition activates trigger of input 12 (8 second trigger)
24 Volt load management	Output 13	Set the load management system to 24V values rather than 12V values
Toggle #4	Output 14	Each OFF to ON transition changes the state of input 14 (Toggle #4)
Toggle #5	Output 15	Each OFF to ON transition changes the state of input 15 (Toggle #5)
Toggle #6	Output 16	Each OFF to ON transition changes the state of input 16 (Toggle #6)
Toggle #7	Output 17	Each OFF to ON transition changes the state of input 17 (Toggle #7)
Toggle #8	Output 18	Each OFF to ON transition changes the state of input 18 (Toggle #8)
Toggle #9	Output 19	Each OFF to ON transition changes the state of input 19 (Toggle #9)
Delay #5 (3 seconds)	Output 20	Each OFF to ON transition activates input 20 (Delay #5)
Delay #6 (5 seconds)	Output 21	Each OFF to ON transition activates input 21 (Delay #6)
Delay #7 (30 seconds)	Output 22	Each OFF to ON transition activates input 22 (Delay #7)
Delay #8 (600 seconds)	Output 23	Each OFF to ON transition activates input 23 (Delay #8)

Shaded outputs are related to load management functions.

 607 NW 27th Ave Ocala, FL 34475 Ph: 352-629-5020 or 1-800-533-3569 Fax: 352-629-2902 or 1-800-520-3473	TECHNICAL DATA SHEET			PAGE	31 of 46	
	PRODUCT GROUP	ES-KEY	P/N	119890 and 119891 w/ MODEM	DATE	2-2-2015
	PRODUCT	High Density I/O Node (SuperNode II)			REV	1.60
					BY	AMS

11. Universal System Manager Functions

A Supernode II configured as address 0 will also function as the ES-Key system Universal System Manager (USM) as long as a standard (stand-alone) ES-Key USM is not in the physical network.

11.1. Load management enabling and functions

The Supernode can be used as a load manager by implementing a Utility Module. Enable the load management function by activating output memory space 1 of the Utility Module (see section 10.3). There are five basic processes of the load management system: *operating mode*, *stage switch*, *priority*, *sequence level*, and *high idle*.

11.1.1. Operating modes

The Supernode load management allows two operating modes: mode A and mode B. Mode A is the default operating mode but mode B can be selected by activating output memory space 2 of the Utility Module (see section 10.3). Any output in the ES-Key database can be tied to one or both of the operating modes by checking the desired mode in its “Output Port Load Settings” under the “Settings” tab.

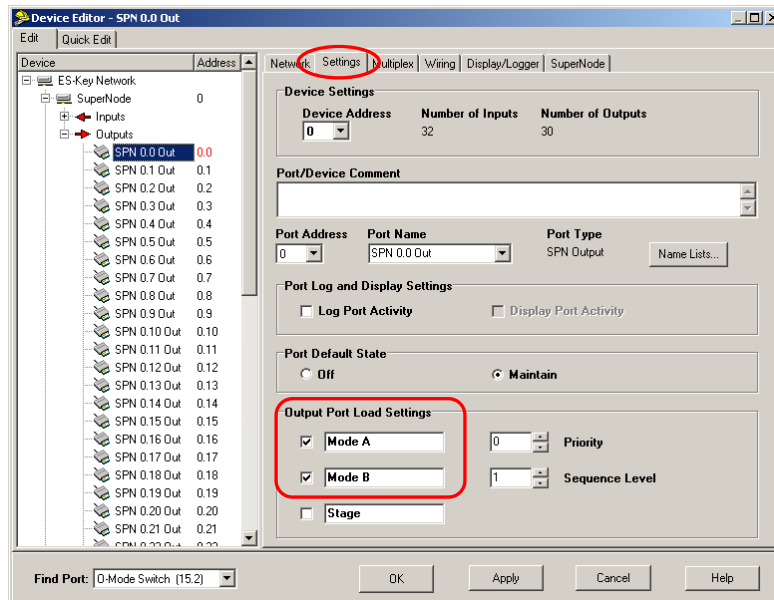

When an output is tied to both operating modes then the state of the mode switch is not important to the state of the output. However, if an output is tied to just one operating mode then the state of the output is controlled by the state of the mode switch as well as its normal multiplexing equation.

The names of the operating modes can be changed from the standard “modeA/modeB” to anything desired by modifying the text in the “Output Port Load Settings” area. On fire apparatus, mode A is typically referred to as “response” and mode B is typically referred to as “scene”.

 607 NW 27th Ave Ocala, FL 34475 Ph: 352-629-5020 or 1-800-533-3569 Fax: 352-629-2902 or 1-800-520-3473	TECHNICAL DATA SHEET			PAGE	32 of 46	
	PRODUCT GROUP	ES-KEY	P/N	119890 and 119891 w/ MODEM	DATE	2-2-2015
	PRODUCT	High Density I/O Node (SuperNode II)			REV	1.60
					BY	AMS

11.1.2. Stage switch (master switch)

All outputs can be tied or not tied to the stage switch. In fire apparatus this switch is typically referred to as the master switch. The state of the stage switch is controlled by Utility Module output memory space 3. When this output is active the stage switch is active. Any output tied to the stage switch will be OFF if the stage switch is not active regardless of the output's multiplex equation.

Set an output's to be tied to the stage switch by checking the stage switch box in its "Output Port Load Settings" under the "Settings" tab.

The name of the stage switch can be changed from the standard "stage" to anything desired by modifying the text in the "Output Port Load Settings" area.

11.1.3. Priority

Priority refers to the shed and unshed level to which the output is tied. There are eight (8) priority levels (0 through 7) which indicate the voltage level required to turn OFF (shed) or turn ON (unshed) the output in response to changes in the vehicles system voltage level. Any output in the ES-Key database can be tied to one of the eight priority levels in its "Output Port Load Settings" under the "Settings" tab.

Priority	12 Volt system		24 Volt system	
	Shed voltage	Unshed voltage	Shed voltage	Unshed voltage
7	< 12.8V	> 12.7V	< 25.5V	> 25.4V
6	< 12.7V	> 12.6V	< 25.3V	> 25.2V
5	< 12.5V	> 12.4V	< 24.9V	> 24.8V
4	< 12.3V	> 12.2V	< 24.5V	> 24.4V
3	< 12.1V	> 12.0V	< 24.1V	> 24.0V
2	< 11.9V	> 11.8V	< 23.7V	> 23.6V
1	< 11.5V	> 11.3V	< 22.9V	> 22.8V
0	Never shed	----	Never shed	----

A. LOAD SHEDDING

An output is shed (turned OFF) when the system voltage drops below the designated priority level's shed voltage for thirty (30) seconds. If the voltage has dropped below multiple priority level shed voltages then each higher priority level will shed before the lower priority levels. For example, if the voltage was at 13.9 volts and then fell rapidly to 12.4 volts, after 30 seconds all outputs at priority level 7 will shed, then 30 seconds later all outputs at priority level 6 will shed, and 30 seconds later all outputs at priority level 5 will shed.

B. LOAD UNSHEDDING

An output is unshed (turned back ON) when the system voltage rises above the designated priority level's unshed voltage for ten (10) seconds. If the voltage has risen above multiple priority level unshed voltages then each lower priority level will unshed before the upper priority levels. For example, if the voltage was at 12.4 volts and then rose rapidly to 13.9 volts, after 10 seconds all outputs at priority level 5 will unshed, then 10 seconds later all outputs at priority level 6 will unshed, and 10 seconds later all outputs at priority level 7 will unshed.

C. LOAD MANAGEMENT VOLTAGE RANGE

The load management voltage range can be set to 12 volts (default) or 24 volts. Nothing needs to be done to use the 12 volt shed/unshed ranges. To set the system to use the 24 volt shed/unshed ranges the Utility Module memory output space 13 (24 volt load management) must be activated (see section 10.3).

 607 NW 27th Ave Ocala, FL 34475 Ph: 352-629-5020 or 1-800-533-3569 Fax: 352-629-2902 or 1-800-520-3473	TECHNICAL DATA SHEET			PAGE	33 of 46	
	PRODUCT GROUP	ES-KEY	P/N	119890 and 119891 w/ MODEM	DATE	2-2-2015
	PRODUCT	High Density I/O Node (SuperNode II)			REV	1.60
					BY	AMS

11.1.4. Sequence level

Outputs can be tied to one of 4 sequence levels (1 through 4). When the output is turned ON due to its association with an operating mode (mode A, mode B) all outputs on sequence level 1 are turned ON first, then a half second later all outputs on sequence level 2 are turned ON, then a half second later all outputs on sequence level 3 are turned ON, and finally a half second later all outputs on sequence level 4 are turned ON. The reverse is true when the associated operating mode is turned OFF.

11.1.5. High idle

The Utility Module's high idle request (input memory space 2) is activated when the system voltage drops below the high idle threshold (12.8 volts standard or 25.6 volts if 24 volt load management is enabled) for 8 seconds or longer **AND** load management has been enabled (Utility Module output memory space 1 is active). The high idle request will remain active as long as the voltage remains below the voltage threshold and for 3 minutes after the system voltage rises above the voltage threshold. High idle can be canceled by activating the Utility Module's high idle cancel (output memory space 0).

 607 NW 27th Ave Ocala, FL 34475 Ph: 352-629-5020 or 1-800-533-3569 Fax: 352-629-2902 or 1-800-520-3473	TECHNICAL DATA SHEET			PAGE	34 of 46	
	PRODUCT GROUP	ES-KEY	P/N	119890 and 119891 w/ MODEM	DATE	2-2-2015
	PRODUCT	High Density I/O Node (SuperNode II)			REV	1.60
					BY	AMS

12. Data Logger Function

The Supernode II contains all of the standard features of an ES-Key Data Logger.

- Capture events and faults
- Time set and transmission
- Upload/download of events and header data

13. MODEM function (available with p/n 119891 only)

The Supernode II (p/n 119891 only) contains all of the standard features of an ES-Key MODEM.

13.1. MODEM wiring

Connect the integrated MODEM to the phone line by properly wiring the MODEM TIP (pin 31 of the 40-pin connector) and the MODEM RING (pin 21 of the 40-pin connector) to a RJ11 connector.

13.2. MODEM usage

The MODEM is utilized by “dialing” into the system with the ES-Key Professional software. The MODEM operates at 4800 baud.

- Click on the “System” menu item and then select “COM Port Selection” to configure the port for MODEM operation. The *Configure Port* window will open.
- Click the “Modem” radio button in the **Connection Type** section.
- Select the available modem from the **Select Communications Port** drop down menu.
- Enter the phone number of the phone line to which the Supernode MODEM is connected.
- Click the “OK” button to begin communications.

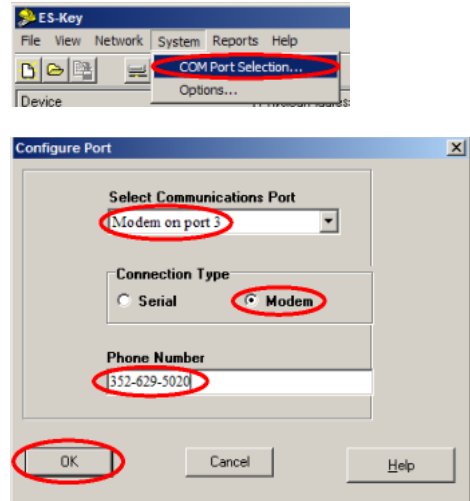

 607 NW 27th Ave Ocala, FL 34475 Ph: 352-629-5020 or 1-800-533-3569 Fax: 352-629-2902 or 1-800-520-3473	TECHNICAL DATA SHEET			PAGE	35 of 46	
	PRODUCT GROUP	ES-KEY	P/N	119890 and 119891 w/ MODEM	DATE	2-2-2015
	PRODUCT	High Density I/O Node (SuperNode II)			REV	1.60
					BY	AMS

14. Seat Belt Warning System

14.1. Seat Belt Warning ES-Key Setup Interface

Up to 20 seats/belts inputs can be configured in the system. In configuring the ES-Key interface the Input and Output Port Names **MUST** be Spelled **EXACTLY** as seen below. Only configure the number of seats for your application you do not have to configure all 20 seats and 20 belts. The inputs can be used on any device with inputs within your database.

Seat, Belt, Seat Alarm, and Park Brake inputs/outputs **MUST** be named as follows with no spaces between words:

Input	Description
Seat01	Seat 1 input
Seat02	Seat 2 input
Seat03	Seat 3 input
Seat04	Seat 4 input
Seat05	Seat 5 input
Seat06	Seat 6 input
Seat07	Seat 7 input
Seat08	Seat 8 input
Seat09	Seat 9 input
Seat10	Seat 10 input
Seat11	Seat 11 input
Seat12	Seat 12 input
Seat13	Seat 13 input
Seat14	Seat 14 input
Seat15	Seat 15 input
Seat16	Seat 16 input
Seat17	Seat 17 input
Seat18	Seat 18 input
Seat19	Seat 19 input
Seat20	Seat 20 input
PARKBRAKE	Park brake input

Input	Description
Belt01	Belt 1 input
Belt02	Belt 2 input
Belt03	Belt 3 input
Belt04	Belt 4 input
Belt05	Belt 5 input
Belt06	Belt 6 input
Belt07	Belt 7 input
Belt08	Belt 8 input
Belt09	Belt 9 input
Belt10	Belt 10 input
Belt11	Belt 11 input
Belt12	Belt 12 input
Belt13	Belt 13 input
Belt14	Belt 14 input
Belt15	Belt 15 input
Belt16	Belt 16 input
Belt17	Belt 17 input
Belt18	Belt 18 input
Belt19	Belt 19 input
Belt20	Belt 20 input

Output	Description
SEATALARM	Seat violation alarm

14.2. Seat and Belt input configuration

Each of the Seat and Belt inputs can be set for normally open (default) or normally closed type inputs. Open the device editor in ES-Key Pro and right click and select "Assign VDR Ports...". Each Seat and Belt position has a "Normally Closed" check box associated. The data base must be uploaded to the Supernode II using a flex file transfer for the configuration to be updated and saved.

 607 NW 27th Ave Ocala, FL 34475 Ph: 352-629-5020 or 1-800-533-3569 Fax: 352-629-2902 or 1-800-520-3473	TECHNICAL DATA SHEET			PAGE	36 of 46	
	PRODUCT GROUP	ES-KEY	P/N	119890 and 119891 w/ MODEM	DATE	2-2-2015
	PRODUCT	High Density I/O Node (SuperNode II)			REV	1.60
					BY	AMS

14.3. Seat Belt Warning displays

The Supernode II Seatbelt system works with the small and large seat belt displays.



p/n 118620
Seat Belt Warning Display (small)



p/n 118551, p/n 119375
Seat Belt Warning Display (large)

14.4. Seat and Seat Belt detection overview

The Seat Belt Warning system is designed to detect when a seat is occupied and when its associated seat belt is buckled correctly. The Seat Belt Warning system recognizes five (5) distinct seat/seat belt conditions: not occupied, occupied and buckled, seat belt violation, buckled and not occupied, and sequence violation.

The chart below describes the conditions with the associated alarm and indications.

(RED = negative indication, GRN = affirmative indication).

TYPE	CONDITION	DESCRIPTION	INDICATION		
			SEAT ALARM	RED	GRN
Valid	Not occupied	Seat is NOT occupied and associated seat belt is NOT buckled.			
Valid	Occupied and buckled	Seat is occupied and THEN the associated seat belt is buckled.			●
Error	Seat belt violation	Seat is occupied BUT the associated seat belt is NOT buckled.	●	●	
Error	Buckled and not occupied	Seat belt is buckled BUT the associated seat is not occupied.	●	●	
Error	Sequence violation	Seat belt is buckled and THEN the associated seat is occupied.	●	●	

Note: The seat alarm output will only sound when the park brake input is not active



The Seat Belt Warning system is designed to detect safe and unsafe conditions for seated occupants. The system cannot defend against tampering with the seat or seat belt switches, system modules, or intentional manipulation of the seat and seat belt activations to circumvent safe operation. Class 1 cannot be held responsible in these circumstances.

14.5. Sequence violation during power on cycle

The Seat Belt Warning system will indicate a *sequence violation* for a seat position if the seat is occupied and buckled before the input module power on cycle. This is due to the fact that the Seat Belt Warning system cannot determine the order of seat/seat belt activation and therefore assumes the worst case scenario (seat belt was pre-buckled and occupant sits on top of seat belt).

 607 NW 27th Ave Ocala, FL 34475 Ph: 352-629-5020 or 1-800-533-3569 Fax: 352-629-2902 or 1-800-520-3473	TECHNICAL DATA SHEET			PAGE	37 of 46	
	PRODUCT GROUP	ES-KEY	P/N	119890 and 119891 w/ MODEM	DATE	2-2-2015
	PRODUCT	High Density I/O Node (SuperNode II)			REV	1.60
					BY	AMS

14.6. “Seat bounce” error validation

The seat inputs have a special two second bounce timer. This is designed to prevent the system from reporting a “*buckled and not occupied* error” when a buckled occupant removes pressure from the seat’s occupant detection switch. This could occur if an occupant adjusts their body or the vehicle encounters a bump during operation.

The system will report a *buckled and not occupied* error if a buckled occupant removes pressure from the seat’s occupant detection switch for longer than two seconds (the “seat bounce” error validation time).

14.7. Seat Belt Violation Alarm (SEATALARM)

The Supernode II will flash the designated seat alarm output at one second intervals when it receives a seat belt violation or sequence violation while the park brake input (see section 14.9) is turned OFF.

14.8. OEM Responsibility

The Supernode II must be properly powered and connected to the associated CAN buses to record NFPA data correctly. It is the OEM’s responsibility to ensure that the Supernode II is connected properly and the potential for tampering is minimized.

14.9. Park Brake input (PARKBRAKE)

The Supernode II’s VDR and seat belt functionality will recognize the park brake input from one of three possible sources (in order of evaluation):

1. A standard input designated with the name “PARKBRAKE” as detailed in section 14.1.
2. A Supernode Utility configured for Park Brake (“PB”) as detailed in section 9.19.
3. A Vocation input named “Park Brake” (as is standard on a split-shaft Vocation).

15. Climate Control System

15.1. Climate Control System features

- Control of a vehicle’s air conditioning clutch
- Control of a vehicle’s heating valve
- Control of a vehicle’s fan motor speed
- Vehicle internal/external temperature

15.2. Using the Climate Control System

The Climate Control System within the Supernode II is designed for use with a Climate Control Display like the stand-alone climate display (p/n 120179) or a climate control enabled UltraView display.

 607 NW 27th Ave Ocala, FL 34475 Ph: 352-629-5020 or 1-800-533-3569 Fax: 352-629-2902 or 1-800-520-3473	TECHNICAL DATA SHEET			PAGE	38 of 46	
	PRODUCT GROUP	ES-KEY	P/N	119890 and 119891 w/ MODEM	DATE	2-2-2015
	PRODUCT	High Density I/O Node (SuperNode II)			REV	1.60
					BY	AMS

15.3. Climate Control System ES-Key Setup Interface

In configuring the ES-Key interface the Input and Output Port Names MUST be Spelled EXACTLY as seen below. Once the climate control outputs are entered into ES-Key Pro the next step is to upload the database. The Climate Control System in the SuperNode II will not be functional until all required outputs are designated.

Output	Output placement	Note
CCPOWER	Any output on any module in the database	Required
CCCLTCH	Any output on any module in the database	Required
CCVALVE	Any output on any module in the database	Required
CCMOTOR	Output 10-17* (PWM) on SuperNode 0. *Output 11 or 12 when paralleling with the second fan motor output	Required
CCMOTR2	Output 11 or 12 (PWM) on SuperNode 0.	Optional

15.4. Power Output (CCPOWER)

The power output is ON anytime the Climate Control System is enabled by the Climate Control Display.

15.5. Heat Valve Control Output (CCVALVE)

The heat valve control output is a digital output used to activate the vehicle's heating system when applicable.

15.6. Air Conditioning Clutch Output (CCCLTCH)

The air conditioning clutch output is a digital output used to activate the vehicle's A/C clutch when applicable.

15.7. Fan Motor Speed Output (CCMOTOR and CCMOTR2)

The fan motor speed output is a high current (13 Amps) positive polarity digital Pulse Width Modulated (PWM) output used to drive the vehicle's blower fan at variables speeds. If more current capability is required, the second fan motor output (CCMOTR2) can be paralleled with the first (CCMOTOR) to allow up to 26 Amps.

15.8. Temperature Sensor Inputs

The Climate Control System utilizes a Class 1 Temperature Sensor Module (p/n 122397) to determine the internal and external temperatures. The Temperature Sensor Module requires Analog Temperature Sensors (p/n 115722). The Climate Control System's embedded firmware on the Supernode II adjusts the fan speed and heat/cool operation based on the internal temperature detected while in the automatic mode of operation.

15.9. Automatic Mode

The Climate Control System receives the desired set temperature from a supported Climate Control Display and evaluates against the detected internal temperature. Software algorithms then set the appropriate fan speed PWM output and heat/cool output to maintain the desired temperature.

15.10. Manual Mode

The Climate Control System strictly uses the commands from a supported Climate Control Display when setting the heat/cool output and fan speed PWM output. In manual mode the Climate Control System does not attempt to maintain a certain temperature.

 607 NW 27th Ave Ocala, FL 34475 Ph: 352-629-5020 or 1-800-533-3569 Fax: 352-629-2902 or 1-800-520-3473	TECHNICAL DATA SHEET			PAGE	39 of 46	
	PRODUCT GROUP	ES-KEY	P/N	119890 and 119891 w/ MODEM	DATE	2-2-2015
	PRODUCT	High Density I/O Node (SuperNode II)			REV	1.60
					BY	AMS

16. Vehicle Data Recorder System

16.1. Vehicle Data Recorder features

- Utilizes the SAE J1939 CAN standard to record NFPA required data.
- Retains the last 100 hours of stored data in memory (saved in one second intervals).
- Internal real-time clock with 10 year battery back-up.

The Vehicle Data Recorder (VDR) saves the timestamp, engine speed (RPM), throttle position (%), vehicle speed (mph), vehicle acceleration/deceleration (mph), ABS status, seat belt status (seats 1-20), J1939 CAN error, Master switch state, and Parke Brake state every second as long as engine speed is greater than 500 RPM. If the engine speed is not greater than 500 RPM the VDR will save data once every 15 minutes.

16.2. Master Switch input

The VDR will log the master switch state when a database input is named "MWSWITCH".

16.3. Vehicle Data Recorder software

Configuration of the Vehicle Data Recorder module requires installation of the VDR Viewer II Data Management software.

16.3.1. Vehicle Data Recorder configuration using the VDR Viewer II Data Management software

The Vehicle Data Recorder in the Supernode II must be initially configured for accurate operation.

- **VDR identification parameters.**
 - Fire department's name
 - Vehicle identification number (VIN)
 - Apparatus ID
 - Comments for data identification purposes

Read the VDR Viewer II Data Management software manual for instructions on configuring the Vehicle Data Recorder.

16.3.2. Vehicle Data Recorder information retrieval

The Vehicle Data Recorder's saved data is retrieved and viewed using the VDR Viewer II Data Management software. The Supernode II's USB port must be connected to the computer running the VDR Viewer II Data Management software.

 607 NW 27th Ave Ocala, FL 34475 Ph: 352-629-5020 or 1-800-533-3569 Fax: 352-629-2902 or 1-800-520-3473	TECHNICAL DATA SHEET			PAGE	40 of 46	
	PRODUCT GROUP	ES-KEY	P/N	119890 and 119891 w/ MODEM	DATE	2-2-2015
	PRODUCT	High Density I/O Node (SuperNode II)			REV	1.60
					BY	AMS

16.4. Passwords

The VDR has three levels of password: Factory, OEM, and User. The passwords for the OEM and User may be modified using the VDR Viewer II Data Management software. The default passwords are:

- OEM - 12345678
- User - 12345678

A password can be a maximum of 127 characters long. Factory level allows access/modifications to all areas of the VDR.

Function	Minimum password level required
Get Fire Department Name	None
Get Vehicle ID	None
Get Comment	None
Get Apparatus ID	None
Get GMT Offset	None
Get VDR data log	User
Set User Password	User
Set Fire Department Name	OEM
Set Vehicle ID	OEM
Set Comment	OEM
Set Apparatus ID	OEM
Set GMT Offset	OEM
Set OEM Password	OEM
Clear VDR log	Factory
Clear User Data (Dept name, Veh ID, etc)	Factory



607 NW 27th Ave
Ocala, FL 34475
Ph: 352-629-5020 or 1-800-533-3569
Fax: 352-629-2902 or 1-800-520-3473

TECHNICAL DATA SHEET

PAGE 41 of 46

DATE 2-2-2015

PRODUCT GROUP ES-KEY P/N 119890 and 119891 w/ MODEM

REV 1.60

PRODUCT **High Density I/O Node (SuperNode II)**

BY AMS

17. USB port

The Supernode II's USB port allows database transfers, VDR data transfers, and diagnostics with the ES-Key Professional software.

Use a USB A (male) to USB A (male) cable to connect the Supernode II's USB port to a computer running the ES-Key Professional software.

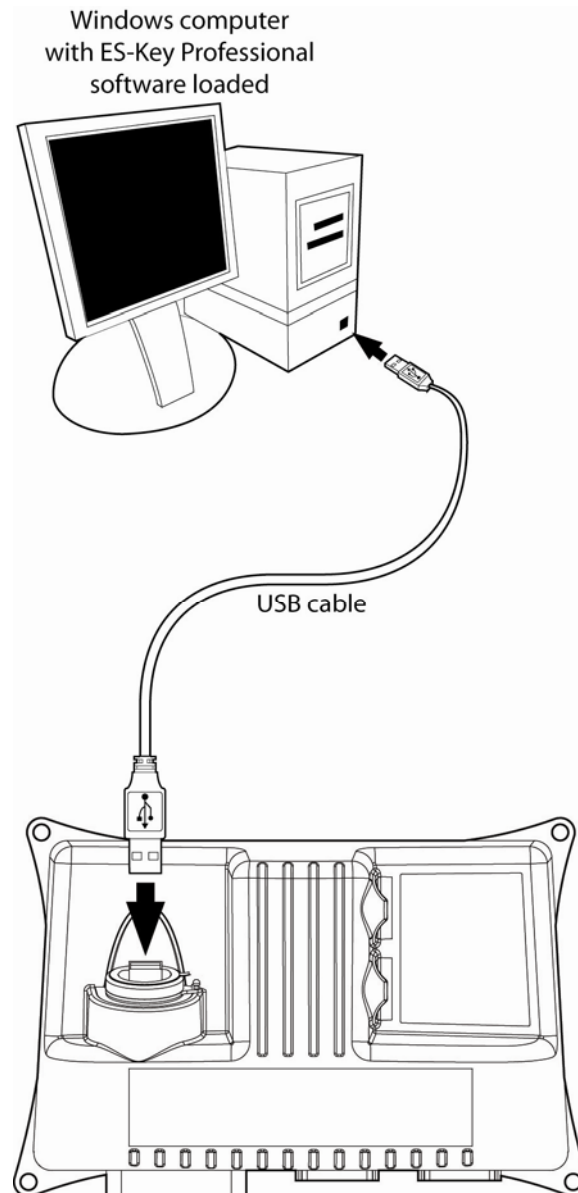

 607 NW 27th Ave Ocala, FL 34475 Ph: 352-629-5020 or 1-800-533-3569 Fax: 352-629-2902 or 1-800-520-3473	TECHNICAL DATA SHEET			PAGE	42 of 46	
	PRODUCT GROUP	ES-KEY	P/N	119890 and 119891 w/ MODEM	DATE	2-2-2015
	PRODUCT	High Density I/O Node (SuperNode II)			REV	1.60
					BY	AMS

18. Dimensions

The Supernode II is a water tight unit (IP67) and is mounted using four 1/4" or M6 screws.
 The overall dimensions are (W x H x D, inches [millimeters]) 11.06" [280.92] x 2.56" [65.02] x 7.31" [185.67].

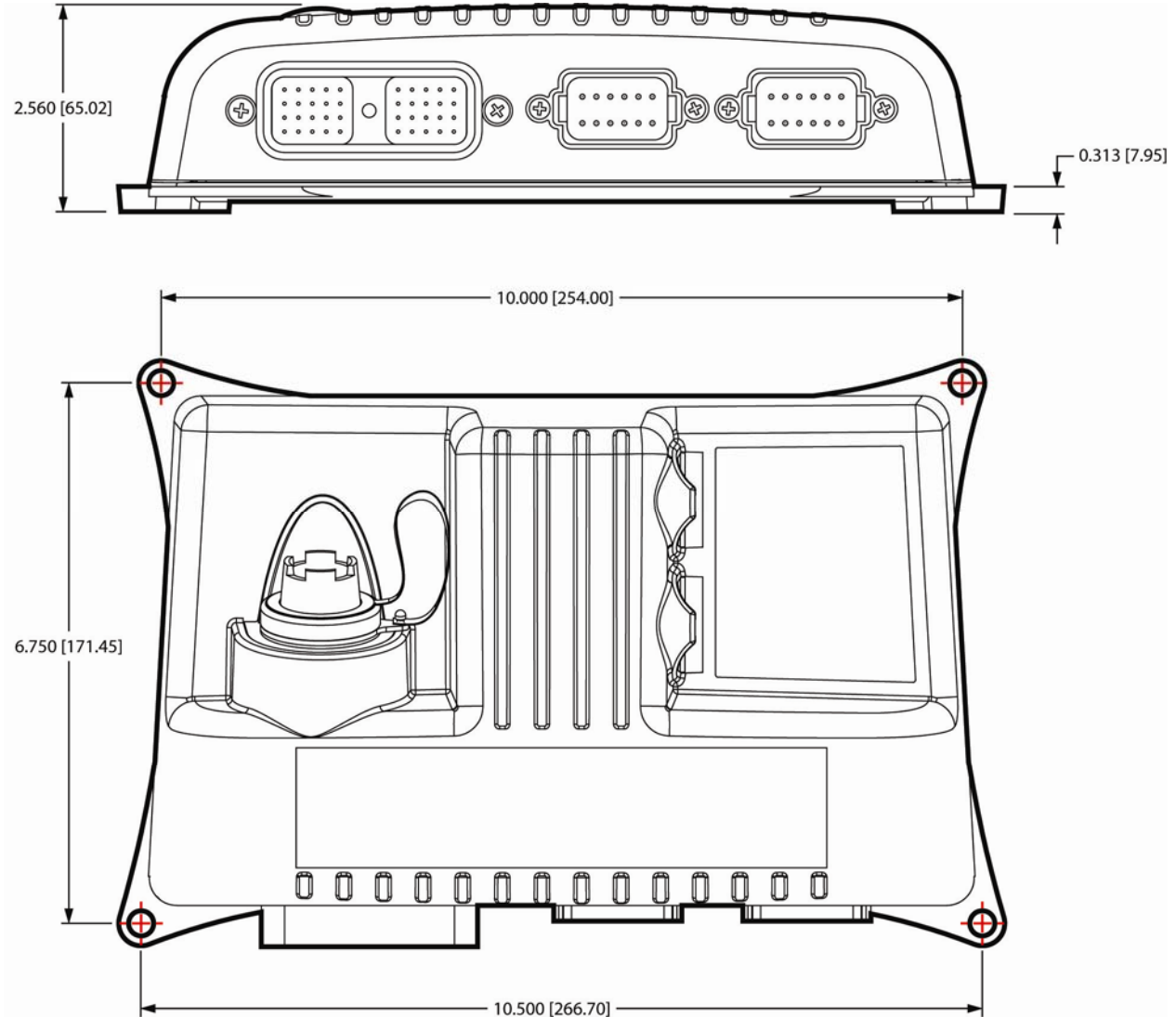

Dimensions in inches [millimeters].

 607 NW 27th Ave Ocala, FL 34475 Ph: 352-629-5020 or 1-800-533-3569 Fax: 352-629-2902 or 1-800-520-3473	TECHNICAL DATA SHEET			PAGE	43 of 46
	PRODUCT GROUP	ES-KEY	P/N	REV	DATE
	PRODUCT	High Density I/O Node (SuperNode II)		119890 and 119891 w/ MODEM	2-2-2015
				1.60	BY

19. Connector Descriptions

19.1. Outputs

All outputs are located on the two 12-pin Deutsch connectors (gray and black).

Mating connector:		Deutsch DT06-12SB BLACK	
Mating sockets:		0462-201-16141	
Wedge lock:		W12S Recommended wire gage: 16-18 AWG	
PIN	CIRCUIT	DESCRIPTION	FEATURES
1	Output 7	Positive output (13A max)	FLASH, DCB, OOLD
2	Output 1	Positive output (13A max)	FLASH, DCB, OOLD
3	Output 6	Positive output (13A max)	FLASH, DCB, OOLD
4	Output 5	Positive output (13A max)	FLASH, DCB, OOLD
5	Output 2	Positive output (13A max)	FLASH, DCB, OOLD
6	Output 3	Positive output (13A max)	FLASH, DCB, OOLD
7	Output 4	Positive output (13A max)	FLASH, DCB, OOLD
8	Output 8	Positive output (13A max)	FLASH, DCB, OOLD
9	Output 22	Ground output (2A max)	-
10	Output 23	Ground output (2A max)	-
11	Output 9	Positive output (13A max)	FLASH, DCB, OOLD
12	Output 0	Positive output (13A max)	FLASH, DCB, OOLD

Mating connector:		Deutsch DT06-12SA GRAY	
Mating sockets:		0462-201-16141	
Wedge lock:		W12S Recommended wire gage: 16-18 AWG	
PIN	CIRCUIT	DESCRIPTION	FEATURES
1	Output 17	Positive output (13A max)	FLASH, DCB, PWM
2	Output 11	Positive output (13A max)	FLASH, DCB, PWM
3	Output 16	Positive output (13A max)	FLASH, DCB, PWM
4	Output 15	Positive output (13A max)	FLASH, DCB, PWM
5	Output 12	Positive output (13A max)	FLASH, DCB, PWM
6	Output 14	Positive output (13A max)	FLASH, DCB, PWM
7	Output 13	Positive output (13A max)	FLASH, DCB, PWM
8	Output 18	Ground output (2A max)	-
9	Output 19	Ground output (2A max)	-
10	Output 20	Ground output (2A max)	-
11	Output 21	Ground output (2A max)	-
12	Output 10	Positive output (13A max)	FLASH, DCB, PWM

FLASH – output flashing capable, DCB – digital circuit breaker feature, DCB-SB – digital circuit breaker feature with slow blow, OOLD – output “open load” detection, PWM – output pulse width modulation (60% duty cycle)

19.2. Logic power, communications, and inputs

All inputs and communication lines are located on the 40-pin Deutsch connector. Main logic power is supplied to the Supernode II through the 40-pin Deutsch connector (pins 10 and 20).

Mating Connector:		Deutsch DRC26-40SA BLACK	
Mating sockets:		0462-201-20141	
		Recommended wire gage: 20-24 AWG	
PIN	CIRCUIT	DESCRIPTION	
1	Input 23	Digital input (selectable polarity)	
2	Input 21	Digital input (selectable polarity)	
3	Input 17	Digital input (selectable polarity)	
4	Input 13	Digital input (selectable polarity)	
5	Input 9	Digital input (selectable polarity)	
6	Input 5	Digital input (selectable polarity)	
7	Input 1	Digital input (selectable polarity)	
8	ADDR 1	Addressing input (ground polarity)	
9	CAN Low	ES-Key CAN	
10	Supply (+)	Module supply (+9VDC...+32VDC)	
11	Input 22	Digital input (selectable polarity)	
12	Input 20	Digital input (selectable polarity)	
13	Input 16	Digital input (selectable polarity)	
14	Input 12	Digital input (selectable polarity)	
15	Input 8	Digital input (selectable polarity)	
16	Input 4	Digital input (selectable polarity)	
17	Input 0	Digital input (selectable polarity)	
18	CAN Low	J1939 CAN	
19	CAN High	ES-Key CAN	
20	Supply (-)	Module supply (vehicle ground)	

PIN	CIRCUIT	DESCRIPTION
21	Modem ring	Modem communication
22	Input 19	Digital input (selectable polarity)
23	Input 15	Digital input (selectable polarity)
24	Input 11	Digital input (selectable polarity)
25	Input 7	Digital input (selectable polarity)
26	Input 3	Digital input (selectable polarity)
27	ADDR 3	Addressing input (ground polarity)
28	CAN High	J1939 CAN
29	CAN Shield	ES-Key CAN
30	SER GND	Serial communication
31	Modem tip	Modem communication
32	Input 18	Digital input (selectable polarity)
33	Input 14	Digital input (selectable polarity)
34	Input 10	Digital input (selectable polarity)
35	Input 6	Digital input (selectable polarity)
36	Input 2	Digital input (selectable polarity)
37	ADDR 2	Addressing input (ground polarity)
38	CAN Shield	J1939 CAN
39	SER TX	Serial communication
40	SER RX	Serial communication

 607 NW 27th Ave Ocala, FL 34475 Ph: 352-629-5020 or 1-800-533-3569 Fax: 352-629-2902 or 1-800-520-3473	TECHNICAL DATA SHEET			PAGE	44 of 46	
	PRODUCT GROUP	ES-KEY	P/N	119890 and 119891 w/ MODEM	DATE	2-2-2015
	PRODUCT	High Density I/O Node (SuperNode II)			REV	1.60
					BY	AMS

19.3. Driver power

Output driver power is supplied through the two power connectors (6 AWG wire recommended). Power connector A supplies power for outputs 0-9 and the power connector B supplies power for outputs 10-17.

Mating Connector:	Deutsch DTHD-06-1-4-S BLACK	
Mating sockets:	0462-203-04141	
	Recommended wire gage: 6 AWG	
CIRCUIT	DESCRIPTION	
DRIVER PWR A	Driver power for outputs 0-9	(+9VDC...+32VDC)
DRIVER PWR B	Driver power for outputs 10-17	(+9VDC...+32VDC)

Use power wires that are able to handle the maximum desired current:

- Maximum current on power stud 1 is 100 Amps (see Technical details in section 21).
- Maximum current on power stud 2 is 80 Amps (see Technical details in section 21).

 607 NW 27th Ave Ocala, FL 34475 Ph: 352-629-5020 or 1-800-533-3569 Fax: 352-629-2902 or 1-800-520-3473	TECHNICAL DATA SHEET			PAGE	45 of 46	
	PRODUCT GROUP	ES-KEY	P/N	119890 and 119891 w/ MODEM	DATE	2-2-2015
	PRODUCT	High Density I/O Node (SuperNode II)			REV	1.60
					BY	AMS

20. Diagnostic LEDs

The SuperNode has 58 LEDs located on its front panel. There are 6 LEDs for power and communication status, 4 LEDs for address indication, and 48 LEDs for output and input indications.

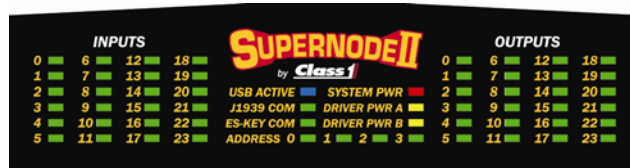

ES-Key COM LED	Description
ON solid	SuperNode online
Flashing slow (1 Hz)	CAN okay, not configured for network
Flashing fast (4 Hz)	CAN has physical problem

J1939 COM LED	Description
ON solid	Receiving J1939 data
Flashing	Not receiving J1939 data, configured
Flashing fast (4 Hz)	Not receiving J1939 data, not configured

Address 0 LED	Description
ON solid	Address 0 selected
OFF	Address 0 not selected
Flashing slow (1 Hz)	USM detects system fault
Flashing fast (4 Hz)	USM is not loaded with database

Address LEDs ON	Description
0	Address 0 selected
0 and 1	Address 0 selected, modem equipped (p/n 119891)
1	Address 1 selected
2	Address 2 selected
3	Address 3 selected

USB ACTIVE LED	Description
ON	USB port connected and ACTIVE
OFF	USB port not connected

INPUT LEDs	Description
ON	Input is ON
OFF	Input is OFF

OUTPUT LEDs	Description
ON	Output is ON
OFF	Output is OFF
Flashing	Output is in current limit condition

 607 NW 27th Ave Ocala, FL 34475 Ph: 352-629-5020 or 1-800-533-3569 Fax: 352-629-2902 or 1-800-520-3473	TECHNICAL DATA SHEET			PAGE	46 of 46	
	PRODUCT GROUP	ES-KEY	P/N	119890 and 119891 w/ MODEM	DATE	2-2-2015
	PRODUCT	High Density I/O Node (SuperNode II)			REV	1.60
					BY	AMS

21. Technical details

Product category	ES-Key network
Voltage range	+9VDC...+32VDC
Power consumption	Logic supply+ input (pin 10 of 40-pin Deutsch connector)
@ 13.8VDC	500mA
@ 27.6VDC	350mA
Output power	13A per positive polarity output 2A per ground polarity output
Temperature range	-40°C...+85°C
Environmental range	IP 67
CAN specification	SAE J1939 proprietary, 250 Kbits/second
LEDs	54 green LEDs, 1 red LED, 1 blue LED, and 2 yellow LEDs for output status, input status, , power status, and communication status
Protection	Internal thermal fuse (2500mA on pin 10 of 40-pin connector) Reverse voltage protection (pins 10 and 20 of 40-pin connector) CAN buses protected to 24V ESD voltage protected to SAE J1113 specification for heavy duty trucks (24V) Transient voltage protected to SAE J1113 specification for heavy duty trucks (24V) Load dump voltage protected to SAE J1113 specification for heavy duty trucks (24V) Outputs protected for short circuit and thermal overload
Dimensions (W x H x D) in inches [mm]	11.06 [280.92] x 2.56 [65.02] x 7.31 [185.67]