



**Class 1**

ISO 9001 CERTIFIED

---

607 NW 27th Ave  
Ocala, FL 34475  
Phone: (352) 629-5020 or 800-533-3569  
Fax: (352)-629-2902

SUITABLE FOR EXTERNAL DISTRIBUTION

## TECHNICAL PRODUCT DATASHEET

ES-KEY™

USM II (Universal Systems Manager)

P/N 122116



 <p>607 NW 27th Ave Ocala, FL 34475 Ph: 352-629-5020 or 1-800-533-3569 Fax : 352-629-290 or 1-800-520-3473</p>	<b>TECHNICAL DATA SHEET</b>				<b>PAGE</b>	2 OF 29	
	<b>PRODUCT GROUP</b>	<b>ES-KEY</b>	<b>P/N</b>	122116	<b>DATE</b>	7/18/2012	
<b>PRODUCT</b>	<b>USM II</b>			<b>REV</b>	1.10	<b>BY</b>	<b>BHS</b>

- 1. REVISION LOG..... 4**
- 2. MODULE OVERVIEW..... 5**
  - 2.1. FEATURES ..... 5
- 3. SELECTABLE POLARITY SOLID STATE OUTPUTS ..... 5**
- 4. SELECTABLE POLARITY DIGITAL INPUTS ..... 5**
- 5. ES-KEY NETWORK DETAIL ..... 6**
  - 5.1. ADDING A SYSTEM MANAGER TO THE ES-KEY NETWORK DATABASE ..... 6
  - 5.2. NETWORK INPUT SPACE ..... 6
    - 5.2.1. *Low Oil Pressure network input space* ..... 7
    - 5.2.2. *High temperature transmission Oil network input space* ..... 7
    - 5.2.3. *Always ON network input space* ..... 7
    - 5.2.4. *Neutral network input space* ..... 7
  - 5.3. NETWORK OUTPUT SPACE ..... 7
- 6. SUPERNODE UTILITIES ..... 8**
  - 6.1. ADDING A SUPERNODE UTILITY MODULE TO THE ES-KEY NETWORK DATABASE ..... 8
  - 6.2. CREATING A UTILITY IN THE SUPERNODE UTILITY MODULE ..... 9
  - 6.3. SUPERNODE UTILITY NAMING SYNTAX ..... 10
  - 6.4. SUPERNODE UTILITY NAMES AND FUNCTIONS ..... 11
  - 6.5. PROGRAMMABLE DELAYS ..... 11
    - 6.5.1. *Delay ON* ..... 11
    - 6.5.2. *Delay OFF* ..... 11
    - 6.5.3. *Delay OFF after transition* ..... 12
    - 6.5.4. *Delay OFF after minutes* ..... 12
  - 6.6. BI-STABLE TRIGGER ..... 13
    - 6.6.1. *Standard bi-stable trigger* ..... 13
    - 6.6.2. *Power-up ON bi-stable* ..... 13
  - 6.7. TIMER FUNCTIONS ..... 13
    - 6.7.1. *Timer run* ..... 13
    - 6.7.2. *Timer reset* ..... 13
    - 6.7.3. *Timer trigger* ..... 14
  - 6.8. COUNTER FUNCTIONS ..... 14
    - 6.8.1. *Counter advance* ..... 14
    - 6.8.2. *Counter reset* ..... 14
    - 6.8.3. *Counter trigger* ..... 14
  - 6.9. VOLTAGE TRIP POINTS ..... 15
    - 6.9.1. *High voltage trip point* ..... 15
    - 6.9.2. *Low voltage trip point* ..... 15
  - 6.10. FLASH RATE ..... 15
  - 6.11. SEQUENCER FUNCTION ..... 16
  - 6.12. OIL PRESSURE TRIP POINTS ..... 16
    - 6.12.1. *High oil pressure trip point* ..... 16
    - 6.12.2. *Low oil pressure trip point* ..... 17
  - 6.13. ENGINE RPM TRIP POINTS ..... 17
  - 6.14. WATER TEMPERATURE TRIP POINTS ..... 17
    - 6.14.1. *High water temperature trip point* ..... 17
    - 6.14.2. *Low water temperature trip point* ..... 17

 607 NW 27th Ave Ocala, FL 34475 Ph: 352-629-5020 or 1-800-533-3569 Fax : 352-629-290 or 1-800-520-3473	<b>TECHNICAL DATA SHEET</b>			<b>PAGE</b>	3 OF 29
	<b>PRODUCT GROUP</b>	<b>ES-KEY</b>	<b>P/N</b>	<b>122116</b>	<b>DATE</b>
<b>PRODUCT</b>	<b>USM II</b>			<b>REV</b>	1.10
				<b>BY</b>	<b>BHS</b>

- 6.15. TRANSMISSION HIGH TEMPERATURE TRIP POINT ..... 18
- 6.16. TRANSMISSION GEAR INDICATIONS..... 18
  - 6.16.1. *Transmission reverse indication*..... 18
  - 6.16.2. *Transmission neutral indication*..... 18
  - 6.16.3. *Transmission park indication* ..... 18
- 6.17. ENGINE WAIT TO START WARNING ..... 18
- 6.18. ENGINE WATER IN FUEL WARNING..... 19
- 6.19. PARKING BRAKE INDICATION ..... 19
- 6.20. VEHICLE SPEED TRIP POINT ..... 19
- 6.21. CHECK MODULE STATUS FUNCTION ..... 19
- 6.22. FLIP-FLOP FUNCTIONS ..... 20
  - 6.22.1. *Flip-Flop SET*..... 20
  - 6.22.2. *Flip-Flop RESET*..... 20
- 7. UTILITY MODULE .....21**
  - 7.1. ADDING A UTILITY MODULE TO THE ES-KEY NETWORK DATABASE..... 21
  - 7.2. UTILITY MODULE INPUT MEMORY SPACE FUNCTIONS ..... 21
  - 7.3. UTILITY MODULE OUTPUT MEMORY SPACE FUNCTIONS ..... 22
- 8. UNIVERSAL SYSTEM MANAGER FUNCTIONS .....23**
  - 8.1. LOAD MANAGEMENT ENABLING AND FUNCTIONS ..... 23
    - 8.1.1. *Operating modes* ..... 23
    - 8.1.2. *Stage switch (master switch)*..... 24
    - 8.1.3. *Priority* ..... 24
    - 8.1.4. *Sequence level*..... 25
    - 8.1.5. *High idle*..... 25
- 9. USB PORT .....26**
- 10. DIMENSIONS .....27**
- 11. CONNECTOR DESCRIPTIONS .....28**
  - 11.1. OUTPUTS / INPUTS ..... 28
- 12. DIAGNOSTIC LEDS.....29**
- 13. TECHNICAL DETAILS .....29**

 607 NW 27th Ave Ocala, FL 34475 Ph: 352-629-5020 or 1-800-533-3569 Fax : 352-629-290 or 1-800-520-3473	<b>TECHNICAL DATA SHEET</b>			<b>PAGE</b>	4 OF 29
	<b>PRODUCT GROUP</b>	<b>ES-KEY</b>	<b>P/N</b>	<b>DATE</b>	7/18/2012
			122116	<b>REV</b>	1.10
	<b>PRODUCT</b>	<b>USM II</b>		<b>BY</b>	<b>BHS</b>

## 1. Revision Log

Rev	Date	Approved	Changes
1.00	7-13-2012	BHS	Initial release.
1.10	7-18-2012	BHS	Added and changed graphics. Added SuperNode Utility workaround.

 <p>607 NW 27th Ave Ocala, FL 34475 Ph: 352-629-5020 or 1-800-533-3569 Fax: 352-629-290 or 1-800-520-3473</p>	<b>TECHNICAL DATA SHEET</b>			<b>PAGE</b>	5 OF 29
				<b>DATE</b>	7/18/2012
<b>PRODUCT GROUP</b>	<b>ES-KEY</b>	<b>P/N</b>	122116	<b>REV</b>	1.10
<b>PRODUCT</b>	<b>USM II</b>			<b>BY</b>	<b>BHS</b>

## 2. Module Overview

USM II (p/n 122116) is a solid state module that controls and monitors the ES-Key network database. The module is referred to as the USM II (Universal System Manager II). In the ES-Key network, the USM II is responsible for arbitrating the network variables to each module, monitoring faults and diagnostics and controlling electrical load management functions. The USM II has 6 inputs and 5 outputs. The polarity of the inputs is selectable by the end user (see section 4). The module reports the state of the inputs to the network and will activate the outputs on command from the network.

### 2.1. Features

- 5 selectable polarity outputs (500mA each) section 3
- 6 selectable polarity inputs section 4
- SAE J1939 CAN engine message reception and ES-Key I/O association section 5.2
- Programmable special utilities (timers, delays, etc) section 6
- Incorporated Universal System Manager incl. load management functions section 8
- USB port for database transfer and diagnostics section 9

## 3. Selectable Polarity Solid State Outputs

The USM II has five (5) selectable polarity outputs, each of which is capable of supplying 500mA of current continuously at an ambient temperature of up to 85° Celsius (185° Fahrenheit).

See Section 4 for configuring the polarity of the outputs.

## 4. Selectable Polarity Digital Inputs

The USM II has six (6) digital inputs. The polarity of these inputs is determined by the switches correlating to inputs 0-5 (labeled IN0, IN1, IN2, IN3, IN4, and IN5 on the circuit board).

Use the table below to determine what voltage is required to activate the selected polarity.

Polarity	Input Requirements
Ground	Input "ON" when input voltage is < 40% of Supply +
Positive	Input "ON" when input voltage is > 60% of Supply +

To set the polarity of the digital inputs or outputs, set the corresponding switches into either an **up (Positive)** or **down (Ground)** position.

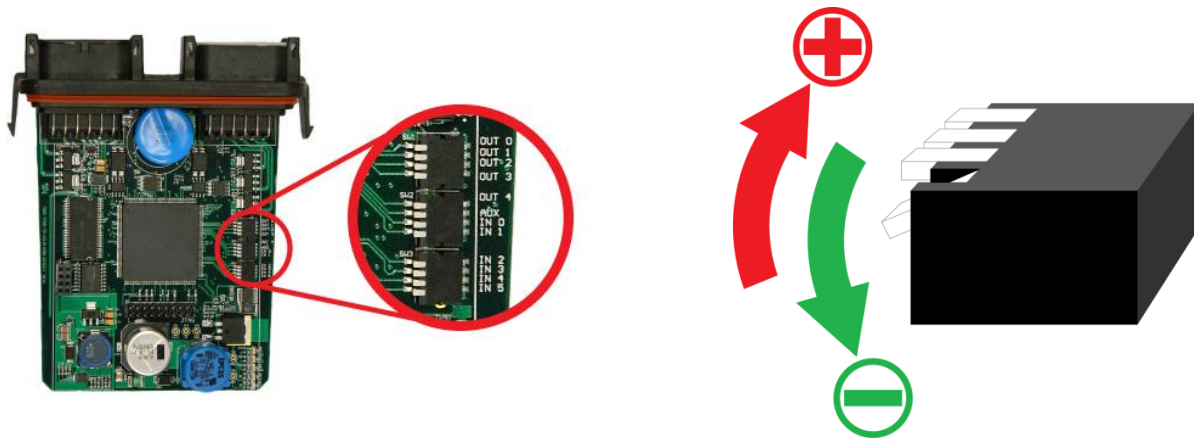

 <p>607 NW 27th Ave Ocala, FL 34475 Ph: 352-629-5020 or 1-800-533-3569 Fax : 352-629-290 or 1-800-520-3473</p>	<b>TECHNICAL DATA SHEET</b>			<b>PAGE</b>	6 OF 29
	<b>PRODUCT GROUP</b>	ES-KEY	<b>P/N</b>	122116	<b>DATE</b>
<b>PRODUCT</b>	USM II			<b>REV</b>	1.10
				<b>BY</b>	BHS

## 5. ES-Key Network Detail

### 5.1. Adding a System Manager to the ES-Key network database

Add a System Manager to the ES-Key network by right-clicking on the “ES-Key Network” block, select “Add Device”, and select “System Manager”. The first USM II added will be assigned address 0; the second will be assigned address 1, etc.

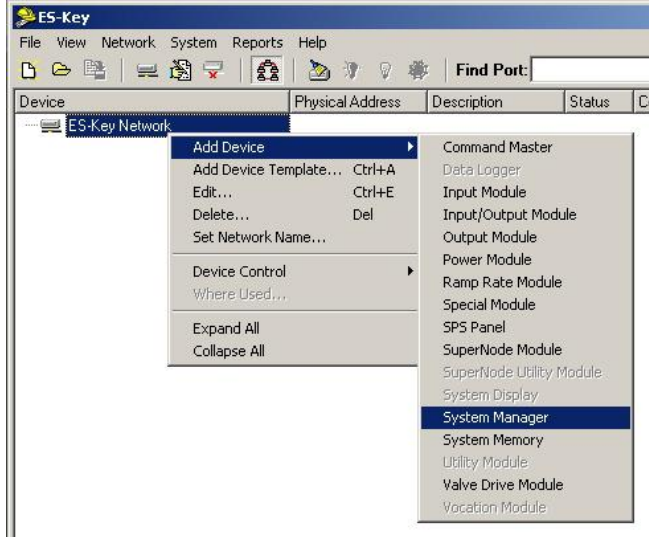

### 5.2. Network input space

The USM II can have up to 6 inputs (physical) assigned to the ES-Key network database. Use the ES-Key Professional software to add network inputs by double clicking on the “System Manager” to open the “Device Editor” and then pressing **CTRL+I** on the keyboard to create each input.

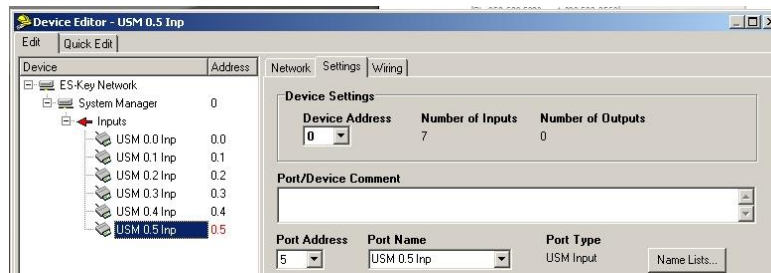

The six (6) selectable polarity inputs are the physical inputs which have a direct connection through the USM II's connector to the real world.

Input	Description
0	Input 0 (selectable)
1	Input 1 (selectable)
2	Input 2 (selectable)
3	Input 3 (selectable)
4	Input 4 (selectable)
5	Input 5 (selectable)

Input	Description
24	J1939 Stop Engine
25	J1939 Check Engine
26	J1939 Water Temp HIGH
27	J1939 Oil PSI LOW <sup>(1)</sup>
28	Trans Temperature HIGH
29	Not Defined
30	Always ON
31	Neutral

<sup>(1)</sup> Engine RPM must be greater than 600.

 607 NW 27th Ave Ocala, FL 34475 Ph: 352-629-5020 or 1-800-533-3569 Fax : 352-629-290 or 1-800-520-3473	<b>TECHNICAL DATA SHEET</b>			<b>PAGE</b>	7 OF 29	
	<b>PRODUCT GROUP</b>	<b>ES-KEY</b>	<b>P/N</b>	122116	<b>DATE</b>	7/18/2012
	<b>PRODUCT</b>	<b>USM II</b>			<b>REV</b>	1.10
					<b>BY</b>	<b>BHS</b>

### 5.2.1. Low Oil Pressure network input space

The USM II associates low oil pressure (less than 5 PSI) into its ES-Key network input space. A low oil pressure causes the USM II to activate input 27 of its network input space. Engine oil pressure is received from the engine control unit via SAE J1939 PGN 65263.

### 5.2.2. High temperature transmission Oil network input space

The USM II associates high temperature transmission Oil (greater than 220 °F) into its ES-Key network input space. A high transmission Oil temperature causes the USM II to activate input 28 of its network input space. Engine oil pressure is received from the transmission control unit via SAE J1939 PGN 65272.

### 5.2.3. Always ON network input space

The USM II's Always ON ES-Key network input space is activated one (1) second after the USM II is powered ON. This network spaced remains ON until the USM II is powered OFF.

### 5.2.4. Neutral network input space

The USM II associates transmission in neutral into its ES-Key network input space. Transmission in neutral causes the USM II to activate input 31 of its network input space. Transmission selected gear is received from the transmission control unit via SAE J1939 PGN 61445.

## 5.3. Network output space

The USM II can have up to 5 outputs (physical) assigned to the ES-Key network database. Use the ES-Key Professional software to add network outputs by double clicking on the "System Manager" to open the "Device Editor" and then pressing **CTRL+O** on the keyboard to create each output.

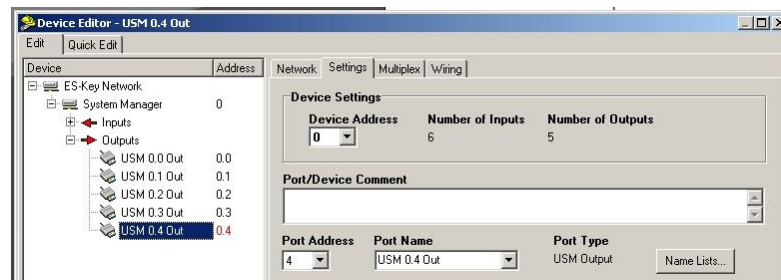

The five (5) selectable polarity outputs are the physical outputs which have a direct connection through the USM II's connector to the real world.

Output	Description
0	Output 0 (selectable polarity)
1	Output 1 (selectable polarity)
2	Output 2 (selectable polarity)
3	Output 3 (selectable polarity)
4	Output 4 (selectable polarity)

 607 NW 27th Ave Ocala, FL 34475 Ph: 352-629-5020 or 1-800-533-3569 Fax : 352-629-290 or 1-800-520-3473	<b>TECHNICAL DATA SHEET</b>				<b>PAGE</b>	8 OF 29
	<b>PRODUCT GROUP</b>	<b>ES-KEY</b>	<b>P/N</b>	122116	<b>DATE</b>	7/18/2012
	<b>PRODUCT</b>	<b>USM II</b>			<b>REV</b>	1.10
					<b>BY</b>	<b>BHS</b>

## 6. SuperNode Utilities

### 6.1. Adding a SuperNode Utility Module to the ES-Key network database

The USM II contains many utilities for allowing unique operation. Section 6.4 contains a table which lists all of the SuperNode Utilities available.

The SuperNode Utilities are available to the ES-Key network by adding a “SuperNode Utility Module” with the ES-Key Professional software. The SuperNode Utility Module is a virtual device that resides in the memory of the USM II.

#### For ES-Key Pro versions later than V. 1.20.04:

1. Add a SuperNode Utility to the ES-Key network by right-clicking on “ES-Key Network”, select “Add Device”, and select “SuperNode Utility Module”.

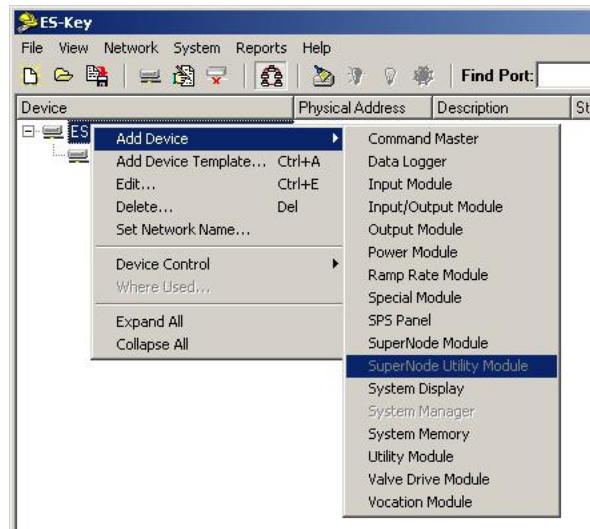

#### For ES-Key Pro V. 1.20.04 and earlier:

*(ES-Key Pro V. 1.20.04 and earlier will not allow a database with a System Manager to add a SuperNode Utility. The steps below outline the workaround.)*

1. Add a SuperNode Module to the ES-Key Network by right-clicking on “ES-Key Network”, selecting “Add Device”, and selecting “SuperNode Module” which will initially be set at address “0”.
2. Add a “SuperNode Utility Module” under the “Add Device” menu.
3. Change the address of the SuperNode Module to “1”.
4. Add a “System Manager” under the “Add Device” menu.
5. Finally, delete the “SuperNode Module”. The only items left now are the System Manager and the SuperNode Utility Module in the ES-Key Network.



 607 NW 27th Ave Ocala, FL 34475 Ph: 352-629-5020 or 1-800-533-3569 Fax : 352-629-290 or 1-800-520-3473	<b>TECHNICAL DATA SHEET</b>			<b>PAGE</b>	9 OF 29	
	<b>PRODUCT GROUP</b>	ES-KEY	<b>P/N</b>	122116	<b>DATE</b>	7/18/2012
	<b>PRODUCT</b>	<b>USM II</b>	<b>REV</b>	1.10	<b>BY</b>	<b>BHS</b>

## 6.2. Creating a utility in the SuperNode Utility Module

All SuperNode utilities are added to the network input space of the SuperNode Utility. You must first create the desired number of inputs (up to 32) to the SuperNode Utility by double clicking on the “SuperNode Utility” to open the “Device Editor” and then pressing **CTRL+I** on the keyboard to create each input.

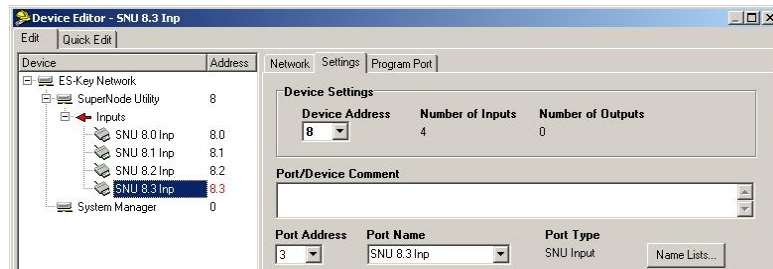

Add the desired number of outputs (up to 32) to the SuperNode Utility by pressing **CTRL+O** on the keyboard to create each output.

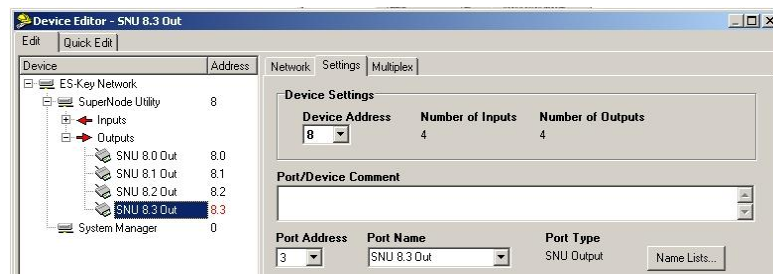

Highlight (click on) the desired SuperNode Utility input and assign a special utility function by selecting the “Program Port” folder tab and then clicking on the down arrow to open the “Select Function” list box. Select the desired utility.

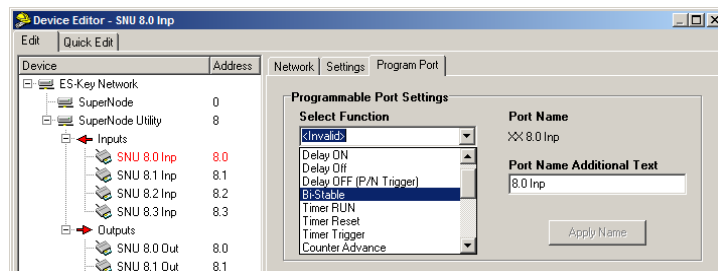

If the selected utility requires an additional parameter the “Function Parameter #1” text box will be enabled so that the value can be entered. Some utilities require an additional value to be entered into the “Function Parameter #2” text box (see section 6.4).

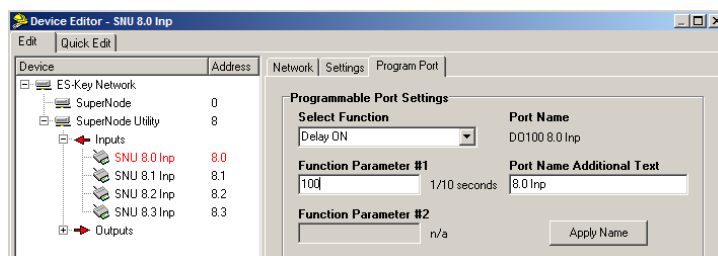

 607 NW 27th Ave Ocala, FL 34475 Ph: 352-629-5020 or 1-800-533-3569 Fax : 352-629-290 or 1-800-520-3473	<b>TECHNICAL DATA SHEET</b>			<b>PAGE</b>	10 OF 29
	<b>PRODUCT GROUP</b>	<b>ES-KEY</b>	<b>P/N</b>	<b>DATE</b>	7/18/2012
	<b>PRODUCT</b>	<b>USM II</b>		<b>REV</b>	1.10
					<b>BY</b>

### 6.3. SuperNode Utility naming syntax

The ES-Key Professional software will automatically name the selected SuperNode utility port with the correct syntax when using the “program port” tab. *(The details of the default syntax structure are found in each of the SuperNode Utility description sections).*

The ES-Key professional software adds extra text to the core naming syntax, but this extra text can be personalized in the “Port Name Additional Text” box to make the SuperNode utility port easier to identify. For example, below we have created a “Voltage Greater Than” trip point with a “Function Parameter 1” of 150 (15.0 volts), and the additional text was re-named “Voltage HI”.

The ES-Key Professional software only allows port names to be 16 characters long (including the core syntax) and truncates names that exceed 16 characters (spaces count as a character).

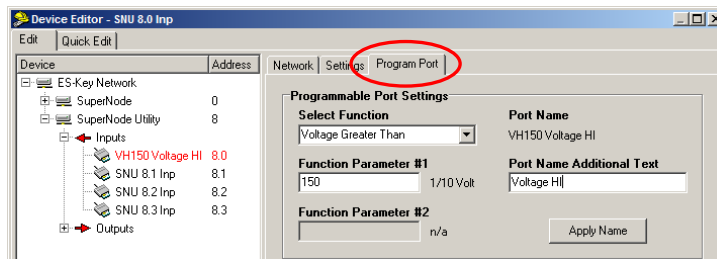

It is not mandatory to use the ES-Key Professional “program port” tab to create the naming syntax of a utility. A utility input can be manually named using the “settings” tab as long as the rules of the desired utility are followed. For example, below a coolant temperature high utility is created by manually naming utility port 8.0 **TH250**.

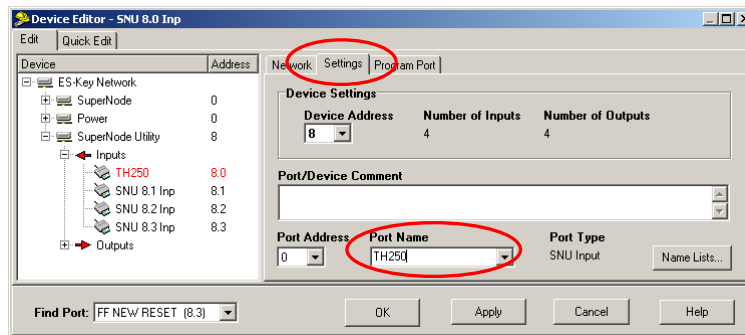

 607 NW 27th Ave Ocala, FL 34475 Ph: 352-629-5020 or 1-800-533-3569 Fax : 352-629-290 or 1-800-520-3473	<b>TECHNICAL DATA SHEET</b>				<b>PAGE</b>	11 OF 29
	<b>PRODUCT GROUP</b>	<b>ES-KEY</b>	<b>P/N</b>	122116	<b>DATE</b>	7/18/2012
	<b>PRODUCT</b>	<b>USM II</b>			<b>REV</b>	1.10
					<b>BY</b>	<b>BHS</b>

#### 6.4. SuperNode Utility names and functions

Function	Function Syntax	Function Parameter 1	Function Parameter 2	Example	Section
Delay ON seconds	DO	Time (1/10 seconds)	----	DO600	6.5.1
Delay OFF seconds	DF	Time (1/10 seconds)	----	DF30	6.5.2
Delay OFF after transition	DB	Time (1/10 seconds)	----	DB300	6.5.3
Delay OFF minutes	DM	Time (minutes)	----	DM10	6.5.4
Bi-stable trigger	BS	----	----	BS	6.6.1
Bi-stable trigger (default ON)	BO	----	----	BO	6.6.2
Timer run	TA	Timer number (0,1,2,3)	----	TA2	6.7.1
Timer reset	TR	Timer number (0,1,2,3)	----	TR1	6.7.2
Timer trigger	TT	Timer number (0,1,2,3)	Time (1/10 hours)	TT0,2	6.7.3
Counter advance	CA	Counter number (0,1,2,3)	----	CA1	6.8.1
Counter reset	CR	Counter number (0,1,2,3)	----	CR1	6.8.2
Counter trigger	CT	Counter number (0,1,2,3)	Trip count	CT1,500	6.8.3
Voltage greater than	VH	Trip voltage (1/10 volts)	----	VH140	6.9.1
Voltage less than	VL	Trip voltage (1/10 volts)	----	VL119	6.9.2
Flasher	F	Flash rate (1/4 second)	----	F4	6.10
Sequence	S	Sequencer number (0,1,2,3)	Number of steps (2-9)	S0,4	6.11
Oil pressure high	OH	Pressure in PSI	----	OH60	6.12.1
Oil pressure low	OL	Pressure in PSI	----	OL5	6.12.2
Engine RPM warning	R	RPM	----	R2200	6.13
Coolant temperature high	TH	Degrees in F	----	TH250	6.14.1
Coolant temperature low	TL	Degrees in F	----	TL75	6.14.2
Transmission temp HIGH	TX	Degrees in F	----	TX250	6.15
Transmission – reverse	RW	----	----	RW	6.16.1
Transmission – park	TP	----	----	TP	6.16.3
Transmission – neutral	N	----	----	N	6.16.2
Wait to start warning	WS	----	----	WS	6.17
Water in fuel warning	WF	----	----	WF	6.18
Park brake warning	PB	----	----	PB	6.19
Vehicle speed warning	M	Miles per hour	----	M65	6.20
Check module status	CM	Device type (0-F)	Device address (0-F)	CM10	6.21
Flip flop set	FFB	----	----	FFB	6.22.1
Flip flop reset	FFA	----	----	FFA	6.22.2

#### 6.5. Programmable delays

The USM II has four types of programmable delays: delay ON, delay OFF, delay OFF after transition, and delay OFF after number of minutes. A delay is created by using the ES-Key Professional software to name an input with the delay naming syntax in the SuperNode Utility (SNU) space.

The delay naming syntax consists of DX####. The D indicates delay, X is the type of delay (O = ON, F = OFF, B = OFF after transition, M OFF after minutes), #### is the time of the delay in tenths of a second (101 = 10.1 seconds). For example, DO15 is a delay ON for 1.5 seconds.

##### 6.5.1. Delay ON

Delay ON causes the designated SuperNode Utility input to turn ON after the associated SuperNode Utility output is activated and the designated delay time is met.

##### Example:

SuperNode Utility input 2 is labeled **DO125** (delay ON after 12.5 seconds). When SuperNode Utility output 2 is turned ON then DO125 (SuperNode Utility input 2) will turn ON after 12.5 seconds.

*Resolution: minimum 1 (0.1 seconds), maximum 9999 (999.9 seconds).*

##### 6.5.2. Delay OFF

Delay OFF causes the designated SuperNode Utility input to turn ON with the associated SuperNode Utility output and then turn OFF after the designated delay time.

 607 NW 27th Ave Ocala, FL 34475 Ph: 352-629-5020 or 1-800-533-3569 Fax : 352-629-290 or 1-800-520-3473	<b>TECHNICAL DATA SHEET</b>			<b>PAGE</b>	12 OF 29
	<b>PRODUCT GROUP</b>	<b>ES-KEY</b>	<b>P/N</b>	<b>DATE</b>	7/18/2012
			122116	<b>REV</b>	1.10
	<b>PRODUCT</b>	<b>USM II</b>		<b>BY</b>	<b>BHS</b>

Example:

SuperNode Utility input 2 is labeled **DF300** (delay OFF after 30.0 seconds). When SuperNode Utility output 2 is turned ON then DF300 (SuperNode Utility input 2) will turn ON and then turn OFF after 30.0 seconds.

*Resolution: minimum 1 (0.1 seconds), maximum 9999 (999.9 seconds).*

**6.5.3. Delay OFF after transition**

Delay OFF after transition causes the designated SuperNode Utility input to turn ON after the associated SuperNode Utility output is transitioned (ON to OFF or OFF to ON) and then turn OFF after designated delay time is met.

Example:

SuperNode Utility input 2 is labeled **DB55** (delay OFF after transition after 5.5 seconds). When SuperNode Utility output 2 is turned ON or OFF then DB55 (SuperNode Utility input 2) will turn ON after 5.5 seconds.

*Resolution: minimum 1 (0.1 seconds), maximum 9999 (999.9 seconds).*

**6.5.4. Delay OFF after minutes**

Delay OFF after minutes causes the designated SuperNode Utility (SNU) input to turn ON with the associated SuperNode Utility (SNU) output and then turn OFF after the designated delay time.

Example:

SuperNode Utility input 2 is labeled **DM60** (delay OFF after 60 minutes). When SuperNode Utility output 2 is turned ON then DM60 (SuperNode Utility input 2) will turn ON and then turn OFF after 60 minutes.

*Resolution: minimum 1 minute, maximum 100 minutes.*

 607 NW 27th Ave Ocala, FL 34475 Ph: 352-629-5020 or 1-800-533-3569 Fax : 352-629-290 or 1-800-520-3473	<b>TECHNICAL DATA SHEET</b>			<b>PAGE</b>	13 OF 29
	<b>PRODUCT GROUP</b>	<b>ES-KEY</b>	<b>P/N</b>	<b>DATE</b>	7/18/2012
			122116	<b>REV</b>	1.10
	<b>PRODUCT</b>	<b>USM II</b>		<b>BY</b>	<b>BHS</b>

## 6.6. Bi-stable trigger

The USM II has two bi-stable trigger functions (standard and power-up ON). The standard bi-stable trigger changes the state of a SuperNode Utility input with the activation of the associated SuperNode Utility output. The power-up bi-stable trigger turns ON when the USM II is initialized and then acts the same as a standard bi-stable trigger. The naming syntax is BS (standard bi-stable) and BO (power-up ON bi-stable). Additional text should be added after the naming syntax to create unique identifiers.

### 6.6.1. Standard bi-stable trigger

A standard bi-stable trigger is created by using the ES-Key Professional software to name an input BS (bi-stable trigger naming syntax) in the SuperNode Utility space.

Example:

SuperNode Utility input 2 is labeled **BS Light1**. When SuperNode Utility output 2 is turned ON then BS Light1 (SuperNode Utility input 2) will change states.

### 6.6.2. Power-up ON bi-stable

A power-up ON bi-stable trigger is created by using the ES-Key Professional software to name an input BO (bi-stable power-up ON trigger naming syntax) in the SuperNode Utility space.

Example:

SuperNode Utility input 2 is labeled **BO Light2**. When SuperNode Utility output 2 is turned ON then BO Light2 (SuperNode Utility input 2) will change states.

## 6.7. Timer functions

The USM II has four 1/10 hour timers. Each timer can be started/reset independently and can record a maximum of 16,666.6 hours. The timers only run when the vehicle power is applied and the associated timer run port is enabled. When the timer reaches the defined time limit its timer trigger will be activated.

The timer functions are created by using the ES-Key Professional software to name an input with the timer function naming syntax in the SuperNode Utility (SNU) space.

### 6.7.1. Timer run

The timer run naming syntax consists of TA# (where TA = timer advance, and # = timer number 0, 1, 2, or 3).

Create a timer by naming a SuperNode Utility input with TA#. When the associated SuperNode Utility output is ON the timer will be advancing.

Example:

SuperNode Utility input 2 is labeled **TA2** (timer advance number 2). When SuperNode Utility output 2 is turned ON then timer 2 will be running.

### 6.7.2. Timer reset

The timer reset naming syntax consists of TR# (where TR = timer reset, and # = timer number 0, 1, 2, or 3). Create a timer reset function by naming a SuperNode Utility input with TR#. When the associated SuperNode Utility output is turned from OFF to ON, the timer will be reset.

Example:

SuperNode Utility input 3 is labeled **TR2** (timer reset number 2). When SuperNode Utility output 3 is turned from OFF to ON then timer 2 will be reset. Reset only occurs at the transition from OFF to ON of the associated SuperNode Utility output.

 607 NW 27th Ave Ocala, FL 34475 Ph: 352-629-5020 or 1-800-533-3569 Fax : 352-629-290 or 1-800-520-3473	<b>TECHNICAL DATA SHEET</b>			<b>PAGE</b>	14 OF 29
	<b>PRODUCT GROUP</b>	<b>ES-KEY</b>	<b>P/N</b>	<b>DATE</b>	7/18/2012
			122116	<b>REV</b>	1.10
	<b>PRODUCT</b>	<b>USM II</b>		<b>BY</b>	<b>BHS</b>

### 6.7.3. **Timer trigger**

The timer trigger naming syntax consists of TT#,xxxx (where TT = timer trigger, # = timer number 0, 1, 2, or 3, and xxxx = trigger time). Create a timer trigger function by naming a SuperNode Utility input with TT#,xxxx. When the associated timer has reached the designated time the SuperNode Utility input will turn ON.

Example:

SuperNode Utility input 4 is labeled **TT2,500** (timer trigger number 2 at 50.0 hours). When timer 2 reaches 50.0 hours the SuperNode Utility input 4 will be turned ON.

*Resolution: minimum 1 (0.1 hours), maximum 99999 (9999.9 hours).*

### 6.8. **Counter functions**

The USM II has four event counters. Each counter can be incremented, enabled, and reset independently and can record a maximum of 9999 events.

The counter functions are created by using the ES-Key Professional software to name an input with the counter function naming syntax in the SuperNode Utility space.

#### 6.8.1. **Counter advance**

The counter advance naming syntax consists of CA# (where CA = counter advance, and # = counter number 0, 1, 2, or 3). Create a counter by naming a SuperNode Utility input with CA#. The counter will advance with the activation of the associated SuperNode Utility output.

Example:

SuperNode Utility input 2 is labeled **CA1** (counter advance number 1). When SuperNode Utility output 2 is turned ON then counter 1 will increment once.

#### 6.8.2. **Counter reset**

The counter reset naming syntax consists of CR# (where CR = counter reset, and # = counter number 0, 1, 2, or 3). Create a counter reset function by naming a SuperNode Utility input with CR#. Turn the associated SuperNode Utility output from OFF to ON to reset the counter.

Example:

SuperNode Utility input 3 is labeled **CR1** (counter reset number 1). When SuperNode Utility output 3 is toggled from OFF to ON then counter 1 will be reset. Reset only occurs at the transition from OFF to ON of the associated SuperNode Utility output.

#### 6.8.3. **Counter trigger**

The counter trigger naming syntax consists of CT#,xxxx (where CT = counter trigger, # = counter number 0, 1, 2, or 3, and xxxx = counter value). Create a counter trigger function by naming a SuperNode Utility (SNU) input with CT#,xxxx. The SuperNode Utility input set as the counter trigger will turn ON when the counter has reached the designated count value.

Example:

SuperNode Utility input 4 is labeled **CT1,500** (counter trigger number 1 at 500 events). When counter 1 reaches 500 events the SuperNode Utility input 4 will be turned ON.

*Resolution: minimum 1 event, maximum 9999 events.*

 607 NW 27th Ave Ocala, FL 34475 Ph: 352-629-5020 or 1-800-533-3569 Fax : 352-629-290 or 1-800-520-3473	<b>TECHNICAL DATA SHEET</b>			<b>PAGE</b>	15 OF 29
	<b>PRODUCT GROUP</b>	<b>ES-KEY</b>	<b>P/N</b>	<b>DATE</b>	7/18/2012
			122116	<b>REV</b>	1.10
	<b>PRODUCT</b>	<b>USM II</b>		<b>BY</b>	<b>BHS</b>

## 6.9. Voltage trip points

The USM allows configuring of high and low voltage trip points. The voltage trip points are created by using the ES-Key Professional software to name an input with the voltage trip point naming syntax in the SuperNode Utility space. System voltage is evaluated from the voltage potential between pins 1 (supply +) and 12 (supply -).

*Resolution: minimum 1 (0.1 volts), maximum 300 (30.0 volts).*

### 6.9.1. High voltage trip point

The high voltage trip point naming syntax consists of VH### (where VH = voltage high, ### = voltage in tenths). Create a high voltage trip point by naming a SuperNode Utility input with VH###. The high voltage trip point SuperNode Utility input will turn ON when the system voltage has exceeded the designated voltage level.

Example:

SuperNode Utility input 2 is labeled **VH150** (voltage high at 15.0 volts), when the system voltage exceeds 15.0 volts the SuperNode Utility input 2 will be turned on.

### 6.9.2. Low voltage trip point

The low voltage trip point naming syntax consists of VL### (where VL = voltage low, ### = voltage in tenths). Create a low voltage trip point by naming a SuperNode Utility input with VL###. The low voltage trip point SuperNode Utility input will turn ON when the system voltage has dropped below the designated voltage level.

Example:

SuperNode Utility input 2 is labeled **VL119** (voltage low at 11.9 volts). When the system voltage drops below 11.9 volts the SuperNode Utility input 2 will be turned on.

## 6.10. Flash rate

The USM II allows configuring of variable flash rates in ¼ second intervals. The flash rates are created by using the ES-Key Professional software to name an input with the flash rate naming syntax in the SuperNode Utility space.

The flash rate naming syntax consists of F### (where F = flash, and ### = rate in ¼ second increments). Create a flash rate by naming a SuperNode Utility input with F###. The flash rate naming syntax is complete after a space is entered so other text can also be used to identify the input. For example, "F8 Warning Light" is a valid name.

The flash rate SuperNode Utility input will flash at the designated rate when the associated SuperNode Utility output is activated.

Example:

SuperNode Utility input 2 is labeled **F8** (flash at rate 8). The SuperNode Utility input 2 will toggle ON and OFF in 2 second intervals when SuperNode Utility output 2 is activated.

*Resolution: minimum 1 (0.25 seconds), maximum 9999 (2499.75 seconds).*

*[flash rate value X 0.25 = time in seconds - e.g. rate 8 X 0.25 = 2 seconds]*

 607 NW 27th Ave Ocala, FL 34475 Ph: 352-629-5020 or 1-800-533-3569 Fax: 352-629-290 or 1-800-520-3473	<b>TECHNICAL DATA SHEET</b>			<b>PAGE</b>	16 OF 29	
	<b>PRODUCT GROUP</b>	<b>ES-KEY</b>	<b>P/N</b>	122116	<b>DATE</b>	7/18/2012
	<b>PRODUCT</b>	<b>USM II</b>			<b>REV</b>	1.10
					<b>BY</b>	<b>BHS</b>

### 6.11. Sequencer function

A sequencer function is created by using the ES-Key Professional software to name an input with the sequencer naming syntax in the SuperNode Utility space.

The sequencer naming syntax consists of S#,N (where S = sequence, # = number associated with the sequence [0-9], and N = the number of cycles to sequence through [2-9]).

Example:

Label SuperNode Utility input 3 as **S0,4** (this states that sequence 0 has 4 steps to cycle through). Then create variable names **X1** and **X2** in the 2 successive inputs spaces (inputs 4 and 5). The three steps of the sequencer will be the inputs S0,4, X1, and X2. Create variables for the “sequencer control”, and “sequencer force off” in the associated output space (in the below example named Seq 0 CONT and Seq 0 OFF). Toggling the Seq 0 CONT output causes the sequence to step, and turning Seq 0 OFF forces the configured inputs OFF and resets the sequence.

*Resolution: minimum 2 steps, maximum 9 steps.*

<b>Inputs</b>	S0,4	8.3	When Output 8.3 (in this example named ‘Seq 0 CONT’) is toggled from OFF to ON the input space sequences one step. The system initializes with the configured sequence steps all OFF			
	X1	8.4				
	X2	8.5	Seq 0 CONT (Output 8.3)	S0,4 (Input 8.3)	X1 (input 8.4)	X2 (input 8.5)
<b>Outputs</b>	Seq 0 CONT	8.3	<b>First toggle</b>	<b>ON</b>	OFF	OFF
	Seq 0 OFF	8.4	<b>Second toggle</b>	OFF	<b>ON</b>	OFF
			<b>Third toggle</b>	OFF	OFF	<b>ON</b>
			<b>Fourth toggle</b>	OFF	OFF	OFF
			<b>Fifth toggle</b>	<b>ON</b>	OFF	OFF

### 6.12. Oil pressure trip points

The USM II allows configuring of high and low oil pressure trip points. The oil pressure trip points are created by using the ES-Key Professional software to name an input with the oil pressure trip point naming syntax in the SuperNode Utility space. Engine oil pressure is received from the engine ECU via SAE J1939 PGN 65263.

*Resolution: minimum 1 PSI, maximum 999 PSI.*

#### 6.12.1. High oil pressure trip point

The high oil pressure trip point naming syntax consists of OH### (where OH = oil pressure high, ### = pressure in PSI). Create a high oil pressure trip point by naming a SuperNode Utility input with OH###. The high oil pressure trip point SuperNode Utility input will turn ON when the system voltage exceeds the designated pressure level.

Example:

SuperNode Utility input 2 is labeled **OH80** (oil pressure high when greater than 80 PSI). When the engine oil pressure exceeds 80 PSI the SuperNode Utility input 2 will be turned ON.



 607 NW 27th Ave Ocala, FL 34475 Ph: 352-629-5020 or 1-800-533-3569 Fax : 352-629-290 or 1-800-520-3473	<b>TECHNICAL DATA SHEET</b>			<b>PAGE</b>	17 OF 29
	<b>PRODUCT GROUP</b>	<b>ES-KEY</b>	<b>P/N</b>	<b>DATE</b>	7/18/2012
			122116	<b>REV</b>	1.10
	<b>PRODUCT</b>	<b>USM II</b>		<b>BY</b>	<b>BHS</b>

### 6.12.2. Low oil pressure trip point

The low oil pressure trip point naming syntax consists of OL### (where OL = oil pressure low, ### = pressure in PSI). Create a low oil pressure trip point by naming a SuperNode Utility input with OL###. The low oil pressure trip point SuperNode Utility input will turn ON when the engine oil pressure has dropped below the designated pressure level.

Example:

SuperNode Utility input 2 is labeled **OL20** (oil pressure low when less than 20 PSI). When the engine oil pressure drops below 20 PSI the SuperNode Utility input 2 will be turned ON.

### 6.13. Engine RPM trip points

The USM II allows configuring of engine RPM trip points. The engine RPM trip points are created by using the ES-Key Professional software to name an input with the engine RPM trip point naming syntax in the SuperNode Utility space. The engine RPM trip point naming syntax consists of R#X## (where R = engine RPM, #### = engine RPM). Create an engine RPM trip point by naming a SuperNode Utility input with R####. The engine RPM trip point SuperNode Utility input will turn ON when the engine RPM reaches or exceeds the designated RPM level.

Engine RPM is received from the engine ECU via SAE J1939 PGN 61444.

Example:

SuperNode Utility input 2 is labeled **R2200** (RPM trip when greater than 2200 RPM). When the engine RPM increases above 2200 RPM the SuperNode Utility input 2 will be turned ON.

*Resolution: minimum 1 RPM, maximum 9999 RPM.*

### 6.14. Water temperature trip points

The USM II allows configuring of high and low water temperature trip points. The water temperature trip points are created by using the ES-Key Professional software to name an input with the water temperature trip point naming syntax in the SuperNode Utility space.

Engine water temperature is received from the engine ECU via SAE J1939 PGN 65262.

*Resolution: minimum 1 °F, maximum 999 °F.*

#### 6.14.1. High water temperature trip point

The high water temperature trip point naming syntax consists of TH### (where TH = water temperature high, ### = temperature in °F). Create a high water temperature trip point by naming a SuperNode Utility input with TH###.

The high water temperature trip point SuperNode Utility input will turn ON when the engine water temperature exceeds the designated temperature level.

Example:

SuperNode Utility input 2 is labeled **TH250** (water temperature high when greater than 250 °F). When the engine water temperature exceeds 250 °F the SuperNode Utility input 2 will be turned ON.

#### 6.14.2. Low water temperature trip point

The low water temperature trip point naming syntax consists of TL### (where TL = water temperature low, ### = temperature in °F). Create a low water temperature trip point by naming a SuperNode Utility input with TL###.

The low water temperature trip point SuperNode Utility input will turn ON when the engine water temperature is less than the designated temperature level.

Example:

SuperNode Utility input 2 is labeled **TL65** (water temperature low when less than 65 °F). When the engine water temperature falls below 65 °F the SuperNode Utility input 2 will be turned ON.

 607 NW 27th Ave Ocala, FL 34475 Ph: 352-629-5020 or 1-800-533-3569 Fax : 352-629-290 or 1-800-520-3473	<b>TECHNICAL DATA SHEET</b>			<b>PAGE</b>	18 OF 29
	<b>PRODUCT GROUP</b>	<b>ES-KEY</b>	<b>P/N</b>	<b>DATE</b>	7/18/2012
			122116	<b>REV</b>	1.10
	<b>PRODUCT</b>	<b>USM II</b>		<b>BY</b>	<b>BHS</b>

## 6.15. Transmission high temperature trip point

The USM allows configuring of high transmission temperature trip point. The transmission temperature trip point is created by using the ES-Key Professional software to name an input with the transmission temperature trip point naming syntax in the SuperNode Utility space.

Transmission temperature is received from the transmission ECU via SAE J1939 PGN 65272.

The high transmission temperature trip point naming syntax consists of TX### (where TX = transmission temperature high, ### = temperature in °F). Create a high transmission temperature trip point by naming a SuperNode Utility input with TX###. The high transmission temperature trip point SuperNode Utility input will turn ON when the transmission temperature exceeds the designated temperature level.

### Example:

SuperNode Utility input 2 is labeled **TX250** (transmission temperature high when greater than 250 °F). When the transmission temperature exceeds 250 °F the SuperNode Utility input 2 will be turned ON.

*Resolution: minimum 1 °F, maximum 999 °F.*

## 6.16. Transmission gear indications.

The USM II has three transmission gear indications (reverse, neutral, and park). Transmission gear indications are received from the transmission control unit via SAE J1939 PGN 61445.

### 6.16.1. Transmission reverse indication

The transmission reverse indication is created by using the ES-Key Professional software to name an input RW (reverse warning) in the SuperNode Utility space.

#### Example:

SuperNode Utility input 2 is labeled **RW** (reverse warning). When the transmission is in the reverse gear the SuperNode Utility input 2 will be turned ON.

### 6.16.2. Transmission neutral indication

The transmission neutral indication is created by using the ES-Key Professional software to name an input N (neutral) in the SuperNode Utility space.

#### Example:

SuperNode Utility input 2 is labeled **N** (neutral). When the transmission is in the neutral gear the SuperNode Utility input 2 will be turned ON.

### 6.16.3. Transmission park indication

The transmission park indication is created by using the ES-Key Professional software to name an input TP (transmission park) in the SuperNode Utility space.

#### Example:

SuperNode Utility input 2 is labeled **TP** (transmission park). When the transmission is in the park gear the SuperNode Utility input 2 will be turned ON.

## 6.17. Engine wait to start warning

The engine wait to start warning is created by using the ES-Key Professional software to name an input WS (wait to start) in the SuperNode Utility space.

### Example:

SuperNode Utility input 2 is labeled **WS** (wait to start). When the warning is received from the engine ECU via SAE J1939 PGN 65252 SuperNode Utility input 2 will be turned ON.

 607 NW 27th Ave Ocala, FL 34475 Ph: 352-629-5020 or 1-800-533-3569 Fax : 352-629-290 or 1-800-520-3473	<b>TECHNICAL DATA SHEET</b>			<b>PAGE</b>	19 OF 29
	<b>PRODUCT GROUP</b>	<b>ES-KEY</b>	<b>P/N</b>	<b>DATE</b>	7/18/2012
			122116	<b>REV</b>	1.10
	<b>PRODUCT</b>	<b>USM II</b>		<b>BY</b>	<b>BHS</b>

### 6.18. Engine water in fuel warning

The engine water in fuel warning is created by using the ES-Key Professional software to name an input WF (water in fuel) in the SuperNode Utility space.

Example:

SuperNode Utility input 2 is labeled **WF** (water in fuel). When the warning is received from the engine ECU via SAE J1939 PGN 65279 SuperNode Utility input 2 will be turned ON.

### 6.19. Parking Brake indication

The Parke Brake indication is created by using the ES-Key Professional software to name an input PB (Park Brake) in the Supernode Utility space.

Example:

SuperNode Utility input 2 is labeled **PB** (park brake). When the warning is received from the engine ECU via SAE J1939 PGN 65265 SuperNode Utility input 2 will be turned ON.

### 6.20. Vehicle Speed trip point

A Vehicle Speed trip point is created by using the ES-Key Professional software to name an input M### (MPH) in the Supernode Utility space. The port becomes active when the vehicle speed exceeds the value in the ### place holder (mph).

Example:

SuperNode Utility input 2 is labeled **M55** (speed greater than 55 MPH). When the vehicle speed received from the engine ECU via SAE J1939 PGN 65265 is greater than 55 MPH SuperNode Utility input 2 will be turned ON.

*Resolution: minimum 1 MPH, maximum 999 MPH.*

### 6.21. Check module status function

The USM II allows the status of a module to be verified. A check module status function is created by using the ES-Key Professional software to name an input **CMDA** in the Supernode Utility (SNU) space where **D** is the module type and **A** is the module address. When the designated module is offline the SNU input will be ON.

Example:

SuperNode Utility input 2 is labeled **CM15** (check module device type 1 address 5). When Power Module address 5 is not transmitting on the CAN bus then SuperNode Utility input 2 is ON.

*Resolution:*

Device Type	Description
1	Power Module
2	Input Module
3	Output Module
4	Input/Output Module
5	SPS Panel
6	SuperNode
7	Special Module

Address	Description
0	Address 0
1	Address 1
2	Address 2
3	Address 3
4	Address 4
5	Address 5
6	Address 6
7	Address 7
8	Address 8
9	Address 9
A	Address 10
B	Address 11
C	Address 12
D	Address 13
E	Address 14
F	Address 15

 607 NW 27th Ave Ocala, FL 34475 Ph: 352-629-5020 or 1-800-533-3569 Fax : 352-629-290 or 1-800-520-3473	<b>TECHNICAL DATA SHEET</b>			<b>PAGE</b>	20 OF 29
	<b>PRODUCT GROUP</b>	<b>ES-KEY</b>	<b>P/N</b>	<b>DATE</b>	7/18/2012
			122116	<b>REV</b>	1.10
	<b>PRODUCT</b>	<b>USM II</b>		<b>BY</b>	<b>BHS</b>

## 6.22. Flip-Flop functions

The USM II has two flip-flop trigger functions (SET and RESET). The naming syntax is FFA (Flip-Flop RESET) and FFB (Flip-Flop SET). The SuperNode Utility input space named FFB is the flip-flop output and is controlled by the associated SuperNode Utility outputs. Additional text should be added after the naming syntax to create unique identifiers.

### 6.22.1. Flip-Flop SET

Create a flip-flop SET by naming a SuperNode Utility input with FFB. The flip-flop will turn ON with the activation of the associated SuperNode Utility output.

Example:

SuperNode Utility input 2 is labeled **FFB**. When SuperNode Utility output 2 is turned ON then the flip-flop will turn ON (SuperNode Utility input 2 turns ON).

### 6.22.2. Flip-Flop RESET

Create a flip-flop RESET by naming a SuperNode Utility input with FFA. The flip-flop will turn OFF with the activation of the associated SuperNode Utility output.

Example:

SuperNode Utility input 3 is labeled **FFA**. When SuperNode Utility output 3 is turned ON then the flip-flop will turn OFF (SuperNode Utility input 2 turns OFF).

 607 NW 27th Ave Ocala, FL 34475 Ph: 352-629-5020 or 1-800-533-3569 Fax: 352-629-290 or 1-800-520-3473	<b>TECHNICAL DATA SHEET</b>			<b>PAGE</b>	21 OF 29
	<b>PRODUCT GROUP</b>	<b>ES-KEY</b>	<b>P/N</b>	<b>DATE</b>	7/18/2012
			122116	<b>REV</b>	1.10
	<b>PRODUCT</b>	<b>USM II</b>		<b>BY</b>	<b>BHS</b>

## 7. Utility Module

### 7.1. Adding a Utility Module to the ES-Key network database

The USM II contains all of the standard utilities of the Universal System Manager (USM) for allowing unique operation. Section 7.2 contains a table which lists all of the Utilities available. These utilities are only available for a USM II set to address 0.

The Utilities are available to the ES-Key network by adding a “Utility Module” with the ES-Key Professional software. The Utility Module is a virtual device that resides in the memory of the USM II. A USM II must be added to the network before a Utility Module can be added.

Add a Utility Module to the ES-Key network by right-clicking on “ES-Key Network”, select “Add Device”, and select “Utility Module”. The Utility Module’s input and output memory space is preloaded with most of the default functions.

### 7.2. Utility Module input memory space functions

The Utility module has 23 (0 through 12, 14 through 23) dedicated input memory space functions as described in the table below.

Function	Memory Space	Description
Flasher 2Hz	Input 0	Toggles at 2 Hz
Low voltage	Input 1	Turns ON when the voltage drops below 11.8V for more than 10 seconds
High idle request	Input 2	Turns ON when load management is enabled and voltage is 12.8V or less
System fault	Input 3	Turns ON when any system fault is reported
Toggle #1	Input 4	Toggles state based on output 4 (Toggle #1)
Toggle #2	Input 5	Toggles state based on output 5 (Toggle #2)
Delay #1 (3 seconds)	Input 6	Turns ON 3 seconds after output 6 (Delay #1) transitions from OFF to ON
1 second positive trigger	Input 7	Turns ON for 1 second after output 7 transitions from OFF to ON
1 second trigger	Input 8	Turns ON for 1 second after output 8 transitions from OFF to ON <b>or</b> ON to OFF
Delay #2 (5 seconds)	Input 9	Turns ON 5 seconds after output 9 (Delay #2) transitions from OFF to ON
Delay #3 (30 seconds)	Input 10	Turns ON 30 seconds after output 10 (Delay #3) transitions from OFF to ON
Delay #4 (5 seconds)	Input 11	Turns ON 5 seconds after output 11 (Delay #4) transitions from OFF to ON
8 second positive trigger	Input 12	Turns ON for 8 seconds after output 12 transitions from OFF to ON
Toggle #4	Input 14	Toggles state based on output 14 (Toggle #4)
Toggle #5	Input 15	Toggles state based on output 15 (Toggle #5)
Toggle #6	Input 16	Toggles state based on output 16 (Toggle #6)
Toggle #7	Input 17	Toggles state based on output 17 (Toggle #7)
Toggle #8	Input 18	Toggles state based on output 18 (Toggle #8)
Toggle #9	Input 19	Toggles state based on output 19 (Toggle #9)
Delay #5 (3 seconds)	Input 20	Turns ON 3 seconds after output 20 (Delay #5) transitions from OFF to ON
Delay #6 (5 seconds)	Input 21	Turns ON 5 seconds after output 21 (Delay #6) transitions from OFF to ON
Delay #7 (30 seconds)	Input 22	Turns ON 30 seconds after output 22 (Delay #7) transitions from OFF to ON
Delay #8 (600 seconds)	Input 23	Turns ON 600 seconds after output 23 (Delay #8) transitions from OFF to ON

*Shaded inputs are related to load management functions.*

 607 NW 27th Ave Ocala, FL 34475 Ph: 352-629-5020 or 1-800-533-3569 Fax : 352-629-290 or 1-800-520-3473	<b>TECHNICAL DATA SHEET</b>			<b>PAGE</b>	22 OF 29
	<b>PRODUCT GROUP</b>	<b>ES-KEY</b>	<b>P/N</b>	<b>DATE</b>	7/18/2012
			122116	<b>REV</b>	1.10
	<b>PRODUCT</b>	<b>USM II</b>		<b>BY</b>	<b>BHS</b>

### 7.3. Utility Module output memory space functions

The Utility module has 24 (0 through 23) dedicated output memory space functions as described in the table below.

Function	Memory Space	Description
High idle cancel	Output 0	Forces a cancel of the high idle request (input 2)
Enable load management	Output 1	Enables all load management functions
Mode switch	Output 2	Enables secondary mode of the load management system
Stage switch	Output 3	Enables secondary stage of the load management system
Toggle #1	Output 4	Each OFF to ON transition changes the state of input 4 (Toggle #1)
Toggle #2	Output 5	Each OFF to ON transition changes the state of input 5 (Toggle #2)
Delay #1	Output 6	Each OFF to ON transition activates input 6 (Delay #1)
1 second positive trigger	Output 7	Each OFF to ON transition activates trigger of input 7 (1 second positive trigger)
1 second trigger	Output 8	Each OFF to ON transition activates trigger of input 8 (1 second trigger)
Delay #2 (5 seconds)	Output 9	Each OFF to ON transition activates input 9 (Delay #2)
Delay #3 (30 seconds)	Output 10	Each OFF to ON transition activates input 10 (Delay #3)
Delay #4 (5 seconds)	Output 11	Each OFF to ON transition activates input 11 (Delay #4)
8 second positive trigger	Output 12	Each OFF to ON transition activates trigger of input 12 (8 second trigger)
24 Volt load management	Output 13	Set the load management system to 24V values rather than 12V values
Toggle #4	Output 14	Each OFF to ON transition changes the state of input 14 (Toggle #4)
Toggle #5	Output 15	Each OFF to ON transition changes the state of input 15 (Toggle #5)
Toggle #6	Output 16	Each OFF to ON transition changes the state of input 16 (Toggle #6)
Toggle #7	Output 17	Each OFF to ON transition changes the state of input 17 (Toggle #7)
Toggle #8	Output 18	Each OFF to ON transition changes the state of input 18 (Toggle #8)
Toggle #9	Output 19	Each OFF to ON transition changes the state of input 19 (Toggle #9)
Delay #5 (3 seconds)	Output 20	Each OFF to ON transition activates input 20 (Delay #5)
Delay #6 (5 seconds)	Output 21	Each OFF to ON transition activates input 21 (Delay #6)
Delay #7 (30 seconds)	Output 22	Each OFF to ON transition activates input 22 (Delay #7)
Delay #8 (600 seconds)	Output 23	Each OFF to ON transition activates input 23 (Delay #8)

*Shaded outputs are related to load management functions.*

 607 NW 27th Ave Ocala, FL 34475 Ph: 352-629-5020 or 1-800-533-3569 Fax: 352-629-290 or 1-800-520-3473	<b>TECHNICAL DATA SHEET</b>			<b>PAGE</b>	23 OF 29	
	<b>PRODUCT GROUP</b>	<b>ES-KEY</b>	<b>P/N</b>	<b>122116</b>	<b>DATE</b>	7/18/2012
	<b>PRODUCT</b>	<b>USM II</b>			<b>REV</b>	1.10
					<b>BY</b>	<b>BHS</b>

## 8. Universal System Manager Functions

A USM II configured will also function as the ES-Key system Universal System Manager (USM) as long as a standard (stand-alone) ES-Key USM is not in the physical network.

### 8.1. Load management enabling and functions

The USM II can be used as a load manager by implementing a Utility Module. Enable the load management function by activating output memory space 1 of the Utility Module (see section 7.3). There are five basic processes of the load management system: *operating mode*, *stage switch*, *priority*, *sequence level*, and *high idle*.

#### 8.1.1. Operating modes

The USM II load management allows two operating modes: mode A and mode B. Mode A is the default operating mode but mode B can be selected by activating output memory space 2 of the Utility Module (see section 7.3). Any output in the ES-Key database can be tied to one or both of the operating modes by checking the desired mode in its "Output Port Load Settings" under the "Settings" tab.

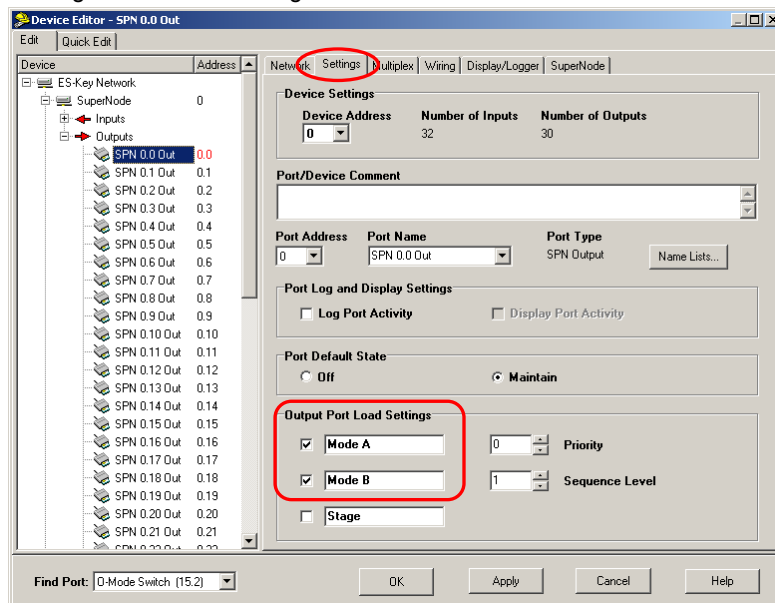

When an output is tied to both operating modes then the state of the mode switch is not important to the state of the output. However, if an output is tied to just one operating mode then the state of the output is controlled by the state of the mode switch as well as its normal multiplexing equation.

The names of the operating modes can be changed from the standard "modeA/modeB" to anything desired by modifying the text in the "Output Port Load Settings" area. On fire apparatus, mode A is typically referred to as "response" and mode B is typically referred to as "scene".

 607 NW 27th Ave Ocala, FL 34475 Ph: 352-629-5020 or 1-800-533-3569 Fax : 352-629-290 or 1-800-520-3473	<b>TECHNICAL DATA SHEET</b>			<b>PAGE</b>	24 OF 29
	<b>PRODUCT GROUP</b>	<b>ES-KEY</b>	<b>P/N</b>	<b>DATE</b>	7/18/2012
			122116	<b>REV</b>	1.10
	<b>PRODUCT</b>	<b>USM II</b>		<b>BY</b>	<b>BHS</b>

### 8.1.2. Stage switch (master switch)

All outputs can be tied or not tied to the stage switch. In fire apparatus this switch is typically referred to as the master switch. The state of the stage switch is controlled by Utility Module output memory space 3. When this output is active the stage switch is active. Any output tied to the stage switch will be OFF if the stage switch is not active regardless of the output's multiplex equation.

Set an output's to be tied to the stage switch by checking the stage switch box in its "Output Port Load Settings" under the "Settings" tab.

The name of the stage switch can be changed from the standard "stage" to anything desired by modifying the text in the "Output Port Load Settings" area.

### 8.1.3. Priority

Priority refers to the shed and unshed level to which the output is tied. There are eight (8) priority levels (0 through 7) which indicate the voltage level required to turn OFF (shed) or turn ON (unshed) the output in response to changes in the vehicles system voltage level. Any output in the ES-Key database can be tied to one of the eight priority levels in its "Output Port Load Settings" under the "Settings" tab.

Priority	12 Volt system		24 Volt system	
	Shed voltage	Unshed voltage	Shed voltage	Unshed voltage
7	< 12.8V	> 12.7V	< 25.5V	> 25.4V
6	< 12.7V	> 12.6V	< 25.3V	> 25.2V
5	< 12.5V	> 12.4V	< 24.9V	> 24.8V
4	< 12.3V	> 12.2V	< 24.5V	> 24.4V
3	< 12.1V	> 12.0V	< 24.1V	> 24.0V
2	< 11.9V	> 11.8V	< 23.7V	> 23.6V
1	< 11.5V	> 11.3V	< 22.9V	> 22.8V
0	Never shed	----	Never shed	----

#### A. LOAD SHEDDING

An output is shed (turned OFF) when the system voltage drops below the designated priority level's shed voltage for thirty (30) seconds. If the voltage has dropped below multiple priority level shed voltages then each higher priority level will shed before the lower priority levels. For example, if the voltage was at 13.9 volts and then fell rapidly to 12.4 volts, after 30 seconds all outputs at priority level 7 will shed, then 30 seconds later all outputs at priority level 6 will shed, and 30 seconds later all outputs at priority level 5 will shed.

#### B. LOAD UNSHEDDING

An output is unshed (turned back ON) when the system voltage rises above the designated priority level's unshed voltage for ten (10) seconds. If the voltage has risen above multiple priority level unshed voltages then each lower priority level will unshed before the upper priority levels. For example, if the voltage was at 12.4 volts and then rose rapidly to 13.9 volts, after 10 seconds all outputs at priority level 5 will unshed, then 10 seconds later all outputs at priority level 6 will unshed, and 10 seconds later all outputs at priority level 7 will unshed.

#### C. LOAD MANAGEMENT VOLTAGE RANGE

The load management voltage range can be set to 12 volts (default) or 24 volts. Nothing needs to be done to use the 12 volt shed/unshed ranges. To set the system to use the 24 volt shed/unshed ranges the Utility Module memory output space 13 (24 volt load management) must be activated (see section 7.3).



 607 NW 27th Ave Ocala, FL 34475 Ph: 352-629-5020 or 1-800-533-3569 Fax : 352-629-290 or 1-800-520-3473	<b>TECHNICAL DATA SHEET</b>				<b>PAGE</b>	25 OF 29
					<b>DATE</b>	7/18/2012
	<b>PRODUCT GROUP</b>	<b>ES-KEY</b>	<b>P/N</b>	122116	<b>REV</b>	1.10
	<b>PRODUCT</b>	<b>USM II</b>			<b>BY</b>	<b>BHS</b>

#### 8.1.4. Sequence level

Outputs can be tied to one of 4 sequence levels (1 through 4). When the output is turned ON due to its association with an operating mode (mode A, mode B) all outputs on sequence level 1 are turned ON first, then a half second later all outputs on sequence level 2 are turned ON, then a half second later all outputs on sequence level 3 are turned ON, and finally a half second later all outputs on sequence level 4 are turned ON. The reverse is true when the associated operating mode is turned OFF.

#### 8.1.5. High idle

The Utility Module's high idle request (input memory space 2) is activated when the system voltage drops below the high idle threshold (12.8 volts standard or 25.6 volts if 24 volt load management is enabled) for 8 seconds or longer **AND** load management has been enabled (Utility Module output memory space 1 is active). The high idle request will remain active as long as the voltage remains below the voltage threshold and for 3 minutes after the system voltage rises above the voltage threshold. High idle can be canceled by activating the Utility Module's high idle cancel (output memory space 0).

 607 NW 27th Ave Ocala, FL 34475 Ph: 352-629-5020 or 1-800-533-3569 Fax : 352-629-290 or 1-800-520-3473	<b>TECHNICAL DATA SHEET</b>			<b>PAGE</b>	26 OF 29
				<b>DATE</b>	7/18/2012
<b>PRODUCT GROUP</b>	ES-KEY	<b>P/N</b>	122116	<b>REV</b>	1.10
<b>PRODUCT</b>	<b>USM II</b>			<b>BY</b>	<b>BHS</b>

## 9. USB port

The USM II's USB port allows database transfers and diagnostics with the ES-Key Professional software.

Connect the USM II to a computer running the ES-Key Pro software with harness part number 513-00011.

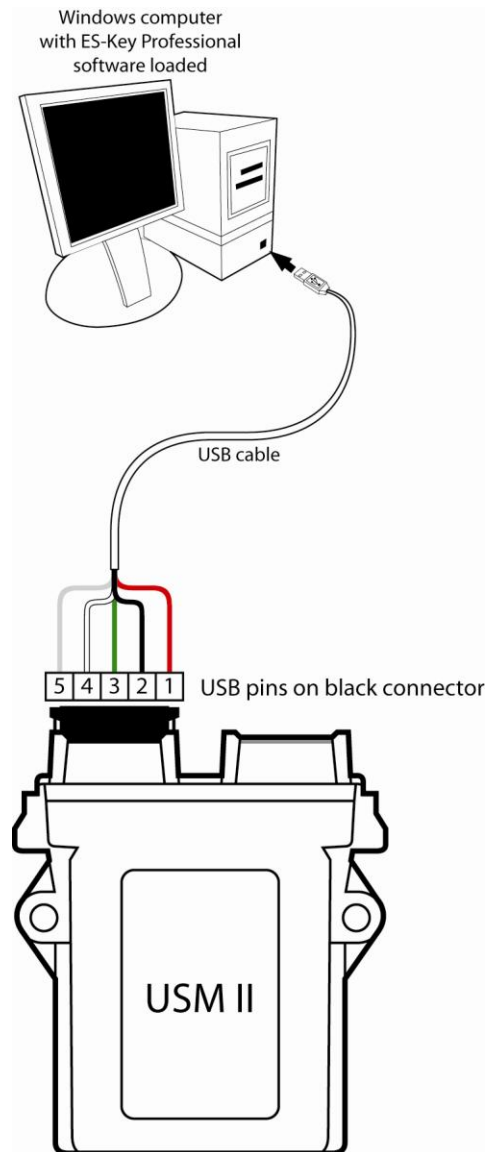

 <p>607 NW 27th Ave Ocala, FL 34475 Ph: 352-629-5020 or 1-800-533-3569 Fax: 352-629-290 or 1-800-520-3473</p>	<b>TECHNICAL DATA SHEET</b>			<b>PAGE</b>	27 OF 29
	<b>PRODUCT GROUP</b>	ES-KEY	<b>P/N</b>	122116	<b>DATE</b>
<b>PRODUCT</b>	<b>USM II</b>			<b>REV</b>	1.10
				<b>BY</b>	<b>BHS</b>

## 10. Dimensions

The USM II is a water tight unit (IP67) and is mounted using two 1/4" — 20 screws.  
 The overall dimensions are (L x W x D, inches [millimeters]) 5.240" [133.10] x 4.630" [117.60] x 1.460" [37.08].

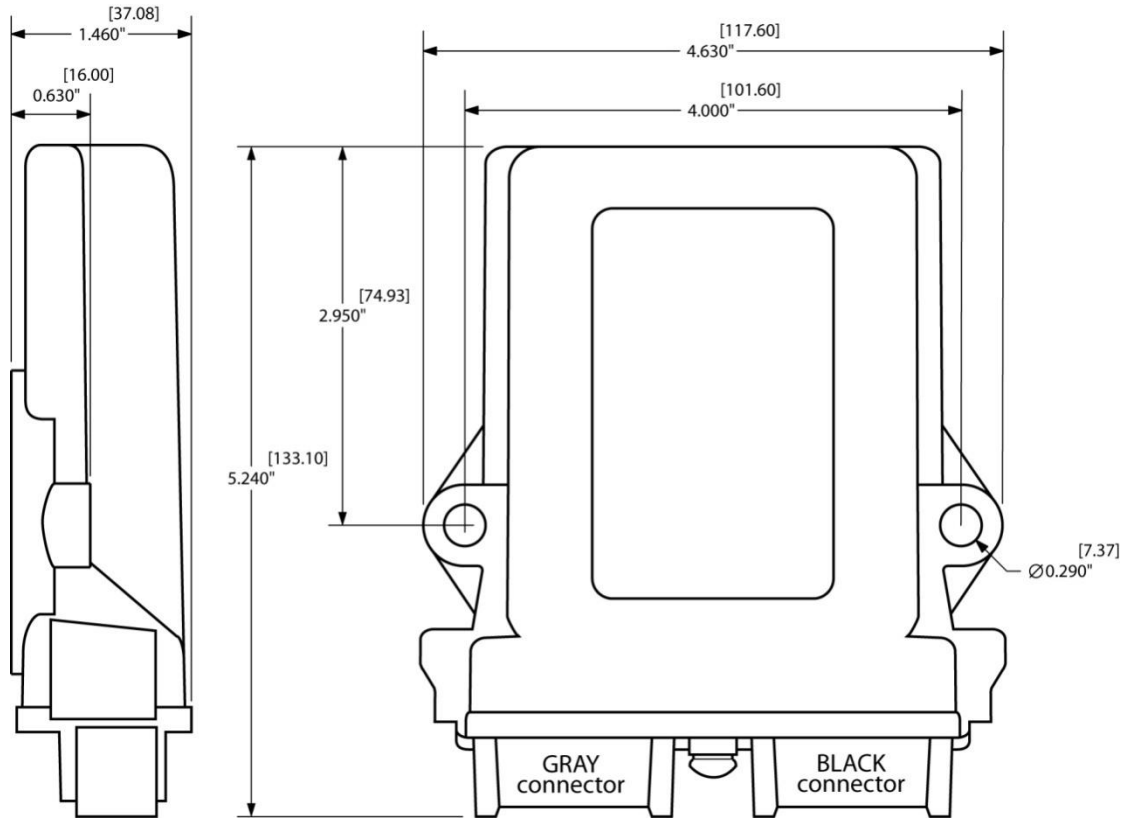

Dimensions in inches [millimeters].

**MOUNTING NOTE:** When mounting the module vertically, make certain the connectors are pointed down so as to eliminate the possibility of standing water in the connector.

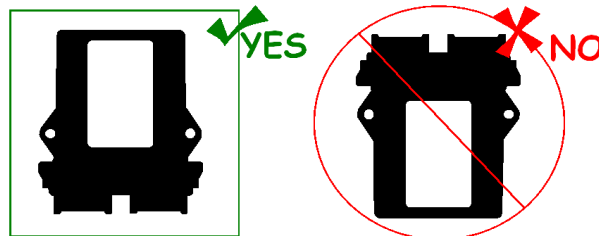

 607 NW 27th Ave Ocala, FL 34475 Ph: 352-629-5020 or 1-800-533-3569 Fax : 352-629-290 or 1-800-520-3473	<b>TECHNICAL DATA SHEET</b>			<b>PAGE</b>	28 OF 29	
	<b>PRODUCT GROUP</b>	<b>ES-KEY</b>	<b>P/N</b>	<b>122116</b>	<b>DATE</b>	7/18/2012
	<b>PRODUCT</b>	<b>USM II</b>			<b>REV</b>	1.10
					<b>BY</b>	<b>BHS</b>

## 11. Connector Descriptions

### 11.1. Outputs / Inputs

All outputs are located on the two 12-pin Deutsch connectors (gray and black).

Mating connector: Deutsch DT06-12SB BLACK		Mating sockets: 0462-201-16141	
Wedge lock: W12S		Recommended wire gage: 16-18 AWG	
PIN	DESCRIPTION	FEATURES	
1	USB Power	USB 2.0	
2	USB Ground	USB 2.0	
3	USB D + (Digital)	USB 2.0	
4	USB D – (Digital)	USB 2.0	
5	USB Shield	USB 2.0	
6	Input 4	Selectable Polarity	
7	Input 5	Selectable Polarity	
8	Output 3	Selectable polarity, 500mA max current	
9	Output 4	Selectable polarity, 500mA max current	
10	J1939 CAN High	250 Kbits /s	
11	J1939 CAN Low	250 Kbits /s	
12	J1939 CAN Shield	250 Kbits /s	

Mating connector: Deutsch DT06-12SA GRAY		Mating sockets: 0462-201-16141	
Wedge lock: W12S		Recommended wire gage: 16-18 AWG	
PIN	DESCRIPTION	FEATURES	
1	Power (SUPPLY+)	+9V...+32V (Vehicle Ignition)	
2	ES-Key CAN High	250 Kbits /s	
3	ES-Key CAN Shield	250 Kbits /s	
4	Input 0	Selectable Polarity	
5	Input 1	Selectable Polarity	
6	Input 2	Selectable Polarity	
7	Input 3	Selectable Polarity	
8	Output 0	Selectable polarity, 500mA max current	
9	Output 1	Selectable polarity, 500mA max current	
10	Output 2	Selectable polarity, 500mA max current	
11	Es-Key CAN Low	250 Kbits /s	
12	Ground (SUPPLY-)	Vehicle Ground	

 607 NW 27th Ave Ocala, FL 34475 Ph: 352-629-5020 or 1-800-533-3569 Fax : 352-629-290 or 1-800-520-3473	<b>TECHNICAL DATA SHEET</b>			<b>PAGE</b>	29 OF 29
	<b>PRODUCT GROUP</b>	<b>ES-KEY</b>	<b>P/N</b>	<b>DATE</b>	7/18/2012
	<b>PRODUCT</b>	<b>USM II</b>		<b>REV</b>	1.10
				<b>BY</b>	<b>BHS</b>

## 12. Diagnostic LEDs

The USM II has 5 LEDs located on the PCB board. There are 2 LEDs for power communication, 1 for ES-Key CAN communication status, 1 for SAE J1939 CAN communication status, and 1 LED for USB connectivity status.

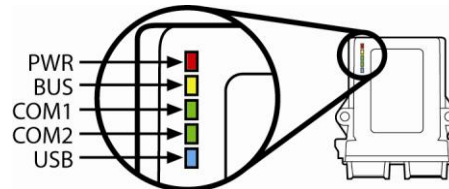

COM 1 LED (ES-Key)	Description
ON solid	USM II online
Flashing slow (1 Hz)	CAN okay, not configured for network
Flashing fast (4 Hz)	CAN has physical problem

COM 2 LED (J1939)	Description
ON solid	Receiving J1939 data
Flashing	Not receiving J1939 data, configured
Flashing fast (4 Hz)	Not receiving J1939 data, not configured

USB ACTIVE LED	Description
ON	USB port connected and ACTIVE
OFF	USB port not connected

## 13. Technical details

Product category	ES-Key network
Voltage range	+9VDC...+32VDC
Power consumption	Supply + Input (pin 1 of the gray 12-pin Deutsch connector)
@13.8VDC	100mA
@27.6VDC	125mA
Output power	500mA per selectable polarity output
Temperature range	-40°C...+85°C
Environmental range	IP 67
CAN specification	SAE J1939 standard, 250 Kbits/second
LEDs	2 LEDs for power, 2 LEDs for comm, and 1 LED for USB connectivity.
Protection	<ul style="list-style-type: none"> <li>Internal thermal fuse (750mA on pin 1 of gray 12-pin connector)</li> <li>Reverse voltage protection (pins 1 (Supply+) and 12 (Supply-) of 12-pin gray connector)</li> <li>CAN buses protected to 24V</li> <li>ESD voltage protected to SAE J1113 specification for heavy duty trucks (24V)</li> <li>Transient voltage protected to SAE J1113 specification for heavy duty trucks (24V)</li> <li>Load dump voltage protected to SAE J1113 specification for heavy duty trucks (24V)</li> <li>Outputs protected for short circuit and thermal overload</li> </ul>
Dimensions (W x H x D) in inches [mm]	11.06 [280.92] x 2.56 [65.02] x 7.31 [185.67]