



Class 1

ISO 9001 CERTIFIED

607 NW 27th Ave
Ocala, FL 34475
Phone: (352) 629-5020 or 800-533-3569
Fax: (352)-629-2902

SUITABLE FOR EXTERNAL DISTRIBUTION

TECHNICAL DATASHEET

1Touch[®] Switch Panel

1200-04-00-CL1 (4 position)
1200-08-00-CL1 (8 position)
1200-12-00-CL1 (12 position)
1200-16-00-CL1 (16 position)



 607 NW 27th Ave Ocala, FL 34475 Ph: 352-629-5020 or 1-800-533-3569 Fax: 352-629-2902 or 1-800-520-3473	TECHNICAL DATA SHEET			PAGE	1 OF 23	
	PRODUCT GROUP	ES-Key	P/N	1200-XX-00-CL1 (XX=04,08,12,16)	DATE	5/19/2011
	PRODUCT	1Touch® Switch Panel			REV	1.20
					BY	AMS

1.	REVISION LOG	2
2.	PART NUMBERS	3
2.1.	1TOUCH SWITCH PART NUMBERS	3
2.2.	MISCELLANEOUS PART NUMBERS.....	3
3.	OVERVIEW	4
3.1.	PRODUCT DESCRIPTION	4
3.2.	FEATURES	5
3.3.	INDICATORS AND SWITCHES.....	5
3.3.1.	<i>Diagnostic indicator</i>	5
3.3.2.	<i>Shorted switch indication</i>	6
3.3.3.	<i>Memory error indication</i>	6
3.4.	DEVICE TYPE AND ADDRESS	6
4.	ES-KEY NETWORK DETAIL	7
4.1.	INPUT/OUTPUT MEMORY SPACE	7
4.1.1.	<i>I/O memory space map</i>	7
5.	OPERATION	8
5.1.	INITIALIZATION CYCLE	8
5.2.	NORMAL OPERATION	8
5.3.	MASTER SWITCH OPERATION.....	9
5.3.1.	<i>Master switch OFF</i>	10
5.3.2.	<i>Master switch ON</i>	10
5.4.	DIM INPUT OPERATION.....	10
5.4.1.	<i>Digital input</i>	10
5.4.2.	<i>Analog input</i>	10
6.	CONFIGURATION ENTRY METHODS	11
6.1.	ENTERING PASSWORDS.....	11
6.1.1.	<i>List of passwords</i>	11
6.2.	"PRESS AND HOLD" SWITCH TYPE CONFIGURATION METHOD	12
7.	CONFIGURATION PROCEDURES	13
7.1.	SWITCH TYPE CONFIGURATION	13
7.2.	LOAD DEFAULTS.....	14
7.3.	ADDRESS CONFIGURATION	14
7.4.	DEVICE TYPE CONFIGURATION	14
7.5.	INITIAL SWITCH STATES CONFIGURATION	15
7.6.	LED INDICATOR CONTROL SOURCE CONFIGURATION	15
7.7.	MASTER SWITCH CONFIGURATION.....	15
7.8.	DIM INPUT TYPE CONFIGURATION	16
7.9.	DIM LEVEL CONFIGURATION	16
7.10.	NETWORK MODE CONFIGURATION.....	17
7.11.	PEER-TO-PEER MAPPING	17
8.	MOUNTING AND INSTALLATION	18
8.1.	SWITCH CAP INSTALLATION.....	18
8.2.	SWITCH CAP REMOVAL	19
8.3.	SIDE VIEW DIMENSIONS (ALL MODELS)	19
8.4.	MOUNTING DIMENSIONS (4 POSITION, 1200-04-00-CL1)	20
8.5.	MOUNTING DIMENSIONS (8 POSITION, 1200-08-00-CL1)	20
8.6.	MOUNTING DIMENSIONS (12 POSITION, 1200-12-00-CL1)	21
8.7.	MOUNTING DIMENSIONS (16 POSITION, 1200-16-00-CL1)	21
9.	CONNECTOR DESCRIPTION	22
10.	REFERENCES	22
10.1.	LIST OF FIGURES.....	22
10.2.	LIST OF TABLES.....	22
11.	TECHNICAL DETAILS AND COMPLIANCES	23

 607 NW 27th Ave Ocala, FL 34475 Ph: 352-629-5020 or 1-800-533-3569 Fax: 352-629-2902 or 1-800-520-3473	TECHNICAL DATA SHEET			PAGE	2 OF 23	
	PRODUCT GROUP	ES-Key	P/N	1200-XX-00-CL1 (XX=04,08,12,16)	DATE	5/19/2011
	PRODUCT	1Touch® Switch Panel			REV	1.20
					BY	AMS

1. Revision Log

Rev	Date	Changes
1.00	11/10/2010	Initial revision
1.10	11/22/2010	Updated part numbers for clear switch caps
1.20	5/19/2011	Added registered trademark symbol



Product specifications in this manual are subject to change without notice.

 607 NW 27th Ave Ocala, FL 34475 Ph: 352-629-5020 or 1-800-533-3569 Fax: 352-629-2902 or 1-800-520-3473	TECHNICAL DATA SHEET			PAGE	3 OF 23	
	PRODUCT GROUP	ES-Key	P/N	1200-XX-00-CL1 (XX=04,08,12,16)	DATE	5/19/2011
	PRODUCT	1Touch® Switch Panel			REV	1.20
					BY	AMS

2. Part Numbers

2.1. 1Touch® Switch part numbers

1Touch Switch, 4 position	1200-04-00-CL1
1Touch Switch, 8 position	1200-08-00-CL1
1Touch Switch, 12 position	1200-12-00-CL1
1Touch Switch, 16 position	1200-16-00-CL1

These part numbers include the 1Touch® switch panel, clear switch caps (+1 extra), quick reference guide, and overlay. Individual switch label are not included and must be supplied by the OEM. Refer to section 8.1 for details regarding the switch label size.

1Touch switch cap, standard, clear	120723
1Touch switch cap, standard, red	120723-01
1Touch switch cap, standard, amber	120723-02
1Touch switch cap, standard, yellow	120723-03
1Touch switch cap, standard, green	120723-04
1Touch switch cap, standard, blue	120723-05

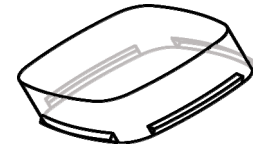

1Touch switch cap, contoured, clear	121306
1Touch switch cap, contoured, red	121306-01
1Touch switch cap, contoured, amber	121306-02
1Touch switch cap, contoured, yellow	121306-03
1Touch switch cap, contoured, green	121306-04
1Touch switch cap, contoured, blue	121306-05

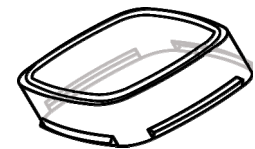

Documentation (available from Class 1's website - www.class1.com)

Full Manual (this manual)	121677
Quick reference guide	121693

2.2. Miscellaneous part numbers

1Touch Switch connector items

Deutsch 6-position mating plug	DT06-6S
Deutsch 6-position mating plug wedge lock	W6S
Deutsch DT series socket (16 GA)	0462-201-16141
Deutsch DT series socket (16 GA) - GOLD	0462-201-1631

CAN connector items

Deutsch 3-position mating plug - GRAYDT06-3S	
Deutsch 3-position mating plug wedge lock - BLUE	W3S-1939
Deutsch 3-position mating plug wedge lock - ORANGE	W3S
Deutsch DT series socket (16 GA) - GOLD	0462-201-1631
Deutsch DT series 3-way "Y" receptacle	DT04-3P-P007
Deutsch 3-position mating plug with terminating resistor	DT06-3S-P006

 607 NW 27th Ave Ocala, FL 34475 Ph: 352-629-5020 or 1-800-533-3569 Fax: 352-629-2902 or 1-800-520-3473	TECHNICAL DATA SHEET			PAGE	4 OF 23	
	PRODUCT GROUP	ES-Key	P/N	1200-XX-00-CL1 (XX=04,08,12,16)	DATE	5/19/2011
	PRODUCT	1Touch® Switch Panel			REV	1.20
					BY	AMS

3. Overview

3.1. Product description

The ES-Key™ 1Touch® switch panel is a fully customizable switch solution for utilization within a Class 1 ES-Key distributed multiplex network (or peer-to-peer networks). The 1Touch switch allows control and indication of outputs configured within the network database.

The 1Touch switch panel is available in four layouts: 4 switches (2 pairs, p/n 1200-04-00-CL1), 8 switches (4 pairs, p/n 1200-08-00-CL1), 12 switches (6 pairs, p/n 1200-12-00-CL1), and 16 switches (8 pairs, p/n 1200-16-00-CL1).

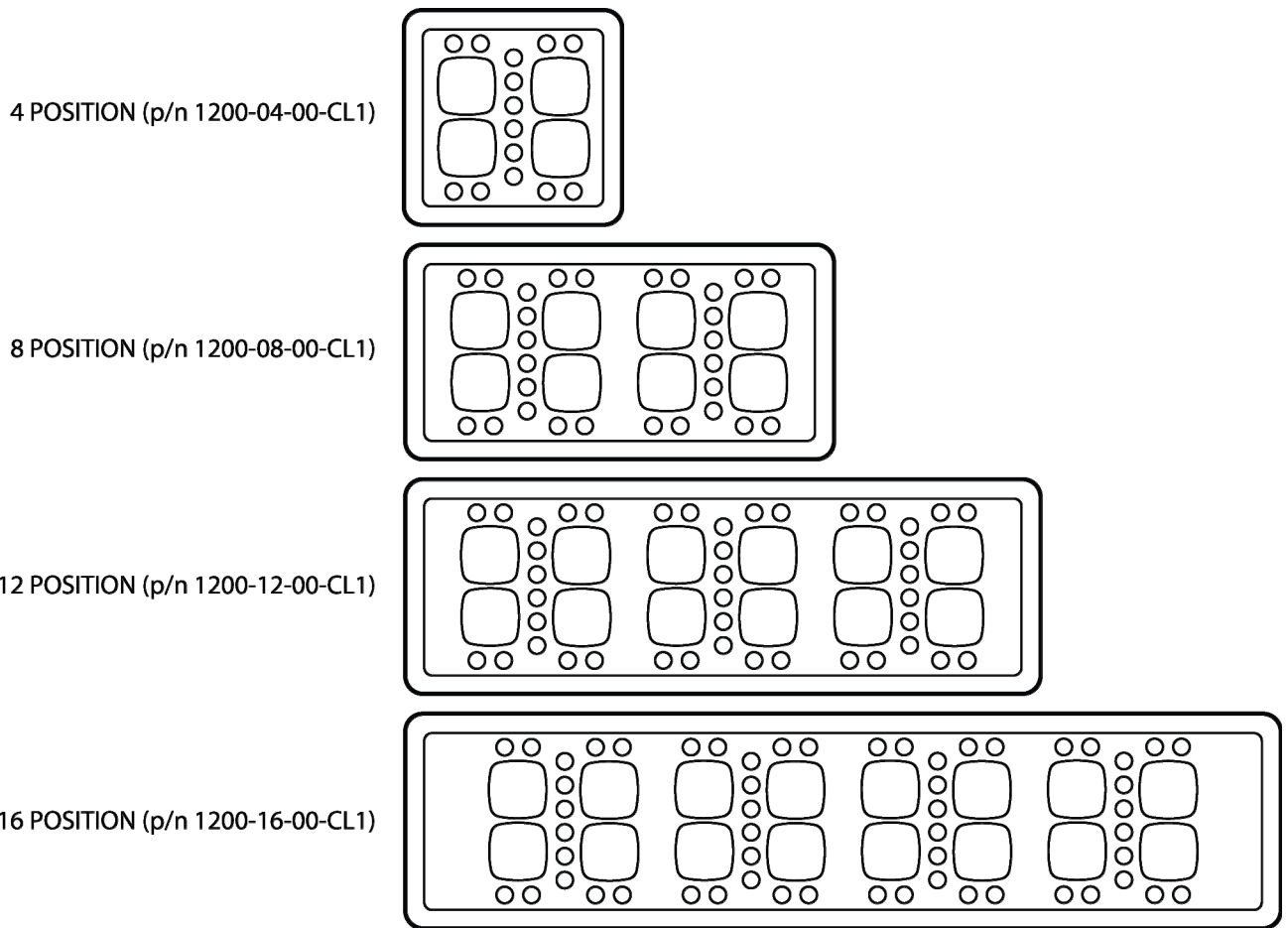



Figure 1. Available 1Touch switch panel layouts.

 607 NW 27th Ave Ocala, FL 34475 Ph: 352-629-5020 or 1-800-533-3569 Fax: 352-629-2902 or 1-800-520-3473	TECHNICAL DATA SHEET			PAGE	5 OF 23	
	PRODUCT GROUP	ES-Key	P/N	1200-XX-00-CL1 (XX=04,08,12,16)	DATE	5/19/2011
	PRODUCT	1Touch® Switch Panel			REV	1.20
					BY	AMS

3.2. Features

- Backlit switches with customizable transparent colored switch caps (clear, red, amber, yellow, green, and blue)
- Customizable switch labels protected by the switch caps
- Dimmable backlighting
- Configurable switches with 6 switch functions (momentary, bi-stable, dimmer, and 3 toggle switch types)
- Two state indicator LEDs (green and yellow) per switch
- ES-Key network and peer-to-peer compatible
- 12 and 24 volt operation
- Sealed to IP67

3.3. Indicators and switches

The 1Touch switch is comprised of paired switches (upper and lower) and each switch has its own set of backlighting (white) and indicator LEDs (green and yellow). Between every other pair of switches is a LED bargraph (red) used as a dim level indication for switches configured as a dimmer type switch. The left-most LED bargraph serves a dual purpose as a diagnostic indicator (see section 3.3.1).

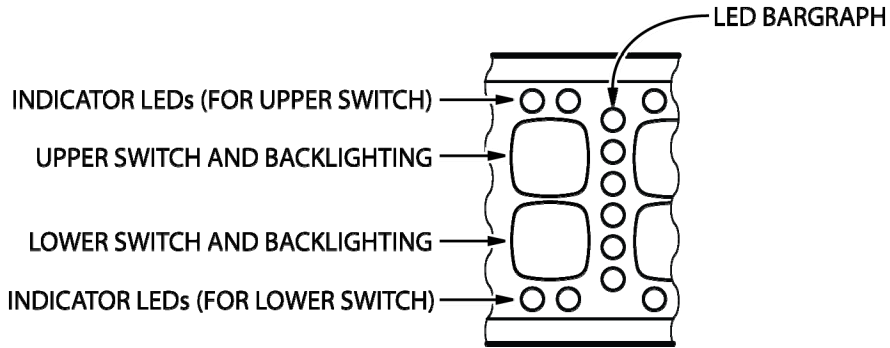

Figure 2. Indicators and switches.

3.3.1. Diagnostic indicator

The 1Touch switch uses the left-most LED bargraph (red) as a diagnostic indicator to display error conditions.

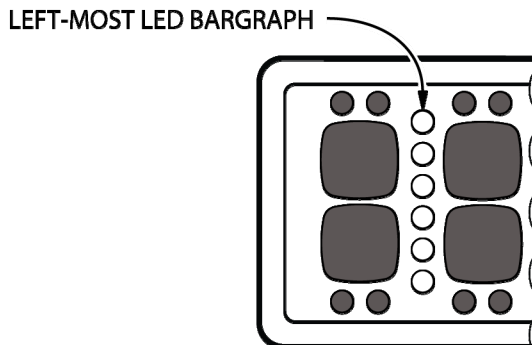



Figure 3. Diagnostic indicator (left-most bargraph).

 607 NW 27th Ave Ocala, FL 34475 Ph: 352-629-5020 or 1-800-533-3569 Fax: 352-629-2902 or 1-800-520-3473	TECHNICAL DATA SHEET			PAGE	6 OF 23	
	PRODUCT GROUP	ES-Key	P/N	1200-XX-00-CL1 (XX=04,08,12,16)	DATE	5/19/2011
	PRODUCT	1Touch® Switch Panel			REV	1.20
					BY	AMS

Diagnostic indications

LED state	Description
OFF (or operating as a dim indicator)	CAN communication active, no errors detected.
<i>Cycling slowly</i> (2.5 seconds back and forth)	<i>CAN bus okay, but no communication with the ES-Key USM. Verify CAN bus connection to the USM.</i>
<i>Cycling quickly</i> (0.5 seconds back and forth)	<i>CAN bus error (passive). Verify terminating resistors are correctly installed on CAN bus. Evaluate CAN bus wiring for shorts, improper wiring, etc.</i>
<i>Upper 3 and lower 3 alternate flashing</i> (0.5 seconds)	<i>CAN bus error (active). Verify terminating resistors are correctly installed on CAN bus. Evaluate CAN bus wiring for shorts, improper wiring, etc.</i>
<i>All flashing</i> (0.5 seconds)	<i>Address conflict with another 1Touch Switch. Verify that another 1Touch Switch with the same address is not connected to the bus.</i>

Table 1. Diagnostic indications (left-most bargraph).

3.3.2. Shorted switch indication

The 1Touch checks its switches for a shorted condition (always active) during initialization. The 1Touch flashes the backlighting of a suspected shorted switch. For safety, the input space associated with the suspected shorted switch is forced to OFF. The suspected shorted switch will resume normal operation if the short condition is no longer detected.

3.3.3. Memory error indication

The 1Touch checks all of the configuration data during initialization and after configuration saves. The 1Touch will flash the switch backlighting if a memory error is detected. The 1Touch uses the default settings (see section 7.2) and sets the switch types to momentary during a memory error.

3.4. Device type and address

The 1Touch is recognized by the ES-Key Professional software as a **SPS Module** (default), but may be configured via password as an Input/Output Module (see section 7.4).

The 1Touch's **address is 0** (default), but may be configured to any valid ES-Key address by entering a password (see section 7.3).

 607 NW 27th Ave Ocala, FL 34475 Ph: 352-629-5020 or 1-800-533-3569 Fax: 352-629-2902 or 1-800-520-3473	TECHNICAL DATA SHEET			PAGE	7 OF 23	
	PRODUCT GROUP	ES-Key	P/N	1200-XX-00-CL1 (XX=04,08,12,16)	DATE	5/19/2011
	PRODUCT	1Touch® Switch Panel			REV	1.20
					BY	AMS

4. ES-Key Network Detail

4.1. Input/output memory space

The 1Touch Switch uses ES-Key defined input and output memory space.

- The state of the switches is mapped into the input memory space.
- The control of the green and yellow indicator LEDs is mapped into the output memory space (*NOTE: The control of these LEDs is only allowed if the 1Touch Switch has been set to ES-Key LED control – see section 7.6).*

4.1.1. I/O memory space map

INPUT MEMORY SPACE		OUTPUT MEMORY SPACE	
INPUT	DESCRIPTION	OUTPUT	LOCATION
0	Switch state – 0	0	Green LED indicator switch 0
1	Switch state – 1	1	Green LED indicator switch 1
2	Switch state – 2	2	Green LED indicator switch 2
3	Switch state – 3	3	Green LED indicator switch 3
4	Switch state – 4	4	Green LED indicator switch 4
5	Switch state – 5	5	Green LED indicator switch 5
6	Switch state – 6	6	Green LED indicator switch 6
7	Switch state – 7	7	Green LED indicator switch 7
8	Switch state – 8	8	Green LED indicator switch 8
9	Switch state – 9	9	Green LED indicator switch 9
10	Switch state – 10	10	Green LED indicator switch 10
11	Switch state – 11	11	Green LED indicator switch 11
12	Switch state – 12	12	Green LED indicator switch 12
13	Switch state – 13	13	Green LED indicator switch 13
14	Switch state – 14	14	Green LED indicator switch 14
15	Switch state – 15	15	Green LED indicator switch 15
16	reserved	16	Yellow LED indicator switch 0
17	reserved	17	Yellow LED indicator switch 1
18	reserved	18	Yellow LED indicator switch 2
19	reserved	19	Yellow LED indicator switch 3
20	reserved	20	Yellow LED indicator switch 4
21	reserved	21	Yellow LED indicator switch 5
22	reserved	22	Yellow LED indicator switch 6
23	reserved	23	Yellow LED indicator switch 7
24	reserved	24	Yellow LED indicator switch 8
25	reserved	25	Yellow LED indicator switch 9
26	reserved	26	Yellow LED indicator switch 10
27	reserved	27	Yellow LED indicator switch 11
28	reserved	28	Yellow LED indicator switch 12
29	reserved	29	Yellow LED indicator switch 13
30	reserved	30	Yellow LED indicator switch 14
31	reserved	31	Yellow LED indicator switch 15

Table 2. I/O memory space map.

 607 NW 27th Ave Ocala, FL 34475 Ph: 352-629-5020 or 1-800-533-3569 Fax: 352-629-2902 or 1-800-520-3473	TECHNICAL DATA SHEET			PAGE	8 OF 23	
	PRODUCT GROUP	ES-Key	P/N	1200-XX-00-CL1 (XX=04,08,12,16)	DATE	5/19/2011
	PRODUCT	1Touch® Switch Panel			REV	1.20
					BY	AMS

5. Operation

5.1. Initialization cycle

The 1Touch switch turns ON all of its lighting (switch backlighting, bargraphs, and indicator LEDs) for the first second after a power cycle and then begins normal operation (section 5.2). This initialization cycle may be used to verify the operation of the LED indicators.

5.2. Normal operation

The 1Touch switch begins normal operation after the initialization cycle (section 5.1). The switches will operate as the switch type for which they were configured (bi-stable switches by default).

The graphic below (**Figure 4**) shows the position of the switches and their associated indicator LEDs. The switches are mapped into input memory space (section 4.1). The state of each switch is transmitted via the input memory space CAN message for use within the ES-Key database. The indicator LEDs are (by default) mapped for **internal control** but may be mapped for **ES-Key control** in the output memory space.

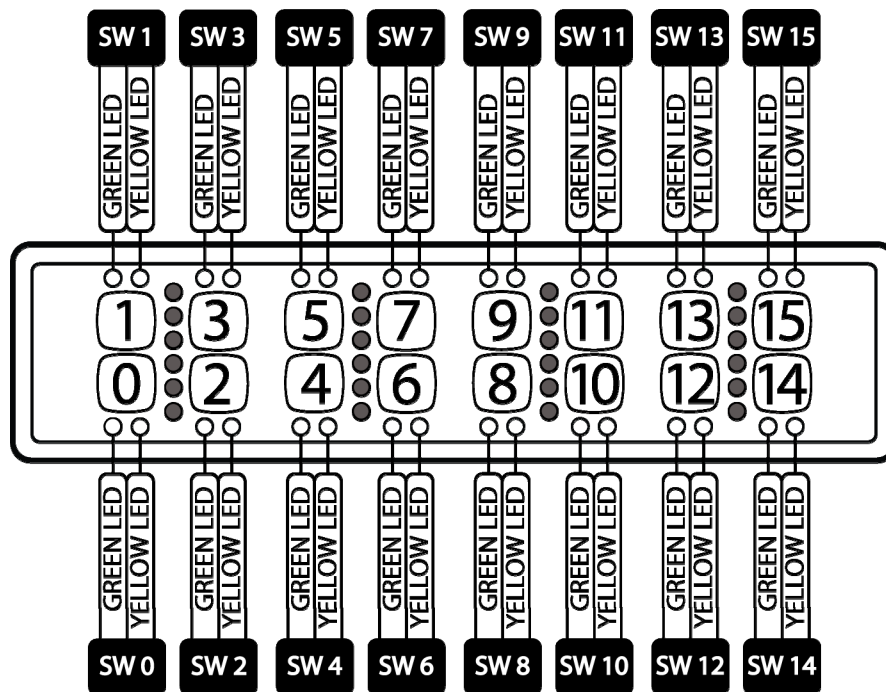



Figure 4. Switch and indicator LED identification.

Internal control of the indicators (default)

The output memory space (section 4.1) is not used for internal indicator control. A switch's associated green indicator LED is ON when the switch position is ON. The yellow indicator LEDs are not used and are always OFF.

ES-Key control of the indicators

The switch state does not control the state of the associated green or yellow LEDs. The output memory space (section 4.1) is must be used to control the state of the green and yellow indicator LEDs through the ES-Key database.

 607 NW 27th Ave Ocala, FL 34475 Ph: 352-629-5020 or 1-800-533-3569 Fax: 352-629-2902 or 1-800-520-3473	TECHNICAL DATA SHEET			PAGE	9 OF 23	
	PRODUCT GROUP	ES-Key	P/N	1200-XX-00-CL1 (XX=04,08,12,16)	DATE	5/19/2011
	PRODUCT	1Touch® Switch Panel			REV	1.20
					BY	AMS

The 1Touch switches can be configured for **individual switch types** and **paired switch types**.

- Individual switch types are those that can be configured to an individual switch where its operation does not affect the operation of its complementary switch. Complementary switches are a lower and upper pair. For example, switches 0 and 1 are complementary; switches 2 and 3 are complementary, etc.
- Paired switch types are those whose switch operation affects its complementary switch.

Individual switch types. The upper and lower switches in a complementary pair are not associated.

1. No function
Pressing the switch has no effect on the input memory space associated with the switch position.
2. Momentary
The input memory space associated with the switch position is only ON while the switch is pressed.
3. Bi-stable (default switch type)
The input memory space associated with the switch position toggles with every press of the switch.

Paired switch types. The upper and lower switches work together as a pair.

4. Toggle (upper switch = ON)
The switch pair acts a single toggle switch with the upper switch turning ON its associated input memory space and the lower switch turning OFF the upper switch's input memory space.
5. Toggle (lower switch = ON)
The switch pair acts a single toggle switch with the lower switch turning ON its associated input memory space and the upper switch turning OFF the lower switch's input memory space.
6. Toggle (exclusive)
The switch pair acts as an exclusive toggle switch.
Each upper switch press toggles the state of its associated input memory space while turning OFF the input memory space of the lower switch.
Each lower switch press toggles the state of its associated input memory space while turning OFF the input memory space of the upper switch.
7. Dimmer
The upper switch increases the brightness of the 1Touch panel lighting.
The lower switch decreases the brightness of the 1Touch panel lighting.
The closest LED bargraph shows the relative brightness of the 1Touch panel lighting.
Only one dimmer switch is allowed. The dimmer switch type option will not be available if another switch pair has previously been configured as a dimmer.

5.3. Master switch operation

The 1Touch allows a switch pair to be configured as a master switch. The master switch controls the state of all the other switches and will only allow the other switches to operate when the master switch is ON. The master switch is always initialized OFF during a power cycle (regardless of the initial switch state configuration). Only one master switch may be configured for the 1Touch switch (see section 7.7).

Permitted master switch types

A master switch can be configured as a toggle (upper switch = ON) or a toggle (lower switch = ON).

 607 NW 27th Ave Ocala, FL 34475 Ph: 352-629-5020 or 1-800-533-3569 Fax: 352-629-2902 or 1-800-520-3473	TECHNICAL DATA SHEET			PAGE	10 OF 23	
	PRODUCT GROUP	ES-Key	P/N	1200-XX-00-CL1 (XX=04,08,12,16)	DATE	5/19/2011
	PRODUCT	1Touch® Switch Panel			REV	1.20
					BY	AMS

5.3.1. Master switch OFF

When the master switch is turned OFF the input memory space is completely cleared and the backlighting of all of the other switches will be OFF. Any indicator LEDs which were ON before the master switch was turned OFF begin pulsating. The pulsating indicator LEDs show the switches which will be ON when the master switch is turned back ON.

5.3.2. Master switch ON

When the master switch is turned ON the input memory space returns to the state it held before the master switch was turned OFF. All other switches resume their normal operation.

5.4. Dim input operation

Pin 3 of the 6-pin Deutsch connector is the dim level input. The dim level input can be configured as a digital input (default) or an analog input (see section 7.8).

The dim input does not function if a switch has been configured as a dimmer. The dimmer type switch takes priority over the physical dim input (pin 3).

5.4.1. Digital input

The 1Touch's panel lighting is set to the brightest setting when the dim input (pin 3) is open (not connected to any voltage level) or connected to ground.

The 1Touch's panel lighting is set to the configured dim level when system voltage is applied to the dim input (pin 3).

The dim level's default level is mid-brightness, but it may be configured for any of the brightness levels (see section 7.9).

The voltage required to activate the dim input is a minimum of half of the system voltage. System voltage is the voltage level applied to pin 1 of the 6-pin Deutsch connector.

This method of controlling the 1Touch's dim level is perfect for day/night control.

5.4.2. Analog input

The 1Touch's panel lighting is set to one of the sixteen dim levels (from dimmest to brightest) based on a variable voltage level applied to the dim input (pin 3).

The variable voltage can be any voltage level from ground to system voltage. System voltage is the voltage level applied to pin 1 of the 6-pin Deutsch connector. The 1Touch scales the dim level based on the dim input's voltage level and the range from ground to system voltage and automatically compensates for system voltage levels and fluctuations.

This method of controlling the 1Touch's dim level is perfect for rheostat/potentiometer control.

 607 NW 27th Ave Ocala, FL 34475 Ph: 352-629-5020 or 1-800-533-3569 Fax: 352-629-2902 or 1-800-520-3473	TECHNICAL DATA SHEET			PAGE	11 OF 23	
	PRODUCT GROUP	ES-Key	P/N	1200-XX-00-CL1 (XX=04,08,12,16)	DATE	5/19/2011
	PRODUCT	1Touch® Switch Panel			REV	1.20
					BY	AMS

6. Configuration Entry Methods

6.1. Entering passwords

The 1Touch Switch utilizes passwords to modify its operational parameters. All operational parameters are stored in memory and will not be lost when power is disconnected.

Use the left-most UPPER and LOWER switches to enter passwords. The switches and indicator LEDs will operate as configured during password entry (there is no special indication that a password is being entered). Each password button press must occur within 2 seconds of the last button press otherwise the attempted password is cleared.

The 1Touch Switch only allows passwords to be entered for the first sixty (60) seconds after a power cycle. However, the 1Touch Switch will allow one password after this time period has elapsed – **1101 1011** resets the “configuration allow” timer allowing another 60 seconds for passwords to be entered. The “configuration allow” timer is automatically reset after a password or configuration has been entered.

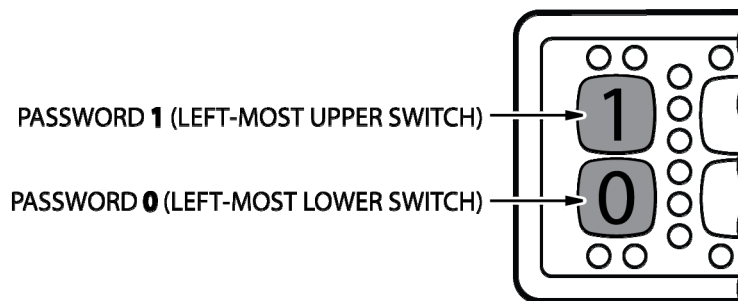



Figure 5. Password switches.

6.1.1. List of passwords

Function	Root password	Section
Reset “configuration allow” timer	1101 1011	---
Configure switch types for pair 0 (switches 0 and 1)	1000 0000	7.1
Configure switch types for pair 1 (switches 2 and 3)	1000 0001	7.1
Configure switch types for pair 2 (switches 4 and 5)	1000 0010	7.1
Configure switch types for pair 3 (switches 6 and 7)	1000 0011	7.1
Configure switch types for pair 4 (switches 8 and 9)	1000 0100	7.1
Configure switch types for pair 5 (switches 10 and 11)	1000 0101	7.1
Configure switch types for pair 6 (switches 12 and 13)	1000 0110	7.1
Configure switch types for pair 7 (switches 14 and 15)	1000 0111	7.1
Load defaults	1001 1001	7.2
Configure the address	1001 0010	7.3
Set device type to SPS (device type 5)	0111 0101	7.4
Set device type to IOM (device type 4)	0111 0100	7.4
Configure the initial states of the switches at power cycle	1001 0000	7.5
Configure the indicator LEDs control source (Internal or ES-Key)	1001 0011	7.6
Configure a master switch	1001 0001	7.7
Set dim input type to analog voltage	0110 0000	7.8
Set dim input type to digital (positive polarity)	0110 0001	7.8
Set dim level to 0 (dimkest)	0011 0000	7.9
Set dim level to 1	0011 0001	7.9
Set dim level to 2	0011 0010	7.9
Set dim level to 3	0011 0011	7.9
Set dim level to 4	0011 0100	7.9
Set dim level to 5	0011 0101	7.9
Set dim level to 6	0011 0110	7.9

 607 NW 27th Ave Ocala, FL 34475 Ph: 352-629-5020 or 1-800-533-3569 Fax: 352-629-2902 or 1-800-520-3473	TECHNICAL DATA SHEET			PAGE	12 OF 23	
	PRODUCT GROUP	ES-Key	P/N	1200-XX-00-CL1 (XX=04,08,12,16)	DATE	5/19/2011
	PRODUCT	1Touch® Switch Panel			REV	1.20
					BY	AMS

Function	Root password	Section
Set dim level to 7 (mid-brightness)	0011 0111	7.9
Set dim level to 8	0011 1000	7.9
Set dim level to 9	0011 1001	7.9
Set dim level to 10	0011 1010	7.9
Set dim level to 11	0011 1011	7.9
Set dim level to 12	0011 1100	7.9
Set dim level to 13	0011 1101	7.9
Set dim level to 14	0011 1110	7.9
Set dim level to 15 (brightest)	0011 1111	7.9
Set network mode to ES-Key	0101 0000	7.10
Set network mode to Peer-to-Peer	0101 0001	7.10
Set peer-to-peer simple mapping	0101 1000	7.11
Clear all peer-to-peer mapping	0101 1001	7.11

Table 3. Password list.

6.2. “Press and Hold” switch type configuration method

The 1Touch Switch allows a “press and hold” method for configuring the switch types.

1. Within the first sixty (60) seconds after a power cycle “press and hold” the switch pair to configure until all backlighting except for the held switches turns OFF (five seconds). The password to reset the 60 second timer may be used (**1101 1011**).
2. Follow the switch type configuration detailed in section 7.1.

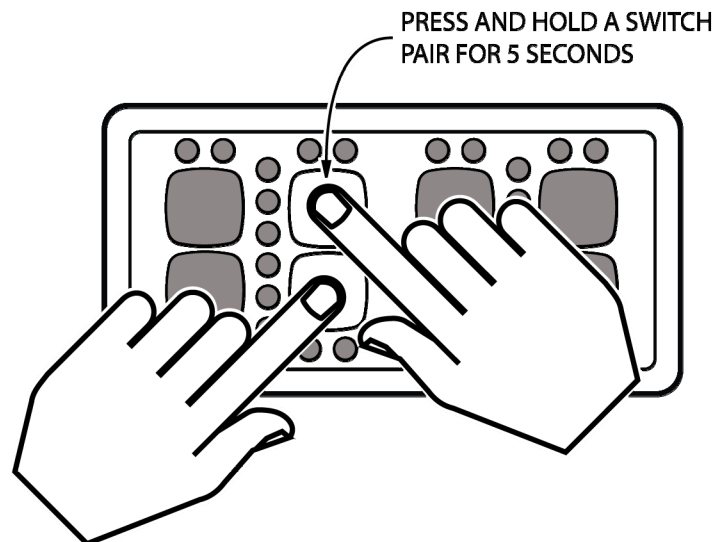



Figure 6. Press and hold configuration method.

 607 NW 27th Ave Ocala, FL 34475 Ph: 352-629-5020 or 1-800-533-3569 Fax: 352-629-2902 or 1-800-520-3473	TECHNICAL DATA SHEET			PAGE	13 OF 23	
	PRODUCT GROUP	ES-Key	P/N	1200-XX-00-CL1 (XX=04,08,12,16)	DATE	5/19/2011
	PRODUCT	1Touch® Switch Panel			REV	1.20
					BY	AMS

7. Configuration Procedures

7.1. Switch type configuration

The 1Touch's switches can be configured to one of the seven different types: no function, momentary, bi-stable, toggle (upper switch = ON), toggle (lower switch = ON), toggle (exclusive), and dimmer.

Configuring a switch type

Enter the switch type configuration using the "press and hold" method (section 6.2) or the password method (section 6.1). The switch pair's backlighting is now lit and all other lighting is OFF. Press the desired switch (upper or lower) of the switch pair to configure. The switch pair's backlighting and indicator LEDs (green and yellow) show the selected switch's current switch type (see Figure 7).

Each time the switch is toggled it increments to the next switch type (see Figure 7). When the last switch type (dimmer) is reached it wraps back to the first switch type (no function).

The other switch of the switch pair may also be toggled to set its switch type. Press any other switch in any other switch pair to save the switch types configuration and exit.

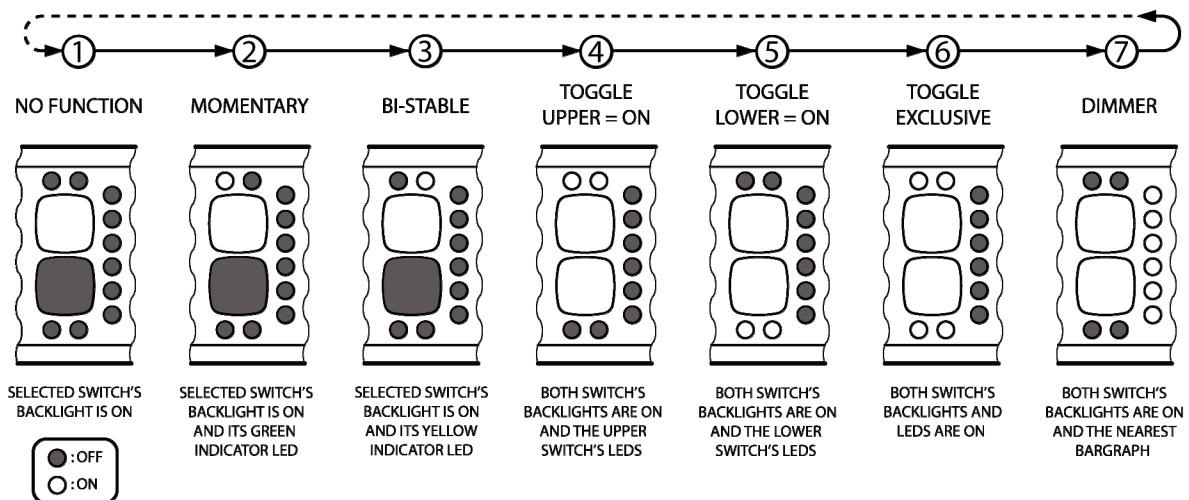



Figure 7. Switch type configuration's indication.

 607 NW 27th Ave Ocala, FL 34475 Ph: 352-629-5020 or 1-800-533-3569 Fax: 352-629-2902 or 1-800-520-3473	TECHNICAL DATA SHEET			PAGE	14 OF 23	
	PRODUCT GROUP	ES-Key	P/N	1200-XX-00-CL1 (XX=04,08,12,16)	DATE	5/19/2011
	PRODUCT	1Touch® Switch Panel			REV	1.20
					BY	AMS

7.2. Load defaults

The 1Touch's default configuration may be reloaded by entering the password – **1001 1001**. The backlighting of each switch is individually cycled to indicate that the defaults have been loaded and saved.

The 1Touch's default configurations are:

All switch types:	Bi-stable
Device type:	SPS Module (device type 5)
Device address:	0
Dim level:	7 (mid-brightness)
Dim input type:	Digital (positive polarity)
Network mode:	ES-Key
Switch indicator control source:	Internal
Master switch configuration:	No master switch enabled
Initial state of switches at power cycle:	All OFF

7.3. Address configuration

The 1Touch's ES-Key address can be set from 0 to 15 by entering the password – **1001 0010**. Switches 0 and 1 (left most pair) are now lit and all other switches are OFF. The bargraph indicates the current address. Use the left-most switches to change the address (upper switch decreases, lower switch increases). Press any other switch in any other switch pair to save the address configuration and exit.

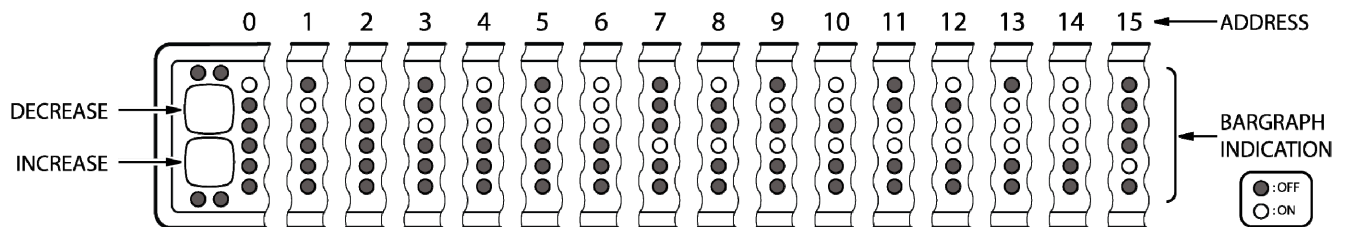

Figure 8. Address configuration indication.

7.4. Device Type configuration

The 1Touch's device type can be set as a SPS Module (device type 5, default) or as an Input Output Module (IOM, device type 4).

SPS Module (device type 5)

Set the device type to SPS Module (device type 5) by entering the password – **0111 0101**.

I/O Module (Device type 4)

Set the device type to I/O Module (Device type 4) by entering the password – **0111 0100**.

 607 NW 27th Ave Ocala, FL 34475 Ph: 352-629-5020 or 1-800-533-3569 Fax: 352-629-2902 or 1-800-520-3473	TECHNICAL DATA SHEET			PAGE	15 OF 23	
	PRODUCT GROUP	ES-Key	P/N	1200-XX-00-CL1 (XX=04,08,12,16)	DATE	5/19/2011
	PRODUCT	1Touch® Switch Panel			REV	1.20
					BY	AMS

7.5. Initial switch states configuration

The initial state (ON or OFF) of each switch during a power cycle may be configured. “No function” and “dimmer” type switches cannot have an “ON” initial state associated.

Set the initial switch states by entering the password – **1001 0000**. The backlighting of all switches begins flashing and the left-most bargraph begins counting down. Each switch press resets the countdown timer.

Set the desired initial state of each switch. The switches operate as the types for which they have been configured. Allow the countdown timer to time-out (fifteen seconds) once the switches have been set to the desired initial state. The 1Touch will resume normal operation with the new initial states.

7.6. LED indicator control source configuration

The 1Touch’s indicator LEDs (green/yellow) can be configured for internal control (default) or ES-Key control.

Internal control

The green indicator LED will be ON when its associated switch is active. The yellow LED is not used and remains OFF.

ES-Key control

The green and yellow indicator LEDs are controlled by the ES-Key database through the output memory space (see section 4.1.1).

Enter the password – **1001 0011**. Switch 0’s backlighting is ON and all of the indicator LEDs show the current control source:

- Green LEDs only – internal control
- Green and yellow LEDs – ES-Key control

Press switch 0 (the only switch with the backlight ON) to toggle the indicator control source. Press any other switch in any other switch pair to save the indicator control source and exit.

7.7. Master switch configuration

The 1Touch allows one switch pair to be configured as a master switch.

Add or remove a master switch by entering the password – **1001 0001**. The backlighting of all switches begins flashing and the left-most bargraph begins counting down.

To remove a master switch

Do not press any switches. Allow the countdown timer to time-out (fifteen seconds) to remove a master switch. The 1Touch will remove the master switch, save the configuration, and resume normal operation.

To add a master switch

Press one of the switches in a switch pair to select it as the master switch. The backlighting stops flashing and only the backlighting of the selected switch pair remains ON. The countdown timer is turned OFF.

Toggle one of the switches in the switch pair to select the type of switch to use as a master switch. Only the “toggle, upper=ON” and “toggle, lower=ON” are allowed. Press any other switch in any other switch pair to save the indicator control source and exit.

 607 NW 27th Ave Ocala, FL 34475 Ph: 352-629-5020 or 1-800-533-3569 Fax: 352-629-2902 or 1-800-520-3473	TECHNICAL DATA SHEET			PAGE	16 OF 23	
	PRODUCT GROUP	ES-Key	P/N	1200-XX-00-CL1 (XX=04,08,12,16)	DATE	5/19/2011
	PRODUCT	1Touch® Switch Panel			REV	1.20
					BY	AMS

7.8. Dim input type configuration

The 1Touch's dim input (pin 3) can be set to accept a digital (positive polarity, default) input or an analog (ground to system voltage) input. The dim input is not available (analog or digital) if a switch pair has been set to "dimmer".

Digital input

The digital input type sets the 1Touch's dim level to the configured dim level when a positive voltage is applied to pin 3. This method is desired when using a day/night type selection.

Set the input to digital type entering the password – **0110 0001**.

Analog input

The analog input type sets the 1Touch's dim level to one of sixteen levels based on the voltage level applied to pin 3. This method is desired when using a rheostat/potentiometer type control.

Set the input to analog type entering the password – **0110 0000**.

7.9. Dim level configuration

The 1Touch's dim level associated with the physical dim input (pin 3) is set by entering a password. The dim level can be set to one of sixteen brightness levels. Dim level 0 is the dimmest and dim level 15 is full brightness.

Set the dim level to:

0	(dimmest) by entering the password	– 0011 0000
1	by entering the password	– 0011 0001
2	by entering the password	– 0011 0010
3	by entering the password	– 0011 0011
4	by entering the password	– 0011 0100
5	by entering the password	– 0011 0101
6	by entering the password	– 0011 0110
7	(mid-level, default) by entering the password	– 0011 0111
8	by entering the password	– 0011 1000
9	by entering the password	– 0011 1001
10	by entering the password	– 0011 1010
11	by entering the password	– 0011 1011
12	by entering the password	– 0011 1100
13	by entering the password	– 0011 1101
14	by entering the password	– 0011 1110
15	(brightest) by entering the password	– 0011 1111

 607 NW 27th Ave Ocala, FL 34475 Ph: 352-629-5020 or 1-800-533-3569 Fax: 352-629-2902 or 1-800-520-3473	TECHNICAL DATA SHEET			PAGE	17 OF 23	
	PRODUCT GROUP	ES-Key	P/N	1200-XX-00-CL1 (XX=04,08,12,16)	DATE	5/19/2011
	PRODUCT	1Touch® Switch Panel			REV	1.20
					BY	AMS

7.10. Network mode configuration

The 1Touch's network mode can be configured for ES-Key (default) or Peer-to-Peer.

ES-Key network mode

The ES-Key network mode is the default mode and allows normal ES-Key multiplex system database control. Set the network mode to **ES-Key** by entering the password – **0101 0000**.

Peer-to-Peer network mode

The Peer-to-Peer network mode allows the 1Touch to work within a very basic multiplex system which does not require a USM or database. Each switch can be mapped to a Class 1 Power Distribution Module (PDM) output for peer-to-peer control. The “switch to PDM output” mapping is accomplished with the ES-Key Professional software or by setting a basic one-for-one mapping by entering a password (see section 7.11).

Set the network mode to **Peer-to-Peer** by entering the password – **0101 0001**

7.11. Peer-to-Peer mapping

A 1Touch set for Peer-to-Peer network mode (see section 7.10) requires “1Touch switch to PDM output” mapping. This is normally accomplished with the ES-Key Professional software, but a very simple one-for-one mapping can be set with a password.

One-for-one mapping details:

The 1Touch is mapped to a PDM with same address (e.g. 1Touch address 0 to PDM address 0). Each 1Touch switch is mapped to control the state of the associated PDM's output (e.g. switch 0 controls output 0, switch 1 controls output 1, etc).

Set simple Peer-to-Peer mapping

Enter the password – **0101 1000**.

Clear all Peer-to-Peer mapping (default)

Enter the password – **0101 1001**.

 607 NW 27th Ave Ocala, FL 34475 Ph: 352-629-5020 or 1-800-533-3569 Fax: 352-629-2902 or 1-800-520-3473	TECHNICAL DATA SHEET			PAGE	18 OF 23
	PRODUCT GROUP	ES-Key	P/N	1200-XX-00-CL1 (XX=04,08,12,16)	DATE
PRODUCT	1Touch® Switch Panel			REV	1.20
				BY	AMS

8. Mounting and Installation

8.1. Switch cap installation

The plastic switch caps and switch labels are easily installed with no special tools required. Clear switch caps are provided with the 1Touch, but transparent colors are available (see section 2.1).

The switch label is protected by the switch cap. The switch labels may be custom created using the dimensions listed below. Use a label material which is UV and moisture resistant.

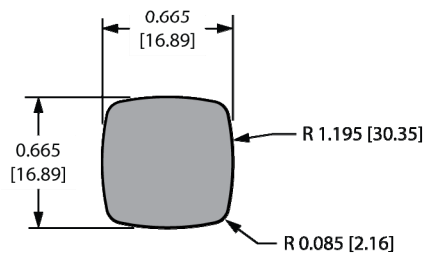

Figure 9. Switch label dimensions in inches [millimeters].

1. Adhere the switch label to the rubber switch pad. Take special care to place the label with the proper orientation.
2. Place one corner of the switch cap into the corner of the switch opening.
3. Press the switch cap's other corner firmly into place using finger pressure.

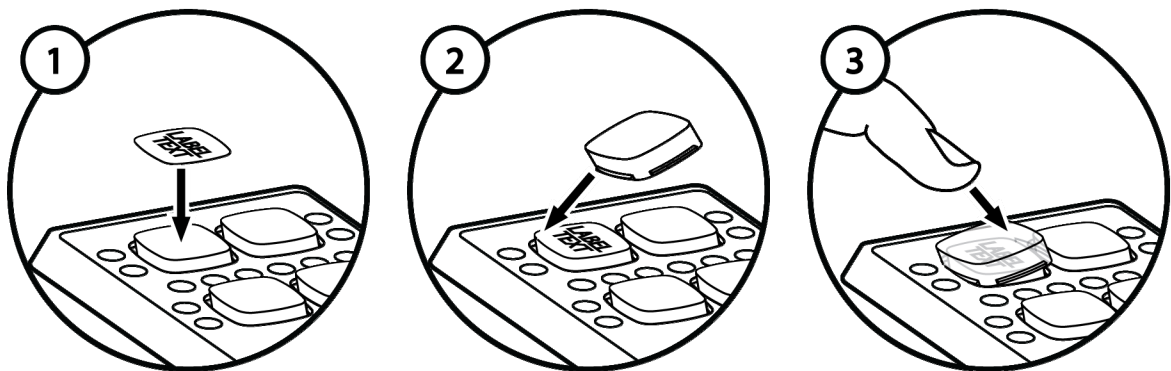



Figure 10. Switch cap installation.

 607 NW 27th Ave Ocala, FL 34475 Ph: 352-629-5020 or 1-800-533-3569 Fax: 352-629-2902 or 1-800-520-3473	TECHNICAL DATA SHEET			PAGE	19 OF 23
	PRODUCT GROUP	ES-Key	P/N	1200-XX-00-CL1 (XX=04,08,12,16)	DATE
PRODUCT	1Touch® Switch Panel			REV	1.20
				BY	AMS

8.2. Switch cap removal

The plastic switch caps may be easily removed using a small flat-bladed tool. Use caution when removing switch caps to reduce the danger of damaging the 1Touch.

1. Place the flat-bladed tool beside one corner of the switch cap.
2. Gently pry the corner of the switch cap up and remove.

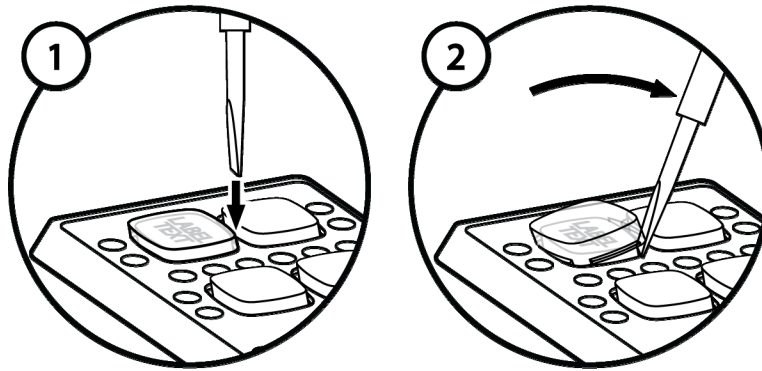

Figure 11. Switch cap removal.

8.3. Side view dimensions (all models)

The 1Touch uses 6-32 studs (0.650 in / 16.51 mm long) for mounting.

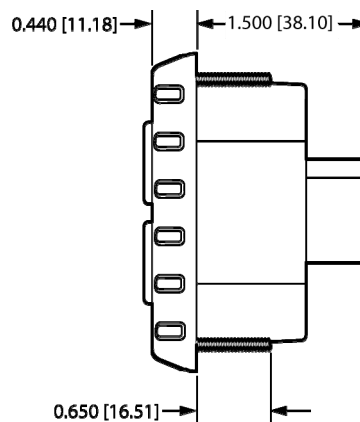



Figure 12. Overall dimensions in inches [millimeters].

 <p>607 NW 27th Ave Ocala, FL 34475 Ph: 352-629-5020 or 1-800-533-3569 Fax: 352-629-2902 or 1-800-520-3473</p>	TECHNICAL DATA SHEET			PAGE	20 OF 23
	PRODUCT GROUP	ES-Key	P/N	1200-XX-00-CL1 (XX=04,08,12,16)	DATE
PRODUCT	1Touch® Switch Panel			REV	1.20
				BY	AMS

8.4. Mounting dimensions (4 position, 1200-04-00-CL1)

Mount the 4 position 1Touch and secure with four 6-32 nuts.

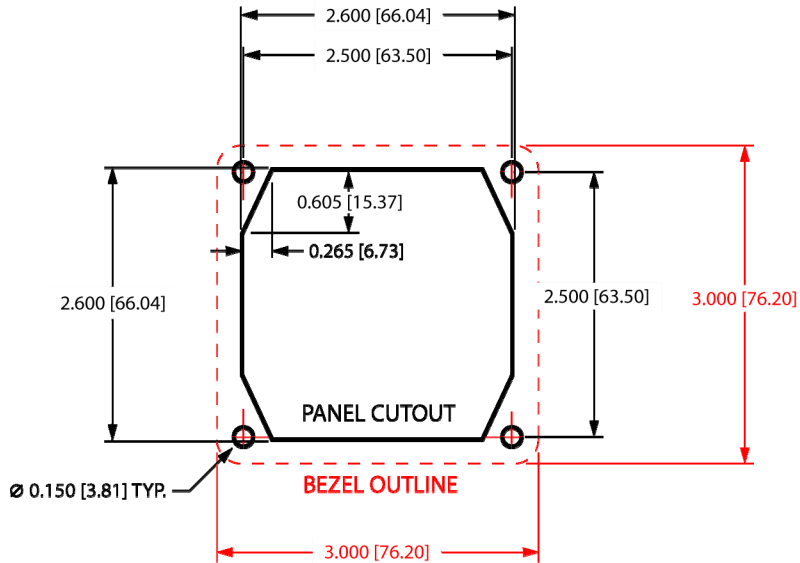

Figure 13. 1Touch, 4 position installation dimensions in inches [millimeters].

8.5. Mounting dimensions (8 position, 1200-08-00-CL1)

Mount the 8 position 1Touch and secure with with four 6-32 nuts.

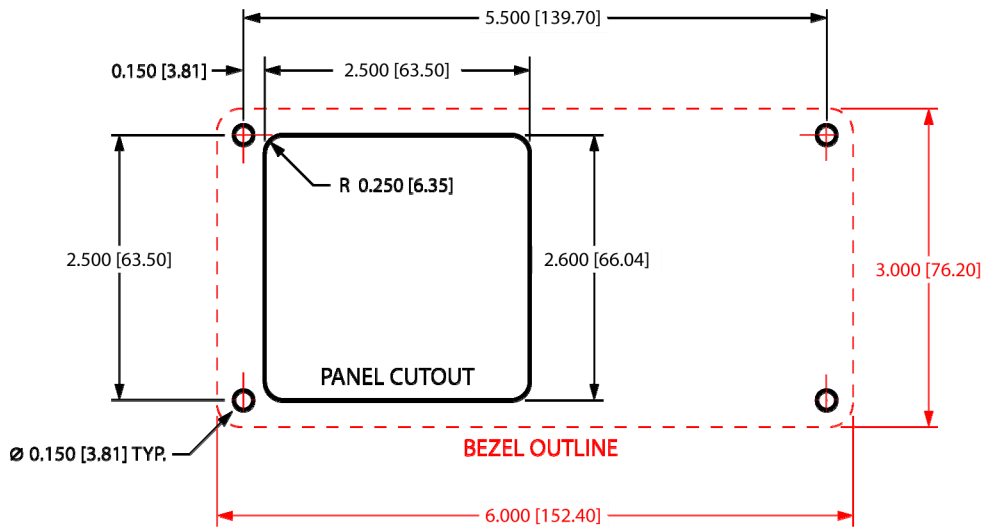



Figure 14. 1Touch, 8 position installation dimensions in inches [millimeters].

 <p>607 NW 27th Ave Ocala, FL 34475 Ph: 352-629-5020 or 1-800-533-3569 Fax: 352-629-2902 or 1-800-520-3473</p>	TECHNICAL DATA SHEET			PAGE	21 OF 23	
	PRODUCT GROUP	ES-Key	P/N	1200-XX-00-CL1 (XX=04,08,12,16)	DATE	5/19/2011
	PRODUCT	1Touch® Switch Panel			REV	1.20
					BY	AMS

8.6. Mounting dimensions (12 position, 1200-12-00-CL1)

Mount the 12 position 1Touch and secure with four 6-32 nuts.

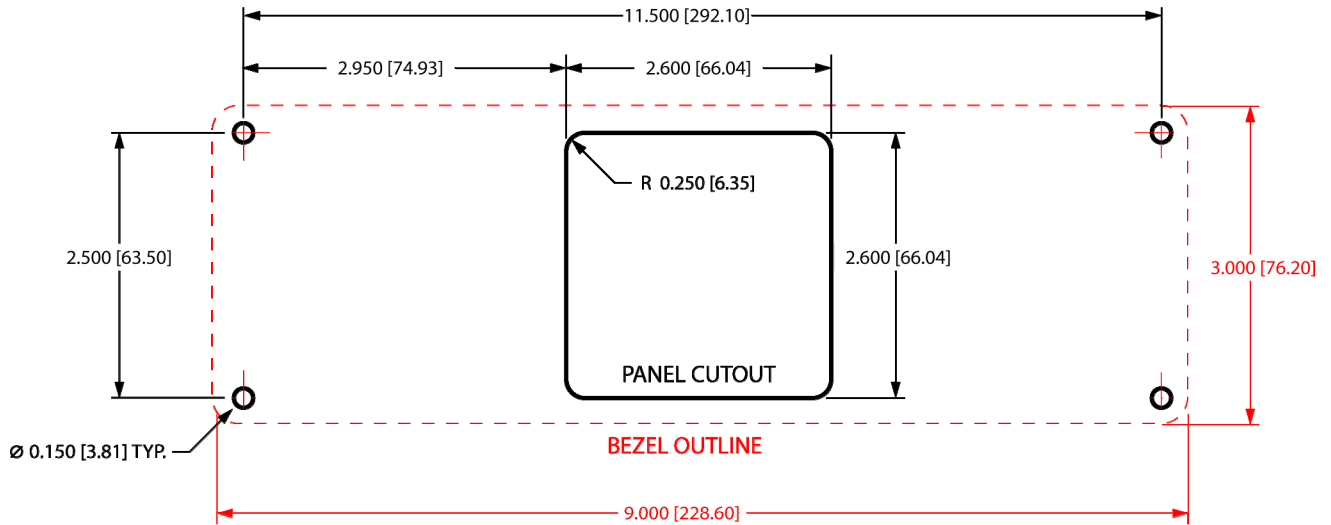

Figure 15. 1Touch, 12 position installation dimensions in inches [millimeters].

8.7. Mounting dimensions (16 position, 1200-16-00-CL1)

Mount the 16 position 1Touch and secure with six 6-32 nuts.

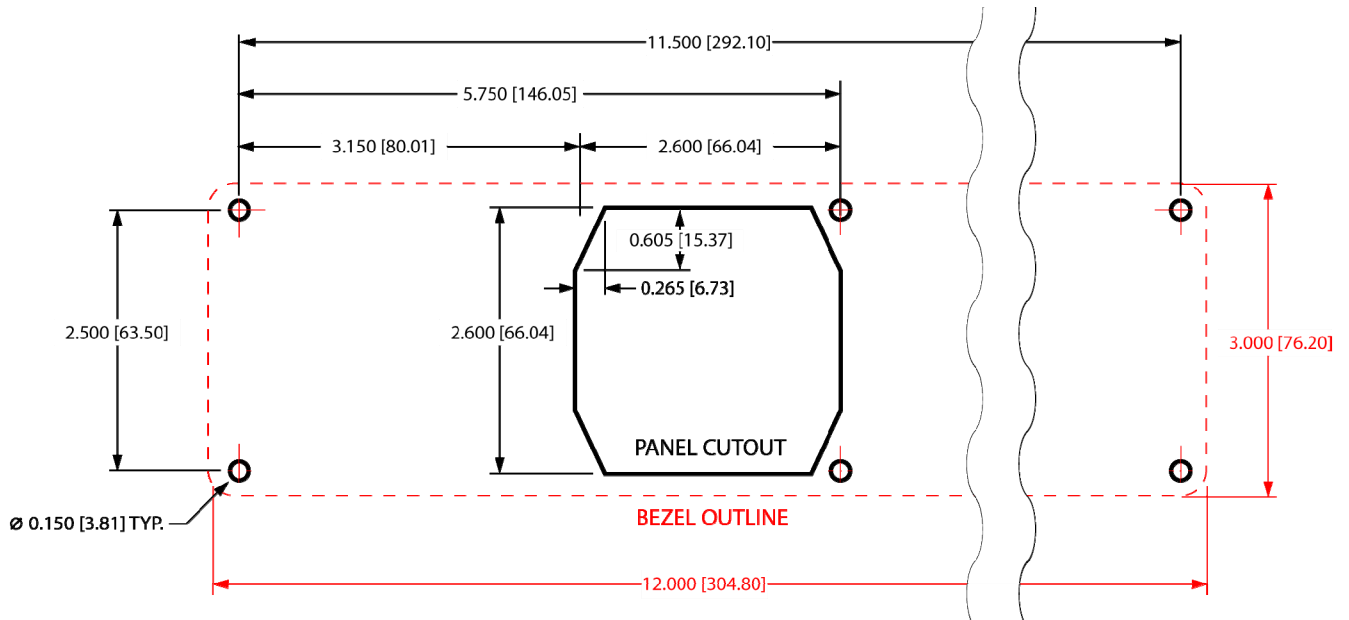



Figure 16. 1Touch, 16 position installation dimensions in inches [millimeters].

 607 NW 27th Ave Ocala, FL 34475 Ph: 352-629-5020 or 1-800-533-3569 Fax: 352-629-2902 or 1-800-520-3473	TECHNICAL DATA SHEET			PAGE	22 OF 23	
	PRODUCT GROUP	ES-Key	P/N	1200-XX-00-CL1 (XX=04,08,12,16)	DATE	5/19/2011
	PRODUCT	1Touch® Switch Panel			REV	1.20
					BY	AMS

9. Connector Description

Mating connector: Deutsch DT06-6S
Mating sockets: Deutsch 0462-201-16141
Gold mating sockets: Deutsch 0462-201-1631
Recommended wire gage: 16-20 AWG
Wedge lock: W6S

PIN	CIRCUIT	DESCRIPTION
1	SYS POWER	(INPUT) – battery voltage (+9VDC...+32VDC)
2	SYS GROUND	(INPUT) – battery ground
3	DIM INPUT	(INPUT) – Configurable, analog or digital (ground to battery voltage)
4	CAN HIGH	(DATA) – SAE J1939 CAN 2.0B, 250Kbits/s *
5	CAN LOW	(DATA) – SAE J1939 CAN 2.0B, 250Kbits/s *
6	CAN SHIELD	(DATA) – SAE J1939 CAN 2.0B, 250Kbits/s *

* Gold sockets recommended for CAN connections.

10. References

10.1. List of figures

FIGURE 1. AVAILABLE 1TOUCH SWITCH PANEL LAYOUTS.	4
FIGURE 2. INDICATORS AND SWITCHES.	5
FIGURE 3. DIAGNOSTIC INDICATOR (LEFT-MOST BARGRAPH).	5
FIGURE 4. PASSWORD SWITCHES.	11
FIGURE 5. PRESS AND HOLD CONFIGURATION METHOD.	12
FIGURE 6. SWITCH TYPE CONFIGURATION'S INDICATION.	13
FIGURE 7. ADDRESS CONFIGURATION INDICATION.	14
FIGURE 8. SWITCH LABEL DIMENSIONS IN INCHES [MILLIMETERS].	18
FIGURE 9. SWITCH CAP INSTALLATION.	18
FIGURE 10. SWITCH CAP REMOVAL.	19
FIGURE 11. OVERALL DIMENSIONS IN INCHES [MILLIMETERS].	19
FIGURE 12. 1TOUCH, 4 POSITION INSTALLATION DIMENSIONS IN INCHES [MILLIMETERS].	20
FIGURE 13. 1TOUCH, 8 POSITION INSTALLATION DIMENSIONS IN INCHES [MILLIMETERS].	20
FIGURE 14. 1TOUCH, 12 POSITION INSTALLATION DIMENSIONS IN INCHES [MILLIMETERS].	21
FIGURE 15. 1TOUCH, 16 POSITION INSTALLATION DIMENSIONS IN INCHES [MILLIMETERS].	21

10.2. List of tables

TABLE 1. DIAGNOSTIC INDICATIONS (LEFT-MOST BARGRAPH).	6
TABLE 2. I/O MEMORY SPACE MAP.	7
TABLE 3. PASSWORD LIST.	12

 607 NW 27th Ave Ocala, FL 34475 Ph: 352-629-5020 or 1-800-533-3569 Fax: 352-629-2902 or 1-800-520-3473	TECHNICAL DATA SHEET			PAGE	23 OF 23	
	PRODUCT GROUP	ES-Key	P/N	1200-XX-00-CL1 (XX=04,08,12,16)	DATE	5/19/2011
	PRODUCT	1Touch® Switch Panel			REV	1.20
					BY	AMS

11. Technical Details and Compliances

Product category	ES-Key	
Voltage range	+9VDC...+32VDC	
Maximum current draw	Logic supply+ input (pin 1 of 6-pin connector)	
@13.8VDC	65 mA	
@27.6VDC	45 mA	
Temperature range	-40°F...+185°F (-40°C...+85°C)	
Environmental range	IP 67	
CAN specification	SAE J1939, 250 Kbits/second	
LED	3 LEDs (two green and one red) to indicate status	
Electrical protection	Internal thermal fuse (2500 mA on pin 1 of gray 6-pin connector)	
	Reverse voltage protection (pins 1 and 2 of 6-pin connector)	
	CAN bus protected for heavy duty trucks (24V)	
	ESD voltage protected to SAE J1113 specification for heavy duty trucks (24V)	
	Transient voltage protected to SAE J1113 specification for heavy duty trucks (24V)	
Electrical performance	Immunity to Radiated Electromagnetic Fields– Bulk Current Injection (BCI) method, Class C device	SAE J1113-4
	Reverse voltage protection on power leads (pins 1 and 2 of 12-pin gray connector), Class C device	ISO 16750-2
	Overvoltage due to failing generator, Class A device	ISO 16750-2
	Immunity to conducted transients on power leads, L4 requirements (24V)	SAE J1113-11
	Immunity to Electrostatic Discharge – powered and unpowered modes	SAE J1113-13
	Immunity to radiated electromagnetic fields, Class C device	SAE J1113-21
	Conducted emission on power leads (Class 3 average and Class 5 peak limits)	CISPR 25
	Radiated emissions, absorber-lined shielded enclosure (Class 1 average and Class 3 peak limits)	CISPR 25
	Reset behavior on voltage drop 24V, Class C device	ISO 16750-2
	Environmental performance	Thermal shock
Exposure to humidity		MIL-STD-810F (method 507.4)
Thermal shock due to splash		Class 1 (STD-0001)
Pressure cleaning		Class 1
Exposure to salt spray atmosphere/fog		SAE J1455 (sec 4.3)
Exposure to outdoor UV		ISO 4892-2 (method A)
Exposure to chemicals		Class 1
Mechanical performance	Resonance dwell	SAE J1455 (sec 4.9.4.1)
	Random vibration	SAE J1455 (sec 4.9.4.2)
	Mechanical shock	SAE J1455 (sec 4.10.3.4)
Dimensions (W x H x D) in inches [millimeters]	3.00 [76.20] (4 position, 1200-04-00-CL1)	
	6.00 [152.40] (8 position, 1200-08-00-CL1)	
	9.00 [228.60] (12 position, 1200-12-00-CL1)	
	12.00 [304.80] (16 position, 1200-16-00-CL1)	
	x 3.00 [76.20] x 1.94 [49.28]	