

TOSHIBA

OWNER'S MANUAL

High Definition Digital Receiver

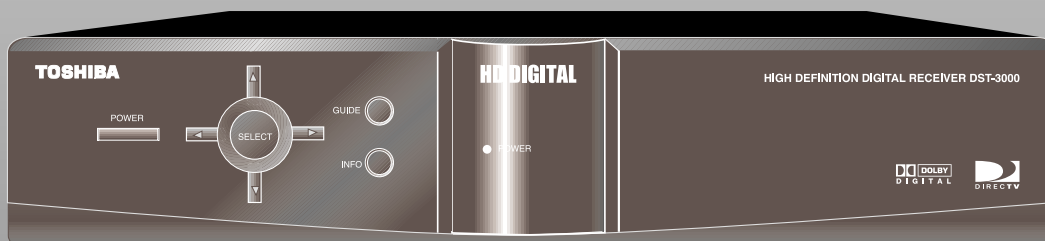

DST-3000

Trademarks and Copyrights—This manual is copyright © 2000 by Toshiba America Consumer Products, Inc. Some features are patent pending. **WordFinder, PrePick, MyLogos, AlphaJump,** and **BannerGuide** are trademarks of Toshiba America Consumer Products, Inc. TOSHIBA is a registered trademark of Toshiba Corporation. DIRECTV, the Cyclone Design logo, Advanced Program Guide, and DIRECTV PLUS are trademarks of DIRECTV, Inc. a unit of Hughes Electronics Corp., and are used with permission. DIRECT TICKET is a registered trademark of Hughes Communications, Inc. “NFL,” the NFL Shield and “NFL SUNDAY TICKET” are registered trademarks of The National Football League and its affiliates. “NHL” and the NHL Shield are registered trademarks of the National Hockey League. “NHL Center Ice” is a trademark of the National Hockey League. “MLB,” “MLB EXTRA INNINGS,” “Major League Baseball,” and the Major League Baseball silhouetted batter logo are service marks of Major League Baseball Properties, Inc. Major League Baseball trademarks and copyright are used with permission of Major League Baseball Properties, Inc. All other trademarks and service marks are the property of their respective owners.

This product is the subject of one or more U.S. or foreign patents pending.

Disclaimer—Every effort has been made to ensure the correctness and completeness of the material in this document. No company shall be liable for errors contained herein. The information in this document is subject to change without notice. No warranty of any kind is made with regard to this material, including, but not limited to, the implied warranties of merchantability and fitness for a particular purpose.

StarSight® Information—StarSight is a registered trademark of StarSight Telecast, Inc. StarSight features are licensed under one or more of the following U.S. patents: 4,706,121; 5,151,789; 5,335,277; 5,353,121; 5,479,266; 5,479,268; and 5,532,754. Use rights reserved.

Macrovision® Information—Macrovision is a registered trademark of Macrovision Corporation. This device incorporates an anticopy process technology that is protected by U.S. patents and other intellectual property rights. The anticopy process is licensed for noncommercial, home use only. Reverse engineering or disassembly is prohibited.

Dolby® Information—Manufactured under license from Dolby Laboratories. “Dolby” and the double-D symbol are registered trademarks of Dolby Laboratories Licensing Corp. Confidential unpublished works. © 1992–2000 Dolby Laboratories. All rights reserved.

Note on Recording Programming—Most television programs and films are copyrighted. This

means that someone has legal rights governing the reproduction and distribution of this material. In certain circumstances, copyright law may apply to private in-home taping of copyrighted materials. In most cases, it is permissible to record for personal use, as long as you do not sell the material. You must act responsibly in this area—check into the matter if you are unsure.

Some pay per view programs may be licensed from producers as “view only” programs. These are copyrighted programs and may not be copied or reproduced for any purpose without the express written permission of the copyright owner.

DIRECTV® Programming—DIRECTV® service can only be received by U.S. residents and is not available outside the U.S. DIRECTV® programming is sold separately and independently of DIRECTV® System hardware. Due to copyright restrictions, you may not be able to view some high definition programs in high definition format using this product. A valid programming subscription is required to operate DIRECTV® System hardware. For subscription information, or to resolve problems related to programming, call the service provider, DIRECTV, at 1-800-DIRECTV (347-3288).

Satellite System Hardware and Installation—To arrange for professional installation of your satellite system, ask questions, or to resolve problems, please contact your dealer. For additional information, please visit our web site at www.toshiba.com/tacp.

Toshiba Customer Solutions Center
1-888-867-4377

Subscriptions and pay per view
1-800-DIRECTV

**PLEASE MAKE NOTE OF THE FOLLOWING
INFORMATION FOR WARRANTY**

Receiver Model #: DST-3000

Receiver Serial #: _____

Access Card #: _____

Important Safety Instructions

For your safety and protection, read this entire Owner's Manual before you attempt to install or use your satellite system. In particular, read this safety section carefully. Keep this safety information where you can refer to it, if necessary.

Heed Cautions—All cautions on the product and in the operating instructions should be adhered to.

Follow Instructions—All operating and use instructions should be followed.

THESE CAUTIONS AND SYMBOLS APPEAR ON THE BACK OF THE DST-3000 RECEIVER

WARNING or CAUTION

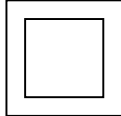

Double insulated systems are protected by additional board clearances and creepage, so that the unit will not be a safety hazard to the end-user.

CAUTION

RISK OF ELECTRIC SHOCK
DO NOT OPEN



THESE ARE DEFINITIONS FOR ALERTS USED IN THIS MANUAL

WARNING or CAUTION



Where you see this alert symbol and the WARNING or CAUTION heading, strictly follow the warning instructions to avoid personal injury.

DANGER



Electric shock hazard: Where you see this symbol and the DANGER heading, strictly follow the warning instructions to avoid electric shock injury.

THESE ALERTS APPEAR IN THIS MANUAL

DANGER



To reduce the risk of fire or electrical shock, do not expose this apparatus to rain or moisture.

CAUTION



Do not stack electronic components or other objects on top of the HD receiver. The slots on top of the receiver must be left uncovered to allow proper airflow to the unit. Blocking the airflow to the unit could impair performance or damage your receiver. Also do not stack the HD receiver on top of a "hot" component such as an audio power amplifier.

INSTALLATION

Polarization—This DST-3000 receiver is equipped with a plug that will fit into the power outlet only one way. Do not defeat the safety purpose of the polarized or grounding-type plug. A polarized plug has two blades with one wider than the other. A grounding-type plug has two blades and a third grounding prong. The wide blade or the third prong are provided for your safety. If the provided plug does not fit into your outlet, consult an electrician for replacement of the obsolete outlet. To prevent electric shock, do not use this plug with an extension cord or outlet unless you can fully insert the blades without blade exposure.

Power Sources—Operate this DST-3000 receiver only from the type of power source indicated on the marking label. If you are not sure of the type of power supply to your home, consult your dealer or local power company.

Power-Cord Protection—Protect the power cord from being walked on or pinched particularly at plugs, convenience receptacles, and the point where they exit from the apparatus.

Overloading—Do not overload wall outlets, extension cords, or integral convenience receptacles as this can result in a risk of fire or electric shock.

Ventilation—Slots and openings in the cabinet are provided for ventilation and to ensure reliable operation of the product and to protect it from overheating. Do not block any ventilation openings, install in accordance with the manufacturer's instructions.

The openings should never be blocked by placing the product on a bed, sofa, rug, or other similar surface. This product should not be placed in a built-in installation such as a bookcase or rack unless proper ventilation is provided or the manufacturer's instructions have been adhered to. Failure to follow these Ventilation instructions may cause the DST-3000 to overheat, which may degrade performance or result in property damage.

For electrical safety, power line operated equipment or accessories connected to this unit should bear the UL listing mark and should not be modified so as to defeat the safety features. This will help avoid any potential hazard from electrical shock or fire. If in doubt, contact qualified service personnel.

Heat—Do not install near any heat sources such as radiators, heat registers, stoves, or other apparatus (including amplifiers) that produce heat.

Accessories—To avoid personal injury or damage to the DST-3000 receiver, do not place the DST-3000 receiver on any unstable cart, stand, table, or bracket. Any mounting of the product should follow the manufacturer's instructions.

Attachments—Do not use attachments unless recommended by Toshiba as they may cause hazards.

Satellite Dish Antenna Grounding—The outdoor satellite dish antenna used to receive satellite signals and

the cable used to connect the satellite dish antenna to the indoor receiving unit are required to comply with local installation codes and the appropriate sections of the National Electric Code (NEC) and in particular Article 810–15, which covers proper installation and grounding of television receiving equipment, as well as to Article 820–33, which specifies that the satellite dish antenna cable ground shall be connected to the grounding system of the building as close to the point of cable entry as practical. These codes require proper grounding of the metal structure of the outdoor satellite dish antenna and grounding of the connecting cable at a point where it enters the house (or other building). If you are having a professional installer make the installation, the installer must observe installation codes. This manual contains instructions on how to make the installation in compliance with the NEC. If additional local installation codes apply, contact local inspection authorities.

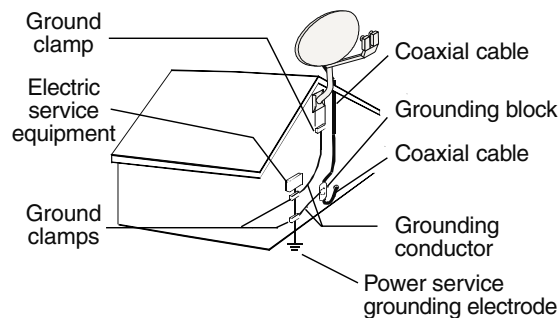

EXAMPLE OF ANTENNA GROUNDING ACCORDING TO THE NATIONAL ELECTRICAL CODE INSTRUCTIONS CONTAINED IN "RADIO AND TELEVISION EQUIPMENT"

Note: The DST-3000 receiver shall be grounded through the satellite/local antenna cable before plugging into the telephone jack, and it must remain grounded thereafter.

Water and Moisture—Warning! To reduce the risk of fire or electric shock, do not expose this apparatus to rain or moisture.

Lightning—For added protection for this product, unplug this apparatus during lightning storms or when unused for long periods of time. Unplug it from the wall outlet, disconnect the antenna and cable system, and disconnect it from the telephone line. This will prevent damage to the product due to lightning and power line surges.

Television Antenna Information—Installing an outdoor antenna can be hazardous and should be left to a professional antenna installer. Do not locate the outside antenna system in the vicinity of overhead power lines or other electric light or power circuits or where it can fall into such power lines or circuits. When installing an outside antenna system, take extreme care to keep from touching such power lines or circuits, as contact with them might be fatal. If an outside antenna is connected to

the DST-3000 receiver, be sure the antenna system is grounded so as to provide some protection against voltage surges and built-up static charges. Section 810 of the NEC, NFPA No. 70 1987, provides information with respect to proper grounding of the mast and supporting structure, grounding of the lead-in wire to an antenna discharge unit, size of the grounding conductors, location of antenna discharge unit, connection to grounding electrodes, and requirements for the grounding electrode.

Note to CATV System Installer—This reminder is provided to call the CATV system installer's attention to Section 820-40 of the NEC which provides guidelines for proper grounding and particularly specifies that the cable ground shall be connected to the grounding system of the building, as close to the point of cable entry as practical.

Power Lines—Extreme care must be taken when installing and adjusting or maintaining the outdoor

antenna and connecting cable, especially in the vicinity of overhead power lines, electric lights, or power circuits. When installing the outdoor antenna or cable, extreme care should be taken to keep from touching or approaching such power lines or circuits, as contact with them might be fatal.

Cleaning—Unplug this DST-3000 receiver from the wall outlet before cleaning. Do not use liquid cleaners or aerosol cleaners. Clean only with dry cloth.

Object and Liquid Entry—Never push objects of any kind into this DST-3000 receiver through openings as they may touch dangerous voltages or short out parts that may result in property damage or electric shock. Never spill liquid of any kind on the DST-3000 receiver. No objects filled with liquids, such as vases, shall be placed on the apparatus.

SERVICE

Servicing—Do not attempt to service this DST-3000 receiver yourself as opening or removing covers may expose you to dangerous voltage or other hazards. There are no user serviceable parts inside. Refer all servicing to qualified service personnel.

Conditions Requiring Service—Unplug the DST-3000 receiver from the wall outlet and refer servicing to qualified personnel under the following conditions:

- When the power supply cord or plug is damaged.
- If liquid has been spilled on, or objects have fallen into, the DST-3000 receiver or it has been exposed to water.
- If the DST-3000 receiver does not operate normally by following the operating instructions. Adjust only those

controls that are covered by the operating instructions. Other adjustments may result in damage and will often require extensive work by a qualified technician to restore the DST-3000 receiver to its normal operation.

- If the DST-3000 receiver has been dropped or the cabinet has been damaged.
- When the DST-3000 receiver exhibits a distinct change in performance.

Replacement Parts—When replacement parts are required, have the technician verify that the replacements being used have the same safety characteristics as the original parts. Use of replacement parts specified by the manufacturer can prevent fire, electric shock, or other hazards.

Federal Communications Commission (FCC) Regulatory Information

Federal Communications Commission (FCC)—

This equipment complies with both Part 15 and Part 68 of the FCC rules.

FCC Declaration of Conformity Compliance Statement

The Toshiba DST-3000 High Definition Digital Receiver complies with Part 15 of the FCC rules. Operation is subject to the following two conditions: (1) this device may not cause harmful interference, and (2) this device must accept any interference that may cause undesired operation. The responsible party for compliance to these rules is as follows:

Toshiba America Consumer Products, Inc.
82 Totowa Rd.
Wayne, NJ 07470

Ph: (888) 867-4377

Part 15 compliance—

Changes or modifications to this equipment not expressly approved by Toshiba could void the user's authority to operate this equipment.

This equipment has been tested and found to comply with the limits for a Class B digital device, pursuant to Part 15 of the FCC rules. These limits are designed to provide reasonable protection against harmful interference in a residential installation. This equipment generates, uses and can radiate radio frequency energy and, if not installed and used in accordance with the instructions, may cause harmful interference to radio communications.

However, there is no guarantee that interference will not occur in a particular installation. If this equipment does cause harmful interference to radio or television reception, which can be determined by removing and applying power to the equipment, the user is encouraged to try to correct the interference by one or more of the following measures:

- Reorient or relocate the receiving satellite dish antenna.
- Increase the separation between the equipment and the DST-3000 receiver.
- Connect the equipment into an outlet on a circuit different from that to which the DST-3000 receiver is connected.
- Consult the dealer or an experienced radio/TV technician for help.

The user may find the following booklet, prepared by the Federal Communications Commission, helpful: "How to Identify and Resolve Radio and TV Interference Problems." This booklet is available from the U.S. Government Printing Office, Washington, DC.

To meet FCC requirements, only peripherals (computer input/output devices, terminals, printers, etc.) certified to comply with the Class B limits may be attached to this device. Operation with noncertified peripherals is likely to result in interference to radio and TV reception.

To meet FCC requirements, shielded cables are required to connect the device to a personal computer, peripheral, or other Class B certified device.

Part 68 compliance—

- 1) This equipment complies with Part 68 of the FCC rules. On the modem card is a label that contains, among other information, the FCC Registration Number and Ringer Equivalence Number (REN) for this equipment. If requested, this information must be provided to the Telephone Company.

The REN is used to determine the quantity of devices which may be connected to the telephone line. An excessive number of REN's on the line may result in the devices not ringing in response to an incoming call. In most, but not all areas, the sum of the number of REN's should not exceed five (5). To be certain of the number of devices that may be connected to the line, contact the Telephone Company to determine the maximum number of REN's permitted for the calling area.

- 2) If the terminal equipment DST-3000 receiver causes harm to the telephone network, the Telephone Company will notify you in advance that temporary discontinuance of service may be required. But, if advance notice is not practical, the Telephone Company will notify you as soon as possible. Also, you will be advised of your right to file a complaint with the FCC, if you believe it is necessary.
- 3) The Telephone Company may make changes in its facilities, equipment, operations, or procedures that could affect the operation of the equipment. If this happens, the Telephone Company will provide advance notice in order for you to make the necessary modifications in order to maintain interrupted service.
- 4) If trouble is experienced operating the DST-3000 receiver on the telephone network, please contact the Toshiba Customer Solutions Center at 1-888-867-4377 for further instructions.
 - Toshiba America Consumer Products, Inc. must make any necessary repairs to the modem portion of this equipment in order to maintain valid FCC registration. Do not attempt to repair or service the modem in the DST-3000 receiver.
 - No repairs can be made by customers. All repairs are to be performed by a Toshiba America Consumer Products, Inc. Authorized Service Station (TASS).
 - This equipment cannot be used on public coin service provided by the Telephone Company. Connection to Party Line Service is subject to state tariffs.

Table of Contents

Important Safety Instructions	iii	Setting Up the Satellite Dish Antenna and Terrestrial Inputs	4-1
Federal Communications Commission (FCC) Regulatory Information	vi	Installing and Testing the Satellite Dish Antenna.....	4-1
A First Look at the HD System	1-1	Displaying the INSTALLATION Screen.....	4-2
<i>What You Should Do First</i>	1-1	<i>Selecting the Correct Type of Satellite Dish Antenna</i>	4-2
<i>How Does All This Work?</i>	1-2	<i>Dish Type Selections</i>	4-2
HD System Components	1-3	Finding the Correct Antenna-pointing Coordinates	4-3
<i>The DIRECTV PLUS™ Satellite Dish Antenna</i>	1-3	<i>Pointing the Dish Antenna</i>	4-4
<i>The DST-3000 Receiver with DIRECTV PLUS™ Receiver Built-in</i>	1-4	<i>Testing Signal Strength</i>	4-4
<i>The Remote Control</i>	1-6	<i>System Test</i>	4-4
<i>Installing the Remote Control Batteries</i>	1-8	Fine Tuning the Pointing of the Dish Antenna	4-5
Setting Up Your Satellite Receiver	2-1	<i>Selecting Transponders</i>	4-6
Choosing the Best Connection for Your Entertainment System	2-2	Adding Terrestrial Antenna or Cable to Your Satellite Connections	4-6
<i>HD Receiver and Satellite Dish Antenna with Terrestrial Antenna or Cable Service</i>	2-3	<i>Local In Connection Options</i>	4-7
<i>HD Receiver and HDTV Monitor</i>	2-4	<i>Scan Channels</i>	4-7
<i>HD Receiver with HDTV Monitor and VCR</i>	2-6	<i>Local Providers</i>	4-7
<i>HD Receiver and Standard Definition TV Monitor</i>	2-8	<i>Local Provider Area Options</i>	4-7
<i>HD Receiver with Standard Definition TV Monitor and VCR</i>	2-9	<i>Testing the Strength of the Terrestrial Digital Channels</i>	4-8
<i>HD Receiver and Dolby® Digital Receiver or Decoder</i>	2-12	Terrestrial Antenna or Cable without a Satellite Connection	4-9
<i>HD Receiver and Standard Stereo System</i>	2-13	<i>Local In Connection Options</i>	4-9
<i>Finishing Up</i>	2-13	<i>Selecting the Correct Satellite Dish Type for Terrestrial-only Operation</i>	4-9
Connecting the VCR Control Cable	2-14	<i>Scan Channels</i>	4-10
<i>Finding the VCR's Remote Control Sensor</i>	2-14	<i>Editing Local Channels</i>	4-10
Now You Can Turn It On	2-14	Time Setup	4-10
<i>POWER-ON Screen</i>	2-15	Installation Is Now Complete	4-10
<i>Exit</i>	2-15	Watching Local Terrestrial and DIRECTV® Programming	5-1
<i>Installation</i>	2-15	Types of Channels	5-1
Controlling the DST-3000 Receiver	3-1	<i>DIRECTV® Programming</i>	5-1
Front Panel vs. Remote Control Keys	3-1	<i>Local Channels from DIRECTV</i>	5-1
Basic Navigation	3-1	<i>Digital (ATSC) Channels with Dish Connection</i>	5-1
		<i>Analog (NTSC) Channels with Dish Connection</i>	5-1
		<i>Digital (ATSC) Channels without Dish Connection</i>	5-1
		<i>Analog (NTSC) Channels without Dish Connection</i>	5-2

Basic Channel Changing	5-2	Setup Menu	7-2
<i>Channel Banner</i>	5-2	<i>Done</i>	7-2
<i>The Information Banner</i>	5-3	<i>Video</i>	7-2
<i>BannerGuide™</i>	5-3	Preferences	7-3
<i>MyLogos™</i>	5-3	<i>Done</i>	7-3
<i>AlphaJump™</i>	5-4	<i>Video</i>	7-3
Alternate Services	5-4	<i>Advanced</i>	7-3
<i>Audio</i>	5-4	<i>Preference Options</i>	7-3
<i>Closed Caption</i>	5-4	<i>Channel Tags</i>	7-3
Advanced Program Guide™	6-1	<i>Scheme</i>	7-3
Program Guide	6-1	<i>Filters</i>	7-4
<i>PROGRAM GUIDE Screen</i>	6-1	<i>Translucency</i>	7-4
<i>PROGRAM GUIDE Pop-up Menu</i>	6-2	Advanced Preferences	7-4
<i>Choosing the Guide Style</i>	6-2	<i>Done</i>	7-4
<i>Descriptions</i>	6-5	<i>Video</i>	7-4
<i>General On-Screen Guide Features</i>	6-6	<i>Advanced Preference Options</i>	7-4
<i>Using the PrePick™ Feature from the</i>		<i>Receiver ID</i>	7-4
<i>Advanced Program Guide™</i>	6-6	<i>Channel Lock</i>	7-5
<i>Using the PrePick™ Feature</i>		<i>Factory Defaults</i>	7-5
<i>for Viewing</i>	6-7	Audio/Video Setup	7-5
<i>Canceling Scheduled Programs</i>	6-7	<i>Audio</i>	7-5
Filtering the Guides	6-7	<i>Dolby Digital</i>	7-5
<i>Theme Filters</i>	6-7	<i>Closed Caption</i>	7-5
<i>Channel List</i>	6-8	<i>TV Resolution</i>	7-6
<i>Guide Times</i>	6-8	<i>Screen Ratio</i>	7-6
The INFORMATION Screen	6-9	<i>Image Shape</i>	7-6
<i>Done</i>	6-9	Limits	7-7
<i>Show Times</i>	6-9	<i>Done</i>	7-7
<i>SHOW TIMES Screen</i>	6-9	<i>Video</i>	7-7
<i>Done</i>	6-9	<i>TV Timer</i>	7-8
<i>Video</i>	6-9	<i>Rating Help</i>	7-8
<i>Guides</i>	6-9	<i>Max Spending</i>	7-9
<i>PrePick™</i>	6-10	Channel Lists	7-9
WORDFINDER™	6-10	<i>Done</i>	7-10
<i>WORDFINDER™ Entry</i>	6-11	<i>Video</i>	7-10
DST-3000 Receiver's Menu System	7-1	<i>AutoSet</i>	7-10
<i>Menu Overview</i>	7-1	<i>Rename</i>	7-10
Main Menu	7-2	<i>Clear</i>	7-10
<i>Guide</i>	7-2	<i>Set</i>	7-10
<i>Video</i>	7-2	<i>Tag Boxes</i>	7-11
		MyLogos™	7-11
		<i>Done</i>	7-11

Installation.....	7-11	<i>Disable</i>	7-17
VCR Setup.....	7-12	<i>Call History</i>	7-17
<i>Brand</i>	7-12	<i>Callback</i>	7-17
<i>Code</i>	7-12	<i>Help</i>	7-17
<i>Test (Record/Stop)</i>	7-12	Lock/Unlock	7-17
Scheduler	7-12	<i>Locking Procedure</i>	7-18
<i>Done</i>	7-12	<i>Unlocking Procedure</i>	7-18
<i>Video</i>	7-12	<i>Temporarily Overriding the Lock</i>	7-19
<i>Event Scheduling Options</i>	7-13	The Remote Control	8-1
<i>Editing an Event</i>	7-13	Remote Control Buttons	8-2
Check Mail	7-14	Programming the Remote Control.....	8-3
<i>Message</i>	7-14	<i>Programming Mode</i>	8-3
<i>Page</i>	7-14	<i>Code Scan</i>	8-3
<i>Erase</i>	7-14	<i>Code Entry</i>	8-4
Purchases	7-14	Using the Remote Control	8-8
<i>Done</i>	7-15	<i>Switching the Remote Control</i>	
<i>Video</i>	7-15	<i>to Operate Additional DST-3000</i>	
<i>History</i>	7-15	<i>Receivers</i>	8-8
<i>Upcoming Purchases</i>	7-15	<i>Identifying Codes That Have Been</i>	
<i>Buy</i>	7-15	<i>Stored</i>	8-8
<i>Buy Options</i>	7-15	<i>Controlling Other Components Using</i>	
<i>Cancel Purchase</i>	7-16	<i>the AUX Button</i>	8-9
<i>Purchase History</i>	7-16	Questions and Answers	A-1
Caller ID	7-16	Specifications.....	A-3
<i>Call History and Callback</i>	7-16	Limited Warranty	A-4
<i>Done</i>	7-16		
<i>Video</i>	7-17		

A First Look at the HD System



Congratulations! You've selected one of the most advanced digital video and audio components available today. You now have the capacity to receive hundreds of channels of video programming and digital-quality audio.

What You Should Do First

Your HD system is both a sophisticated technical product and an easy-to-operate source of entertainment. You should complete the following steps to achieve the greatest performance from your system:

- Confirm the following items are included with your DST-3000 receiver
 - Access card (located behind the door on your DST-3000 receiver)
 - IR (infrared) remote control with 2 AA batteries
 - Owner's Manual
 - 6-foot coaxial RF cable
 - 6-foot VCR control cable
 - 25-foot Telephone cable
 - 8-foot 5-conductor component audio/video cable.
- Read this manual to familiarize yourself with the system.
- Install the DST-3000 receiver.
- Connect the terrestrial antenna or cable for local analog and digital channels.
- Install the DIRECTV PLUS™ antenna and cables. Professional installation is strongly recommended.
- Align the satellite dish antenna.
- Arrange for programming from DIRECTV.

How Does All This Work?

First, here is some information about your HD receiver. Your HD receiver can receive three types of television signals:

- **Analog** signals in **NTSC** (National Television Systems Committee—traditional TV signals) format—from terrestrial, or broadcasting towers built on earth, and cable sources.
- **Digital** signals in **ATSC** (Advanced Television Systems Committee—digital TV signals) format—from terrestrial sources.
- **Digital Satellite** signals—from DIRECTV satellites in space. These signals can be either Standard Definition (SD) signals or High Definition (HD) signals.

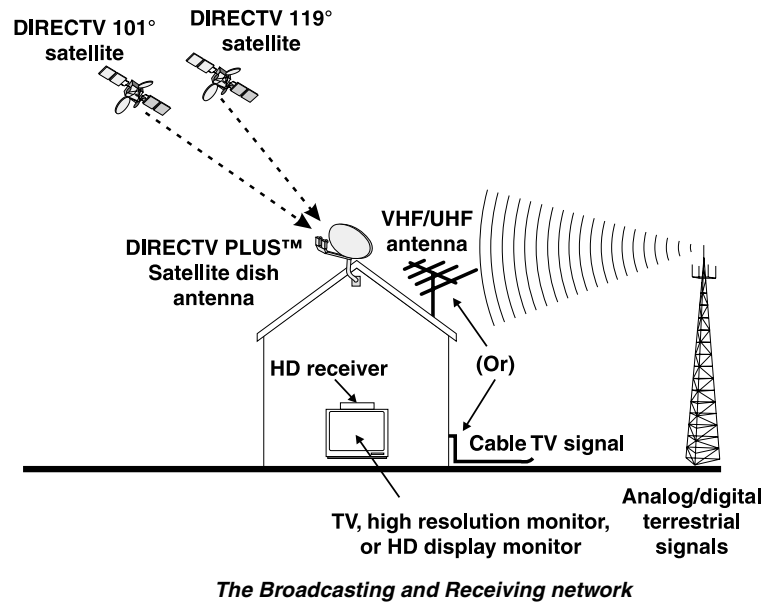

Second, here is some information about the broadcasting and receiving network shown.

Television stations, film studios, and other broadcasters send signals to earthbound terrestrial broadcasting towers and satellites. The tower shown on the right is sending **Digital ATSC** format signals and the more traditional **Analog NTSC** format signals. Both ATSC and NTSC signals can be received by the same VHF/UHF antenna normally mounted on a roof or in an attic. The satellites shown are sending **DIRECTV** programming signals which are received by a **DIRECTV PLUS™** Satellite Dish Antenna usually mounted on a roof or on the ground. These satellites are located in geostationary orbit. Cable television signals are received through cables installed by cable television providers. The terrestrial broadcast (from a tower), satellite, and cable signals then go into your DST-3000 receiver where they are processed and sent to your television set.

HD System Components

There are three main components of the HD system. They are the DIRECTV PLUS™ satellite dish antenna (not included), the DST-3000 receiver, and the remote control.

The DIRECTV PLUS™ Satellite Dish Antenna

The satellite dish antenna, such as the Toshiba HSD-3, is the component that receives the digital signals. It must be mounted to a solid outdoor surface that allows a clear view of the southern sky.

The large dish-shaped part is known as the reflector. The oval-shaped DIRECTV PLUS™ satellite dish antenna enables reception of DIRECTV High Definition programming throughout the United States and local stations in specific cities. The dimensions of the oval dish reflector are approximately 18 inches high by 24 inches wide.

A Low Noise Block (LNB)

Downconverter assembly is attached to the satellite dish antenna at the end of a tubular arm. Your assembly provides for receiving signals from multiple satellite orbit locations and distributing the signal to the HD receiver and up to 3 more DIRECTV digital satellite receivers through the use of a multiswitch (not shown).

The mounting bracket and base plate make adjustments easy during installation. Once the satellite dish antenna has been properly positioned to point toward the satellites, you should never need to adjust it again.

Professional installation of the satellite dish antenna is strongly recommended. This is recommended to help ensure your personal safety, compliance with electrical codes, and compliance with all specifications. The proper installation and aiming of the dish antenna is critical for proper operation. To arrange professional installation, please contact your dealer. Refer to the instructions included with the satellite dish for more details.

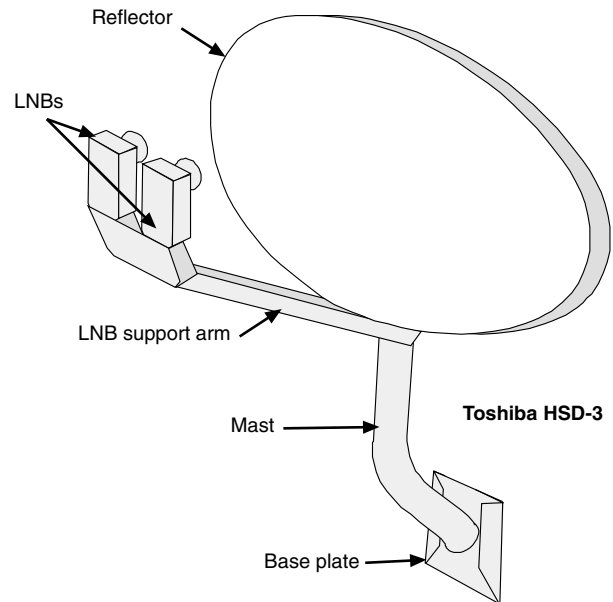

The satellite dish antenna parts. While your dish may vary in appearance, the components are referred to using the same names.

The DST-3000 Receiver with DIRECTV PLUS™ Receiver Built-in

The DST-3000 receiver is one of the most compact available today. The basic features for setup, installation, and viewing programming can be accessed from the front panel keys.

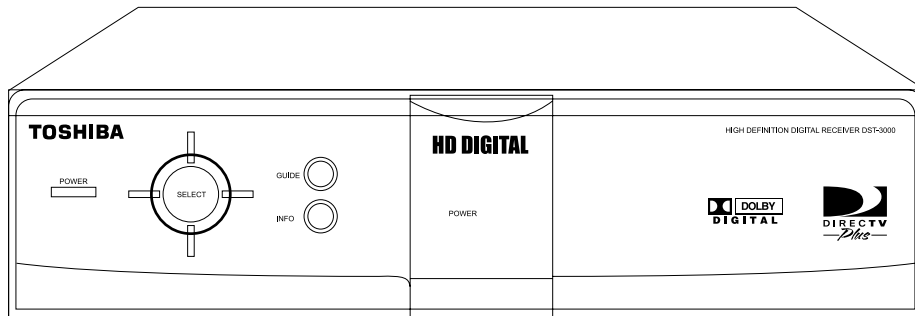

The front of the DST-3000 receiver

Your access card is located behind the door on the right side of the DST-3000 receiver. This special card contains information about your services. This card should not be removed except to protect the DST-3000 receiver from unauthorized use or to replace the card when DIRECTV supplies a new one.

The power key (**POWER**) is used to turn the DST-3000 receiver on and off. The power light will illuminate when the unit is on.

The information key (**INFO**) is used to display descriptions of programs and channels on your TV screen.

Pressing the (**GUIDE**) key will display the on-screen guide, where you can see a listing of all available programs. If the (**GUIDE**) key is pressed while the program guide is already displayed, the Guide Pop-Up menu will be displayed. The Guide Pop-Up menu provides access to the Main Menu or to the different program guide sorting options.

The four directional keys, up (▲), down (▼), left (◀), and right (▶), are used to move the highlight around the program guide and menus. Up and down keys also provide access to the **BannerGuide™** when menus aren't displayed.

The select key (**SELECT**) is used to access a highlighted guide or menu item.

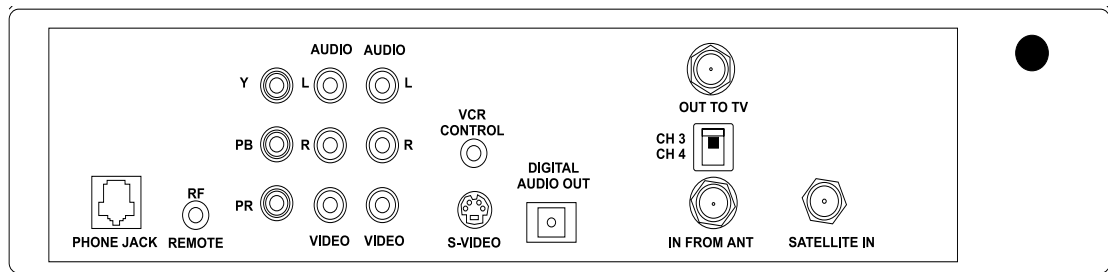

The rear of the DST-3000 receiver (power cord not shown)

The rear of the DST-3000 receiver has numerous jacks for connection to your audio/video entertainment system. You will also find the power cord permanently connected to the back.

The **SATELLITE-IN** F-type jack is for connecting the cable from your satellite dish antenna to the DST-3000 receiver. Be sure that you use RG-6 cable only. The **SATELLITE-IN** F-type jack can also accept a terrestrial analog or digital input when combined with the satellite signal using a diplexer.

Note: Refer to “HD Receiver and Satellite Dish Antenna with Terrestrial Antenna or Cable Service” in Chapter 2 for more information on using a diplexer. This is an advanced installation technique and professional installation is recommended.

The **IN FROM ANT** jack is for connecting a terrestrial analog or digital input to your DST-3000 receiver.

The **OUT TO TV** F-type jack is an RF output that you may connect to your standard definition (SD) TV or videocassette recorder (VCR) (depending on your entertainment system). Note that the **CH3/CH4** switch enables you to select the channel on which DST-3000 receiver signals will appear. Set your TV or VCR to match this.

Three component video output jacks **Y** (Luminance), **P_r** (the amount of color Red is different from Luminance), and **P_b** (the amount of color Blue is different from Luminance) are connected to a High Definition (HD) monitor set to achieve highest quality video images. The output format is always 1080i.

The phono-type **AUDIO** output jacks, labeled and color-coded (**L** is white, and **R** is red) to indicate Left and Right, can be used for connection to your SDTV, VCR, or audio system. The phono-type composite **VIDEO** output jack is color-coded yellow. You may use this jack for connection to your SDTV or VCR. The multiple-pin **S-VIDEO** jack is for high-quality video output. Use this jack to achieve the clearest picture for your TV or VCR. The output format is 480i.

The **VCR CONTROL** mini-jack is for connecting the VCR control cable that is included with the system. With this cable, the DST-3000 receiver can interface with most popular brands of VCRs to record selected programs automatically.

There is one **DIGITAL AUDIO OUT** connector which is **OPTICAL**. It provides signals for connection to a Dolby[®] Digital decoder.

The **RF REMOTE** jack is provided for future accessory use.

The standard RJ-11 modular **PHONE JACK** is for connecting the DST-3000 receiver to your telephone line. This telephone connection is necessary to access certain program offerings such as Pay Per View. Telephone calls generated by the DST-3000 receiver are toll-free. The telephone line connection will not normally interfere with your telephone operation.

The Remote Control

The remote control uses an invisible infrared (IR) light to send signals to your components when you press the keys. You must aim the remote control toward the component for it to receive the command.

The remote control can control your DST-3000 receiver and most TV brands, as well as VCRs and many other auxiliary devices such as cable boxes, amplifiers, and DVD players.

The mode keys across the top of the remote control enable you to specify the device you intend to control. This is important since many devices share the same keys, such as the **POWER** key and the numeric keys. **You must press the appropriate device key before pressing a command key to make sure the remote control sends the right signal to the right device.** The only keys that deviate from this rule are the 9 keys in the center section of the remote plus the (**EXIT**) key, as they are always associated with the DST-3000 receiver.

For the DST-3000 receiver only, the four directional keys will cause the on-screen highlight to move in the direction you want. The keys will be referred to as ◀, ▶, ▲, and ▼.

The select key (**SELECT**) is one of the most important keys. Pressing the **SELECT** key will tell the DST-3000 receiver that you wish to choose the highlighted item.

The arch of keys above the directional keys control frequently used functions. These include menu (**MENU**), program information (**INFO**), favorite lists (**FAV**), and program guide (**GUIDE**) keys.

Pressing the **ACTION** key displays the action icon in the upper left corner of your screen for a few seconds. During this time, you can press other keys to access special functions indicated in blue above the keys. Refer to the chart on the next page for a list of **ACTION** key functions.

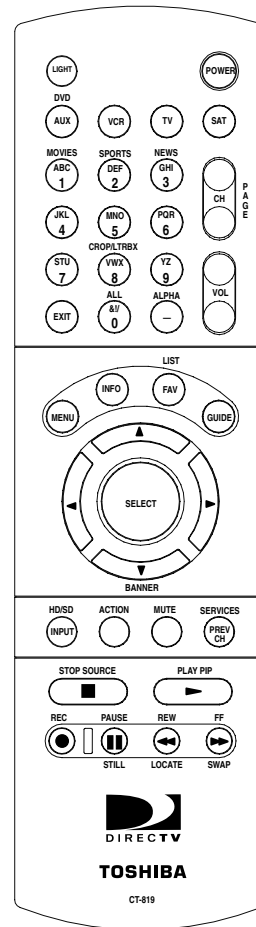

The remote control

The following chart describes the **ACTION** key functions for easy reference:

Keys	Label	Feature
ACTION FAV	LIST	Displays the CHANNEL LISTS screen
ACTION CH	SERVICES	Displays the Alternate Services menu
ACTION 1	MOVIES	Filters the on-screen guide to movies only*
ACTION 2	SPORTS	Filters the on-screen guide to sports only*
ACTION 3	NEWS	Filters the on-screen guide to news only*
ACTION -	ALPHA	Select channel by call sign
ACTION INPUT	HD/SD	Switches the output of the HD receiver between HD and SD**
ACTION 8	CROP/ LTRBX	Modifies video display viewing format
ACTION 0	ALL	Removes all on-screen guide filters.
<p>* Pressing this sequence a second time will undo the respective filter. ** HD formatted video output (1080i) uses the Y, P_r, and P_b jacks. SD formatted video output (480i) uses the Audio/Video (A/V) and Out to TV jack. Note: The first time you turn your system on, the HD formatted video output is active. You may have to press the SAT key followed by the ACTION INPUT key sequence twice to get any picture. A complete explanation of switching from HD to SD can be found in the section “Now You Can Turn It On” on page 2–14.</p>		

The remaining keys are DST-3000 receiver-specific keys and common device keys, including numbers, channel up and down, etc. The functions of these keys change depending on the device currently selected.

Please refer to “Controlling the DST-3000 Receiver” in Chapter 3 for more remote control capabilities and “Programming Your Remote Control” in Chapter 8 for setting your remote control to handle other audio/video components.

Descriptions and details of each individual key will be given in the appropriate subsections throughout this manual.

Installing the Remote Control Batteries

Before the remote control can be used, the two supplied AA batteries need to be installed. First, unsnap the battery cover from the back of the remote control. Install each fresh battery as shown, making sure that the + and – on each battery line up with the marks in the battery compartment. Next, snap the cover back onto the remote control.

Refer to “Programming Your Remote Control” in Chapter 8 for setting the codes to control the devices in your entertainment system.

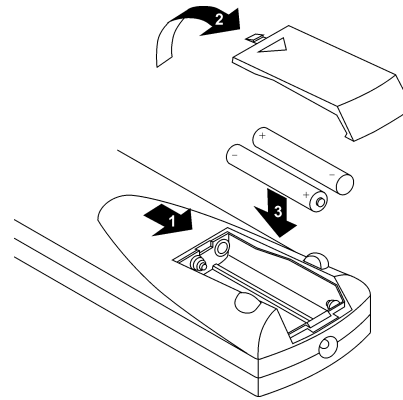

Battery installation

Setting Up Your Satellite Receiver

2

Professional installation of the satellite dish antenna is strongly recommended. This is recommended to help ensure your personal safety, compliance with electrical codes, and compliance with all specifications. The proper installation and aiming of the dish antenna is critical for proper operation. To arrange professional installation, please contact your dealer.

DANGER



To reduce the risk of fire or electrical shock, do not expose this apparatus to rain or moisture.

This chapter provides step-by-step instructions for setting up your HD system and connecting it to your television or entertainment system.

The carton includes the DST-3000 receiver with DIRECTV PLUS™ receiver built-in, an access card (already installed in the DST-3000 receiver behind the door), an IR remote control (batteries included), cables, and this Owner's Manual.

You now need to decide where you want to place the DST-3000 receiver. Choose a location near your TV where the power cord or cables will not be inadvertently disconnected.

CAUTION



Do not stack electronic components or other objects on top of the HD receiver. The slots on top of the receiver must be left uncovered to allow proper airflow to the unit. Blocking the airflow to the unit could impair performance or damage your receiver. Also do not stack the HD receiver on top of a "hot" component such as an audio power amplifier.

Choosing the Best Connection for Your Entertainment System

There are a number of ways to connect the DST-3000 receiver, depending on the other audio/video equipment you wish to use. The simplest hookups are described in the following subsections.

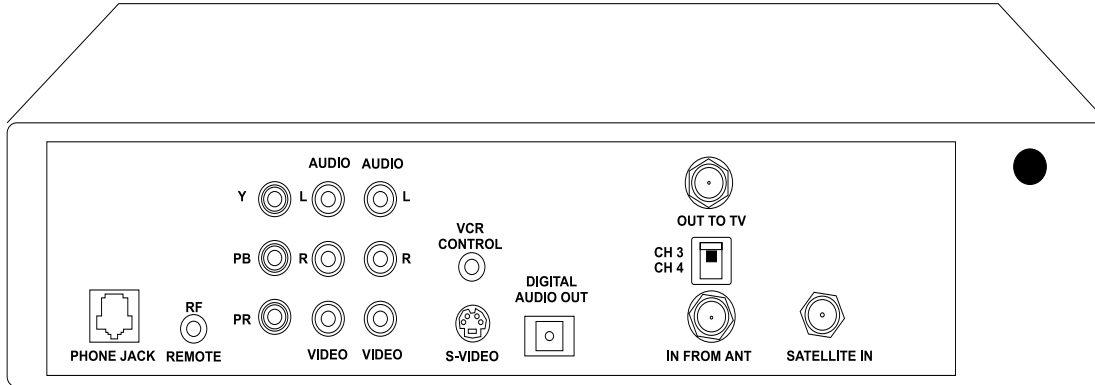

The rear of the DST-3000 receiver (power cord not shown)

Before connecting the DST-3000 receiver to your entertainment system, you should connect the phone line. This can be done by plugging one end of the provided telephone cable into the **PHONE JACK** on the back of the DST-3000 receiver and the other end into a telephone wall jack. If you do not have a telephone jack within reach, you should move the DST-3000 receiver to be within reach of a telephone wall jack, buy a longer telephone cable, or have a new phone jack installed.

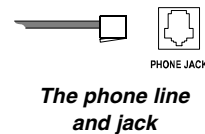

To suit your specific needs, you may need to purchase additional connectors and/or cables from your dealer or electronic hardware store. Choose which hookup method to use based on:

- The capabilities of your TV and VCR.
- Your desire to receive local terrestrial analog and/or digital programming through the DST-3000 receiver.
- Any other devices you want to include in the system (stereo, second VCR, etc.).

Before attempting to connect anything, position yourself so you are looking at the back of your components. Note the various input and output receptacles, their shapes, and how they are labeled. Then read through the rest of this connection subsection before choosing a hookup method and proceeding with the actual installation.

Note: *Make sure the DST-3000 receiver, TV, VCR, and any other devices to be connected are unplugged from the power outlet while hooking them up.*

Some of the connection methods described in this chapter may require optional cables or accessories that are not included with your DST-3000 receiver.

HD Receiver and Satellite Dish Antenna with Terrestrial Antenna or Cable Service

Follow these steps indicated by the diagram below:

- 1) Connect the RG-6 Coaxial Cable from the satellite dish antenna to the back of the HD receiver using the connector marked **SATELLITE IN**.

Optional Hookup: If you plan to combine an outside terrestrial antenna with the signal from the satellite dish antenna, obtain a signal Diplexer* from your local retailer of satellite accessories. Connect the RG-6 Coaxial Cable from the satellite dish antenna to the “power pass” input of the Diplexer, and connect the coaxial cable from the terrestrial antenna to the other input. Connect the output of the Diplexer to the back of the HD receiver at the connector marked **SATELLITE IN**.

** Note: It is very important that you use a Diplexer that is designed to combine satellite signals and terrestrial signals. Standard signal combiners are not compatible.*

- 2) Connect the cable from your terrestrial antenna or cable TV service to the HD receiver at the connection marked **IN FROM ANT**.

Optional Hookup: If you plan to record a terrestrial signal while watching satellite programming, or vice versa, connect the cable from your terrestrial antenna or cable TV service to the input of a standard two-way splitter as shown in the hookup diagram.

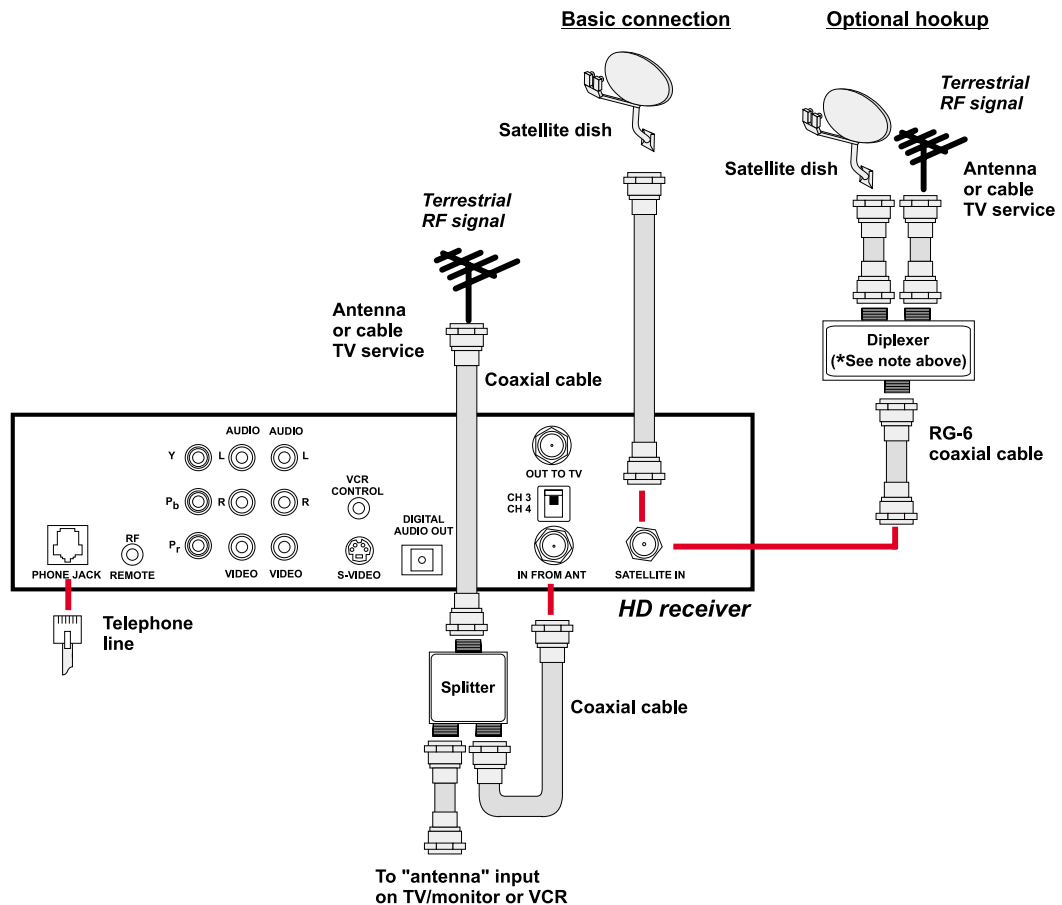

Note: Signals from a terrestrial antenna and cable TV can be connected to the IN FROM ANT connector and diplexed into the SATELLITE IN connection simultaneously. However, the receiver does not support the simultaneous connection of two terrestrial antenna signals or two cable signals.

Note: In order for the Advanced Program Guide™ to receive the correct listing of local channels and local program information from DIRECTV, make sure you select the correct zip code or cable provider on the LOCAL PROVIDERS screen. Refer to Chapter 4, “Setting Up the Satellite Dish Antenna and Terrestrial Inputs.”

HD Receiver and HDTV Monitor

Follow these steps indicated by the diagram on the next page:

- 1) Connect the satellite dish antenna and terrestrial antenna or cable service to the HD receiver following instructions in “HD receiver and Satellite Dish Antenna with Terrestrial Antenna or Cable Service” on page 2–3.
- 2) Connect one set of Component Video Cables (one green **Y** connector, one red **P_r** connector, and one blue **P_b** connector) to the back of the HD receiver using the connections marked **Y**, **P_r**, and **P_b**. Connect the other ends of this cable to the back of the HDTV monitor using the HDTV input connections marked **Y**, **P_r**, and **P_b**.

Note: Connect the Y, P_r, and P_b connectors of the HD receiver only to the Y, P_r, and P_b connectors on your TV that are compatible with HD signals in the 1080i scanning rate and that comply with the EIA 770.3 signal standards. Refer to your television owner’s guide for verification.

- 3) Connect one set of audio cables (one white left audio connector and one red right audio connector) to the back of the HD receiver using the connectors marked **AUDIO L, R**. Connect the other end of the audio cables to the back of the HDTV monitor using the audio inputs.

Note: This connection allows the use of the speakers in the TV to hear the sound.

- 4) **Optional:** Connect one set of audio cables and a video or S-video cable to the back of the HD receiver using the connectors marked **AUDIO L, R** and **VIDEO** or **S-VIDEO**. Connect the other end of audio and video cables to the back of the HD monitor using the **AUDIO** and **VIDEO** or **S-VIDEO** inputs.

Note: This connection allows you to send standard 480i signals to your TV.

For better standard definition performance, if your TV has an S-VIDEO connector, then use an S-video cable instead of the yellow video cable.

Note: When the HD receiver is converting all signals to standard 480i signals that can be viewed on standard video inputs of TVs, there will be no signals on the Y, P_r, and P_b connectors. When the HD receiver is converting all signals to 1080i format that can be sent to the HDTV input of HD monitors, there will be no standard 480i signals to standard video inputs of TVs.

If you have connected a VCR into your entertainment system in a way that routes the cables from the DST-3000 receiver to your VCR before the signal reaches the TV, you may experience a distorted picture if you attempt to record a copy-protected program. These programs are identified by a “Can’t Tape” symbol in the banner area of the screen. If this occurs, simply stop the recording process and your picture will automatically correct itself.

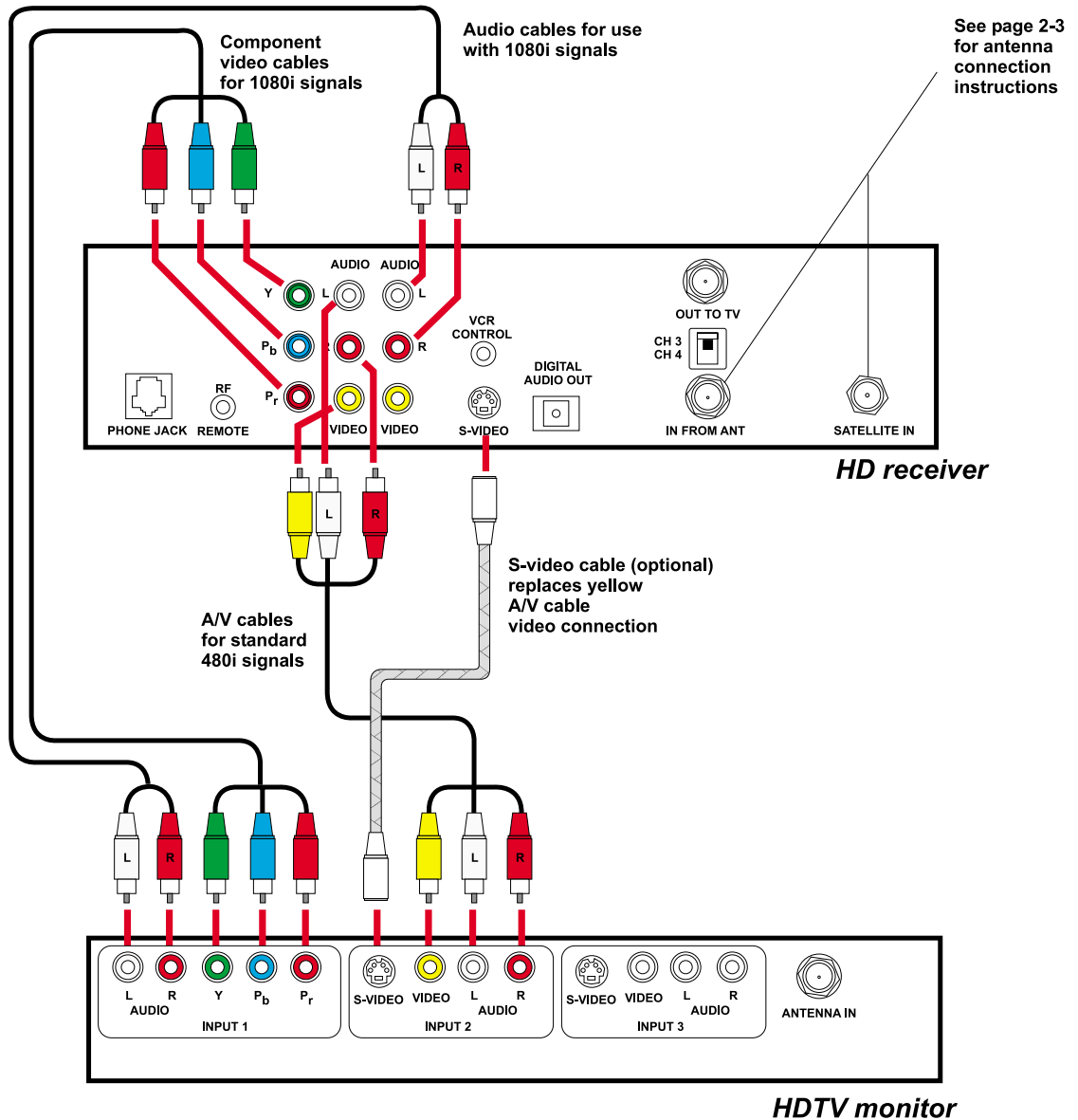

HD Receiver with HDTV Monitor and VCR

Follow these steps indicated by the diagram on the next page:

- 1) Connect the satellite dish antenna and terrestrial antenna or cable service to the HD receiver following the instructions in “HD Receiver and Satellite Dish Antenna with Terrestrial Antenna or Cable Service” on page 2-3.
- 2) Connect one set of Component Video Cables (one green **Y** connector, one red **P_r** connector, and one blue **P_b** connector) to the back of the HD receiver using the connections marked **Y**, **P_r**, and **P_b**. Connect the other ends of this cable to the back of the HDTV monitor using the HDTV input connections marked **Y**, **P_r**, and **P_b**.

Note: Connect the Y, P_r, and P_b connectors of the HD receiver only to the Y, P_r, and P_b connectors on your TV that are compatible with HD signals in the 1080i scanning rate and that comply with the EIA 770.3 signal standards. Refer to your television owner’s guide for verification.

- 3) Connect one set of audio cables (one white left audio connector and one red right audio connector) to the back of the HD receiver using the connectors marked **AUDIO L, R**. Connect the other end of the audio cables to the back of the HDTV monitor using the audio inputs.

Note: This connection allows the use of the speakers in the TV to hear the sound.

- 4) Connect a set of audio/video or S-video cables to the second set of **AUDIO L, R**, and **VIDEO** or **S-VIDEO** connectors on the back of the HD receiver. Connect the other end to the **AUDIO**, **VIDEO**, or **S-VIDEO** input connections on the back of the VCR.
- 5) Connect another set of audio/video or S-video cables to the back of the VCR using the **AUDIO** and **VIDEO** output connection. Connect the other end of this cable to a group of standard **AUDIO**, **VIDEO**, or **S-VIDEO** input connections on the back of your TV.

Note: This connection allows you to send HD receiver signals, converted to standard 480i signals, to your VCR so they can be recorded.

You can see the playback of a video tape by selecting this input on your TV. You can also pass HD receiver signals, converted to standard 480i format, through your VCR to your TV; however, you may need to turn on your VCR to pass these signals.

When the HD receiver is converting all signals to standard 480i signals that can be recorded by standard VCRs, there will be no signals on the Y, P_r, and P_b connectors.

When the HD receiver is converting all signals to 1080i format that can be sent to the HDTV input of the HD monitors, there will be no standard 480i signals to send to VCRs or standard video inputs of TVs.

For better performance, if both the TV and the VCR have S-video connectors, use S-video cables instead of standard yellow video cables.

Note: If you have connected a VCR into your entertainment system in a way that routes the cables from the DST-3000 receiver to your VCR before the signal reaches the TV, you may experience a distorted picture if you attempt to record a copy-protected program. These programs are identified by a “Can’t Tape” symbol in the banner area of the screen. If this occurs, simply stop the recording process and your picture will automatically correct itself.

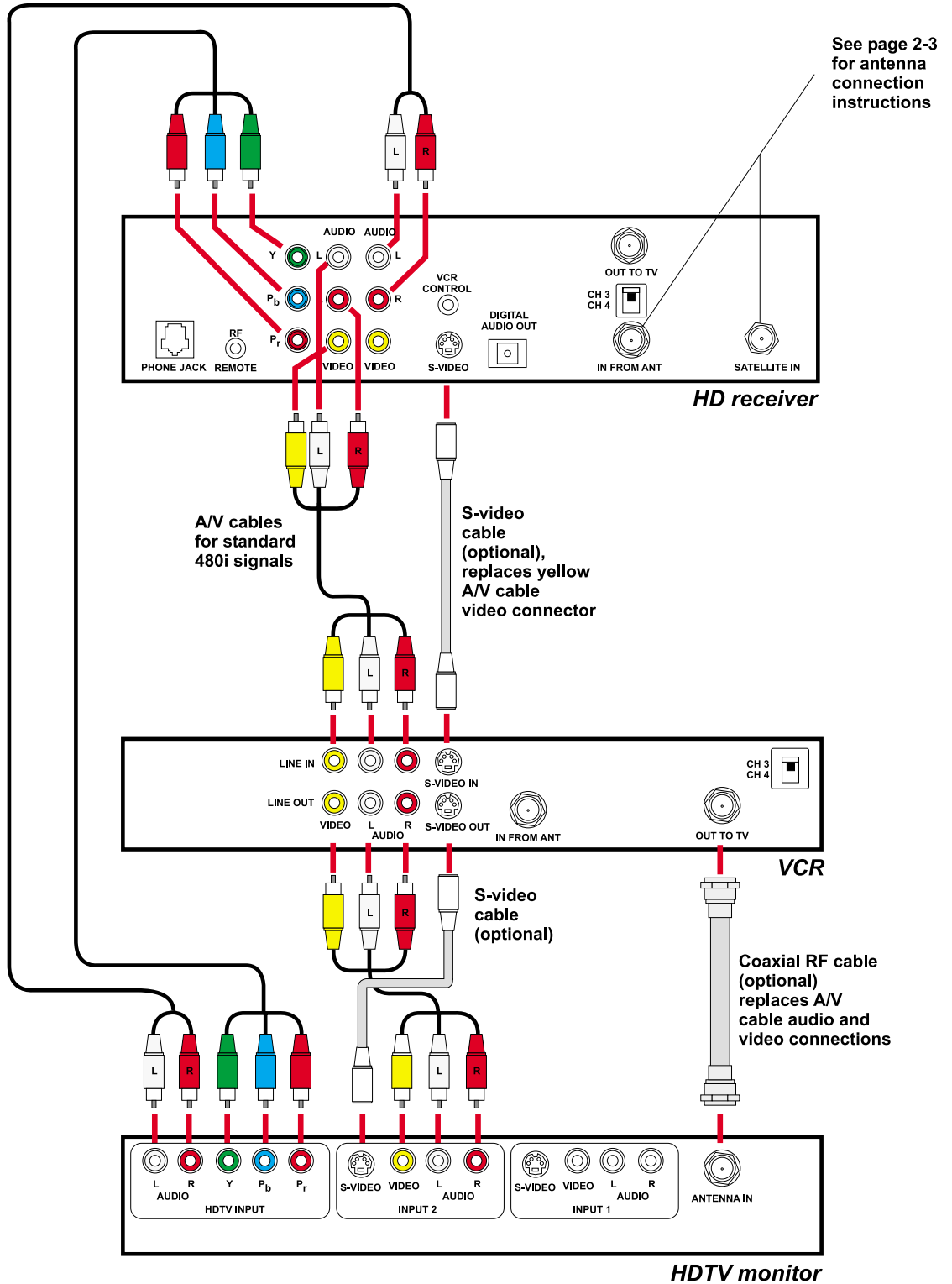

HD Receiver and Standard Definition TV Monitor

Follow these steps indicated by the diagram on the next page:

- 1) Connect the satellite dish antenna and terrestrial antenna or cable service to the HD receiver following the instructions in “HD Receiver and Satellite Dish Antenna with Terrestrial Antenna or Cable Service” on page 2–3.
- 2) Connect one set of standard audio/video cables (one yellow video connector, one white left audio connector, and one red right audio connector) to the back of the HD receiver using the connectors marked **AUDIO L, R** and **VIDEO**. Connect the other end of the audio/video cable to the back of the TV monitor using the AUDIO and VIDEO inputs.

Optional: If your TV has an S-VIDEO input, then connect one end of an S-video cable to the back of the HD receiver using the output marked **S-VIDEO**. Connect the other end of the S-video cable to the back of the TV using the S-VIDEO input that matches the previously used audio inputs. If you use an S-video cable, you will not need to use the yellow video cable.

- 3) **Optional:** If the TV does not have AUDIO/VIDEO input connectors, then connect one end of a coaxial RF cable to the OUT TO TV connector on the back of the HD receiver. Connect the other end of the coaxial RF cable to the antenna input connector on the back of the TV. Set the CH3/CH4 switch on the HD receiver to the channel not used in your area. It is this channel you will select on your TV to view the HD receiver.

***Note:** When the HD receiver is in HD output mode or in standby (power LED off), the RF signal received on the IN FROM ANT connector will pass through to the OUT TO TV connector.*

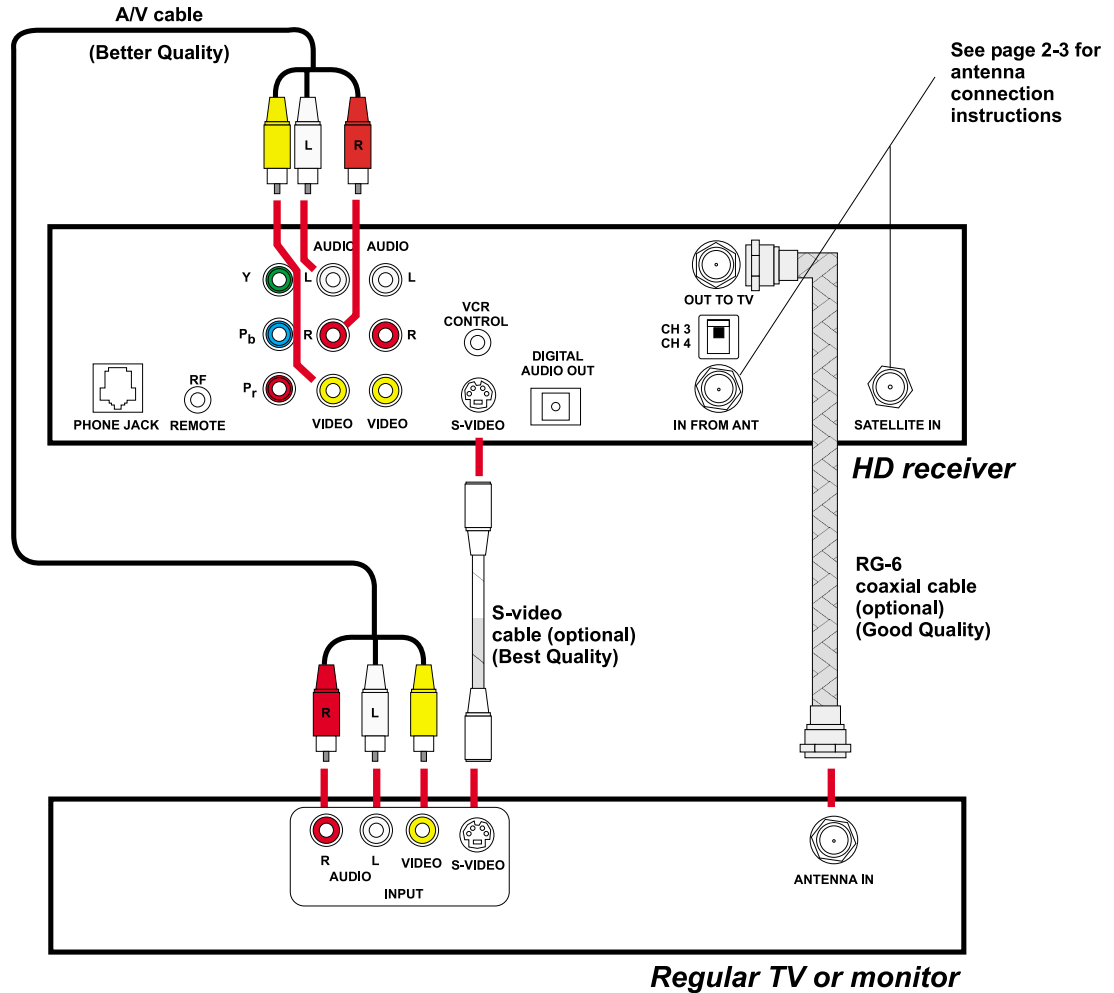

HD Receiver with Standard Definition TV Monitor and VCR

Follow these steps indicated by the diagram on the next page.

- 1) Connect the satellite dish antenna and terrestrial antenna or cable service to the HD receiver following the instructions in “HD Receiver and Satellite Dish Antenna with Terrestrial Antenna or Cable Service” on page 2–3.
- 2) Connect one set of standard Audio/Video cables (one yellow video connector, one white left audio connector, and one red right audio connector) to the back of the HD receiver using the connectors marked **AUDIO L, R and VIDEO**. Connect the other end of the Audio and Video cables to the back of the TV monitor using the Audio/Video input connectors.

Optional: For better performance, if your TV has an S-VIDEO input, then use an S-Video cable instead of a standard yellow Video cable.

- 3) Connect another set of standard Audio/Video cables to the back of the HD receiver using the connectors marked **AUDIO L, R and VIDEO**. Connect the other end of the audio and video cables to the back of the VCR using the AUDIO/VIDEO input connectors.

- 4) Connect another set of standard audio/video cables to the back of the VCR using the AUDIO and VIDEO output connectors. Connect the other end of this cable to another group of unused input connectors on the back of the TV.

Note: There are possible variations to steps 3, and 4 above. For example, if your TV or monitor has only one set of AUDIO/VIDEO input connectors, or if you have an S-VHS VCR, you may choose the following connection variation: Connect the AUDIO and VIDEO or S-VIDEO connectors of the HD receiver only to the VCR. Then connect the VCR output connectors to the TV. In this situation, you may need to turn on your VCR to pass HD receiver signals to your TV.

- 5) **Optional:** If the TV does not have AUDIO/VIDEO input connectors, then connect one end of a coaxial RF cable to the OUT TO TV connector on the back of the HD receiver. Connect the other end of the coaxial RF cable to the antenna input connector on the back of the VCR. Connect another coaxial RF cable to the antenna output connector on the back of the VCR and connect the other end of this cable to the ANTENNA or VHF input connector on the back of the TV. Set the CH3/CH4 switch on the HD receiver to the channel not used in your area. It is this channel you will select on your TV to view the HD receiver.

Note: If you have connected a VCR into your entertainment system in a way that routes the cables from the DST-3000 receiver to your VCR before the signal reaches the TV, you may experience a distorted picture if you attempt to record a copy-protected program. These programs are identified by a “Can’t Tape” symbol in the banner area of the screen. If this occurs, simply stop the recording process and your picture will automatically correct itself.

Note: When the HD receiver is in HD output mode or in standby (power LED off), the RF signal received on the IN FROM ANT connector will pass through to the OUT TO TV connector.

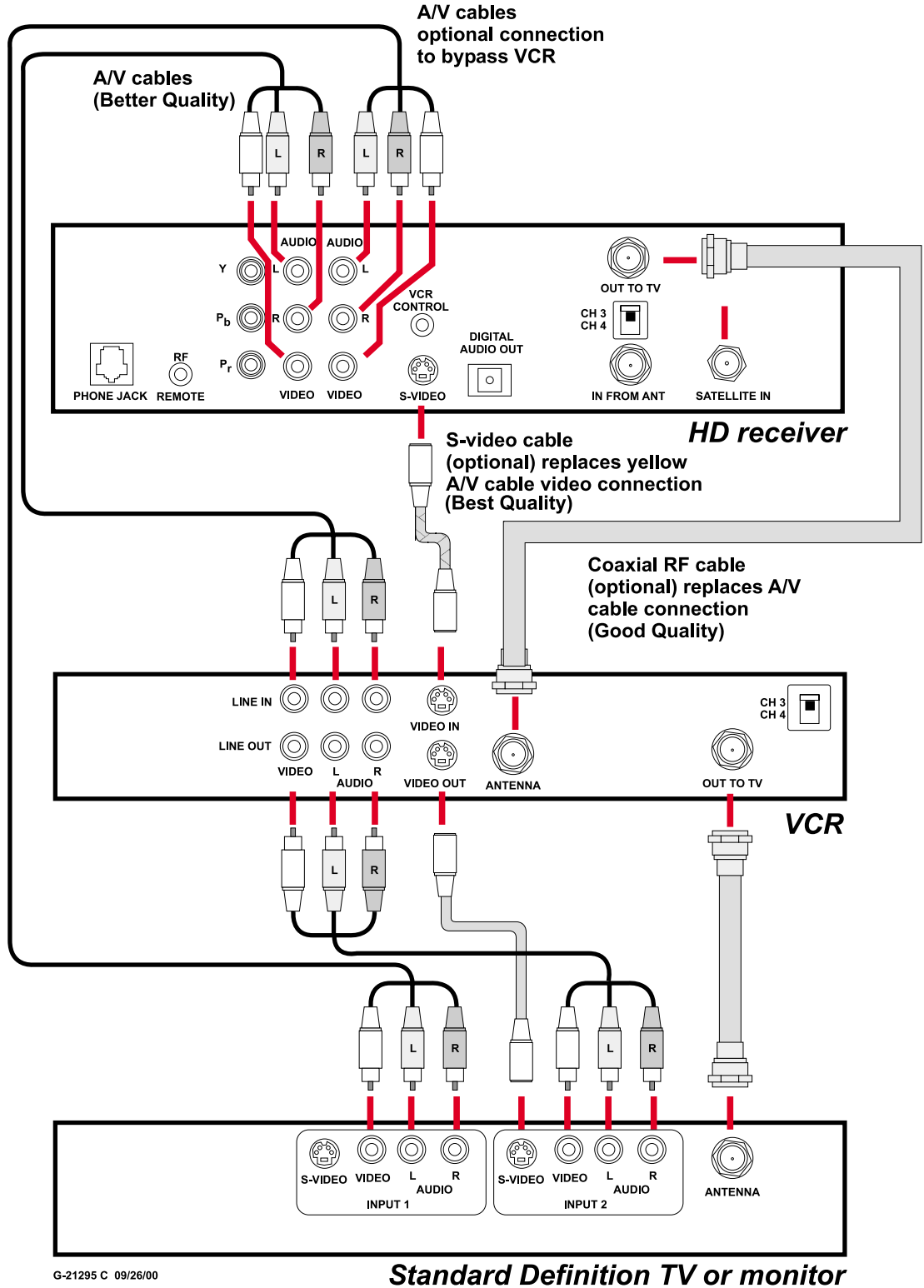

G-21295 C 09/26/00

HD Receiver and Dolby® Digital Receiver or Decoder

Follow these steps indicated by the diagram below:

- 1) Connect an optical digital cable (not included) to the back of the HD receiver using the connector marked **DIGITAL AUDIO OUT**. Connect the other end of this cable to the optical input on the back of your Dolby Digital receiver or decoder.
- 2) Check the Owner's Guide for the Dolby Digital receiver or decoder for proper set-up and operation.

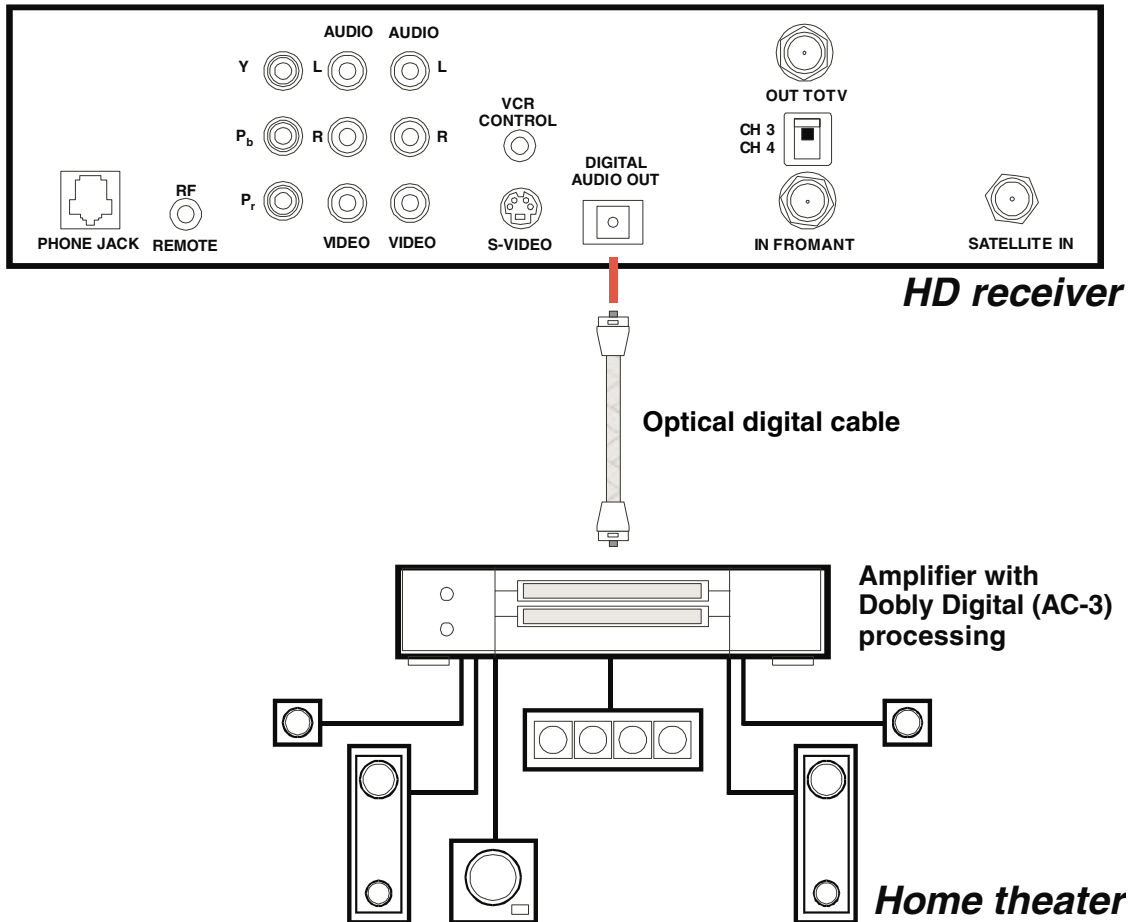

HD Receiver and Standard Stereo System

Follow these steps indicated by the diagram below:

- 1) Connect a set of stereo audio cables (one white left connector and one red right connector) to the back of the HD receiver using the connectors marked **AUDIO L, R**. Connect the other ends of the cables to the back of your stereo system using a set of **AUDIO** inputs. You may select any input except for the input marked **PHONO, TT, or TURN-TABLE**. Those inputs are for turntables only and will distort the sound from any other components.

*Note: If you used both sets of connectors marked **VIDEO** and **AUDIO L, R** in connecting your TV or VCR you will have to replace one set of the **AUDIO L, R** connections as shown below.*

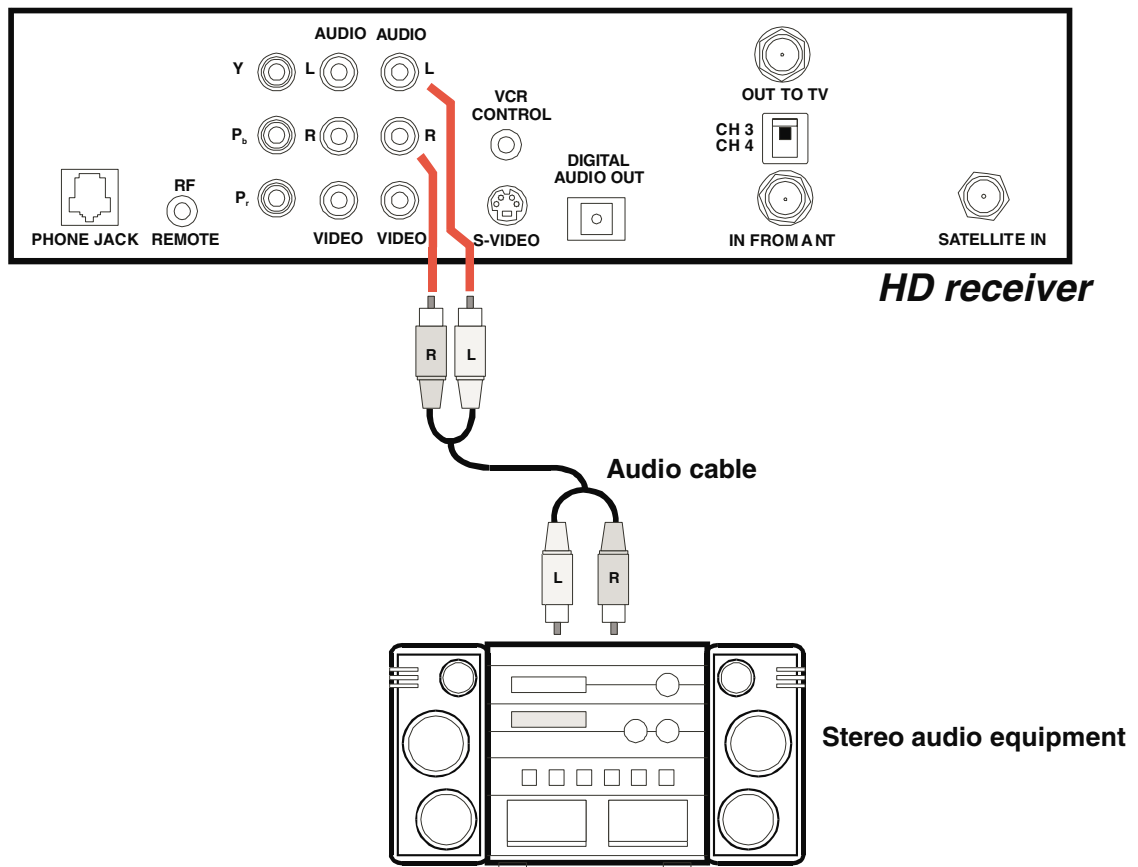

Finishing Up

You can mix and match the different hookups described herein to suit your entertainment system's available connections. For example, you can connect the VCR using audio/video cables, while the TV is connected with the coaxial RF cable. Always try to achieve the highest quality audio and video and greatest flexibility possible.

Once all connections have been completed, connect the TV, VCR, and DST-3000 receiver to the wall power outlet, appropriate extension cord, or surge protector.

Note: A surge protector is recommended to reduce the chance of receiver damage due to electrical surges on the power line.

Connecting the VCR Control Cable

With the proper connections the DST-3000 receiver can control your VCR for unattended recording.

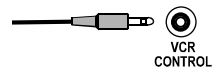

The VCR Control cable and jack

Note: The output of the HD receiver must be in SD mode to record using the connection configurations previously described in this chapter.

Finding the VCR's Remote Control Sensor

Plug the VCR control cable into the back of the DST-3000 receiver.

So that the DST-3000 receiver can control your VCR, the emitter end of the VCR control cable must be attached where the VCR's remote control sensor is located. This is labeled on some VCRs. You may also find a diagram in your VCR manual indicating the sensor position. It is commonly identifiable by a small dark plastic window. For reference, see the sensor on the DST-3000 receiver located in the center.

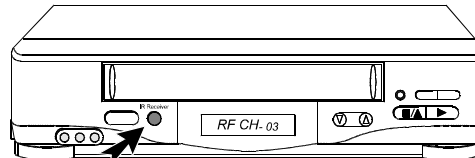

Look for indications of the remote control sensor

If the sensor is not labeled or documented, you will need to scan the front of your VCR with your VCR remote control. Use the following procedure to accomplish this:

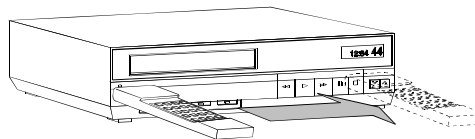

Scanning for the remote control sensor

- Hold the VCR remote control about ½-inch from the front left side of your VCR.
- Slowly move the remote control to the right repeatedly pressing the remote control's **POWER** key on and off.
- Once the VCR responds to pressing the **POWER** key on the remote control, note the position of the remote control. This should indicate the location of the VCR remote control sensor.

Once the sensor position has been determined, temporarily attach the emitter to the area with a piece of tape until the system can be tested. Refer to the “VCR Setup” subsection in Chapter 7, “DST-3000 Receiver’s Menu System,” to program and test the VCR control feature.

Upon verifying that the VCR control is functioning properly, you can remove the tape and permanently attach the emitter using the peel-and-stick backing. This attachment should not interfere with normal VCR operation.

Now You Can Turn It On

Once you have connected everything, you can begin powering up the components. Turn the TV on and set it to the HD input, VIDEO or S-VIDEO, or the DST-3000 receiver's output channel (3 or 4). Do the same for the VCR, if applicable. Now turn the DST-3000 receiver on. You will see the start-up screen for several seconds.

*Note: The HD receiver VIDEO output defaults to the Y, P_r, and P_b HD connectors when first used. If you are not using an HDTV monitor, or prefer to use the standard video outputs, try switching the outputs of the HD receiver from HD to SD. Using the remote control, press the **SAT** button once, then press the **ACTION** button, followed by the **INPUT** button. Pressing this sequence of keys will switch the receiver between the High Definition (1080i) output mode and the Standard Definition (480i) output mode. Following one or more of this **ACTION** **INPUT** sequence, your picture should appear.*

POWER-ON Screen

As power is applied to the DST-3000 receiver for the first time after being plugged in or after a power failure, the **POWER-ON** screen, shown on the right, is displayed. The screen will not appear each time you press the *Power* button.

A panel will display an *Exit* and an *Installation* button. Below that, a progress meter will display illuminated boxes, which will progressively light up from left to right as the system powers up.



The POWER-ON screen

Exit

Highlighting the *Exit* button on the screen and pressing the **SELECT** key on the remote control causes an exit from the **POWER-ON** screen and interrupts the Guide data acquisition.

Installation

If the power is on, but the satellite dish antenna or local area antenna or cable system inputs are not yet installed, highlighting the *Installation* button and pressing the **SELECT** key on the remote control will display the **INSTALLATION** screen. Read Chapter 4 for installation and testing instructions.

If the satellite is properly pointed, the program guide is loaded when power is applied. You can exit out of this start up process, but you would not load the current guide data. Allow time for this program data to load.

Note: If your satellite dish is properly pointed and receiving a signal, this boot-up process is necessary to completely load the Advanced Program Guide™ information. If you exit this screen before it is complete, or have yet to install the satellite dish, this process will take place later. Loading Advanced Program Guide™ data can take several minutes.

If you are using the HD receiver with only the terrestrial antenna or cable signal, you can immediately exit this screen.

Controlling the DST-3000 Receiver

3

Now it's time for you to take control. Take a few minutes to read through this chapter to begin to understand how to operate your system. Let's begin with a couple of simple rules. First, understand there is nothing you can do, using the front panel keys or the remote control keys, which could harm DST-3000 receiver in any way. Once you understand the capabilities and options available in your receiver, you'll be able to undo any changes or settings that you make.

It is not necessary to know everything your system can do right away. As you use the DST-3000 receiver, the techniques necessary to control it will become second nature.

Front Panel vs. Remote Control Keys

The front panel provides all the basic controls needed to access and use the primary features of the DST-3000 receiver. The remote control has additional keys to provide shortcuts or access to extended features of the DST-3000 receiver. Most of the remote control keys can also be used to control other components in your entertainment system. For this reason, you must remember to press the **SAT** key, putting the remote control in DST-3000 receiver mode, when you want to control the DST-3000 receiver.

Basic Navigation

The most common DST-3000 receiver-related keys that you will use are **▲**, **▼**, **◀**, **▶**, and **SELECT**. Four distinct keys on the DST-3000 receiver front panel represent the direction keys. On the remote control, the direction keys are represented by the top, bottom, left, and right keys surrounding the **SELECT** key. These keys are primarily used to move the highlight (also known as a cursor) around the screen. Press the **SELECT** key to activate a highlighted item.

Another key you will be using frequently is the **GUIDE** key, located on both the front panel of the DST-3000 receiver and on the remote control. This key is used when you want to display the current on-screen guide. Once you are in the guide, pressing the **GUIDE** key while a program title is highlighted will display the Guide pop-up menu.

Another key appearing on both the front panel and the remote control is the **INFO** key. This key is used to retrieve descriptive information about a currently airing event and to provide access to scheduling information (and purchasing information for pay per view) about highlighted programs in the on-screen guide.

The final key that appears on both the remote control and the front panel is the **POWER** key. Make sure the remote control is in "SAT" mode for the **POWER** key to control the DST-3000 receiver. When you turn the DST-3000 receiver off, it has not actually stopped using electricity. Rather, it goes into a standby mode that enables it to continue monitoring data sent by DIRECTV, call in

status reports to DIRECTV, start and stop your VCR for programs you have scheduled, receive messages, and perform other background activities.

There are two keys on your remote control that most people use frequently. They are the **FAV** and the **EXIT** keys.

After you have established favorite channel lists, as described in Chapter 7, “DST-3000 Receiver’s Menu System,” you can use the **FAV** key to cycle through them quickly and easily. Each press of the **FAV** key will advance to the next list of channels. After stepping through the favorite lists, it will cycle back to “All Channels.”

At any time, you can exit the on-screen guide by selecting *Video* in the Guide pop-up menu. An even faster way is to press the **EXIT** key. The **EXIT** key also clears all inputs and menus, and returns to the program you were watching.

Setting Up the Satellite Dish Antenna and Terrestrial Inputs



There is a cluster of DIRECTV satellites in space, and, just as a telescope is pointed at a star, you need to point your satellite dish at the satellites. In this chapter, we will explain how to configure your receiver for your satellite dish antenna, where to point your satellite dish antenna, and how to configure your receiver for analog or digital terrestrial (broadcast or cable) reception.

It is recommended that you have the satellite dish and terrestrial antennas professionally installed. If you choose to install the antennas yourself, please pay special attention to the precautions in the front of this manual and refer to the installation instructions packaged with the satellite dish antenna.

Your satellite dish antenna will need to be pointed at a satellite cluster located 22,300 miles in orbit above the equator. To aim the satellite dish antenna at the satellites, you need to know the azimuth, elevation, and tilt angles. The HD receiver will assist you in determining these angles.

Set-up of the satellite dish antenna and terrestrial inputs will be explained in three parts:

- 1) Installing and testing the satellite dish antenna by itself first.
- 2) Setting up and testing terrestrial or cable inputs.
- 3) Setting up and testing terrestrial or cable inputs by themselves, without a satellite dish antenna.

Installing and Testing the Satellite Dish Antenna

Installing your dish antenna involves four separate steps:

- Selecting the correct type of satellite dish antenna.
- Finding the correct dish antenna pointing coordinates.
- Pointing the dish antenna.
- Testing the strength of the satellite signal.

Displaying the INSTALLATION Screen

Highlighting the *Installation* button on the **POWER-ON** screen (explained on page 2-15) and pressing the **SELECT** key on the remote control will display the **INSTALLATION** screen shown on the right.

If this is not the first time the DST-3000 receiver is turned on after being plugged in, follow these steps:

- Open the MAIN MENU screen by pressing the **MENU** key on the remote control.
- Using the **▲** and **▼** keys, highlight the *Setup Menu* Button then press the **SELECT** key on the remote control to display the **SETUP** menu.
- Using the **▲** and **▼** keys, highlight the *Installation* Button then press the **SELECT** key on the remote control to display the **INSTALLATION** screen.

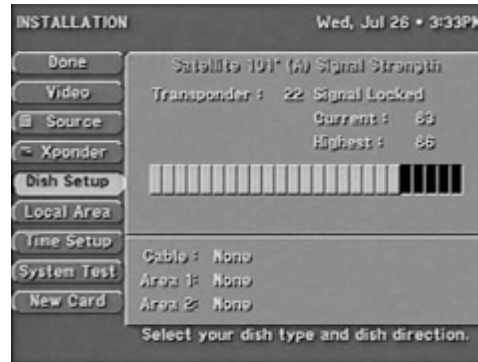

The **INSTALLATION** screen

Selecting the Correct Type of Satellite Dish Antenna

You need to select the correct type of dish antenna that you have connected, so that the DST-3000 receiver can calculate the correct coordinates for pointing the dish antenna.

Highlighting the *Dish Setup* button on the **INSTALLATION** screen and pressing the **SELECT** key on the remote control will display the **DISH SETUP** screen. Highlighting the *Dish Type* button on the **DISH SETUP** screen and pressing the **SELECT** key on the remote control will display the **DISH TYPE** pop-up menu. Press the **▲** and **▼** keys to highlight the type of dish antenna that is connected to the DST-3000 receiver and then press the **SELECT** key.

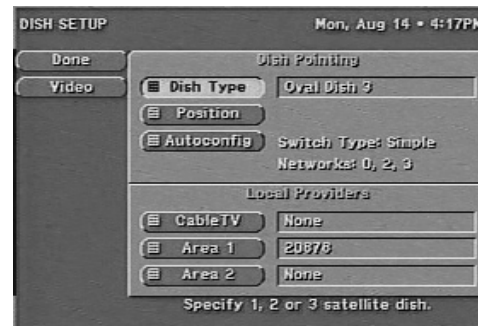

The **DISH SETUP** pop-up menu

Dish Type Selections

Note: You must select the correct dish antenna type to obtain correct pointing results.

The dish type selections are:

- None** Highlight this selection if you are not connecting a dish antenna, but are connecting a terrestrial antenna or cable signal.
- Round Dish** Highlight this selection if you connected an 18" round dish antenna. This setting allows the DST-3000 receiver to receive a signal from the main satellite, located at 101°.

Note: A round dish antenna will not receive High Definition satellite signals from DIRECTV.

- Oval Dish 2** Highlight this selection if you connected a DIRECTV PLUS™ oval dish antenna with two LNBS. This setting allows the DST-3000 receiver to receive signals from Satellite A at 101° and Satellite B at 119°, enabling reception of DIRECTV High Definition programming throughout the United States as well as local stations in specific cities. Most users will have this type of dish.
- Oval Dish 3** Highlight this selection if you connected a DIRECTV PLUS™ oval dish antenna with the optional Satellite C LNB kit purchased separately from your local satellite system installer. This setting allows the DST-3000 receiver to receive signals from Satellite A at 101°, Satellite B at 119°, and Satellite C at 110°, enabling the reception of local stations in additional specific cities in the United States.
- Cancel** Highlight this selection to return to the **DISH SETUP** screen without making a dish antenna type selection.

Highlighting a selection button as explained immediately above and pressing the **SELECT** key on the remote control will confirm the selection and return to the **DISH SETUP** screen.

Finding the Correct Antenna-pointing Coordinates

The **POSITION** pop-up menu will provide you with the correct coordinates to point your dish antenna. This is important to receive all of the channels you are entitled to when you subscribe to DIRECTV.

Highlighting the *Position* button on the **DISH SETUP** menu and pressing the **SELECT** key on the remote control will display the **POSITION** pop-up menu. Using the ▲ and ▼ keys, and highlighting either the *ZIP Code* or *Latitude/Longitude* button and pressing the **SELECT** key on the remote control will display the corresponding pop-up menu.

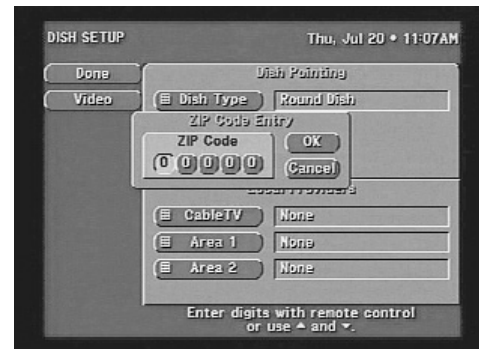

The ZIP Code pop-up menu

To select a digit, use the number keys or the ▲ and ▼ keys on the remote control to enter your ZIP Code or Latitude and Longitude. After the last number has been entered, highlight the *OK* button and press the **SELECT** key on the remote control to confirm the entry. The **RESULTS** screen will display. Highlighting the cancel button and pressing the **SELECT** key on the remote control will return to the **DISH SETUP** menu.

Pointing the Dish Antenna

The DST-3000 receiver will calculate the correct pointing coordinates and then display this information on the **RESULTS** screen shown on the right. Write down this Elevation, Azimuth, and Tilt information. Then highlighting the **OK** button and pressing the **SELECT** key on the remote control will return to the **DISH SETUP** Menu. Use the coordinates from the **RESULTS** screen to point your dish antenna at the sky. The separate installation instructions that come with the dish antenna will explain exactly how to use the Elevation, Azimuth, and Tilt information.

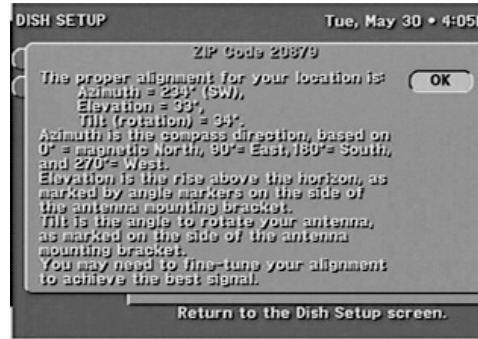

The RESULTS screen

Note: The round dish has no tilt information.

Testing Signal Strength

The **INSTALLATION** screen shown at the right will display the strengths of signals from the different satellites and the transponders on each satellite. The screen displays a numerical strength indication and a bar graph accompanied by an audible tone to indicate signal strength. The higher the number, the greater the amount of the bar graph occupied, or the faster the beeping tone, the stronger the signal.

You can check the signals from each of the satellites that match the type of dish that you selected on the **DISH TYPE** screen.

Highlighting the **Source** button on the **INSTALLATION** screen and pressing the **SELECT** key on the remote control will display the **Signal Source** pop-up menu shown at the right. Highlighting **Satellite 101° (A)**, **Satellite 119° (B)**, **Satellite 110° (C)**, or **Local Digital** and pressing the **SELECT** key on the remote control will return to the **INSTALLATION** screen and show the signal strength for the selected source.



The INSTALLATION screen

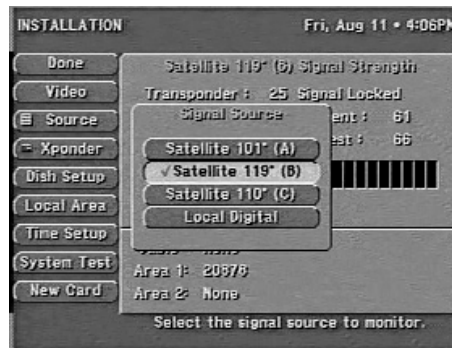

The Signal Source screen

System Test

The **SYSTEM TEST** screen allows you to test the DST-3000 receiver and its satellite antenna connections. The **SYSTEM TEST** Menu offers the following options:

- Begin Test** Starts the receiver test, which provides basic status information about the receiver. The test may take up to 1 minute.
- Cable Test** Tests and displays indicators of all transponder signals from the satellite chosen by the **Source** pop-up menu.
- Upgrade** Checks the status of software upgrades that DIRECTV periodically performs.

Highlighting the *System Test* button on the **INSTALLATION** screen and pressing the **SELECT** key on the remote control will display the **SYSTEM TEST** screen. Using the ◀ and ▶ keys, highlight either the *Begin Test* or *Cable Test* button and press the **SELECT** key on the remote control. After a short period of time, the results of the test will be displayed.

You should perform the cable test for each of the satellites supported by the dish antenna you selected in the **DISH TYPE** screen.

Note: Not all of the transponders on Satellites B (119°) and C (110°) are currently being used. On Satellite B, for example, you may receive NA (Not Available) indications for several transponders. This is normal.

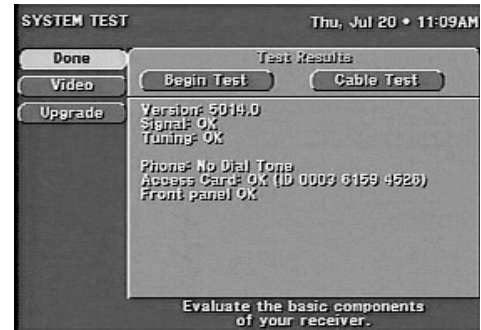

The SYSTEM TEST screen

When you have received a strong signal from several transponders on each of the satellites you are setting up, you have completed the setup for digital satellite channels. A numeric value for the signal strength ranges from 0 to 99. While your signal strength may vary, refer to the following map to determine the suggested signal strength for your area:

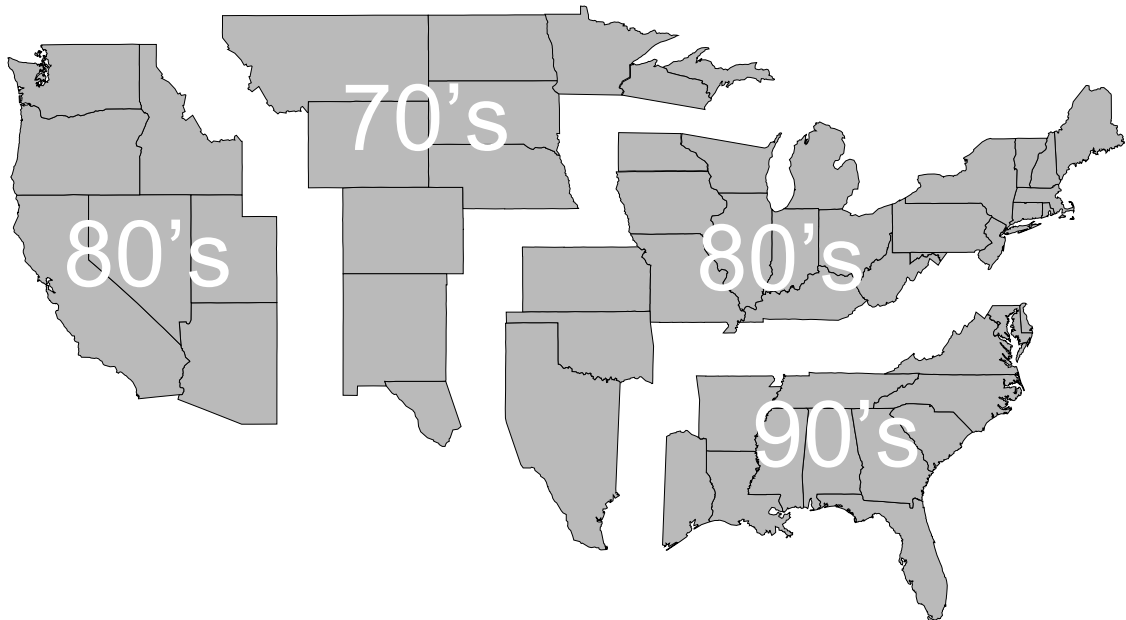

Typical signal strength results. Your actual signal strength may vary.

Check to see if you are receiving the DIRECTV Promotional Channel on Channel 100. If you are receiving that channel, you can now telephone 1-800 DIRECTV to subscribe to DIRECTV Programming®. If you have difficulties receiving a strong signal on one individual satellite, the pointing of the dish antenna will need fine tuning.

Fine Tuning the Pointing of the Dish Antenna

It often takes two people to fine tune the pointing of the dish antenna. One person watches the signal strength indicator on the **INSTALLATION** screen and relays the information to another person who is adjusting the dish antenna. To fine tune the pointing of the dish antenna, you will need to select a satellite on the **Source** pop-up menu. Then select a transponder from that satellite

by using the **XPONDER** popup menu. Once the pointing of the dish antenna has been fine tuned to receive a strong signal from Satellite 101° (A) and Satellite 119° (B), the pointing of the dish antenna at Satellite 110° (C) is automatically correct.

Selecting Transponders

The **XPONDER** pop-up menu will display the signal strength from individual transponders on each of the satellites. A transponder is a group of circuits on the satellite that transmits the satellite channels. There are numerous transponders on each satellite; however, not all of the transponders will be in use. All of the transponders on Satellite A will provide some signal strength indication. But not all the transponders on Satellites B and C may be fully utilized at this time.

To check the signal strength of individual transponders, first select the satellite using the **Source** pop-up menu. Then highlighting the *Xponder* button on the **INSTALLATION** screen and pressing the **SELECT** key on the remote control will display the **XPONDER** pop-up menu. Use the **▲** and **▼** buttons to select different transponders. Observe the signal strengths of the different transponders. Adjust the dish antenna to improve the signal strengths. After fine tuning, highlighting the *Done* button and pressing the **SELECT** key on the remote control will display the **INSTALLATION** screen. Highlighting the *Video* button and pressing the **SELECT** key or pressing the **EXIT** key on the remote control will display the channel last viewed.

Adding Terrestrial Antenna or Cable to Your Satellite Connections

If you connected a terrestrial antenna or local cable TV service to view local analog or digital channels, you need to configure the DST-3000 receiver to receive those broadcasts.

Highlighting the *Local Area* button on the **INSTALLATION** screen and pressing the **SELECT** key on the remote control will display the **LOCAL AREA** screen shown at the right. Using the **▲** and **▼**, highlight either the *Local In 1* button if you connected your terrestrial antenna or cable service to the jack labeled **IN FROM ANT**, or highlight the *Local In 2* button if you connect the jack labeled **SATELLITE IN** and used a Diplexer to combine your terrestrial antenna cable with the cable from the satellite dish antenna. Then press the **SELECT** key on the remote control to display the **Local In** pop-up menu.

On the **Local In** pop-up menu, use the **▲** and **▼** keys to highlight the buttons for the type of antenna or cable you connected to the DST-3000, and then press the **SELECT** key on the remote control.

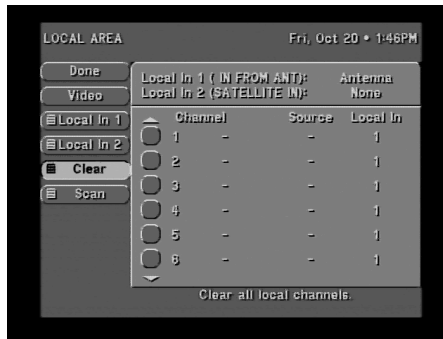

The **LOCAL AREA** screen

Local In Connection Options

The connection options found on the **Local In 1** and **Local In 2** pop-up menus are:

- None** You are not connected to an antenna or cable.
- Antenna** You have connected a standard VHF/UHF indoor or outdoor antenna.
- Cable TV (STD)** You have connected a cable service that uses a standard type of cable signal.

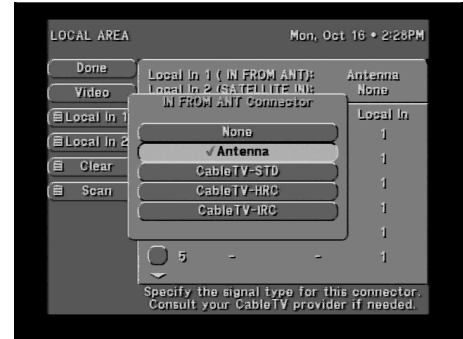

Local In 1 pop-up menu

Cable TV (HRC) You have connected a cable service that uses the HRC type of cable signal.

Cable TV (IRC) You have connected a cable service that uses the IRC type of cable signal.

Note: Consult your cable company to find out what type of cable signal you have.

Note: Local In 1 and Local In 2 must have different input signal types. The receiver does not support the simultaneous connection of two terrestrial antenna or two cable signals.

After selecting your Connector Type and pressing the **SELECT** key on the remote control, the **LOCAL AREA** screen will be displayed.

Scan Channels

This option will automatically scan through all of the possible channels and place the active channel numbers into the Advanced Program Guide™ grid. NTSC (analog) channels will be listed by the Channel Number followed by a hyphen and the number zero. An example of an NTSC channel would be 2-0 for local analog Channel 2. ATSC (digital) channels will be listed by the Channel Number followed by a hyphen and a number other than zero. An example of an ATSC channel would be 23-1. At this time, the program information for local NTSC and ATSC channels that is shown on the Advanced Program Guide™ will simply display “Regular Schedule.” To receive accurate program information for these channels, you need to select a local cable provider or enter area ZIP Code on the **DISH SETUP** screen.

Local Providers

The **LOCAL PROVIDERS** screen allows DIRECTV to add local channels to the Advanced Program Guide™ in the same way that it lists satellite program information.

Highlighting the *Dish Setup* button on the **INSTALLATION** screen and pressing the **SELECT** key on the remote control will display the **DISH SETUP** screen. Using the **▲** and **▼** keys, highlight these Local Provider area options and press the **SELECT** key on the remote control.

Local Provider Area Options

Cable TV (STD) You have connected cable television service. The cable provider entered here will specify what cable program information should appear in the on-screen program guide.

Area 1 You have connected a standard VHF/UHF antenna for receiving your primary analog and digital terrestrial signals. The ZIP Code entered here will specify

what terrestrial program information should appear in the Advanced Program Guide™.

Area 2

Area 2 may be a neighboring city or distant terrestrial station you wish to receive from the same VHF/UHF antenna used in Area 1. The ZIP Code entered here will specify what additional terrestrial program information should appear in the Advanced Program Guide™.

Testing the Strength of the Terrestrial Digital Channels

The **INSTALLATION** screen will also display the signal strengths of the terrestrial digital channels. The screen displays a numerical strength indication and a bar graph accompanied by an audible tone to indicate signal strength. The higher the number, the greater the amount of the bar graph occupied, or the faster the beeping tone, the stronger the signal.

You should test the signal strength of each digital channel by “physical” Channel Number, not by “virtual” Channel Number. The “physical” Channel Number is the channel number that the FCC uses to identify the channel frequency, and it is a one-digit or two-digit number. The “virtual” Channel Number is the number that a local broadcast station wishes to use to identify itself. For instance, if the number for your local CBS analog channel is 2 (Channel 2), then that station may use 2-1 as a digital “virtual” Channel Number, even though the “physical” number assigned by the FCC to that channel is 40.

To test the strength of terrestrial digital channel signals, highlighting the *Source* button on the **INSTALLATION** screen and pressing the **SELECT** key on the remote control will display the **SOURCE** pop-up menu. Using the **▲** and **▼** keys to highlight the *Local Digital* button on the pop-up menu and pressing the **SELECT** key on the remote control will display the **LOCAL DIGITAL** Signal Strength Screen. Use the **▲** and **▼** keys on the remote control to move to the column on the left and use the **▲** and **▼** to highlight the *Channel* button. Press the **SELECT** key on the remote control to display the **CHANNEL** pop-up menu.

If you know the “physical” numbers for your local channels, use the number buttons on the remote control to select each channel number, and observe the signal strength. If you do not know these “physical” channel numbers, use the **▲** and **▼** keys on the remote control to change the channel one number at a time. Channels with a signal strength of less than 60 may require a better antenna, adjustment of the antenna angle, or the antenna may be too far away from the signal source.

After fine-tuning, highlighting the *Done* button and pressing the **SELECT** key on the remote control will display the **INSTALLATION** screen. Highlighting the *Video* button and pressing the **SELECT** key on the remote control will display the channel last viewed. You may also use the *Exit* key on the remote control to exit all menus and return to the last viewed channel.



The INSTALLATION screen

Terrestrial Antenna or Cable without a Satellite Connection

If you connected a terrestrial antenna or local cable TV service to view local analog or digital channels, you need to configure the DST-3000 receiver to receive these broadcasts.

Highlighting the *Local Area* button on the **INSTALLATION** screen and pressing the **SELECT** key on the remote control will display the **LOCAL AREA** screen. Using the **▲** and **▼** keys, highlight either the *Local In 1* button if you connected your terrestrial antenna or cable service to the jack labeled **IN FROM ANT**. Or, highlight the *Local In 2* button if you connected your terrestrial antenna to the jack labeled **SATELLITE IN**. Then press the **SELECT** key on the remote control to display the **Local In** pop-up menu.

On the **Local In** pop-up menu, use the **▲** and **▼** keys to highlight the buttons for the type of connection made to the DST-3000 receiver, and then press the **SELECT** key on the remote control.

Local In Connection Options

The connection options found on the **Local In 1** and **Local In 2** pop-up menus are:

None You are not connected to an antenna or cable.

Antenna You have connected a standard VHF/UHF indoor or outdoor antenna.

Cable TV (STD) You have connected a cable service that uses a standard type of cable signal.

Cable TV (HRC) You have connected a cable service that uses the HRC type of cable signal.

Cable TV (IRC) You have connected a cable service that uses the IRC type of cable signal.

Note: Consult your cable company to find out what type of cable signal you have.

After selecting your **Local In** Type and pressing the **SELECT** key on the remote control, the **LOCAL AREA** screen will be displayed.

Note: Local In 1 and Local In 2 must have different input signal types. The receiver does not support the simultaneous connection of two terrestrial antenna signals or two cable signals.

Selecting the Correct Satellite Dish Type for Terrestrial-only Operation

If you have a terrestrial-only antenna hookup (that is, no satellite dish), you must configure the DST-3000 receiver for a **DISH TYPE** of “None” so it will not search for a satellite signal.

Highlighting the **Dish Setup** button on the **INSTALLATION** screen and pressing the **SELECT** key on the remote control will display the **DISH SETUP** screen.

Highlighting the **Dish Type** button on the **DISH SETUP** screen and pressing the **SELECT** key on the remote control will display the **DISH TYPE** pop-up menu. Using the **▲** and **▼** keys, highlight dish type “None” and press the **SELECT** key.

Scan Channels

This option will automatically scan through all of the possible channel frequencies and place the active channel numbers into the LOCAL AREA channel list. NTSC (analog) channels will be listed by the Channel Number followed by a hyphen and the number zero. An example would be 2-0. At this time, the program information for local NTSC and ATSC digital channels that is shown on the Advanced Program Guide™ will simply display “Regular Schedule.” To receive accurate program information for these channels, you need to select a local provider on the **DISH SETUP** screen.



Channel Scan

Editing Local Channels

To remove or add local NTSC analog and ATSC digital channels in the channel list, use the ▲ and ▼ keys to highlight the specific channel. Press **SELECT** to remove the checkmark and the channel from the channel list. Press **SELECT** again to add it back.

Time Setup

The **TIME SETUP** screen allows you to set your time zone and whether or not you observe daylight savings time. If you have selected a DISH TYPE of “None,” buttons allowing you to set the current date and time will also appear.

Use the ▲ and ▼ buttons to move around the **TIME SETUP** screen, then press **SELECT** to select an item, and you can use your remote control to enter numbers.

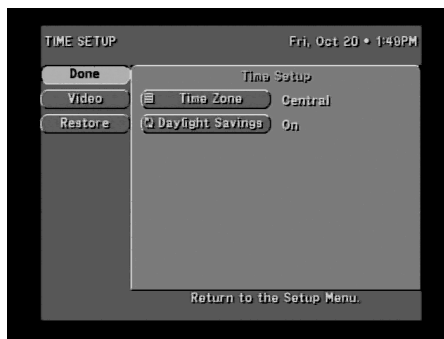

Time Setup screen

Installation Is Now Complete

The installation and testing of the satellite dish antenna and/or terrestrial inputs is now complete. You are ready to enjoy your system.

Watching Local Terrestrial and DIRECTV® Programming



Types of Channels

This chapter will reveal many different ways to find programs you want to watch. The first thing you should know is how channels in the DIRECTV Advanced Program Guide™ are arranged.

DIRECTV® Programming

DIRECTV programming will be listed with network logo and channel numbers 100 to 9999. For example, the DIRECT TICKET movie preview channel is channel 100.

Local Channels from DIRECTV

Local channels from DIRECTV, when available and subscribed to, will be listed as traditional channel numbers along with the network logo or call letters.

Digital (ATSC) Channels with Dish Connection

Digital (ATSC) channels received by a terrestrial antenna or cable service when a dish antenna has been connected will be listed by a single- or double-digit Channel Number followed by a hyphen and a Sub-channel Number of 1 or greater; for examples: 23-1 or 23-2. The main Channel Number can be either the “physical” Channel Number assigned to the broadcast frequency by the FCC or a “virtual” Channel Number assigned by the broadcast station. The type of number, “physical” or “virtual,” depends on information sent by the broadcaster or DIRECTV. The channel call letters or network name may also be included by the broadcaster. The program information area will display the program name and description if this channel is supported for your zip code area.

Analog (NTSC) Channels with Dish Connection

Analog (NTSC) channels received by terrestrial antenna or cable service when a dish antenna has been connected will be listed by their traditional single- or double-digit Channel Number and the station’s call letters or network logo. The program information area will display program name and description if this channel is supported for your zip code area.

Digital (ATSC) Channels without Dish Connection



Digital (ATSC) channels received by a terrestrial antenna or cable service when a dish antenna has not been connected will be listed by a single- or double-digit Channel Number followed by a hyphen and a Sub-channel Number of 1 or greater; for examples: 23-1 or 23-2. The main Channel Number can be either the “physical” Channel Number assigned to the broadcast frequency by the

FCC or a “virtual” Channel Number assigned by the broadcast station. The type of number, “physical” or “virtual,” depends on information sent by the broadcaster. The channel call letters or network name may also be included by the broadcaster. The program information will simply state “Regular Schedule.”

Analog (NTSC) Channels without Dish Connection

Analog (NTSC) channels received by terrestrial antenna or cable service when a dish antenna has not been connected will be listed by the traditional single- or double-digit Channel Number. The program information will simply state “Regular Schedule.”

Basic Channel Changing

There are many ways to “surf” (move from channel to channel) through the available programming. You already know two ways to change channels. The first of these is by using the  and  keys on the remote control. Each key press takes you to the next available channel in the direction that you selected.

The second way is to enter the Channel Number of the desired channel. For example, to go to the DIRECT TICKET movie preview channel, press **100** on the remote control.

*Note: if the channel does not change right away, press the **SELECT** key on the remote control to instruct the HD receiver that you have finished entering channel number digits.*

You can enter the number for any channel that you wish.

*Note: To select a terrestrial ATSC (digital) channel, enter the main channel number followed by the hyphen **-** key, then the Sub-channel Number, and then press the **SELECT** key on the Remote Control.*



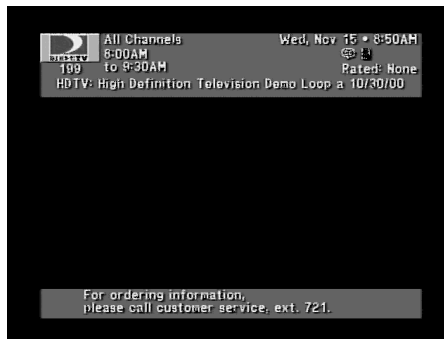

Channel Banner

Every time you select a channel while you are watching TV, a **Channel Banner**, such as that shown to the right, will be displayed at the top of the screen. You can also display the banner by pressing the **INFO** key on the remote control or on the front panel of the receiver. This banner also displays channel-related symbols where applicable. These symbols are shown below.

The following icons may be displayed on the channel banner. Subsequent sections will explain how to access these features.



The CHANNEL BANNER screen

Icon		ALT. AUDIO		NEW MAIL			CAN'T TAPE	
Meaning	Pay Per View	Other audio available	Closed caption available	Unread mail	Limits enforced	Limits override	Taping not allowed	Dolby Digital audio available

The Information Banner

Pressing the **INFO** key on your remote control or the front panel while the **Channel Banner** is displayed will add a description of the current program. This is called the **Information Banner**. Either of these banners will go away after a few seconds, or you can press the **INFO** key for the second time or the **EXIT** key to clear them.



The INFORMATION BANNER

BannerGuide™

If you'd like to know what's on another channel without switching from your current channel, use the **BannerGuide** feature. Simply press **▲** or **▼** to begin browsing. You can see the channel call sign and number, logo, and program title(s). When you see something you like, then press **SELECT** to tune to the channel.

You may also directly enter a channel number to advance the **BannerGuide** feature to that channel. The other filter keys, including **ACTION 1** for movies, **ACTION 2** for sports, and **ACTION 3** for news, as well as the **FAV** key will also control the content of the **BannerGuide** feature.

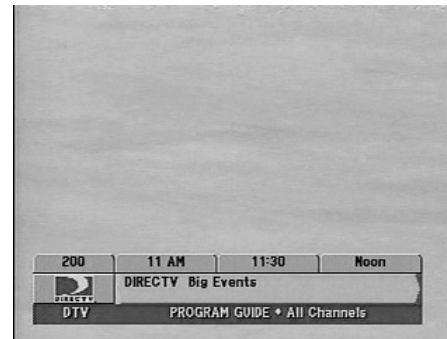

BannerGuide™ feature

Pressing the **EXIT** key will cancel the **BannerGuide** feature.

MyLogos™

The **MyLogos** feature provides access to nine of your preferred channels on top of the current video. The **MyLogos** panel is displayed by pressing the remote control **SELECT** key while watching the video as long as there are no messages prompting you to press **SELECT** for some other purpose. The **MyLogos** feature is also accessible from the front panel **SELECT** key. The **MyLogos** panel displays nine channel tags. These channels can be specified via the **MyLogos** button on the **SETUP MENU**. The header area of the panel displays the title of the highlighted channel tag. You can choose one of the nine by moving the highlight over the desired channel and pressing **SELECT**.



The MyLogos™ popup

*Note: A shortcut to moving the highlight is to press the number on the remote control that corresponds with the on-screen position of the logo for the desired channel. Example, press **SELECT**, then **1** for the upper left channel.*

AlphaJump™

Using the **AlphaJump** feature, you can select a channel by spelling the channel's call sign. To use the **AlphaJump** feature, press the **ACTION** key and the **—** key on the remote control, one after the other. The **ALPHA** symbol will appear on the screen. You can now enter numbers and letters (letters are located above the number keys) to spell a channel's call sign. For example, to tune to ESPN, press the key sequence **ACTION — 2 7 6 5**. All special symbols such as the ampersand (&), forward slash (/), exclamation point (!) are found in the **0** key. As soon as the receiver can determine what channel you are seeking, it will tune to it automatically. No additional keys need to be pressed.

If the channel call sign contains fewer than four letters, you may need to press the **SELECT** key after the letter sequence to indicate that you have entered enough letters. If more than one channel call sign shares the same set of keys (for example, CNN and COM both use 155), one channel will be displayed. If that is not the channel you want, press **ACTION — ACTION —**, one after the other, and the next channel sharing the same set of keys will appear.

With experience, you will become more familiar with the channel name abbreviations that are used.

Alternate Services

The DST-3000 receiver can support alternate audio services. To determine if the services are available for a particular program, look for their icons below the data and time in the **Channel Banner** or on the on-screen guide. To use these services when available, press the **ACTION** key and **Ⓜ** key on the remote control, one after the other. The **Alternate Services** banner, shown at the right, will appear at the bottom of the screen.

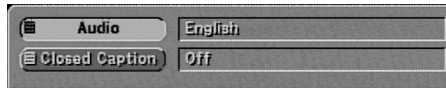

The Alternate Services banner

Audio

Once you have selected the Audio button you can use the **▲** and **▼** keys to step through the audio tracks offered for the current program in different languages.

To choose the highlighted language, press **SELECT**. On occasion an audio track may be offered that is not being broadcast. If this is the case, you will hear either unchanged audio or silence. SAP (Secondary Audio Program) sound is not available on local analog channels received from a terrestrial antenna or cable TV service.

Closed Caption

Closed Caption allows you to change the caption display mode for the program being watched and to turn it on or off. If the closed caption setting in the A/V menu is set to OFF or to a different caption setting, then the selection chosen on this screen is temporary and will be canceled when you change channels. This setting does not affect the closed caption setting of your TV.

Advanced Program Guide™



Program Guide

The most powerful feature of the DST-3000 receiver is the DIRECTV Advanced Program Guide™. You may customize the on-screen guide to list only channels or programs of interest to you. Other advanced features available from the on-screen guides, such as scheduling and program information, will help plan your viewing. Continue reading to learn the real power of the DST-3000 receiver's on-screen guides or Advanced Program Guide™. At any time you can press the **GUIDE** key to display the current on-screen guide.

This DST-3000 receiver offers a variety of on-screen guides. Each guide has its own design to make finding programs of interest an easy task. These guides include the **PROGRAM GUIDE (SM. CELL)**, **PROGRAM GUIDE (LG. CELL)**, and **LOGO GUIDE**.

Each guide can be filtered into smaller channel groupings, as specified in your personalized favorite *Channel Lists*. You can also reduce the displayed listing by specifying a *Theme* of interest, and then narrow the offerings further by specifying a type within the *Theme*. Additional settings, such as *Guide Times* and *Channel List*, may be specified to determine the guide content. A full description of the filtering options can be found later in this chapter.

Note: Most Program Guide features will not be available if the DST-3000 is used without a satellite connection.

PROGRAM GUIDE Screen

Pressing the **GUIDE** button on the remote control will display the **PROGRAM GUIDE** screen shown at the right. The guide is available in three formats: Large Cell, Small Cell, and the Logo Guide.

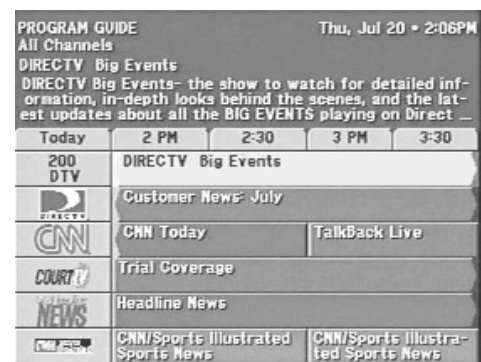

The PROGRAM GUIDE screen

PROGRAM GUIDE Pop-up Menu

Pressing the **GUIDE** key on the remote control a second time will display the **PROGRAM GUIDE** pop-up menu, shown at right. On the left side are the buttons Main Menu, Video, Guide Style, and Guide Sort. On the right side are the buttons Descriptions, Theme Filters, Channel List, Guide Times, and WordFinder™. These buttons are explained in the following sections.

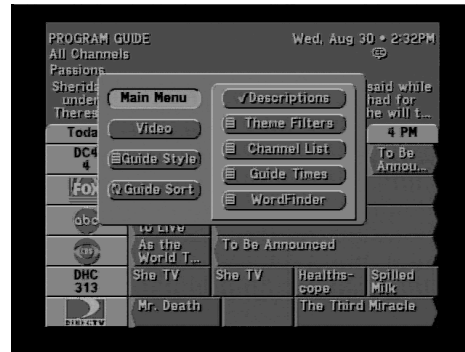

The **PROGRAM GUIDE** pop-up menu

Main Menu

Highlighting the Main Menu button on the pop-up menu and pressing the **SELECT** key on the remote control will display the **MAIN MENU** screen shown and explained on page 7-2.

Video

Highlighting the Video button on the pop-up menu and pressing the **SELECT** key on the remote control will return you to the last program you were viewing.

Choosing the Guide Style

To display the on-screen guides, press the **GUIDE** key. Press the **GUIDE** key again to display or remove the guide pop-up menu.

To choose a guide style, simply highlight the *Guide Style* button and press **SELECT**. A pop-up menu shown at right offering each of the guide styles will be displayed. Highlight your selection and press the **SELECT** key. The guide will be redrawn to display your selection.

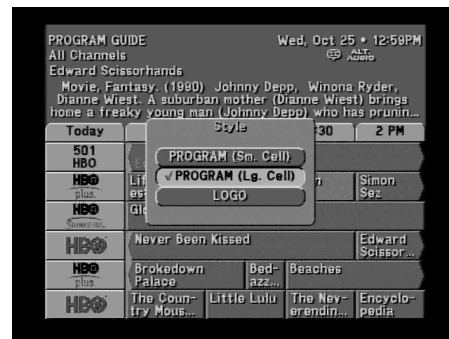

The **GUIDE STYLE** pop-up menu

Familiarize yourself with the benefits of each guide style.

PROGRAM GUIDE (Large Cell)

The **PROGRAM GUIDE (Large Cell)** shown below displays two hours of programming information. Up to eight lines of channel information can be seen on the screen at one time. The number of lines is reduced to six if the program description option is selected.

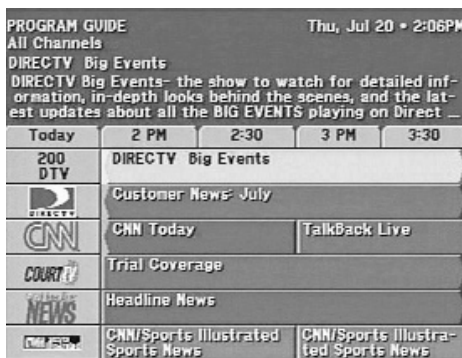

The **LARGE CELL** screen with description

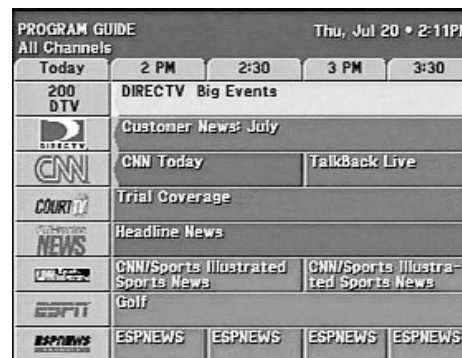

The **LARGE CELL** screen without description



The term “Large Cell” means that there are two lines of text associated with each program title. While this provides more space for the program titles and Channel Tags, it also reduces the number of channels whose information can be seen on the screen at one time.

The largest area of the PROGRAM GUIDE (Large Cell) is made up of cells known as the program grid. Some cells have arrows indicating that the program started at an earlier time, or continues until a later time, than the time displayed on the grid. The length of each grid cell approximates the duration of the associated program.

A time line spanning the width of the guide indicates the show times of the programs being displayed. The list of blocks running down the left-hand side are the “channel tags.” Depending on the Guide Sort (Name or Number) option specified in the **GUIDE** pop-up menu, the tags may display the channel numbers or call signs. This will dictate whether the channels are listed by channel number or alphabetically by call sign.

To navigate the guide, use the ▲, ▼, ◀, and ▶ keys on the remote control. You can continue to press the ▲ or ▼ keys on the remote control to scroll more program information on the screen.

Pressing the  key on the remote control while highlighting any title will display the **INFORMATION** screen.

Use the  and  keys on the remote control to scroll through the guide entries one page at a time.

When the highlight is in the grid, use the ◀ or ▶ keys on the remote control to move the highlight left or right. If you move the highlight on to the Channel Tags in the leftmost column, they will reverse themselves: they will turn from Channel Numbers to Call Signs or from Call Signs to Channel Numbers.

Move the highlight to the right, using the ▶ key on the remote control, to move the grid area to reveal later time periods. Sometimes after scrolling a few hours ahead, there may be a brief delay while more information is received from the satellite.

PROGRAM GUIDE (Small Cell)

The **PROGRAM GUIDE** (Small Cell) screen shown below displays 1-1/2 hours of programming information. Up to 12 lines of channel information can be seen on the screen at one time. This number of lines is reduced to 9 if the program description option is selected.

PROGRAM GUIDE			
All Channels			
Today	2 PM	2:30	3 PM
DTV	DIRECTV Big Events		
201	Customer News: July		
202	CNN Today	TalkBack Li...	
203	Trial Coverage		
204	Headline News		
205	CNN/Sports Illustrated Spor...	CNN/Sports ...	
206	Golf		
207	ESPNEWS	ESPNEWS	ESPNEWS
208	Magic: The ...	WNBA Action	NFL Yearbook
208	Magic: The ...	WNBA Action	NFL Yearbook
210	To Be Announced		
212	This Week ON SPORTS		

*The SMALL CELL screen
without description*

PROGRAM GUIDE			
All Channels			
DIRECTV Big Events			
DIRECTV Big Events- the show to watch for detailed information, in-depth looks behind the scenes, and the latest updates about all the BIG EVENTS playing on Direct ...			
Today	2 PM	2:30	3 PM
DTV	DIRECTV Big Events		
201	Customer News: July		
202	CNN Today	TalkBack Li...	
203	Trial Coverage		
204	Headline News		
205	CNN/Sports Illustrated Spor...	CNN/Sports ...	
206	Golf		
207	ESPNEWS	ESPNEWS	ESPNEWS
208	Magic: The ...	WNBA Action	NFL Yearbook
208	Magic: The ...	WNBA Action	NFL Yearbook

*The SMALL CELL screen
with description*

The term “Small Cell” means that there is only one line of text associated with each program title. While this can cause the title to be cut short, or abbreviated, it also permits information about more channels to be seen on the screen at one time.

A time line spanning the width of the guide indicates the show times of the programs being displayed. The list of blocks running down the left-hand side are the channel tags. Depending on the Guide Sort option (Name or Number) specified in the **GUIDE** pop-up menu, the tags may display the channel numbers or call signs. This will dictate whether the channels are listed by channel number or alphabetically by call sign.

To navigate the guide, use the ▲, ▼, ◀, and ▶ keys on the remote control. You can continue to press the ▲ or ▼ keys on the remote control to scroll more program information on the screen.

Pressing the **INFO** key on the remote control while highlighting any title will display the **INFORMATION** screen.

Use the ⏪ and ⏩ keys on the remote control to scroll through the guide entries one page at a time.

When the highlight is in the grid, use the ◀ or ▶ keys on the remote control to move the highlight left or right. If you move the highlight on to the Channel Tags in the leftmost column, they will reverse themselves: they will turn from Channel Numbers to Call Signs or from Call Signs to Channel Numbers.

Move the highlight to the right, using the ▶ key on the remote control, to move the grid area to reveal later time periods. Sometimes after scrolling a few hours ahead, there may be a brief delay while more information is received from the satellite.

LOGO GUIDE

This guide style offers the greatest number of channel identifiers displayed simultaneously. It displays up to 40 network logos at one time. This number of logos is reduced to 30 if the program description option is selected.

The title of the program currently being broadcast on the highlighted channel appears in the header area immediately above the logo grid. Only information about current programming is available from the LOGO GUIDE.

To navigate the guide, use the ▲, ▼, ◀, and ▶ keys. You can continue to press the ▲ or ▼ keys to scroll through the guide entries a full page at a time.

Pressing **INFO** on any title will direct you to the **INFORMATION** screen. Use the ⏮ and ⏭ keys to scroll through the guide entries a full page at a time.



The LOGO GUIDE without description

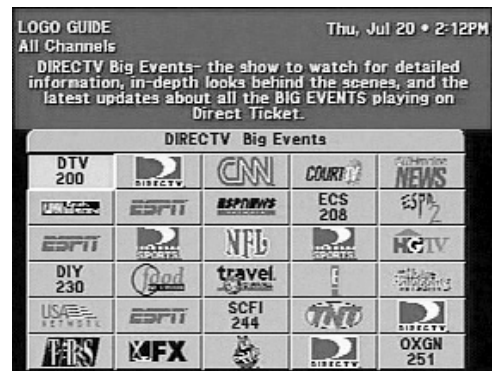

The LOGO GUIDE with description

Descriptions

One guide option is to automatically display descriptions for highlighted program titles. The descriptions usually provide information such as actors' names, a program synopsis, and additional rating information. Sometimes the description may be only a message describing what type of program is highlighted, such as "Current News."

This option is chosen via the *Descriptions* button on the **GUIDE** pop-up menu. Displaying the extra information reduces the number of channels or titles that can be displayed at one time.

Remember that you can always access program descriptions by pressing the **INFO** key whether or not the *Descriptions* button is selected.

General On-Screen Guide Features

While there are different ways the guides can appear, there are some things they have in common.

The guide name will always appear in the upper left corner. It may be something simple like “PROGRAM GUIDE.” If you have filtered the guide, it could be more descriptive such as “COMEDY MOVIES GUIDE.” (See the “Filtering the Guides” subsection later in this chapter.)

- Immediately below the guide title are indicators showing how the guide is further filtered. The label to the left specifies the current class filter setting. To the right you will see the current channel list.
- In the upper right corner of your screen the current day, date, and time are displayed.
- Just below the time you may see small icons indicating the status of the system or details about the currently highlighted program title. They are the same icons that appear in the **Channel Banner**.
- The primary body of the guide screen displays channels or program titles. You can press **SELECT** on a currently airing program to tune to it. Pressing **INFO** will take you to the **INFORMATION** screen described later in this chapter.
- If a program title cannot entirely fit in the space provided, ellipses (...) indicate that a portion of the title is missing.

Using the PrePick™ Feature from the Advanced Program Guide™

Preselecting Programs for Taping

You can utilize this feature commonly known as StarSight® One-Touch Record (OTR). Programs that have been scheduled to be taped will be identified with a videotape icon () before the program title on the on-screen guide. If you do not want to have the PrePicked program recorded, press the **SELECT** key again to change the setting to be automatically tuned to for viewing.



When using the *To Tape* feature the following steps must be completed for the DST-3000 receiver to perform unattended recording:

Note: Only the OUT TO TV or Audio/Video outputs (480i format) of the DST-3000 receiver can be recorded with a standard VHS VCR. You cannot watch the Y, P_r, or P_b outputs (1080i format) video while recording, because the DST-3000 receiver will only output 1080i format or standard 480i format, but not both simultaneously. You must manually switch the DST-3000 to SD (480i format) output mode before recording starts.

- Attach the VCR Control cable. (See Chapter 2, “Setting Up Your Satellite Receiver.”)
- Use the **VCR SETUP** screen. (See Chapter 7, “DST-3000 Receiver’s Menu System.”)
- Switch the DST-3000 to SD (480i) output mode.
- Set your VCR to match the output of the DST-3000 receiver. This could be either RF (channel 3 or 4) or A/V (audio left and right with video or S-video).
- Insert a recordable videotape of sufficient length in the VCR.
- Leave the VCR turned ON.

Using the PrePick™ Feature for Viewing

Programs that are PrePicked for viewing will be identified on the on-screen guide with a check mark (✓) before the program title. An additional press of the **SELECT** key will return the status to not scheduled.

Canceling Scheduled Programs

To cancel a PrePicked program, find the upcoming program you wish to cancel and press the **SELECT** key until the check mark (✓) or videotape icon (📀) is no longer shown.

If the program is currently airing, you will need to delete the event from the **SCHEDULER** screen accessed from the **MAIN MENU**.

Filtering the Guides

Searching through hundreds of channels can be overwhelming. The DST-3000 receiver will help you find what you are looking for. By pressing the **GUIDE** key while already in a guide, a pop-up menu will display, providing the filtering tools and ways to access other guide styles.

By combining each of these filter options, you can quickly narrow down 225+ channels to those that match your viewing interests. Once you exit to view your program, all filters except for the favorite list will reset to an unfiltered condition.

You should also be aware that some guide styles do not provide access to certain filter options. The unavailable filters will not appear in the Guide Menu.

Theme Filters

When the Theme Filters button on the **Program Guide** pop-up menu is highlighted and the **SELECT** button is pressed, a **Theme Filters** pop-up menu, shown on the right, will be displayed listing all of the categories of available programs such as Movies, Sports, Interests, Lifestyles, News, and other categories. You can scroll up or down through this list by using ▲ and ▼ on the remote control.

Activating a category displays a subcategory pop-up menu, which lists the subcategories within the selected category. As one example, within the Movies category are Action/Adventure, Comedy, Current Affairs, Drama, Fantasy, Horror, Music, and Mystery/Crime.

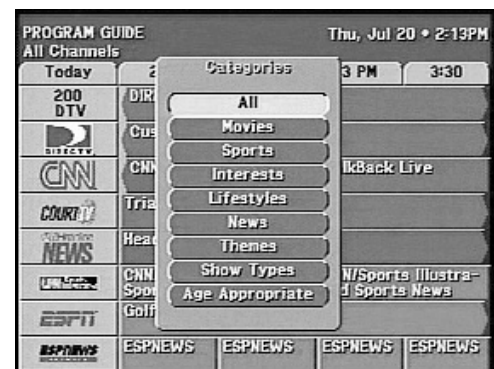

The Theme Filters pop-up menu

Pressing the *All* button clears the choices. Highlighting the Done button and pressing the **SELECT** key on the remote control causes an Exit from the pop-up screen and a return to the **PROGRAM GUIDE** screen.

Popular categories can be quickly selected from your remote control by pressing **ACTION**, followed by a number key. You will see labels on the remote control for filtering the guide to movies, sports, news, and all. Press **ACTION** **1** for movies, **ACTION** **2** for sports, or **ACTION** **3** for news, and the guide will filter accordingly. Pressing the key sequence a second time or pressing **ACTION** **0** will restore the guide to show all themes.

Channel List

The Lists pop-up menu enables you to filter the guide to display only channels from the selected list. In addition to *All Channels*, you can choose one of your own defined lists. See the “Fav. Lists” subsection of Chapter 7, “DST-3000 receiver’s Menu System,” to learn how to set your favorite lists.

The channels selected on the Family List are the only channels available when the HD Receiver has been locked.

You can use the **FAV** key to cycle through the lists at any time in the on-screen guide without using the drop-down menu.

Guide Times

The *Guides* pop-up menu provides easy access to future programming information. Simply select one of the listed times. After a few seconds, the selected guide will appear.

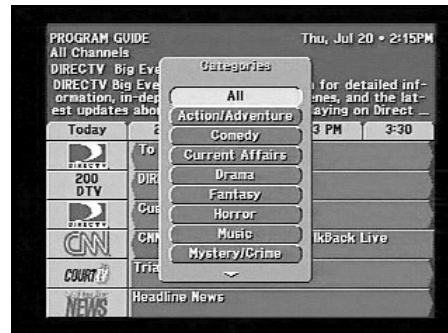

The Movies Subcategory pop-up menu

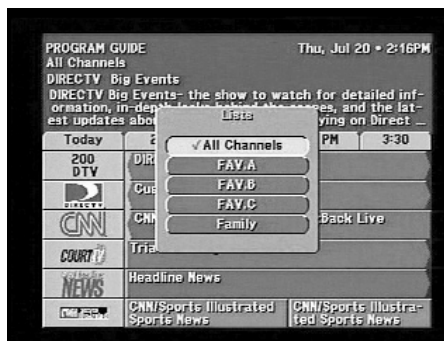

The Lists pop-up menu

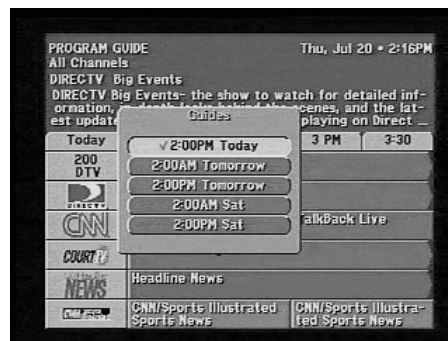

The Guides pop-up menu

The INFORMATION Screen

To obtain more information about a particular program while a **PROGRAM GUIDE** screen is displayed, and you are highlighting a Program on the screen, press the **INFO** button on the remote control to display the **INFORMATION** screen shown here.

If you are highlighting a Channel Tag in the channel column of the **PROGRAM GUIDE** screen, press the **INFO** button on the remote control to display a modified **INFORMATION** screen. Information about the Channel Tag and Call Sign will be displayed.

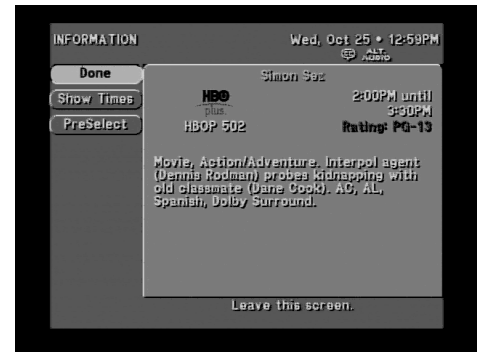

The INFORMATION screen

Done

Highlighting the *Done* button on the screen and pressing the **SELECT** key on the remote control causes an exit from the **INFORMATION** screen and return to the **PROGRAM GUIDE** screen or channel offering a purchase.

Show Times

Highlighting the Show Times button on the **INFORMATION** screen and pressing the **SELECT** key on the remote control will display the **SHOW TIMES** screen, shown here, which displays the upcoming show times for the program selected.

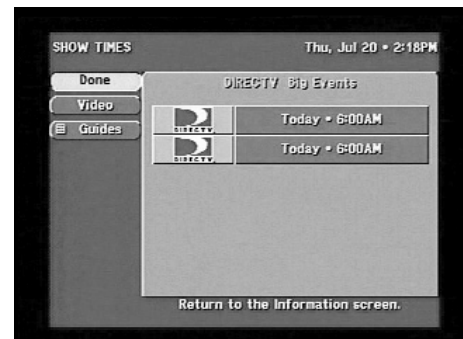

The SHOW TIMES screen

SHOW TIMES Screen

On the right side of the **SHOW TIMES** screen will appear the Program Title of the program highlighted in the **PROGRAM GUIDE** screen. On the left-hand side of this column will appear the Channel Identifiers and Call Signs of the channels offering that show. On the right-hand side of the column will appear a Program Show Date and Time.

On the left are the buttons Done, Video, and Guides explained below.

Done

Highlighting the Done button on the screen and pressing the **SELECT** key on the remote control will cause an exit from the **SHOW TIMES** screen and a return to the **INFORMATION** screen.

Video

Highlighting the Video button on the screen and pressing the **SELECT** key on the remote control will return you to the last program you were viewing.

Guides

Highlighting the Guides button on the **SHOW TIMES** screen and pressing the **SELECT** key on the remote control will initiate a drop-down menu offering easy access to future programming information. Simply select one of the listed times. After a few seconds, the selected guide will appear.

PrePick™

Use the PrePick feature to plan your evening or weekend viewing. The PrePick feature will initiate a drop-down menu offering your PrePick options.

To View

To View will mark the selected program to be automatically tuned in when it airs. At the right time, the DST-3000 receiver will turn on and tune to the appropriate channel. Your selected programs will be identified on the on-screen guide with a check mark (✓) before the program title.

To Tape

To Tape is very similar to *To View*; however, if you have connected your VCR to the DST-3000 receiver via the VCR control cable and have properly set the VCR code from the Setup Menu, the chosen program will be recorded at the correct time. If the DST-3000 receiver turned itself on to record the program, it will also remember to turn itself back off after the program ends. Programs you have scheduled for taping will be identified with a videotape icon () before the program title in the on-screen guide.

Note: Only the PrePick *To View* option appears when the unattended recording capability is not available or when a program is not authorized for taping. In this case, the DST-3000 receiver can still be scheduled to tune to it when it comes on.

Don't PrePick™

Once a program has been scheduled for viewing, previewing, or taping, you have the option of canceling the action. Schedules can also be canceled directly from the on-screen guide by highlighting a scheduled program and pressing the **SELECT** key.

WORDFINDER™

The **WordFinder** popup is used to specify up to eight different words that can be used to identify programming of interest to you. The DST-3000 receiver will search the program titles and descriptions in the guide for programs that contain matching words. These matches will be displayed when you select the **RESTART** button. Some matches will be displayed as soon as they are found and others will be added as the search continues in the background.

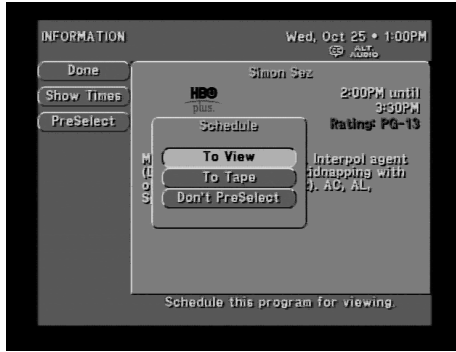

The PreSelect screen



The WordFinder™ feature setup screen

WORDFINDER™ Entry

Highlighting one of the eight choices and pressing **SELECT** will initiate a pop-up keyboard where you can define a search word. If “CAGNEY” and “ALIEN” were specified, the “CAGNEY” search word might find movies in which James Cagney performed, as well as the TV series “Cagney and Lacey.” The “ALIEN” search word might find the movie “Aliens,” as well as any program which includes the word “alien” in the description. Partial words work as well.

Entering the desired words is easy using the pop-up keyboard. You can highlight the desired letter using the ▲, ▼, ◀, and ▶ keys. Press **SELECT** to enter the letter. Once the word is entered, choose *OK*.



The WordFinder™ Entry pop-up menu

DST-3000 Receiver's Menu System



The DST-3000 receiver offers much more than fantastic audio and video. The Main Menu is the primary location where you can access system management functions. From the **MAIN MENU** you can access the on-screen guide, customize system features, read DIRECTV messages, lock and unlock your system, and more.



Most of the menus and screens described in this chapter can be accessed from the front panel. When number entry is requested, the ▲ and ▼ keys will cycle through the possible digits. If the current channel is locked, pressing the **SELECT** key will display the **LOCK OVERRIDE** pop-up screen panel where you may enter your passcode to unlock the channel.

Menu Overview

DST-3000 receiver menus have been designed to provide a logical and convenient way to access system features and settings. The basic screen layout of each menu is divided into several distinct areas. They are as follows:

- Title, date, and time—Across the top of the screen you will see the title of the current menu on the left-hand edge and the date and time on the right-hand edge.
- Advisory messages—Along the bottom of the screen you will see an area that is dedicated to providing a brief explanation of the currently highlighted on-screen button.
- Places to go—Down the left-hand edge of the screen are a variety of buttons. These buttons usually navigate you to different screens. The top two buttons on the list are always *Done* and *Video*. The *Done* button will take you back one level. The *Video* button will return you to the most recently watched channel. This button is provided in case you are using the DST-3000 receiver's front panel and don't have access to the remote control. If the remote control is handy, pressing the **EXIT** key is an easier way to return to your program. The information banner will appear briefly or you can erase it quickly by pressing the **EXIT** key again.
- Things to do—This largest portion of the screen is dedicated to topics associated with the current menu. Contents usually include buttons for changing settings or checking the status of some feature. You will also see information regarding the current menu.

Some buttons contain small icons inside them, indicating their function:

-  The current setting will cycle through the possible settings with each press of the **SELECT** key.
-  A list of options will be offered. This list appears in what is referred to as a "Pop-up Menu."
-  A series of boxes will appear to specify numbers and/or letters for the particular feature.

Main Menu

From the **MAIN MENU** you can access the on-screen guide, customize your system features, check incoming mail, lock and unlock your system, and more.

There are two ways to get to the **MAIN MENU**. First, you can press the **MENU** key on the remote control. Or when one of the on-screen program guides is displayed, you can press the **GUIDE** key to reveal the pop-up **GUIDE MENU**, then select the *Main Menu* button.



The MAIN MENU

Guide

The *Guide* button takes you from the **MAIN MENU** to the on-screen guide. You can use the guide to display what's available at a given time. The guide also offers a pop-up menu of buttons that are useful for filtering the guide or changing the style of the on-screen guide. See Chapter 6, "Advanced Program Guide," for information.

A quicker way to access the on-screen guide from the **MAIN MENU** or any other menu is by pressing the **GUIDE** key, either on the remote control or on the DST-3000 receiver's front panel.

The remaining buttons provide access to those features described in greater detail in this chapter.

Video

Highlighting the *Video* button on the screen and pressing the **SELECT** key on the remote control will return you to the last program you were viewing.

Setup Menu

On the left of the **SETUP MENU** screen are the buttons Done, Video, Preference, A/V Setup, Limits, Chan. Lists (for Channel Lists), MyLogos™, Installation, and VCR Setup, which are explained below.

Done

Highlighting the *Done* button on the screen and pressing the **SELECT** key on the remote control causes an exit from the **SETUP MENU** screen and a return to the **MAIN MENU** screen.

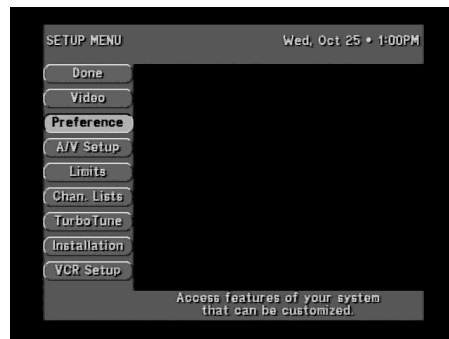

The SETUP MENU

Video

Highlighting the *Video* button on the screen and pressing the **SELECT** key on the remote control will return you to the last program you were viewing.

Preferences

Highlighting the *Preferences* button on the **SETUP MENU** screen and pressing the **SELECT** key on the remote control will display the **PREFERENCES** screen. By changing the various options on the **PREFERENCES** screen and its companion, the **ADVANCED PREFERENCES** screen, you can customize operation of the DST-3000 receiver as many times as you wish.

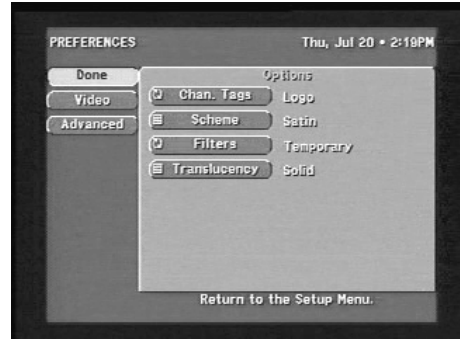

The PREFERENCES screen

Done

Highlighting the *Done* button on the **PREFERENCES** screen and pressing the **SELECT** key on the remote control causes an exit from the **PREFERENCES** screen and a return to the **SETUP MENU** screen.

Video

Highlighting the *Video* button on the screen and pressing the **SELECT** key on the remote control will return you to the last program you were viewing.

Advanced

Highlighting the *Advanced* button on the **PREFERENCES** screen and pressing the **SELECT** key on the remote control will display the **ADVANCED PREFERENCES** screen. This screen contains additional preference options, which are described under “Advanced Preferences” on the next page.

Preference Options

On the right of the **PREFERENCES** screen is a panel of option buttons and current settings that relate to the look of menus and guides. These are Chan. (Channel) Tags, Scheme, Filters, and Translucency.

Channel Tags

With the **Chan. Tags** option, you can select the Channel Tags that are displayed on the **PROGRAM GUIDE** screens. You may select Name/Number Channel Identifiers (numbers or Call Signs such as ABC, for example) or Network Logos.

*Note: If you sort the channels by Name, using the **CH** and **CH** keys will step through the channels in alphabetical order.*

Scheme

The **SCHEME** pop-up menu enables you to select a color scheme for the on-screen guides and menus.

Highlighting the *Scheme* button on the screen and pressing the **SELECT** key on the remote control will display the **SCHEME** pop-up menu to select a color scheme for the guide screens and menus.

Filters

The default setting for *Filters* is “Temporary.” With a setting of “Temporary,” each time you leave the on-screen guide, all filters other than the Channel List will reset “All Categories” and complete class. If you change the *Filters* setting to “Persistent,” any filtering that you should happen to do will survive exiting the on-screen guide and be in effect for the **Banner Guide** and even later when returning to the on-screen guide at a later time.

Translucency

The **TRANSLUCENCY** option allows you to set the degree of translucency in menus and screens that overlay video.

Advanced Preferences

Highlighting the *Advanced* button on the **PREFERENCES** screen and pressing the **SELECT** key on the remote control will display the **ADVANCED PREFERENCES** screen shown at right. This screen contains additional preferences that are less likely to require changes once they are selected. Most users will not make any changes to this screen. This screen also provides a means to reset all preference settings to the factory default settings.

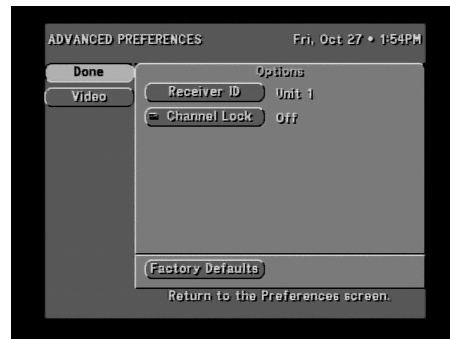

The **ADVANCED PREFERENCES** screen

Done

Highlighting the *Done* button on the screen and pressing the **SELECT** key on the remote control causes an exit from the **ADVANCED PREFERENCES** screen and a return to the **PREFERENCES** screen.

Video

Highlighting the *Video* button on the screen and pressing the **SELECT** key on the remote control will return you to the last program you were viewing.

Advanced Preference Options

On the right of the **ADVANCED PREFERENCES** screen is a panel of option buttons and their related current settings: Receiver ID, Channel Lock, and Factory Defaults, which are explained below.

Receiver ID

Someday, you may choose to get a second DST-3000 receiver. If both receivers are in the same room or if you are using an RF remote control or a remote control extender, you may experience interference between signals. To avoid this “cross talk,” simply highlight the *Receiver ID* button and press **SELECT** on the remote control to be used for that specific DST-3000 receiver. Remember to set your remote control to the desired code first. For information regarding changing the remote control code, see Chapter 8, “Programming Your Remote Control.”

Channel Lock

The *Channel Lock* setting provides a way for you to set your DST-3000 receiver to permanently stay on a specified channel. This feature may be desirable in commercial installations. When the setting is anything other than “- - -” the DST-3000 receiver will always power up on that channel and will ignore any attempts to change the channel. To allow channel changing to function again, set this option to “Off.”

Factory Defaults

To reset the DST-3000 receiver preferences, select the *Factory Defaults* button on the **ADVANCED PREFERENCES** screen.

Audio/Video Setup

Highlighting the A/V Setup button on the **SETUP MENU** screen and pressing the **SELECT** key on the remote control will display the **AUDIO/VIDEO SETUP** screen.

Audio

The AUDIO option on the pop-up menu enables you to specify the language track for programs you watch. While English is the default language, you may choose an alternate language. If your chosen language is available for the program, you will hear that language. Otherwise, you will hear the primary language in which the program was produced.

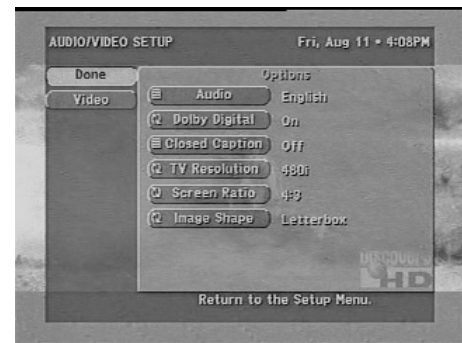

AUDIO/VIDEO SETUP screen

Dolby Digital

The Dolby Digital menu option lets you turn the Dolby Digital output ON or OFF. This setting affects the optical DIGITAL AUDIO OUT port on the back of the DST-3000 receiver. Refer to the subsection “HD Receiver and Dolby Digital Receiver or Decoder” in Chapter 2.

WARNING



Before using the DIGITAL AUDIO OUT connector with a standard PCM (i.e., not Digital Dolby) digital bitstream decoder/receiver, set the Dolby Digital option on the Advanced Preferences screen to “Off.” Failure to do this could result in a high level noise and could be harmful to your ears and equipment.

Closed Caption

The Closed Caption pop-up menu allows you to set the default caption information to be viewed on-screen when tuned to a program that includes captions. When OFF is selected, captions will not be displayed. If CC1 or CC2 is selected, then the DST-3000 receiver will decode and display the appropriate Closed Captioning information, if present.

TV Resolution

The TV Resolution menu option lets you set the output format of the DST-3000 receiver. By default the TV Resolution is set to 1080i for a High Definition (HD) monitor or television. If you have a Standard Definition (SD) monitor or television, you should choose 480i.

Note: The DST-3000 receiver will output HD video through the Component Video (Y, P_r, P_b) connectors or SD video through the OUT TO TV/VIDEO/S-VIDEO connectors, but it will not output both formats simultaneously. Please refer to Chapter 2, "Setting Up Your HD Receiver," for instructions on connecting your type of monitor or television.

Note: All video is converted to the selected output format (1080i or 480i) regardless of the original format. For example, when the 1080i format is selected, all 480i, 480p, and 720p programs are upconverted to 1080i.

Screen Ratio

The Screen Ratio menu option lets you specify the aspect ratio of your monitor or television so that video programming can be properly displayed. Select 4:3 (standard) or 16:9 (widescreen).

Image Shape

If you are using a 4:3 (standard) television or monitor and receiving a 16:9 (widescreen) image, which is wider than the screen, you can choose one of the following display methods:

Full

In Full mode, the 16:9 image is stretched vertically to fill the screen. No image content is lost, but objects will appear taller than normal.

Cropped

In Cropped mode, the 16:9 image is enlarged to fill the screen vertically and centered horizontally. Some image content is lost at the left and right sides of the image.

Letterbox

In Letterbox mode, the 16:9 image fills the screen horizontally and is centered vertically, with gray bars above and below the image. No image content is lost, but the horizontal and vertical resolution is reduced.

Note: If you are using a 4:3 television or monitor and receiving a 4:3 image, the Image Shape setting will have no effect.

Note: The gray bars that occur in Letterbox mode can increase the chance of CRT burn-in. Because of this, it is recommended that you use either the Full or Cropped mode instead.

If you are using a 16:9 (widescreen) television or monitor and receiving a 4:3 (standard) image, which is narrower than the screen, you can choose one of the following display methods:

Full

In Full mode, the 4:3 image is stretched horizontally to fill the screen. No image content is lost, but objects will appear wider than normal.

Cropped

In Cropped mode, the 4:3 image is enlarged to fill the screen horizontally and centered vertically. Some image content is lost at the top and bottom of the image.

Side Panels

In Sidepanels mode, the 4:3 image fills the screen vertically and is centered horizontally, with gray bars on the left and right of the image. No image content is lost, but the horizontal resolution is reduced.

Note: If you are using a 16:9 television or monitor and receiving a 16:9 image, the Image Shape setting will have no effect.

Note: The gray bars that occur in Side Panels mode can increase the chance of CRT burn-in. Because of this, it is recommended that you use either the Full or Cropped mode instead.

Limits

Highlighting the *Limits* button on the **SETUP** screen and pressing the **SELECT** key on the remote control will display the **LIMITS** screen shown. The **LIMITS** screen allows you to set limits on viewing specific types of programming. These limits, when accompanied by the **CHANNEL LISTS**, put TV-watching control in your hands.

Note: The TV Timer, Rating, and Spending Limits are in effect only when the DST-3000 receiver is locked. Locking and unlocking the DST-3000 receiver is explained later in this chapter.

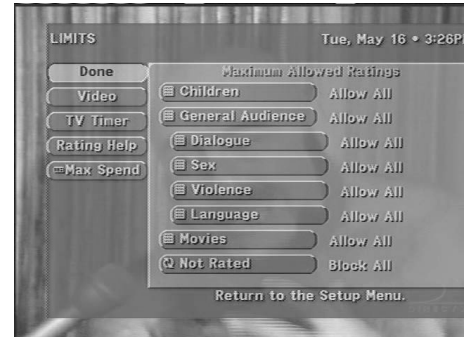

The **LIMITS** screen

On the left of the **LIMITS** screen are buttons for Done, Video, TV Timer, Rating Help, and Max Spending, which are explained below.

Done

Highlighting the *Done* button on the screen and pressing the **SELECT** key on the remote control will cause an exit from the **LIMITS** screen and a return to the **SETUP** screen.

Video

Highlighting the *Video* button on the screen and pressing the **SELECT** key on the remote control will return you to the last program you were viewing.

TV Timer

Highlighting the *TV Timer* button on the **LIMITS** screen and pressing the **SELECT** key on the remote control will display the **TV TIMER** screen.

From the **TV TIMER** screen you can specify the hours that satellite programming can be viewed on your receiver, which is done by highlighting each of the days you wish to control and pressing **SELECT**. After selecting a day of the week, you can set an acceptable start and end viewing period *or* a total viewing duration.



The TV TIMER screen

Rating Help

Program ratings indicate the suitability of a program's content for a given audience. For families with younger children, a lower rating limit may be desirable. Other families may choose to allow viewing of more sophisticated programming.

Highlight the *Rating Help* button and press **SELECT** to display the **RATING HELP** pop-up menu. Use the **▲** and **▼** keys to view information about the age-based rating and content themes listed in the menu. The table below provides more detail about the ratings.

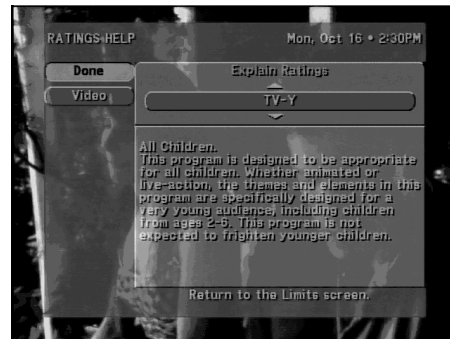

The RATING HELP pop-up panel

Rating	Description
TV-MA	Mature Audience Only. Specifically designed to be viewed by adults and may be unsuitable for children under 17. It contains one or more of the following content themes: crude, indecent language (L), explicit sexual activity (S), or graphic violence (V).
TV-14	Parents Strongly Cautioned. Contains some material that many parents would find unsuitable for children under 14. Parents are strongly urged to exercise greater care in monitoring this program and are cautioned against letting children under the age of 14 watch unattended. This program contains one or more of the following content themes: intensely suggestive dialogue (D), strong, coarse language (L), intense sexual situations (S), or intense violence (V).
TV-PG	Parental Guidance Suggested. Contains material that parents may find unsuitable for younger children. Many parents may want to watch it with their younger children. The program contains one or more of the following content themes: some suggestive dialogue (D), infrequent coarse language (L), some sexual situations (S), or moderate violence (V).
TV-G	General Audience. Most parents would find this program suitable for all ages. It contains little or no sexual dialogue (D), no strong language (L) or sexual situations (S), and little or no violence (V).

Rating	Description
TV-Y7	Designed for children ages seven and above. More appropriate for children who have acquired the developmental skills needed to distinguish between make-believe and reality. Themes and elements in this program may include mild fantasy violence (FV) or comedic violence, or may frighten children under the age of seven.
TV-Y	All Children. Themes and elements in this program are designed for a young audience, including children from ages 2–6. Not expected to frighten younger children.
MPAA	G: General audiences. All ages admitted. PG: Parental guidance suggested. Some material may not be suitable for children. PG-13: Parents strongly cautioned. Some material may be inappropriate for children under 13. R: Restricted. Under 17 requires accompanying parent or adult guardian. NC-17: No one 17 and under admitted.

Max Spending

Pay per view access enables you to purchase special, limited-broadcast programs such as sporting events and movies. You can set the maximum purchase price on a per-event basis. To change the displayed limit, highlight the *Max Spending* button and press **SELECT** to display the **SPENDING LIMIT** pop-up panel.

When the DST-3000 receiver is locked, the passcode will be needed to change the ratings limit. Refer to the subsection “**Lock/Unlock**” later in this chapter for information on setting the passcode.

Use the number keys on the remote control to set the limit or use the ▲ and ▼ keys to increase or decrease each digit. Use the ◀ and ▶ keys to highlight the digit that you want to change. The maximum limit is \$655 per event.

Highlight **OK** and press **SELECT** to confirm the entered amount.

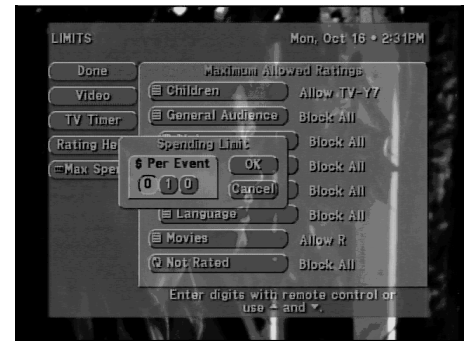

The **MAX SPENDING** pop-up panel

Channel Lists

Highlighting the *Chan. Lists* button on the **SETUP** screen and pressing the **SELECT** key on the remote control displays the **CHANNEL LISTS** screen shown.

Channel Lists are provided to help you organize the hundreds of available channels into groupings that suit the needs of your household. Each list can contain as many or as few channels as you would like. You can customize these groupings in a variety of ways. For example, *Fav. A* could be Dad's favorite channels, *Fav. B* could be Mom's favorites, *Fav. C*



The **CHANNEL LISTS** screen

could be the kids' channels, and *Family* could be all channels that Mom and Dad have deemed appropriate for the entire family. Each of the lists, with the exception of *Family*, can be renamed.

Note: Remember that when the DST-3000 receiver is locked, only channels selected in the *Family* list can be viewed. This means that even though a channel appears on the *Fav. A*, *Fav. B*, *Fav. C*, or *All Channels* list, the selected channel must also be on the *Family* list in order to view it.

Note: For the *Family* list limit to be in force, the DST-3000 receiver must be locked.

On the left of the **CHANNEL LISTS** screen are buttons for Done, Video, AutoSet, Rename, Clear, and Set, which are explained below:

Done

Highlighting the *Done* button on the screen and pressing the **SELECT** key on the remote control causes an exit from the **CHANNEL LISTS** screen and a return to the **SETUP** screen.

Video

Highlighting the *Video* button on the screen and pressing the **SELECT** key on the remote control will return you to the last program you were viewing.

AutoSet

AutoSet is designed to help in the initial programming of your channel lists. When you select the *AutoSet* button, a pop-up menu appears showing each of the channel lists. Highlight and select a channel list to be programmed. Once selected, the AutoSet Progress pop-up status panel appears. It will take several minutes for the DST-3000 receiver to scan through all channels and determine which ones you are authorized to receive. The results of this scan will be stored in the designated channel list.

Note: The *AutoSet* Channel Scanning Process can inadvertently exclude some channels (such as the *MUSIC CHOICE* channels) or include some *Pay Per View* channels. You can manually edit your channel lists after *AutoSet* is done (see "Tag Boxes" below).

Rename

When you highlight the *Rename* button and press the **SELECT** key, a Rename List pop-up menu appears. You can choose any of the first three lists to be renamed. The *All* and *Family* lists cannot be renamed. Once you have selected a list, a Rename List entry keyboard pop-up panel appears. You can highlight the desired letter using the **▲**, **▼**, **◀**, and **▶** keys. Press **SELECT** to enter the letter. When you have finished, choose *OK*.

Clear

You may decide to remove all channels from a particular list later on. Selecting *Clear* will allow you to clear all channels from a chosen list. You may then add channels back in.

Set

If you decide to include all channels in a particular list, selecting *Set* will allow you to specify the list. You may then remove channels from this list, if you so choose (see "Tag Boxes" below).

Tag Boxes

The four columns of small boxes on the right hand side of the **CHANNEL LISTS** screen are the Tag Boxes. The first three columns are the lists traditionally known as *Fav. A*, *Fav. B*, and *Fav. C*. The fourth column is the *Family* list.

In the **CHANNEL LISTS** screen, use the ▲, ▼, ◀, and ▶ keys to highlight the button that corresponds to the channel number and list that you wish to change. Press the **SELECT** key to add or remove the check mark, which indicates that the channel in that row is included in the list shown at the top of the column.

To help you decide whether to include or exclude a certain channel, the title of the currently airing program for that channel will appear at the top of the screen.

Locking is described in the subsection “Lock/Unlock” later in this chapter. When the system is locked, the passcode will be needed to modify the settings of the channel lists.

MyLogos™

Highlighting the *MyLogos* button on the **SETUP** screen and pressing the **SELECT** key on the remote control displays the **MYLOGOS SETUP** screen shown to the right.

On the left are buttons for Done and Video, which are explained below.

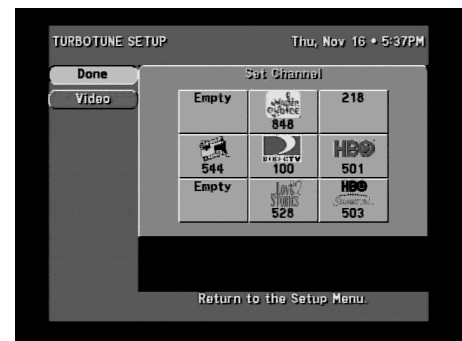

The MyLogos™ setup screen

Done

Highlighting the *Done* button on the screen and pressing the **SELECT** key on the remote control causes an exit from the **MYLOGOS SETUP** screen and a return to the **SETUP** screen.

Video

Highlighting the *Video* button on the screen and pressing the **SELECT** key on the remote control will return you to the last program you were viewing.

The **MYLOGOS SETUP** screen is used to specify which nine channels will appear in the *MyLogos* pop-up panel that displays when **SELECT** is pressed.

Set Channel

Using the ▲, ▼, ◀, and ▶ keys, highlight one of the nine channel boxes. You can enter the desired channel using the number keys on the remote control or by using the **CH** and **CH** keys. Pressing **SELECT** while highlighting one of the channel boxes will also initiate a pop-up panel that will allow you to set the channel using the ▲ and ▼ keys on the remote control or the DST-3000 receiver's front panel.

Installation

Highlighting the *Installation* button on the **SETUP** screen takes you to the **INSTALLATION** screen, which contains utilities to facilitate installation of your satellite dish antenna. You can also evaluate your system's signal strength via the **INSTALLATION** screen. This screen was discussed in detail in Chapter 4, “Setting Up the Satellite Dish Antenna and Terrestrial Inputs.”

VCR Setup

The **VCR SETUP** screen provides access to the settings that will allow the DST-3000 receiver to communicate the record and stop commands to your VCR.

Brand

Using the ▲ and ▼ keys, search through the various brands of VCRs that are supported. Related brands that share the same control codes may be suggested. You may want to experiment with these if you are having difficulty finding a functioning code under your VCR's own brand name.

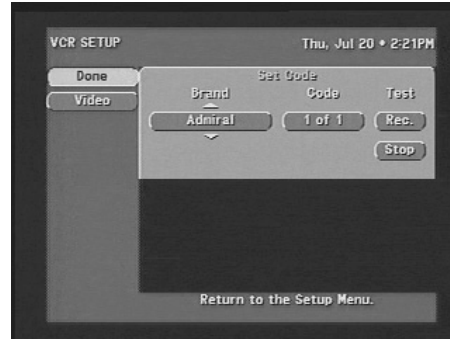

The VCR SETUP screen

Code

More than one code may be assigned to your brand of VCR. Try each of the codes by using the ▲ and ▼ keys to step through each code. Alternate between this procedure and testing the code.

Test (Record/Stop)

The testing function allows you to verify that the specified code will control your VCR. To run the test, the VCR control cable must be properly attached (see “Setting Up Your Satellite Receiver” in Chapter 2), a recordable tape must be in the VCR, and the VCR must be turned on.

Use the buttons on the front panel of the DST-3000 receiver (instead of the remote control) when testing the codes, because signals coming from the remote control at the same time as signals coming from the VCR control cable could give unreliable test results.

Be sure to test both the *Record* and the *Stop* commands, which are necessary for successful taping capability. If either *Record* or *Stop* fails to function, try other codes associated with your VCR brand. If you are unsuccessful in the test process after trying all available codes, recheck your VCR control cable connections and IR emitter placement.

Scheduler

Highlighting the *Scheduler* button on the **MAIN MENU** screen and pressing the **SELECT** key on the remote control will display the **SCHEDULER** screen shown.

On the left are the buttons for Done and Video explained immediately below:

Done

Highlighting the *Done* button on the screen and pressing the **SELECT** key on the remote control causes an exit from the **SCHEDULER** screen and a return to the **MAIN MENU** screen.

Video

Highlighting the *Video* button on the screen and pressing the **SELECT** key on the remote control will return you to the last program you were viewing.

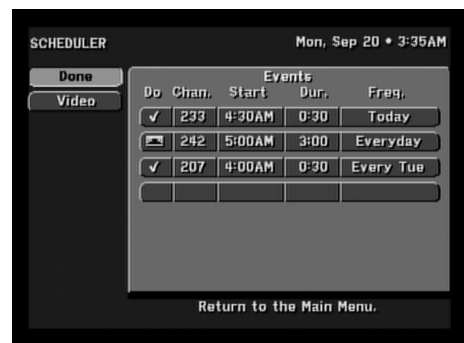

The SCHEDULER screen

Event Scheduling Options

On the right is the **Events** panel, which displays up to seven rows of events. The column headings on this panel are Do, Chan. (Channel), Start, Dur. (Duration), and Freq. (Frequency). The Do column permits two entries: a Check Mark (✓) for Viewing only and a Videotape symbol (📼) for Taping. The Chan. (Channel) column permits an entry of a desired channel. The Start column permits entry of the Start Time, in hours and minutes, of a scheduled event. The Dur. (Duration) column permits entry of the duration, in hours and minutes, of the event. The Freq. (Frequency) column displays when or how often the event occurs: *Today, Tomorrow, Every Mon (Tue and so on), Everyday, Mon–Fri*, or “/” to specify an exact date.

When using the **PrePick™ To Tape** feature, the following steps must be completed for the DST-3000 receiver to perform unattended recording:

- Attach the VCR control cable as described in Chapter 2.
- Use the **VCR SETUP** utility as described earlier in this chapter.
- Switch the HD receiver to SD (480i) output mode.
- Set your VCR to match the output of the DST-3000 receiver, which could be either RF (channel 3 or 4) or A/V (audio left and right with video or S-video).
- Insert a recordable videotape of sufficient length in the VCR.
- Leave the VCR turned ON.

Editing an Event

The “Events” portion of the **SCHEDULER** screen displays up to seven scheduled events at one time. If more than seven events are scheduled, you can use either the ▼ key to scroll down, or the ⏮ key to view the additional events. A small arrow at the top or bottom of the event list indicates that there are additional events.

Use the ▲ and ▼ keys to highlight the event you wish to schedule or edit, then press the **SELECT** key on the remote control. You will be prompted with a pop-up menu. If you choose the scheduling option, the DST-3000 receiver will turn on (if necessary) and tune to the specified channel at the correct date and time. If the *Schedule to Tape* option is provided and is chosen, and you have successfully completed the VCR setup procedure, the DST-3000 receiver will allow recording of the event. To remove a scheduled event, select the *Delete* option. If you inadvertently pressed **SELECT**, select Cancel.

After choosing a scheduling option, a pop-up panel appears for channel selection. You can enter the desired channel using either the number keys on the remote control or the ▲ and ▼ or ⏮ and ⏭ keys.

After specifying a channel, press the **SELECT** key or select *OK* when you are ready to continue.

Next, enter a *Start* time using either the number keys on the remote control or the ▲ and ▼ keys. Press ► to continue.

You then must specify whether the time you entered is AM or PM (or N for noon, or M for midnight if the time specified is 12:00) using the ▲ and ▼ keys. To continue, press ►.

Using the same procedure as setting the start time, set the program *Duration* as hours and minutes. As before, use ► to advance to the *Frequency* column.

The *Frequency* column is very versatile. Using the ▲ and ▼ keys, you can specify when, or how often, the event occurs. Your choices are: *Today, Tomorrow, Every Mon, Every Tue, Every Wed,*

Every Thu, Every Fri, Every Sat, Every Sun, Everyday, Mon–Fri, or “/” to specify an exact date. If you are specifying a date, enter the numbers using the remote control in month/day format. The year will be set automatically. Events can be scheduled up to eleven months in advance. Once you have set the *Frequency*, advance using the ► key.

Review your settings and choose *OK*. Otherwise, choose *Cancel* to delete the edits made to this event.

Check Mail

The CHECK MAIL feature of the DST-3000 receiver enables DIRECTV to notify you about important information, upcoming special events, offers, and other promotional programming.

When new messages are received, a “new mail” icon appears at the top of all menu screens. This indicator will remain on the menus until you have read the new message.

When you highlight the *Check Mail* button on the **MAIN MENU** screen, the advisory message at the bottom of the screen indicates if there are any messages to read. If there are, you can press **SELECT** to access the **CHECK MAIL** screen.

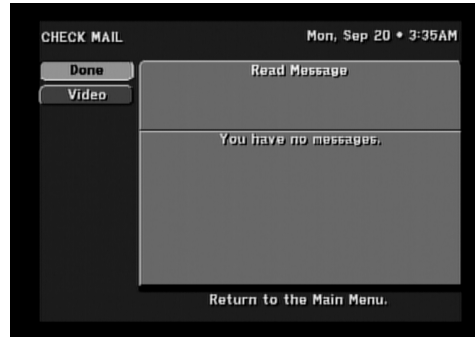

The CHECK MAIL screen

Message

The *Message* button will allow you to cycle through multiple messages if more than one piece of mail is available. Highlight the *Message* button and use the ▲ and ▼ keys to step through the messages.

Page

The *Page* button will allow you to cycle through the pages of a multipage message. Highlight the *Page* button and use the ▲ and ▼ keys to step through the pages.

Erase

The *Erase* button will remove a piece of mail from your mailbox. Please be aware that once a piece of mail has been erased, it cannot be retrieved. Messages will self-erase if they become outdated or if space is needed to hold newer incoming messages.

Purchases

The **PURCHASE** screen displays recently viewed and advance purchase pay per view events. You can choose between Purchase History and Upcoming Purchases by selecting the *History* button or *Upcoming* button located in the Places to Go area of the **PURCHASES** screen.

For each purchase, the event channel, title, start date and time, and cost is listed. If there are more events than can fit on the screen, use the ▼ key or advance a page at a time using **FN** to view them.

Highlighting the *Purchases* button on the **MAIN MENU** screen and pressing the **SELECT** key on the remote control will display the **PURCHASES** screen.

On the left are the buttons for Done, Video, and History, as explained below.

Done

Highlighting the *Done* button on the screen and pressing the **SELECT** key on the remote control causes an exit from the **PURCHASES** screen and a return to the **MAIN MENU** screen.

Video

Highlighting the *Video* button on the **PURCHASES** screen and pressing the **SELECT** key on the remote control will return you to the last program you were viewing.

History

Highlighting the *History* button on the **PURCHASES** screen and pressing the **SELECT** key on the remote control causes the button to change to *Upcoming*, and a banner at the bottom right of the screen displays a partial history of Pay Per View (PPV) purchases (made with your remote control). *Upcoming Purchases* are explained below. Highlighting the *Upcoming* button on the screen and pressing the **SELECT** key on the remote control causes the button to change back to *History*, and a banner at the bottom right of the screen displays a list of future PPV programs that you order with your remote control. Purchase History is explained on page 7-16.

Upcoming Purchases

The *Upcoming Purchases* screen displays PPV events you have purchased but not yet viewed or purchased but never viewed. Events that were ordered by calling DIRECTV will not appear on this list.

You will see the event channel, title, start date and time, and cost for each purchase. There may be more events than can fit on the screen. You can access these by using the ▼ key or  key.

If you would like to cancel an event, highlight that event and press **SELECT**. A pop-up panel will be displayed where you can cancel your purchase. Be aware that cancellation of some events may not be possible.

Buy

The *Buy* feature is used for PPV programming. The price of the event is displayed on the right side of the screen under the program title. To confirm your purchase, highlight the *Buy* button on the screen and press the **SELECT** key on the remote control. If you are not authorized to make the purchase directly from the DST-3000 receiver, you will need to contact DIRECTV for assistance.

Note: An order assistance fee applies to all Pay Per View phone-in orders.

Buy Options

Activating the *Buy* Button will display a pop-up menu screen with three purchase options and prices for: *View*, *Tape*, and *Don't Purchase*.

The *View* price indicates the cost to view the program only. A purchase of this type excludes the possibility of taping the program for later viewing.

The *Tape* price indicates the cost to record the event for later viewing. You can also view the event as it is being shown and recorded.

After choosing either *View* or *Tape*, confirm or cancel the purchase.

If neither purchase option is of interest, highlight the *Don't Purchase* button and press the **SELECT** key on the remote control.

Cancel Purchase

Some events may allow cancellation after they have been purchased, depending upon the event type and whether the event has been viewed. Events that have been purchased but not yet viewed can usually be cancelled. If the *Cancel Purchase* button is displayed, you are allowed to cancel the purchase. If the button is not displayed, then it is likely that a portion of the event has been viewed and the purchase may not be cancelled.

Purchase History

The *Purchase History* displays a list of Pay Per View events that will be or have been charged to you. You will not see events you purchased but later canceled or events you purchased but which the DST-3000 receiver never tuned to. Events that were ordered by directly calling DIRECTV will also not appear on this list. You cannot remove events from this list. Reported events will disappear from this list as the DST-3000 receiver needs space to log more recent purchases.

You will see the event channel, title, start date and time, and cost for each purchase. There may be more events than can fit on the screen. You can access these by using the **▼** key or **⏏** key.

If you need to discuss an event with DIRECTV, highlight the questioned event and press **SELECT**. Additional information will be displayed.

Caller ID

If you have Caller ID (Identification) service from your telephone service provider, an incoming telephone call will display an **Incoming call** from pop-up screen containing the Name and Telephone Number of the caller.

Highlighting the *OK* button on the pop-up screen and pressing the **SELECT** key on the remote control will continue to display this pop-up screen whenever an incoming telephone call arrives. Highlighting the *Disable* button on the pop-up screen and pressing the **SELECT** key on the remote control will prevent the display of the **Incoming call** from pop-up screen whenever an incoming telephone call arrives. Incoming telephone call information will still be retained, however, and displayed on the **Caller ID List** screen.



Caller ID Over video

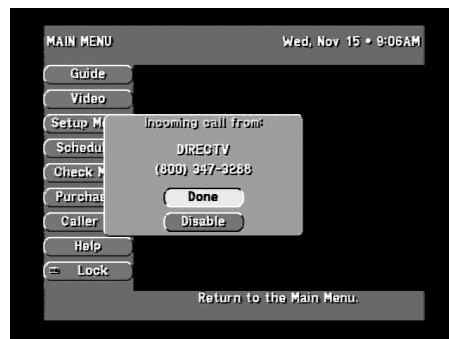

Caller ID Over menu

Call History

Highlighting the *Caller ID* button on the **MAIN MENU** screen and pressing the **SELECT** key on the remote control displays the **Caller ID List** screen.

On the left are the buttons for Done, Video, and Disable, as explained below.

Done

Highlighting the *Done* button on the screen and pressing the **SELECT** key on the remote control causes an exit from the **Caller ID List** screen and a return to the **MAIN MENU** screen.

Video

Highlighting the *Video* button on the screen and pressing the **SELECT** key on the remote control will return you to the last program you were viewing.

Disable

Highlighting the *Disable* button on the screen and pressing the **SELECT** key on the remote control will prevent the display of the **Incoming call** from pop-up screen whenever an incoming telephone call arrives.

Call History

On the right is displayed the Call History, which displays two lines of information for each incoming caller: Today or a date, the Time of the most recent telephone call from that caller, the Number of Telephone Calls from that Caller since the screen was last displayed, and the Telephone Number of the Caller. These lines of information are displayed with the latest telephone call shown first.

Help

The *Help* button takes you to the **ASSISTANCE** screen. It should be your first stop when you need help or have a question. Think of this feature as a quick reference manual.

Lock/Unlock

When you first receive your satellite system, it will be unlocked (that is, no limits or restrictions are in effect). To enforce the limits (spending, ratings, and “Family” favorite list), you must lock the system.

When the button on the **MAIN MENU** reads *Lock*, no lock symbol appears at the top of the menu screen, indicating that the system is unlocked.

NOTE: Once the DST-3000 receiver is locked, only channels selected on the Family list will be accessible. If the Family list does not have channels selected on it, no channels can be viewed without first unlocking the DST-3000 receiver. To avoid this inconvenience, verify the contents of the Family list before locking the DST-3000 receiver. For additional information, refer to “Channel Lists” earlier in this chapter.

Locking Procedure

When the *Lock* button is selected, the **LOCK SYSTEM** pop-up panel is displayed. Use the ▲ and ▼ keys or the remote control number keys to enter a four-digit passcode of your choosing. If you enter the code using the number keys, you will not see the numbers appear on the screen. After entering a four-digit passcode, highlight and select *OK* to proceed. Otherwise, choose *Cancel* to cancel the locking process.

If you continue, you will be asked to confirm the code by entering it again in the same fashion as before. Once again, highlight and select *OK* to proceed. Otherwise, choose *Cancel*.

Once *OK* has been selected, the DST-3000 receiver is locked. You will need your passcode whenever you wish to unlock or override the lock. The on-screen button used to lock your system is now used to unlock your receiver. A lock symbol appears at the top of every menu screen to remind you that the DST-3000 receiver is locked.

Unlocking Procedure

To remove the lock and its restrictions, highlight the *Unlock* button and press the **SELECT** key.

When the **UNLOCK SYSTEM** pop-up panel appears, you can use the ▲ and ▼ keys or the remote control number keys to enter the four-digit passcode that you used to lock the DST-3000 receiver earlier. If you enter the passcode using the number keys, you will not see the numbers appear on the screen.

After entering the passcode, highlight *OK* and press the **SELECT** key on the remote control.

Note: Once the DST-3000 receiver has been unlocked, all limits and restrictions are removed!

Otherwise, choose *Cancel* to keep the lock in effect.

If you forget your four-digit passcode, you must call DIRECTV® at 1-800-DIRECTV for assistance.

Note: When the DST-3000 is used without DIRECTV® services, the password can be cleared from the Service Test screen. The smart card must not be inserted in the DST-3000.



The LOCK pop-up screen

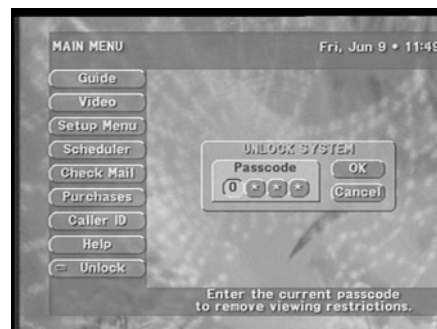

The UNLOCK pop-up panel

Temporarily Overriding the Lock

There are times you may wish to temporarily remove the restrictions imposed by locking. You can do this by temporarily unlocking the DST-3000 receiver.

When you press **SELECT**, the **OVERRIDE LOCK** pop-up will be displayed. It looks and navigates just like the **UNLOCK SYSTEM** pop-up panel.



The OVERRIDE LOCK pop-up panel on menus

Note: Once the correct four-digit passcode is entered, the DST-3000 receiver will remain unlocked until you turn the DST-3000 receiver off. The next time you turn the DST-3000 receiver on, all locks and limits will be enforced again.

The Remote Control

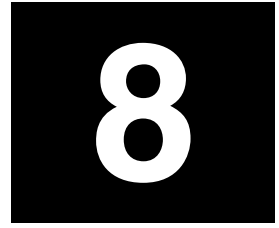

You can use the IR remote control that came with your DST-3000 receiver to control other components in your entertainment system. Your remote control has been pre-programmed to control Toshiba components, but you can easily program it to control other components as described in the section **“Programming the Remote Control”** on page 8-3.

Remote Control Buttons

1	LIGHT	Temporarily lights the keys on the remote control for use in a dark room.
2	POWER	Turns the currently selected device on and off. Press SAT, TV, VCR, or AUX (described below) to select a device.
3	AUX	Puts the remote control in AUX mode to control the programmed auxiliary device (a DVD player, for example).
4	VCR	Puts the remote control in VCR mode to control the programmed VCR.
5	TV	Puts the remote control in TV mode to control the programmed TV.
6	SAT	Puts the remote control in SAT mode to control the DST-3000 receiver.
7	CH	Changes the channel of the current device up or down. When in SAT mode, also functions as a page up or page down key when the DST-3000 receiver displays a list.
8	EXIT	Closes all on-screen displays including program guides, banners, and menus.
9	VOL	Controls the TV's volume, even if a different device mode is currently selected.
10	MENU	When in SAT mode, displays the DST-3000 Main Menu screen.
11	INFO	When in SAT mode, displays additional information about the current program or the highlighted program in a program guide.
12	FAV	When in SAT mode, displays the favorite channel lists.
13	GUIDE	When in SAT mode, displays the DST-3000 receiver's Advanced Program Guide screen.
14	ARROWS	Allow navigation through on-screen menus and program guides. Also, when viewing a program, the up and down arrows access the BannerGuide™ feature.
15	SELECT	Selects the currently highlighted item. When displaying a program guide, accesses the PrePick™ feature. When viewing a program, accesses the MyLogos™ feature.
16	INPUT	When in TV, VCR, or AUX mode, selects the input of the current device. Not used in SAT mode.
17	ACTION	Displays the ACTION icon in the upper left corner of the screen for a few seconds, during which time other keys can be pressed to access special functions.
18	MUTE	Turns off the TV's volume. Press again to restore the volume.
19	PREV CH	Returns to the last channel viewed.
20	STOP/SOURCE, PLAY/PIP, REC, PAUSE/STILL, REW/LOCATE, FF/SWAP	If programmed, operate related features on auxiliary devices such as TVs, VCRs, and DVD players.

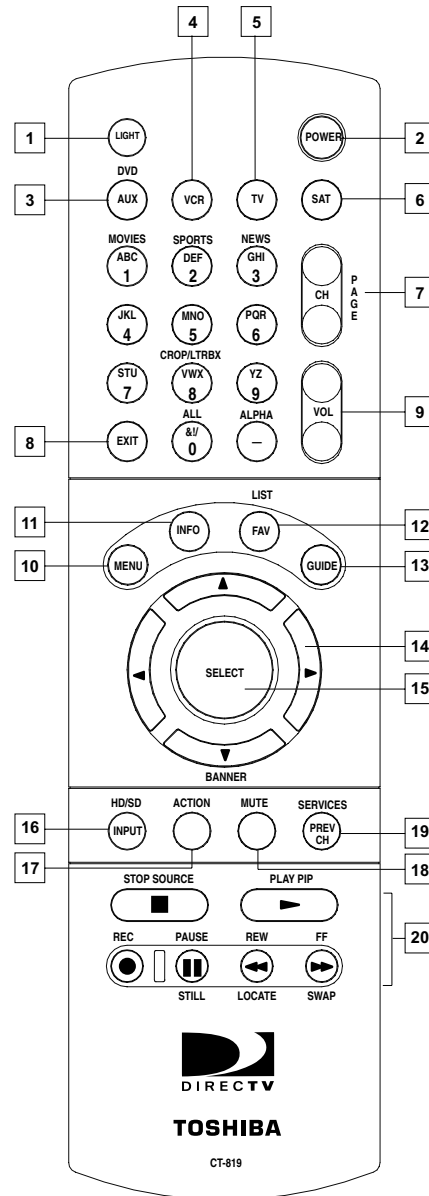

The IR remote control

Keys	Label	Feature
	LIST	Displays the CHANNEL LISTS screen
	SERVICES	Displays the Alternate Services menu
	MOVIES	Filters the on-screen guide to movies only*
	SPORTS	Filters the on-screen guide to sports only*
	NEWS	Filters the on-screen guide to news only*
	ALPHA	Select channel by call sign
	HD/SD	Switches the output of the HD receiver between HD and SD**
	CROP/ LTRBX	Modifies video display viewing format
	ALL	Removes all on-screen guide filters.
<p>* Pressing this sequence a second time will undo the respective filter. ** HD formatted video output (1080i) uses the Y, P_p, and P_b jacks. SD formatted video output (480i) uses the Audio/Video (A/V) and Out to TV jack. Note: The first time you turn your system on, the HD formatted video output is active. You may have to press the key sequence twice to get any picture. A complete explanation of switching from HD to SD can be found in the section “Now You Can Turn It On” on page 14.</p>		

Programming the Remote Control

There are two ways to program your remote control to match your equipment: code scan and code entry. Code scan can take some time, but it avoids having to refer to this manual to program your remote control. Code entry saves some time but you will need to look up the codes assigned to the devices.

Programming Mode

Keep your remote control aimed at the device you want to control during this process. The remote control will send out the “power” command for the device being programmed.

While holding down the device key you are programming (“TV” in this instance), press the MUTE key for one full second. Then release the keys. The device key should light and stay lit. If it doesn’t, repeat the process. If it does, the remote control is now in programming mode.

Then choose either the code scan or code entry method, as described below.

Code Scan

Once you are in programming mode, repeatedly press the key to step through the codes, sending out the power command. This could take some time since there could be many codes for each type of device. When your device shuts off, you have found the code. If you inadvertently go past a code that responded, or realized that you may not have been aiming the remote at the device, you can use the key to step backward through the codes. Press the key to verify that you haven’t missed the code. In order to lock in the code, press the device key again. The remote will remember the code until you reprogram it.

Code Entry

Look for your device type and brand in the following charts. You will find one or more codes that should operate your device. If there is more than one code, try each of them to find the one that controls your device.

Once you are in programming mode (as explained under “Programming Mode” on the previous page), enter the three-digit code. Press the device key being programmed to lock in the code. The remote control will remember the code until you reprogram it.

Test whether the entered code matches your device by pressing the **POWER** key. If the device doesn't respond, repeat the process using the next code for your brand or try the code scan method described under “Code Scan” on the previous page.

TELEVISION	CODE NUMBERS
Admiral	072 081 160 161
A Mark	112 143
Akai	070 146
Amstrad	052
Anam	043 054 056 080 112 131
AOC	070 004 058 112
Audiovox	076 120
Blaupunkt	088
Bruette	572
Candle	070 002 003 004
Capehart	058
Cetronic	043
Citizen	070 002 003 004 043 101 103 143
Classic	043
Concerto	004
Contec	043 050 051
Coronado	143
Craig	043 054 191
Crown	043 143
Curtis Mathes	070 101 143 004
CXC	043
Daewoo	076 103 004 016 043 114 120 127 143 128 136 192 044
Daytron	004 143
Dynasty	043
Dynatech	062
Electrohome	024 076 120 143
Emerson	004 005 028 043 047 048 050 051 076 120 143 151 153 154 155 070 096 191
Fisher	007 057
Funai	028 043
Futuretech	043
GE	160 165 161 070 008 009 034 056 073 074 130 155 167 004 145
Goldstar	004 106 110 112 119 127 143 193
Hall Mark	004
Hitachi	011 004 009 010 012 023 075 143 007 072
Infinity	164
JBL	164
JCPenny	070 004 008 009 030 065 101 160 024 143 156
Jensen	013
JVC	038 001 083 034
KEC	043
Kenwood	070 001
Kloss	002 059

TELEVISION	CODE NUMBERS
KMC	143
KTV	043 143 154 070
Kuehn	722
Lodgenet	072
Logik	072
Lauxman	004
LXI	007 015 052 081 160
Magnavox	164 059 070 003 004 060 061 063 064 022 094 127 160
Marantz	070 164
Matsui	164
Memorex	004 007 072
Metz	088
MGA	024 070 004 024 028 042
Minerva	088
Mitsubishi	024 004 040 042 028 146
MTC	070 004 062 101
NAD	015 025
NEC	070 040 016 056 024 130 134 019 004
Nikei	043
Onking	043
Onwa	043
Optonica	019 081
Panasonic	034 080 056 164
Philco	164 070 003 059 060 064 004 056 063 024
Philips	164 093 038 005 059 127 070 003 004
Pioneer	025 070 004 018 023 190
Portland	004 143 065
Proscan	160 161 167 145 065
Proton	004 058 131 143 171 173
Quasar	034 056 080 164
Radio Shack	004 019 043 127 143
RCA	160 161 156 165 065 070 004 023 024 056 074 152 167 145
Realistic	007 019 043 047
Runco	072 130
Sampo	070 004 058
Samsung	101 004 050 089 105 160 127 143 133
Sanyo	007 020 053 057 082
Scott	004 028 043 048 143
Sears	015 030 028 094 004 007 057 082 143 160 167
Sharp	081 004 014 019 022 028 143 029
Siemens	088

TELEVISION	CODE NUMBERS
Signature	072
Sony	001 085 126 166 079
Soundesign	028 003 004 043
Spectricon	112
SSS	004 043
Supre Macy	002
Sylvania	070 003 059 060 063 064 127 160 164 044
Sylvester	917
Symphonics	194 052
Tandy	081
Tatung	056 062
Technics	034 080
Techwood	004
Teknika	002 003 004 024 028 043 072 101 143
Telerent	072
Tera	173
Tmk	004
Toshiba	015 030 007 040 062 101
Universal	008 009
Video Concepts	146
Vidtech	004
Wards	004 019 064 008 009 028 060 061 063 072 074 143 164 165
Westing House	076 120
Yamaha	070 004
York	004
Yupiteru	043
Zenith	072 073 095 103
Zonda	112

VCR	CODE NUMBER
Aiwa	034
Akai	016 043 046 124 125 142 146
Ampro	072
Anam	031
Audio Dynamics	012 023 039 043
Brooksonic	035 037 044 129 152
Canon	028 031
Capehart	108
Craig	003 040 135
Curtis Mathes	031 041 156
Deawoo	117 119 005 116 007 010 065 108 110 112
Daytron	108
Dimensia	156
DBX	012 023 039 043
Dynatech	034 053
Electrohome	059
Emerson	006 029 035 025 027 034 036 037 046 101 129 131 138 017 031 044 152 157 153
Fisher	003 008 009 010
Funai	034
GE	031 072 144 147 063 151 107 109 156 126
Go Video	040 132 136
Goldstar	101 123 012 013 114
Harman Kardon	012 045
Hitachi	004 026 034 063 137 150 156
Instantreplay	031
JCL	031
JCPenny	012 013 040 101 156 066
Jensen	043
JVC	048 050 043 130 060 012 031 150 055 158
Kenwood	014 034 047 048 023
Lloyd	034
LXI	034 003 009 017
Magin	040
Magnavox	067 031 034 041 068 154 160 064
Marantz	067 069 031 067 012 023
Marta	101
Matsui	027 030
MEI	031
Memorex	102 101 003 010 014 031 034 053 072 139 134
MGA	045 046 059

VCR	CODE NUMBER
Minolta	013 156
Mitsubishi	059 061 046 051 142 013 045 162
MTC	034 040
Multitech	024 034
NEC	012 023 043 048 039
Nordmende	043
Optonica	053 054
Panasonic	070 133 031 066 161
Pentax	013 031 063 156
Philco	031 034 067
Philips	031 067 034 101 054 071
Pilot	101
Pioneer	021 013 048
Portland	108
Quartz	002 014
Quasar	070 133 161 031 066
Radio Shack	123
RCA	107 109 144 147 151 013 041 034 040 156 031 140
Realistic	003 008 010 014 031 034 040 053 054 101
Rico	058 078
Salora	014
Samsung	102 040 032 104 107 109 112 113 115 120 122 125 159
Sansui	043 048 135 022
Sanyo	003 010 102 007 014 134
Scott	017 037 044 129 131 112 159
Sears	003 008 009 010 013 014 017 081 101
Sharp	031 054 053
Shintom	024
Signature	034
Sony	056 057 058 003 052 149 031 155
Soundesign	034
STS	013
Sylvania	031 059 034 067
Symphonic	034
Tandy	010 034
Tatung	039 043 023
Teac	034 039 043 023
Technics	031 070
Teknika	031 019 034 101
TMK	006
Toshiba	112 008 131 047 059 082 013 042
Totevision	040 101
Unitech	040

VCR	CODE NUMBER
Vector	012
Research	
Video	012 046 034 141
Concepts	
Videosonic	040
Wards	003 013 024 031 034 040 053 054 017 131
Yamaha	012 043 034 039
Zenith	072 080 056 048 034 101 058

AUX-AUDIO	CODE NUMBER
Adcom	146 149 227 244
AMC	083 084
Arcam	100
Audio File	093 098
Audio Technica	221
Aiwa	111 114 117 156 170 199 203 219 231 241 254
Akai	181 233
Anam	180
Bose	064 137 219
B & K	150 152
Carver	013 098 107 126 129 160 163 220 245 249
Clarion	151 169
Denon	101 133 191 202 208 246 247
Enlightened Audio	078 153
Fisher	107 129 157 163 176
Fosgate Audionics	228 248
GE	216 123
Harman Kardon	073 195 248 249
Haitai	119
Hitachi	088
JCPenny	109 154 178
Jensen	099
Jerrold	141
JVC	112 198 252
Kenwood	096 104 119 125 148 151 163 171 173 242
Krell	223
Lexicon	215 250
Luxman	066 120 205 229
LXI	123 177
Magnavox	126 162 185 186 224 228
Marantz	074 105 126 128 139 155 162 186 232
McIntosh	251

AUX-AUDIO	CODE NUMBER
Mondial	069 225
MCS	178
Mitsubishi	253
Meridian	013 067
NAD	128
Nakamichi	072 212 234 235
Niles	236
Onkyo	094 115 116 209 211 255
Optimus	121 125 140 181
Panasonic	131 144 187 200
Parasound	085 086 090
Philips	136 186 126 197
Pioneer	093 132 138 210 165 189 195 201 081 230
Quasar	131 187
RCA	109 213 166
Realistic	103 122 123 124 172 174 177 179 180 194
Rotel	204 218 239
Sansui	196 214 126 139 075 197
Sanyo	157 129
Samsung	068
Scott	180 190
Sharp	096 125 151 161 169 182 193
Sherwood	089 127
Sony	097 117 147 183 200 253 237 238 188 192
Soundstream	197
Starcom	141
Symphonic	124
Teac	102 159 180 062
Technics	131 184 187 200 202 208 165
Toshiba	175
Wards	163
Yamaha	092 120 166 240 125 169 216
Zenith	222 061

AUX-LDP	CODE NUMBER
Radio Shack	056
RCA	046
Realistic	049
Runco	058
Sanyo	052
Sharp	060
Sony	050 053
Technics	047 051 054
Toshiba	060
Yamaha	045 059

AUX-DVD	CODE NUMBER
Denon	030
GE	035 036
GLG	041
JVC	031
Magnavox	038 042
Marantz	042
Mitsubishi	032
Onkyo	038
Panasonic	033
Philips	038 042
Pioneer	034
Proscan	035 036
RCA	035 036
Samsung	029 040
Sony	037
Toshiba	038
Yamaha	039
Zenith	028 041

AUX-CATV	CODE NUMBER
Hamlin	015 017 022
Jerrold/G.I.	010 021 025
Oak	008 016 023
Pioneer	007 026 027
Scientific/ Atlanta	002 006 013
Tocom	003
Zenith	004

AUX-LDP	CODE NUMBER
California Audio	047
Denon	043 044
Fisher	047
Kenwood	060
Magnavox	048 057
Mitsubishi	057
NAD	057
Optimus	049
Panasonic	047 051 054
Philips	048
Pioneer	055 057
Quasar	047

Using the Remote Control

Once your device codes are entered, you are ready to start using your universal remote control. The device keys allow you to switch from one device to another. Some keys behave in a special way—they control one device while you are actually in another device mode. For instance, while in SAT (satellite) mode, pressing Volume +/- controls your TV's volume—not the DST-3000 receiver's volume. This is because the remote control knows that there is no volume control on the DST-3000 receiver.

Advanced feature keys (i.e., **ACTION**, **EXIT**) are not supported for devices other than your DST-3000 receiver. For other devices, only the primary keys (**FF**, **TV**, and **POWER**) will function.

For Sony-brand devices, use the **SELECT** key as the “Enter” key.

For RCA-brand devices, the device key (“TV” or “VCR”) may function as the “power on” key and **POWER** the “power off” key.

Switching the Remote Control to Operate Additional DST-3000 Receivers

Your remote control can be reprogrammed to operate additional DST-3000 receivers. This may be necessary in situations where multiple DST-3000 receivers are located in the same general area and can pick up signals intended for one specific receiver.

To switch the remote control, simply press and hold the **SAT** key while entering the receiver ID. The receiver ID can be 001 through 008. Do not forget the two zeros. Remember to access the **ADVANCED PREFERENCES** screen using the keys on the front of the DST-3000 receiver to pair it with the remote control.

The other way to program your remote control to match your DST-3000 receiver is to scan for the correct code.

- 1) Keep your remote control aimed at the device you want to control during this process. The remote control will send out the “power” command for the DST-3000 receiver.
- 2) While holding down the SAT key, press the MUTE key for one full second. Then release the keys. The SAT key should light and stay lit (indicating programming mode). If it doesn't, repeat the process.
- 3) Once you are in programming mode, repeatedly tap the **FF** key to step through the codes, sending out the power command, which could take up to eight presses. When your DST-3000 receiver shuts off, you have found the code.
- 4) Press the **POWER** key to verify that you haven't missed the code. In order to lock in the code, press the SAT key again.

The remote will remember the code until you reprogram it.

Identifying Codes That Have Been Stored

You can identify the codes you stored in your remote control's device keys. These codes can be used when programming additional remote controls.

- 1) While holding down the device key, press the MUTE key. Then release both keys.
- 2) Press the **ACTION** key and count the number of times the red light in the device key blinks. Each digit of the three-digit code is separated by a two-second period the light is off. For example, if the code number is 021, the light will blink 10 times (for “0”), pause two seconds, blink two times (for “2”), pause two seconds, and then blink one time (for “1”).

Controlling Other Components Using the AUX Button

Some additional features are available when the remote control is in the AUX mode.

Volume Control in AUX Mode

When the remote control is in TV, VCR, or SAT mode, the volume keys control the TV's volume. When the remote control is in AUX mode, the volume keys control the auxiliary device's volume. If your auxiliary device does not have audio output, you can program the volume keys to control the TV's volume when your remote control is in AUX mode by performing the following steps:

- 1) While holding down the **AUX** key, press the MUTE key. Then release both keys.
- 2) Press the "Volume Up" key.

Repeat these steps to restore volume control of your auxiliary device in AUX mode.

Assigning a Device to a Different Device Key

You can assign a device to a device key that has a different label. For example, you can assign a second TV to the **AUX** key:

- 1) While holding down the **AUX** key, press the MUTE key. Then release both keys.
- 2) Press the device key associated with the type of device you wish to assign to the **AUX** key. In this example, you would press the TV key.
- 3) Enter the correct code. (To determine the code, use either the code scan or code entry method described earlier.)
- 4) Press the **AUX** key. The new device code is now stored in the **AUX** key, and the **AUX** key now controls the second TV.

Questions and Answers

APPENDIX A

Many people, over time, have questions about their satellite system. We have compiled the most frequently asked questions and their answers in this appendix.

-
- Q** I had a satellite signal but now I am getting a message “Searching for satellite signal. To access related utilities, press **SELECT**.” What happened?
- A** Rain clouds and snow can affect the satellite signal reception. This loss of signal is temporary. Also check for new growth on trees and bushes that could be blocking the signal. One other possibility is that the wind or someone has moved the satellite dish antenna.
-
- Q** Why can't I control my TV?
- A** Before you can control your TV, VCR, or any other device, besides your DST-3000 receiver, you must program your remote control to match your different devices. See the chapter, “Programming Your Remote Control” in this manual for specific instructions. If you have already successfully programmed your remote control, try pressing the appropriate device key to put your remote in the proper mode. Then try controlling that device. Also, make sure that the batteries in the remote control are good.
-
- Q** Some channels look good, while others freeze or indicate that no signal is available. What's wrong?
- A** The most common causes for this behavior relate to an improperly grounded satellite cable. Check the cable between your DST-3000 receiver and the satellite dish antenna. Confirm that RG-6 (not RG-59) cable is used and does not exceed 100 feet in length. Longer cable runs require amplification. This special amplifier is available from your dealer.
-
- Q** How can I watch one satellite program while recording another?
- A** With only one DST-3000 receiver, unfortunately, you can't. Each receiver can only decode one channel at a time.
-
- Q** I'm getting a message to call some extension. Why?
- A** There are many different reasons for this. If you want to watch the channel that is displaying the message, call DIRECTV at 1-800-DIRECTV (1-800-347-3288).

Q Why don't I have an on-screen offer to purchase Pay Per View programs?

A There are four possibilities: 1) Your DST-3000 receiver is not connected to a phone line; 2) Your DST-3000 is connected to a phone line but DIRECTV does not realize that it is; 3) DIRECTV has disabled your ability to make on-screen purchases. Call DIRECTV at 1-800-DIRECTV (1-800-347-3288) for assistance; or 4) The Pay Per View program is not available for purchase.

Q Can I receive my local TV programs through my DST-3000 receiver?

A There are three ways to receive local programming:

- 1) If you are in an area where local programming is available via satellite, contact DIRECTV to arrange for the necessary subscription package.
- 2) Install a traditional antenna (roof mounted, attic mounted, or rabbit ears).

If you should select item 1 above, your local programming will appear in the program guide just as any other channel. For options 2 or 3, connect the cable for the local signal to the **IN FROM ANTENNA** input on the back of your DST-3000 receiver.

Q If I have questions about my satellite system or need to have it serviced, whom should I call?

A For issues regarding your equipment, contact your dealer first. They are the most familiar with your installation and needs. If you would like, visit our web site at www.toshiba.com/tacp, or call the Toshiba Customer Solutions Center at 1-888-867-4377.

If you need assistance with your subscription, such as adding channels, contact DIRECTV at 1-800-DIRECTV (1-800-347-3288).

Q I thought I had set an event to record on my VCR but, when I played the tape back, nothing was there. What could be wrong?

A There are several possible reasons for this. First, check that the VCR was programmed correctly and left turned on and the input matches the output from your DST-3000 receiver (no SD output with HD on). Confirm that you were authorized to tape the chosen program.

Q I picked up my telephone and it was making a hissing and squealing sound. Why?

A Your DST-3000 receiver was reporting any pay per view activity that may have occurred. This happens very infrequently and lasts for only a minute or so.

Q What if my question isn't listed here?

A Visit our website at www.toshiba.com/tacp for more Frequently Asked Questions, or call the Toshiba Customer Solutions Center at 1-888-867-4377.

Specifications

Signal Sources	NTSC analog terrestrial ATSC digital terrestrial DIRECTV satellite
Terrestrial Channel Coverage	VHF: 2 through 13 UHF: 14 through 69 Cable TV: 2 through 125
Power Source	120 V AC, 60 Hz
Power Consumption	51 W (average)
Video/Audio Terminals	ColorStream™ (COMPONENT VIDEO) OUTPUT Y: 1 V(p-p), 75 ohm PB: 0.7 V(p-p), 75 ohm PR: 0.7 V(p-p), 75 ohm S-VIDEO OUTPUT Y: 1 V(p-p), 75 ohm, negative sync. C: 0.286 V(p-p) (burst signal), 75 ohm VIDEO/AUDIO OUTPUT (x2) VIDEO: 1 V(p-p), 75 ohm, negative sync. AUDIO: 150 mV(rms) (47 kohm) DIGITAL AUDIO OPTICAL OUTPUT
Dimensions	Width : 13.125 inches Height : 2.75 inches Depth : 10.88 inches
Weight	5 lbs
Supplied Accessories	Access card (located behind the door on your DST-3000 receiver) IR (infrared) remote control with 2 AA batteries Owner's Manual 6-foot coaxial RF cable 6-foot VCR control cable 25-foot Telephone cable 8-foot 5-conductor component audio/video cable

Design and specifications are subject to change without notice.

LIMITED WARRANTY

TOSHIBA DST-3000 HIGH DEFINITION DIGITAL RECEIVER

Toshiba America Consumer Products, Inc. ("TACP") and Toshiba Hawaii Inc. ("THI") make the following limited warranty. This limited warranty extends to the original consumer purchaser, or any person receiving this product as a gift from the original consumer purchaser, and to no other purchaser or transferee. This limited warranty applies only to products purchased and operated in the USA.

LIMITED WARRANTY - ONE (1) YEAR PARTS AND LABOR

WHAT IS COVERED

Any defect in materials or workmanship. This warranty applies only to the Toshiba DST-3000 High Definition Digital Receiver and the included remote control unit.

WHAT TACP OR THI WILL DO

Within one year from the date of original retail purchase:

Repair the defective DST-3000 Receiver, remote control unit, or parts; or exchange the receiver or remote control unit with a new or (at TACP/THI's option) refurbished receiver or remote control unit. Labor costs for the removal and re-installation of any equipment are your responsibility.

Your responsibility:

1. You must retain your bill of sale or provide other proof of purchase.
2. All warranty servicing of the product must be made by a TACP/THI Authorized Service Station.
3. These warranties are effective only if the product is purchased and operated in the U.S.A.

WHAT YOUR WARRANTY DOES NOT COVER

- Any High Definition Digital Receiver accessory not included with the DST-3000 Receiver.
- Original or subsequent installation.
- Damage caused by acts of God, including but not limited to lightning or power surge damage.
- Adjustment of customer controls, including but not limited to installation, alignment, or repair of a satellite dish or terrestrial antenna.
- Damage from misuse, accident, neglect, improper installation, installation or use in violation of instructions provided by TACP/THI or applicable building codes, or improper maintenance.
- Units or parts which have been lost or discarded by you.
- A unit that has been modified or incorporated into other products, or is used for institutional, rental, or commercial purposes.
- Batteries for remote control hand units.
- Units purchased, serviced, or operated outside the United States of America.
- Loss of programming.
- Shipping damage if the unit was not packaged in the manner prescribed by TACP.
- Warranty is void if the model and/or serial number tag is missing, altered, defaced, or otherwise rendered illegible.

You should read the DST-3000 Receiver Owner's Manual thoroughly before using this product.

How you get service:

- Have the unit's proof of purchase, model number, and serial number ready, and call 1-888-867-4377. The model and serial number information is on the back panel of the DST-3000 Receiver.
- A Customer Service Representative will help you troubleshoot the problem over the telephone.
- If our Customer Service Representative determines that the Toshiba High Definition Digital Receiver, or the remote control unit, is the cause of your problem, you will be provided with a Return Authorization (RA) number, and instructions on returning the defective unit for repair or replacement. No returns will be accepted without an RA number.
- If our Customer Service Representative determines that your terrestrial antenna, satellite dish, or access card is defective, you will be advised of appropriate corrective measures.
- If our Customer Service Representative determines that the installation is the cause of your problem, you will be referred to your system installer for installation service. Installation service is your responsibility.
- Removal and re-installation of any and all equipment are your responsibility.
- If you have questions concerning your DIRECTV billing or programming, please call DIRECTV at 1-800-347-3288.

How state law relates to your warranty:

ALL WARRANTIES IMPLIED BY STATE LAW, INCLUDING THE IMPLIED WARRANTIES OF MERCHANTABILITY AND FITNESS FOR A PARTICULAR PURPOSE, ARE EXPRESSLY LIMITED TO THE DURATION OF THE LIMITED WARRANTIES SET FORTH ABOVE. WITH THE EXCEPTION OF ANY WARRANTIES IMPLIED BY STATE LAW AS HEREBY LIMITED, THE FOREGOING EXPRESS WARRANTIES ARE EXCLUSIVE AND IN LIEU OF ALL OTHER WARRANTIES, GUARANTEES, AGREEMENTS AND SIMILAR OBLIGATIONS OF MANUFACTURER OR SELLER WITH RESPECT TO THE REPAIR OR REPLACEMENT OF ANY PRODUCT OR PARTS. IN NO EVENT SHALL TACP OR THI BE LIABLE FOR CONSEQUENTIAL OR INCIDENTAL DAMAGES.

NO PERSON, AGENT, DISTRIBUTOR, DEALER OR COMPANY IS AUTHORIZED TO CHANGE, MODIFY OR EXTEND THE TERMS OF THESE WARRANTIES IN ANY MANNER WHATSOEVER. THE TIME WITHIN WHICH AN ACTION MUST BE COMMENCED TO ENFORCE ANY OBLIGATION OF TACP OR THI ARISING UNDER THE WARRANTY OR UNDER ANY STATUTE, OR LAW OF THE UNITED STATES OR ANY STATE THEREOF, IS HEREBY LIMITED TO ONE (1) YEAR FROM THE DATE YOU DISCOVER OR SHOULD HAVE DISCOVERED, THE DEFECT.

SOME STATES DO NOT ALLOW LIMITATION ON HOW LONG AN IMPLIED WARRANTY LASTS, WHEN AN ACTION MAY BE BROUGHT, OR THE EXCLUSION OR LIMITATION OF INCIDENTAL OR CONSEQUENTIAL DAMAGES, SO THE ABOVE PROVISIONS MAY NOT APPLY TO YOU. THIS WARRANTY GIVES YOU SPECIFIC LEGAL RIGHTS AND YOU MAY ALSO HAVE OTHER RIGHTS, WHICH MAY VARY FROM STATE TO STATE.

QUESTIONS AND COMMENTS ?

Please visit our web site at www.toshiba.com/tacp

Part No: 1029565-0001 Rev. A

