

DIRECTV™ Receiver with UltimateTV® Service from Microsoft® Digital Satellite Receiver/Recorder

Installation Guide

Before you begin using your DIRECTV Receiver with UltimateTV service:

- Make sure your Satellite Dish Antenna is properly installed.
- Follow the steps in "Connecting Your DIRECTV Receiver" on pages 7-12.
- Activate DIRECTV® programming and UltimateTV by calling: 1-800-DIRECTV (347-3288)



SAT-W60

WARNING

To prevent fire or shock hazard, do not expose the Satellite Receiver to rain or moisture.

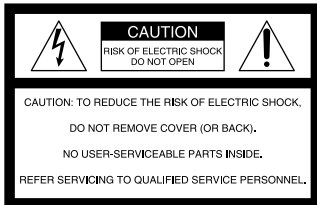

This symbol is intended to alert the user to the presence of uninsulated "dangerous voltage" within the product's enclosure that may be of sufficient magnitude to constitute a risk of electric shock to persons.



This symbol is intended to alert the user to the presence of important operating and maintenance (servicing) instructions in the literature accompanying the appliance.

Note to the CATV Installer

This reminder is provided to call the CATV system installer's attention to Article 820-40 of the NEC (National Electrical Code) that provides guidelines for proper grounding and, in particular, specifies that the cable ground shall be connected to the grounding system of the building as close to the point of cable entry as practical.



To prevent electric shock, do not use this polarized plug with an extension cord, receptacle, or other outlet unless the blades can be fully inserted to prevent blade exposure.



Any changes or modifications not expressly approved in these Operating Instructions could void your authority to operate this equipment.

Owner's Record

The model and serial numbers are located on the bottom of the Satellite Receiver. Record the serial number in the space provided below. Refer to these numbers whenever you call upon Sony Customer Service regarding this product. (see page 29 for the Sony Customer Service number)

Model No. **SAT-W60**

Serial No. _____

Access Card No. _____

Trademarks

Sony is a trademark of Sony. Microsoft, UltimateTV, the UltimateTV Logo, WebTV, and the WebTV logo are either registered trademarks or trademarks of Microsoft Corporation in the United States and/or other countries. DIRECTV and the Cyclone Design logo are trademarks of DIRECTV, Inc., a unit of Hughes Electronics Corp., and are used with permission. Manufactured under license from Dolby Laboratories. "Dolby" and the double-D symbol are trademarks of Dolby Laboratories. Confidential Unpublished Works.

© 1992-1997 Dolby Laboratories Inc. All rights reserved.

Other company or product names mentioned herein may be trademarks of their respective owners.

Notice

Your Satellite Receiver provides access to the Internet and the World Wide Web. Information on the Internet and World Wide Web is created by millions of individuals and organizations. This is what gives the Internet its diversity and value. However, some information may include material which you find objectionable. Sony is not responsible for the content of material accessed through your Satellite Receiver.

The Satellite Receiver, like other Internet devices, does not support all data formats.

SONY SOFTWARE LICENSE AGREEMENT

ATTENTION: USE OF THE SOFTWARE IS SUBJECT TO THE SONY SOFTWARE LICENSE TERMS SET FORTH BELOW. USING THE SOFTWARE OR THE PRODUCT IN WHICH IT IS INCORPORATED INDICATES USER'S ACCEPTANCE OF THESE LICENSE TERMS. IF THE USER DOES NOT ACCEPT THESE LICENSE TERMS, THE USER MAY IMMEDIATELY RETURN THE ENTIRE PRODUCT IN ITS ORIGINAL PACKING FOR A FULL REFUND OF THE PURCHASE PRICE.

License and Restrictions

Sony Electronics Inc. ("Sony") grants User a license to Use one copy of the software which is provided to you as part of this Sony product ("Software"). "Use" means storing, loading, installing, executing or displaying the Software. User may not copy, modify the Software or disable any licensing or control features of the Software. No portion of the Software may be reproduced in any form, or by any means, without prior written permission from Sony. User is not permitted to modify, distribute, publish, transmit or create derivative works of any Software included for any public or commercial purposes. In consideration of this authorization, User agrees that any copy of this Software which User makes shall retain all copyright and other proprietary notices in the same form and manner as on the original. Except as specified above, nothing contained herein shall be construed as conferring by implication, estoppel or otherwise any license or right under any patent, trademark or copyright of Sony, its affiliates or any third party licensor. User may not in any way sell, lease, rent, license, sublicense or otherwise distribute the Software. The Software may only be accessed by the functionality of the Sony product in which the Software is incorporated by Sony (the "Product(s)"), and a User shall not intentionally make the Software directly accessible to others or to hardware other than the Products, or otherwise expose an API. Nothing in this Agreement grants User any rights, license or interest with respect to source code of the Software. User shall not modify, translate, reverse engineer, decompile or disassemble the Software or any part thereof or otherwise attempt to derive source code or create derivative works therefrom, and shall not authorize any third party to do any of the foregoing unless Sony's prior written consent is

obtained. Sony may elect to provide to User updates and other support services for the licensed Software. All updates provided to User shall constitute licensed Software under this License, and such updates shall be governed by the terms hereof.

Intellectual Property

The Software is owned and copyrighted by Sony, its affiliates or its third party licensors. User's license confers no title or ownership in the Software and is not a sale of any rights in the Software. Sony's affiliates and/or third party suppliers may protect their rights directly in the event of any User's violation of this Agreement. The trademarks, tradenames, Product designation, logos and service marks ("Marks") displayed with this Software are the property of Sony, its affiliates or third party licensors, and User shall acquire no rights of any kind in or to any Mark under which the Software and/or Products are marketed. User is not permitted to use these Marks without the prior written consent of Sony, its affiliates or the applicable third party licensor which may own the Mark. "Sony" is a registered trademark of Sony Corporation. User agrees not to remove, alter or destroy any patent, trademark or copyright markings or notices placed upon or contained within the Software, User Manuals or documentation. User further agrees to insert and maintain with the Software and any documentation a copyright notice in User's name.

Termination

User's license will automatically terminate upon any transfer of the Product. Upon transfer, User must deliver the Software, including any copies and related documentation, to the transferee. The transferee must accept these License Terms as a condition to the transfer. Otherwise, Sony does not authorize the transfer and the User and transferee will be in violation of this Agreement should the transferee use the Product. This license will automatically terminate upon User's failure to comply with any of these License Terms. Upon termination, User must stop using the Product and immediately destroy the Software, together with all copies, adaptations and merged portions in any form and/or return it to Sony.

Export Requirements and U.S. Government Restricted Rights

User may not export or re-export the Software or any copy or adaptation in violation of any applicable laws or regulations. The Software and documentation have been developed entirely at private expense and are provided as "Commercial Computer Software - Restricted Rights" in accordance with FAR 52.227-19 (1987) or limited rights in technical data in accordance with FAR 52.227-14 (1987). User has only those rights provided for such Software and documentation by the applicable FAR or DFARS clause or this Sony Software License Agreement.

Limited Warranty

Sony warrants to User that the Software will not fail to execute its programming instructions due to defects in material and workmanship for a period equal to the warranty period provided for the Product when properly installed and used. Warranty does not apply to defects resulting from (a) improper or inadequate maintenance, (b) software, interfacing, parts or supplies not supplied by Sony, (c) unauthorized modification of the Software or the Product, or (d) improper site preparation or maintenance. If Sony receives notice of a covered defect(s) during the warranty period, Sony will replace Software that does not execute its programming instructions due to such defect(s). Sony does not warrant that the operation of the Software and/or Product will be uninterrupted or error free. If Sony is unable, within a reasonable time, to repair or replace any Software to a condition as warranted, User shall be entitled to a refund of the purchase price upon prompt return of the Product.

EXCEPT AS SPECIFICALLY STATED ABOVE, THE SOFTWARE IS PROVIDED "AS IS" WITHOUT WARRANTY AND SONY, ITS AFFILIATES AND ITS THIRD PARTY LICENSORS DISCLAIM ANY IMPLIED WARRANTY OF NONINFRINGEMENT, MERCHANTABILITY OR FITNESS FOR A PARTICULAR PURPOSE. THE REMEDIES IN THIS WARRANTY STATEMENT ARE USER'S SOLE AND EXCLUSIVE REMEDIES. EXCEPT AS INDICATED ABOVE, IN NO EVENT WILL SONY, ITS AFFILIATES OR ANY OF ITS THIRD PARTY LICENSORS BE LIABLE FOR LOSS OF DATA OR FOR DIRECT, INDIRECT, SPECIAL, INCIDENTAL, CONSEQUENTIAL (INCLUDING LOST PROFIT), EXEMPLARY, OR OTHER DAMAGE, WHETHER BASED IN CONTRACT, TORT, OR OTHERWISE, EVEN IF SUCH PARTY HAS BEEN ADVISED OF THE

POSSIBILITY OF SUCH DAMAGES. IN NO EVENT WILL SONY OR ANY OF ITS AFFILIATES OR THIRD PARTY LICENSORS' LIABILITY UNDER AGREEMENT, WHETHER IN CONTRACT, TORT OR OTHERWISE, EXCEED THE COST OF THE PRODUCT.

General

This Agreement shall be deemed to have been made and executed in the State of California and both parties agree that any dispute arising hereunder related to this Agreement or the Product will be governed by laws of the State of California, exclusive of its conflicts of law principles and that the courts in the County of San Diego, California will have exclusive jurisdiction over all such disputes. FURTHER THE PARTIES HEREBY WAIVE TRIAL BY JURY IN CONNECTION WITH ANY ACTION OR SUIT ARISING UNDER THIS AGREEMENT OR OTHERWISE ARISING FROM THE RELATIONSHIP BETWEEN THE PARTIES HERETO. This Agreement shall be binding upon the parties' authorized successor and assignees. Neither party's waiver of any breach or failure to enforce any of the provisions of this Agreement at any time shall in any way affect, limit or waive such party's right thereafter to enforce and compel strict compliance with every other provision. No modification of this Agreement shall be effective unless in writing signed by both parties.

Contents

Connecting Your Satellite Receiver	7
Package Contents.....	7
Cables and Jacks.....	8
Connection Overview.....	9
Step 1: Connecting the Antenna	10
Step 2: Connecting Your Phone Line	10
Step 3: Connecting Your TV Set.....	11
Step 4: Connecting the AC Power	12
Step 5: Checking the Access Card	12
Step 6: Activating Your Service	12
Making Advanced Connections	13
Advanced Connection: Connecting Your VCR.....	13
Advanced Connection: Connecting Your IR Blaster	14
Advanced Connection: Connecting an Audio System.....	15
Advanced Connection: Connecting a Microphone.....	15
Advanced Connection: Connecting a Printer	16
Advanced Connection: Connecting a Camcorder.....	16
Using Your Remote Control	17
Batteries for the Remote Control	17
Selecting Items.....	18
Setting up the Remote Control.....	21
Manufacturer Codes.....	22
Other Information.....	23
Front Panel Controls & Terminals.....	23
Back Panel Terminals	24
Specifications.....	25
Troubleshooting	26
Limited Warranty	28
FCC Regulations and Information.....	30

Connecting Your Satellite Receiver

Package Contents

Make sure you have received all of the following items in your Satellite Receiver package.

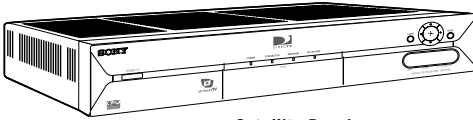

Satellite Receiver

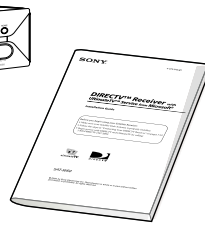

Satellite Receiver Manual

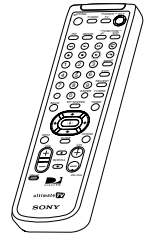

Remote Control



Telephone Cable



S-Video Cable

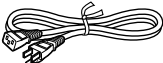

AC Power Cord

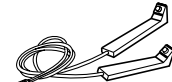

IR Blaster



Telephone Cable
T Splitter



Size AA
Batteries (2)

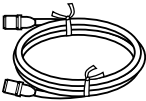

Coaxial Cable



A/V (Audio/Video)
Cable

Boxed separately

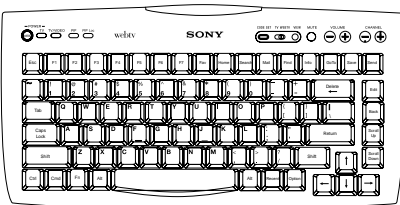

Keyboard
(For keyboard instructions, please
refer to the keyboard manual)



Size AA
Batteries (2)



Keyboard Manual



If you are missing any of these items, contact your Sony dealer.

Below is a description of the jacks and cables you can use to make connections. Note that not all cables come with your Satellite Receiver.

VHF/UHF Jacks and Coaxial (RF) Cable



Use the VHF/UHF IN jacks to receive signals from a TV antenna or from a cable TV connection. You can also use the VHF(SAT)/UHF OUT jack to send audio and video signals to your TV.

SATELLITE IN Jacks and RG-6 Coaxial cable



Use the SATELLITE IN jacks to receive signals from your Satellite Dish Antenna with RG-6 coaxial cable.

Audio/Video Jacks and Audio/Video Cables (RCA-type)



Use the audio/video jacks to send good quality analog video and stereo audio signals.

S-VIDEO Jack and S-VIDEO Cables



Use the S-VIDEO jack to send excellent quality analog video signal.

DIGITAL AUDIO OUT (OPTICAL) Jack and Optical Cable



Use the DIGITAL AUDIO OUT (OPTICAL) jack to send excellent quality audio signal.

TEL LINE Jack and RJ-11 Telephone Cable



Use the TEL LINE jack to connect to a telephone outlet. If you subscribe to DIRECTV programming, some services require a continuously connected telephone line. The telephone line connection is used to periodically call out to DIRECTV and to use for connection to the UltimateTV service. (connection is needed for DIRECTV and UltimateTV service)

IR Blaster Jack and Controller



Use the IR jack to connect your Infrared Controller to your Satellite Receiver. This allows you to control your VCR and/or Cable Box through your Satellite Receiver.

MIC (Microphone) Jack



Use the MIC jack to connect to an external microphone. This allows you to record and send voice messages on the Web in e-mail notes.

Connection Overview

Follow the procedures or make the connections in each of the steps to connect your Satellite Receiver.

Step 1: Connecting the Antenna

Page 10



Step 2: Connecting the Telephone Line

Page 10



Step 3: Connecting Your TV

Page 11



Step 4: Connecting the AC Power

Page 12



Step 5: Checking the Access Card

Page 12



Step 6: Activating Your Service

Page 12

Step 1: Connecting the Antenna

Satellite Receiver

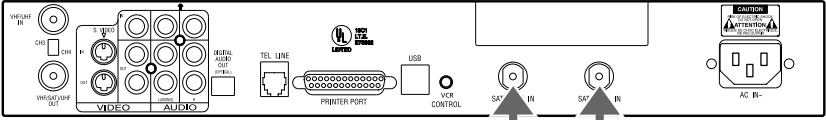

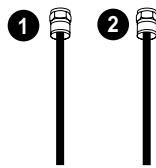

- 1 Connect the SATELLITE IN jack to your Satellite Dish Antenna using RG-6 coaxial cable.
- 2 Connect the 2nd signal if you have Dual LNB. Advance Set Up for dual output.

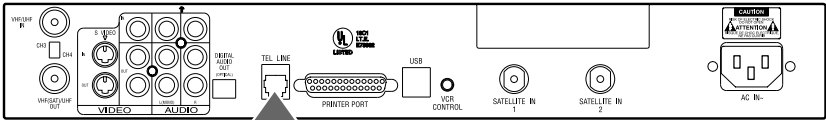

Step 2: Connecting Your Phone Line

Satellite Receiver



- 1  Connect the TELEPHONE LINE jack to a telephone line wall jack using the supplied telephone cord.

Step 3: Connecting Your TV Set

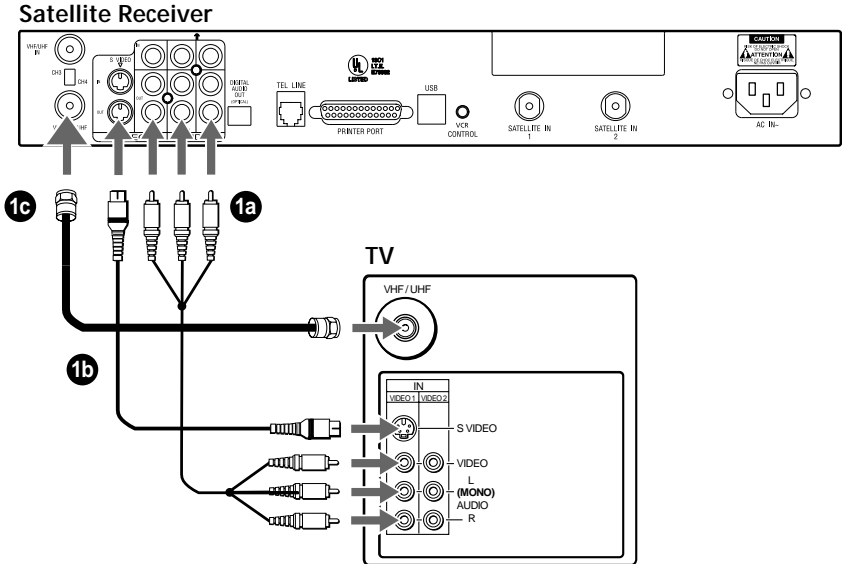

- 1a** If your TV has A/V input jacks
Connect the VIDEO OUT jacks on your Satellite Receiver to the A/V input jacks on your TV using the supplied A/V cable. (Be sure to match the colors on the jacks with the colored plugs on the A/V cable.) If your TV has only one audio input, connect it to the L(MONO) jack on the Satellite Receiver.
- 1b** If your TV has an S-Video input
Use an S-Video cable instead of the yellow video connection. S-Video cable is supplied.
- 1c** If your TV does not have A/V jacks
Connect the VHF/UHF OUT jack to the VHF/UHF input jack on your TV using coaxial cable. Set the CH3/CH4 switch to the channel that does not carry off-air broadcasts in your area.

Note

With this connection, your input source is channel 3 or channel 4 depending on how you set the CH3/CH4 switch on the Satellite Receiver.

Step 4: Connecting the AC Power

Satellite Receiver

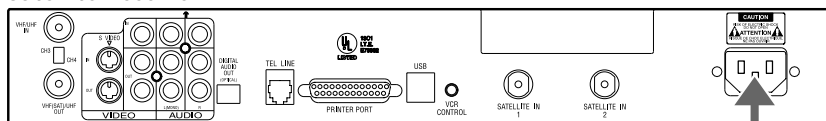

- 1 After all other connections are complete, connect the AC Power Cord to the Satellite Receiver. Then connect the AC Power Cord to a power outlet.

AC Power Cord

to power outlet

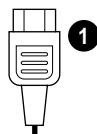

Step 5: Checking the Access Card

Satellite Receiver

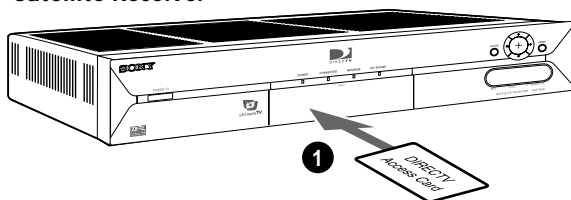

- 1 Open the access door by applying gentle pressure to the latch and releasing. Make sure the DIRECTV Access Card is firmly inserted into the front left hand slot of the Satellite Receiver. After the DIRECTV Access Card is inserted (correctly), **DO NOT** remove it unless instructed to do so by your service provider.

Step 6: Activating Your Service

After checking to see that the DIRECTV Access Card and your Satellite Dish Antenna is installed, you are ready to begin enjoying service.

Call DIRECTV at 1-800-DIRECTV (347-3288) to begin your service.

For DIRECTV and UltimateTV operational instructions, please refer to the User Guide.

Advanced Connection: Connecting Your VCR

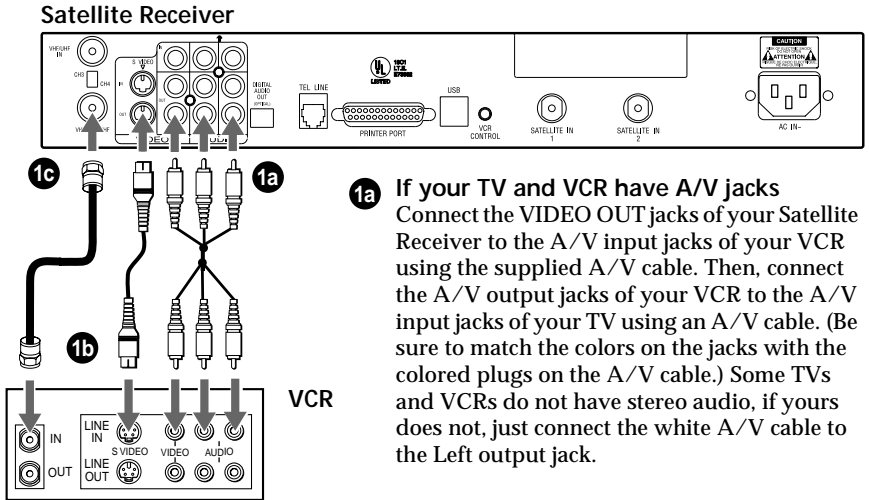

1b If your TV and VCR have S-Video jacks

Use an S-Video cable instead of the yellow video connection. S-Video cable is supplied.



Tip

To allow your Satellite Receiver to control the recording functions of your VCR, see page 14.

1c If your TV and VCR do not have A/V jacks

Connect the VHF(SAT)/UHF OUT jack on the Satellite Receiver to the VHF/UHF input jack on your VCR using coaxial cable.

Then, connect the VHF/UHF output jack on your VCR to the VHF/UHF input jack on your TV using a second coaxial cable.

Set the CH3/CH4 switch to the channel that does not carry off-air broadcasts in your area.

Note

With this connection, your input source is channel 3 or channel 4 depending on how you set the CH3/CH4 switch on your VCR.

Advanced Connection: Connecting Your IR Blaster

Satellite Receiver

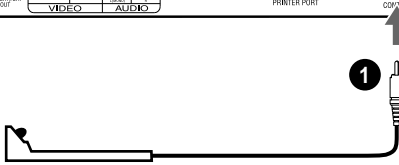
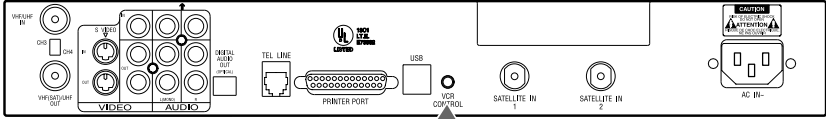

1 To allow the Satellite Receiver to control your VCR Connect the IR Blaster to the VCR CONTROL jack on the Satellite Receiver.

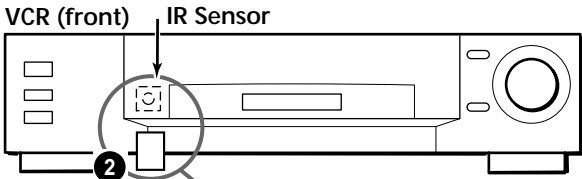

2 In front of the VCR Place the IR Blaster under and in front of the VCR. The IR Blaster must extend just in front of the infrared sensor of the VCR.

Tip

If the infrared sensor is not marked on your VCR, shine a flashlight into the front panel of the VCR to locate the sensor.

Advanced Connection: Connecting an Audio System

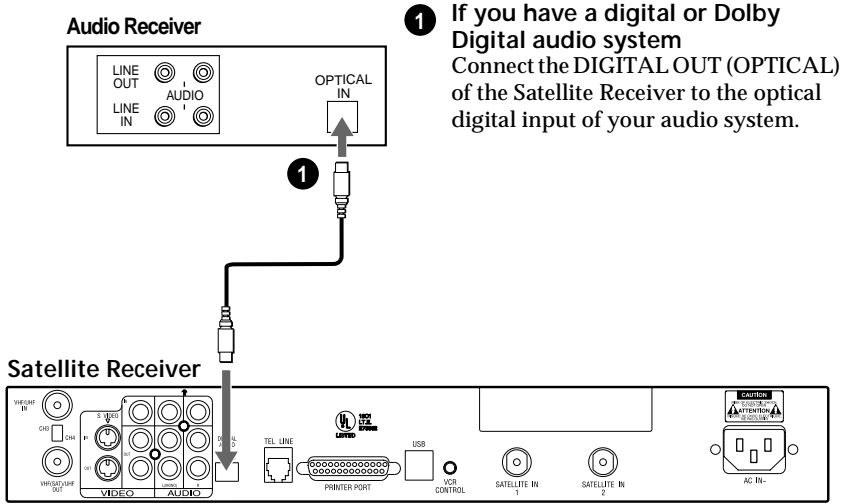

Tip

If you connect your Satellite Receiver to a Dolby Digital receiver, set the Dolby Digital option of the Audio display to Auto Select.

Advanced Connection: Connecting a Microphone

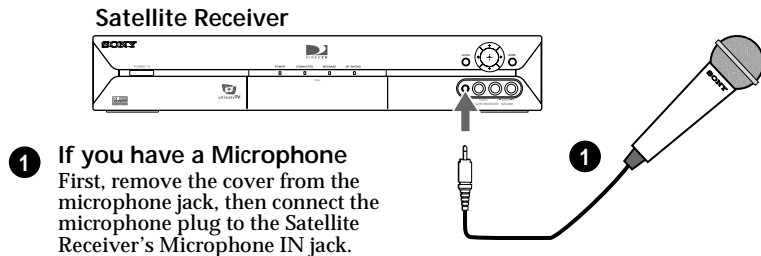

Tip

Check "Help" screen for a list of compatible microphones.

Advanced Connection: Connecting a Printer

Connecting a printer to your Satellite Receiver enables you to print Web pages and e-mail messages. The Satellite Receiver is not compatible with all printers. Check the on-line instructions for a list of the latest compatible printers.

Satellite Receiver

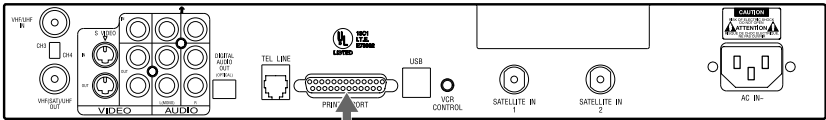

To print screens

Connect the printer port on the Satellite Receiver to the port on the printer.

Note

Unplug the Satellite Receiver and printer before you begin connecting.

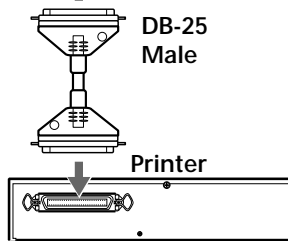

Advanced Connection: Connecting a Camcorder

Satellite Receiver

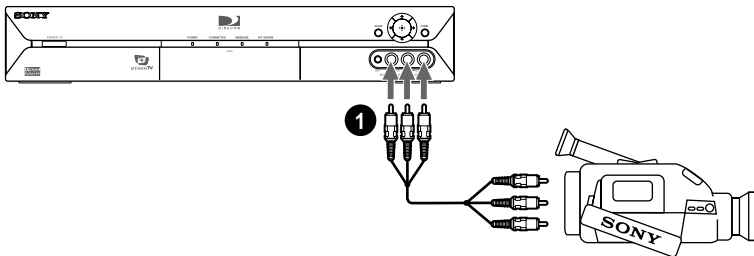

1 If you have a Camcorder

First, remove the cover from the A/V jacks, then, using A/V cables, connect the camcorder's A/V OUT jacks to the Satellite Receiver's A/V IN jacks.

Note

If you have a mono camcorder, connect its left audio output to the Satellite Receiver's AUDIO L (white) jack.

Using the Remote Control and Basic Functions

Although the Satellite Receiver's remote control is preset to operate Sony brand TVs, you can program the remote control to operate other manufacturer's TVs. This will enable you to operate your TV when viewing regular broadcast TV using the remote control.

Batteries for the Remote Control

Insert two size AA batteries (supplied) into the remote control as shown.

Be sure to match the + and - marks on the batteries with the + and - marks inside the battery compartment.

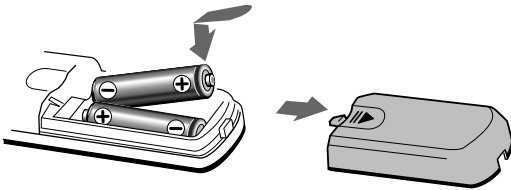

If the remote control is not working properly, the batteries may be worn out. When replacing batteries, replace both batteries. Do not mix different brands and types of batteries. After you replace batteries, you may need to reprogram the remote control.

Selecting Items

In on-screen displays such as the TV Home Screen and program guide, you must first move the highlight to the item you want, then select the item.

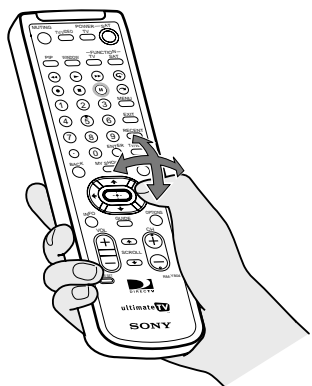

1 Press the $\uparrow/\downarrow/\leftarrow/\rightarrow$ buttons to move the highlight to the item you want.

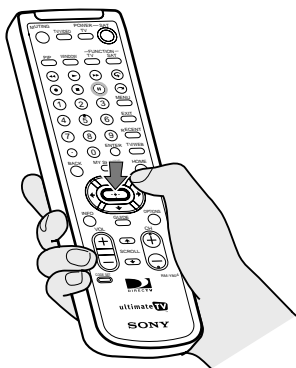







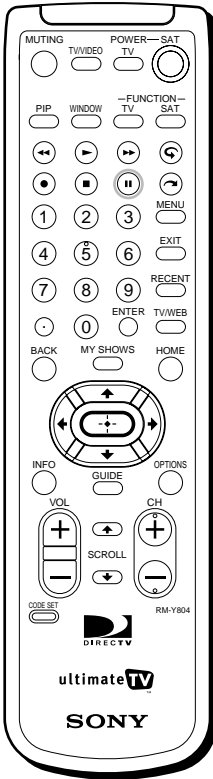

2 Press the \rightarrow button to select the item.

Tip

Be sure to always press the SAT FUNCTION button before operating the Satellite Receiver with the remote control.



Muting	Press to mute the sound. Press again, or press VOL +, to restore the sound. (For the TV only)
TV/VIDEO	Cycles through the video inputs of your TV.
TV POWER	Turns your TV on and off.
SAT POWER	Turns your Satellite Receiver on and off.
PIP	Turns the Picture-in-Picture features of the Satellite Receiver on and off.
WINDOW	Selects the active window while in PIP mode, allowing you to change the Main or PIP window. (For the Satellite Receiver only)
TV FUNCTION	Selects TV feature control.
SAT FUNCTION	Selects Satellite Receiver feature control.
 Button	Review button.
 Button	Play button.
 Button	Forward scan button.
 Button	Record button.
 Button	Stop button.
 Button	Pause button.
 Button	Replay button.
 Button	Jump ahead button.
0 – 9 Buttons	Select channels or enter numbers in text boxes.
 Button	Adds period to separate major/minor channel numbers.
MENU	Opens the TV Main Menu.
EXIT	Closes all on-screen displays, including program guides and menus.
ENTER	Activates the selected channel on your TV.

OPTIONS	Displays the OPTIONS panel.
RECENT	Displays and allows you to access the most recently viewed Web pages or the last TV channel.
SCROLL ▲/▼ Buttons	Moves the page up or down when the page is too long to be displayed on the screen.
HOME	Displays the Web Home or TV Home screen.
BACK	Displays the last screen viewed, or hides the on-screen keyboard.
TV/WEB	Switches between TV and Internet modes.
Arrow Buttons	Move the yellow highlight box to a different command or activity on the screen; select different keys when the on-screen keyboard is displayed.
MY SHOWS	Displays a list of programs that you have recorded with your Satellite Receiver.
INFO	Displays information on the program you are viewing.
GUIDE	Displays information on available programs, including channel, time and date.
◆ Button	Activates a highlighted link or command; displays the on-screen keyboard.
VOL +/-	Increases and decreases the volume.
CH +/-	Moves to the next or previous channel.
CODE SET	Used for programming the remote control to operate your TV. See page 21 for details.

Setting up the Remote Control

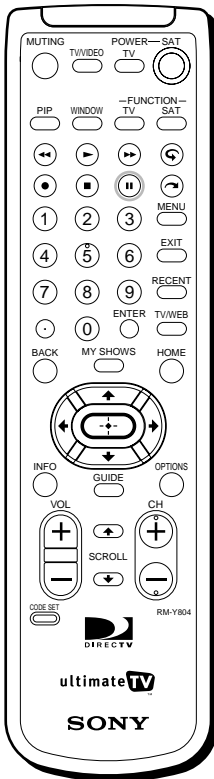

The remote control can be programmed to operate most brands of televisions.

- 1 Find the code(s) for the manufacturer of the TV you want to operate with this remote control. You can find these codes on page 22.
- 2 Press the CODE SET button. The function indicators begin flashing.



- 3 Press the 0-9 buttons to input the manufacturer code, then press the ENTER button. The function indicator goes off, and the remote is set up to operate that device.

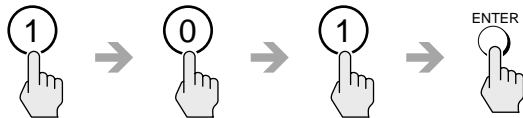

- 4 Test the remote control. Press the POWER button for the device you want to control, then press other operation controls such as the CH +/- buttons. If the TV does not respond to the remote control, repeat from step 2 and enter a different manufacturer code in step 3.

Tip

Remember to aim the remote control at the TV you are trying to operate.

Manufacturer Codes

TV Codes

Manufacturer	Code
Sony	101
Admiral (M. Wards)	102, 114, 109
ABC	112
Bell & Howell (M. Wards)	114, 109, 138
Broksonic	103, 112
Craig	122, 123, 120, 121
Croslex	111
Curtis Mathis	103, 119, 123
Daewoo	135, 136, 103
Daytron	113
Emerson	122, 113, 120, 121, 123, 103, 115
Fisher	125
General Electric	102, 118, 103, 107
Goldstar	103, 113, 112, 130
Hitachi	131, 113, 103, 132
JC Penney	103, 102, 130, 107
JVC	128, 129
KTV	133, 113, 103, 123, 134
LXI (Sears)	102, 103 111, 125, 119, 112
Magnavox	111, 112, 113, 107
Mitsubishi/MGA	124, 103, 112
NEC	103, 112
Panasonic	118, 116, 117, 107
Philco	111, 118, 109
Philips	111
Pilot	103
Pioneer	137, 118, 119

Manufacturer	Code
Portland	103, 108
Quasar	110, 107
Radio Shack	102, 112, 124, 123
RCA/Proscan	102, 103, 104, 105, 106, 107, 108
Samsung	126, 112, 113, 103
Sanyo	125
Scott	123, 112
Sharp	114, 113, 115
Signature 2000 (M. Wards)	114, 109
Sylvania	111, 112, 108
Symphonic	123, 139
Tenika	109
Toshiba	119, 114
Videch	131, 103, 112
Wards	113, 103, 115, 112
Zenith	108, 110

Other Information

Front Panel Controls & Terminals

Satellite Receiver

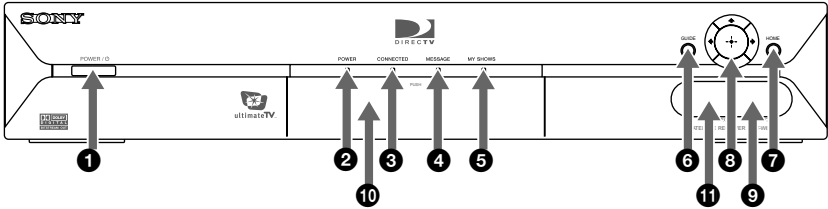

Feature	Description
1 Power Button	Turns your Satellite Receiver on and off
2 POWER Indicator	Indicates whether the Satellite Receiver is on or off.
3 CONNECTED Indicator	Flashes while the Satellite Receiver is connecting to the WebTV service and while receiving new information. Remains lit while in use.
4 MESSAGE Indicator	Lights up to indicate you have an unopened e-mail message.
5 MY SHOWS Indicator	Indicates that a program is being recorded by My Shows.
6 GUIDE Button	Opens the Program Guide.
7 HOME Button	Opens the TV Home screen.
8 Arrow and \oplus Buttons	The arrow buttons move the highlight in the on-screen displays. The \oplus button selects the highlighted item.
9 AUDIO (R/L)/VIDEO IN	Allows easy connection of audio/video devices, such as a camcorder or digital camera.
10 ACCESS CARD Slot	The Access Card allows you to access DIRECTV services.
11 MIC INPUT Jack	Allows easy connection of a microphone.

Back Panel Terminals

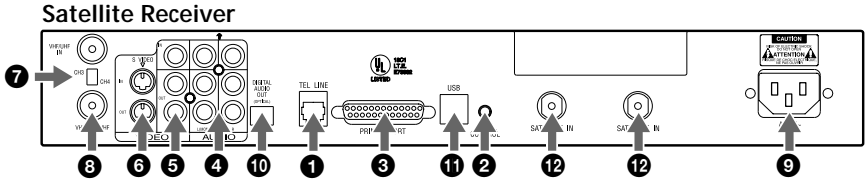

Connector	Description
1 TELEPHONE LINE	Connects your Satellite Receiver to a telephone jack.
2 VCR CONTROL	Allows you to connect your IR Blaster for easy control of your cable box and/or VCR through the Satellite Receiver.
3 PRINTER PORT	Allows you to connect your Satellite Receiver to a printer.
4 AUDIO (R)/(L) IN/OUT	Connects your Satellite Receiver to the right and left audio inputs and outputs of your TV.
5 VIDEO IN/OUT	Connects your Satellite Receiver to your TV's or VCR's video inputs and outputs.
6 S-VIDEO IN/OUT	Allows you to connect your Satellite Receiver to your TV and VCR for optimal picture quality (if your TV and VCR support S-Video).
7 CH 3-CH 4 Switch	The switch determines which TV channel allows you to view programs from your Satellite Receiver when connected through the VHF/UHF connector.
8 VHF/UHF	IN: Allows you to connect your normal (antenna) TV or cable TV service to your Satellite Receiver. OUT: Allows you to send normal (antenna) TV or cable signals to your TV or VCR from your Satellite Receiver.
9 AC IN	Connects your Satellite Receiver to a 120V AC outlet.
10 DIGITAL AUDIO OUTPUT	Allows you to connect an optional digital audio system.
11 USB Port	Allows you to connect Universal Serial Bus components.
12 SATELLITE IN	Connect the cable from your satellite dish antenna here. Connect a second cable if you wish to use both of the Satellite Receiver's tuners, this allows features such as PIP and recording one show while viewing another.

Specifications

Terminals	Video In (2) Video Out (2) Audio (R/L) In (2) Audio (R/L) Out (2) S-Video In (1)/Out (1) Tel Line (1) Microphone In (1) Printer Port (DB25) (1) VCR Control (1) Digital Audio Out (1) USB Port (2) Satellite In (2) CH3-CH4 Switch (1) VHF/UHF In/Out (1) AC In (1)
Dimensions	430 mm x 70 mm x 290 mm (w/h/d) (17" x 2 3/4" x 11 1/2")
Weight	4.3 kg (9.4 lbs)
Power Requirements	AC 120V
Power Consumption	90 W max
Supplied Accessories	Remote Control RM-Y804 (1) Size AA Batteries (2) AC Power Cord (1) A/V (Audio/Video) Cable (1) Telephone Cable (1) S-Video Cable (1) T Splitter (1) Coaxial Cable (1) IR Blaster (1) Wireless Keyboard KI-W250 (1) Access Card (1)
Optional Accessories	Local Antenna ANJ-AA1 Installation Kit ANJ-DS2 Amplifier EAC-DA1 Diplexer EAC-DD1 Voltage Switch EAC-DV2 Dish SAN-24MD1

Troubleshooting

Symptom	Possible Cause and remedies
TV POWER button doesn't turn on TV.	The remote control has not been properly programmed. See "Setting up the Remote Control" on page 21. The batteries in the remote control or wireless keyboard could be weak. Check the batteries and replace them if necessary.
No picture, no sound.	Make sure the AC Power Cord is connected. Check that the TV/VIDEO switch is set correctly. Make sure the Satellite Receiver is properly connected. If you connected using a S-Video or A/V cables, make sure they are properly connected. If your TV must be set to a certain channel to view other devices to which it is connected, make sure this channel is selected. Check that the correct video input is selected by pressing the TV/VIDEO button. If your TV is not connected using the S-Video or A/V cables, set the CH3-CH4 switch on the back of the Satellite Receiver to the opposite channel to which it is currently set.
No sound.	If you connected the Satellite Receiver using A/V cables, make sure the cables are properly connected.
Can't change TV channels while using UltimateTV service.	Make sure you select the TV FUNCTION button.
The UltimateTV service screens disappear after pressing the CHANNEL +/- buttons.	Press the TV/VIDEO button on the remote control until the UltimateTV screen appears.
VCR Control doesn't seem to be working correctly.	Check that the IR Blaster is positioned directly in front of the infrared sensor area of your cable box and/or VCR. Follow the on-line instructions in the "Settings" link, accessible from the TV Home page of the UltimateTV service.

Symptom	Possible Cause and remedies
The Satellite Receiver gets extremely hot.	Check the placement of the Satellite Receiver. Place the Satellite Receiver in a location with adequate ventilation. Do not place the Satellite Receiver in a cabinet or on a TV. If the heat is excessive, contact your Sony dealer.
The Satellite Receiver turns off and on by itself.	This is often caused by static build up. Turn off the Satellite Receiver and disconnect the AC Power Cord from the power outlet. Then reconnect the AC Power Cord to the power outlet and turn on the Satellite Receiver. If this does not solve the problem, contact your Sony dealer.
The Satellite Receiver will not turn on.	Make sure the AC Power Cord is securely connected to the Satellite Receiver and a power outlet.
The Satellite Receiver will not connect to the Internet after receiving an upgrade from the UltimateTV service.	Turn off the Satellite Receiver and disconnect the AC Power Cord from the power outlet. Then reconnect the AC Power Cord to the power outlet and turn on the Satellite Receiver. You may need to repeat this procedure three or four times to solve the problem.
The Message Indicator light is not working.	You can set your Satellite Receiver to check for messages automatically. However, if you check for messages yourself before the Satellite Receiver is set to do so automatically, the Message Indicator may not light until the Satellite Receiver checks again. You may want to consider setting the Satellite Receiver to check for mail when you usually are not connected.
Remote control or keyboard is no longer working.	Replace the batteries. Try pressing the SAT FUNCTION button.
No channels are viewable.	Activate your service by contacting DIRECTV at 1-800-DIRECTV (347-3288) Check the status of your service with UltimateTV at 1-877-ULTIMATE (858-4628)

Limited Warranty

Satellite Receiver

SONY ELECTRONICS INC. ("SONY") warrants this Product against defects in material or workmanship as follows:

1. Labor: For a period of 90 days from the original date of purchase, if the Product is determined to be defective, SONY will repair or replace the Product at no charge. After this 90 day period, you must pay for all labor charges.
2. Parts: For a period of one year from the original date of purchase, SONY will supply, at no charge, new or rebuilt replacements in exchange for defective parts. Any replacements will be warranted for the longer of the remainder of the original warranty period or 90 days from the parts installation by a SONY authorized DIRECTV System installer or facility.

To obtain warranty service:

- If the Product was installed by a SONY authorized DIRECTV System installer, contact that installer for instructions.
- If the Product was not installed by a SONY authorized DIRECTV System installer, you must take the Product or deliver the Product in either its original packaging or packaging affording an equal degree of protection (with freight prepaid), to a SONY authorized DIRECTV System service facility. To locate the closest such facility, please call the telephone number listed below.

This warranty does not cover customer instruction, installation, set up adjustments or signal reception problems. This warranty does not cover cosmetic damage or damage due to acts of God, accident, misuse, abuse, negligence, commercial use, or modification of, or to any part of the Product. This warranty does not cover improper installation (if not installed by a SONY authorized DIRECTV System installer), loss of use of the product, or

wasted programming charges due to product malfunction. This warranty does not cover damage due to improper operation or maintenance, connection to improper voltage supply, or attempted repair by anyone other than a facility authorized by SONY to service the Product. This warranty does not cover Products sold AS IS or WITH ALL FAULTS. This warranty is valid only in the United States. Proof of purchase in the form of a bill of sale or receipted invoice which is evidence that the Product is within the Warranty period must be presented to obtain warranty service.

REPAIR OR REPLACEMENT AS PROVIDED UNDER THIS WARRANTY IS THE EXCLUSIVE REMEDY OF THE CONSUMER. SONY SHALL NOT BE LIABLE FOR ANY INCIDENTAL OR CONSEQUENTIAL DAMAGES FOR BREACH OF ANY EXPRESS OR IMPLIED WARRANTY ON THIS PRODUCT. IN NO EVENT SHALL SONY BE LIABLE FOR ANY INCIDENTAL OR CONSEQUENTIAL DAMAGES WHATSOEVER ARISING OUT OF THE USE OR INABILITY TO USE THE PRODUCT. UNDER NO CIRCUMSTANCES SHALL SONY'S LIABILITY, IF ANY, EXCEED THE PURCHASE PRICE PAID FOR THE PRODUCT. EXCEPT TO THE EXTENT PROHIBITED BY APPLICABLE LAW, ANY IMPLIED WARRANTY OF MERCHANTABILITY OR FITNESS FOR A PARTICULAR PURPOSE ON THIS PRODUCT IS LIMITED IN DURATION TO THE DURATION OF THIS WARRANTY.

This warranty is invalid if the factory applied serial number has been altered or removed from the Product. Some states do not allow the exclusion or limitation of incidental or consequential damages, or allow limitations on how long an implied warranty lasts, so the above limitations or exclusions may not apply to you. In

In addition, if you enter into a service contract with the SONY Partnership within 90 days of the date of sale, the limitation on how long an implied warranty lasts does not apply to you. This warranty gives you specific legal rights, and you may have other rights which vary from state to state.

For your convenience, SONY ELECTRONICS INC. has established telephone numbers for frequently asked questions:

For assistance with installation, contact the dealer from whom you purchased your Multi-Sat Oval Antenna System.

For product information or operation, for service assistance or for resolution of a service problem, call:

**SONY SATELLITE SYSTEM
INFORMATION CENTER
1-800-838-SONY (7669)**

For an accessory or part not available from your authorized dealer, call:

1-800-488-SONY (7669)

About Sony Customer Support

Every DIRECTV System manufactured by Sony comes with Sony's Express Support at no charge to you. In the event of a system failure, our Express Support Program can have a replacement Satellite Receiver on its way to you via overnight Federal Express (for calls Monday-Friday until 7:30 pm Eastern Time; Saturday delivery depends upon zip code). All it takes is a valid credit card to cover a security deposit, and Sony will pay freight in both directions. Our Express Support continues with our 800 number, staffed by dedicated technical representatives who can answer questions on dealer locations, system operation, installation, hookup, accessories, and how to get the most out of your home entertainment system. Sony's ExpressSupportSM program: another expression of our commitment to excellence in customer service.



Should you have any other problems with your Satellite Receiver, please call one of the following numbers:

- For service problems call: **1-877-ULTIMATE (858-4628)**
- To begin service call: **1-800-DIRECTV (347-3288)**

FCC Regulations and Information

FCC Registration Information

Your Satellite Receiver has been registered by the Federal Communication Commission (FCC) as not being harmful to the telephone network when connected directly to the telephone lines. In order to fully comply with the Rules of the FCC, the following instructions should be read carefully and followed completely where applicable:

FCC has established Rules which permit this device to be directly connected to the telephone network. Standardized jacks are used for these connections. This equipment should not be used on party lines or coin phones.

If this device is malfunctioning, it may also be causing harm to the telephone network; this device should be disconnected until the source of the problem can be determined and until the repair has been made. If this is not done, the telephone company may temporarily disconnect service.

The telephone company may make changes in its technical operations and procedures; if such changes affect the compatibility or use of this device, the telephone company is required to give adequate notice of the changes. You will be advised of your right to file a complaint with the FCC.

If the telephone company requests information on what equipment is connected to their lines, inform them of:

- a. The telephone number to which this unit is connected.
- b. The ringer equivalence number.
- c. The USOC jack required.
- d. The FCC Registration Number.

Items (b) and (d) are indicated on the label. The Ringer Equivalence Number (REN) is used to determine how many devices can be connected to your telephone line. In most areas, the sum of the REN's of all devices on any one line should not exceed five (5). If too many devices are attached, they may not ring properly.

Service Requirements

In the event of equipment malfunction, all repairs should be performed by our Company or an authorized agent. It is the responsibility of users requiring service to report the need for service to our company or to one of our authorized agents. For service, call 1-888-772-7669.

Radio Interference Information

This equipment has been tested and found to comply with the limits for a Class B digital device, pursuant to Part 15 of the FCC rules. These limits are designed to provide reasonable protection against harmful interference in a residential installation. This equipment generates, uses and can radiate radio frequency energy and, if not installed and used in accordance with the instructions, may cause harmful interference with radio communications. However, there is no guarantee that interference will not occur in a particular installation. If this equipment does cause interference to radio or television reception (which you can determine by turning the equipment off and on), you are encouraged to try to correct the interference by one or more of the following measures:

Change the position of the Satellite Receiver with respect to the radio or television equipment that is receiving the interference.

Move the Satellite Receiver away from the equipment that is receiving the interference.

Plug the Satellite Receiver into a different outlet so that the Satellite Receiver and the equipment receiving the interference are on different branch circuits.

Shielded cables and I/O cords must be used for this equipment to comply with the relevant FCC regulations. Changes or modifications not expressly approved in writing by Sony Electronics, Inc., void the user's authority to operate this equipment.

If these measures do not eliminate the interference, you should consult your Satellite Receiver dealer or an experienced radio/television technician for additional suggestions. In addition, you may find the following booklet prepared by the FCC helpful: "How to Identify and Resolve Radio-TV Interference Problems." This booklet is available from the U.S. Government Printing Office, Washington, D.C., 20402 Stock No. 004-000-00345-4.

Declaration of Conformity

Trade Name: Sony
Model No.: SAT-W60
Responsible Party: Sony Electronics Inc.
Address: 1 Sony Drive, Park Ridge, NJ, 07656 USA
Telephone No.: 201-930-6972

This device complies with Part 15 of the FCC rules. Operation is subject to the following two conditions:

- (1) This device may not cause harmful interference, and
- (2) this device must accept any interference received, including interference that may cause undesired operation.

Sony  line

www.sony.com

Contact Sony with your questions and comments
www.sel.sony.com/SEL/feedback.htm