

NRD412NA

OWNER'S MANUAL

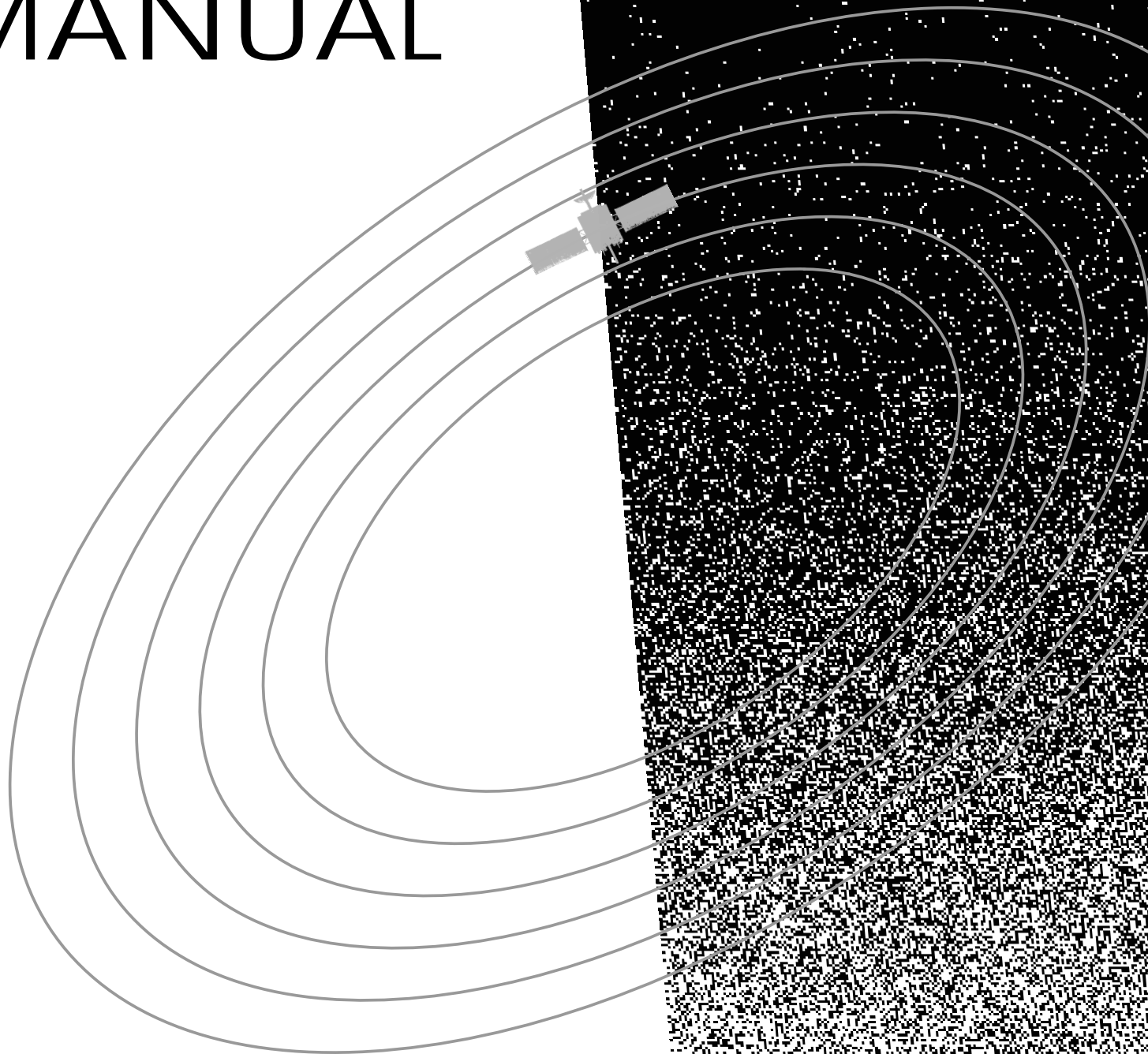

SATELLITE RECEIVER

SAFETY INFORMATION

WARNING

To reduce risk of fire or shock hazard, do not expose this receiver to rain or moisture.

WARNING

RISK OF ELECTRIC SHOCK
DO NOT OPEN



This symbol indicates "dangerous voltage" inside the product that presents a risk of electric shock or personal injury.



This symbol indicates important instructions accompanying the product.

TO REDUCE THE RISK OF ELECTRIC SHOCK, DO NOT REMOVE COVER (OR BACK). NO USER SERVICEABLE PARTS INSIDE. REFER SERVICING TO QUALIFIED SERVICE PERSONNEL.

Cautions

Do not stack electronic components or other objects on top of the DSS Receiver. The slots on top of the receiver must be left uncovered to allow proper airflow to the unit. Blocking the airflow to the unit could impair performance or damage your receiver and other components.

Do not stack the DSS receiver on top of a "hot component" such as an audio power amplifier.

FCC Regulations state that unauthorized changes or modifications to this equipment may void the user's authority to operate it.

Note to Cable TV Installer:

This reminder is provided to call your attention to Article 820-40 of the National Electrical Code (Section 54 of the Canadian Electrical Code, Part 1) which provides guidelines for proper grounding and, in particular, specifies that the cable ground shall be connected to the grounding system of the building as close to the point of cable entry as practical.

Note to Satellite Dish Installer:

This reminder is provided to call your attention to Article 810 and in particular article 810-15 of the National Electrical Code which covers proper installation and grounding of television receiving equipment as well as to article 820-40 of the National Electrical Code which specifies that the satellite dish cable ground shall be connected to the grounding system of the building as close to the point of cable entry as practical.

IMPORTANT NOTICE:

This device incorporates an anticopy process technology that is protected by U.S. patents and other intellectual property rights. The anticopy process is licensed for non-commercial, home use only. Reverse engineering or disassembly is prohibited.

TABLE OF CONTENTS

First Things First	3
What is the DSS® System?	4
Ordering DSS® Programming	4
Unpacking the Box	5
Installing Batteries In the Remote Control	5
Using This Manual	6
Important Note about This User's Manual	6
Point and Select	7
What is Point and Select?	8
Program Guides	9
Bringing Up the Program Guides	10
Using A Program Guide	10
Using the Number Keys (0-9)	10
Scrolling Channel By Channel	10
Scrolling Page By Page	11
Tuning to a Program	11
Selecting A Program Guide from the Main Menu	11
Types of Program Guides	12
Sorting the Grid Guide	13
Exiting A Program Guide	15
The Menu System	17
Using the Menu System	18
Exiting a Screen	18
Using Help	18
Menu Descriptions	19
Lists & Limits	21
An Overview	22
Setting the Ratings Limit	22
Setting Up Spending Limits	23
Creating Favorite Channel Lists	23
Parent Approved Channel List	25
Selecting a Channel List to Use	25
Locking the System	25
Unlocking the System	26
Session Unlock	26

TABLE OF CONTENTS

More Features	27
Pay-Per-View Programs	28
Using the Attractions Guide	29
Using the Purchases Menu	30
Timer Feature	31
Editing or Canceling a Timer	31
The Mailbox	32
Alternate Audio Programs	33
Picture Size	34
System Test	34
New Access Card Setup	34
Using On-Line Help	35
Connections	37
Connecting Your DSS® Receiver to Your TV	38
Choosing a Connection	39
Interactive Setup	44
Disabling Interactive Setup	44
Reference	45
Parts of the DSS® System	46
Front Panel Controls	48
Back Panel	48
Remote Control Buttons	49
Programming the Remote to Control aTV	50
Using the Remote Buttons to Control a TV	50
Glossary	52
Troubleshooting	53
Appendix A: Warranty Information	55
Appendix B: FCC Regulations	58
Appendix C: Accessories	59
Index	61

DSS® is a registered trademark of DIRECTV, Inc., a unit of Hughes Electronics Corp.

StarSight-Licensed: The manufacture and sale of the television schedule feature of this product was licensed under one or more of the following patents of Starsight Telecast, Inc.: U.S. Patent Nos. 4,706,121; 4,977,455; 5,151,789; and 5,353,121.

FIRST THINGS FIRST

READ THE FIRST FOUR SECTIONS

The first four sections of the manual introduce you to your DSS® system, and show you how to use the on-screen guides and menus. Reading these sections gives you the basic information you need to navigate the DSS® system.

LISTS & LIMITS

The fifth section of the book introduces you to the Lists & Limits feature, which lets you control the way you watch DSS® programming by creating favorite channel lists, and by setting ratings limits and spending limits.

THE REST OF THE MANUAL

The rest of the book highlights the remaining features, and includes reference information such as a connections guide, a glossary, and an index.

1 FIRST THINGS FIRST



2 POINT AND SELECT



3 PROGRAM GUIDES



4 THE MENU SYSTEM



5 LISTS & LIMITS

Take some time right now to read at least the first five sections. Then, as you have time, you can check out the rest of the book.

FIRST THINGS FIRST

WHAT IS THE DSS® SYSTEM?

You've purchased the DSS® Digital Satellite System, so you already know a lot of the great things it offers. You know that the DSS® system uses the latest satellite technology to deliver television programming to your home. And you know that the transmissions are digital, so the quality of the picture and audio rivals that of laser discs and CDs. You know the dish is small—18 inches wide—and that it often can be installed in a matter of hours. (See the DSS® System Installer Guide for specific information.)

Those are the some of the things you probably know about the DSS® system. But what about the things you don't know? For instance...

- **The DSS® system works like your TV.** Pick up the DSS® remote and push the DSS® button. Press the Channel Up/Down buttons to scan through the channels. Press the number keys to go directly to a channel.
- There is an **on-screen Program Guide**. The Program Guide is like a TV listing in the newspaper. It is designed to help you select regular programs and pay-per-view events. You can also sort the Guide to list only specific types of programs. You can select Sports, for example, and your guide will show current and upcoming sports programs only. Or Movies. Or News.
- There is the **on-screen Menu System** that allows you to customize your system. You can set up your system, build channel lists, preview coming attractions, set spending limits, and receive mail from your program providers.
- There are three types of **On-line Help** to assist you in learning how to use the DSS® system: Auto Help, Help buttons, and the About DSS menu.

ORDERING DSS® PROGRAMMING

After you have installed your system, you should contact the service providers, DIRECTV and USSB to receive DSS® programming.

Programming with DIRECTV: Call 1-800-347-3288

Programming with USSB: Call 1-800-204-USSB

When you order programming, you need to know your Access Card number. To get the number, select Options from the Main menu, and then select System Test. Wait for the system to run all of it's tests. The Access Card number is displayed at the end of the system test.

Write the Access Card number in the space below for easy reference:

FIRST THINGS FIRST

UNPACKING THE BOX

The following items come with your DSS® receiver:

- Receiver (with access card inserted)
- Remote Control



Receiver

Remote Control

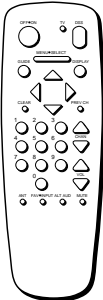

INSTALLING BATTERIES IN THE REMOTE CONTROL

Follow these steps whenever you need to install or change the batteries in your DSS® remote.

1. Pull off the cover of the battery compartment.
2. Place four AAA batteries as shown, matching the + and - end of each battery in each compartment.
3. Replace the cover.

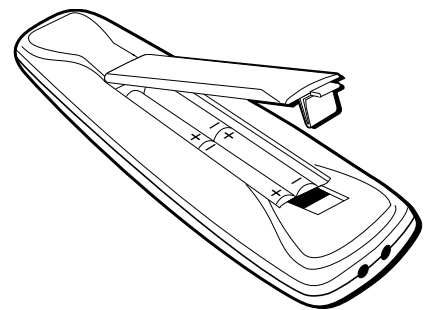

FIRST THINGS FIRST

USING THIS MANUAL

There are a couple of conventions used in this manual that might help you read it.

- Words that appear in ALL CAPS indicate the name of a button.
- The names of on-screen menu option are shown in *italics*.

IMPORTANT NOTE ABOUT THIS USER'S MANUAL

This manual assumes that your DSS® system has been installed, meaning:

1. The DSS® satellite dish has been installed, correctly pointed at the satellite, and connected to your DSS® receiver.
2. The DSS® receiver is connected to your television and to a telephone line.
3. The access card is installed in your DSS® receiver.

Your access card has been matched to your receiver, and should already be installed when you take the receiver out of the packing box. The access card should only be taken out of the DSS® receiver when you are issued a new card by your programming providers.

4. The DSS® remote control has batteries and can be programmed to control both your DSS® receiver and your TV (if your TV is remote-controllable).

If your system has not been installed, refer to the satellite dish Installer's Guide for information regarding proper installation. Then, refer to the section, "Connections," in this manual. See your dealer for specific information regarding professional installation or the purchase of a Self-Installer's Kit.

POINT AND SELECT

A NAVIGATION METHOD

Point and Select is a method of navigating through the menu system and program guides. Once you know how to point and select, you can explore the menus to learn more about how your DSS® system works.

1 FIRST THINGS FIRST



2 POINT AND SELECT



3 PROGRAM GUIDES



4 THE MENU SYSTEM



5 LISTS & LIMITS

POINT AND SELECT

WHAT IS POINT AND SELECT?

Point and Select is the two-step method you use to control the DSS® system.

1. POINT

You point by pressing the arrow keys on the remote or front panel. Pressing the arrow keys moves the on-screen highlight to different items in the Program Guide and the menu screens. Pressing an arrow once moves the highlight one space in the direction of the arrow.

For example, to point down (that is, to move the highlight toward the bottom of the screen), press the down arrow. To point right, press the right arrow.

2. SELECT

Once you have pointed to an item on the screen, select it by pressing the MENU•SELECT button on the remote or front panel. Selecting an item tells the menu system to make the change you have indicated.

For example, the instructions in the User's Manual might tell you to "Point to the *Help* button and press MENU•SELECT."

Once you've understand the Point and Select rule, you can use any part of the DSS® system, beginning with the Program Guides.

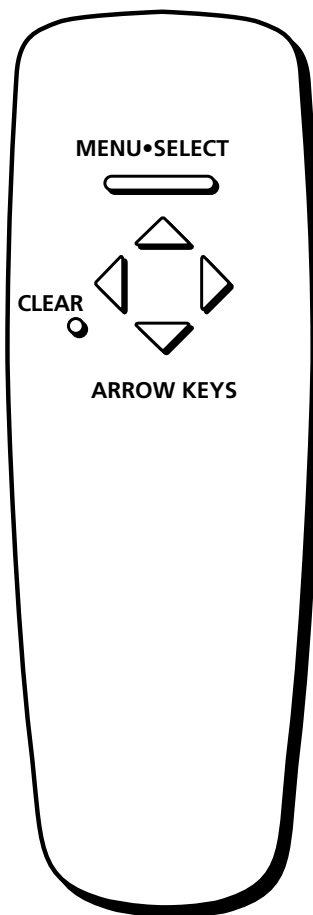

Exiting A Screen

Pressing the CLEAR button on the remote takes you out of the menu system and back to the program you were watching.

PROGRAM GUIDES

WHAT IS A PROGRAM GUIDE?

A program guide is an on-screen programming schedule. There are several types of guides, each presenting the schedule in a different format.

Using Program Guides is easy as long as you remember the Point and Select rule. Point to items on the screen by pressing the arrow keys on the remote or front panel. Then, press MENU•SELECT to go to that program.

1 FIRST THINGS FIRST



2 POINT AND SELECT



3 PROGRAM GUIDES



4 THE MENU SYSTEM



5 LISTS & LIMITS

Take some time to explore the different types of Program Guides and use the one that best suits your viewing habits.

PROGRAM GUIDES

BRINGING UP THE PROGRAM GUIDES

You can access the program guides by using the GUIDE button on the remote, or by selecting *Program Guide* from the Main menu.

When you press the GUIDE button on the remote, the Grid Guide appears on-screen.

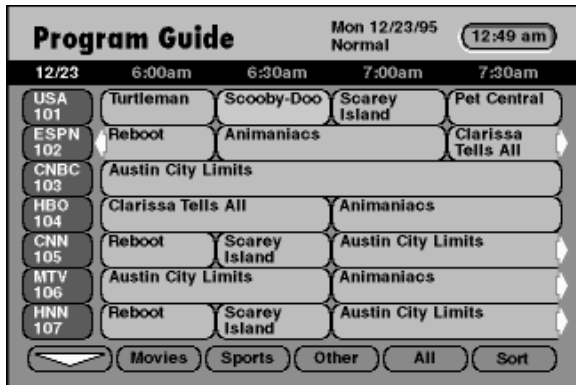

The Grid Guide is one type of program guide.

USING A PROGRAM GUIDE

There are several ways to navigate through a program guide, once it has been selected.

USING THE NUMBER KEYS (0-9)

You can point quickly to any channel in a Program Guide by entering the channel number with the number keys (0-9). For example, to point to the first listing for Channel 128, press the numbers 1-2-8 on the remote. To point to Channel 102, press 1-0-2.

SCROLLING CHANNEL BY CHANNEL

The programs that you see on the TV screen make up one section—or page—of the total Program Guide. You can scroll to other sections using the arrows: point to other times with the left and right arrows; point to other channels with the up and down arrows.

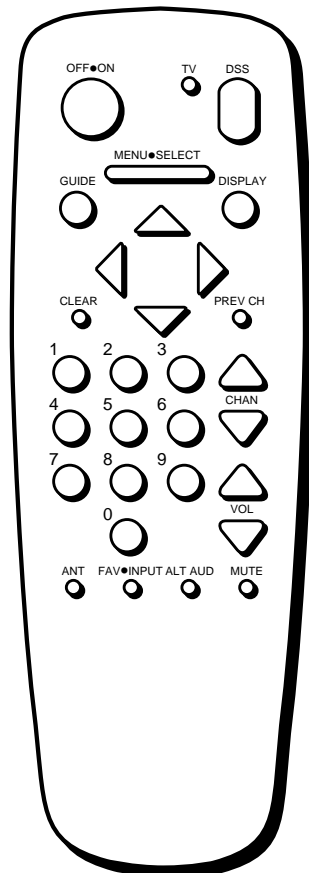

PROGRAM GUIDES

SCROLLING PAGE BY PAGE

If you want to scroll up or down through the Program Guide faster, press the Channel Up/Down buttons on the remote control. The highlight scrolls a page at a time. This is called "paging."

TUNING TO A PROGRAM

To tune to a program listed in the guide, point to the program and press MENU•SELECT.

Program Details

To see program details, press the DISPLAY button on the remote.

SELECTING A PROGRAM GUIDE FROM THE MAIN MENU

When you access the program guides through the Main menu, you have more available options:

1. Press MENU•SELECT to bring up the Main menu.
2. Point to *Program Guide* and press MENU•SELECT.

The Program Guide menu screen appears.

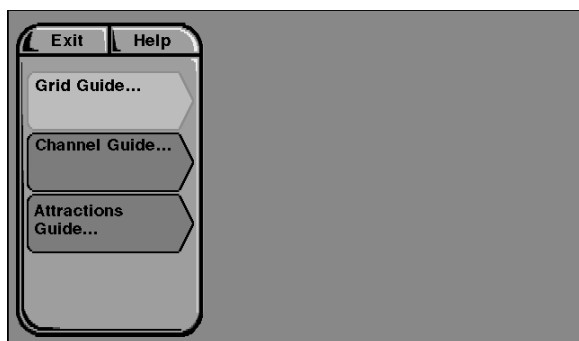

This is the Program Guide menu. Use the arrow to scroll down to see the Attractions Guide option.

PROGRAM GUIDES

TYPES OF PROGRAM GUIDES

There are three types of program guides: the Grid Guide, the Channel Guide, and the Attractions Guide.

The Grid Guide

Shows the schedule in a time-and-channel format, similar to a TV schedule listed in a newspaper.

Program Guide		Mon 12/23/95		12:49 am
		Normal		
12/23	6:00am	6:30am	7:00am	7:30am
USA 101	Turtleman	Scooby-Doo	Scarey Island	Pet Central
ESPN 102	Reboot	Animaniacs		Clarissa Tells All
CNBC 103	Austin City Limits			
HBO 104	Clarissa Tells All		Animaniacs	
CNN 105	Reboot	Scarey Island	Austin City Limits	
MTV 106	Austin City Limits		Animaniacs	
HNN 107	Reboot	Scarey Island	Austin City Limits	

Navigation buttons: Movies, Sports, Other, All, Sort

The seven-channel Grid Guide.

The Channel Guide

Displays the programming schedule in a channel-by-channel format.

Channel	Program	Start Time
HBO2 Ch 976	A Bronx Tale	12/24/95 12:00am
HBO2 Ch 976	Bang the Drum Slowly	12/24/95 2:00am
HBO2 Ch 976	Taxi Driver	12/24/95 4:15am
HBO2 Ch 976	Raging Bull	12/24/95 7:00am
HBO2 Ch 976	This Boy's Life	12/24/95 9:30am

Navigation buttons: Exit, Help, Channel Up, Channel Down, Multi-Channel HBO

The Channel guide.

Reminder

You can use the **GUIDE** button on the remote to directly access the Grid Guide while you are watching a DSS® program.

PROGRAM GUIDES

The Attractions Guide

Displays coming attractions and special events information.



The Attractions guide.

SORTING THE GRID GUIDE

There are six on-screen choices—called “buttons”—at the bottom of the Grid Guide: down arrow, Movies, Sports, Other, All, and Sort.

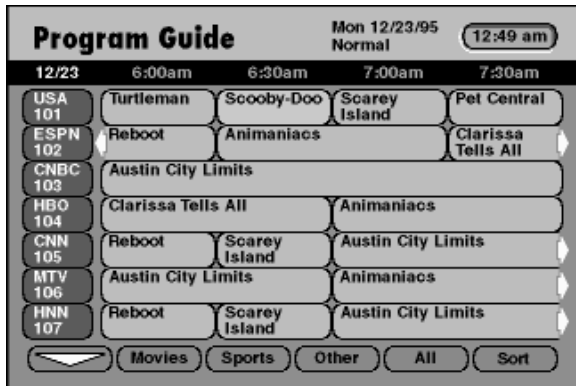

The Sorting buttons are at the bottom of the screen.

DOWN ARROW

The down arrow button allows you to scroll down through other channels in the guide. Point to the down arrow, and then press MENU•SELECT to scroll down through the program guide.

See the section on purchasing pay-per-view programs for more information on the Attractions guide.

PROGRAM GUIDES

USING THE SORTING BUTTONS

The remaining buttons at the bottom of the guide are called “sorting buttons.” These buttons allow you to simplify the guide to show specific types of information such as movies, or sports.

Movies

The Movies button lists movies only. After selecting Movies, point to the *Theme* button that appears and press MENU•SELECT to sort the guide to list specific types of movies, such as comedies or thrillers.

Sports

The Sports button lists sporting events only. After selecting Sports, point to the *Theme* button that appears and press MENU•SELECT to sort the guide to highlight specific types of sports, such as basketball or soccer.

Other

Allows you choose from a list of sorting topics. Once you have selected a sorting topic from the list, your guide will be simplified to show only that type of program.

After selecting a topic, a *Themes* button may appear in the place of the *Other* button.

All

Resets the guide to show all available channels and listings.

Sort

The Sort button takes you to the Guide Filter menu screen

PROGRAM GUIDES

USING THE THEMES BUTTON

After you select one of the sorting buttons, the name of that button changes into the *Themes* button. Use the *Themes* button to further sort the Grid or Info Guide to show subtopics ("themes"). For example, you could simplify the guide to show "baseball" under the Sports sorting button, or "comedies" under Movies.

EXITING A PROGRAM GUIDE

There are two ways to exit a Program Guide:

- Tune to a program.
- Press CLEAR on the remote.

THE MENU SYSTEM

WHAT IS A MENU?

The DSS® menu is a list of choices, just like a menu in a restaurant. And, just as a restaurant menu is divided into sections such as appetizers, entrees, and desserts, the on-screen menus are also separated into sections to help you find the information you need.

DON'T FORGET TO POINT AND SELECT

As with all of the on-screen displays, you use Point and Select to navigate.

1 FIRST THINGS FIRST



2 POINT AND SELECT



3 PROGRAM GUIDES



4 THE MENU SYSTEM



5 LISTS & LIMITS

Use the MENU•SELECT button to bring up the Main Menu, and then use Point and Select to choose a menu option.

THE MENU SYSTEM

USING THE MENU SYSTEM

To bring up the Main Menu, press MENU•SELECT on the remote.



The Main Menu.

To use the menu system, you need to know the Point and Select rule. Use the arrows on the remote to point to an item on the screen, and then press MENU•SELECT to select it.

EXIT AND HELP

There are Exit and Help buttons at the top of most screens. Point to *Exit* and press MENU•SELECT to leave that screen. Point to *Help* and press MENU•SELECT to see more information about that screen.

Exiting a Screen

There are two ways to exit a menu:

- Point to *Exit* and press MENU•SELECT.
- Press the CLEAR button on the remote control. The on-screen displays clear from the screen and you return to TV viewing.

Using Help

All menus have a Help button. For example, selecting the Help button from the Main Menu shows you information about using the Main Menu screen.

The rest of the Help buttons in the menu system bring up helpful information explaining one aspect of that menu.

If the Main Menu doesn't appear when you press MENU•SELECT, the remote might not be in DSS® mode. Try pressing the DSS button on the remote, and then MENU•SELECT.

Context-Sensitive Help

Most of the screens contain information to help you decide what to do next. If you get stuck, look for the help text.

THE MENU SYSTEM

MENU DESCRIPTIONS

This section briefly describes each of the available Main Menu options. Detailed information about each menu is included in the sections of the manual which describe each menu.

Program Guide

Shows the on-screen programming schedule options.

Mailbox

Use to read your mail messages.

Purchases

Use to review or cancel upcoming purchases, and to review past purchases.

Timers

Allows you to schedule the DSS® system to tune to a specific channel at a specific time.

Lists and Limits

Allows you to set ratings and spending limits, and to create favorite channel lists.

Options

Allows you to run the system test and install a new access card.

Dish Pointing

Use to find your dish pointing coordinates, and to access the on-screen signal strength meter.

Assistance

Shows you information about using the system and setting the system to your personal preferences.

EXPLORE THE SYSTEM

The best way to learn about the DSS® system is to explore the menus. The context-sensitive help at the bottom of the screen provides instructions for getting through any particular menu or control panel. Remember, press CLEAR at any time to leave the menu system and return to regular DSS® viewing.



Don't Forget about the CLEAR button

Press the CLEAR button on the remote to remove the on-screen menus and return to normal viewing.

LISTS & LIMITS

CONTROLLING THE SYSTEM

The Lists & Limits feature puts you in control of your DSS® viewing by letting you create channel lists and set ratings and spending limits which can be password protected.

ESPECIALLY FOR PARENTS

You can set up a parent approved channel list so that selected channels cannot be viewed when the system is locked, unless the system password is entered.

In addition to activating the ratings, spending, and channel limits, the system lock feature keeps anyone from changing any of the limits without first entering a four-digit password.

1 FIRST THINGS FIRST



2 POINT AND SELECT



3 PROGRAM GUIDES



4 THE MENU SYSTEM



5 LISTS & LIMITS

LISTS & LIMITS

AN OVERVIEW

When you select *Lists & Limits* from the Main Menu, the first screen you see is the Ratings Limit screen. By moving down through the other options, you can set per-event spending limits, create favorite channels lists, and also lock the system by assigning a password.

SETTING THE RATINGS LIMIT

The Ratings Limit menu enables you to set a maximum viewing limit for rated movies (based on the MPAA ratings system), as long as the program provider has transmitted the proper code.

- Note that the ratings limit cannot be enforced if a program has not been rated, if rating information for that program is not transmitted by the program provider, or if the system has not been locked.
1. Point to *Rating Limit* and press MENU•SELECT.

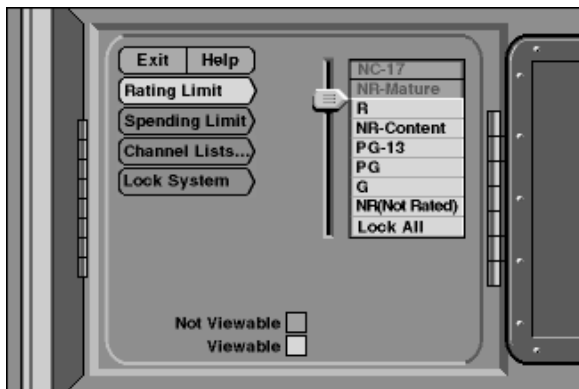

Use the arrow keys to move the selector up and down.

2. Use the up and down arrows to move the rating selector to the highest rating you want to be able to view; then press the left arrow to set the rating. (In the preceding illustration, movies that are rated up to and including an “R” rating can be viewed.)

After the ratings limit is set *and* the system is locked, you must enter the system password to watch programs with a rating higher than your limit.

You need to lock the system in order for rating limits and channel lists to go into effect. See “Locking the System” for details

LISTS & LIMITS

SETTING UP SPENDING LIMITS

Use the *Spending Limit* option to indicate a per-event spending limit for pay-per-view programs.

1. Point to *Spending Limit*, and press MENU•SELECT.

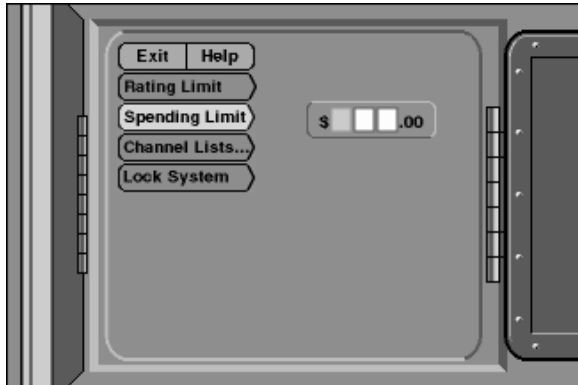

Set a per-event spending limit.

2. Use the arrow keys to enter a single-event spending limit.

After a spending limit is set *and* the system is locked, you must enter the system password to purchase a pay-per-view program that costs more than your spending limit allows.

CREATING FAVORITE CHANNEL LISTS

You can create as many as four different channel lists that can be easily accessed by using the FAV•INPUT button on the remote control.

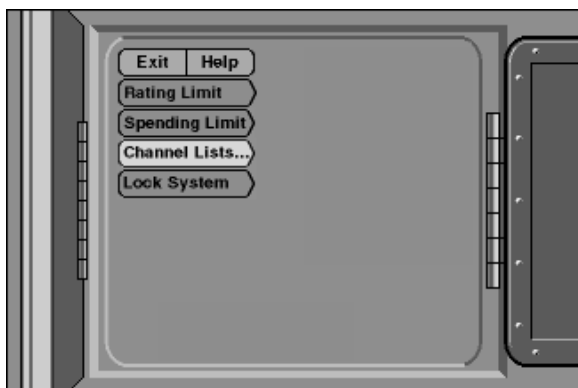

Select the Channel Lists option to create or edit a favorite channels list.

LISTS & LIMITS

1. Point to *Channel Lists* and press MENU•SELECT.



Select a Favorite channel list to edit.

2. Point to a channel list option and press MENU•SELECT.

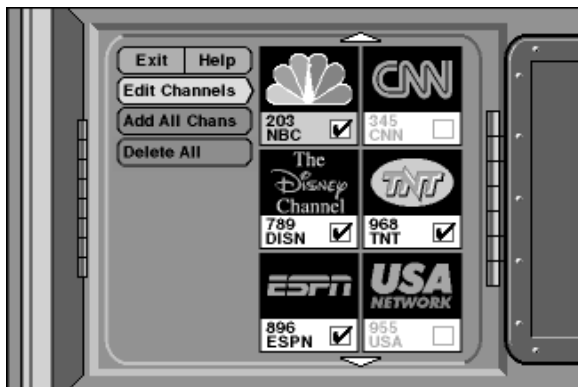

Channels containing a checkmark are included in the channel list .

3. Use the arrow keys to point to a channel, and press MENU•SELECT to remove (or replace) the check mark.

After you have set up the channel lists and locked the system, you will need to enter the system password before you can modify the existing channel lists.

ADD OR DELETE ALL CHANNELS

You might be able to save time when creating a channel list by using the *Add All Chans* option or the *Delete All* option to either add all channels or delete all channels before removing or adding individual channels.

LISTS & LIMITS

PARENT APPROVED CHANNEL LIST

The *Parent Apprv* channel list enables you to limit access to channels by creating a list of acceptable channels, and then locking the system.

When the system is locked, the *Parent Apprv* list overrides all other channel lists, and requires that you enter the four-digit system password to view an unapproved channel.

Note that when you enter the system password to view an unapproved channel, all spending, ratings, and channel limits remain unlocked until you turn off the receiver (see “Locking the System” for more information).

SELECTING A CHANNEL LIST TO USE

When you turn on the DSS receiver, the unit defaults to the “Normal” channel list. You can easily change the channel list by pressing the FAV•INPUT button on the remote to scroll through the available channel lists (Normal, FAV A, FAV B, and FAV C). The active channel list is indicated in the channel banner at the top of the screen (which appears when you change channels or press DISPLAY on the remote).

LOCKING THE SYSTEM

You can lock the system in order to put into effect the ratings, spending, and channel limits you have set up. In addition, when you lock the system, no one can modify any of these setting without first entering the four-digit system password.

1. Point to *Lock System* and press MENU•SELECT.



Enter a four-digit system password to lock the system.

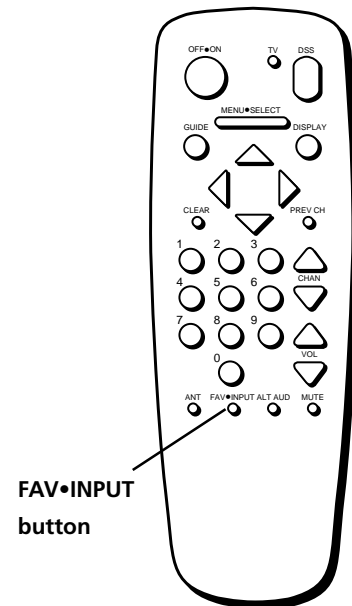

LISTS & LIMITS

2. Use the arrows or the digit keys to enter a four-digit system password.
3. Enter the password a second time to confirm it.

After the system has been locked, you must enter the correct password in order to access the *Lists & Limits* menu, so **Don't Forget Your Password!** If you do forget your password, contact your program provider's authorization center.

UNLOCKING THE SYSTEM

When the system is unlocked, the spending and ratings limits, that you have set are no longer in effect.

1. Point to *Unlock Limits* and press MENU•SELECT.
2. Point to *Yes* and press MENU•SELECT to confirm that you want to unlock the system.

SESSION UNLOCK

If your system is locked and you attempt to access a channel or program that is blocked by one or more limits, you are asked to enter the four-digit system password to override the system lock. If you enter the password to override the rating or spending limit, all limits are unlocked until you turn off the receiver. When you turn on the receiver again, the system will be locked, and the normal channel list will be selected.

Forget Your System Password?

You need to contact your program provider's authorization center to reset your system if you forget your system password.

MORE FEATURES

Up to this point in the manual, you've learned how to use the on-screen program guides, how to get around in the menu system, and how to use the Lists & Limits feature. This section highlights the rest of the features offered by your DSS® system, including the following:

- Pay-Per-View Programs
- The Timer Feature
- Mailbox Menu
- Alternate Audio Programs
- Picture Size
- System Test
- New Access Card Setup
- On-Line Help

Use Point and Select to explore all of the DSS® features on your own.

MORE FEATURES

PAY-PER-VIEW PROGRAMS

Pay-per-view programs (PPV) are programs that you purchase on an event-by-event basis. For instance, there might be a specific channel that runs nothing but previews for movies. After previewing the movie, you can purchase it or find out more details about it. PPV programs can also be found in the Program Guide.

PURCHASING AND VIEWING

There are several ways to purchase PPV movies and events:

- Tune to a PPV program while using the channel buttons on the remote to scan through the channel lists.
- Select a PPV program from the Program Guide.
- Select a coming attraction from the Attractions menu.

TUNING TO A PPV PROGRAM

When you use the channel buttons or digits on the remote to tune to a Pay-Per-View channel, you see the Purchase Offer menu screen.

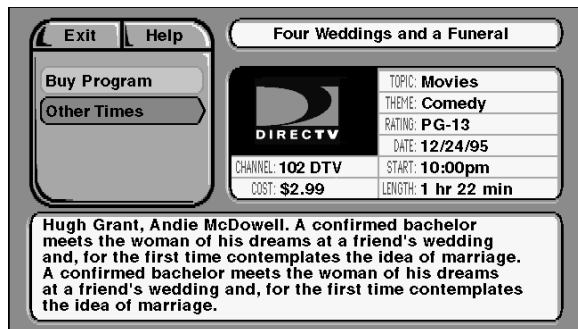

Purchase Offer screen.

Select *Buy Program* and then follow the on-screen instructions to purchase the selected program.

You need to connect your phone line to your satellite receiver to be able to order PPV programs by using the on-screen menus. If your phone line is not connected, you may not be able to access some of the PPV purchase screens shown in this manual.

You may need to enter your four-digit system password to order a PPV program if it costs more than the spending limit you set up in the List & Limits menu.

MORE FEATURES

USING THE PROGRAM GUIDE FOR PPV PROGRAMS

When you use the Program Guide to select a PPV program, the Program Details screen gives you a few more options.

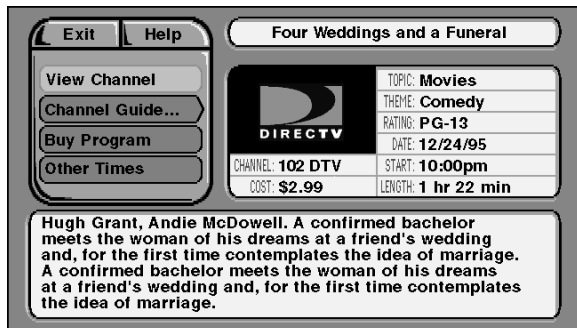

Use the Program Guide to get to the Program Details screen.

Select *View Channel* to see go to that channel and view a program preview (if a preview is available).

Select *Channel Guide* to go to the channel guide.

Select *Buy Program* to purchase the program.

Select *Other Times* to see additional show times.

USING THE ATTRACTIONS GUIDE

Your program providers may offer future programming events not currently listed in the Program Guide. These events are called "coming attractions," and can be previewed and purchased through the *Attractions Guide*.

Access the *Attractions Guide* by first selecting *Program Guide* from the Main menu, and then scrolling down the guide options.



The *Attractions Guide* is accessed through the *Program Guide* menu.

Buy and Record Option

Your program provider may offer PPV programs that are coded so that you cannot record them. When these programs are offered, an additional option (*Buy and Record*) appears in the program details screen. Selecting *Buy and Record* allows you to record the program; selecting *Buy Program* allows you only to watch the program.

MORE FEATURES

USING THE PURCHASES MENU

The Purchases menu allows you to review upcoming and past purchases.



The Purchases menu shows you upcoming or past purchases.

The list of purchases may be longer than one screen; use the down arrow keys to see more items. The display also shows the title, channel, date, time, and cost of each program.

- Note that the Past Purchases list might be modified after each billing cycle and still show purchases for which you have already paid.

REVIEWING AND CANCELING AN UPCOMING PURCHASE

Use Point and Select to choose an upcoming purchase and review the program description. From the Purchase Edit screen, you can also cancel an upcoming purchase.



The Purchase Edit screen lets you cancel an upcoming purchase.

MORE FEATURES

TIMER FEATURE

The Timer feature allows you to preset your system to automatically tune to a particular channel at a predetermined time.

To use the Timer feature, select *Timers* from the main menu to bring up the Timers screen. Select a Timer (1, 2, 3, or 4) and then use the arrow keys to complete the on-screen sentence. When the sentence is complete, select *Run Timer*.



Complete the sentence to set up the timer for each of the four available Timer options.

EDITING OR CANCELING A TIMER

From the Timers screen, select the Timer you want to edit or cancel, and then do the following:

- Use the arrows keys to edit the Timer, then select *Run Timer*.
- Select *Clear Timer* to cancel the timer.

MORE FEATURES

THE MAILBOX

The mailbox shows you messages that are sent—or “mailed”—from your program providers. For example, you may receive a message calling your attention to a new service.

HOW TO TELL WHEN YOU HAVE MAIL

There are two ways to tell if you have mail, depending on whether the DSS® receiver is turned on or off.

- If the DSS® receiver is turned on, a mail icon appears in the upper right corner of the channel marker.
- If the DSS® receiver is turned off, the power light on the front panel of the receiver flashes.

CHECKING YOUR MAIL

Select Mailbox on the Main menu to view your mail.

1. Point to a message and press MENU•SELECT. The message is opened for you to read.

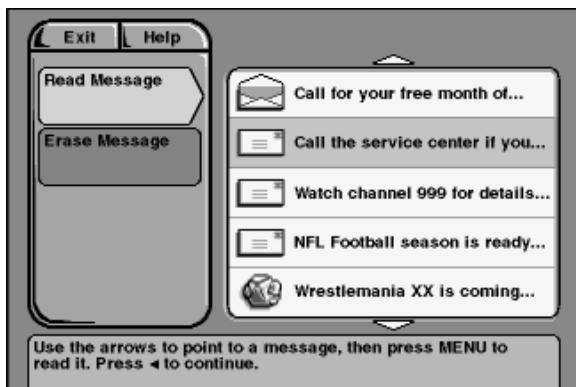

The Mail menu.

2. Press MENU•SELECT again to close the letter.

After you read a message and want to erase it, point to Erase and press MENU•SELECT. When you exit the display screen, messages not erased are saved in memory.

Is your ON/OFF Light Flashing?

Don't worry, your receiver's not broken. It means that you have mail.

MORE FEATURES

MAILBOX SIZE

The mailbox has enough memory to store as many as ten (10) 200-character messages. You should periodically review and erase your mail messages to prevent any mail messages from being erased by the system when memory runs low.

ALTERNATE AUDIO PROGRAMS

Alternate Audio allows you to select different audio programs (when available) to be played with the video. For example, audio broadcast in a second language may be available for certain programs.

There are two ways to change the audio:

- Press ALT AUD on the remote.
- Point to Alternate Audio from the Preferences menu and press MENU•SELECT.

ALT AUD Remote Button

Temporary audio selections are made by pressing ALT AUD on the remote. All the available audio types are selected one after another as you continue pressing the ALT AUD button. Once selected, the chosen audio remains selected until it is changed or until the DSS® receiver is turned off.

Alternate Audio Display Screen

When you select Alternate Audio from the *Preferences* menu, the Alternate Audio display screen comes up.

Point to the audio program type you want and press MENU•SELECT. A check mark next to the program means you have selected that program. The DSS® system will then automatically set the audio program to the selected audio program type when that type is available.

MORE FEATURES

PICTURE SIZE

The Picture size display screen allows you to choose between a standard TV screen and a Cinema option. A standard TV screen has an aspect ratio of 4:3; the Cinema option has an aspect ratio of 16:9.

You should only use the Cinema option if you have a CinemaScreen® TV; using the Cinema option on a standard TV screen could crop the picture.

SYSTEM TEST

The System Test display screen is accessed through the *Options* menu, and allows you to initiate diagnostic procedures on the DSS® system. You should use this feature to get your Access Card number, or when your receiver doesn't seem to be working correctly. There are four separate tests: signal, tuning, phone connection, and access card.

A message screen appears, telling you whether the system passed each test. If your system fails a test, run the system test several times before concluding that there is a problem. Occasional fluctuations in the phone line or satellite signal can give temporary false readings.

NEW ACCESS CARD SETUP

Periodically, your program provider may issue you a replacement access card. The New Access Card Setup display screen allows you to transfer the information from the old card onto the new one.

Follow the display screen prompts to initialize your new card. Once you have transferred the information to the new card, your old card becomes invalid.

Because your specific account information and custom settings are stored in the access card, power failures should have no effect on your DSS® system.

MORE FEATURES

USING ON-LINE HELP

On-line Help is available for all of the menus and display screens. The System provides Auto Help, Help buttons, and Menu Help.

AUTO HELP

Most menus contain a short description of that menu.

HELP BUTTONS

Help buttons appear in many display screens. To see information about the display screen you are using, point to the Help button and press MENU•SELECT.

Press MENU•SELECT again to remove the message from the screen.

MENU HELP

Select *About DSS* from the *Assistance* menu to choose from a list of on-line Help topics. Point and select to find out about the specific parts of the DSS® system, then use the right arrow key to continue through each of the Help screens or press MENU•SELECT to return to the Help menu.

Program Guide shows a screen-by-screen overview of the Program Guide features.

Menu System shows a screen-by-screen overview of the DSS® menu system.

Remote Control shows an on-screen display of the remote control. Point to the different remote buttons to see a brief description of the highlighted button.

Front Panel shows an on-screen display of the DSS® receiver front panel. Point to the different front panel features to see a brief description of the highlighted feature.

Back Panel shows an on-screen display of the DSS® receiver back panel. Point to the different back panel features to see a brief description of the highlighted feature.

Glossary shows a list of common DSS® and TV terms. Point to a glossary item to see a brief description.

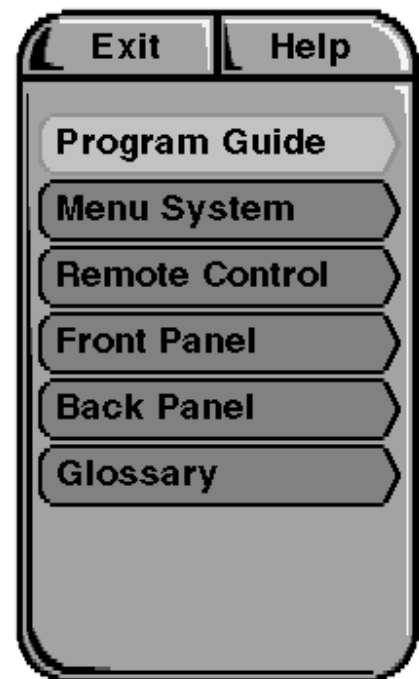

Use the *About DSS* menu (within the Assistance menu) to learn more about your system.

THINGS TO KNOW BEFORE CONNECTING COMPONENTS

Protect Your Components from Power Surges

- Connect all components before plugging any power cords into the wall outlet.
- Always turn off the DSS® receiver, TV and other components before you connect or disconnect any cables.

Position Cables Correctly to Avoid Audio Hum or Interference

- Insert all cable plugs firmly into their jacks.
- Place the audio/video cables to the sides of the TV's back panel instead of straight down the middle after you connect your components.
- Try not to coil any twin-lead cables and keep them away from the audio/video cables as much as possible.
- Make sure all antennas and cables are properly grounded. Refer to the Safety Tips sheet packed with your unit.

Protect Your Components from Overheating

- Do not block ventilation holes in any of the components. Arrange the components so that air can circulate freely.
- Do not stack components.
- Allow adequate ventilation when placing your components in a stand.
- Place an amplifier or DSS® receiver on the top shelf of the stand so heated air rising from it will not flow around other components.

CONNECTIONS

CONNECTING YOUR DSS® RECEIVER TO YOUR TV

If your DSS® system has not been professionally installed, or if you move your system or add a component, refer to these pages to help you connect your system.

JACKS AND CABLES

S-Video Jack and Cable (S-VHS)

The S-Video jack provides the best picture quality for your DSS® system.

This jack is available on many TVs and is used in conjunction with audio cables to connect the DSS® receiver to your TV. Remember also to connect the left and right audio cables because the S-Video jack carries only the picture signal, not the sound.



S-Video Jack

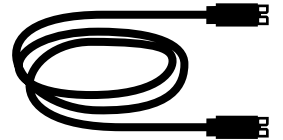

Audio/Video Jacks and Cables (RCA-type)

The audio/video jacks provide very good picture and stereo sound quality, and should be used if your TV has no S-Video jack.

These jacks are used for most audio/video connections between components. The DSS® receiver audio/video jacks are color coded (yellow for video, red for right audio, and white for left audio). If your TV has only one input for audio (mono), connect it to the right (red) audio jack on the DSS® receiver.



Audio/Video Jack

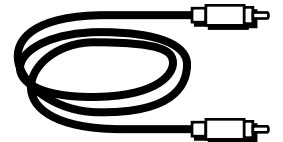

RF Jacks and Coaxial Cables (F-type)

The RF jacks provide good picture and mono sound quality, and are to be used if audio/video connections are not available for your TV.

These jacks are required for antenna or cable-TV connections. The RF jacks on the DSS® receiver are labeled IN FROM ANT and OUT TO TV. The coaxial cable supplied with your DSS® system is used to connect the RF jacks between the DSS® receiver and your TV's antenna input.



RF Jack

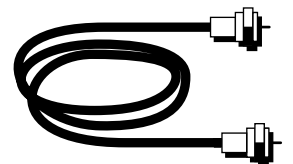

CONNECTIONS

CHOOSING A CONNECTION

The following pages show four examples of hookups commonly used to connect the DSS® receiver with a TV and other components. Refer to your TV and VCR Owner's Manuals for more information on hooking up your specific components.

Connection A

Provides the best possible picture and stereo audio quality.

To use Connection A, you must have:

- TV with S-Video input, plus separate RF and audio/video inputs (jacks).
- VCR with RF inputs and outputs
- S-Video, coaxial, and audio/video cables

Connection B

Provides very good picture and stereo audio quality.

To use Connection B, you must have:

- TV with separate RF and audio/video inputs (jacks)
- VCR with RF inputs and outputs (jacks)
- Coaxial and audio/video cables

Connection C

Provides good picture and mono audio quality.

To use Connection C, you must have:

- TV with RF input (jack)
- VCR with RF input (jack)
- Coaxial and audio/video cables

Connection D

Provides good picture and mono audio quality.

To use Connection D, you must have:

- TV with RF input (jack)

CONNECTIONS

CONNECTION A

BEST PICTURE AND SOUND QUALITY

To use this connection you must have:

- TV with separate RF, audio/video, and S-Video inputs (jacks)
- VCR with RF inputs and outputs (jacks)
- Coaxial, audio/video, and S-Video cables

To connect TV, VCR and antenna or cable box.

1. Connect coaxial cables as shown.
2. Connect audio/video cables as shown.
3. Connect S-Video cable as shown.

To receive DSS® programming:

1. Tune TV to receive the S-Video output from the DSS® receiver.
2. Tune DSS® receiver to desired channel.

To receive off-air programming (no cable box):

1. Turn off VCR and DSS® receiver.
2. Tune TV to desired channel.

To receive off-air programming (with cable box):

1. Turn off VCR and DSS® receiver.
2. Tune TV to cable box output channel (usually CH2, CH3, or CH4).
3. Tune cable box to desired channel.

To record DSS® programming:

1. Tune TV to receive S-Video output from DSS receiver.
2. Tune DSS® receiver to desired channel.
3. Set your VCR to record on DSS® output channel (CH3 / CH4).

To view VCR programming:

1. Tune TV to VCR output channel (usually CH3 or CH4).

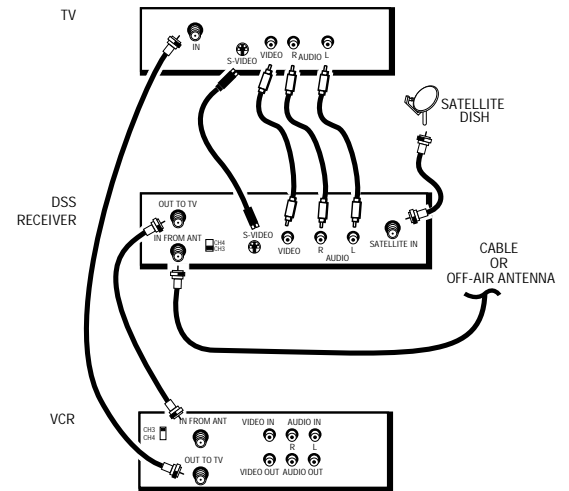

CAUTION

Do not stack electronic components or other objects on top of the DSS® receiver. See Safety Information, inside front cover.

CONNECTIONS

CONNECTION B

VERY GOOD PICTURE AND SOUND QUALITY

To use this connection you must have:

- TV with separate RF and audio/video inputs (jacks)
- VCR with RF and audio/video inputs
- Coaxial and audio/video cables

To connect TV, VCR and antenna or cable box.

1. Connect coaxial cables as shown.
2. Connect audio/video cables as shown.

To receive DSS® programming:

1. Tune TV to receive line output from DSS® receiver (often called Input 1).
2. Tune DSS® receiver to desired channel.

To receive off-air programming (no cable box):

1. Turn off VCR and DSS® receiver.
2. Tune TV to desired channel.

To receive off-air programming (with cable box):

1. Turn off VCR and DSS® receiver.
2. Tune TV to cable box output channel (usually CH2, CH3, or CH4).
3. Tune cable box to desired channel.

To record DSS® programming:

1. Tune TV to record line output from DSS® receiver (Input1).
2. Tune DSS® receiver to desired channel.
3. Set your VCR to record on DSS® output channel (CH3 / CH4).

To view VCR programming:

1. Tune TV to VCR output channel (usually CH3 or CH4).

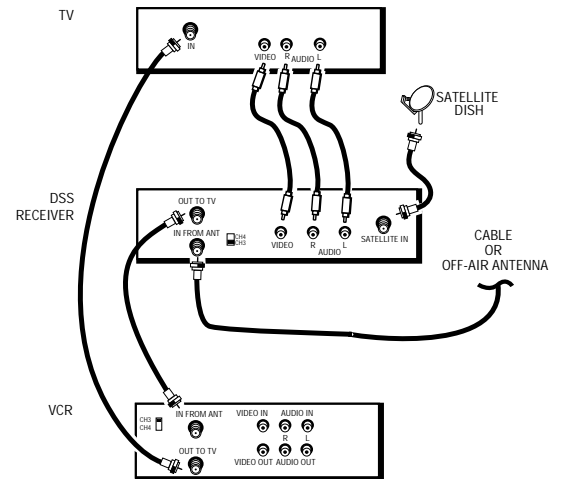

CAUTION

Do not stack electronic components or other objects on top of the DSS® receiver. See Safety Information, inside front cover.

CONNECTIONS

CONNECTION C

GOOD PICTURE AND SOUND QUALITY

To use this connection you must have:

- TV with RF input (jack)
- VCR with RF and audio/video inputs
- Coaxial and audio/video cables

To connect TV, VCR, and antenna or cable box.

1. Connect coaxial cables and audio/video cables as shown.

To receive DSS® programming:

- Tune TV to channel 3 or 4 (depending on how you set the CH3/CH4 switch on the back of the DSS® receiver).

To receive off-air programming (no cable box):

1. Turn off VCR and DSS® receiver.
2. Tune TV to desired channel.

To receive cable programming (with cable box):

1. Turn off VCR and DSS® receiver.
2. Tune TV to cable box output channel (usually CH2, CH3, or CH4).
3. Tune cable box to desired channel.

To record DSS® programming:

1. Tune TV to the channel on which you receive the DSS® signal.
2. Tune DSS® receiver to desired channel.
3. Set VCR to record on line input.

To view VCR programming:

1. Tune TV to VCR output channel (usually CH3 or CH4).
2. Turn DSS® receiver off.

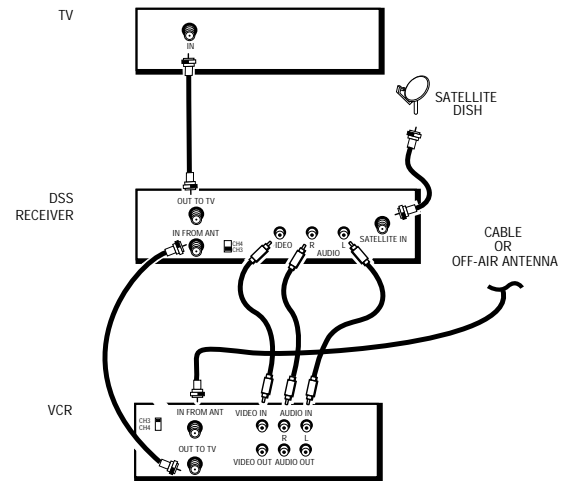

CAUTION

Do not stack electronic components or other objects on top of the DSS® receiver. See Safety Information, inside front cover.

CONNECTIONS

CONNECTION D

GOOD PICTURE AND SOUND QUALITY

To use this connection you must have:

- TV with RF input
- Coaxial cables

To connect TV and antenna or cable box:

1. Connect coaxial cables as shown.

To receive DSS® programming:

- Tune TV to channel 3 or 4 (depending on how you set the CH3/CH4 switch on the back of the DSS® receiver.

To receive off-air programming (no cable box):

1. Turn off VCR and DSS® receiver.
2. Tune TV to desired channel.

To receive cable programming (with cable box):

1. Turn off VCR and DSS® receiver.
2. Tune TV to cable box output channel (usually CH2, CH3, or CH4).
3. Tune cable box to desired channel.

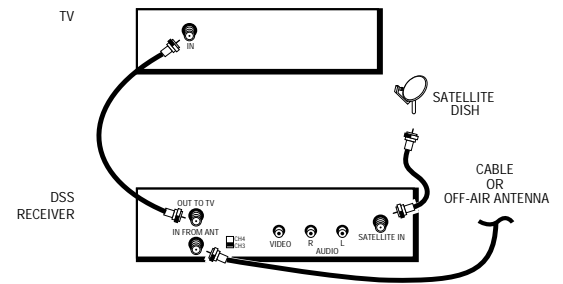

CAUTION

Do not stack electronic components or other objects on top of the DSS® receiver. See Safety Information, inside front cover.

INTERACTIVE SETUP

If you self-installed your satellite dish, you may have already used the interactive setup to find the dish pointing coordinates, acquire and fine-tune the signal, and run a system test.

If you need to run the interactive setup again, go to the *Assistance* menu and select *Setup*.

If you just want to check your dish pointing coordinates, or run the signal strength meter, select *Dish Pointing* from the Main menu.

DISABLING INTERACTIVE SETUP

The Interactive Setup menus automatically appear on-screen the first time you plug in your receiver, and when power is restored after a power loss.

The final step of the Interactive Setup allows you to disable the automatic appearance of the Interactive Setup.

To enable it again, select *Setup* from the *Assistance* menu and then follow the Interactive Setup routine until the end, where you can choose to enable the automatic feature.

REFERENCE

DSS® SYSTEM OVERVIEW

Although the DSS® system is simple to use, there are a number of parts in the system. Don't be overwhelmed. This section explains how these different parts work together to bring a picture to your screen.

CONTROLS AND BUTTONS

This section also describes the controls located on the front and back of the receiver.

PROGRAMMING THE REMOTE CONTROL

This section tells you how to program the remote to control most brands of remote controllable televisions.

REFERENCE

PARTS OF THE DSS® SYSTEM

One way to understand the DSS® system is to look at the different parts of the system—from the studio down to the DSS® receiver and remote control in your living room.

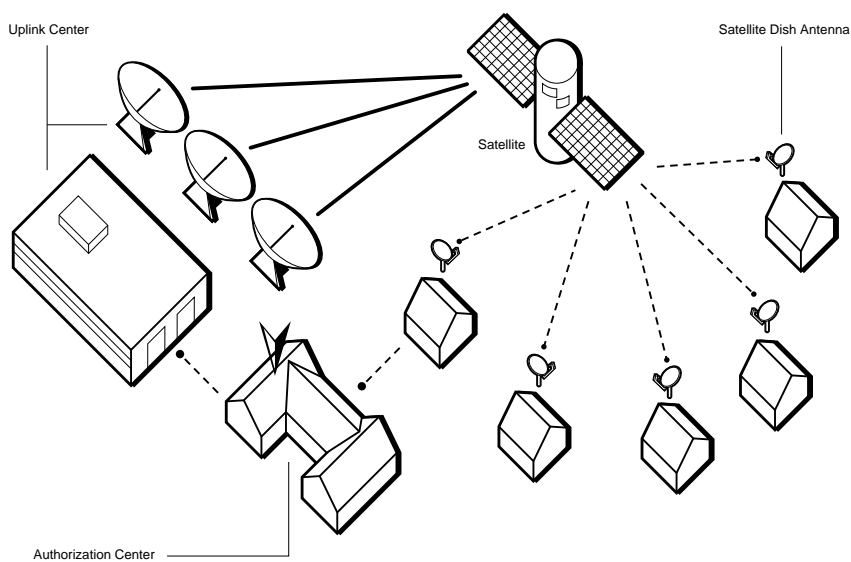

WORLD VIEW

These parts make up the DSS® system “big picture.”

Uplink Center Transmits programming up to the satellite.

Satellite Relays the programming signals back to your satellite dish. The satellite is parked above the equator, in geostationary orbit 22,300 miles above the earth.

DSS® Satellite Dish Antenna Receives the satellite signals. Because the satellite is so powerful, the dish can be as small as 18 inches.

Program Provider Authorization Center Processes billing statements. Your DSS® system is linked to the Service Center through the phone jack on the back of your DSS® receiver.

REFERENCE

HOME VIEW

These parts are inside of or attached to your house.

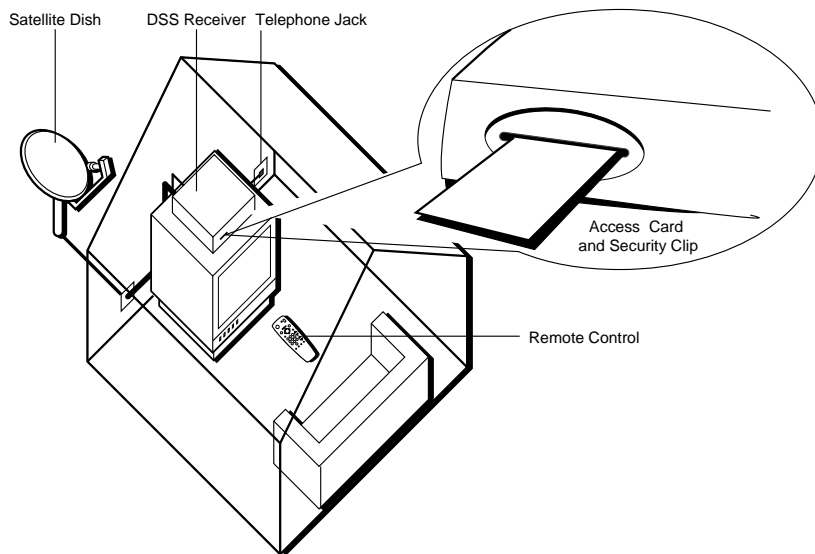

DSS® Satellite Dish Picks up the satellite's coded program information and relays it to your DSS® receiver. (Your satellite dish may be installed in different locations on or around your house. The satellite dish must, however, be pointed in a southern direction toward the satellite.)

DSS® Receiver Receives the TV program information and sends it to your TV or VCR.

Telephone Jack Connects to the phone jack on the back of the DSS® receiver. The DSS® receiver uses a toll-free number once a month to update your access card. This update only takes a few seconds and ensures that you will have continuous service. The system automatically hangs up if you pick up the phone when the DSS® receiver is calling out.

Television If your television is remote controllable, you can program the DSS® Universal TV Remote to change channels and volume.

DSS® TV Universal Remote (included with your DSS® system) Controls the DSS® system as well as most remote controllable TVs, VCRs, and other devices. Point the remote at the device you want to control.

Access Card (installed in DSS® receiver) Must be inserted for you to use the DSS® system! Provides system security and authorization of DSS® services. Do not remove the card except when issued a new card as a replacement for the original.

REFERENCE

FRONT PANEL CONTROLS



ON/OFF Turns the DSS® receiver's power on or off.

DISPLAY Brings up the on-screen channel marker.

ANTENNA Switches the source of the video signal from satellite signals to an off-air antenna or cable signal.

ARROWS Press the navigation arrows to move the on-screen highlight up, down, left, or right. Using the arrows to highlight a menu item is also called "pointing."

MENU•SELECT Brings up the Main menu. If you are already in the menu system, press MENU•SELECT to select a highlighted choice.

ACCESS CARD Identifies you to your program providers. The DSS® system requires a valid access card.

BACK PANEL

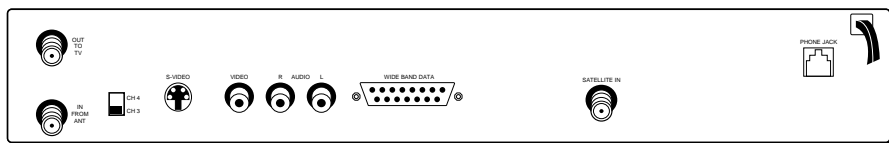

IN FROM ANT Use to connect an off-air antenna or cable TV signal to the DSS® system.

OUT TO TV Use to connect the DSS® receiver to your TV. However, if your TV has audio/video jacks, you should use those jacks to get better picture and sound quality.

CH3/CH4 SWITCH If a coaxial cable is used to connect the DSS® receiver to your TV, you must set the CH3/CH4 SWITCH. For example, to see the DSS® signal on TV channel 3, set the switch to 3.

S-VIDEO Provides the best picture quality. If your TV has S-VIDEO capability, use this jack along with the audio/video jacks to connect the DSS® receiver to your TV.

VIDEO Provides better picture quality than the OUT TO TV jack. If your TV has audio/video capability, use this jack to connect the DSS® receiver to your TV. You must also connect the AUDIO jacks.

AUDIO (R and L) Provide better sound quality than the OUT TO TV jack. If your TV has audio/video capability, use these jacks to connect the DSS® receiver to your TV. You must also connect the VIDEO jack.

WIDE BAND DATA PORT This port allows you to connect the DSS® system to future services and accessories as they become available. A shielded cable and additional hardware may be required.

SATELLITE IN Use to connect the DSS® receiver to the satellite dish.

PHONE JACK Use to connect a phone line to the DSS® receiver. The DSS® system requires a phone line connection to periodically call out to program providers.

REFERENCE

REMOTE CONTROL BUTTONS

OFF•ON Turns the device you are controlling on or off.

TV Tells the remote to control the TV.

DSS Turns on the DSS® receiver and tells the remote to control DSS® system functions.

DISPLAY Brings up the on-screen channel marker.

MENU•SELECT Brings up the Main menu. If you are already in the menu system, press MENU•SELECT to select a highlighted choice.

ARROWS Use the navigation arrows to move the on-screen highlight up, down, left, or right. Using the arrows to highlight a menu item is also called “pointing.”

GUIDE Brings up the on-screen program guide. Press the GUIDE button several times to toggle through the different types of guides.

PREV CH Moves you back and forth between your last two selected channels.

CLEAR Removes the on screen displays and return to normal viewing.

DIGIT KEYS (0 - 9) Use the digit keys to tune directly to a channel. If you are in the menu system, use the digit keys to enter numbers for the time, date, channel and passwords.

CHAN UP/DOWN Use to scan up and down through the channels in the current channel list. If you are in the program guide or menu system, use the CHAN UP/DOWN buttons to page up and down a screen at a time.

VOL UP/DOWN Adjusts the audio volume.

MUTE Turns off the sound. Press again to restore the sound.

ALT AUD (Alternate Audio) Use to toggle through the available languages or audio types for a program.

FAV•INPUT In TV mode, press the FAV•INPUT button one or more times to toggle through the available video inputs connected to the TV. In DSS® mode, press the FAV•INPUT button one or more times to toggle through the favorite channel lists.

ANT Lets you switch the source of the video signal from DSS® satellite signals to an off-air antenna or cable signal.

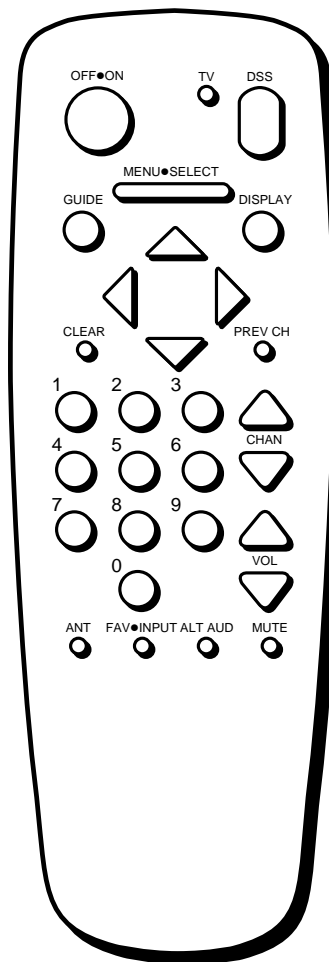

REFERENCE

PROGRAMMING THE REMOTE CONTROL

The DSS® remote can be programmed to control most brands of remote controllable televisions.

PROGRAMMING THE REMOTE TO CONTROL A TV

To determine whether the remote needs to be programmed, turn the TV on, point the remote at the TV, and press the TV button. Then press CHAN UP or DOWN to see whether the TV responds to the remote commands.

Follow these steps to program your remote to control your TV.

1. Turn on the TV.
2. Look up your brand and code number(s) on the TV Code list on page 51.
3. Press and hold the TV button.
4. Enter the three-digit code from the code list.
5. Release the TV button and press OFF•ON or CHAN UP/DOWN to see if the TV responds to the remote commands. If it doesn't, try the next code listed for your brand.
6. Repeat these steps until the TV responds to the remote commands.

USING THE REMOTE BUTTONS TO CONTROL A TV

Once the remote has been programmed with the correct codes, you are ready to use it to control your TV.

To operate the device:

1. Press the TV button to set the remote to control the TV.
2. Press OFF•ON to turn the TV off or on.
3. Use the remote buttons to control the TV.

This remote may not operate all models of the brands that are shown. Use the codes shown in this manual, or on the sheet packed with your remote.

After you program the remote to control your TV, record your TV code here for easy reference.



REFERENCE

REMOTE CODES

TV Codes

Akai	002	Kloss Novabeam	035, 043	Realistic	021
Anam National	038	KTV	078	Sampo	011, 027
AOC	011, 019, 027, 088	Loewe	013	Samsung	006, 011, 014, 015, 019, 027, 036, 037, 077
Candle	011, 027, 033	Luxman	011, 027	Sanyo	017, 021, 039, 056, 057, 058
Citizen	011, 027, 033, 064	LXI	013, 018, 021, 023, 054	Scott	028, 037, 064
Colortyme	011, 027, 084	Magnavox	006, 007, 010, 011, 013, 016, 027, 033, 035, 043, 049, 066, 087, 089	Sears	000, 006, 011, 014, 017, 018, 021, 023, 027, 039, 040, 041, 051, 071, 083
Concerto	011, 027	Marants	013	Sharp	011, 020, 025, 027, 037, 052, 053, 059, 060
Contec/Cony .	036, 037, 040, 042, 064	Marantz	011, 013, 027, 069	Sony	002
Craig	064	MGA	006, 011, 014, 019, 022, 027, 041, 056, 061, 068	Soundesign	011, 027, 033
Curtis Mathes .	000, 011, 015, 027, 037	Mitsubishi	006, 011, 014, 019, 022, 027, 041, 055, 056, 061, 068	Sylvania	006, 007, 010, 011, 013, 016, 027, 033, 035, 043, 049, 066, 087, 089
CXC	064	MTC	011, 019, 027	Symphonic	064, 076
Daewoo	011, 019, 027	Multivision	081	Tatung	038
Daytron	011, 027	NAD	018, 023	Technics	012
Electrohome ...	006, 011, 014, 027, 038, 061, 068	NEC	011, 014, 019, 027, 038, 084	Techwood	011, 027
Emerson	011, 026, 027, 028, 029, 030, 031, 032, 037, 042, 053, 064, 065, 067, 075, 076, 078, 079	Panasonic	012, 013, 038, 086	Teknika	011, 019, 027, 033, 036, 037, 040, 066
Envision	011, 027	Penney	000, 008, 011, 019, 027, 040, 068, 077, 086, 088	Telecaption	090
Fisher	017, 021, 039, 041	Philco	006, 007, 010, 011, 013, 016, 019, 027, 033, 035, 037, 038, 043, 087, 089	TMK	011, 027
Funai	064	Philips ...	002, 006, 007, 010, 011, 013, 016, 033, 035, 037, 038, 043, 066, 073	Toshiba	018, 021, 023, 040, 071, 077, 085
GE	000, 008, 009, 011, 012, 027, 038, 068, 086, 089, 091	Pioneer	011, 027, 045, 062, 093	Universal	008, 009
Goldstar	003, 004, 006, 011, 019, 027, 037, 050	Portland	011, 019, 027, 037	Victor	051
Hallmark	011, 027	ProScan	000	Vidtech	019, 027
Hitachi	009, 011, 027, 036, 037, 040, 047, 063, 080	Proton	011, 027, 037, 072	Wards	000, 005, 006, 007, 008 009, 010, 011, 013, 019, 025, 027, 028, 035, 043, 059, 066, 076, 082, 089
Infinity	013	Quasar	012, 038, 092	Yamaha	006, 014, 019, 027
JBL	013	Radio Shack .	000, 021, 025, 036, 037, 059, 064, 078	Zenith	001
Jensen	011, 027	RCA	000, 006, 011, 012, 019, 027, 034, 038, 044, 046, 072, 088, 100		
JVC	012, 024, 036, 037, 040, 048, 051, 074				
Kawasho	002, 011, 027				
Kenwood	006, 011, 014, 027				

REFERENCE

GLOSSARY

The following is a list of terms used in this manual. There is also a glossary contained within the Assistance menu of your DSS® system.

Access Card

Identifies you to the DSS® service providers and is required for your DSS® system to work. Do not remove the access card except when a new card has been issued to replace the original.

Alternate Audio

Refers to the different audio channels that may be broadcast in conjunction with a video program. A foreign language translation is an example.

ANT Button

Remote control buttons that toggles the input signal to your TV from the antenna or cable signals to the satellite signal. Similar in function to that of TV/VCR buttons on some VCRs and remote controls.

Attractions

Previews of special programs broadcast by your program provider.

Azimuth

Refers to the left-to-right positioning of your DSS® dish. When you enter your zip code (or latitude and longitude), the display screen provides the number corresponding to an azimuth setting for your location.

DSS® Receiver

Receives, processes, and converts the digitally compressed satellite signals into audio and video.

Elevation

Refers to the up and down positioning of your DSS® dish. When you enter your zip code (or latitude and longitude), the display screen provides the number corresponding to the elevation setting for your location.

Limits

There are three kinds of limits. The Ratings Limit allows you to control program viewing of rated programs by ratings level. The Spending Limit controls spending on a cost-per-program basis. The Parent Approved channel list allows you to select which channels can be viewed when the system is locked.

Locks

The means of restricting access to certain features of the DSS® system. The lock is controlled by a 4-digit password. The closed or open lock icon in the channel marker indicates whether your system is locked or unlocked.

Mailbox

Stores incoming electronic messages sent to you by your program providers. The Mailbox is accessed through the on-screen menu system, and can store up to ten messages of forty characters each.

REFERENCE

Main Menu

The first list of choices in the DSS® on-screen menu system. Press the MENU button on the remote or front panel to bring up the Main menu.

Past Purchases

Detailed list of the programs that you have already purchased and viewed.

Point and Select

The method of using the remote control (or front panel) buttons to navigate to and make choices among the different parts of the on-screen displays.

Program Guide

Lists and updates the programs and services available from your program providers.

Ratings Limit

Provides a means of restricting viewing of rated programs, based on program rating information. The operation of this feature depends upon the availability and accuracy of data supplied from and broadcast by the program provider.

Signal Meter

An on-screen display that indicates the relative strength of the satellite signal and sounds a test tone to help you lock in on the satellite signal. The signal meter is used when you adjust your DSS® dish.

Spending Limit

Provides a means of restricting viewing; based on cost-per-program limit.

System Test

Provides a diagnostics check that can be used to determine that the main components of the DSS® system—signal, tuning, phone, and access card—are connected and working properly.

Themes

Provides a way to simplify the Program Guide and make it easier to find programs of special interest to you.

Upcoming Purchases

Detailed list of the programs you have purchased but have not yet been broadcast.

REFERENCE

TROUBLESHOOTING

The DSS® System Test allows you to run a basic diagnostics check on your DSS® system. If you are experiencing any trouble with your system, run the system test.

Make sure that

- All connections—jacks, cables, etc. are correctly in place. See *Connecting Your DSS® Receiver*, page 46, for more information.
- There are batteries in the remote, and that they are working correctly.
- The access card is installed in the receiver.

RUNNING THE SYSTEM TEST

Follow these steps to run the diagnostics system test on your system.

1. Turn on your TV and the DSS® receiver.
2. Press DSS® to put remote in DSS® mode, then press MENU•SELECT to bring up the Main menu.
3. Point to and select Options.
4. Point to and select System Test. Follow the on-screen directions after the test is completed.
5. If your system does not pass the system test, check any of these potential trouble areas: cabling, pointing the satellite dish, phone connection, and access card.
6. If you continue to have problems, call 1-800-679-4776.

APPENDIX A: WARRANTY INFORMATION

TOLL-FREE TELEPHONE PRODUCT HELP

You can reach Thomson Consumer Electronics at the following number:

1-800-679-4776 (Toll free inside U.S.A.)

Our toll-free DSS® System number operates from

8:00 a.m. to 10:00 p.m. EST on weekdays and

10:00 a.m. to 10:00 p.m. EST Saturday and Sunday.

Thomson provides a toll-free telephone number to help you with any problems you may encounter with your DSS® System, as many problems can be diagnosed over the phone. If necessary, a replacement unit can be shipped to you. **Please have your DSS® System model/serial number and date of purchase ready when you call.** If your unit is out of warranty, we will quote the cost of an exchange unit to you.

Returning Equipment to Thomson for Repair or Exchange

If we are unable to resolve your problem over the phone we will gladly service your unit or exchange it for a new or refurbished unit. Refer to the limited warranty included in the booklet to learn about your specific rights and responsibilities. *Always consult Thomson and get a Return Authorization number before returning anything.* Obtain a Return Authorization (RA) number from the telephone representative before returning your equipment to avoid delays, accounting errors, or even loss of your unit.

Important Information to Customers Who Ship Defective Equipment to Thomson Consumer Electronics

The Thomson representative who authorizes the return of your equipment will give you an RA number over the phone. The representative will also provide you with instructions on where and how to return your unit. Write the number in large, clear characters on the outside of the box. *To avoid confusion and misunderstandings, shipments without an RA number clearly visible on the outside of the box will be returned to you at your expense.*

Include a brief note describing the problem and any conversations you have had with Thomson personnel about the problem. Include your name, address and model/serial number of your unit. These numbers are located on the back of your receiver. If your DSS® System is within the warranty period, please provide a copy of the bill of sale to verify purchase date. Use the original box and packing material to protect the equipment from damage in shipment. ***For your protection, insure all shipments for full replacement value and use a reliable shipper.*** Thomson assumes no responsibility for warranty shipments from the customer to the factory if not shipped in the manner prescribed by Thomson.

DIGITAL SATELLITE SYSTEM (DSS®) LIMITED WARRANTY

WHAT YOUR WARRANTY COVERS:

- Any defect in materials or workmanship.
- Basic installation, provided installation is performed by a Thomson Consumer Electronics Authorized Installer.

FOR HOW LONG AFTER YOUR PURCHASE:

- 90 days - Installation which includes parts and labor.
- 90 days - Unit exchange, which includes parts and labor.
- 91 days to 1 year – Unit exchange, which includes parts only; you pay the labor.
(The warranty period for rental units begins with the first rental or 45 days from date of shipment to the customer, whichever comes first.)

APPENDIX A: WARRANTY INFORMATION

WHAT WE WILL DO:

- **During the initial 90 days:**

Exchange the defective portion of your DSS® with a new or, at our option, refurbished unit and correct any basic installation defects at no cost to you.

- **After the 90 days and within one year:**

Exchange the defective portion of your DSS® with a new or, at our option, refurbished unit. We will bill you a flat exchange charge to replace a defective receiver. This charge covers the labor cost for its repair. Labor costs for the removal and re-installation of any equipment are your responsibility.

HOW YOU GET SERVICE:

- Call 1-800-679-4776 and have your unit's date of purchase and model/serial number ready. The model/serial number information is on the back of your receiver.
- A representative will troubleshoot your problem over the phone.
- If the representative determines that you should receive a replacement receiver you will be provided with a Return Authorization (RA) number and the location of a nearby exchange point if one exists. No returns will be accepted without the RA number.
- If the representative determines that your antenna/dish is defective they will arrange for its repair or replacement.
- If the representative determines that installation is defective they will arrange for its repair.

To receive a replacement receiver before your return yours:

If you are located near an exchange point:

1. We will send a replacement unit to our exchange point next business day delivery in the continental USA.
2. The exchange location will notify you of its arrival.
3. Take your unit and your evidence of purchase date, such as a bill of sale, to the exchange location and you will be provided the new or refurbished unit. Please retain all accessories such as the remote control hand unit.
4. If the repairs are covered by your warranty, you will not be billed.

If you are *not* located near an exchange point:

1. Provide your Discover, Mastercard, or Visa account number and expiration date to your phone representative. This is for security purposes only and your account will not be charged at this time.
2. We will send you a replacement unit next business day delivery in the continental USA.
3. If you return the unit to us within 14 days from the date you were provided an RA, only items not covered by warranty will be charged to your account. If your unit is not received within 14 days, the suggested retail value of the receiver will be charged to your credit card. This amount will be credited if the unit is subsequently received.
4. Ship your defective unit back to us using the replacement unit's carton. Shipping instructions will be included on the carton along with your RA number which will allow you to easily ship the unit back to us. Make sure you insure your shipment in case of damage or loss. Include with the shipment:
 - Evidence of purchase date such as a bill of sale.
 - A brief note describing the receiver's problem.
 - Your name, address, and phone number.

Thomson assumes no responsibility of warranty shipments from the customer to the factory if not shipped in the manner prescribed by Thomson.

APPENDIX A: WARRANTY INFORMATION

To receive a replacement receiver after we have received your unit:

- Write the RA number on the outside of the carton used to return the unit. Make sure you insure your shipment in case of damage or loss.
- Carefully pack the unit using the original box and packing material if possible. Please retain all accessories that were included with your unit such as the remote control hand unit.
- Include with the shipment:
 - Evidence of purchase date such as a bill of sale.
 - A brief note describing the receiver's problem.
 - Your name, address, and phone number.
- Include a cashier's check or money order for payment if there are any out of warranty labor or parts charges which were indicated by the representative, and you elect not to use your credit card.
- After we receive your product, a new or refurbished unit will be shipped to you next business day delivery in the continental USA.

WHAT YOUR WARRANTY *DOES NOT* COVER:

- Acts of God, such as but not limited to lightning damage.
- Adjustment of customer controls.
- Damage from misuse or neglect.
- A unit that has been modified or incorporated into other products or is used for institutional or other commercial purposes.
- Batteries.
- Units purchased, serviced, or operated outside the USA. Only the DSS® receiver is covered by this warranty if the system is purchased in the state of Alaska.
- Loss of programming.
- Shipping damage if the unit was not packed and shipped in the manner prescribed by Thomson.
- Storage fees may be charged by the exchange point if you fail to pick up the replacement unit in a timely manner.
- Any installation other than a basic installation. A basic installation consists of:
 - Antenna mounted to a single family dwelling using 100 ft. or less of cable.
 - Antenna grounded to meet National Electrical Code (NEC).
 - Routing of the cabling through a normal frame structure or only one layer of masonry.
 - One TV connected to the antenna.
 - A telephone cable and connection installed at the connected TV.
- Installations performed by anyone other than Thomson Consumer Electronics Authorized Installers.

PRODUCT REGISTRATION:

- Please complete and mail the Product Registration Card packed with your DSS® product. It will make it easier to contact you should it ever be necessary. The return of the card is not required for warranty coverage.

HOW STATE LAW RELATES TO THIS WARRANTY:

- This warranty gives you specific legal rights and you may have other rights that vary from state to state.

IF YOU PURCHASED YOUR PRODUCT OUTSIDE THE USA:

- This warranty does not apply. Contact your dealer for warranty information.

APPENDIX B: FCC REGULATIONS

FCC REGISTRATION INFORMATION

Your DSS® equipment is registered with the Federal Communications Commission and is in compliance with parts 15B and 68, FCC Rules and Regulations.

1. Notification to the Local Telephone Company.

On the bottom of this equipment is a label indicating among other information, the FCC Registration number and Ringer Equivalence Number (REN) for the equipment. You must, upon request, provide this information to your telephone company.

The REN is useful to determine the number of devices you may connect to your telephone line and still have all these devices ring when your telephone number is called. In most (but not all) areas, the sum of the RENs of all devices connected to one line should not exceed 5. To be certain of the number of devices you may connect to your line as determined by the REN, you should contact your local telephone company.

Notes: This equipment may not be used on coin service provided by the telephone company.

Party lines are subject to state tariffs, and therefore, you may not be able to use your own telephone equipment if you are on a party line. Check with your local telephone company.

Notice must be given to the telephone company upon permanent disconnection of your DSS® equipment from your line.

2. Rights of the Telephone Company.

Should your equipment cause trouble on your line which may harm the telephone network, the telephone company shall, where practicable, notify you that temporary discontinuance of service may be required. Where prior notice is not practicable and the circumstances warrant such action, the telephone company may temporarily discontinue service immediately. In case of such temporary discontinuance, the telephone company must: (1) promptly notify you of such temporary discontinuance (2) afford you the opportunity to correct the situation and (3) inform you of your right to bring a complaint to the Commission pursuant to procedures set forth in Subpart E of Part 68, FCC Rules and Regulations.

The telephone company may make changes in its communications facilities, equipment, operations or procedures where such action is required in the operation of its business and not inconsistent with FCC Rules and Regulations. If these changes are expected to affect the use or performance of your telephone equipment, the telephone company must give you adequate notice, in writing, to allow you to maintain uninterrupted service.

RADIO INTERFERENCE

This equipment has been type tested and found to comply with the limits for a Class B Digital Device in accordance with the specifications in Part 15 of FCC Rules. These rules are designed to provide reasonable protection against radio and television interference in a residential installation. This equipment generates, uses and can radiate radio frequency energy and, if not installed and used in accordance with the instructions, may cause harmful interference to radio communications. However, there is no guarantee that interference will not occur in a particular installation.

If this equipment does cause interference to radio or television reception (which you can determine by turning the equipment off and on), try to correct the interference by one or more of the following measures.

- Reorient or relocate the receiving antenna (that is, the antenna for radio or television that is “receiving” the interference).
- Change the position of the DSS® satellite receiver with respect to the radio or television equipment that is receiving interference.
- Move the DSS® satellite receiver away from the equipment that is receiving interference.
- Plug the DSS® satellite receiver into a different wall outlet so that the DSS® satellite receiver and the equipment receiving interference are on different branch circuits.

If these measures do not eliminate the interference, please consult your dealer or an experienced radio/television technician for additional suggestions. Also, the Federal Communications Commission has prepared a helpful booklet, “How To Identify and Resolve Radio/TV Interference Problems”. This booklet is available from the U.S. Government Printing Office, Washington, D.C. 20402. Please specify stock number 004-000-00345-4 when ordering copies.

APPENDIX C: ACCESSORIES

Audio/Video Cables



RG-6 Coaxial Burial Cable with weatherproof "F" connectors

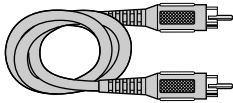

Stereo Audio/Video Cable with gold RCA-type connectors

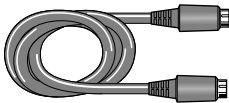

S-VHS Video Cable



(2) Weatherproof "F" Connectors for RG-6 coaxial cable

Miscellaneous Supplies

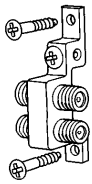

Grounding Block for RG-6 coaxial cable

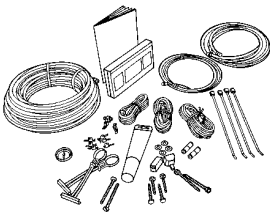

Self-Installer's Kit

Accessory Order Form for DSS® Models

Description	Part No.	Price	Qty	Total
RG-6 Coaxial Cable				
12 feet	D912	\$12.95		
25 feet	D925	\$15.95		
50 feet	D950	\$21.95		
75 feet	D975	\$29.95		
100 feet	D901	\$29.95		
Stereo Audio/Video Cable				
6 feet	D906	\$12.95		
12 feet	D914	\$14.95		
S-Video Cable				
"F" Connector	D905	\$ 5.30		
Grounding Block	D902	\$ 2.95		
TVRO Bullet Amplifier	D903	\$24.95		
Self-Installer's Kit	DKIT94	\$69.95		

Prices are subject to change without notice.

Total Merchandise (\$10 Minimum Order) \$ _____

Sales Tax \$ _____

We are required by law to collect the appropriate sales tax for each individual state, country, and locality to which the merchandise is being sent.

Shipping, Handling, and Insurance \$ 5.00

Total Amount Enclosed \$ _____

Use VISA or MasterCard preferably.

Money order or check must be in U.S. currency only.

No COD or CASH.

Detach Here 

All accessories are subject to availability.
Where applicable, we will ship a superseding model.

Please complete other side also 

APPENDIX C: ACCESSORIES

Charge your order on your VISA or MasterCard by filling in below

USE YOUR CREDIT CARD

IMPORTANT: Copy complete account number from your VISA card



My card expires:

IMPORTANT: Copy complete account number from your MasterCard



Copy Number above your name on MasterCard:

My card expires:

AUTHORIZED SIGNATURE

Prices are subject to change without notice.

PLEASE

Print or type your name and address clearly. This will be your mailing label.

A complete and correct order will save you days of waiting.



Name: _____

Street: _____

_____ Apt: _____

City: _____

State: _____ Zip: _____

To order accessories, follow the instructions below to order by telephone.

United States and Canadian Orders

To place your order by phone, have your Visa or MasterCard ready and call the toll-free number listed below between 8 AM and 8 PM Eastern Standard Time. **Use this number only to place an order for accessory items listed on this order form.**

1 - 800 - 338 - 0376

Most times your order will be shipped UPS within 72 hours of receipt. If ever it is not possible to ship within 30 days, we will notify you with an update on your order and an option to cancel.

To place your order by mail, detach and mail the completed order form with credit card information, money order, or check in U.S. currency (made payable to Thomson Consumer Electronics, Inc.) to the following address:

Video Accessories
P.O. Box 8419
Ronks, PA 17573

For more information on these accessories (or current prices), write to the following address:

Video Accessories Customer Service
Thomson Consumer Electronics, Inc.
Distributor & Special Products
2000 Clements Bridge Rd
Deptford, NJ 08096-2088

International Orders

This offer is valid only in the 50 United States and Canada. For international orders, please send your request for quotation (not an order) to:

International Customer Service
Thomson Consumer Electronics, Inc.
Distributor & Special Products
2000 Clements Bridge Rd
Deptford, NJ 08096-2088

INDEX

A

Access Card 47
 new card setup 34
Access Card number 4
ALT AUD button 33
Alternate audio programs 33
Arrow keys 8
Attractions Guide 13, 29
Audio/video jacks 38
Auto Help 35

B

Back Panel controls 48
 AUDIO (R & L) 48
 IN FROM ANT 48
 OUT TO TV 48
 PHONE JACK 48
 S-VIDEO 48
 SATELLITE IN 48
 VIDEO 48
 WIDE BAND DATA port
 48
Batteries
 installing in the remote 5
Buy and Record Option 29

C

Channel Guide 12
Cinema screen 34
CLEAR button 8, 18
Coming Attractions 29

D

DIRECTV 4
DSS Satellite Dish
 Antenna 46

E

\Exiting a menu 18
Exiting A Program Guide 15

F

Flashing ON/OFF light 32
Front Panel controls 48
 ANTENNA 48
 ARROWS 48
 DISPLAY 48
 MENU•SELECT 48
 ON/OFF 48

G

Grid Guide 12

H

Help 18, 35
Help Buttons 35

I

Interactive setup 44

L

Limited Warranty 55–57

M

Mailbox 32
 checking your mail 32
 deleting mail messages 32
Mailbox size 33
Main menu 18
Menu Help 35
MENU•SELECT button 8
Menus
 Assistance 19
 Dish Pointing 19
 exiting 18
 Mailbox 19
 Options 19
 Program Guide 19
 Purchases 19
 Timers 19
Movies button 14

N

New Access Card Setup 34

O

On-Line Help 35
ON/OFF Light, flashing 32
Ordering programming 4

P

Password, system
 forgetting 26
Past purchases 30
Pay-Per-View Programs 28
Picture size 34
PPV (Pay-Per-View) 28
Program Guide 9
 All Button 14
 Arrow button 13
 Attractions Guide 13
 Channel guide 12
 Exit Button 14
 Grid Guide 12
 Other 14
 scrolling channel
 by channel 10
 scrolling page by page 11
 selecting 11
 selecting from the
 Main Menu 11
 sorting 13
 Sports button 14
 Theme button 14, 15
 tuning to a channel 11
Program Provider
 Authorization Center
 46
Programming the Remote
 50
 to control a TV 50
Purchases menu 30
Purchasing a PPV program
 28

R

Receiver 47
Remote control
 installing batteries 5
Remote Control Buttons 49
Remote Control,
 programming 50
RF jacks 38

S

S-Video jack 38
Satellite 46
Satellite Dish 47
Session unlock 26
Sort button 14
Sorting the Grid Guide 13
Spending limits 23
System controls 25
System Test 34

T

Timer feature 31
 editing or cancelling 31
 setting up 31
Troubleshooting 54
Tuning to a PPV program 28

U

Unlocking the system 26
 temporarily 26
Upcoming purchases 30
Uplink Center 46
USSB 4

W

Warranty information 55-57

If your DSS® system needs service, please contact your dealer or the nearest Servicenter from the yellow pages. Please do not send any products to the Indianapolis address listed in this manual or on the carton. This will only add delays in service for your product.

 **THOMSON CONSUMER ELECTRONICS**
10330 North Meridian Street
Indianapolis, IN 46290

©1996 Thomson Consumer Electronics, Inc.
Trademark(s)® Registered
Marca(s) Registrada(s)
Printed in USA
TOCOM 15087800



100%
RECYCLED PAPER
MINIMUM 50% POST CONSUMER

