

RCA

SATELLITE RECEIVER

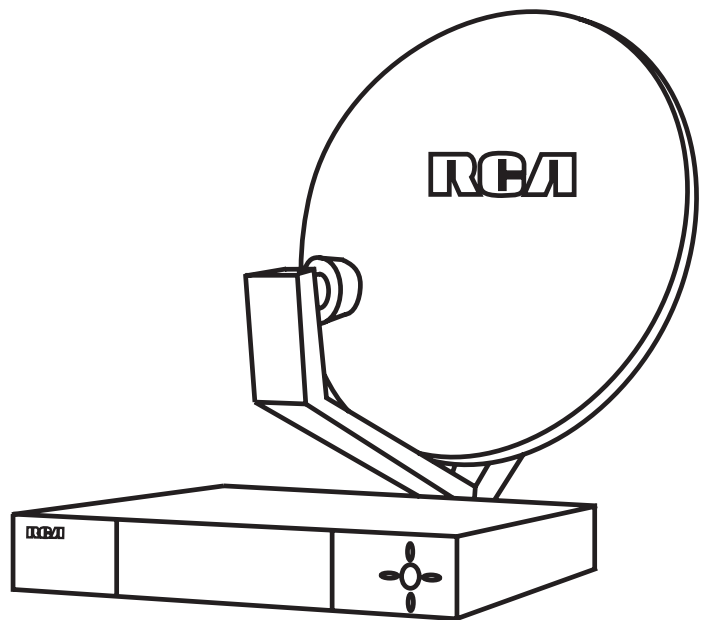

USER'S GUIDE

SAFETY INFORMATION

WARNING

To reduce risk of fire or shock hazard, do not expose this receiver to rain or moisture.

WARNING

RISK OF ELECTRIC SHOCK
DO NOT OPEN



This symbol indicates "dangerous voltage" inside the product that presents a risk of electric shock or personal injury.



This symbol indicates important instructions accompanying the product.

TO REDUCE THE RISK OF ELECTRIC SHOCK, DO NOT REMOVE COVER (OR BACK). NO USER SERVICEABLE PARTS INSIDE. REFER SERVICING TO QUALIFIED SERVICE PERSONNEL.

Cautions

Do not stack electronic components or other objects on top of the DSS® Receiver. The slots on top of the receiver must be left uncovered to allow proper airflow to the unit. Blocking the airflow to the unit could impair performance or damage your receiver and other components.

Do not stack the DSS® receiver on top of a "hot component" such as an audio power amplifier.

FCC Regulations state that unauthorized changes or modifications to this equipment may void the user's authority to operate it.

The RF remote control complies with part 15 of the FCC Rules. Operation is subject to the following two conditions: 1) The RF remote control may not cause harmful interference and; 2) The RF remote control must accept any interference received, including interference that may cause undesired operation.

Note to Cable TV Installer:

This reminder is provided to call your attention to Article 820-40 of the National Electrical Code (Section 54 of the Canadian Electrical Code, Part 1) which provides guidelines for proper grounding and, in particular, specifies that the cable ground shall be connected to the grounding system of the building as close to the point of cable entry as practical.

Note to Satellite Dish Installer:

This reminder is provided to call your attention to Article 810 and in particular article 810-15 of the National Electrical Code which covers proper installation and grounding of television receiving equipment as well as to article 820-40 of the National Electrical Code which specifies that the satellite dish cable ground shall be connected to the grounding system of the building as close to the point of cable entry as practical.

IMPORTANT NOTICE:

This device incorporates an anticopy process technology that is protected by U.S. patents and other intellectual property rights. The anticopy process is licensed for non-commercial, home use only. Reverse engineering or disassembly is prohibited.

Care and Cleaning:

Use a soft cloth or dusting attachment of your vacuum cleaner to dust your DSS® receiver. Remove dust from the ventilation holes on the top and bottom.

Plastic surfaces are easily scratched and can be marred by alcohol and various solvents. Avoid excessive use of oil-based furniture polishes since the materials used in the cabinet will accumulate more dust. A non-abrasive, anti-static cleaner/polisher is recommended.

TABLE OF CONTENTS

First Things First	3
What is the DSS® System?	4
What's in the Box	5
Using This Manual	6
The Point and Select Method	7
Connecting Your DSS® Receiver to Your TV	8
Things to Know Before Connecting Components	8
Jacks and Cables	9
Connecting the VCR Controller	14
Choosing a DSS® Output Channel	16
Connecting a Compatible D-VHS VCR	18
Ordering DSS® Programming	18
Program Guides	19
Anatomy of a Program Guide	20
Anatomy of The Channel Banner	21
Using the GUIDE Button	22
Getting Around in the Guides	22
Tuning to a Program	23
The Other Program Guides	23
Sorting the Guides	25
The Menu System	31
Using the Menu System	32
Exit and Help	32
Menu Descriptions	33
The Program Guide	34
Anatomy of a Program Guide	34
The Mailbox	35
How to tell when you have mail	35
Checking your mail	35
Pay-Per-View Programs	36
Purchasing and Previewing	36
Tuning to a PPV Program	36
Using the Program Guide for PPV Programs	37
Using the Attractions Guide	38
Using the Purchases Menu	39
Reviewing and Canceling an Upcoming Purchase	39
Spending Limits	40
Timers Feature	41
Profiles	43
Creating a Profile Channel List	43
Setting the Ratings Limit	44

TABLE OF CONTENTS

Viewing Hours	45
Setting Up Spending Limits	45
Locking a User's Profile	46
Locking the System	46
Choosing Your Profile	47
Options	48
Look and Feel	49
System Options	50
Alternate Audio	51
Alternate Data	51
The Dish Pointing Menu Screen	52
Using the On-Screen Signal Meter	53
Home Control	54
Fetch Menu	56
Reference	57
Parts of the DSS® System	58
World View	58
Home View	59
Controls and Buttons	60
Front Panel Controls	60
Back Panel Controls	61
Remote Control Buttons	62
Programming the Remote Control	63
Programming the Remote to Control Your TV	64
Programming the Remote to Control Your VCR	64
Programming the Remote to Control Other Devices	65
Using the Remote Buttons to Control a Device	65
Remote Codes	66
Glossary	68
Troubleshooting	70
Running the System Test	70
Appendix A: Warranty Information	71
Appendix B: FCC Regulations	74
Appendix C: Accessories	75
Index	77

DSS® is a registered trademark of DIRECTV, Inc., a unit of Hughes Electronics Corp.

StarSight-Licensed: The manufacture and sale of the television schedule feature of this product was licensed under one or more of the following patents of StarSight Telecast, Inc.; U.S. Patent Nos. 4,706,121; 4,977,455; 5,151,789; 5,335,277; and 5,353,121.

FIRST THINGS FIRST

READ THE FIRST TWO CHAPTERS

The first two chapters of the manual introduce you to your DSS® system, and show you how to use the on-screen guides and menus.

In *First Things First*, you'll learn:

- how to use this manual
- how to use the menu system and guides
- different ways to connect the receiver to your TV
- how to connect the VCR controller
- how to set the output channel
- how to send the DSS® signal to multiple TVs
- how to connect a D-VHS VCR
- how to order programming

Program Guides details the items and features associated with the different guides.

THE REST OF THE MANUAL

The rest of the book includes menu information, reference information such as remote codes, a glossary, and an index.

1 FIRST THINGS FIRST



2 PROGRAM GUIDES



3 THE MENU SYSTEM



4 REFERENCE



5 APPENDICES

FIRST THINGS FIRST

WHAT IS THE DSS® SYSTEM?

You've purchased the DSS® Digital Satellite System, so you already know a lot of the great things it offers. You know that the DSS® system uses the latest satellite technology to deliver television programming to your home. And you know that the transmissions are digital, so the quality of the picture and audio rivals that of laser discs and CDs. You know the dish is small—18 inches wide—and that it often can be installed in a matter of hours. (See the DSS® System Installer Guide for specific information.)

Those are the some of the things you probably know about the DSS® system. But what about the things you don't know? For instance...

- **The DSS® system works like your TV.** Pick up the DSS® remote and push the DSS1 button. Press the Channel Up/Down buttons to scan through the channels. Press the number keys to go directly to a channel.
- There is an **on-screen program guide**. The program guide is like a TV listing in the newspaper. It is designed to help you select regular programs and pay-per-view events. You can also sort the guide to list only specific types of programs. You can select Sports, for example, and your guide will show current and upcoming sports programs only. Or Movies. Or News.
- There is the **on-screen Menu System** that allows you to customize your system. You can set up your system, build channel lists, preview coming attractions, set spending limits, and receive mail from your program providers.
- There are three types of **On-line Help** to assist you in learning how to use the DSS® system: Context-Sensitive Help (at the bottom of most menu screens), *Help* buttons, and the *About DSS* menu.

FIRST THINGS FIRST

WHAT'S IN THE BOX

The following items come with your DSS® receiver:

- Receiver (with access card inserted)
- Remote Control
- VCR Controller

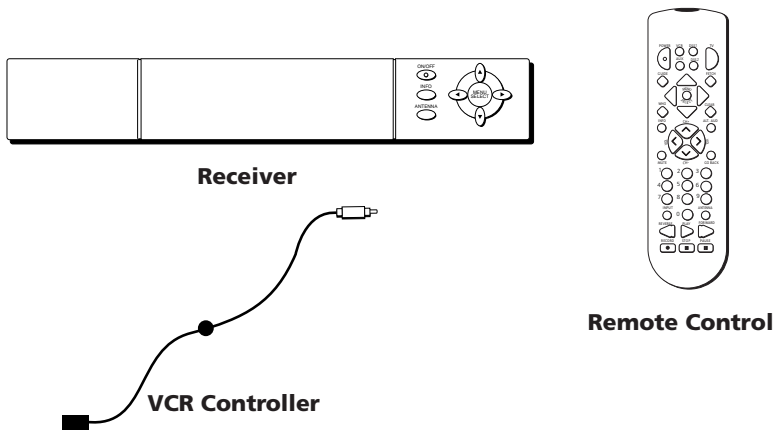

INSTALLING BATTERIES IN THE REMOTE CONTROL

Follow these steps whenever you need to install or change the batteries in your DSS® remote.

1. Remove the cover from the battery compartment.
2. Insert batteries as shown in the battery compartment, matching the + and - end of each battery.
3. Replace the cover.

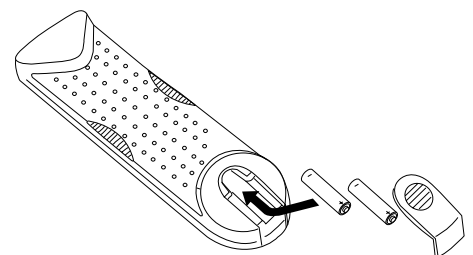

Programming the Remote

Depending on your equipment you may need to program the remote to control other devices. Check out "Programming the Remote" in the Reference section.

FIRST THINGS FIRST

USING THIS MANUAL

There are a couple of conventions used in this manual that might help you read it.

- Words that appear in ALL CAPS indicate the name of a button.
- The names of on-screen menu options are shown in *italics*.

IMPORTANT NOTE ABOUT THIS USER'S MANUAL

This manual assumes that your DSS® system has been installed, meaning:

1. The DSS® satellite dish antenna has been installed, correctly pointed at the satellite, and connected to your DSS® receiver.
2. The DSS® receiver is connected to your television and to a telephone line.
3. The access card is installed in your DSS® receiver.

Your access card has been matched to your receiver, and should already be installed when you take the receiver out of the packing box. The access card should only be taken out of the DSS® receiver when you are issued a new card by your programming providers.

4. The DSS® remote control has batteries and can be programmed to control both your DSS® receiver and your TV (if your TV is remote-controllable).

If your system has not been installed, refer to the satellite dish Installer's Guide for information regarding proper installation. Then, refer to the next section, *Connecting Your DSS® Receiver to Your TV*. See your dealer for specific information regarding professional installation or the purchase of a Self-Installer's Kit.

FIRST THINGS FIRST

THE POINT AND SELECT METHOD

Point and Select is the two-step method you use to navigate through the menu system and program guides. Once you know how to point and select, you can explore the menus to learn more about how your DSS® system works.

1. POINT

You point by pressing the arrow keys on the remote or front panel. Pressing the arrow keys moves the on-screen highlight to different items in the program guide and the menu screens. Pressing an arrow once moves the highlight one space in the direction of the arrow.

For example, to point down (that is, to move the highlight toward the bottom of the screen), press the down arrow. To point right, press the right arrow.

2. SELECT

Once you have pointed to an item on the screen, select it by pressing the MENU•SELECT button on the remote or front panel. Selecting an item tells the menu system to go ahead and make the change you have indicated.

For example, the instructions in the User's Manual might tell you to Point to the *Exit* button and press MENU•SELECT.

Once you've got the hang of the Point and Select rule, you can use any part of the DSS® system.

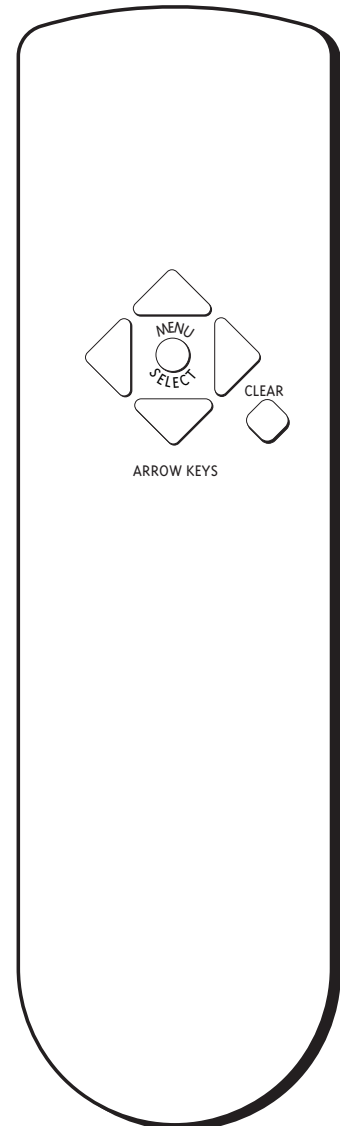

Don't worry about getting stuck inside a menu. Pressing the CLEAR button on the remote takes you out of the menu system and back to the program you were watching.

FIRST THINGS FIRST

CONNECTING YOUR DSS® RECEIVER TO YOUR TV

During the satellite dish antenna installation, the receiver may have been connected to your TV with just a coaxial cable for the system test. Depending on what components you have, another connection may provide better picture and audio quality. The following sections provide cable and connection information to help you decide what connection is best for you.

THINGS TO KNOW BEFORE CONNECTING COMPONENTS

Protect Your Components from Power Surges

- Connect all components before plugging any power cords into the wall outlet.
- Always turn off the DSS® receiver, TV and other components before you connect or disconnect any cables.

Position Cables Correctly to Avoid Audio Hum or Interference

- Insert all cable plugs firmly into their jacks.
- Place the audio/video cables to the sides of the TV's back panel instead of straight down the middle after you connect your components.
- Try not to coil any twin-lead cables and keep them away from the audio/video cables as much as possible.
- Make sure all antennas and cables are properly grounded. Refer to the Safety Tips sheet packed with your unit.

Protect Your Components from Overheating

- Do not block ventilation holes in any of the components. Arrange the components so that air can circulate freely.
- Do not stack components.
- Allow adequate ventilation when placing your components in a stand.
- Place an amplifier or DSS® receiver on the top shelf of the stand so heated air rising from it will not flow around other components.

FIRST THINGS FIRST

JACKS AND CABLES

S-Video Jack and Cable

The S-Video jack provides the best picture quality for your DSS® system.

This jack is available on many TVs and is used in conjunction with audio cables to connect the DSS® receiver to your TV. Remember also to connect the left and right audio cables because the S-video jack carries only the picture signal, not the sound.



S-Video Jack

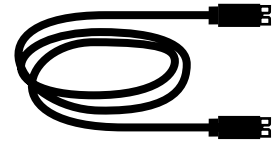

Audio/Video Jacks and Cables (RCA-type)

The audio/video jacks provide very good picture and stereo sound quality, and should be used if your TV has no S-Video jack.

These jacks are used for most audio/video connections between components. The DSS® receiver audio/video jacks are color coded (yellow for video, red for right audio, and white for left audio). If your TV has only one input for audio (mono), connect it to the right (red) audio jack on the DSS® receiver.



Audio/Video Jacks

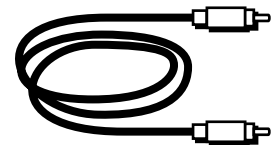

RF Jacks and Coaxial Cables (F-type)

The RF jacks provide good picture and mono sound quality, and are to be used if audio/video connections are not available for your TV.

These jacks are required for antenna or cable-TV connections. The RF jacks on the DSS® receiver are labeled IN FROM ANT and OUT TO TV. The coaxial cable supplied with your DSS® system is used to connect the RF jacks between the DSS® receiver and your TV's antenna input.



RF Jack

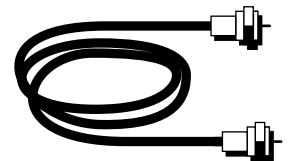

VCR Controller Jack and Cable

The VCR controller cable plugs into a jack on the DSS® receiver's back panel. The other end of the cable affixes to your VCR's remote sensor.



VCR Controller Jack

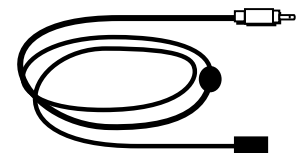

Digital Audio/Video (DAV) Jack and Cable

The digital audio/video cable connects the DSS® receiver to a compatible D-VHS VCR. This connection lets you record and play back digital programming with virtually no loss in picture and sound quality.



Digital Audio/Video Jack

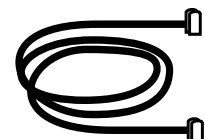

FIRST THINGS FIRST

CONNECTION A

BEST PICTURE AND SOUND QUALITY

To use this connection you must have:

- TV with separate RF, audio/video, and S-Video inputs (jacks)
- VCR with RF and audio/video inputs
- Coaxial, audio/video, and S-Video cables

To connect TV, VCR and antenna or cable box:

1. Connect coaxial cables as shown.
2. Connect audio/video cables as shown.
3. Connect S-Video cable as shown.

To receive DSS® programming:

1. Tune TV to receive the S-Video output from the DSS® receiver.
2. Tune DSS® receiver to desired channel.

To receive off-air programming (no cable box):

1. Turn off VCR and DSS® receiver.
2. Tune TV to desired channel.

To receive off-air programming (with cable box):

1. Turn off VCR and DSS® receiver.
2. Tune TV to cable box output channel (usually CH2, CH3, or CH4).
3. Tune cable box to desired channel.

To record DSS® programming:

1. Tune TV to receive S-Video output from DSS® receiver.
2. Tune DSS® receiver to desired channel.
3. Set your VCR to record on line input.

To view VCR programming:

1. Tune TV to VCR output channel (usually CH3 or CH4).

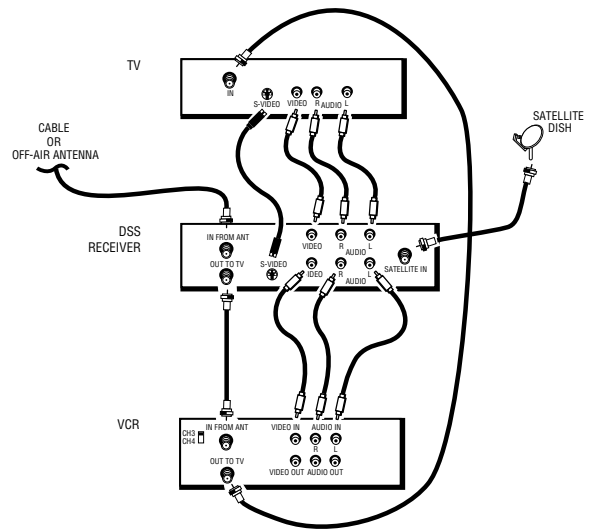

CAUTION

Do not stack electronic components or other objects on top of the DSS® receiver. See Safety Information, inside front cover.

FIRST THINGS FIRST

CONNECTION B

VERY GOOD PICTURE AND SOUND QUALITY

To use this connection you must have:

- TV with separate RF and audio/video inputs (jacks)
- VCR with RF and audio/video inputs
- Coaxial and audio/video cables

To connect TV, VCR and antenna or cable box:

1. Connect coaxial cables as shown.
2. Connect audio/video cables as shown.

To receive DSS® programming:

1. Tune TV to receive line output from DSS® receiver (often called Input 1).
2. Tune DSS® receiver to desired channel.

To receive off-air programming (no cable box):

1. Turn off VCR and DSS® receiver.
2. Tune TV to desired channel.

To receive off-air programming (with cable box):

1. Turn off VCR and DSS® receiver.
2. Tune TV to cable box output channel (usually CH2, CH3, or CH4).
3. Tune cable box to desired channel.

To record DSS® programming:

1. Tune TV to record line output from DSS® receiver (Input1).
2. Tune DSS® receiver to desired channel.
3. Set your VCR to record on line input.

To view VCR programming:

1. Tune TV to VCR output channel (usually CH3 or CH4).

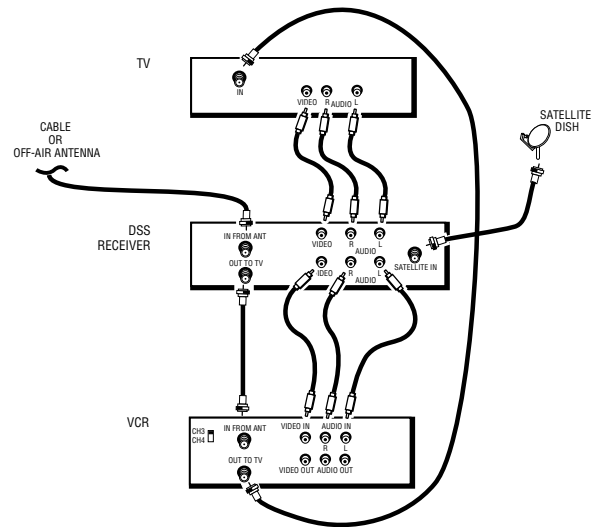

CAUTION

Do not stack electronic components or other objects on top of the DSS® receiver. See Safety Information, inside front cover.

FIRST THINGS FIRST

CONNECTION C

GOOD PICTURE AND SOUND QUALITY

To use this connection you must have:

- TV with RF input (jack)
- VCR with RF and audio/video inputs
- Coaxial and audio/video cables

To connect TV, VCR, and antenna or cable box:

1. Connect coaxial cables and audio/video cables as shown.

To receive DSS® programming:

- Tune TV to channel 3 or 4 (depending on how you set the CH3/CH4 switch on the back of the receiver).

To receive off-air programming (no cable box):

1. Turn off VCR and DSS® receiver.
2. Tune TV to desired channel.

To receive cable programming (with cable box):

1. Turn off VCR and DSS® receiver.
2. Tune TV to cable box output channel (usually CH2, CH3, or CH4).
3. Tune cable box to desired channel.

To record DSS® programming:

1. Tune TV to the channel on which you receive the DSS® signal.
2. Tune DSS® receiver to desired channel.
3. Set VCR to record on line input.

To view VCR programming:

1. Tune TV to VCR output channel (usually CH3 or CH4).
2. Turn DSS® receiver off.

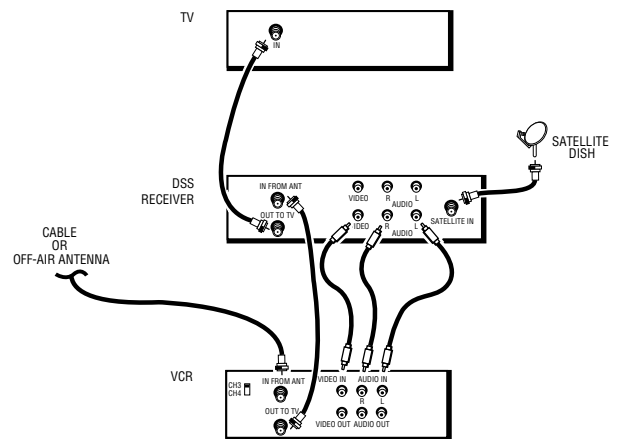

CAUTION

Do not stack electronic components or other objects on top of the DSS® receiver. See Safety Information, inside front cover.

FIRST THINGS FIRST

CONNECTION D

GOOD PICTURE AND SOUND QUALITY

To use this connection you must have:

- TV with RF input
- Coaxial cables

To connect TV and antenna or cable box:

1. Connect coaxial cables as shown.

To receive DSS® programming:

- Tune TV to channel 3 or 4 (depending on how you set the CH3/CH4 switch on the back of the receiver.

To receive off-air programming (no cable box):

1. Turn off DSS® receiver.
2. Tune TV to desired channel.

To receive cable programming (with cable box):

1. Turn off DSS® receiver.
2. Tune TV to cable box output channel (usually CH2, CH3, or CH4).
3. Tune cable box to desired channel.

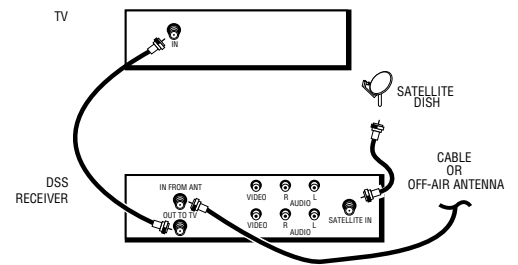

CAUTION

Do not stack electronic components or other objects on top of the DSS® receiver. See Safety Information, inside front cover.

FIRST THINGS FIRST

CONNECTING THE VCR CONTROLLER

In order for the DSS® receiver and VCR to communicate, you need to attach the VCR Controller to the back of the receiver.

1. Plug the VCR Controller into the VCR CONTROL jack on the back of the DSS® receiver.
2. Affix the other end to the remote sensor on your VCR.

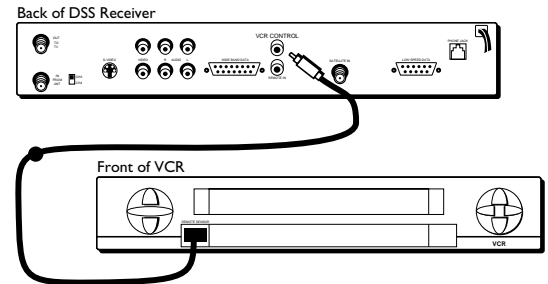

LOCATING THE VCR'S INFRARED REMOTE CONTROL SENSOR

The VCR Controller must be affixed directly over the infrared remote sensor on your VCR.

Some VCRs label the infrared remote sensor, and others do not. If your VCR is labeled, affix the VCR controller directly over the sensor.

Using the VCR Remote to Locate the Remote Sensor

For VCRs that do not label the remote sensor, you need to use the VCR's remote to locate the sensor before affixing the VCR controller.

1. Hold the remote control so that it is touching the front of the VCR.
2. Slowly move the remote over the front of the VCR while pressing the remote power button on and off.
3. When your VCR turns off or on, you have located the sensor.

To test the VCR controller, use a piece of clear tape to temporarily attach the VCR controller to the spot where you think the sensor is located, and then follow the steps described under "Selecting a VCR Type."

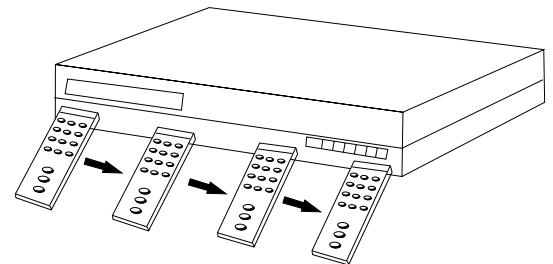

FIRST THINGS FIRST

SELECTING A VCR TYPE

When you connect a VCR Controller, you need to tell the DSS® receiver which VCR brand you are using.

1. Press MENU•SELECT on the remote to bring up the Main menu.
2. Point to *Options* and press MENU•SELECT.
3. Point to *System Options* and press MENU•SELECT.
4. Point to *Set VCR Type* and press MENU•SELECT.

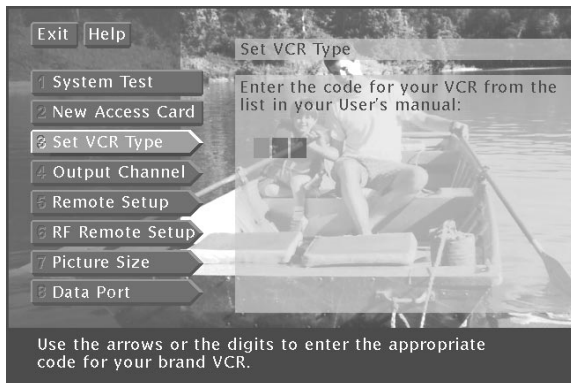

The Set VCR Type screen lets you enter a code for your VCR.

5. Use the arrows or digit keys to input the correct code for your VCR brand. The VCR codes are located in the "Reference" section of this book.
 6. Follow the on-screen instructions to ensure that you are using the correct code. If the VCR automatically stops, then you know that the receiver and the VCR are communicating.
- Some VCR brands may not be capable of being controlled by the DSS® receiver.

FIRST THINGS FIRST

CHOOSING A DSS® OUTPUT CHANNEL

If you are using the OUT TO TV jack to send the signal to a TV, you need to know about the agile modulator. The agile modulator allows you to select the television channel you want to use when you output the DSS® signal from the OUT TO TV jack on the back of the receiver.

SELECTING AN OUTPUT CHANNEL

The default setting is channel 14 (off-air) and 65 (cable). Try to get a signal on these TV channels first. If you want to change the output channel:

1. Press MENU•SELECT to bring up the Main menu.
2. Point to and select *Options*.
3. Point to and select *System Options*.
4. Select *Output Channel* to begin the procedure, and follow the on-screen displays to select a new output channel.

In the first screen, you indicate whether you are getting local channels from cable service or off-air broadcasts, and in the screens that follow, you select an available output channel.

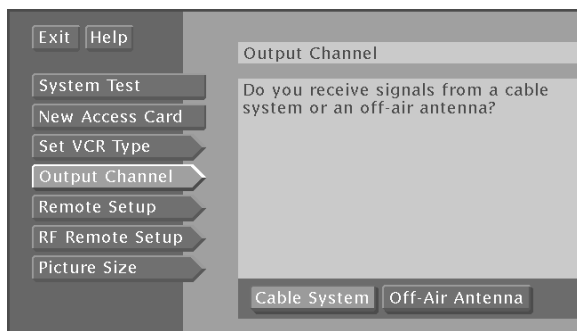

Select *Output Channel* to begin the procedure for changing your output channel.

You can select an off-air channel between UHF channels 14-69; or a cable channel from 65-94 or 100-125 (they use the same channel band). Go through your channels and find one within this range which currently does not have programming.

- If you can find three channels in a row that aren't being used, choose the middle channel.

What Does the Agile Modulator Do?

The agile modulator gives you more channels from which to choose an output channel. This should allow you to choose a channel not already being used by an off-air (antenna) broadcast station, or your local cable service.

Resetting the Agile Modulator

To reset the output channel to the default (UHF channel 14 or cable channel 65), simultaneously press the DISPLAY button and the LEFT ARROW button (◀) on the front of the receiver.

FIRST THINGS FIRST

SENDING THE DSS® SIGNAL TO MULTIPLE TVs

The most important feature of the agile modulator is that it creates a unique DSS® television channel. This unique channel can be combined with other TV channels on your antenna or cable system. Combining the signals and distributing them to all the televisions in your home lets you watch DSS® programming or local programming on any television connected to your system by simply changing channels on the TV.

The simplified drawing at the right shows how cable or off-air signals and the DSS® output channel can be combined and routed through a whole-house distribution system (sold separately). Although not shown in detail, a whole-house distribution system consists of signal splitter/combiners and amplifiers to boost both the DSS® output channel and off-air or cable channels.

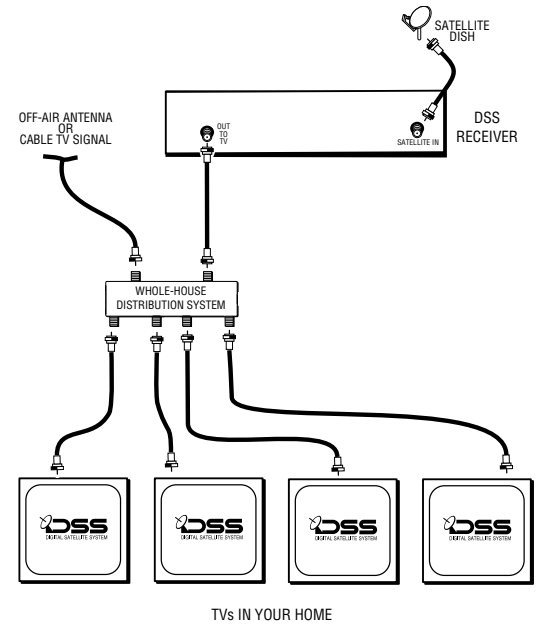

SINGLE TV OUTPUT

Although the agile modulator is designed for a whole-house distribution system, you may still need to set the output channel even if you are running a signal from the OUT TO TV jack to only one television. The default setting is channel 14 (off-air) and 65 (cable). Try to get a signal on these channels first; then go to Output Channel in the Options menu to change the agile modulator setting.

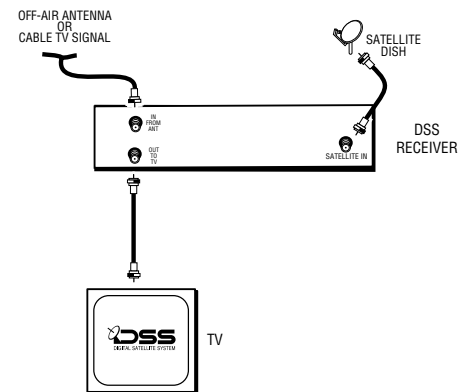

FIRST THINGS FIRST

CONNECTING A COMPATIBLE D-VHS VCR

The DSS® receiver can send a digital signal to a compatible D-VHS VCR. The D-VHS VCR can then record and playback recordings through the DSS® receiver. If you have a D-VHS VCR you must connect both devices so they can send and receive digital signals.

- 1) Connect a digital audio/video (DAV) cable as shown.
- 2) Connect RCA type audio/video cables as shown.

The D-VHS VCR and DSS® receiver communicate through the DAV cable. It is not necessary to connect the VCR controller or enter the VCR type described earlier in this section.

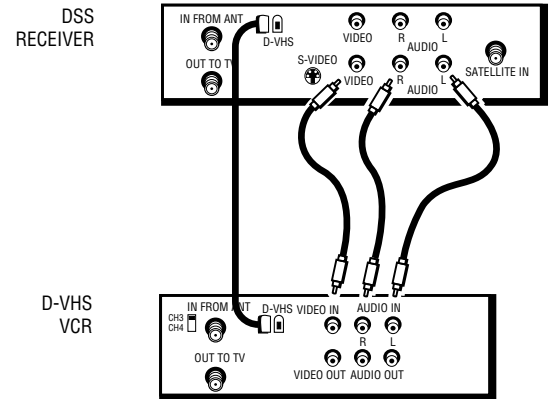

INTERACTIVE SETUP

If you self-installed your satellite dish antenna, you may have already used the interactive setup to find the dish pointing coordinates, acquire and fine-tune the signal, and run a system test.

If you need to run the interactive setup again, select *Options* from the Main menu, then select *Interactive Setup*.

If you just want to check your dish pointing coordinates, or run the signal strength meter, select *Dish Pointing* from the Main menu.

ORDERING DSS® PROGRAMMING

After you have installed your system, you should contact the service providers, DIRECTV and USSB to receive DSS® programming.

Programming with DIRECTV: Call 1-800-347-3288

Programming with USSB: Call 1-800-204-USSB

When you order programming, you need to know your Access Card number. To get the number, select Options from the Main menu, then System Options, and then select System Test.

Wait for the system to run all of it's tests. The Access Card number is displayed at the end of the system test.

Write the Access Card number in the space below for easy reference:

PROGRAM GUIDES

WHAT IS A PROGRAM GUIDE?

A program guide is an on-screen programming schedule. There are several types of guides, each presenting the schedule in a different format.

Using the program guide is easy as long as you remember the Point and Select rule. Point to items on the screen by pressing the arrow keys on the remote or front panel. Then, press MENU•SELECT to tune to that program.

1 FIRST THINGS FIRST



2 PROGRAM GUIDES



3 THE MENU SYSTEM



4 REFERENCE



5 APPENDICES

PROGRAM GUIDES

ANATOMY OF A PROGRAM GUIDE

The following diagram shows you the kind of information you will see in the program guides.

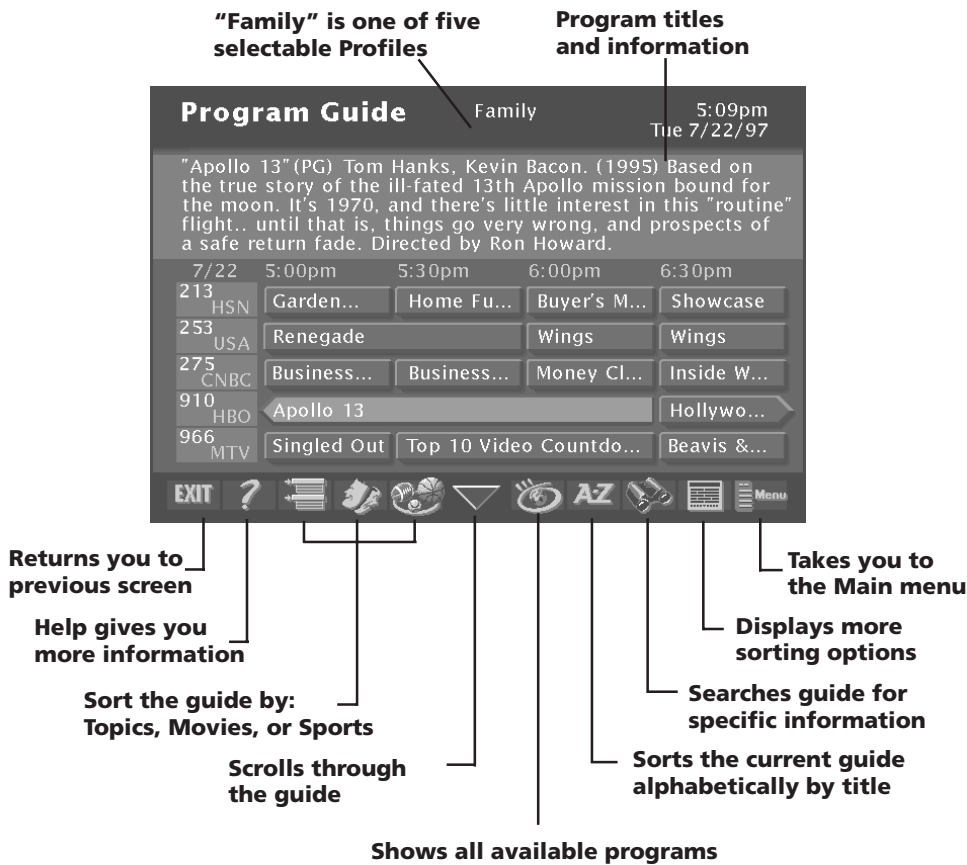

BRINGING UP THE PROGRAM GUIDES

You can access the program guides by pressing MENU•SELECT on the remote and selecting *Program Guide*, or by using the GUIDE button on the remote.

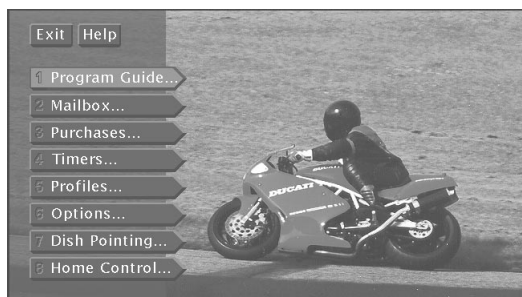

PROGRAM GUIDES

ANATOMY OF THE CHANNEL BANNER

Some of the items you select in the guides can also be selected in the channel banner.

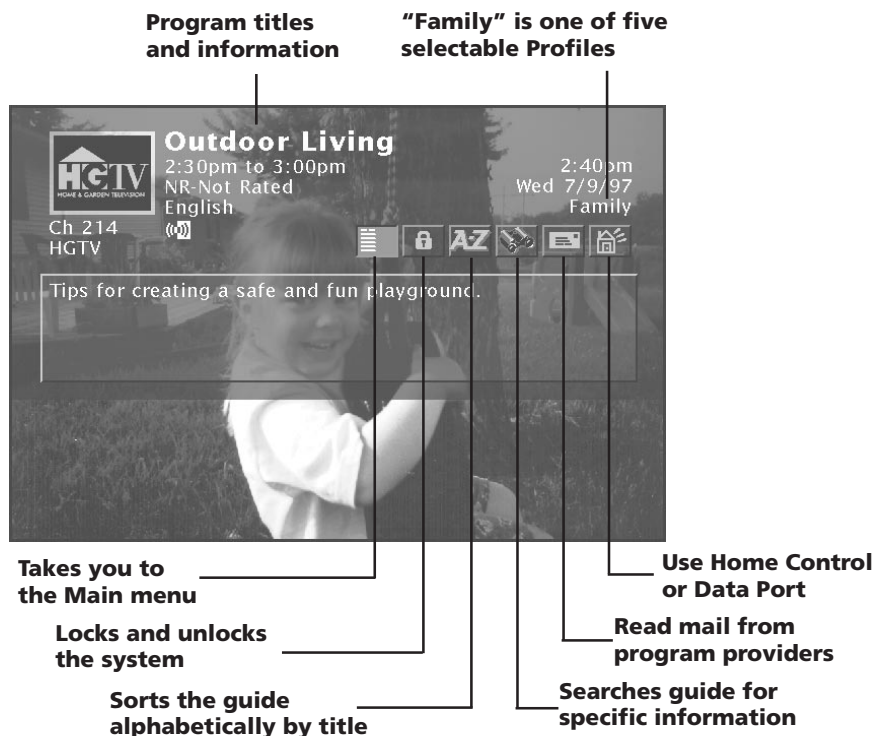

The channel banner appears whenever you tune to a channel, exit a guide, or press INFO on the remote. Use the arrow buttons and MENU•SELECT to choose an item.

On-screen icons represent frequently used menu items. Some icons also change appearance to show the item's status.

Green Unlock icon The system is unlocked. Spending, viewing and other limits can be accessed and changed.

Yellow Unlock icon A password has been entered to override family or profile limits. No limits can be accessed or changed.

Red Lock icon No limits can be accessed or changed. A password is required to override limits or access the system.

Highlighted Scout (binoculars) icon A Scout has found program information.

Highlighted Mail icon indicates a message in your mailbox.

Home Control or Data Port icons The icon changes appearance depending on how the Low Speed Data port is used.

PROGRAM GUIDES

USING THE GUIDE BUTTON

Each press of the GUIDE button takes you to an alternate type of program guide.

The Detail Guide

The Detail Guide shows five channels in a time-and-channel format, with program information for the highlighted program.

The Grid Guide

The Grid Guide shows seven channels in a time-and-channel format.

The SurfGuide

The SurfGuide displays a half-hour format. Press the right arrow button to extend the SurfGuide to a one-hour format.

GETTING AROUND IN THE GUIDES

This section describes how to change channels and move around the program guide.

Point to Channels with the number keys (0-9)

You can point quickly to any channel in the program guide by entering the channel number with the number keys (0-9). For example, to point to channel 228, press the numbers 2-2-8 on the remote. To point to channel 530, press 5-3-0.

Scrolling Channel By Channel

The programs that you see on the TV screen make up one section—or page—of the total program guide. You can scroll to other sections using the arrows: point to other times with the left and right arrows; point to other channels with the up and down arrows.

Scrolling Page By Page

If you want to scroll up or down through the program guide faster, press the Channel Up/Down buttons on the remote control. The highlight scrolls a page at a time.

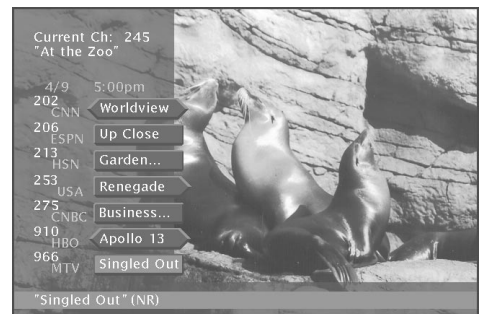
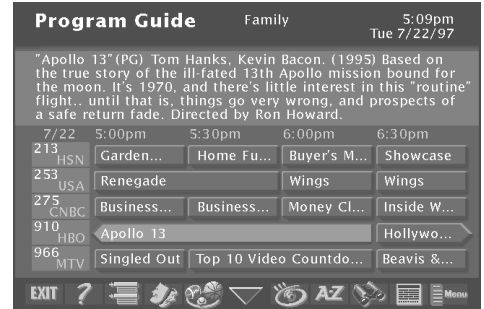

By default, the Detail Guide appears when you press GUIDE on the remote. You can change the default guide from the Detail Guide to the Grid Guide or SurfGuide.

Select *Options* from the Main menu. Select *Look and Feel*, then set the *Default Guide*.

PROGRAM GUIDES

TUNING TO A PROGRAM

To tune directly to a current program listed in the guide, point to the program and press MENU•SELECT.

To see information about a program in the guide, press INFO.

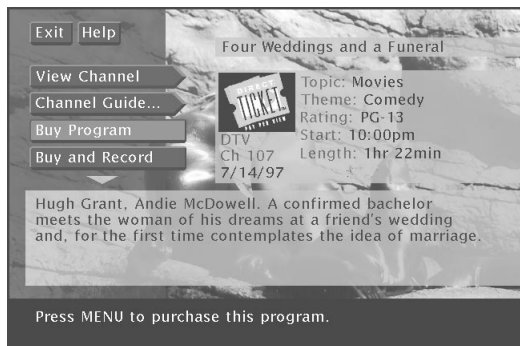

The Program Details screen appears and gives you several options.

Then, you can select:

- *View Channel* to tune to that channel
- *Channel Guide* to see a program lineup for that channel
- *Record Program* to set a timer to record the program
- *Buy Program* to purchase the program
- *Buy and Record* to purchase the program and set up a timer to record the program. (Some *Buy and Record* programs may have a different purchase price.)
- *Other Times* to see what other times the program is available.

The options available to you may vary according to the type of program you select.

THE OTHER PROGRAM GUIDES

Besides the Detail Guide, Grid Guide, and SurfGuide, there are a few more guides: the Channel Guide, the Logo Guide and the Attractions Guide.

You can access these guides by selecting the *Other Guides* button at the bottom of the Detail Guide and Grid Guide.



Other Guides button

PROGRAM GUIDES

The Channel Guide

Displays a channel's programming schedule in a channel-by-channel format.

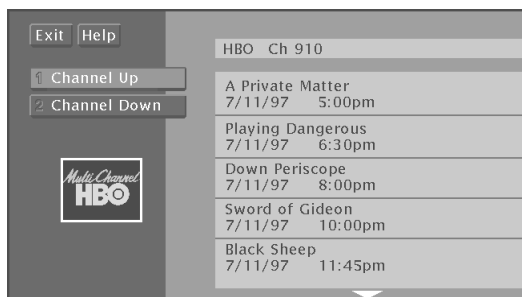

The Logo Guide

Displays channel logos for the current user's profile.



The Attractions Guide

Displays a list of channels that show coming attractions and special events information.



You can point to any program and tune to that channel, get more information, or set a timer to record.

Just press the MENU•SELECT, INFO, or RECORD buttons

Exiting A Program Guide

There are three ways to exit a guide:

- **Point to a channel and press MENU•SELECT.**
- **Point to *Exit* and press MENU•SELECT.**
- **Press CLEAR or GO BACK on the remote.**

PROGRAM GUIDES

SORTING THE GUIDES

Sorting the guide is a way of organizing the guide to show only the types of programs that interest you. There are several on-screen buttons that sort the guide in different ways.



The *Sorting* buttons appear at the bottom of the *Grid Guide* and *Detail Guide*.

Topics

The *Topics* button sorts the guide according to the current user's preferences. Select the *Topics* button to sort the guide.

The *Topics* button changes to the *Topics Themes* button. Press the *Topics Themes* button to edit the current user's themes preferences. These preferences are saved in each user's profile.



Checkmark the themes that interest you.

Select the categories, and checkmark the themes you would like to appear when you select the *Topics* button in the guides. Programming that fits the description of checkmarked themes will appear in the guide when you sort by the *Topics* button.



Topics button



Topics Themes button

PROGRAM GUIDES

Movies

Select the *Movies* button to list movies only. After selecting *Movies*, the *Movies* button changes to a *Movies Themes* button.

Select the *Movies Themes* button to sort the guide to list specific types of movies, such as comedies or musicals.



Select a *Movies Themes* that interests you.



Movies button



Movies Themes button

Sports

Select the *Sports* button to list sporting events only. After selecting *Sports*, the *Sports* button changes to a *Sports Themes* button.

Select the *Sports Themes* button to sort the guide to list specific types of sports, such as basketball or soccer.



Select a *Sports Theme* that interests you.



Sports button



Sports Themes button

All

The *All* button resets the guide to show all available topics, channels and listings for the current Profile.



All button

PROGRAM GUIDES

AlphaSort

AlphaSort lists in alphabetical order all the program titles in the current guide. Select the *AlphaSort* button to search for specific program titles that are in the current program guide. Use the arrow button to highlight a character, then press MENU•SELECT.

For example, to search for the program, *Auto Racing*, the first letter you should enter is "A". (Words like "The", "A" and "An" appear at the end of a title.) All titles that begin with "A" appear in the *AlphaSort* list. Next, enter the letter "U". All titles beginning with "AU" appear in the list.



AlphaSort button

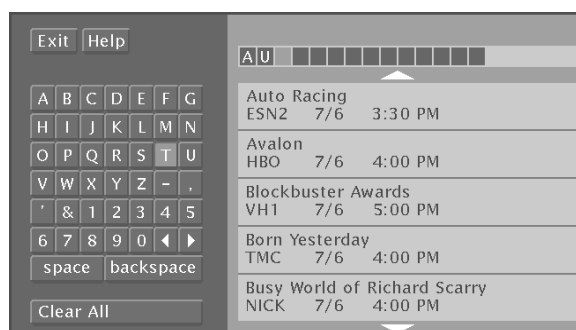

AlphaSort searches for specific titles in the guide.

Continue entering the specific title's letters until it appears in the *AlphaSort* list. If you enter the wrong letter, select either *Backspace* or *Clear All*.

Use the arrow buttons to highlight the title you are looking for. Press the MENU•SELECT button to select it, the INFO button to see more information, or the RECORD button to set up a timer recording. Only titles that are in the current program guide can be found by *AlphaSort*.

PROGRAM GUIDES

Scout

The *Scout* button lets you assign “Scouts” to search the guide for very specific program information, such as actor’s names or program descriptions. Select the *Scout* button to view the available scouts.

Point to an available *Scout*, and select it. Select the *Enter Text* button to set up the information the *Scout* will look for in the program guide. Use the on-screen keyboard to enter the desired search parameters.

For example, if you are interested in National Basketball Association events, enter a common term you might see in program information, like “NBA”.



Scout button



Select *Enter Text* to set up a *Scout*.

If “NBA” appears within a program title or program description, the program will be included in the *Scout Results* program list.

The *Scouts* will search for information when the DSS® receiver is off. (This may take up to 30 minutes for a full guide search.) You can check a *Scout’s* results by selecting a *Scout*.

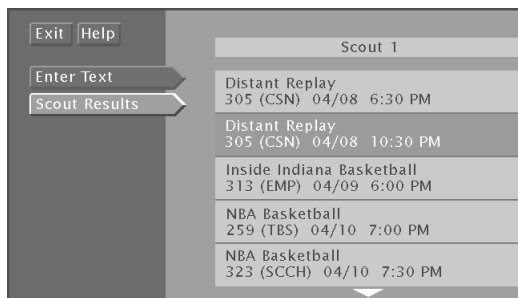

Scouts look for specific program information.

Use the arrow buttons to highlight the title you are looking for. Press the MENU•SELECT button to select it, press INFO to see more information, or RECORD to set up a timer recording.



A checkmark next to the Scout means it is in use.
A highlighted binocular icon means the Scout has found something.

PROGRAM GUIDES

Other Guides

The *Other Guides* button lets you sort the guide by different variables, such as future times, user profile channel lists, and channel groups. You can then choose a guide format to view the program information.



Other Guides button

Select the *Other Guides* button. You can select multiple sort parameters. For example, you could sort the guide by pay-per-view movies that are available at a future time.

Select *Guide Data* and use the arrow and MENU•SELECT buttons to choose the *Guide Data* group.

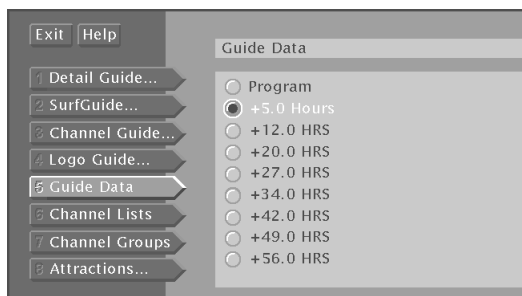

Guide Data lets you see what's on in the future.

Then, select *PPV* in the *Channel Groups* category.

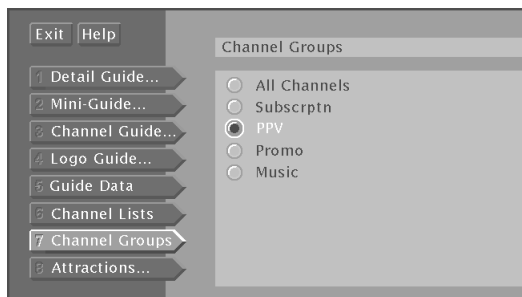

Channel Groups is another way to sort types of programming.

Select *Exit*, or press the GO BACK button on the remote to return to the previous guide. You can also choose another guide format from the category list.

PROGRAM GUIDES

The other buttons

Exit

Exits the guide and returns you to normal viewing on the current channel. Press MENU•SELECT to continue.



Exit button

Help

Brings up additional information about the guide. Press MENU•SELECT to continue.



Help button

Down Arrow

The arrow button allows you to scroll down through other channels in the guide. Point to the down arrow, and then press MENU•SELECT to scroll down through the program guide.



Arrow button

The Main menu

Brings up the DSS® system Main menu. Press MENU•SELECT to continue.



Main menu button

THE MENU SYSTEM

WHAT'S A MENU?

The DSS® system menu is a list of choices, just like a menu in a restaurant. And, just as a restaurant menu is divided into sections such as appetizers, entrees, and desserts, the on-screen menus are also separated into sections to help you find the information you need.

DON'T FORGET POINT AND SELECT

As with all of the on-screen displays, you use Point and Select to navigate.

1 FIRST THINGS FIRST



2 PROGRAM GUIDES



3 THE MENU SYSTEM



4 REFERENCE



5 APPENDICES

Use the MENU•SELECT button to bring up the Main menu, and then use Point and Select to choose a menu option.

THE MENU SYSTEM

USING THE MENU SYSTEM

To bring up the Main menu, press MENU•SELECT on the remote.



Use point and select to choose an item from the Main menu.

To use the menu system, you need to know the Point and Select rule. Use the arrows on the remote to point to an item on the screen, and then press MENU•SELECT to select it.

EXIT AND HELP

There are *Exit* and *Help* buttons at the top of most screens. Point to *Exit* and press MENU•SELECT to leave that screen. Point to *Help* to see more information about that screen.

Exiting a Screen

There are three ways to exit a menu:

- Point to *Exit* and press MENU•SELECT.
- Press the CLEAR button on the remote control. The on-screen displays clear from the screen and you return to TV viewing.
- Press the GO BACK button on the remote. You return to the previous on-screen display or normal programming.

Using Help

All menus have a *Help* button. For example, selecting the *Help* button from the Main menu shows you information about using the Main menu screen.

The rest of the *Help* buttons in the menu system bring up helpful information explaining one aspect of that menu.

If the Main menu doesn't appear when you press MENU•SELECT, the remote might not be in DSS® mode. Try pressing the DSS1 button on the remote, and then MENU•SELECT.

Context-Sensitive Help

Most of the screens contain information to help you decide what to do next. If you get stuck, look for the help text.

THE MENU SYSTEM

MENU DESCRIPTIONS

This section briefly describes each of the available Main menu options. More information about each menu and its features is included later in this chapter.

Program Guide

Shows the on-screen programming schedules.

Mailbox

Use to read mail messages from your program providers.

Purchases

Use to review or cancel upcoming purchases, and to review past purchases.

Timers

Allows you to schedule the DSS® system to tune to a specific channel at a specific time, and to record that channel.

Profiles

Allows you to set ratings limits, spending limits, and viewing hours, as well as create favorite channel lists.

Options

Allows you to find out more about the DSS® receiver and remote, change how your system looks, run the system test and install a new access card.

Dish Pointing

Use to find your dish pointing coordinates, and to access the on-screen signal strength meter.

Home Control

With the proper equipment, this feature lets you control certain devices and appliances in your house.

DON'T BE AFRAID TO EXPLORE

Once you've learned the basics, feel free to poke around the menu system because exploring is the best way to learn. The context-sensitive help at the bottom of the screen provides instructions for getting through any particular menu or control panel. Remember, press CLEAR at any time to leave the menu system and return to regular DSS® system viewing.

Exit Help

1 Program Guide...

2 Mailbox...

3 Purchases...

4 Timers...

5 Profiles...

6 Options...

7 Dish Pointing...

8 Home Control...

Don't Forget about the CLEAR button

Press the CLEAR button on the remote to remove the on-screen menus and return to normal viewing.

THE MENU SYSTEM

THE PROGRAM GUIDE

Selecting *Program Guide* brings up your default program guide: the Detail Guide, the Grid Guide or SurfGuide.

1 Program Guide...

ANATOMY OF A PROGRAM GUIDE

The following diagram shows you the kind of information you will see in the Detail Guide and Grid Guide.

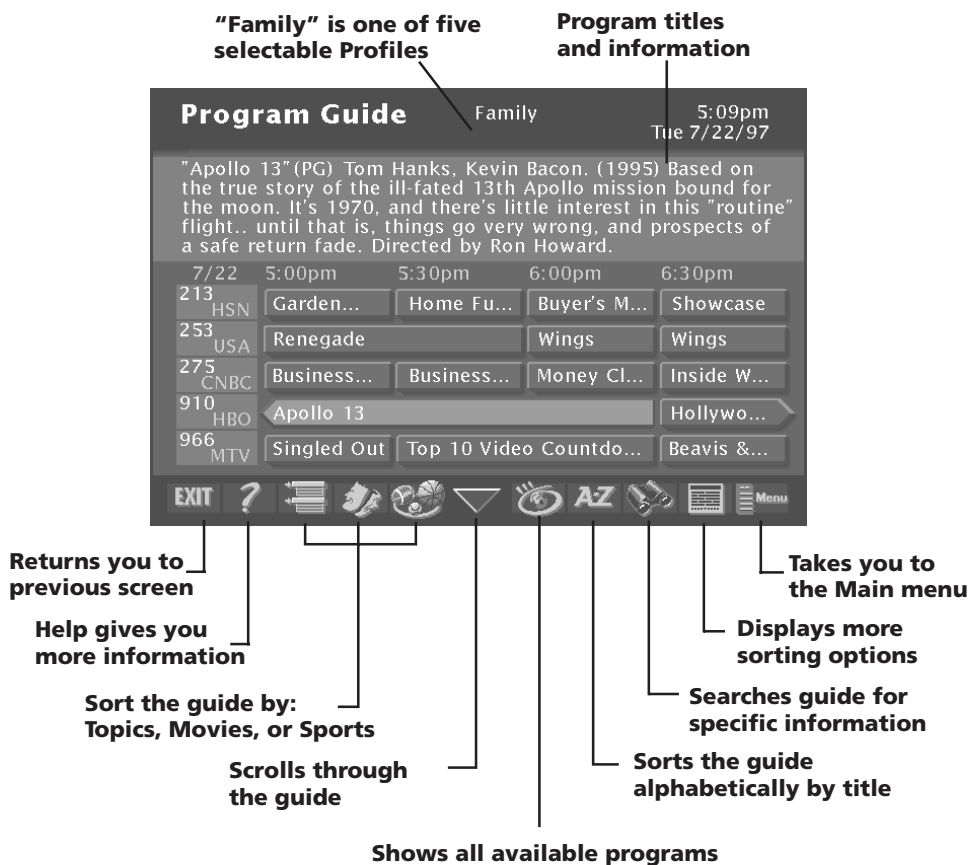

BRINGING UP THE PROGRAM GUIDES

Besides selecting *Program Guide* in the Main menu, you can press the GUIDE button on the remote.

Want More Information?

Read the chapter "Program Guides" earlier in this book for all the details.

THE MENU SYSTEM

THE MAILBOX

The mailbox shows you messages that are sent—or “mailed”—from your program providers. For example, you may receive a message calling your attention to a new service.

2 Mailbox...

HOW TO TELL WHEN YOU HAVE MAIL

There are two ways to tell if you have mail, depending on whether the DSS® receiver is turned on or off.

- If the DSS® receiver is turned on, the mail icon in the channel banner is highlighted.
- If the DSS® receiver is turned off, the power light on the front panel of the receiver flashes.

CHECKING YOUR MAIL

Select *Mailbox* on the Main menu or channel banner to view your mail.

1. Point to a message and press MENU•SELECT. The message is opened for you to read.



Mail provides the latest information from program providers.

2. Press MENU•SELECT again to close the letter.

After you read a message and want to erase it, point to *Erase Message* and press MENU•SELECT. When you exit the display screen, messages not erased are saved in memory.

THE MENU SYSTEM

PAY-PER-VIEW PROGRAMS

Pay-per-view programs (PPV) are programs that you purchase—like a movie ticket—on an event-by-event basis. For instance, there might be a specific channel that runs nothing but previews for movies. After previewing the movie, you can purchase it or find out more details about it. PPV programs can also be found in the program guide.

PURCHASING AND PREVIEWING

There are several ways to purchase and preview PPV movies and events:

- Tune to a PPV program's channel. Program providers may offer on-screen purchase instructions, usually as the PPV program begins.
- Select a PPV program from the program guide.
- Preview a coming attraction by selecting a channel from the Attractions Guide.

TUNING TO A PPV PROGRAM

When you use the channel buttons or digits on the remote to tune to a Pay-Per-View channel, you need to press the INFO button to bring up the *Program Details* screen in order to purchase a program.

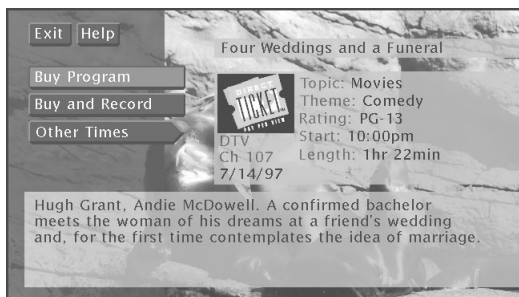

Use the program guide to get to the *Program Details* screen.

Follow the on-screen instructions to purchase the selected program.

3 Purchases...

You may need to enter your four-digit password to order a PPV program if it costs more than the spending limit you set up in the Profiles menu.

THE MENU SYSTEM

USING THE PROGRAM GUIDE FOR PPV PROGRAMS

When you use the program guide to select a PPV program, the *Program Details* screen gives you a few more options.

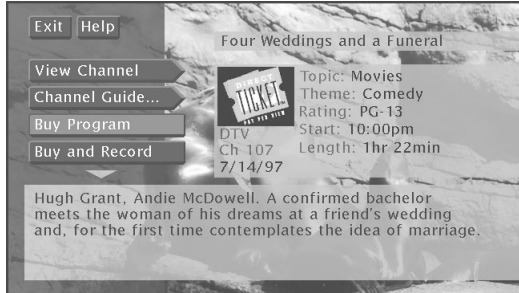

The Program Details screen gives you several options.

You can select:

- *View Channel* to tune to that channel
- *Channel Guide* to see a program lineup for that channel
- *Record Program* to set a timer to record the program
- *Buy Program* to purchase the program
- *Buy and Record* to purchase the program and set up a timer to record the program. (Some *Buy and Record* programs may have a different purchase price.)
- *Other Times* to see what other times the program is available.

The options available to you may vary according to the type of program you select.

3 Purchases...

Buy and Record Option

***Buy and Record* is a convenient way to buy a PPV and set up a timer recording in one step.**

However, your program provider may offer PPV programs that are coded so that you cannot record them.

You need to connect your phone line to your satellite receiver to be able to order PPV programs using the on-screen menus.

THE MENU SYSTEM

USING THE ATTRACTIONS GUIDE

Your program providers may offer future programming events not currently listed in your Program guide. These events are called “coming attractions,” and can be previewed in the Attractions Guide.

1. Press the GUIDE button until the Detail Guide or Grid Guide appears on-screen.
2. Use the down arrow button to move the highlight to the bottom of the screen.
3. Point to and select the *Other Guides* button.
4. Point to and select the *Attractions Guide*.



The Other Guides menu provides several guide formats.

5. Point to a channel and select it.



The Attractions Guide is accessed through the Other Guides menu.

3 Purchases...

THE MENU SYSTEM

USING THE PURCHASES MENU

3 Purchases...

The Purchases menu allows you to review upcoming and past purchases.

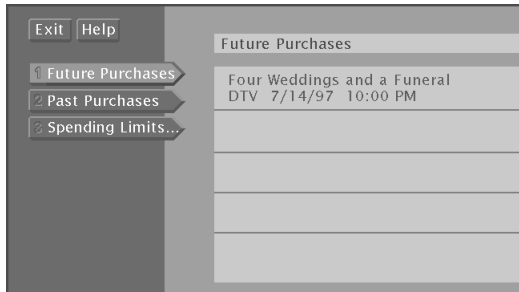

The Purchases menu shows you upcoming or past purchases, and spending limits.

The list of purchases may be longer than one screen; use the down arrow keys to see more items. The display also shows the title, channel, date, time, and cost of each program.

- Note that the Past Purchases list might be modified after each billing cycle and still show purchases for which you have already paid.

REVIEWING AND CANCELING AN UPCOMING PURCHASE

Use Point and Select to choose an upcoming purchase from the *Future Purchases* screen. You can review the program description, as well as cancel an upcoming purchase.

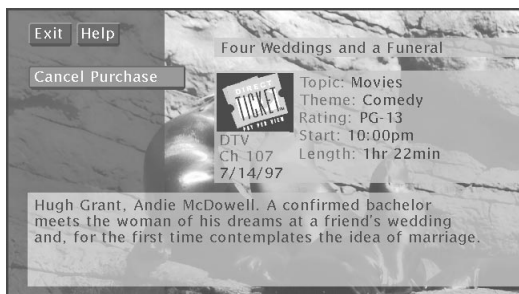

The Purchase Edit screen lets you cancel an upcoming purchase.

THE MENU SYSTEM

SPENDING LIMITS

Use the *Spending Limit* option to indicate a per-event spending limit for pay-per-view programs.

1. Point to *Spending Limit*, and press MENU•SELECT.

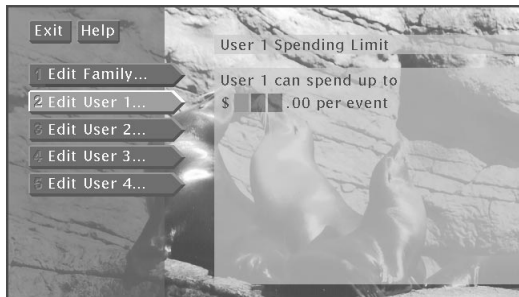

You can set a per-event spending limit for each Profile.

2. Use the digits on the remote or use the arrow keys to enter a single-program spending limit.

After a spending limit is set *and* the system is locked, you must enter a password to purchase a pay-per-view program that costs more than your spending limit allows.

3 Purchases...

Spending limits are in effect only when the system is locked.

THE MENU SYSTEM

TIMERS FEATURE

The Timers feature allows you to preset your system to automatically tune to a particular channel at a predetermined time.

Recording with Timer

To use the Timers feature, select *Timers* from the Main menu to bring up the Timers screen.

- 1 Select a Timer (1-8) and then use the arrow keys to complete the on-screen sentence.
- 2 When the sentence is complete, select *Run Timer*.



Complete the on-screen sentence to set up a timer.

Recording with Timer and D-VHS VCR

When you record with a D-VHS VCR and the required DAV cable, the on-screen scheduling sentence displays a few more options.



Digital recording offers more options.

- Choose the type of recording you want to make, either digital or analog.
- If you choose analog, you can also choose the recording speed: long play (LP), slow long play (SLP), or extended play (EP).

4 Timers...

On-screen icons are an easy way to understand the timers.



indicates the timer is set.



indicates the timer is set for a PPV.



indicates a timer conflict.

Editing or Canceling a Timer

From the Timers screen, select the Timer you want to edit or cancel, and then do the following:

- Use the arrows keys to edit the Timer, then select *Run Timer*.
- Select *Clear Timer* to cancel the timer.
- To record the program on a daily or weekly edit that program's timer.

THE MENU SYSTEM

Setting Up Timer Recordings

The Timers feature allows you to set up timer recordings if:

- You connect the VCR Controller to your DSS® receiver, and tell the receiver what type of VCR you are using.
- Or, if using a D-VHS VCR, the digital audio/video (DAV) cable is connected.

Recording with Timer

If you choose *Record* instead of *Watch* when setting the Timer (and have set up your VCR as previously discussed), the Timer will toggle on your VCR, then start and stop recording a program.

To record with timers:

- Most VCRs must be preset to the DSS® output channel (RF or Line). D-VHS VCRs automatically communicate with the DSS® receiver through the DAV cable.
- Your VCR must be OFF at the time the program is to start recording.
- Digital recordings require a compatible D-VHS or S-VHS cassette tape. Analog recordings can be made on VHS, S-VHS or D-VHS tape.

Schedule a Timer with the RECORD Button

You can schedule a recording directly from the guide.

1. With a program highlighted, press the RECORD button on the remote. The *Program Details* appears on-screen.

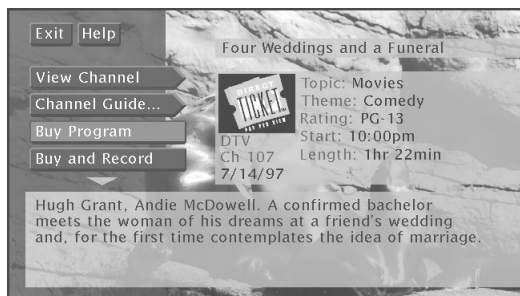

2. To schedule a timer to record, select:
 - *Record Program* to set a timer to record the program
 - *Buy and Record* to purchase the program and set up a timer to record the program. (Some *Buy and Record* programs may have a different purchase price.)

4 Timers...

When recording a PPV program, don't forget to purchase the program as well as set up the timer. Select *Buy and Record* to do both.

The options available to you may vary according to the type of program you select.

THE MENU SYSTEM

PROFILES

5 Profiles...

When you select *Profiles* from the Main menu, the first screen you see is the *User Profiles* control panel. In addition to the Family profile, you can create as many as four different profiles that can be easily accessed by using the WHO button on the remote control.

You can personalize how the profile looks on-screen by entering a name and selecting a picture.

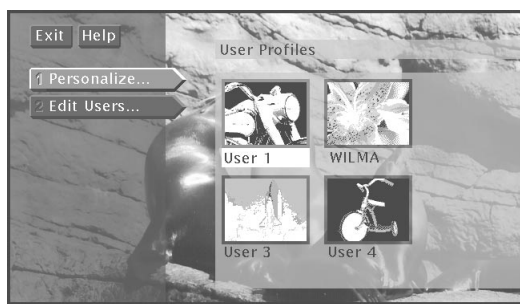

You can personalize each profile.

You can also edit the user profiles. Select a profile from the *Edit Users* control panel. By moving down the options you can create or edit the user's channel list, set a ratings limit, viewing hours, per-event spending limits and assign a profile password.

CREATING A PROFILE CHANNEL LIST

1. Point to and select *Edit Users*, then choose a user.
2. Point to a channel list option and press MENU•SELECT.



To start, you can add or delete all channels.

3. Use the arrow keys to point to a channel, and press MENU•SELECT to remove (or replace) the check mark. Checkmarked items appear in the channel list.

You need to lock the system in order for rating limits, channel limits, viewing hours, and spending limits to go into effect. After you lock the system, you need to enter the system password to edit the limits. See "Locking the System" for details

THE MENU SYSTEM

Add or Delete All Channels

You might be able to save time when creating a channel list by using the *Add All Chans* option or the *Delete All Chans* option to either add all channels or delete all channels before removing or adding individual channels.

Also, program providers may make additional channels available. To prevent new channels from appearing in a profile channel list, choose *Delete All Chans* and checkmark only the channels you want to appear in the list.

5 Profiles...

SETTING THE RATINGS LIMIT

The Ratings Limit menu enables you to set a maximum viewing limit for rated movies (based on the MPAA ratings system), as long as the program provider has transmitted the proper code.

- Note that the ratings limit cannot be enforced if a program has not been rated, if rating information for that program is not transmitted by the program provider, or if the system has not been locked.
1. Point to *Set Rating Limit* and press MENU•SELECT.



Use the arrow keys to move the selector up and down.

2. Use the up and down arrows to move the rating selector to the highest rating you want to be able to view. In the preceding illustration, movies that are rated up to and including a "PG-13" rating can be viewed.

After the *Rating Limit* is set and the system is locked, you must enter the system password to watch programs with a rating higher than your limit.

THE MENU SYSTEM

VIEWING HOURS

5 Profiles...

Use the *Viewing Hours* option to limit the total amount of time, as well as the viewing hours a user can watch programming.

1. Point to *Viewing Hours*, and press MENU•SELECT.



You can limit viewing seven days a week.

2. Use the digits on the remote or point to the + or – and press MENU•SELECT to complete the on-screen sentence. Choose how many hours can be viewed each day (0-24 hours) and when programming can be viewed. Be sure to lock the system for these limits to take effect.

SETTING UP SPENDING LIMITS

Select the *Spending Limit* option to indicate a per-event spending limit for pay-per-view programs.

1. Point to *Spending Limit*, and press MENU•SELECT.

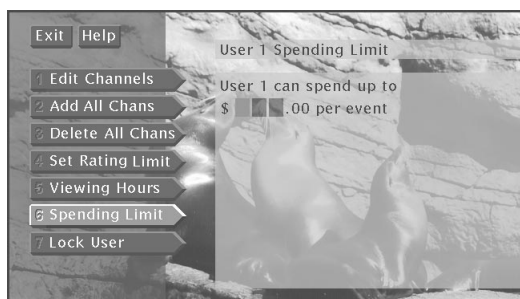

You can set a per-event spending limit for each profile.

2. Use the digits on the remote or use the arrow keys to enter a single-program spending limit.

After a *Spending Limit* is set and the system is locked, you must enter the system password to purchase a pay-per-view program that costs more than your *Spending Limit* allows.

THE MENU SYSTEM

LOCKING A USER'S PROFILE

Each user can be assigned a personal password to lock his or her profile. When a password is assigned, the user must enter the password before he or she can view programs using that profile. Profile passwords do not allow access to, or editing of the profile limits. You must enter the system password to edit profile limits.

1. Point to *Lock User* and press MENU•SELECT.

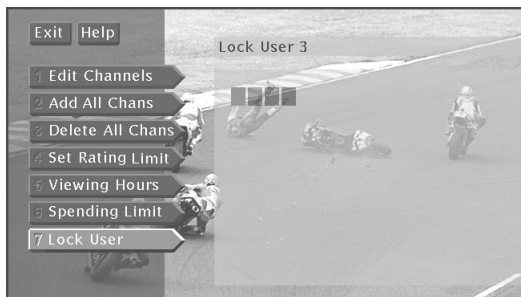

Each user can have a password.

2. Use the arrow or digit keys to select each number of the password.

LOCKING THE SYSTEM

You can lock the system in order to put into effect the ratings, spending, viewing, and channel limits you have set up. When you lock the system, no one can modify any of these settings without first entering the four-digit system password.

1. Point to *Lock System* and press MENU•SELECT.



Locking the system protects the limits you set up.

2. Use the arrows or the digit keys to enter a four-digit system password.
3. Enter the password a second time to confirm it.

5 Profiles...

After the system has been locked, you must enter the correct password in order to access the *Edit Users* control panel.

Don't Forget Your Password

If you forget a USER password, you need to unlock the system and then assign a new user password.

If you forget the SYSTEM password, contact your program provider's authorization center.

THE MENU SYSTEM

Unlocking the System

When the system is unlocked, the channel, spending, viewing, and ratings limits, that you have set are no longer in effect.

1. Point to *Unlock System* and press MENU•SELECT.
2. Point to *Yes* and press MENU•SELECT to confirm that you want to unlock the system.

Session Unlock

If your system is locked and you attempt to access a channel or program that is blocked by one or more limits, you are asked to enter the four-digit system password to override the system lock.

If you enter the password to override the rating or spending limit, all limits are unlocked until you turn off the receiver. When you turn on the receiver again, the system will be locked, and the Family profile channel list will be selected. You can also re-lock the system by selecting the lock icon in the channel banner.

CHOOSING YOUR PROFILE

Each time that you turn on the DSS® receiver, the Family profile is selected by default. To select a different Profile:

1. Press the WHO button to scroll through the profiles.

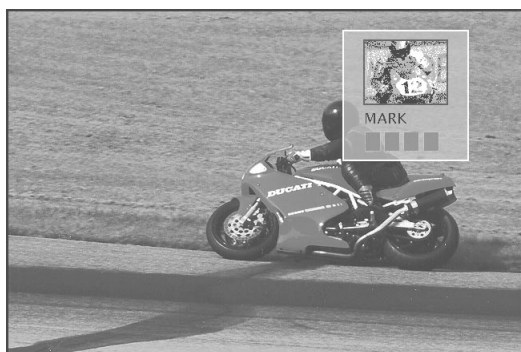

The WHO button toggles through the profiles.

2. When your profile appears, enter your four-digit personal password to activate your profile.
 - If the profile is not password protected, you can just press MENU•SELECT to activate it.

The channel, spending, ratings and viewing limits will reflect the chosen profile only when the system is locked.

5 Profiles...



The Lock/Unlock icons in the channel banner provide an easy way to lock or unlock the system. Just point and select to change the lock status.

Green Unlock icon The system is unlocked. Spending, viewing and other limits can be accessed and changed.

Yellow Unlock icon A password has been entered to override family or profile limits. No limits can be accessed or changed.

Red Lock icon No limits can be accessed or changed. A password is required to override limits or access the system.

THE MENU SYSTEM

OPTIONS

The Options menu lets you set up personal preferences for the look and feel of the system as well as how some of the features work.

Options...



The Options menu lets you change how the system works.

The following sections explain your options when changing your personal preferences. Follow the on-screen instructions to make changes to the system.

Interactive Setup

If you self-installed your satellite dish antenna, you may have already used the interactive setup to find the dish pointing coordinates, acquire and fine-tune the signal, and run a system test.

If you just want to check your dish pointing coordinates, or run the signal strength meter, select *Dish Pointing* from the Main menu.

THE MENU SYSTEM

About DSS

Select *About DSS* from the Options menu to choose from a list of on-line Help topics. Point and select to find out about the specific parts of the DSS® system, then use the right arrow key to continue through each of the Help screens or press MENU•SELECT to return to the Help menu.

Program Guide shows a screen-by-screen overview of the Program guide features.

Menu System shows a screen-by-screen overview of the DSS® system menus.

Remote Control shows an on-screen display of the remote control. Point to the different remote buttons to see a brief description of the highlighted button.

Front Panel shows an on-screen display of the DSS® receiver front panel. Point to the different front panel features to see a brief description of the highlighted feature.

Back Panel shows an on-screen display of the DSS® receiver back panel. Point to the different back panel features to see a brief description of the highlighted feature.

Glossary shows a list of common DSS® system and TV terms. Point to a glossary item to see a brief description.

LOOK AND FEEL

Default Guide lets you choose which guide appears first when you press the GUIDE button on the remote. The choices are Grid Guide, Detail Guide and SurfGuide.

Color Scheme lets you pick which color appears in the guides and menu system.

Translucency lets you choose the translucency of the menu displays. Slide the indicator bar to make the screens more opaque or less opaque.

Animation lets you turn animation on or off. Animation appears on-screen only when music channels are selected.



THE MENU SYSTEM

SYSTEM OPTIONS

A grey arrow-shaped button pointing to the right, containing a circular icon with a gear and the text "Options...".

Options...

System Test The System Test display screen is accessed through the *Options* menu, and allows you to initiate diagnostic procedures on the DSS® system. You should use this feature to get your Access Card number, or when your receiver doesn't seem to be working correctly. There are four separate tests: signal, tuning, phone connection, and access card.

A message screen appears, telling you whether the system passed each test. If your system fails a test, run the system test several times before concluding that there is a problem. Occasional fluctuations in the phone line or satellite signal can give temporary false readings.

New Access Card Periodically, your program provider may issue you a replacement access card. The New Access Card Setup display screen allows you to transfer the information from the old card onto the new one.

Follow the display screen prompts to initialize your new card. Once you have transferred the information to the new card, your old card becomes invalid.

Because your specific account information is stored in the access card, power failures should have no effect on your DSS® system.

Set VCR Type To use the VCR controller feature, you need to tell the DSS® receiver which VCR brand you are using.

1. Use the arrows or digit keys to input the correct code for your VCR brand. The VCR codes are located in the Reference section.
2. Follow the on-screen instructions to ensure that you are using the correct code. If the VCR automatically stops tape play, then you know that the receiver and the VCR are communicating.
 - Some VCR brands may not be capable of being controlled by the DSS® receiver.

Output Channel lets you select the television channel you want to use when you output the DSS® signal from the OUT TO TV jack on the back of the receiver. You can select an off-air channel between UHF channels 14-69; or a cable channel from 65-94 or 100-125.

Remote Setup Choose which remote button, DSS1 or DSS2, will control the DSS® receiver.

THE MENU SYSTEM

RF Remote Setup The remote can control the DSS® receiver using both IR (Infrared) signals and RF (radio frequency) signals. IR signals require line of sight to the receiver's front panel remote sensor. RF signals can control the receiver from other parts of your house—even through walls.

Occasionally, due to interference or other RF devices, you may need to change the remote and receiver RF code. To change the code, follow the on-screen instructions.

Picture Size The Picture size display screen allows you to choose between a standard TV screen and a Cinema option. A standard TV screen has an aspect ratio of 4:3; the Cinema option has an aspect ratio of 16:9.

Data Port Let's you choose whether the low speed data port is used for low speed data or communicating with the Home Control Base accessory. See the Home Control section in this book for more information.

ALTERNATE AUDIO

When you select *Alternate Audio* from the *Options* menu, the Alternate Audio display screen comes up.

Point to the audio language or audio type you want and press MENU•SELECT. The DSS® system will then automatically set the audio program to the selected audio program type when that type is available.

There are two ways to change the audio:

- Press ALT AUD on the remote to temporarily change the Audio program while tuned to the current channel.
- Point to *Alternate Audio* from the *Options* menu and press MENU•SELECT to set the default *Alternate Audio*.

ALTERNATE DATA

Selects from among the available data on the current channel.



THE MENU SYSTEM

THE DISH POINTING MENU SCREEN

7 Dish Pointing...

Follow these steps to obtain your dish pointing coordinates:

1. Turn on your television and satellite receiver.
2. Tune your television to the satellite receiver's output channel.
3. Press MENU•SELECT on the remote or front panel to bring up the Main menu.
4. Use the arrows to highlight the "Dish Pointing" option, and then press MENU•SELECT to access the dish pointing screen.

NOTE: The menu screen that you see may be slightly different from the one pictured here.



5. Use the arrows on the remote or the front panel to highlight "Zip Code" and then press MENU•SELECT.
6. Enter the zip code for the dish installation location.
7. Record the elevation and azimuth numbers below.

Elevation _____

Azimuth _____

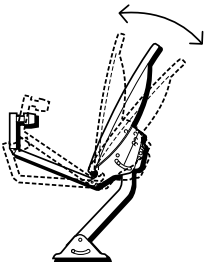

Elevation is the up/down angle that the dish is pointed.

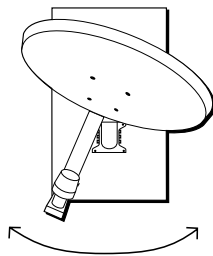

Azimuth is side to side direction that the dish is pointed.

You only need to use one of the available methods to find your dish pointing coordinates. If you know the zip code for the locality where the dish is being installed, use that.

THE MENU SYSTEM

USING THE ON-SCREEN SIGNAL METER

The signal strength meter is used to determine whether or not you are receiving the satellite signal, and it also indicates the strength of the satellite signal.

Follow these steps to bring up the on-screen signal meter:

1. Turn on your television and satellite receiver.
2. Tune your television to the satellite receiver's output channel.
3. Press MENU•SELECT on the remote or front panel to bring up the Main menu.
4. Use the arrows to highlight the "Dish Pointing" option, and then press MENU•SELECT to access the dish pointing screen.
5. Use the arrows on the remote or the front panel to highlight "Signal Meter" and then press MENU•SELECT.

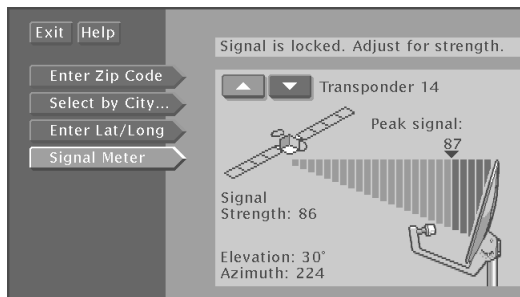

If the dish is pointed to the correct azimuth and elevation, the signal meter will show you the current signal strength (and you should hear a continuous tone).

If you are not receiving a signal, you need to incrementally adjust the azimuth setting on the dish. After you receive a signal, you will want to continue to adjust the azimuth to try to get the best possible signal.

Important

Changing transponders is not the same as fine-tuning the dish. Although the signal strength may appear to change, this may be due to different types of interference. To fine-tune the dish, consult the DSS Installation Guide and follow the instructions on adjusting the dish elevation and azimuth.

7 Dish Pointing...

Peak Signal

The "Peak Signal" indicates the highest signal strength you have obtained, which is not necessarily the highest possible signal.

While the maximum signal strength is 100, the signal strength you achieve will probably be less. Although there is no difference in picture quality between a signal strength of 60 and 85, the higher the signal, the less likely you are to experience negative effects in degraded conditions such as rain or snow (called "rain fade").

THE MENU SYSTEM

HOME CONTROL

Home Control lets you remotely control several lamps and appliances through your DSS® receiver. To control these devices, you must connect a Home Control Data Interface to the receiver and a remote module to the device you want to control. These devices are available as accessories sold through your digital satellite dealer or the accessories order form at the back of this book.

Once you have connected your Home Control devices, you can control them through the on-screen menus.

Home Control setup

The Home Control Data Interface connects to the LOW SPEED DATA port on the back of the receiver. Once connected, you must tell the receiver to use this port for Home Control.

1. Press MENU•SELECT to bring up the Main menu.
2. Point to and select *Options*.
3. Point to and select *System Options*.
4. Point to and select *Data Port* and choose *Home Control* as the default setting

Device Setup

1. From the Main menu select *Home Control*.



Home Control can control several devices.

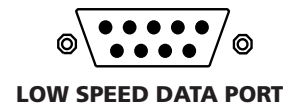

THE MENU SYSTEM

2. Select a device you would like to control.

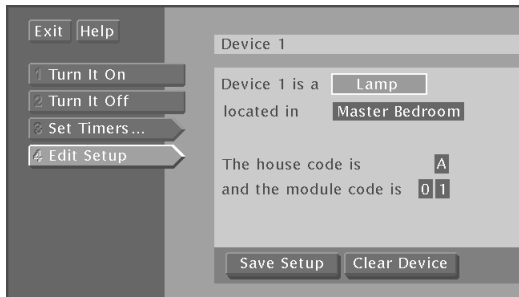

Keep track of devices by assigning a label.

3. Complete the on-screen sentence using the arrow buttons and MENU•SELECT. Press MENU•SELECT to scroll through the lists of appliances and locations.
4. Use the arrow buttons and MENU•SELECT to select the house and module codes that match the device's remote module. Select *Save Setup* to complete the setup.

Once the device is set up, there are two ways to control it. Select a device from the Home Control menu screen. You can turn it on and off, or schedule a timer that controls the device automatically.

Schedule a timer by completing the on-screen sentence.

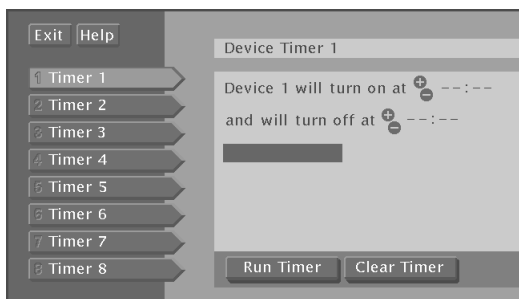

Complete the on-screen sentence to schedule a timer.

1. Use the arrows and MENU•SELECT to enter an *on* and *off* time.
2. Point to and select *Run Timer*.

If you want to change a device, select *Edit Setup*.

8 Home Control...

You can schedule several timers to control the same device at different times.

THE MENU SYSTEM

FETCH MENU

The Fetch menu is a list of favorite menu items that you define. Press the FETCH button on the remote. The Fetch menu appears. You can select up to eight menu items to appear in this menu.



The Fetch menu is a convenient way to call up frequently used menu items.

CUSTOMIZE THE FETCH MENU

To add an item to the Fetch menu, you must first point to an item in the menu system. Not all menu items can be added to the Fetch menu.

For example, you can add the *About DSS* menu item to the Fetch menu.

1. Press MENU•SELECT to bring up the Main menu.
2. Point to and select *Options*
3. Point to *About DSS*, **but do not select it**. Instead, press FETCH on the remote. The Fetch menu appears.
4. Use the arrow up and down arrow buttons to point to where the new Fetch item should appear.
5. Press MENU•SELECT to confirm the selection.

These menu items can be placed in the Fetch menu.

- The Guides
- Edit Users
- Signal Meter
- Alternate Audio
- System Options
- System Test
- New Access Card
- Set VCR Type
- Remote Setup
- Picture Size
- RF Remote Setup
- Interactive Setup
- About DSS
- Translucency
- Default Guide
- Color Scheme

REFERENCE

HOW IT ALL WORKS

Although the DSS® system is simple to use, there are a number of parts in the system. Don't be overwhelmed. This section explains how these different parts work together to bring a picture to your screen.

WHAT'S IT FOR?

This section also describes the controls located on the front and back of the receiver.

WHAT ELSE CAN IT DO?

Your remote is capable of controlling other devices as well. This section tells you how to program the remote to control TVs, VCRs, Laserdisc players, and other equipment.

1 FIRST THINGS FIRST



2 PROGRAM GUIDES



3 THE MENU SYSTEM



4 REFERENCE



5 APPENDICES

REFERENCE

PARTS OF THE DSS® SYSTEM

One way to understand the DSS® system is to look at the different parts of the system—from the studio down to the DSS® receiver and remote control in your living room.

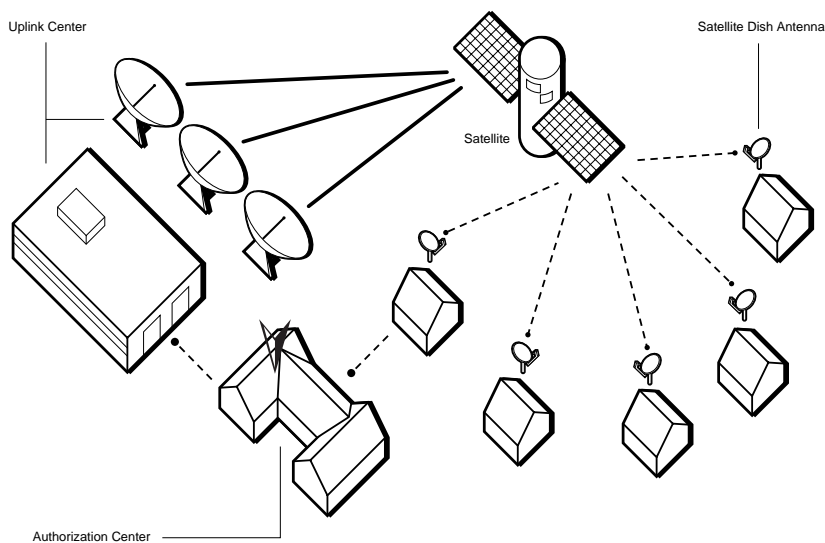

WORLD VIEW

These parts make up the DSS® system “big picture.”

Uplink Center Transmits programming up to the satellite.

Satellite Relays the programming signals back to your satellite dish. The satellite is parked above the equator, in geostationary orbit 22,300 miles above the earth.

DSS® Satellite Dish Antenna Receives the satellite signals. Because the satellite is so powerful, the dish can be as small as 18 inches.

Program Provider Authorization Center Processes billing statements. Your DSS® system is linked to the Service Center through the phone jack on the back of your DSS® receiver.

REFERENCE

HOME VIEW

These parts are inside of or attached to your house.

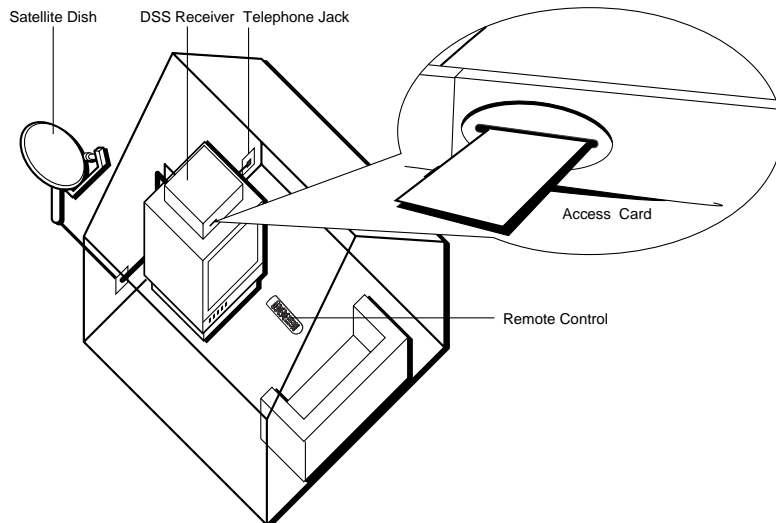

DSS® Satellite Dish Antenna Picks up the satellite's coded program information and relays it to your DSS® receiver. (Your satellite dish may be installed in different locations on or around your house. The satellite dish antenna must, however, be pointed in a southern direction toward the satellite.)

DSS® Receiver Receives the TV program information and sends it to your TV or VCR.

Telephone Jack Connects to the phone jack on the back of the DSS® receiver. The DSS® receiver uses a toll-free number once a month to update your access card. This update only takes a few seconds and ensures that you will have continuous service. The system automatically hangs up if you pick up the phone when the DSS® receiver is calling out.

Television If your television is remote controllable, you can program the DSS® Universal TV Remote to change channels and volume.

DSS® Universal Remote (included with your DSS® system)
Controls the DSS® system as well as most remote controllable TVs, VCRs, and other devices. Point the remote at the device you want to control.

Access Card (installed in DSS® receiver) Must be inserted for you to use the DSS® system! Provides system security and authorization of DSS® services. Do not remove the card except when issued a new card as a replacement for the original.

REFERENCE

CONTROLS AND BUTTONS

This part of the Reference sections discusses the controls and buttons located on the receiver and the remote control.

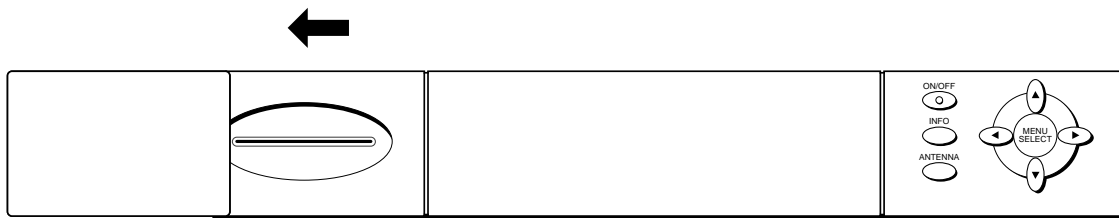

The Access Card door slides open so that you can replace the card when necessary.

FRONT PANEL CONTROLS

ON/OFF Turns the DSS® receiver's power on or off.

INFO Brings up the on-screen channel banner.

ANTENNA Switches the source of the video signal from satellite signals to an off-air antenna or cable signal.

ARROWS Press the navigation arrows to move the on-screen highlight up, down, left, or right. Using the arrows to highlight a menu item is also called "pointing." The up and down arrows also change channels.

MENU•SELECT Brings up the Main menu. If you are already in the menu system, press MENU•SELECT to select a highlighted choice.

ACCESS CARD Identifies you to your program providers. The DSS® system requires a valid access card.

REFERENCE

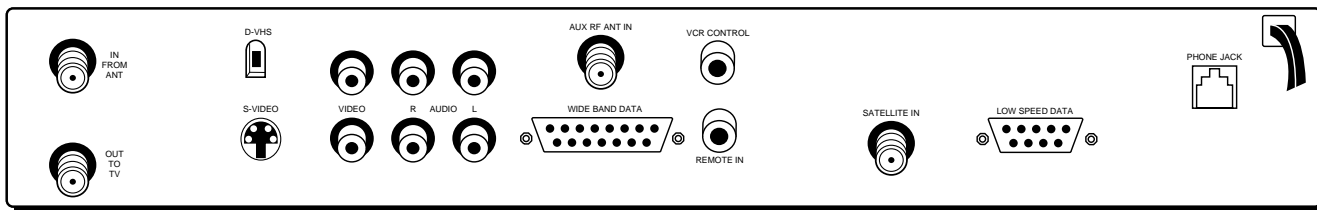

BACK PANEL CONTROLS

IN FROM ANT Use to connect an off-air antenna or cable TV signal to the DSS® system.

OUT TO TV Use to connect the DSS® receiver to your TV. However, if your TV has audio/video jacks, you should use those jacks to get better picture and sound quality.

D-VHS Use to connect the DSS® receiver to a compatible D-VHS VCR with a digital audio/video (DAV) cable.

S-VIDEO Provides the best picture quality. If your TV has S-VIDEO capability, use this jack along with the audio/video jacks to connect the DSS® receiver to your TV.

VIDEO Provides better picture quality than the OUT TO TV jack. If your TV has audio/video capability, use this jack to connect the DSS® receiver to your TV. You must also connect the AUDIO jacks.

AUDIO (R and L) Provide better sound quality than the OUT TO TV jack. If your TV has audio/video capability, use these jacks to connect the DSS® receiver to your TV. You must also connect the VIDEO jack.

AUX RF ANT IN Use to connect an optional RF antenna for RF remote signals. Connecting an antenna extends the remote's range.

WIDE BAND DATA PORT This port allows you to connect the DSS® system to future services and accessories. A shielded cable and additional hardware may be required.

LOW SPEED DATA PORT this port allows you to connect the DSS® system to accessories, such as the Home Control base module.

SATELLITE IN Use to connect the DSS® receiver to the satellite dish antenna.

PHONE JACK Use to connect a phone line to the DSS® receiver. The DSS® system requires a phone line connection to periodically call out to program providers.

VCR CONTROL Allows the receiver to control your VCR.

REMOTE IN Use in conjunction with a remote control signal sender.

REFERENCE

REMOTE CONTROL BUTTONS

POWER Turns the device you are controlling on or off.

TV Tells the remote to control the TV.

VCR Tells the remote to control the VCR.

AUX Tells the remote to control an alternative device connected to your TV.

DSS1/DSS2 Lets you control two DSS® receivers. Turns on the DSS® receiver and tells the remote to control DSS® system functions. DSS1 is the default. Choose DSS2 in the *System Options* control panel.

GUIDE Brings up the on-screen program guide. Press the GUIDE button several times to toggle through the different types of guides.

FETCH Brings up the Fetch menu. Use the arrows and MENU•SELECT to point and select a menu item.

WHO Press the WHO button one or more times to toggle through your user profiles.

CLEAR Removes the on screen displays and return to normal viewing.

MENU•SELECT Brings up the Main menu. If you are already in the menu system, press MENU•SELECT to select a highlighted choice.

ARROWS Use the navigation arrows to move the on-screen highlight up, down, left, or right. Using the arrows to highlight a menu item is also called "pointing."

INFO Brings up the on-screen channel banner. Press again to get program details.

ALT AUD (Alternate Audio) Use to toggle through the available languages or audio types for a program.

MUTE Turns off the sound. Press again to restore the sound.

GO BACK Moves you back and forth between your last two selected channels. In the menu system, returns you to the previous screen.

CHAN UP/DOWN Use to scan up and down through the channels in the current channel list. If you are in the program guide or menu system, use the CHAN UP/DOWN buttons to page up and down a screen at a time.

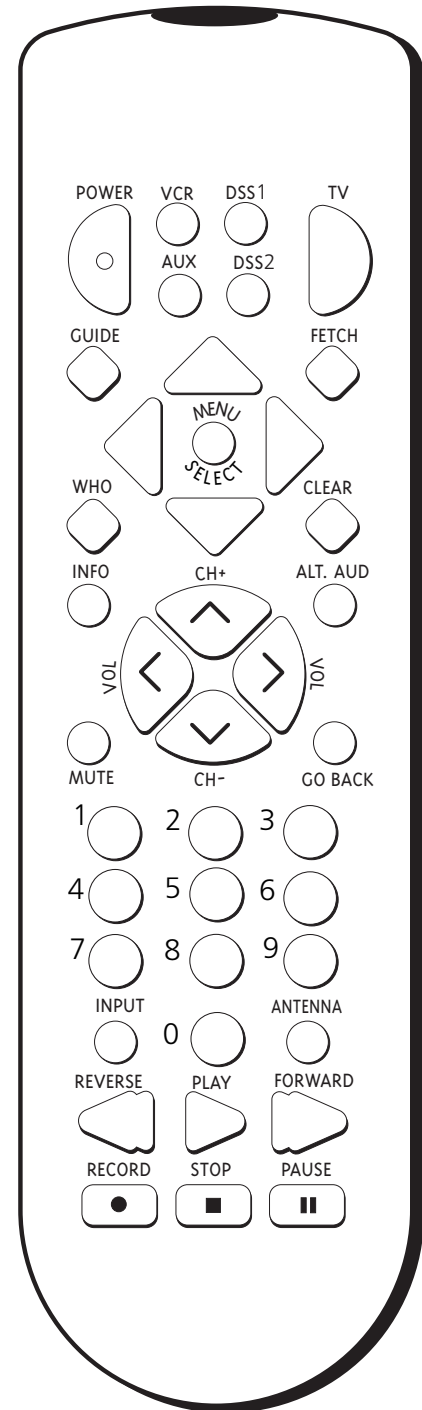

REFERENCE

VOL UP/DOWN Adjusts the audio volume.

DIGIT KEYS (0 - 9) Use the digit keys to tune directly to a channel. If you are in the menu system, use the digit keys to enter numbers for the time, date, channel and passwords.

INPUT In TV and VCR mode, press the INPUT button one or more times to toggle through the available video inputs.

ANT Lets you switch the source of the video signal from DSS® satellite signals to an off-air antenna or cable signal.

TRANSPORT Buttons (REVERSE, PLAY, FORWARD, RECORD, STOP, PAUSE) Use when controlling an auxiliary device, such as a VCR or Laserdisc player. Note that the RECORD button is used to schedule a timer recording when using a program guide.

PROGRAMMING THE REMOTE CONTROL

The DSS® remote can be programmed to control most brands of remote controllable TVs, VCRs, and cable boxes. The remote is programmed to control most RCA, GE and ProScan TVs and VCRs. The remote needs to be programmed to control other manufacturers' brands.

Using the Remote to Control a Second DSS® Receiver

The remote can control two DSS® receivers. From the Main menu, select *Options*, then *System Options*, then *Remote Setup*. Choose which button, DSS1 or DSS2, will control the DSS® receiver.

Changing the RF Remote Code

The remote can control the DSS® receiver using both IR (Infrared) signals and RF (radio frequency) signals. IR signals require line of sight to the receiver's front panel remote sensor. RF signals can control the receiver from other parts of your house—even through walls.

Occasionally, due to interference or other RF devices, you may need to change the remote and receiver RF code. Change the code in the *System Options* menu.

REFERENCE

PROGRAMMING THE REMOTE TO CONTROL YOUR TV

To determine whether your remote needs to be programmed, turn the TV on, point the remote at the TV, and press the TV button. Then press CHAN UP or DOWN to see whether the TV responds to the remote commands.

Follow these steps to program your remote to control your TV.

1. Turn on the TV.
2. Look up your brand and code number(s) on the TV Code list on the following pages.
3. Press and hold the TV button.
4. Enter the three-digit code from the code list.
5. Release the TV button and press OFF•ON or CHAN UP/DOWN to see if the TV responds to the remote commands. If it doesn't, try the next code listed for your brand.
6. Repeat these steps until the TV responds to the remote commands.

PROGRAMMING THE REMOTE TO CONTROL YOUR VCR

To determine whether your remote needs to be programmed, turn the VCR on, point the remote at the VCR, and press the VCR button. Then press POWER or CHAN UP or DOWN to see if the VCR responds to the remote commands.

Follow these steps to program your remote to control your VCR:

1. Turn on the VCR.
2. Look up your VCR brand and its code number on the code list on the following pages.
3. Press and hold the VCR button.
4. Enter the three-digit code from the code list.
5. Release the device button and press POWER or CHAN UP/DOWN to see if the VCR responds to the remote commands.
6. Repeat these steps using the next code listed for your brand until the VCR responds to the remote commands.

This remote may not operate all models of the brands that are shown. Use the codes shown in this manual, or on the sheet packed with your remote.

After you program the remote to control your TV, record your TV code here for easy reference.



This remote may not operate all models of the brands that are shown. Use the codes shown in this manual, or on the sheet packed with your remote.

After you program the remote to control your VCR, record your VCR code here for easy reference.



REFERENCE

PROGRAMMING THE REMOTE TO CONTROL OTHER DEVICES

The AUX button is a device button that can be programmed to control a second VCR, a cable box, or a laserdisc player.

1. Turn on the device to be programmed.
2. Look up your brand and its code number on code list on the following pages.
3. Press and hold the AUX button.
4. Enter the three-digit code from the code list.
6. Release the AUX button and press POWER or CHAN UP/DOWN to see if the device responds to the remote commands.
7. Repeat these steps using the next code listed for your brand until the device responds to the remote commands.

This remote may not operate all models of the brands that are shown. Use the codes shown in this manual, or on the sheet packed with your remote.

After you program the remote to control a device, record your AUX code here for easy reference.



USING THE REMOTE BUTTONS TO CONTROL A DEVICE

Once the remote has been programmed with the correct codes, you are ready to use it to control your devices.

To operate the device:

1. Press the device button (TV, DSS1, DSS2, VCR, or AUX) to set the remote to control the device.
2. Press POWER to turn the device off or on.
3. Use the remote buttons that apply to that device.

REFERENCE

REMOTE CODES

TV Codes

A-Mark.....	102	Kawasho	002, 011, 027	Sampo	011, 027
Admiral	005, 114	Kenwood	006, 011, 014, 027	Samsung	006, 011, 014, 015,
Akai	002, 103	Kloss Novabeam	035, 043	019, 027,036, 037, 077,110
Amtron	064	KTV	078	Sanyo	017, 021, 039, 056, 057, 058
Anam	104,105	Loewe	013	Scott	028, 037, 064
Anam National	038, 106	Luxman	011, 027	Sears.....	000, 006, 011, 014, 017, 018,
AOC.....	011, 019, 027, 088, 107	LXI	000, 013, 018, 021, 023, 054	021, 023, 027,039, 040, 041,
Bell & Howell.....	005, 013	Magnavox....	006, 007, 010, 011, 013,	051, 071, 083, 095
Candle.....	011, 027, 033	016, 027, 033,035, 043,	Sharp....	011, 020, 025, 027, 037, 052,
Citizen.....	011, 027, 033, 064	049, 066, 087, 089	053, 059, 060, 108
Colortyme	011, 027, 084	Marants	013	Signature	005, 094, 108
Concerto	011, 027	Marantz	011, 013, 027, 069	Sony	002
Contec/Cony .	036, 037, 040, 042, 064	Memorex	005	Soundesign	011, 027, 033
Craig	064	MGA.....	006, 011, 014, 019, 022,	Sylvania.....	006, 007, 010, 011, 013,
Curtis Mathes	000, 011, 015, 027, 037	027, 041, 056, 061, 068	016, 027, 033, 035, 043,
CXC	064	Mitsubishi	006, 011, 014, 019, 022,	049, 066, 087, 089
Daewoo	011, 019, 027, 112, 116	027, 041,055, 056,	Symphonic	064, 076, 115
Daytron	011, 027	061, 068, 108, 117	Tatung	038
Dimensia	000	MTC.....	011, 019, 027	Technics	012
Electrohome	006, 011, 014, 027,	Multivision.....	081	Techwood	011, 027
.....	038, 061, 068	NAD	018, 023	Teknika	011, 019, 027, 033,
Emerson	011, 026, 027, 028, 029,	NEC	011, 014, 019, 027, 038, 084	036, 037, 040, 066
.....	030, 031, 032, 037,042, 053,	Panasonic.....	012, 013, 038, 086, 111	Telecaption	090
.....	064, 065, 067, 075, 076, 078,	Penney .	000, 008, 011, 019, 027, 040,	TMK	011, 027
.....	079, 094, 095, 096	068, 077, 086, 088	Toshiba	018, 021, 023, 040,
Envision	011, 027	Philco ...	006, 007, 010, 011, 013, 016,	071, 077, 085, 090
Fisher	017, 021, 039, 041	019, 027,033, 035, 037, 038,	Universal	008, 009
Funai	064	043, 087, 089	Victor	051
GE.....	000, 008, 009, 011, 012, 027,	Philips	002, 006, 007, 010, 011,	Vidtech	019, 027
.....	038, 068, 086, 089, 091,116	013, 016, 033,035, 037,	Wards.....	000, 005, 006, 007, 008,
Goldstar	003, 004, 006, 011, 019,	038, 043, 066, 073	009, 010, 011, 013,019,
.....	027, 037, 050	Pioneer .	011, 027, 045, 062, 093, 113	025, 027, 028,035, 043,
Hallmark	011, 027	Portland	011, 019, 027, 037	059, 066, 076, 082, 089
Hitachi	009, 011, 027, 036, 037,	ProScan	000	Yamaha.....	006, 014, 019, 027
.....	040, 047, 048, 063,	Proton.....	011, 027, 037, 072, 118	Zenith	001, 099, 114
.....	080, 094, 097, 098	Quasar	012, 038, 092, 111		
Infinity	013	Radio Shack	000, 021, 025, 036,		
JBL.....	013	037, 059, 064, 078		
Jensen	011, 027	RCA	000, 006, 011, 019, 027, 034,		
JVC	012, 024, 036, 037,	038, 044, 046, 088, 100, 101, 109		
.....	040, 048, 051, 074	Realistic.....	021		

Laserdisc/DVD Player Codes

RCA	033, 037
RCA (DVD Player)	078
Pioneer	033,033
ProScan	033,037

REFERENCE

VCR Codes

Admiral.....	006, 079	JVC.....	002, 014, 016, 030, 046, 074	Samsung.....	007, 013, 022, 032, 042
Aiwa.....	015	Kenwood.....	002, 014, 016, 030, 044, 046	Sansui.....	016, 071
Akai.....	003, 017, 022, 023, 063, 066	KLH.....	073	Sanyo.....	002, 012
Audio Dynamics.....	014, 016	Lloyd's.....	015	Scott.....	004, 013, 041, 049, 068
Bell & Howell.....	002	Logik.....	031	Sears.....	002, 005, 009, 012, 018, 019, 035, 043, 048
Broksonic.....	010	Magnavox.....	008, 029, 053, 056	Sharp.....	006, 024, 027, 039, 045
Candle.....	007, 009, 013, 044, 045, 046, 052	Marantz.....	002, 008, 014, 016, 029, 030, 044, 046, 061	Shintom.....	017, 026, 031, 055
Canon.....	008, 053	Marta.....	009	Signature.....	015
Capehart.....	001	MEI.....	008	Sony.....	017, 026, 038
Citizen.....	007, 009, 013, 044, 045, 046, 052	Memorex.....	008, 009, 012, 015	Sylvania.....	008, 015, 029, 053, 056
Colortyme.....	014	MGA.....	004, 027	Symphonic.....	015
Craig.....	007, 012	Midland.....	032	Tandy.....	002, 015
Curtis Mathes.....	000, 007, 008, 014, 015, 044, 046, 053, 064, 067	Minolta.....	005, 035	Tashiko.....	009
Daewoo.....	013, 045, 052, 076	Mitsubishi.....	004, 005, 027, 035, 040	Tatung.....	030
dbx.....	014, 016	Montgomery Ward.....	006	Teac.....	015, 030, 069
Dimensia.....	000	MTC.....	007, 015	Technics.....	008
Dynatech.....	015	Multitech.....	007, 015, 031, 032	Teknika.....	008, 009, 015, 021
Electrohome.....	027	NEC.....	002, 014, 016, 030, 044, 046, 059, 061, 064	Toshiba.....	005, 013, 019, 048, 049
Emerson.....	008, 009, 010, 013, 015, 020, 023, 027, 034, 041, 042, 047, 049, 057, 062, 065, 067, 068, 070	Panasonic.....	008, 053, 075, 077	Totevision.....	007, 009
Fisher.....	002, 012, 018, 019, 043, 048, 058	Pentax.....	005, 035, 044	TMK.....	067
Funai.....	015	Pentex Research +.....	046	Unitech.....	007
GE.....	000, 007, 008, 032, 037, 053	Philco.....	008, 029, 053, 056	Vector Research.....	014, 016, 044
Goldstar.....	009, 014, 046, 060	Philips.....	008, 029	Victor.....	016
Harman Kardon.....	014	Pioneer.....	005, 016, 050	Video Concepts.....	014, 016, 044
Hitachi.....	005, 015, 035, 036	Portland.....	044, 045, 052	Videosonic.....	007
Instant Replay.....	008	ProScan.....	000	Wards... ..	005, 006, 007, 008, 009, 012, 013, 015, 025, 027, 031, 035
JCL.....	008	Quartz.....	002	Yamaha.....	002, 014, 016, 030, 046
JC Penney.....	002, 005, 007, 008, 014, 016, 030, 035, 051, 053	Quasar.....	008, 053	Zenith.....	011, 017, 026, 072, 079
		RCA.....	000, 005, 007, 008, 028, 035, 037, 054, 069		
		Radio Shack/Realistic ..	002, 006, 008, 009, 012, 015, 019, 027, 043, 053		

Cable Box/Satellite Receiver Codes

ABC.....	022, 046, 053, 054	NSC.....	009	Sprucer.....	027
Anvision.....	007, 008	Oak.....	001, 016, 038	Starcom.....	046
Cablestar.....	007, 008	Oak Sigma.....	016	Stargate 2000.....	058
Diamond.....	056	Panasonic.....	003, 027, 039, 061	Sylvania.....	011, 059
Eagle.....	007, 008	Philips.....	007, 008, 019, 021, 026, 028, 029, 032, 033, 040, 041	Teknika.....	006
Eastern Int.....	002	Pioneer.....	018, 020, 044	Texscan.....	010, 011, 059
General Instrument.....	046	RCA.....	000, 027	Tocom.....	017, 021, 049, 050, 055
GI 400.....	004, 005, 015, 023, 024, 025, 030, 036	RCA (Satellite Receiver).....	066	Unika.....	031, 032, 041
Hamlin.....	003, 012, 013, 034, 048	Randtek.....	007, 008	Universal.....	051, 052, 060
Hitachi.....	037, 043, 046	Regal.....	003, 012, 013	Viewstar.....	007, 008, 019, 021, 026, 028, 029, 032, 033, 040, 041
Jerrold... ..	004, 005, 015, 023, 024, 025, 030, 036, 045, 046, 047, 062, 065	Regency.....	002, 033	Warner Amex.....	044
Macom.....	037, 043	Samsung.....	044	Zenith.....	014, 042, 057, 061
Magnavox.....	007, 008, 019, 021, 026, 028, 029, 032, 033, 040, 041	Sci. Atlanta ...	003, 022, 035, 063, 064		
		Signature.....	046		
		Sony (Satellite Receiver).....	095		

REFERENCE

GLOSSARY

The following is a list of terms used in this manual. There is also a glossary contained within the *About DSS* menu of your DSS® system.

Access Card Identifies you to the DSS® system service providers and is required for your DSS® system to work. Do not remove the access card except when a new card has been issued to replace the original.

Agile Modulator Lets you choose an output channel when sending the DSS® signal to a television from the OUT TO TV jack on the receiver.

Alternate Audio Refers to the different audio channels that may be broadcast in conjunction with a video program. A foreign language translation is an example.

Attractions Previews of special programs broadcast by your program provider.

Azimuth Refers to the left-to-right positioning of your DSS® dish antenna. When you enter your zip code (or latitude and longitude), the display screen provides the number corresponding to an azimuth setting for your location.

Channel Banner Displays program information and menu items displayed as icons when you tune to a channel, exit a guide or press INFO on the remote. Point to and select the icons to access the menu items.

Channel List Allows you to select which channels can be viewed when the system is locked.

Digital Audio/Video (DAV) A means for transmitting audio and video signals in digital format. The DSS® receiver has a D-VHS jack that lets you connect a digital audio/video (DAV) cable from the receiver to a D-VHS VCR.

Dish Pointing The dish antenna must be pointing directly to the satellites to receive the DSS® signal. Obtain dish pointing coordinates and check signal strength in the *Dish Pointing* menu screen.

DSS® Receiver Receives, processes, and converts the digitally compressed satellite signals into audio and video.

Elevation Refers to the up and down positioning of your DSS® dish antenna. When you enter your zip code (or latitude and longitude), the display screen provides the number corresponding to the elevation setting for your location.

Home Control Home Control lets you remotely control several lamps and appliances through your DSS® receiver. To control these devices, you must connect a Home Control base module to the receiver and a remote module to the device you want to control.

Limits The Ratings Limit allows you to control program viewing of rated programs by ratings level. The Spending Limit controls spending on a cost-per-program basis. The Viewing Limit controls *when* and *how many hours* a user can view programming. The Channel List allows you to select which channels can be viewed when the system is locked.

Locks The means of restricting access to certain features of the DSS® system. The lock is controlled by a 4-digit password. The closed or open lock icon in the channel marker indicates whether your system is locked or unlocked.

REFERENCE

Mailbox Stores incoming electronic messages sent to you by your program providers. The Mailbox is accessed through the on-screen menu system.

Main Menu The first list of choices in the DSS® system on-screen menus. Press the MENU button on the remote or front panel to bring up the Main menu.

Past Purchases Detailed list of the programs that you have already purchased and viewed.

Point and Select The method of using the remote control (or front panel) buttons to navigate to and make choices among the different parts of the on-screen displays.

Profiles Allows you to create lists and limits for individual users, as well as set up limits for the whole system.

Program Guide Lists the programs and services available from your program providers.

Ratings Limit Provides a means of restricting viewing of rated programs, based on program rating information. The operation of this feature depends upon the availability and accuracy of data supplied from and broadcast by the program provider.

Signal Meter An on-screen display that indicates the relative strength of the satellite signal and sounds a test tone to help you lock in on the satellite signal. The signal meter is used when you adjust your DSS® dish antenna.

Spending Limit Provides a means of restricting viewing, based on cost-per-program limit.

System Test Provides a diagnostics check that can be used to determine that the main components of the DSS® system—signal, tuning, phone, and access card—are connected and working properly.

TV/DSS® Buttons Remote control buttons that toggles the input signal to your TV from the antenna or cable signals to the satellite signal. Similar in function to that of TV/VCR buttons on some VCRs and remote controls.

Themes Provides a way to simplify the Program Guide and make it easier to find programs of special interest to you.

Topic Use the Topics screen to sort the guide to show only programs of a particular topic, such as Movies or Sports.

Upcoming Purchases Detailed list of the programs you have purchased but have not yet been broadcast.

Whole-House Distribution System A device which receives signals, amplifies them, and sends them to other televisions within your home.

REFERENCE

TROUBLESHOOTING

The DSS® System Test allows you to run a basic diagnostics check on your DSS® system. If you are experiencing any trouble with your system, run the system test.

Make sure that

- All connections—jacks, cables, etc. are correctly in place. See the section, *Connecting Your DSS® Receiver*, for more information.
- There are batteries in the remote, and that they are working correctly.
- The access card is installed in the receiver.

RUNNING THE SYSTEM TEST

Follow these steps to run the diagnostics system test on your system.

1. Turn on your TV and the DSS® receiver.
2. Press DSS to put remote in DSS® system mode, then press MENU•SELECT to bring up the Main menu.
3. Point to and select *Options*.
4. Point to and select *System Options*.
5. Point to and select *System Test*.
6. If your system does not pass the system test, check any of these potential trouble areas: cabling, pointing the satellite dish, phone connection, and access card.
7. If you continue to have problems, call 1-800-679-4776.

APPENDIX A: WARRANTY INFORMATION

Toll-Free Telephone Product Help

You can reach Thomson Consumer Electronics at the following number: 1-800-679-4776 (Toll free inside U.S.A.) Thomson provides a toll-free telephone number to help you with any problems you may encounter with your DSS® System, as many problems can be diagnosed over the phone. If necessary, a replacement unit can be shipped to you. **Please have your DSS® System model/serial number and date of purchase ready when you call.** If your unit is out of warranty, we will quote the cost of an exchange unit to you.

Returning Equipment to Thomson for Repair or Exchange

If we are unable to resolve your problem over the phone we will gladly service your unit or exchange it for a new or refurbished unit. Refer to the limited warranty included in the booklet to learn about your specific rights and responsibilities. *Always consult Thomson and get a Return Authorization number before returning anything.* Obtain a Return Authorization (RA) number from the telephone representative before returning your equipment to avoid delays, accounting errors, or even loss of your unit.

Important Information to Customers Who Ship Defective Equipment to Thomson Consumer Electronics

The Thomson representative who authorizes the return of your equipment will give you an RA number over the phone. The representative will also provide you with instructions on where and how to return your unit. Write the number in large, clear characters on the outside of the box. *To avoid confusion and misunderstandings, shipments without an RA number clearly visible on the outside of the box will be returned to you at your expense.*

Include a brief note describing the problem and any conversations you have had with Thomson personnel about the problem. Include your name, address and model/serial number of your unit. These numbers are located on the back of your receiver. If your DSS® System is within the warranty period, please provide a copy of the bill of sale to verify purchase date. Use the original box and packing material to protect the equipment from damage in shipment. **For your protection, insure all shipments for full replacement value and use a reliable shipper.** Thomson assumes no responsibility for warranty shipments from the customer to the factory if not shipped in the manner prescribed by Thomson.

RCA DIGITAL SATELLITE SYSTEM LIMITED WARRANTY

What your warranty covers:

- Any defect in materials or workmanship.

For how long after your purchase:

- 90 days - Unit exchange, which includes parts and labor.
- 91 days to 1 year - Unit exchange, which includes parts only; you pay the labor.
- The warranty for rental units begins with the first rental or 45 days from date of shipment to the rental firm, whichever comes first.

What we will do:

- **During the initial 90 days:**
Exchange the defective portion of your DSS® with a new or, at our option, refurbished unit.
- **After the 90 days and within one year:**
Exchange the defective portion of your DSS® with a new or, at our option, refurbished unit. We will bill you a flat exchange charge to replace a defective receiver. This charge covers the labor cost for its repair. Labor costs for the removal and re-installation of any equipment are your responsibility.

APPENDIX A: WARRANTY INFORMATION

How you get service:

- Call 1-800-679-4776 and have your unit's date of purchase and model/serial number ready. The model/serial number information is on the back of your receiver.
- A representative will troubleshoot your problem over the phone.
- If the representative determines that you should receive a replacement receiver you will be provided with a Return Authorization (RA) number and the location of a nearby exchange point if one exists. No returns will be accepted without the RA number.
- If the representative determines that your antenna/dish is defective they will arrange for its repair or replacement.

To receive a replacement receiver before you return yours:

If you are located near an exchange point:

1. We will send a replacement unit to our exchange point next business day delivery in the continental U.S.A.
2. The exchange location will notify you of its arrival.
3. Take your unit and evidence of purchase date, such as a bill of sale, to the exchange location and you will be provided the new or refurbished unit. Please retain all accessories such as the remote control hand unit.
4. If the repairs are covered by your warranty, you will not be billed.

If you are not located near an exchange point:

1. Provide your Discover, Mastercard or Visa account number and expiration date to your phone representative. This is for security purposes only and your account will not be charged at this time.
2. We will send you a replacement unit next business day delivery in the continental U.S.A.
3. If you return the unit to us within 14 days from the date you were provided a RA number, only items not covered by warranty will be charged to your account. If your unit is not received within 14 days, the suggested retail value of the receiver will be charged to your credit card. This amount will be credited if the unit is subsequently received.
4. Ship your defective unit back to us using the replacement unit's carton. Shipping instructions will be included on the carton along with your RA number which will allow you to easily ship the unit back to us. Make sure you insure your shipment in case of damage or loss. Include with the shipment:
 - Evidence of purchase date such as a bill of sale.
 - A brief note describing your receiver problem.
 - Your name, address and phone number.

Thomson assumes no responsibility of warranty shipments from the customer to the factory if not shipped in the manner prescribed by Thomson.

To receive a replacement receiver after we have received your unit:

- Write the RA number on the outside of the carton used to return the unit. Make sure you insure your shipment in case of damage or loss.
- Carefully pack the unit using the original box and packing material if possible. Please retain all accessories that were included with your unit such as the remote control hand unit.
- Include with the shipment:
 1. Evidence of purchase date such as a bill of sale.
 2. A brief note describing your receiver problem.
 3. Your name, address and phone number.
- The representative will advise the address to mail a cashier's check or money order for payment if there are any out of warranty labor or parts charges, and you elect not to use your credit card.
- After we receive your product, a new or refurbished unit will be shipped to you next business day delivery in the continental U.S.A.

APPENDIX A: WARRANTY INFORMATION

What your warranty *does not* cover:

- Acts of God, such as but not limited to lightning damage.
- Adjustment of customer controls.
- Damage from misuse or neglect.
- A unit that has been modified or incorporated into other products or is used for institutional or other commercial purposes.
- Batteries.
- Units purchased, serviced or operated outside the U.S.A.
- For units intended for use in Alaska, this warranty does not cover installation or the dish antenna. It only covers the DSS receiver.
- Loss of programming.
- Installation.
- Shipping damage if the unit was not packed and shipped in the manner prescribed by Thomson.
- Storage fees may be charged by the exchange point if you fail to pickup the replacement unit in a timely manner.

Product Registration:

- Please complete and mail the Product Registration Card packed with your DSS® product. It will make it easier to contact you should it ever be necessary. The return of the card is not required for a warranty coverage.

How state law relates to warranty:

- This warranty gives you specific legal rights and you may have other rights that vary from state to state.

If you purchased your product outside the United States:

- This warranty does not apply. See your dealer for warranty information.

APPENDIX B: FCC REGULATIONS

FCC Registration Information

Your DSS® equipment is registered with the Federal Communications Commission and is in compliance with parts 15B and 68, FCC Rules and Regulations.

1. Notification to the Local Telephone Company.

On the bottom of this equipment is a label indicating among other information, the FCC Registration number and Ringer Equivalence Number (REN) for the equipment. You must, upon request, provide this information to your telephone company.

The REN is useful to determine the number of devices you may connect to your telephone line and still have all these devices ring when your telephone number is called. In most (but not all) areas, the sum of the RENs of all devices connected to one line should not exceed 5. To be certain of the number of devices you may connect to your line as determined by the REN, you should contact your local telephone company.

Notes: This equipment may not be used on coin service provided by the telephone company.

Party lines are subject to state tariffs, and therefore, you may not be able to use your own telephone equipment if you are on a party line. Check with your local telephone company.

Notice must be given to the telephone company upon permanent disconnection of your DSS® equipment from your line.

2. Rights of the Telephone Company.

Should your equipment cause trouble on your line which may harm the telephone network, the telephone company shall, where practicable, notify you that temporary discontinuance of service may be required. Where prior notice is not practicable and the circumstances warrant such action, the telephone company may temporarily discontinue service immediately. In case of such temporary discontinuance, the telephone company must: (1) promptly notify you of such temporary discontinuance (2) afford you the opportunity to correct the situation and (3) inform you of your right to bring a complaint to the Commission pursuant to procedures set forth in Subpart E of Part 68, FCC Rules and Regulations.

The telephone company may make changes in its communications facilities, equipment, operations of procedures where such action is required in the operation of its business and not inconsistent with FCC Rules and Regulations. If these changes are expected to affect the use or performance of your telephone equipment, the telephone company must give you adequate notice, in writing, to allow you to maintain uninterrupted service.

Radio Interference

This equipment has been type tested and found to comply with the limits for a Class B Digital Device in accordance with the specifications in Part 15 of FCC Rules. These rules are designed to provide reasonable protection against radio and television interference in a residential installation. This equipment generates, uses and can radiate radio frequency energy and, if not installed and used in accordance with the instructions, may cause harmful interference to radio communications. However, there is no guarantee that interference will not occur in a particular installation.

If this equipment does cause interference to radio or television reception (which you can determine by turning the equipment off and on), try to correct the interference by one or more of the following measures.

- Reorient or relocate the receiving antenna (that is, the antenna for radio or television that is "receiving" the interference).
- Change the position of the DSS® satellite receiver with respect to the radio or television equipment that is receiving interference.
- Move the DSS® satellite receiver away from the equipment that is receiving interference.
- Plug the DSS® satellite receiver into a different wall outlet so that the DSS® satellite receiver and the equipment receiving interference are on different branch circuits.

If these measures do not eliminate the interference, please consult your dealer or an experienced radio/television technician for additional suggestions. Also, the Federal Communications Commission has prepared a helpful booklet, "How To Identify and Resolve Radio/TV Interference Problems". This booklet is available from the U.S. Government Printing Office, Washington, D.C. 20402. Please specify stock number 004-000-00345-4 when ordering copies.

APPENDIX C: ACCESSORIES

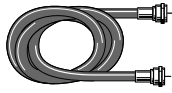

RG-6 Coaxial Burial Cable with weatherproof "F" connectors

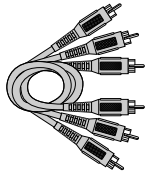

Stereo Audio/Video Cable with gold RCA-type connectors

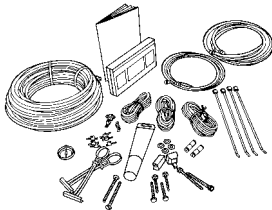

Self-Installer's Kit contains cable and hardware to install the dish and connect the system.

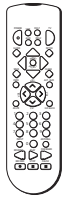

Remote Control replaces a lost remote. Or, order a second remote for convenience.

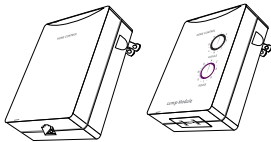

HCDSS10 Home Control Kit contains a Data Interface that connects to the DSS® receiver, and a lamp module.



HC10LM Lamp module lets you control incandescent lamps only.



HC20AM or HC25AM Appliance modules turn appliances, like coffee pots, popcorn makers, or stereo, on or off. Choose 2 or 3 prong.



Detach Here

Accessory Order Form for Digital Satellite Systems

Description	Part No.	Price	Qty
RG-6 Coaxial Cable			
12 feet	D912	\$12.95	
25 feet	D925	\$15.95	
50 feet	D950	\$21.95	
75 feet	D975	\$29.95	
100 feet	D901	\$29.95	
Stereo Audio/Video Cable			
6 feet	D906	\$12.95	
12 feet	D914	\$14.95	
S-Video Cable	D913	\$12.95	
Weatherproof "F" Connector (2)	D905	\$ 5.30	
Grounding Block for RG-6 Cable	D902	\$ 2.95	
TVRO Bullet Amplifier	D903	\$24.95	
Self-Installer's Kit	DKIT96	\$69.95	
Remote Control	232578	\$42.15	
Home Control Kit	HCDSS10	\$59.95	
Lamp Module	HC10LM	\$14.95	
2-Prong Appliance Module	HC20AM	\$16.95	
3-Prong Appliance Module	HC25AM	\$16.95	

Prices are subject to change without notice.

Total Merchandise (\$10 Minimum Order) \$ _____

Sales Tax \$ _____

We are required by law to collect the appropriate sales tax for each individual state, country, and locality to which the merchandise is being sent.

Shipping, Handling, and Insurance \$ 5.00

Total Amount Enclosed \$ _____

Use VISA or MasterCard preferably.

Money order or check must be in U.S. currency only.

No COD or CASH.

All accessories are subject to availability. Where applicable, we will ship a superseding model.

Please complete other side also

APPENDIX C: ACCESSORIES

Charge your order on your VISA, MasterCard, or Discover Card by filling in below

USE YOUR CREDIT CARD

IMPORTANT: Copy complete account number from your VISA card



My card expires:

IMPORTANT: Copy complete account number from your MasterCard



Copy Number My card expires:
 above your name on MasterCard

IMPORTANT: Copy complete account number from your Discover Card



My card expires:

AUTHORIZED SIGNATURE
 (Credit card order will not be processed without signature)
 Prices are subject to change without notice.

Print or type your name and address clearly. This will be your mailing label.



A complete and correct order will save you days of waiting.

Name: _____

Street: _____

_____ Apt: _____

City: _____

State: _____ Zip: _____

Please make sure that both sides of this form have been filled out completely.

- Allow 4 weeks for delivery.
- All accessories are subject to availability.
- Prices are subject to change

United States and Canada Orders

To place your order by phone, have your VISA, MasterCard or Discover Card ready and call the toll-free number listed below between 8AM and 8PM (EST) Monday through Friday or between 9AM and 5PM (EST) Saturday.

Use this number only to place an order for accessory items listed on this order form.

1-800-338-0376

To place your order by mail, detach and mail the completed order form with credit card information, money order or check in US currency (made payable to Thomson Consumer Electronics, Inc.) to the following address:

Video Accessories
PO Box 8419
Ronks, PA 17573

INDEX

A

- About DSS 49
- Access card 59
 - number 18
- Accessories 75
- Agile modulator 16
 - resetting 16
- All button 26
- AlphaSort button 27
- Alternative audio 51
- Alternative data 51
- Attractions Guide 24, 38

B

- Back panel controls 61
- Batteries
 - installing in the remote 5
- Buttons 62

C

- Cancelling purchases 39
- Channel banner
 - anatomy 21
 - icons 21
- Channel Guide 24
- Channel lists 43
 - add channels 44
 - delete channels 44
- Codes 66
- Connections 8
 - audio/video quality 10, 11, 12, 13
 - jacks and cables 9
 - VCR Controller 14

D

- D-VHS VCR 18
- Data port 21
- Default guide 22
- Detail Guide 22
- DIRECTV programming 18
- Dish Pointing 52
 - azimuth 52
 - elevation 52
 - menu 33

DSS

- back panel 61
- front panel 60
- system 4, 58
- system test 70
- troubleshooting 70

DSS receiver

- back panel 61
- connecting 6
- front panel 60

E

- Exiting
 - menus 32, 33
 - program guides 24, 30

F

- Fetch
 - customizing 56
 - items 56
 - menu 56
- Front panel controls 60

G

- Glossary 68
- Grid Guide 22
- GUIDE button 22
- Guides. *See Program guides*

H

- Help 4, 30
- Home Control 54
 - accessories 75
 - icon 21
 - menu 33
 - setup 54
 - timers 55

I

- Icons 21, 41, 47
- Interactive setup 18, 48

L

- Locking
 - a profile 46
 - the system 21, 43, 46
- Logo Guide 24
- Look and feel 49

M

- Mailbox
 - checking your mail 35
 - deleting mail 35
 - icon 21
- Main menu 30, 31, 35
- Menu system 4
 - exit 32
 - help 4, 32
 - icons 41, 47
 - navigation 7
- Menus
 - Dish Pointing 33, 52
 - Fetch 56
 - Home Control 33, 54
 - Mailbox 33, 35
 - Options 33, 48
 - Profiles 33, 43
 - Program Guide 33
 - Purchases 33
 - Timers 33, 41
- Movies button 26

O

- Options menu 33, 48
- Other Guides
 - Attractions Guide 38
 - button 23, 29
- Output channel 16, 50

INDEX

P

- Passwords 46
- Pay-per-view programs 36
 - tuning to 36
- Profiles
 - channel lists 43
 - choosing 47
 - locking 46
 - menu 33, 43
 - ratings limits 44
 - spending limits 45
 - unlocking 47
 - viewing hours 45
- Program guides 4, 19, 23
 - anatomy 20, 34
 - Attractions Guide 24
 - buttons 23
 - Channel Guide 24
 - default 22
 - Detail Guide 22
 - exiting 24, 30
 - Grid Guide 22
 - help 30
 - Logo Guide 24
 - scrolling 22
 - sorting 25
 - SurfGuide 22
 - tuning to a program 23
- Programming the Remote 63
 - to control a TV 64
 - to control a VCR 64
 - to control other devices 65
- Purchases 36
 - cancelling 39
 - menu 33, 39
 - previewing 36
 - reviewing 39
 - spending limits 40

R

- Ratings limit 44
- RECORD button 42
- Recording
 - with timers 42
- Remote control
 - batteries 5
 - buttons 62
 - codes 66
 - programming 5, 63, 64
 - using the 65
- Reviewing purchases 39

S

- Scout 28
 - button 28
 - results 28
- Scrolling 22
- Set VCR type 15
- Signal meter 53
 - peak signal 53
- Sorting
 - program guides 25
- Sorting by
 - All button 26
 - AlphaSort button 27
 - Movies button 26
 - Other Guides button 29
 - Scout button 28
 - Sports button 26
 - Topics button 25
- Spending limits 40, 45
- Sports button 26
- SurfGuide 22
- System lock 46
- System options 50
- System test 70
- System unlock 47

T

- Timer feature
 - editing or cancelling 41
 - setting up 42
- Timers
 - Home Control 55
 - icons 41
- Timers menu 33, 41
- Topics button 25
- Transponders 53
- Troubleshooting 70
- Tuning to a program 23

U

- Unlocking
 - a profile 47
 - the system 21, 47
- USB programming 18

V

- VCR (D-VHS) 18
- VCR Controller 9, 14
- Viewing hours limit 45

W

- Warranty information 71

If your DSS® system needs service, please contact your dealer or the nearest Servicenter from the yellow pages. Please do not send any products to the Indianapolis address listed in this manual or on the carton. This will only add delays in service for your product.

 **THOMSON CONSUMER ELECTRONICS**

10330 North Meridian Street
Indianapolis, IN 46290

©1997 Thomson Consumer Electronics, Inc.
Trademark(s)® Registered
Marca(s) Registrada(s)
Printed in USA
TOCOM 15270640



100%
RECYCLED PAPER
MINIMUM 50% POST CONSUMER

