

# RCA

## USER'S GUIDE

eiversatellitereceiversatellite  
eceiversatellitereceiversatellite  
ereceiversatellitereceiversatelli  
itereceiversatellitereceiversate  
llitereceiversatellitereceiversat  
tellitereceiversatellitereceiver  
satellitereceiversatellitereceive  
rsatellitereceiversatelliterecei  
versatellitereceiversatelliterec  
eiversatellitereceiversatellitere  
eceiversatellitereceiversatellit  
ereceiversatellitereceiversatelli  
itereceiversatellitereceiversate  
llitereceiversatellitereceiversa  
tellitereceiversatellitereceiver  
satellitereceiversatellitereceiv  
ersatellitereceiversatelliterece  
iversatellitereceiversatellitere  
ceiversatellitereceiversatellite  
receiversatellitereceiversatelli  
tereceiversatellitereceiversatel  
litereceiversatellitereceiversat  
ellitereceiver satellit  
ereceiversa sate  
llitereceiver ve  
rsatellit er  
eceive rsa  
tellite rece  
iversat elli  
terecei v  
ersatel



# SAFETY INFORMATION

## WARNING

To reduce risk of fire or shock hazard, do not expose this receiver to rain or moisture.

## WARNING

RISK OF ELECTRIC SHOCK  
DO NOT OPEN



This symbol indicates "dangerous voltage" inside the product that presents a risk of electric shock or personal injury.



This symbol indicates important instructions accompanying the product.

TO REDUCE THE RISK OF ELECTRIC SHOCK, DO NOT REMOVE COVER (OR BACK). NO USER SERVICEABLE PARTS INSIDE. REFER SERVICING TO QUALIFIED SERVICE PERSONNEL.

## Cautions

**Do not stack electronic components or other objects on top of the Digital Satellite Receiver.** The slots on top of the receiver must be left uncovered to allow proper airflow to the unit. Blocking the airflow to the unit could impair performance or damage your receiver and other components.

Do not stack the digital satellite receiver on top of a "hot component" such as an audio power amplifier.

FCC Regulations state that unauthorized changes or modifications to this equipment may void the user's authority to operate it.

Your system is equipped with an RF remote control. The RF remote control complies with Part 15 of the FCC Rules. Operation is subject to the following two conditions: 1) The RF remote may not cause harmful interference and; 2) The RF remote must accept any interference received, including interference that may cause undesired operation.

### Note to Cable TV Installer:

This reminder is provided to call your attention to article 820-40 of the National Electrical Code (Section 54 of the Canadian Electrical Code, Part 1) which provides guidelines for proper grounding and, in particular, specifies that the cable ground shall be connected to the grounding system of the building as close to the point of cable entry as practical.

### Note to Satellite Dish Installer:

This reminder is provided to call your attention to articles 810 and 820 of the 1999 National Electrical Code. Refer to article 810, in particular to 810-1 and 810-15, for required grounding of the metal structure of the Dish Antenna. Refer also to the 810-2 which, by reference to article 820, requires that the satellite dish coaxial cable shield be connected to the grounding system of the building as close to the point of cable entry as practical.

### IMPORTANT NOTICE:

This device incorporates an anticopy process technology that is protected by U.S. patents and other intellectual property rights. The anticopy process is licensed for non-commercial, home use only. Reverse engineering or disassembly is prohibited.

### Care and Cleaning:

Use a soft cloth or dusting attachment of your vacuum cleaner to dust your digital satellite receiver. Remove dust from the ventilation holes on the top and bottom.

Plastic surfaces are easily scratched and can be marred by alcohol and various solvents. Avoid excessive use of oil-based furniture polishes since the materials used in the cabinet will accumulate more dust. A non-abrasive, anti-static cleaner/polisher is recommended.

### Product Registration

Please fill out the product registration card and return it immediately. Returning the card allows us to contact you if needed.

Keep your sales receipt to obtain warranty parts and service and for proof of purchase. Attach it here and record the serial and model numbers in case you need them. The numbers are located on the back of the digital satellite receiver.

Model No. \_\_\_\_\_

Serial No. \_\_\_\_\_

Purchase Date: \_\_\_\_\_

Dealer/Address/Phone: \_\_\_\_\_

# TABLE OF CONTENTS

<b>SETUP AND CONNECTIONS</b> .....	<b>3</b>
Step 1: Unpack the DIRECTV PLUS™ System .....	4
Step 2: Connect Your Digital Satellite Receiver .....	4
Things To Know Before Connecting Components .....	4
Jacks and Cables .....	5
Back of the Digital Satellite Receiver .....	6
Top of the Digital Satellite Receiver .....	6
Basic Connection .....	8
Advanced Connection .....	10
RF Remote Antenna Connection .....	12
Digital Audio Output Connection .....	13
Step 3: Place Batteries In the Remote Control .....	14
Step 4: Plug In and Turn On the Digital Satellite Receiver .....	14
Step 5: Connect the VCR Controller .....	14
Step 6: Using Point and Select .....	16
Step 7: Interactive Setup .....	16
Step 8: Order Programming .....	16
<b>USING THE REMOTE</b> .....	<b>17</b>
Remote Control Buttons .....	18
Programming the Remote Control .....	20
Testing the Remote Control .....	20
Using the Remote to Control a Device .....	21
Modes of Operation .....	21
Controlling a Second Satellite Receiver .....	22
Changing the RF Remote Control Code .....	22
<b>PROGRAM GUIDES</b> .....	<b>25</b>
Anatomy Of a Program Guide .....	26
The Channel Banner .....	27
Using the GUIDE Button .....	28
Getting Around In the Guides .....	28
Tuning To a Program .....	29
Additional Program Guides .....	30
Sorting the Guides .....	32
<b>THE MENU SYSTEM</b> .....	<b>37</b>
Using the Menu System .....	38
The Program Guide .....	40

# TABLE OF CONTENTS

Messages .....	41
Mail .....	41
Caller ID .....	42
Using the Purchases Menu .....	45
Reviewing and Canceling an Upcoming Purchase .....	45
Spending Limits .....	46
Pay Per View Programs .....	46
Previewing and Purchasing .....	47
Using the Attractions Guide .....	48
Timers Feature .....	49
Profiles .....	51
Creating a Profile Channel List .....	51
Setting the Rating Limit .....	52
Viewing Hours .....	53
Setting Up Spending Limits .....	53
Locking a User's Profile .....	54
Locking the System .....	54
Choosing Your Profile .....	56
Options .....	57
Interactive Setup .....	57
System Info .....	57
Look and Feel .....	58
System Options .....	60
Audio Language .....	61
Dolby Digital .....	62
Alternate Data .....	63
Upgrades .....	63
Dish Pointing .....	64
Selecting Dish Type .....	64
Find Your Dish Pointing Coordinates .....	65
Using the Onscreen Signal Meter .....	66
<b>TIPS &amp; TROUBLESHOOTING .....</b>	<b>67</b>
<b>APPENDIX A: WARRANTY INFORMATION .....</b>	<b>71</b>
<b>APPENDIX B: FCC REGULATIONS .....</b>	<b>74</b>
<b>APPENDIX C: ACCESSORIES .....</b>	<b>75</b>
<b>INDEX .....</b>	<b>76</b>

# SETUP AND CONNECTIONS

## GETTING STARTED

This manual is designed to get you started quickly. The first three sections of the manual introduce you to your DIRECTV PLUS™ System.

In Setup and Connections, you'll learn:

- different ways to connect the digital satellite receiver to your TV
- how to order programming
- how to program the remote control

Using the Remote defines the buttons of the remote and how to program it to control other components.

Program Guides details the items and features associated with the different guides.

## THE REST OF THE MANUAL

The rest of the book includes menu information, troubleshooting information (such as running a system test), and an index.

## 1 SETUP AND CONNECTIONS



## 2 USING THE REMOTE



## 3 PROGRAM GUIDES



## 4 THE MENU SYSTEM



## 5 TIPS & TROUBLESHOOTING

# SETUP AND CONNECTIONS

## STEP 1: UNPACK THE DIRECTV PLUS™ SYSTEM

Make sure to locate the remote control, RF remote control antenna, and VCR Controller.

## STEP 2: CONNECT YOUR DIGITAL SATELLITE RECEIVER

During the satellite dish antenna installation, the digital satellite receiver may have been connected to your TV with just a coaxial cable for the system test. Depending on what components you have, another connection may provide better picture and audio quality. The following sections provide cable and connection information to help you decide what connection is best for you.

## THINGS TO KNOW BEFORE CONNECTING COMPONENTS

### Protect Your Components from Power Surges

- Connect all components before plugging any power cords into the wall outlet.
- Always turn off the digital satellite receiver, TV and other components before you connect or disconnect any cables.

### Position Cables Correctly to Avoid Audio Hum or Interference

- Insert all cable plugs firmly into their jacks.
- Place the audio/video cables to the sides of the TV's back panel instead of straight down the middle after you connect your components.
- Try not to coil any twin-lead cables and keep them away from the audio/video cables as much as possible.
- Make sure all antennas and cables are properly grounded. Refer to the Safety Tips sheet packed with your unit.

### Protect Your Components from Overheating

- Do not block ventilation holes in any of the components. Arrange the components so that air can circulate freely.
- Do not stack components.
- Allow adequate ventilation when placing components in a stand.
- Place an amplifier or receiver on the top shelf of the stand so heated air rising from it will not flow around other components.



Remote Control



RF Remote Control Antenna

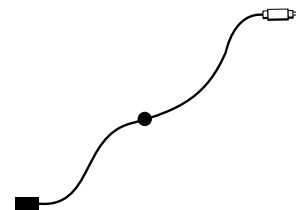

VCR Controller

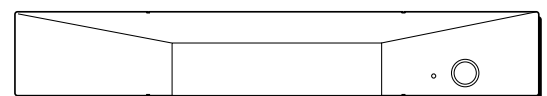

Digital Satellite Receiver

# SETUP AND CONNECTIONS

## JACKS AND CABLES

Below is a description of the jacks and cables you can use to make connections. Not all cables come with your DIRECTV PLUS™ System.

### S-Video Jack and Cable

S-Video jacks provides the best picture quality for your DIRECTV PLUS™ System. S-Video jacks are available on many TVs and are used to carry visual information from the digital satellite receiver to your TV. Remember to connect the left and right audio cables because the S-Video jack carries only the picture signal, not the sound.

### Audio/Video Jacks and Cables (RCA-type)

Audio/video jacks provide very good picture and stereo sound quality, and should be used if your TV has no S-Video jack. These jacks can also be used to connect other components. The digital satellite receiver audio/video jacks are color coded (yellow for video, red for right audio, and white for left audio). If your TV has only one input for audio (mono), connect it to the right (red) audio jack on the receiver.

### RF Jacks and Coaxial Cable (F-type)

The RF jacks provide good picture and mono sound quality, and are to be used if audio/video connections are not available on your TV. These jacks are also used for off-air antenna, cable, and RF remote control antenna connections. The RF jacks on the receiver are labeled IN FROM ANT, OUT TO TV, and RF REMOTE. The coaxial cable supplied with your system is used to connect the receiver to your TV's antenna input jack.

### VCR Jack and Controller

The VCR Controller plugs into the VCR jack on the digital satellite receiver's back panel. Attach the other end of the cable to your VCR's remote control sensor.

### Digital Audio Output Jack\* and SPDIF Cable

If you own a Dolby Digital receiver that uses an optical cable-type input, use an optical (SPDIF) cable to connect the digital satellite receiver to your Dolby Digital receiver or decoder for the best sound quality. (You must remove the cover from digital audio output jack before inserting cable.)

### Telephone Jack and Cord

The telephone line cord is required to connect your digital satellite receiver to a telephone line if you choose to subscribe to \*\*DIRECTV® programming. The phone line connection is used to periodically call out to DIRECTV. You will need an RJ11-type modulator jack, which is the most common type of phone jack and might look like one of those pictured here. If you don't have a modular jack, call your local telephone company to find out how to get one installed.

\*This feature is only available on model DRD480RE.

\*\*DIRECTV programming is provided in accordance with the terms and conditions of the DIRECTV Customer Agreement, which is provided with your first DIRECTV billing statement. DIRECTV is a trademark of DIRECTV, Inc., a unit of Hughes Electronics Corp., and is used with permission.

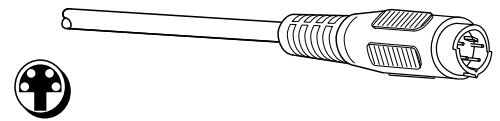

S-Video jack and cable

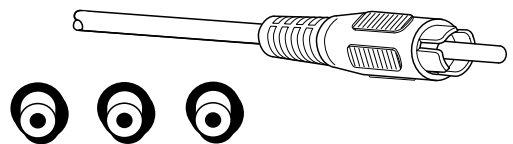

Audio/video jacks and cable

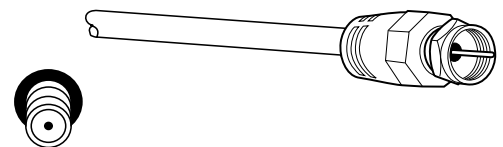

RF jack and coaxial cable

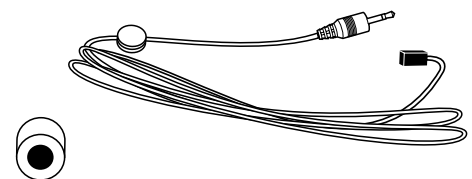

VCR jack and VCR Controller

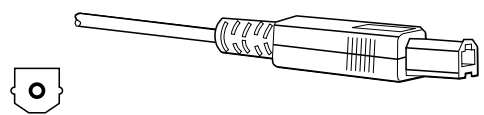

Optical jack and SPDIF cable

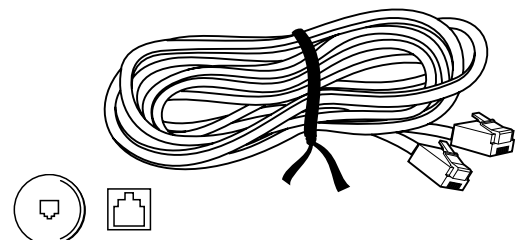

Telephone jacks and cord

# SETUP AND CONNECTIONS

## BACK OF THE DIGITAL SATELLITE RECEIVER

The diagram below describes each of the back panel jacks found on your digital satellite receiver. When connecting A/V cables, be sure to connect corresponding OUTPUTS and INPUTS (Video to Video, Right Audio to Right Audio, etc.). For more information on the function of the back panel jacks and many other features of your digital satellite receiver, press the MENU button and select *Options* from the Main menu, then select *System Info*.

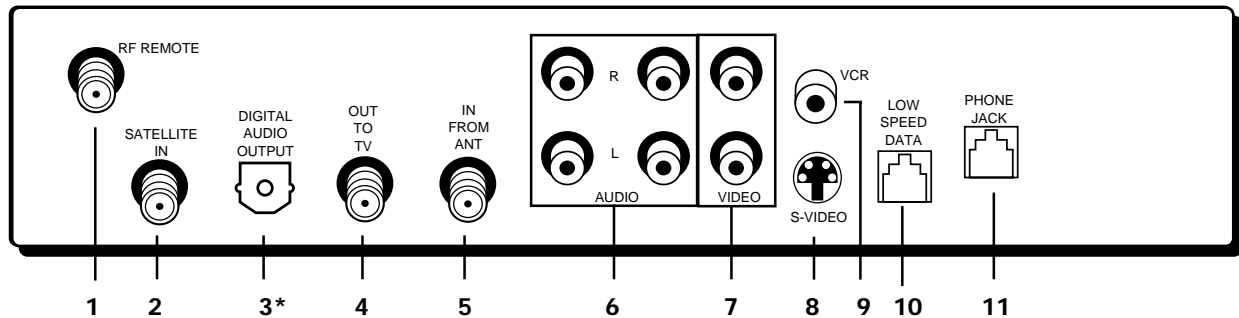

## TOP OF THE DIGITAL SATELLITE RECEIVER

The diagram below describes the buttons on the top of your digital satellite receiver (also referred to as the front panel). For more information on the function of the front panel buttons and many other features of your digital satellite receiver, press the MENU button and select *Options* from the Main menu, then select *System Info*.

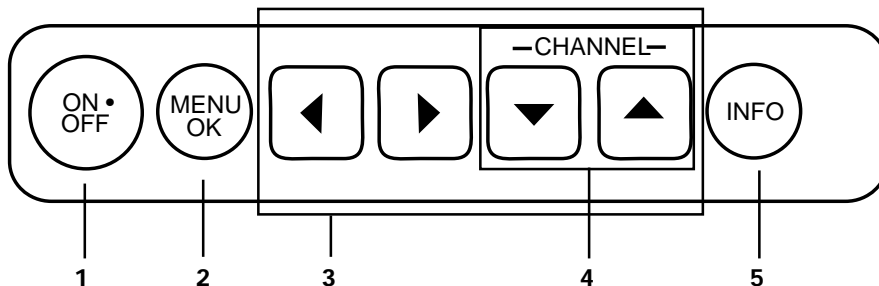

\*The digital audio output jack is only available on model DRD480RE.



# SETUP AND CONNECTIONS

## Back of Digital Satellite Receiver Jacks

- 1 RF REMOTE** Use to connect an optional RF antenna for RF remote signals. Connecting an antenna extends the remote's range.
- 2 SATELLITE IN** Use to connect the digital satellite receiver to the satellite dish antenna.
- 3 DIGITAL AUDIO OUTPUT** This feature is only available on model DRD480RE. Use a digital optical (or SPDIF) cable to connect your digital satellite receiver to a compatible Dolby Digital receiver or decoder. (You must remove the cover from digital audio output jack before inserting cable.) Dolby Digital offers theatre-quality sound (six audio channels).
- 4 OUT TO TV** Use to connect the digital satellite receiver to your TV. However, if your TV has audio/video jacks, you should use those jacks to get better picture and sound quality.
- 5 IN FROM ANT** Use to connect the digital satellite receiver to an off-air antenna or cable TV signal.
- 6 AUDIO (R and L)** Provide better sound quality than the OUT TO TV jack. If your TV has audio/video input jacks, use these jacks to connect the digital satellite receiver to your TV. Connect the second set to another device, such as a VCR. You must also connect the VIDEO or S-VIDEO jack.
- 7 VIDEO** Provides better picture quality than the OUT TO TV jack. If your TV has audio/video input jacks, use this jack to connect the digital satellite receiver to your TV. Connect the second set to another device, such as a VCR. You must also connect the AUDIO jacks.
- 8 S-VIDEO** Provides the best picture quality. If your TV has an S-Video jack, use this jack along with the audio/video jacks to connect the digital satellite receiver to your TV.
- 9 VCR** Use to connect the VCR Controller to your digital satellite receiver. Attach the other end to the IR sensor on your VCR. This connection lets you use the One-Touch Record and Timer recording features.
- 10 LOW SPEED DATA** This port allows you to connect your DIRECTV PLUS™ System to future services and accessories as they become available. A shielded cable and additional hardware may be required.
- 11 PHONE JACK** Use to connect the digital satellite receiver to a telephone line. The DIRECTV PLUS™ System requires a telephone line connection to periodically call out to program providers. If you subscribe to Caller ID through your telephone company, you must also make sure your phone line connection is direct and to a non-wireless jack.

## Top of Digital Satellite Receiver Buttons

- 1 ON•OFF** Use to turn your digital satellite receiver on for viewing or off when you are not viewing it. Your receiver will still be able to download software upgrades and receive messages from program providers when it is off.
- 2 MENU•OK** Use this button to display the Main menu. If you are already in the menu system, pressing this button selects the highlighted item.
- 3 Arrows** Use these buttons to navigate left and right, down and up, in the menu system.
- 4 Channel Down and Up** When you're watching TV, use these buttons to change the channel. When you're in the menu system, use these buttons for navigation.
- 5 INFO** Use this button to display the channel banner, password challenge, or purchase offer screen. Press twice to display additional program information, when available.

# SETUP AND CONNECTIONS

## BASIC CONNECTION

This connection provides a basic level of sound and picture quality and can be used with TVs and VCRs that do not have audio/video jacks. Note: your back panel may not look exactly like the one shown below.

**CAUTION**  
Do not stack electronic components or other objects on top of the digital satellite receiver. See "Safety Information," inside the front cover.

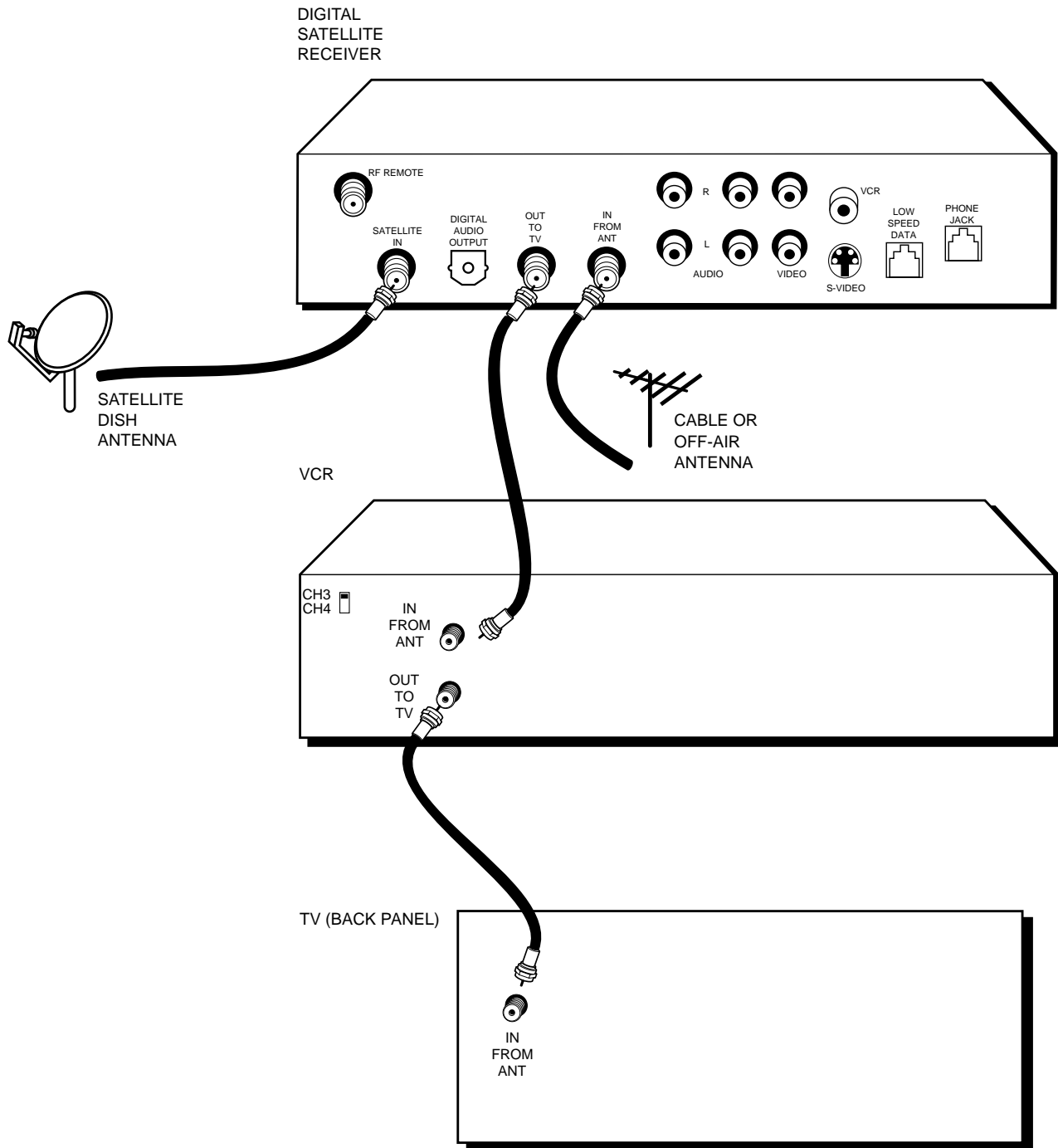

# SETUP AND CONNECTIONS

## What You Need

- Three coaxial cables
- One RG-6 coaxial cable

## Making the Connection

1. Connect the OUT TO TV jack on the digital satellite receiver to the IN FROM ANT jack on the VCR with a coaxial cable.
2. Connect the OUT TO TV jack on the VCR to the TV's IN FROM ANT jack with a coaxial cable.
3. Connect the SATELLITE IN jack on the digital satellite receiver to your satellite dish antenna with an RG-6 coaxial cable.
4. Connect the IN FROM ANT jack on the digital satellite receiver to your cable box or off-air antenna with a coaxial cable.

## Using Your Components

### To watch \*DIRECTV® programming:

Tune the TV to either CH 3 or 4. (The default is CH 3. You can change the output channel to 4 by choosing *Options* from the Main menu, then *System Options*, and then selecting *Output Channel*.)

### To record DIRECTV® programming:

Tune the digital satellite receiver to the desired channel and set your VCR to record on channel 3 or 4.

### To view VCR recordings:

Tune the TV to the VCR output channel (usually CH 3 or 4) and set your VCR to play. If your VCR is a brand other than RCA, GE, or PROSCAN, you may need to program the remote to control the VCR. See the "Using the Remote" section for more information.

# SETUP AND CONNECTIONS

## ADVANCED CONNECTION

This connection provides better sound and picture quality than the basic connection and is recommended for use with TVs and VCRs or other components that have audio/video jacks.

S-Video provides the best picture quality and is recommended for use with components that have S-Video jacks. If you use the S-Video cable, remember to connect audio cables as well. S-Video must be used with audio cables in order for you to receive sound. Note: your back panel may not look exactly like the one shown below.

**CAUTION**  
Do not stack electronic components or other objects on top of the digital satellite receiver. See "Safety Information," inside the front cover.

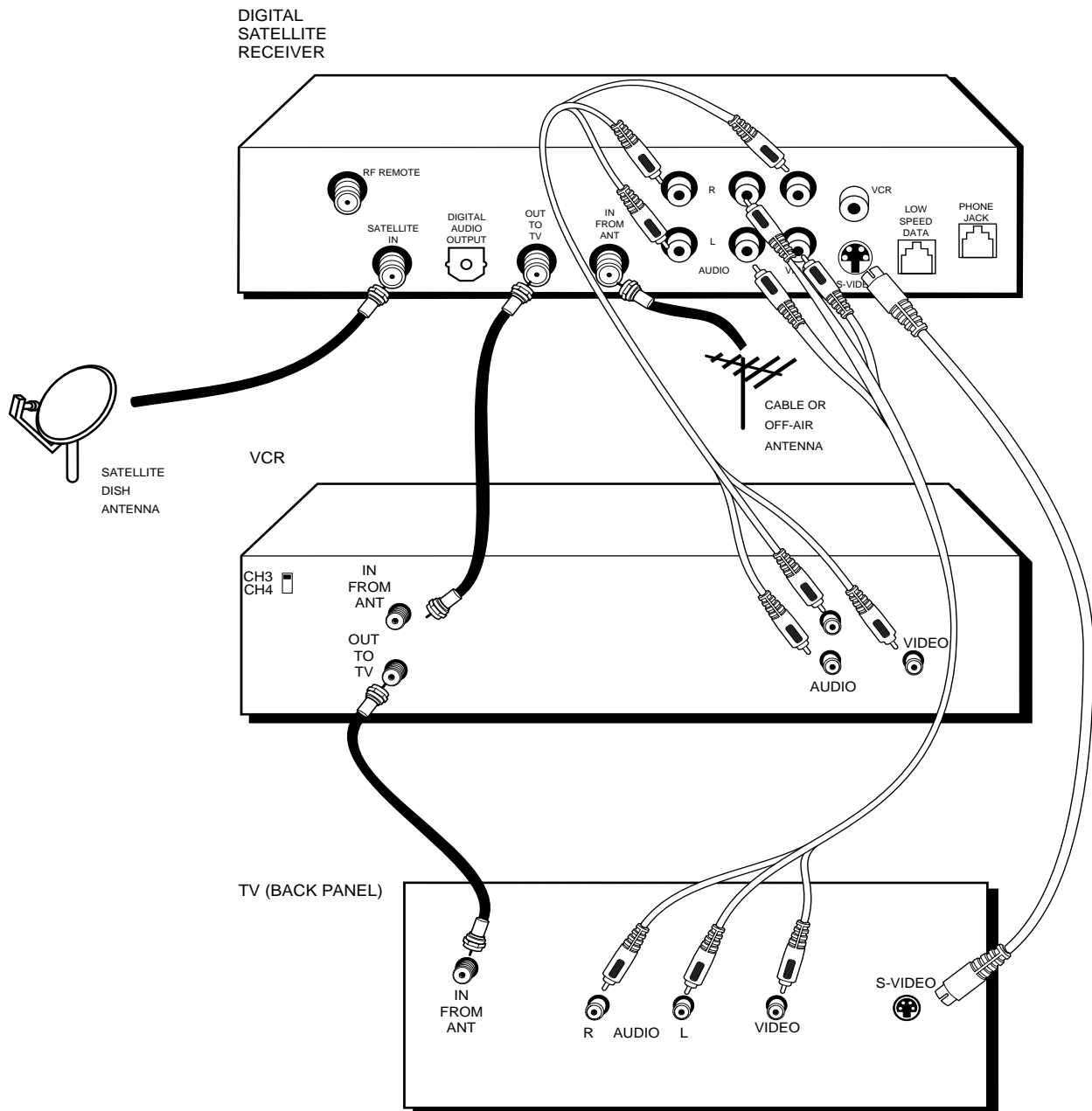

# SETUP AND CONNECTIONS

## What You Need

- Three coaxial cables
- One RG-6 coaxial cable
- Two sets of audio/video cables
- One S-Video cable (optional)

## Making the Connection

1. Connect the OUT TO TV jack on the digital satellite receiver to the IN FROM ANT jack on the VCR with a coaxial cable.
2. Connect the OUT TO TV jack on the VCR to the TV's IN FROM ANT jack with a coaxial cable.
3. Connect the SATELLITE IN jack on the digital satellite receiver to your satellite dish antenna with an RG-6 coaxial cable.
4. Connect the IN FROM ANT jack on the digital satellite receiver to your cable box or off-air antenna with a coaxial cable.
5. Connect one set of AUDIO and VIDEO jacks on the digital satellite receiver to a set of AUDIO and VIDEO jacks on your TV using one audio/video cable.
6. Connect a second set of AUDIO and VIDEO jacks on the digital satellite receiver to a set of AUDIO and VIDEO jacks on another device, such as a VCR, using a second audio/video cable.
7. (optional) Connect the S-VIDEO jack on the digital satellite receiver to the S-VIDEO jack on the TV using an S-Video cable.

## Using Your Components

### To watch DIRECTV® programming:

Tune the TV to the video input channel. (If you have difficulty finding your TV's video input channel, follow the instructions in the "Tips and Troubleshooting" section.) Then tune the digital satellite receiver to the desired channel.

### To record DIRECTV® programming:

Tune the digital satellite receiver to the desired channel. Then set your VCR to record on your video input channel.

### To view VCR recordings:

Tune the TV to the video input channel and set your VCR to play. If your VCR is a brand other than RCA, GE, or PROSCAN, you may need to program the remote to control the VCR. See the "Using the Remote" section for more information.

# SETUP AND CONNECTIONS

## RF REMOTE ANTENNA CONNECTION

This connection allows your remote control to communicate with your digital satellite receiver even when you do not have line-of-sight to the receiver's front panel remote sensor. Note: your back panel may not look exactly like the one pictured below.

### CAUTION

Do not stack electronic components or other objects on top of the digital satellite receiver. See "Safety Information," inside the front cover.

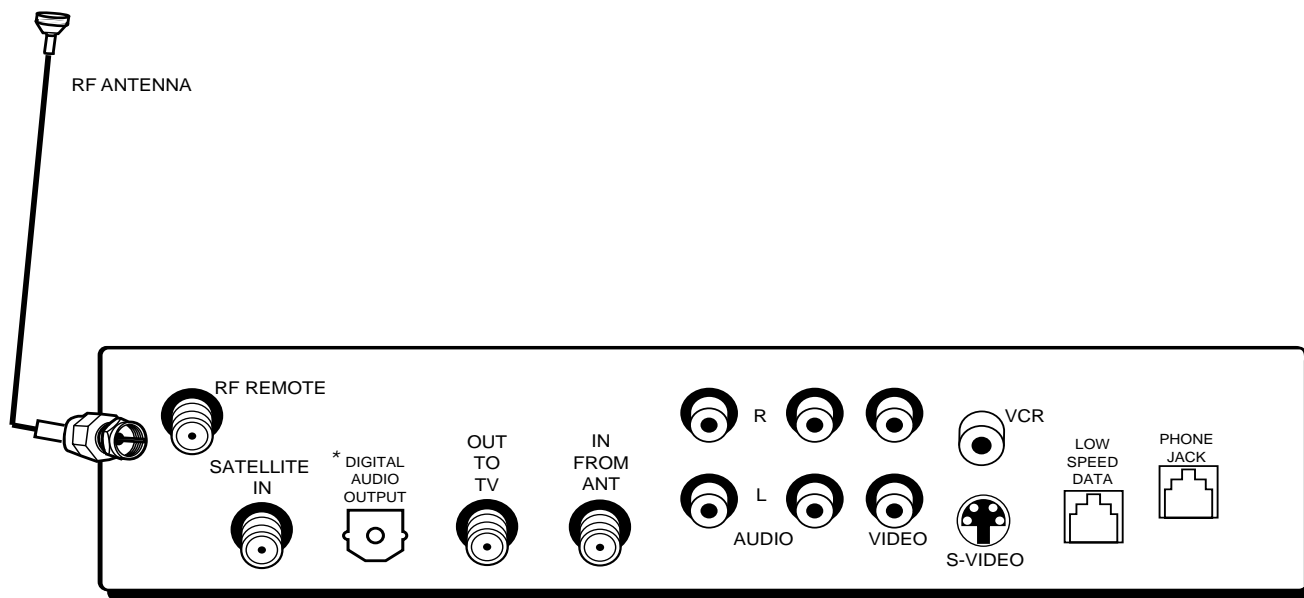

## What You Need

- One RF remote antenna

## Making the Connection

Connect the RF remote antenna to the RF REMOTE jack on the back of your digital satellite receiver.

## Using Your Component

As soon as the above connection is made, the RF feature of your remote is in effect. For information on how to program your remote to control other devices or to change the RF code, see the "Using the Remote" section.

\*The digital audio output jack is only available on model DRD480RE.

# SETUP AND CONNECTIONS

## DIGITAL AUDIO OUTPUT\* CONNECTION

Use this connection to take advantage of Dolby Digital<sup>†</sup> quality sound, when available. Note: your back panel may not look exactly like the one pictured below.

### CAUTION

Do not stack electronic components or other objects on top of the digital satellite receiver. See "Safety Information," inside the front cover.

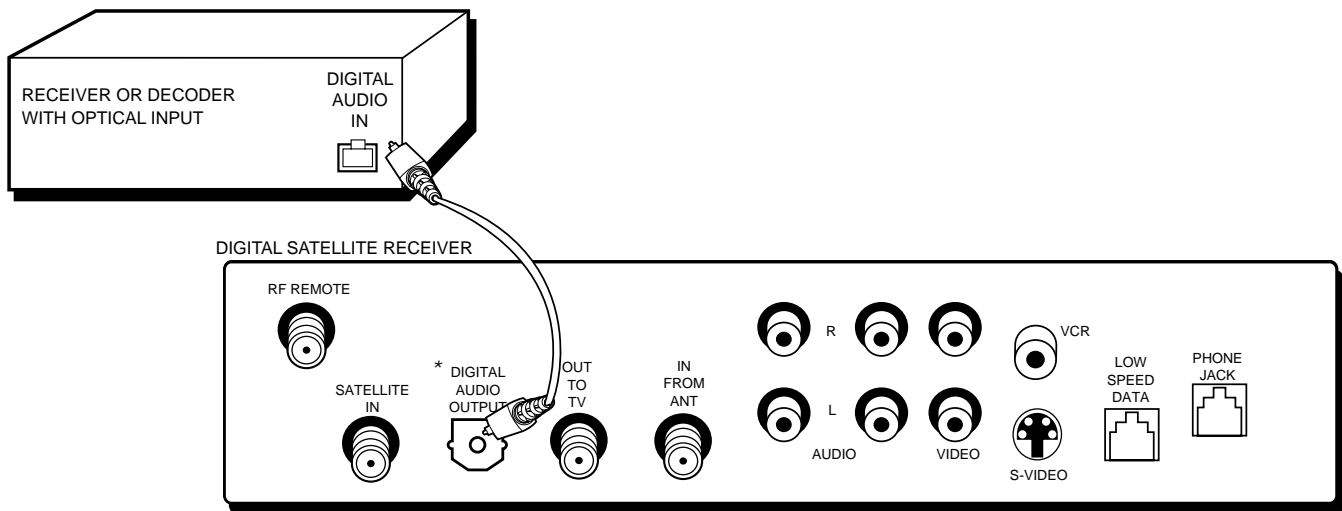

## What You Need

- One optical (SPDIF) cable

## Making the Connection

Connect the DIGITAL AUDIO OUTPUT jack\* on your digital satellite receiver to the DIGITAL AUDIO IN jack on your Dolby Digital Receiver or Decoder with an optical (SPDIF) cable. (Note: you must remove plug from digital audio output jack before inserting cable.)

## Using Your Component

After you connect your digital satellite receiver to a Dolby Digital receiver, you must select *Dolby Digital* from the Options menu, then select *Autoselect*, *PCM*, or *Dolby Digital* in order for the receiver to recognize the connection. For more information on this feature, see the Dolby Digital entry in "The Menu System" section.

\*The digital audio output jack is only available on model DRD480RE.

<sup>†</sup>Manufactured under license from Dolby Laboratories. "Dolby" and the double-D symbol are trademarks of Dolby Laboratories. Confidential Unpublished Works. ©1992-1997 Dolby Laboratories, Inc. All rights reserved.

### Please Read Before Using the DIGITAL AUDIO OUTPUT Jack

This digital satellite receiver's optical digital output jack fully complies with the international standard governing this type of jack (IEC958), and is designed for connection to a Dolby Digital (AC-3 or PCM) receiver or Dolby Digital (AC-3 or PCM) decoder. Older equipment, some of which is not fully compliant with IEC958, may not be compatible with the Dolby Digital bitstream. Such a connection using anything other than a PCM, Dolby Digital, or Dolby Pro Logic receiver or decoder could create a high noise level, causing damage to headphones or speakers.

# SETUP AND CONNECTIONS

## STEP 3: PLACE BATTERIES IN THE REMOTE CONTROL

Follow these steps whenever you need to install or change the batteries in your digital satellite receiver's remote control.

1. Remove the cover from the battery compartment.
2. Insert batteries in the battery compartment, matching the + and - end of each battery.
3. Replace the cover.

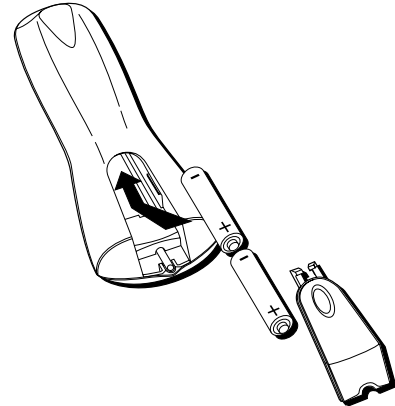

When replacing old batteries, note that you may have to reprogram your remote to control other devices.

## STEP 4: PLUG IN AND TURN ON THE DIGITAL SATELLITE RECEIVER

Plug the end of the power cord into the wall outlet. Be sure to insert the plug completely.

To turn on the digital satellite receiver, press the DIRECTV button on the remote control or the ON•OFF button on the front panel. If your TV brand is RCA, GE, or PROSCAN, press the TV button on the remote to turn on the TV. If your TV brand is not RCA, GE, or PROSCAN, see the next section, "Using the Remote," for details on how to program the remote to control your TV.

## STEP 5: CONNECT THE VCR CONTROLLER

In order for you to use the One-Touch Record and Timer recording features, you need to attach the VCR Controller to the back of the digital satellite receiver.

1. Plug the VCR Controller into the VCR jack on the digital satellite receiver.
2. Affix the other end to the remote control sensor on your VCR.

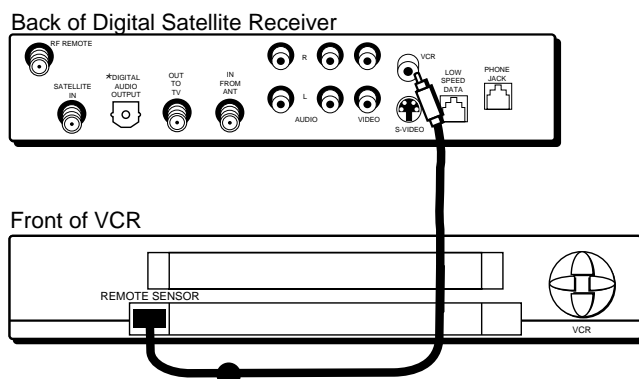

\*The digital audio output jack is only available on model DRD480RE.



# SETUP AND CONNECTIONS

## LOCATING THE VCR'S INFRARED REMOTE CONTROL SENSOR

The VCR Controller must be affixed directly over the infrared remote control sensor on your VCR.

Some VCRs have a label that identifies the infrared remote control sensor, and others do not. If the IR sensor is labeled on your VCR, affix the VCR Controller directly over the sensor.

For VCRs that do not label the remote sensor, you need to use the VCR's remote to locate the sensor before affixing the VCR Controller.

1. Hold the VCR's remote control so that it is touching the front of the VCR.
2. Slowly move the remote over the front of the VCR while pressing the remote power button on and off.
3. When your VCR turns off or on, you have located the sensor.

To test the VCR controller, use a piece of clear tape to temporarily attach the VCR controller to the spot where you think the sensor is located, and then follow the steps under "Selecting a VCR Type."

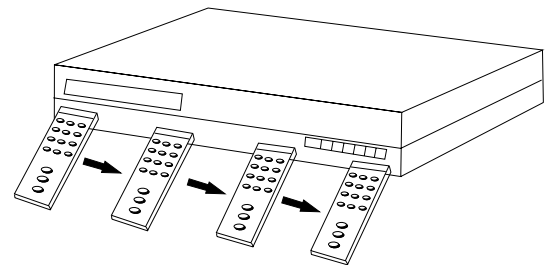

## SELECTING A VCR TYPE

You need to tell the digital satellite receiver which VCR brand you are using.

1. Press MENU on the remote control to bring up the Main menu.
2. Point to *Options* and press OK.
3. Point to *System Options* and press OK.
4. Point to *Set VCR Type* and press OK.

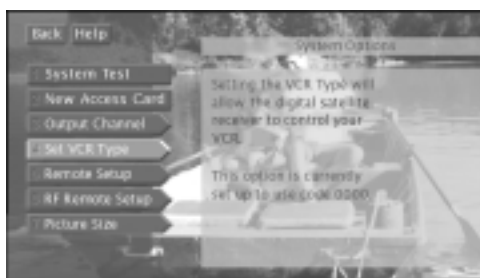

The *Set VCR Type* screen lets you enter a code for your VCR.

5. Use the arrows and the OK button on the remote control to select the name of your VCR manufacturer.
  6. Follow the on-screen instructions to ensure that you are using the correct code.
- Some VCR brands may not be capable of being controlled by the receiver.

See Step 6, "Using Point and Select," for additional help on accessing and navigating the menu system.

If you do not see your VCR manufacturer's name, select *Other* (at the bottom of the list) and enter the appropriate code from the "Using the Remote" section.

# SETUP AND CONNECTIONS

## STEP 6: USING POINT AND SELECT

You only need to know one rule when using the remote to access on-screen menus and control panels: point and select. Once you know how to point and select you can complete the interactive setup (Step 7, below) and explore the menu system.

To enter the menu system, press the DIRECTV button on the remote control to make sure you're in DIRECTV mode, then press MENU.

The point and select method has two steps.

**1. Point** to a menu item using the arrows on the remote.

To point up or down, press the up or down arrows. To point left or right, press the left or right arrows.

**2. Select** a menu item by pressing MENU or OK.

Selecting an item tells the TV's menu system to go ahead and make the change or go to a place you have indicated.

Don't worry about getting stuck inside a menu. Pressing the CLEAR button on the remote control takes you out of the menu system and back to the program you were watching.

## STEP 7: INTERACTIVE SETUP

If you installed your satellite dish antenna yourself, you may have already used the interactive setup to find the dish pointing coordinates, acquire and fine-tune the signal, and run a system test.

If you need to run the interactive setup again, select *Options* from the Main menu, then select *Interactive Setup*.

If you just want to check your dish pointing coordinates or run the signal strength meter, select *Dish Pointing* from the Main menu.

## STEP 8: ORDER PROGRAMMING

After you have installed your DIRECTV PLUS™ System, you should contact DIRECTV in order to receive DIRECTV® programming.

Programming with DIRECTV                      Call 1-800-347-3288

With this receiver and the proper satellite dish antenna, you may be able to receive local channels from DIRECTV in certain areas. Additional Equipment may be required in some areas. Check with your retailer or visit [www.directv.com](http://www.directv.com) for information on availability of local channels from DIRECTV in your area.

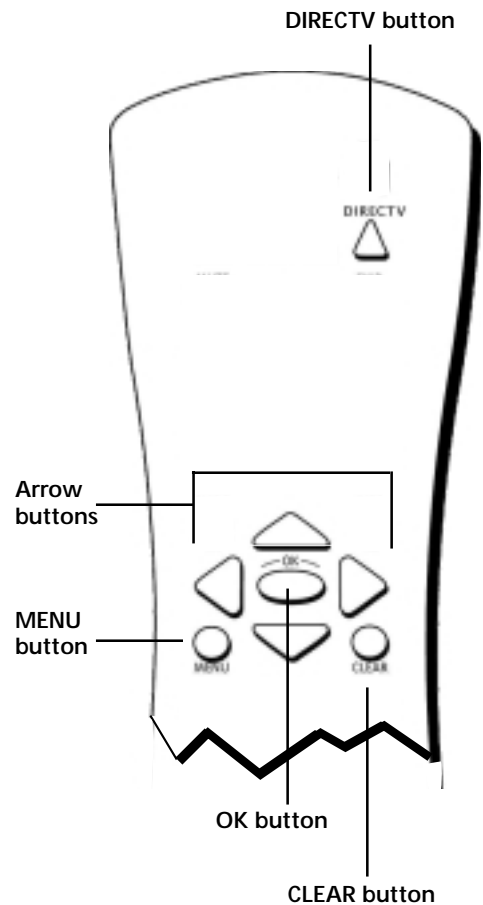

When you order programming, you need to know your access card number. To get the number, select *Options* from the Main menu, then *System Options*, and then select *System Test*.

Wait for the system to run all of its tests. The access card number is displayed at the end of the system test.

Write the access card number in the space below for easy reference:

\_\_\_\_\_

# USING THE REMOTE

## HOW TO USE YOUR UNIVERSAL REMOTE

This section defines the buttons of the remote control and explains how to program it to control other devices.

The universal remote can be programmed to control most brands of remote controllable VCRs, TVs, and cable boxes. If you have an RCA, GE, or PROSCAN device, you probably don't need to program it at all.

**1** SETUP AND CONNECTIONS



**2** USING THE REMOTE



**3** PROGRAM GUIDES



**4** THE MENU SYSTEM



**5** TIPS & TROUBLESHOOTING

# USING THE REMOTE

## REMOTE CONTROL BUTTONS

**ON•OFF** Turns the device you are controlling on or off. When pressed twice within two seconds, all devices that are on will be turned off (this feature only works with most RCA, PROSCAN, and GE products). You can also use the ON•OFF button on the top (front panel) of the digital satellite receiver to turn the receiver on or off.

**VCR** When programmed, tells the remote to control the VCR.

**TV** When programmed, tells the remote to control the TV.

**DVD** Tells the remote to control the DVD player. Note that this button is only functional with GE, RCA, and PROSCAN DVD players.

**VCR2** When programmed, tells the remote to control a second VCR.

**LED** This light turns red at each valid button press. When programming the remote control, it flashes or turns on or off to indicate programming status.

**AUX** Acts as a “wildcard” button. It can be programmed to control another VCR, TV, satellite receiver or cable box. Or, it can be programmed to control an RCA, GE, or PROSCAN audio device. Follow the direct entry programming instructions, later in this section, to program this button.

**DIRECTV** Tells the remote to control the digital satellite receiver.

**MUTE** When programmed, reduces the TV's volume to its minimum level. Press again to restore the volume.

**SKIP** This button is not used by the digital satellite receiver. It is functional only with RCA, GE and PROSCAN TVs and VCRs.

**CH + (up) /- (down)** Use to scan up and down through the channels in the current channel list. If you are in the program guide or menu system, use the CH +/- buttons to page up and down a screen at a time. You can also use the CH +/- buttons on the top of the digital satellite receiver to change the channel.

**VOL down and up** When programmed, adjusts the audio volume of your TV.

**FETCH** Either brings up the Fetch menu or tells the receiver to take the action you programmed it to take.

**GO BACK** Moves you back and forth between the last two selected channels. In the menu system, returns you to the previous screen.

**GUIDE** Brings up the program guide. Subsequent presses of the GUIDE button switch between the Detail and Grid guide formats.

**INFO** Brings up the on-screen channel banner, password challenge, or purchase offer screen. Press again to get program details. In the program guides, press to get information about the highlighted program or channel.

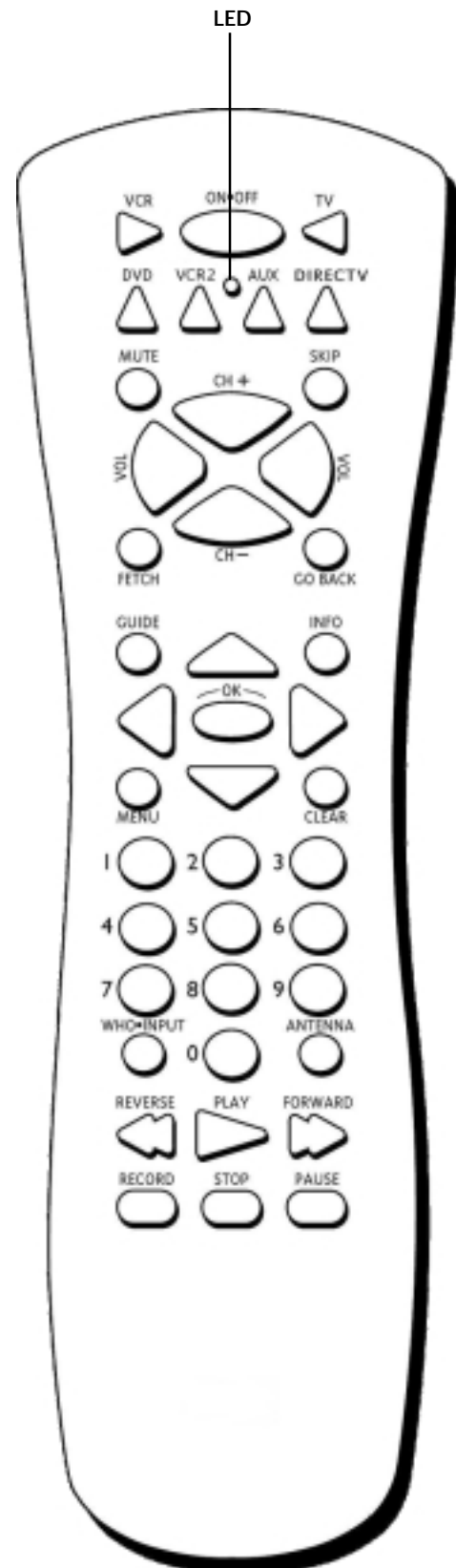

# USING THE REMOTE

**Arrows** Use the navigation arrows to move the on-screen highlight up, down, left, or right. Using the arrows to highlight a menu item is also called "pointing."

**OK** Selects a highlighted choice if you are in the menu system. After entering a one, two, or three-digit DIRECTV channel number, press to tune to the channel. If you are entering a number other than a DIRECTV channel number (for instance, to tune your VCR to a channel), you do not need to press this button.

**MENU** Displays the Main menu. If you are already in the menu system, press OK or MENU to select a highlighted choice. When you are using the remote control to operate an RCA, GE, or PROSCAN VCR (the remote is in VCR mode), the MENU button functions as a PROGRAM button.

**CLEAR** Removes the on-screen displays and returns you to normal viewing.

**Digit Buttons (0 - 9)** Use the digit buttons to tune directly to a four digit DIRECTV channel or non-DIRECTV channel. If a DIRECTV channel number is less than four digits long, you must press OK after entering the channel number. If you are in the menu system, use the digits to highlight and select items (use 0 to return to the previous menu screen).

**WHO•INPUT** Press the WHO button one or more times to scroll through the user profiles. When you are using the remote control to operate an RCA, GE, or PROSCAN TV (in TV mode), press the WHO•INPUT button one or more times to scroll through the available video input sources.

**ANTENNA** In TV mode, lets you switch the source of the video signal from satellite signals to an off-air antenna or cable signal when using the OUT TO TV jack. In VCR mode, functions as a TV/VCR input button.

**Transport Buttons (REVERSE, PLAY, FORWARD, RECORD, STOP, PAUSE)** When programmed, these buttons are used to control an auxiliary device, such as a VCR or Laserdisc player. Note that if your VCR Controller is connected, the RECORD button can be used to schedule a timer recording when using the Program Guide or to begin recording while watching a program (in VCR mode).

# USING THE REMOTE

## PROGRAMMING THE REMOTE CONTROL

The digital satellite receiver's remote can be programmed to control most brands of remote controllable devices. The remote is already programmed to control most RCA, GE and PROSCAN devices; it may need to be programmed to control other manufacturers' brands.

## TESTING THE REMOTE CONTROL

To determine whether the universal remote control needs to be programmed, turn a device on, such as a VCR, point the remote at the VCR, and press the VCR button. Then press ON•OFF or CH + or CH - to see if the VCR responds to the remote commands. If not, the remote needs to be programmed.

There are two ways to program the remote control: automatic or direct entry.

### Using Automatic Code Search

The following instructions can be used to program the remote to control many of the devices connected to your TV. If you want to exit the automatic code search without programming any of your devices, press the CLEAR button until the LED (red light) turns off.

1. Turn on the device you want to control (VCR, satellite receiver, etc.)
2. Press and hold the button you want to program. While holding the device button, press and hold ON•OFF until the LED on the remote control turns on, then release both buttons.
- Note that the AUX button can only be programmed using direct code entry. See "Using Direct Entry," later in this section, for details.
3. Point the remote at the device, press and release PLAY, then wait five seconds or until the LED stops flashing.

At this point the remote control is searching for the correct code to program. If, after five seconds, the device you want to control does not turn off, press and release PLAY again to tell the remote to search the next set of codes.

Continue pressing and releasing PLAY until the device turns off or you have searched through all of the codes. There are 20 total sets of codes. If the device does not turn off after pressing PLAY 20 times, then the remote cannot control that particular device.

If the device you want to control *does* turn off:

1. Press and release REVERSE, then wait two seconds. Repeat this step until the device turns back on.
2. To finish, press and hold STOP until the LED on the remote control turns off.

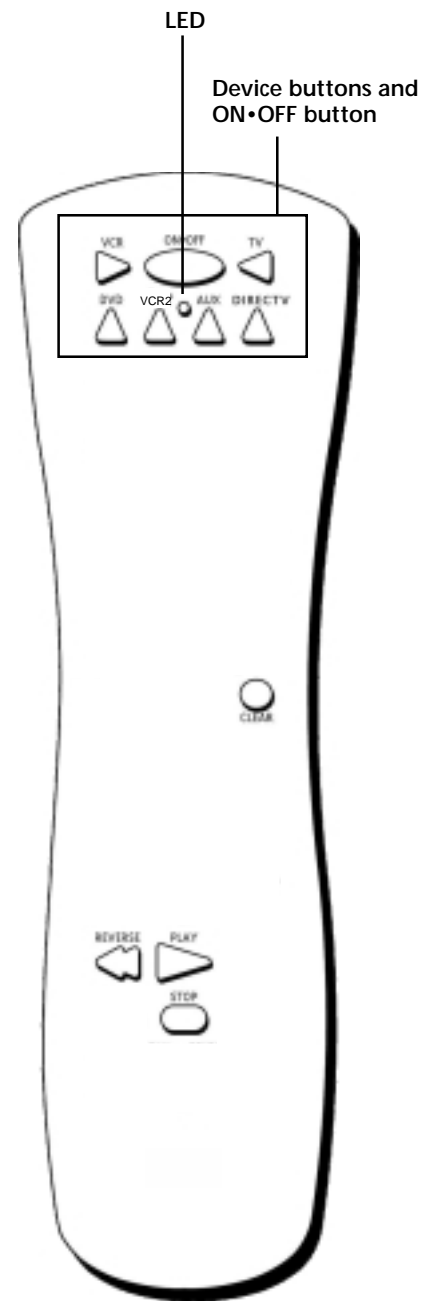

*You'll use these buttons when you program the remote to control any device*

*The remote control may not operate all models of all brands.*

# USING THE REMOTE

## Using Direct Entry

1. Turn on the device to be programmed.
2. Look up the brand and code number(s) for the device on the code list at the end of this section.
3. On your remote control, press and hold the device button you want to program.
4. Enter a code from the code list.
5. Release the device button, and then press ON•OFF to see if the device responds to the remote control commands. If it doesn't, try pressing the device button and then ON•OFF again.
6. If you get no response, repeat these steps using the next code listed for your brand, until the device responds to the remote control commands.

This remote control may not operate all models of the brands that are shown. Use the codes shown in this manual, or on the sheet packed with your remote.

## USING THE REMOTE TO CONTROL A DEVICE

Once the remote has been programmed successfully, you are ready to use it to control your devices.

To operate the device:

1. Press the device button (TV, VCR, DIRECTV, VCR2, or AUX) to set the remote to control the device.
  2. Press ON•OFF to turn the device on or off.
  3. Use the remote control buttons that apply to that device.
- If your remote is programmed to control a VCR, you only need to press the RECORD button to begin recording from video.

## MODES OF OPERATION

Because this universal remote can control several different devices (DVD player, VCR, cable box, etc.) it uses operational modes triggered by the device buttons. For example, if you wanted the remote to control the TV, you would press the TV button to put the remote into TV mode. Then, if you want to play a videotape press VCR then PLAY (pointing the remote at the VCR).

# USING THE REMOTE

## CONTROLLING A SECOND SATELLITE RECEIVER

The remote can control two satellite receivers. From the Main menu, select *Options*, then *System Options*, then *Remote Setup*. Then follow the on-screen instructions and enter the appropriate code from the Satellite Receiver list at the end of this section. By default, the DIRECTV button is used to control the first satellite receiver and the AUX button is used to control the second satellite receiver.

If your second receiver is an RCA, GE, or PROSCAN and you want to control it using the AUX button, use code 5001. Code 5000 is used by the DIRECTV button.

## CHANGING THE RF REMOTE CONTROL CODE

Your remote control is equipped with RF functionality. This means that the remote can control the digital satellite receiver using both IR (infrared) signals and RF (radio frequency) signals. IR signals require line-of-sight to the receiver's front panel remote sensor. RF signals can control the receiver from other parts of your house—even through walls. Installing your RF remote control antenna will increase the range of your RF remote signal. See the "Setup and Connections" section for more information.

If you are experiencing interference from other RF devices, you may need to change the RF remote control code. Change the code by doing the following:

1. Select *Options* in the Main menu.
2. Select *System Options*.
3. Select *RF Remote*.
4. Choose a number between 000 and 255. Follow the on-screen instructions to enter it as your RF remote control code.



RF remote control antenna





# USING THE REMOTE

Jensen ..... 2055, 2056, 2111  
 JVC ..... 0002, 0014, 0016, 0030, 0046, 0074, 2009, 2010, 2011, 2018, 2058, 2111, 2123  
 Kenwood ..... 0002, 0014, 0016, 0030, 0044, 0046, 2009, 2010, 2011, 2016, 2018, 2058, 2111, 2123  
 KLH ..... 0073, 2061  
 Kodak ..... 2014, 2021  
 Lloyd's ..... 0015, 2002, 2026  
 Logik ..... 0031, 2061  
 LXI ..... 2014  
 Magnavox ..... 0008, 0029, 0053, 0056, 2021, 2022, 2062, 2063, 2104, 2108, 2124  
 Magnin ..... 2013  
 Marantz 0002, 0008, 0014, 0016, 0029, 0030, 0044, 0046, .. 0061, 2009, 2010, 2011, 2016, 2018, 2021, 2058, 2062, .. 2064  
 Marta ..... 0009, 2014  
 Masushita ..... 2021  
 MEI ..... 0008, 2021  
 Memorex ..... 0008, 0009, 0012, 0015, 2002, 2011, 2013, .. 2014, 2021, 2023, 2026, 2104, 2131  
 MGA ..... 0004, 0027, 2029, 2065, 2113  
 MGN Technology ..... 2013  
 Midland ..... 0032, 2053  
 Minolta ..... 0005, 0035, 2055, 2056, 2107  
 Mitsubishi ..... 0004, 0005, 0027, 0035, 0040, 2029, 2055, .. 2056, 2065, 2066, 2067, 2069, 2070, 2071, 2072, 2073 .. 2074, 2106, 2113, 2123  
 Montgomery Ward ..... 0006, 2075, 2131  
 Motorola ..... 2021, 2131  
 MTC ..... 0007, 0015, 2002, 2013, 2026  
 Multitech ..... 0007, 0015, 0031, 0032, 2002, 2013, 2016, .. 2026, 2053, 2061  
 NEC ..... 0002, 0014, 0016, 0030, 0044, 0046, 0059, 0061, .. 0064, 2009, 2010, 2011, 2016, 2018, 2058, 2064, 2076, .. 2078, 2079, 2111, 2123  
 Nikko ..... 2014  
 Noblex ..... 2013  
 Olympus ..... 2021  
 Optimus ..... 2014, 2131  
 Optonica ..... 2096  
 Orion ..... 2035  
 Panasonic ..... 0008, 0053, 0075, 0077, 2021, 2022, 2109, .. 2125, 2126, 2127  
 Pentax ..... 0005, 0035, 0044, 2016, 2055, 2056, 2107, 2120  
 Pentax Research + ..... 0046, 2018  
 Philco ..... 0008, 0029, 0053, 0056, 2021, 2022, 2062, 2063  
 Philips ..... 0008, 0029, 2021, 2062, 2096, 2124  
 Pilot ..... 2014  
 Pioneer 0005, 0016, 0050, 2010, 2055, 2080, 2081, 2123  
 Portland ..... 0044, 0045, 0052, 2016, 2017, 2019, 2110  
 PROSCAN ..... 0000, 2000, 2001  
 Protec ..... 2061  
 Pulsar ..... 2104  
 Quarter ..... 2011  
 Quartz ..... 0002, 2011  
 Quasar ..... 0008, 0053, 2021, 2022, 2125  
 RCA ..... 0000, 0005, 0007, 0008, 0028, 0035, 0037, 0054, .. 0069, 2000, 2001, 2003, 2013, 2021, 2055, 2056, 2082, .. 2083, 2084, 2085, 2086, 2087, 2088, 2089, 2090, 2091, .. 2107, 2115, 2120, 2125  
 Radio Shack .. 0002, 0006, 0008, 0009, 0012, 0015, 0019, .. 0027, 0043, 0053, 2002, 2011, 2013, 2014, 2021, 2022, .. 2023, 2026, 2029, 2049, 2050, 2096, 2131  
 Realistic 0002, 0006, 0008, 0009, 0012, 0015, 0019, 0027, .. 0043, 0053, 2002, 2011, 2013, 2014, 2021, 2022, 2023, .. 2026, 2029, 2049, 2050, 2096, 2131  
 Radix ..... 2014  
 Randex ..... 2014  
 Ricoh ..... 2128  
 Runco ..... 2104

Samsung .... 0007, 0013, 0022, 0032, 0042, 2005, 2013, .. 2015, 2033, 2053, 2112  
 Sanky ..... 2104, 2131  
 Sansui ..... 0016, 0071, 2010, 2092, 2111, 2123  
 Sanyo ..... 0002, 0012, 2011, 2013, 2023  
 Scott 0004, 0013, 0041, 0049, 0068, 2012, 2015, 2025, .. 2032, 2035, 2038, 2065, 2093, 2116  
 Sears 0002, 0005, 0009, 0012, 0018, 0019, 0035, 0043, 0048, 2011, 2014, 2021, 2023, 2048, 2049, 2050, 2051, .. 2055, 2056, 2107, 2118  
 Sharp 0006, 0024, 0027, 0039, 0045, 2002, 2017, 2029, .. 2094, 2095, 2096, 2131  
 Shintom .... 0017, 0026, 0031, 0055, 2004, 2056, 2061, .. 2098  
 Shogun ..... 2013  
 Signature ..... 0015, 2002, 2131  
 Singer ..... 2021, 2061, 2128  
 Sony 0017, 0026, 0038, 2002, 2004, 2098, 2099, 2119, .. 2128  
 STS ..... 2021, 2107, 2021, 2107  
 Sylvania ..... 0008, 0015, 0029, 0053, 0056, 2002, 2021, .. 2022, 2026, 2062, 2063, 2065, 2124  
 Symphonic ..... 0015, 2002, 2026  
 Tandy ..... 0002, 0015, 2002, 2011  
 Tashiko ..... 0009, 2014  
 Tatung ..... 0030, 2058, 2111  
 Teac .. 0015, 0030, 0069, 2002, 2026, 2058, 2085, 2111  
 Technics ..... 0008, 2021, 2109  
 Teknika ..... 0008, 0009, 0015, 0021, 2002, 2014, 2021, .. 2026, 2100, 2129  
 TMK ..... 0067, 2013, 2024, 2047  
 Toshiba ..... 0005, 0013, 0019, 0048, 0049, 2015, 2049, .. 2051, 2055, 2065, 2093, 2116  
 Totevision ..... 0007, 0009, 2013, 2014  
 Unitech ..... 0007, 2013  
 Vector Research 0014, 0016, 0044, 2009, 2010, 2015, .. 2016  
 Victor ..... 0016, 2010  
 Video Concepts . 0014, 0016, 0044, 2009, 2010, 2015, .. 2016, 2113  
 Videosonic ..... 0007, 2013  
 Wards ..... 0005, 0006, 0007, 0008, 0009, 0012, 0013, 0015, 0025, 0027, 0031, 0035, 2002, 2013, 2014, 2015, .. 2021, 2023, 2026, 2029, .. 2055, 2056, 2061, 2096, 2101, .. 2102, 2103, 2107, 2116, 2131  
 XR-1000 ..... 2021, 2026, 2061  
 Yamaha ..... 0002, 0014, 0016, 0030, 0046, 2009, 2010, .. 2011, 2018, 2058, 2111  
 Zenith ..... 0011, 0017, 0026, 0072, 0079, 2004, 2098, .. 2104, 2119, 2128

## Cable Box

ABC ..... 5002, 5003, 5004, 5005, 5006, 5007, 5053  
 Antronix ..... 5008, 5009  
 Archer ..... 5008, 5009, 5010, 5011  
 Cabletenna ..... 5008  
 Cableview ..... 5008  
 Century ..... 5011  
 Citizen ..... 5011  
 Colour Voice ..... 5012, 5013  
 Comtronics ..... 5014, 5015  
 Contec ..... 5016  
 Eastern ..... 5017  
 Garrard ..... 5011  
 GC Electronics ..... 5009  
 Gemini ..... 5018, 5019, 5049  
 General Instrument ..... 5003  
 Hamlin ..... 5020, 5021, 5022, 5035, 5045  
 Hitachi ..... 5003  
 Hytex ..... 5002

Jasco ..... 5011  
 Jerrold ..... 5003, 5005, 5007, 5018, 5023, 5024, 5046, 5053  
 Magnavox ..... 5025  
 Memorex ..... 5026  
 Movie Time ..... 5002, 5027, 5028  
 NSC ..... 5002, 5027, 5028  
 Oak ..... 5002, 5016, 5029  
 Panasonic ..... 5048, 5052  
 Paragon ..... 5026  
 Philips ..... 5011, 5012, 5013, 5019, 5025, 5030, .. 5031, 5032  
 Pioneer ..... 5033, 5034  
 Pulsar ..... 5026  
 RCA ..... 5047, 5049, 5052  
 Realistic ..... 5009, 5049  
 Regal ..... 5022, 5035  
 Regency ..... 5017  
 Rembrandt ..... 5003  
 Runco ..... 5026  
 Samsung ..... 5014, 5034  
 Scientific Atlanta ..... 5006, 5036, 5037, 5038  
 Signal ..... 5014, 5018  
 Signature ..... 5003  
 SL Marx ..... 5014  
 Sprucer ..... 5052  
 Starcom ..... 5007, 5018, 5053  
 Stargate ..... 5014, 5018  
 Starquest ..... 5018  
 Tandy ..... 5040  
 Teleview ..... 5014  
 Tocom ..... 5004, 5023, 5041  
 Toshiba ..... 5026  
 Tusa ..... 5018  
 TV86 ..... 5027  
 Unika ..... 5008, 5009, 5011  
 United Artists ..... 5002  
 United Cable ..... 5053  
 Universal ..... 5008, 5009, 5010, 5011  
 Videoway ..... 5044  
 Viewstar ..... 5015, 5025, 5027, 5040  
 Zenith ..... 5026, 5050, 5051

## Satellite Receiver

Chapparral ..... 5056, 5057  
 Drake ..... 5058, 5059  
 GE ..... 5000, 5001  
 General Instruments ..... 5060, 5061, 5062  
 Panasonic ..... 5075  
 Primostar ..... 5076  
 PROSCAN ..... 5000, 5001  
 RCA ..... 5000, 5001  
 Realistic ..... 5063  
 Sony ..... 5072  
 STS1 ..... 5064  
 STS2 ..... 5065  
 STS3 ..... 5066  
 STS4 ..... 5067  
 Toshiba ..... 5068  
 Toshiba ..... 5073  
 Uniden ..... 5069

## Audio

(For RCA and Dimensia brands only)

AM/FM ..... 4003  
 Aux ..... 4004  
 Phono ..... 4005  
 CD ..... 4007  
 Tape ..... 4006

# PROGRAM GUIDES

## WHAT IS A PROGRAM GUIDE?

A program guide is an on-screen programming schedule. There are several types of guides, each presenting the schedule in a different format.

Using the program guides is easy as long as you remember the Point and Select rule. Point to items on the screen by pressing the arrow buttons on the remote control or front panel. Then, press OK to tune to that program.

**1** SETUP AND CONNECTIONS



**2** USING THE REMOTE



**3** PROGRAM GUIDES



**4** THE MENU SYSTEM



**5** TIPS & TROUBLESHOOTING

# PROGRAM GUIDES

## ANATOMY OF A PROGRAM GUIDE

The following diagram shows you the kind of information you will see in the program guides.

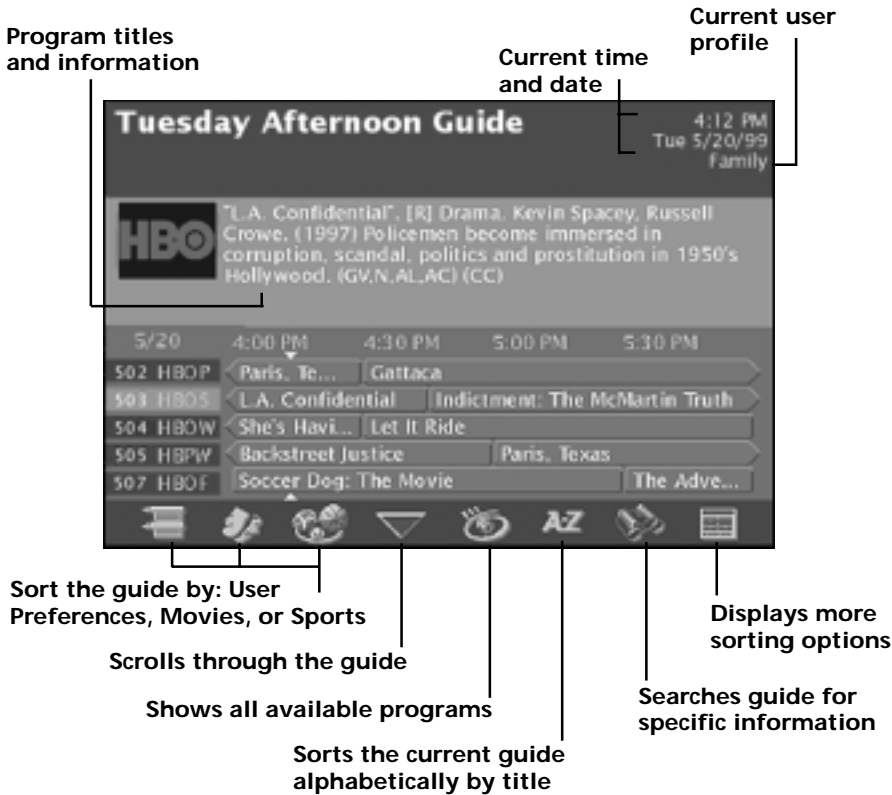

To change the current user, press the WHO•INPUT button while in a program guide.

## BRINGING UP THE PROGRAM GUIDES

You can access the program guides by pressing MENU on the remote control and selecting *Program Guide*, or by using the GUIDE button on the remote.



# PROGRAM GUIDES

## THE CHANNEL BANNER

The channel banner appears whenever you do one of the following:

- tune to a channel
- press INFO, DIRECTV, AUX, or GO BACK from video
- exit a program guide or menu by selecting *Back*

On-screen icons represent frequently-used menu items. Some icons also change appearance to show the item's status. Use the arrow buttons and OK to choose an icon. Some of the items you select in the channel banner can also be selected in the program guides.

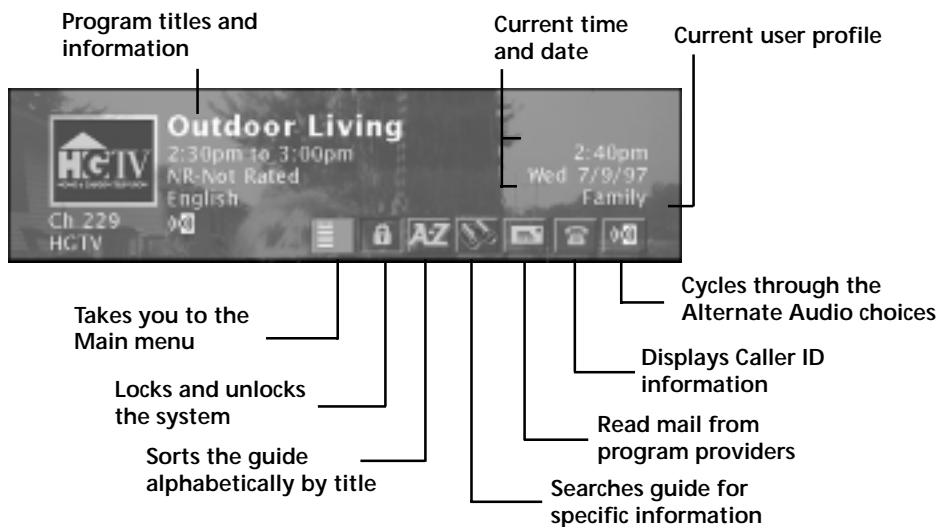

**Main Menu icon** When selected, takes you to the Main menu.

**Green Unlock icon** The system is unlocked. Spending, viewing and other limits can be accessed and changed.

**Yellow Unlock icon** A password has been entered to override family or profile limits. No limits can be accessed or changed.

**Yellow Unlock icon with a "P"** A password has been entered to override limits for the current program. After the program ends, limits are restored.

**Red Lock icon** No limits can be accessed or changed. A password is required to override spending, viewing, and other limits or access the menu system.

**AlphaSort™ icon** When selected, allows you to sort program titles alphabetically.

**Scout™ (binoculars) icon** When selected, allows you to use keywords to search for programs. The icon will be white if a Scout has found program information.

**Mail icon** When selected, takes you to the Mail screen. The icon will be white if you have an unread message or messages.

**Telephone icon** When selected, takes you to the Caller ID list screen. The icon will be white if you have received a new call but have not accessed the Caller ID List screen. It will be gray if you have accessed the Caller ID List screen.

**Alternate Audio icon** When selected, cycles through the alternate audio choices.

# PROGRAM GUIDES

## USING THE GUIDE BUTTON

Each time you press the GUIDE button, a different type of program guide appears.

### The Detail Guide

The Detail Guide shows five channels in a time-and-channel format, with program information for the highlighted program.



Detail Guide

### The Grid Guide

The Grid Guide shows seven channels in a time-and-channel format. A small window showing the program you were watching before entering the program guides is displayed in the upper left hand corner.

## GETTING AROUND IN THE GUIDES

This section describes how to change channels and move around a program guide.

### Point to Channels With the Digit Buttons (0–9)

You can point quickly to any channel in the program guide by entering the channel number with the digit buttons (0–9) and pressing OK. For example, to point to channel 228, press the digits 2-2-8 then press OK on the remote control. If the number is four digits long, you don't have to press OK.

### Scrolling Channel By Channel

The programs that you see on the TV screen make up one section—or page—of the total program guide. You can scroll to other pages using the arrows: point to other times with the left and right arrows; point to other channels with the up and down arrows.

### Scrolling Page By Page

If you want to scroll up or down through the program guide faster, press the CH +/- buttons on the remote control. The highlight scrolls a page at a time.



Grid Guide

By default, the Grid Guide appears when you press GUIDE on the remote. You can change the default guide from the Grid Guide to the Detail Guide.

Select *Options* from the Main menu. Select *Look and Feel*, then set the *Default Guide*.

# PROGRAM GUIDES

## TUNING TO A PROGRAM

To tune directly to a current program listed in the guide, point to the program and press OK.

To see information about a program in the guide, point to the program and press INFO.

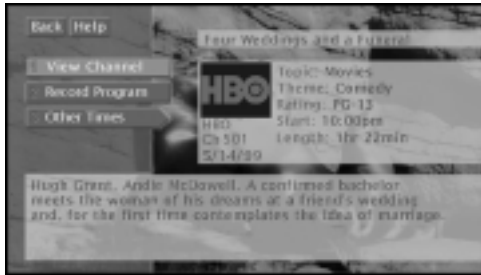

*The Program Details screen gives you several options.*

Then, you can select:

- *View Channel* to tune to that channel
- *Record Program* to record the program
- *Other Times* to see what other times the program is available. The program title is automatically entered and sorted in the AlphaSort control panel.

The options available to you may vary according to the type of program you select.

For information on tuning to a PPV program, see "The Menu System" section.

# PROGRAM GUIDES

## ADDITIONAL PROGRAM GUIDES

Besides the Detail Guide and Grid Guide, there are a few more guides: the Channel Guide, the Logo Guide, and the Attractions Guide, plus the sorting variables Guide Data and Channel Groups.

You can access these guides and sorting variables by selecting the *Other Guides* icon at the bottom of the Detail Guide and Grid Guide.



Other Guides icon

### The Channel Guide

Displays the programming schedule for the selected channel.



Scroll up and down to see programming information for the selected channel.

### The Logo Guide

Displays channel logos for the current user's channel list.

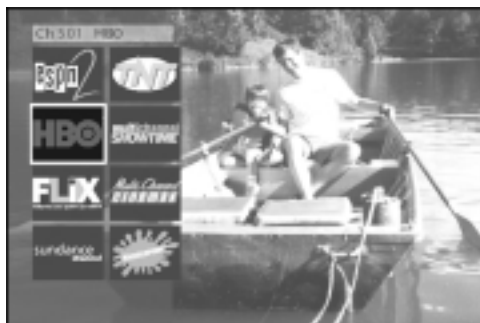

The Logo Guide.

You can point to any program and tune to it or get more information. Just press the OK or INFO buttons.

### Exiting A Program Guide

There are three ways to exit a guide (not all methods work in all guides):

- Point to a channel and press OK.
- Point to *Back* and press OK.
- Press CLEAR or GO BACK on the remote control.



# PROGRAM GUIDES

## The Attractions Guide

Displays a list of channels that show coming attractions and special events information.

## Other Sorting Variables

The *Other Guides* icon also lets you sort the guide by different variables, such as future times (Guide Data), user profile channel lists, and channel groups. You can then choose a guide format to view the program information. For example, you could sort the guide by Pay Per View movies that will be available in the next five hours:

1. Select the *Other Guides* icon.
2. Select *Guide Data* and use the arrow buttons and the OK button on the remote control to choose +5.0 hours.



*Guide Data lets you see what's on in the future.*

3. Select *PPV* in the *Channel Groups* category.



*Channel Groups is another way to sort programming.*

Select *Back*, or press the GO BACK button on the remote control to return to the previous guide. You can also choose another guide format from the *Other Guides* menu.

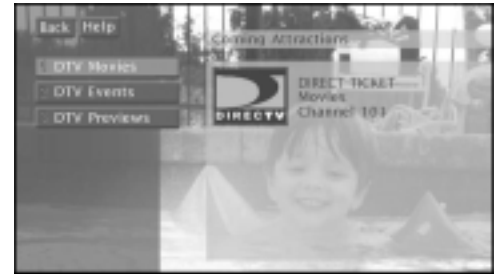

*The Attractions Guide.*

# PROGRAM GUIDES

## SORTING THE GUIDES

Sorting the guide is a way of organizing the guide to show only the types of programs that interest you. There are several on-screen icons that sort the guide in different ways.



The sorting icons appear at the bottom of the Grid Guide and Detail Guide.

## User Preferences

The *User Preferences* icon sorts the guide according to the current user's preferences. The current user's profile name is displayed in the upper right of the Grid and Detail Guides and can be changed by pressing the WHO•INPUT button on the remote control. Select the *User Preferences* icon to sort the guide.

The *User Preferences* icon changes to the *Edit User Preferences* icon. Press the *Edit User Preferences* icon to edit the current user's themes preferences. These preferences are saved in each user's profile.



User Preferences icon



Edit User Preferences icon



Checkmark the themes that interest you.

Select the categories (topics), and checkmark the themes you would like to appear when you select the *User Preferences* icon in the guides. Only programming that fits the description of checkmarked themes will appear in the guide when you sort by the *User Preferences* icon.

To change the current user, press the WHO•INPUT button while in a program guide.

# PROGRAM GUIDES

## Movies

Select the *Movies* icon to list movies only. After selecting *Movies*, the *Movies* icon changes to a *Movies Themes* icon.

Select the *Movies Themes* icon to sort the guide to list specific types of movies, such as comedies or musicals. This icon may change from *Movies* to a different topic in the future, but it will continue to function in the same way.



Select a *Movies Theme* that interests you.



**Movies icon**



**Movies Themes icon**

## Sports

Select the *Sports* icon to list sporting events only. After selecting *Sports*, the *Sports* icon changes to a *Sports Themes* icon.

Select the *Sports Themes* icon to sort the guide to list specific types of sports, such as basketball or soccer. This icon may change from *Sports* to a different topic in the future, but it will continue to function in the same way.



Select a *Sports Theme* that interests you.



**Sports icon**



**Sports Themes icon**

# PROGRAM GUIDES

## All

The *All* icon resets the guide to show all available topics, channels and listings for the current profile.



All icon

## AlphaSort™

*AlphaSort* lists all the program titles in the current guide in alphabetical order. Select the *AlphaSort* icon to search for specific program titles that are in the current program guide in alphabetical order. Use the arrow buttons on the remote control to highlight a character, then press OK.



AlphaSort icon

For example, to search for the program *Auto Racing*, point to and select "A." (Words like "The," "A," and "An" appear at the end of a title.) All titles that begin with "A" appear in the *AlphaSort* list. Next, enter the letter "U." All titles beginning with "AU" appear in the list.

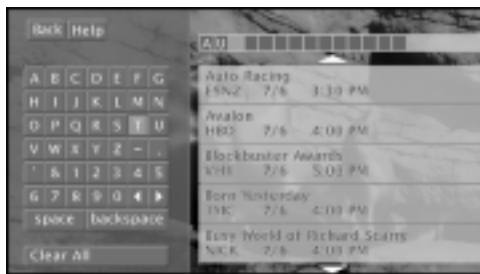

*AlphaSort* searches for specific titles in the guide.

Continue to enter the specific title until it appears in the *AlphaSort* list. If you enter the wrong character, select either *Backspace* or *Clear All*.

Use the arrow buttons on the remote control to highlight the title you are looking for. Press the OK button to select it, or the INFO button to see more information. AlphaSort can only find titles that are in the current program guide. For example, if you have sorted the guide to show only movies, AlphaSort will find only movie titles that match your entry.

# PROGRAM GUIDES

## Scout™

The *Scout* icon lets you assign “Scouts” to search the guide for specific program information, such as actors’ names or program descriptions.

Select the *Scout* icon from a program guide to view the available Scouts. Then, point to an available Scout (one without a checkmark by its name) and select it.

Select *Enter Text* to set up the information the *Scout* will look for in the program guide. Use the on-screen keyboard to enter the desired search parameters.

For example, if you are interested in how to prepare food, enter a common term you think would occur in program information, like “cooking.” When you have finished entering your topic select *Run Scout*.



Select *Enter Text* to set up a Scout.

If “cooking” appears within a program title or program description, the program will be included in the Scout Results program list.

(continued on next page)



Scout icon

On-screen icons represent the status of scout:



Indicates that a scout is set to find specific information.



Indicates that a scout has found the information you specified.

# PROGRAM GUIDES

Once you have set up a Scout, you can check its status by highlighting that Scout. A highlighted binoculars icon means that a Scout has found results.

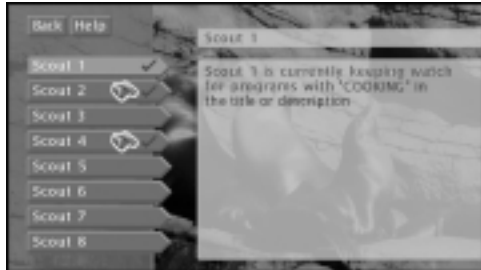

*Scout 1 is in use, but has not yet found anything. Scouts 2 and 4 have results.*

The Scout will search for information when the digital satellite receiver is off. (This may take up to 30 minutes for a full guide search.)

Check a Scout's results by selecting that Scout, then selecting *Scout Results*.

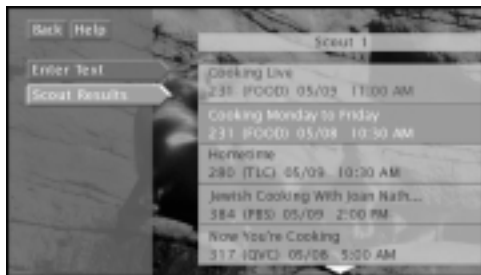

*Scout results lists the Scout's findings.*

## Down Arrow

The down arrow icon allows you to scroll down through other channels in the guide. Point to the down arrow icon and then press OK to scroll down through the program guide.



**Down Arrow icon**

# THE MENU SYSTEM

## WHAT'S A MENU?

The on-screen menu is a list of choices, just like a menu in a restaurant. And, just as a restaurant menu is divided into sections such as appetizers, entrees, and desserts, the on-screen menus are also separated into sections to help you find the information you need.

## DON'T FORGET POINT AND SELECT

As with all of the on-screen displays, you use Point and Select to navigate within the menu system.

**1** SETUP AND CONNECTIONS



**2** USING THE REMOTE



**3** PROGRAM GUIDES



**4** THE MENU SYSTEM



**5** TIPS & TROUBLESHOOTING

# THE MENU SYSTEM

## USING THE MENU SYSTEM

To bring up the Main menu, press MENU on the remote control.



Use point and select to choose an item from the Main menu.

To use the menu system, you need to know the Point and Select rule: use the arrow buttons on the remote control to point to an item on the screen, and then press OK to select it. In numbered menus, use the digit buttons to select an item quickly.

## BACK AND HELP

There are *Back* and *Help* buttons at the top of most screens. Point to *Back* and press OK to leave that screen. Point to *Help* to see more information about that screen.

## Exiting a Screen

There are three ways to exit a menu:

- Point to *Back* and press OK.
- Press the CLEAR button on the remote control. The on-screen displays clear from the screen and you return to TV viewing.
- Press the GO BACK button on the remote control. You return to the previous on-screen display or normal programming.

## Using Help

All menus have an on-screen *Help* choice. For example, select *Help* from the Main menu to see information about using the Main menu screen.

The rest of the on-screen *Help* choices in the menu system bring up helpful information explaining some aspects of that menu.

If the Main menu doesn't appear when you press MENU, the remote control might not be in DIRECTV mode. Try pressing the DIRECTV button on the remote, and then MENU.

## Context-Sensitive Help

Most of the screens contain information to help you decide what to do next. If you get stuck, look for the help text at the bottom of the screen.



# THE MENU SYSTEM

## MENU DESCRIPTIONS

This section briefly describes each of the available Main menu options. More information about each menu and its features is included later in this chapter.

### Program Guide

Shows the on-screen programming schedules.

### Messages

Access Caller ID information from your telephone company and mail messages from DIRECTV.

### Purchases

Review or cancel upcoming purchases, review past purchases, and set spending limits.

### Timers

Schedule the digital satellite receiver to tune to a specific channel at a specific time, or to record future programming, if your VCR has been properly set up.

### Profiles

Set system and user passwords, ratings limits, spending limits, and viewing hours, as well as create favorite channel lists.

### Options

Find out more about the digital satellite receiver and remote control, change how your system looks, run the system test, and install a new access card.

### Dish Pointing

Find your dish pointing coordinates and access the on-screen signal strength meter.

Back Help

1 Program Guide

2 Messages

3 Purchases

4 Timers

5 Profiles

6 Options

7 Dish Pointing

### Don't Be Afraid to Explore

Once you've learned the basics, feel free to poke around the menu system—exploring is the best way to learn. The context-sensitive help at the bottom of the screen provides instructions for getting through any particular menu or control panel. Remember, press CLEAR at any time to leave the menu system and return to regular system viewing.

# THE MENU SYSTEM

## THE PROGRAM GUIDE

Selecting *Program Guide* from the Main menu brings up your default program guide: the Detail Guide or the Grid Guide.

## 1 Program Guide

## ANATOMY OF A PROGRAM GUIDE

The following diagram shows you the kind of information you will see in the Detail Guide and Grid Guide (Detail Guide shown here).

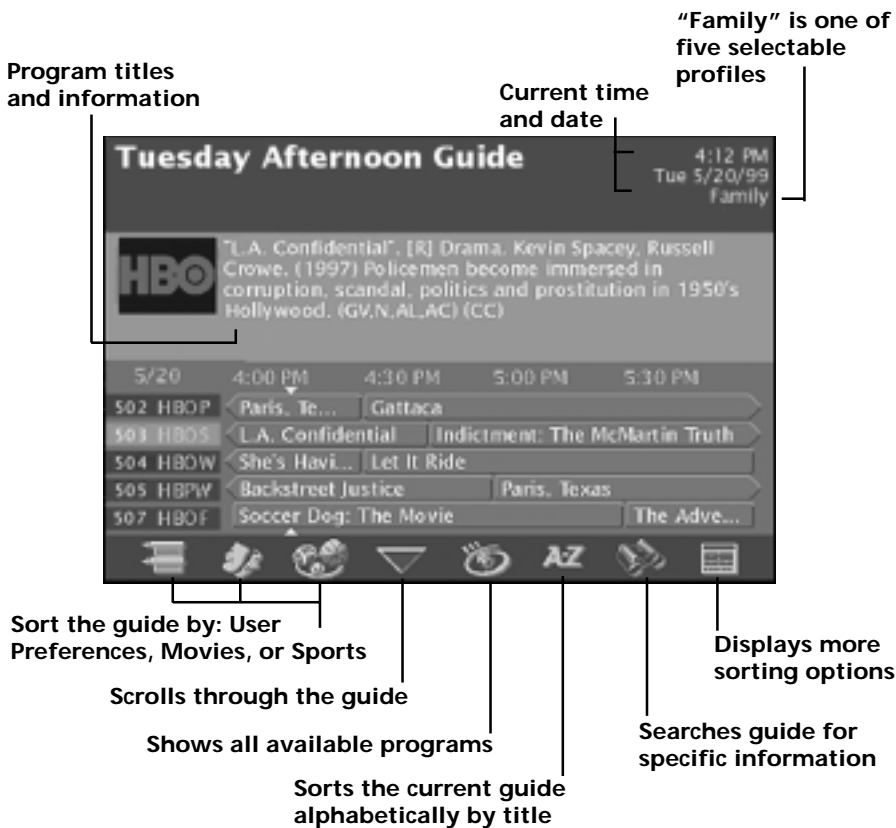

## BRINGING UP THE PROGRAM GUIDES

In addition to selecting *Program Guide* in the Main menu, you can press the GUIDE button on the remote control.

### Want More Information?

Read the "Program Guides" section in this book for all the details.

# THE MENU SYSTEM

## MESSAGES

## 2 Messages

The Messages menu lets you access messages or phone calls. If you select *Mail*, it shows you messages that are sent from DIRECTV. For example, you may receive a message calling your attention to a new service. If you select *Caller ID*, this menu shows you Caller ID information from your telephone provider (if you subscribe to Caller ID service).

## MAIL

There are two ways to tell if you have mail, depending on whether the digital satellite receiver is turned on or off.

- If the digital satellite receiver is turned on, the mail icon in the channel banner is highlighted.
- If the digital satellite receiver is turned off, the light on the front panel of the receiver flashes.

## Checking Your Mail

Select *Messages* from the Main menu, then *Mail* from the next menu. Or select the envelope icon on the channel banner to view your mail.

1. Point to a message and press OK. The message is opened for you to read.



*Mail provides the latest information from program providers.*

2. Press OK again to close the message.

If you want to erase a message, point to *Erase Message* and press OK. When you exit *Messages*, messages that aren't erased are saved in memory.

# THE MENU SYSTEM

## CALLER ID

Your digital satellite receiver is capable of displaying and storing Caller ID information provided by your local telephone company. **To use this feature, you must have your receiver directly plugged into a telephone outlet (not a wireless jack) and you must subscribe to Caller ID or similar caller identification services.**

Your Caller ID enables you to:

- Identify callers before you answer the phone.
- View the time and date of each incoming call.
- Record up to 10 incoming calls sequentially.
- See who called while you were away.

There are two ways to access the Caller ID menus: by selecting *Messages* from the Main menu, or by pressing INFO on the remote control and selecting the telephone icon in the Channel Banner. The icon will be white if you have received a new call but have not accessed the Caller ID List screen. It will be gray if you have accessed the Caller ID List screen.

## Setting Up Caller ID

To set up your Caller ID, go to the Main menu and select *Messages*. Then select *Caller ID Setup*. Use the up and down arrow buttons and OK to select your preferences.

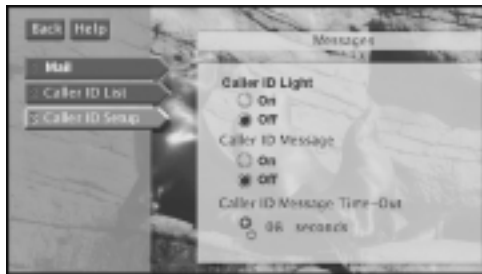

This screen allows you to set up your Caller ID.

**Caller ID Light** Setting *Caller ID Light* to *On* causes the front panel light to flash if you receive new calls while the digital satellite receiver is off. The light will flash until you turn the receiver on.

**Caller ID Message** Setting *Caller ID Message* to *On* displays the on-screen Caller ID banner when a call is received. You may want to turn this feature off when you are recording manually and do not want the on-screen messages to appear on your recordings. Your calls will be stored in the Caller ID List screen even when Caller ID is turned off.

**Caller ID Message Time-out** Set the amount of time (from 1–30 seconds) that the Caller ID banner will display when you have an incoming call. For this feature to work, make sure *Caller ID Message* is set to *On*.

## 2 Messages

### Reminder

This feature requires a subscription to a Caller ID service from your telephone company.

When you have unread Caller ID calls:

- The front panel light will flash (when the digital satellite receiver is off)
- The telephone icon in the channel banner will be highlighted white

### Important

If you have a timer set to either watch or record, the Caller ID banner will be temporarily overridden for the duration of that timer. When the timer event is over, the Caller ID banner will display as selected under *Caller ID Message*.

When viewing or recording manually (not using a timer) the Caller ID banner will display (and be recorded if recording) as selected under *Caller ID Message*.

At all times Caller ID messages will be stored in the Caller ID List screen (unless a call arrives when you are on the telephone and you do not have a Type II box or Type II service).

# THE MENU SYSTEM

## Receiving Calls

When your phone rings twice and *Caller ID Message* is set to *On*, a banner appears at the bottom of the screen.

The banner may include the phone number, date, and time; or the name, phone number, date, and time. The banner information depends on the type of service your telephone company provides.



*The Caller ID banner appears at the bottom of the screen when you receive a call.*

The Caller ID banner will override closed captioning at the bottom of the screen and will appear for the amount of time selected in the *Caller ID Setup* screen. The Caller ID banner will not be displayed if you are in the menu system or a timer is active when you receive a call.

## Message Indicators

The following is text that may appear in the incoming Caller ID banner and call list.

**Out of Area** The name and/or phone number of the incoming call is coming from outside the local area.

**Private Name** The name of the incoming call is sent as "Blocked" from the phone company.

**Private Number** The phone number of the incoming call is sent as "Blocked" from the phone company.

**Unknown Name** The name of the incoming call is not provided by the telephone company or the information is unreadable.

**Unknown Number** The number of the incoming call is not provided by the telephone company or the information is unreadable.

## 2 Messages

If you'd like more information to appear in your Caller ID banner and call list, or if you'd like to subscribe to Caller ID, check with your local phone company about the availability of different types of Caller ID service.

To clear the Caller ID banner from the screen, press CLEAR on the remote control.

# THE MENU SYSTEM

## The Caller ID List Screen

The digital satellite receiver can store up to 10 call entries in the Caller ID List screen. When the memory is full, a new call automatically replaces the oldest call in memory. The list also tells you if you have received multiple calls from the same number.

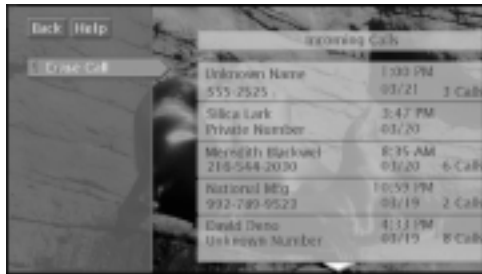

Use this screen to view the last 10 calls.

To access the call list:

- Select *Caller ID List* from the Messages menu, or
- Press the INFO button on the remote control and select the phone icon.

## Deleting Calls

From the Caller ID List screen, you can delete entries:

1. Highlight the call you wish to delete and press OK.
2. A crumpled paper icon appears to indicate that you wish to delete the call.
3. To permanently delete the call, exit the screen. If you change your mind before exiting the screen, highlight the call then press OK to restore it. The crumpled paper icon should disappear.

## 2 Messages

### Note

If you are using your telephone and another call arrives, the new call's information will neither appear in the banner nor be recorded in the Caller ID List screen unless you have type II service and a type II Caller ID box in your house.

### Don't Forget About the CLEAR Button

Press the CLEAR button on the remote control to remove the on-screen menus and return to normal viewing.

# THE MENU SYSTEM

## USING THE PURCHASES MENU

The Purchases menu allows you to review upcoming and past purchases and set spending limits.

### 3 Purchases

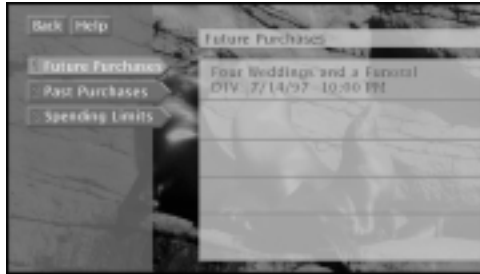

Use the Purchases menu to keep track of program purchase spending.

The list of purchases may be longer than one screen; use the up and down arrow buttons to see more items. The display also shows the title, channel, date, time, and cost of each program.

- Note that the *Past Purchases* list might not show purchases you've already paid for because the list isn't updated until the end of the billing cycle.

## REVIEWING AND CANCELING AN UPCOMING PURCHASE

Use Point and Select to choose an upcoming purchase from the *Future Purchases* screen. You can review the program description, as well as cancel an upcoming purchase.

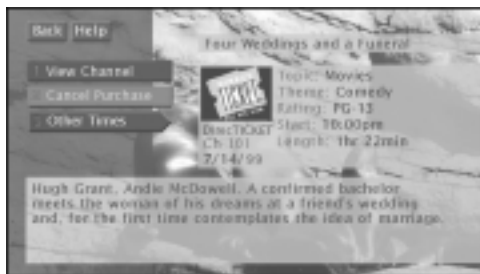

Canceling a future purchase (Program Details screen).

# THE MENU SYSTEM

## SPENDING LIMITS

Use the *Spending Limit* option to indicate a per-event spending limit for Pay Per View programs.

1. Point to *Spending Limit*, and press OK.
2. Select the user profile you'd like to set a spending limit for, then use the digits on the remote control or use the arrow buttons to enter a single-program spending limit.

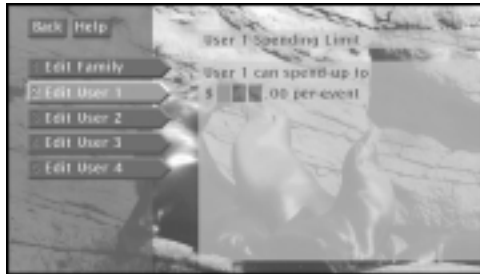

*You can set a per-event spending limit for each Profile.*

After a spending limit is set *and* the system is locked, you must enter a password to purchase a Pay Per View program that costs more than your spending limit allows.

## PAY PER VIEW PROGRAMS

Pay Per View (PPV) programs are DIRECTV programs that you can purchase—like a movie ticket—if you subscribe to DIRECTV® programming and have your digital satellite receiver connected to a telephone line (see the “Setup and Connections” section for more information). You can preview movies on certain channels to determine if you would like to purchase them. See “Previewing and Purchasing” and “Using the Attractions Guide,” next in this section, for more information.

## 3 Purchases

### Important!

Spending limits are in effect only when the system is locked. See “Locking the System,” later in this section, for details.



# THE MENU SYSTEM

## PREVIEWING AND PURCHASING

You can preview and purchase DIRECTV Pay Per View movies and events if you subscribe to DIRECTV® programming and have your digital satellite receiver connected to a telephone line.

### To preview a movie or event:

- When the DIRECTV® programming guide is on the screen, press the down arrow button on the remote control to move the highlight to the bottom of the screen. Select the *Other Guides* icon and then select *Attractions*. Select a channel.

### To purchase a movie or event, you can take one of two actions:

- Tune to a PPV channel by channel surfing among available channels. When you find one, press the INFO button to find more information and details about how to purchase the program.
- Highlight a PPV program in a program guide and press INFO. The Program Details screen will appear and give you more information about the program. From this screen you can also purchase the program.

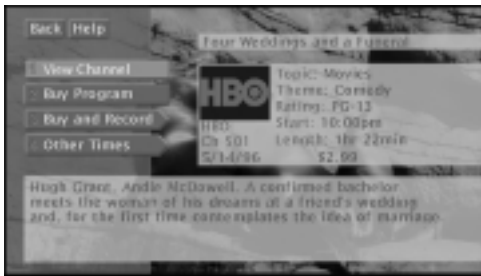

The Program Details screen gives you several options.

You can select:

- *View Channel* to view that channel
- *Buy Program* to purchase the program
- *Buy and Record* to purchase the program and set a timer to record it
- *Other Times* to see what other times the program is available

The options available to you may vary according to the type of program you select.

## 3 Purchases



Other Guides icon

If you want to order PPV programs using the on-screen menus, you need to connect your digital satellite receiver to a telephone line.

You may need to enter your four-digit password to order a PPV program if it costs more than the spending limit you set up in the Profiles or Purchases menu.

# THE MENU SYSTEM

## USING THE ATTRACTIONS GUIDE

Your program providers may offer future programming events not currently listed in your program guide. These events are called “Coming Attractions,” and can be previewed in the Attractions Guide.

1. Press the GUIDE button on the remote control.
2. Use the down arrow button to move the highlight to the bottom of the screen.
3. Point to and select the *Other Guides* icon.
4. Point to and select *Attractions*.



*The Other Guides menu provides several guide formats.*

5. Point to a channel and select it.



*The Attractions Guide is accessed through the Other Guides menu.*

## Purchases



**Other Guides icon**

# THE MENU SYSTEM

## TIMERS FEATURE

The Timers feature allows you to preset your digital satellite receiver to automatically tune to a particular channel at a predetermined time.

To use the Timers feature, select *Timers* from the Main menu. Select a Timer (1-8) and then use the arrow buttons to complete the on-screen sentence. When the sentence is complete, select *Run Timer*.

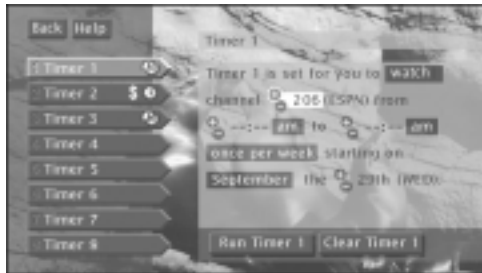

Complete the on-screen sentence to set up a timer.

### Setting Up Timer Recordings

The Timers feature allows you to set up timer recordings if you have connected the VCR Controller to your digital satellite receiver and told the receiver what type of VCR you are using. See the "Setup and Connections" section for details on connecting a VCR Controller.

### Editing or Canceling a Timer

From the Timers screen, select the Timer you want to edit or cancel, and then do the following:

- Use the arrows buttons to edit the Timer, then select *Run Timer*.
- Select *Clear Timer* to cancel the timer.
- To watch the program daily or weekly, edit that program's Timer.

Selecting *View Channel* or *Buy Program* will tune to the program's channel without recording. The options available to you will vary according to the type of program you select.

## 4 Timers

If you subscribe to Caller ID service, note that the Caller ID banner will neither be displayed or recorded during a timer (watch or record). However, all calls will be logged. The banner will display as selected when the timer recording is over.

On-screen icons are a quick way to understand the timers:



Indicates that the timer is set.



Indicates that the timer is set for a PPV.



Indicates a timer conflict.

# THE MENU SYSTEM

## Recording with a Timer

If you choose *Record* instead of *Watch* when setting a Timer (and have set up your VCR as previously discussed), the Timer will turn on your VCR, then start and stop recording a program.

To record with timers:

- Your VCR must be tuned to channel 3 or 4 (if the VCR is connected with just coaxial cables), or to the video input channel (if the VCR is connected with audio/video cables).
- You must turn your VCR off prior to the scheduled recording time.
- You must have a recordable tape in the VCR.

## Schedule a Timer with the RECORD Button

You can schedule a recording directly from the guide.

1. With a program highlighted, press the RECORD button on the remote control. The *Program Details* screen appears.

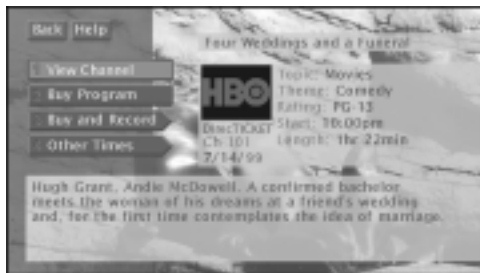

*The choices available to you will differ depending on the nature of the selected program: PPV or non PPV.*

2. To schedule a timer to record, select:
  - *Record Program* to set a timer to record the program, or
  - *Buy and Record* to purchase the program and set up a timer to record the program. (Programs bought to be recorded may have a different purchase price than those bought for viewing only.)

## 4 Timers

# THE MENU SYSTEM

## PROFILES

## 5 Profiles

When you select *Profiles* from the Main menu, the first screen you see presents a menu of user profiles from which to choose. In addition to the Family profile, you can create as many as four different profiles that can be easily accessed using the WHO•INPUT button on the remote control.



*You can select one of five user profiles or lock and unlock the system.*

You can also edit the user profiles. Select a profile to set a rating limit, viewing hours, and a per-event spending limit, name the profile, create a channel list, and assign a user password.

## CREATING A PROFILE CHANNEL LIST

1. Point to and select a user.
2. Point to *Edit Channels* and press OK.



*To start, you can add or delete all channels.*

3. Use the arrow buttons to point to a channel, and press OK to remove (or replace) the check mark. Checkmarked items appear in the channel list.

# THE MENU SYSTEM

## Add or Delete All Channels

You might be able to save time when creating a channel list by using the *Add All Channels* option or the *Delete All Channels* option before removing or adding individual channels.

Also, program providers may make additional channels available. To prevent new channels from appearing in a profile channel list, choose *Delete All Channels* and checkmark only the channels you want to appear in the list.

## SETTING THE RATING LIMIT

The Rating Limit menu enables you to set a maximum rating viewing limit for rated movies (based on the MPAA rating system).

- Note that the rating limit cannot be enforced if a program has not been rated, if rating information for that program is not transmitted by the program provider, or if the system has not been locked.
1. Point to *Set Rating Limit* and press OK.

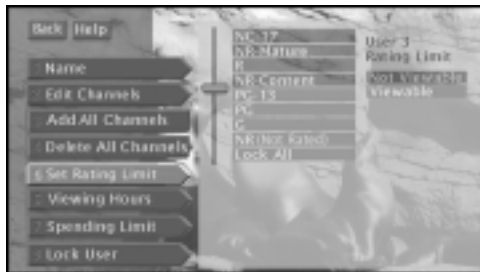

Use the arrow buttons to move the selector up and down.

2. Use the up and down arrow buttons to move the rating selector to the highest rating you want to be able to view. In the preceding illustration, movies that are rated up to and including a "PG-13" rating can be viewed.

After the Rating Limit is set *and* the system is locked, you must enter the system password to watch programs with a rating higher than your limit.

## 5 Profiles

### Important!

You need to lock the system in order for rating limits, channel limits, viewing hours, and spending limits to go into effect.

After you lock the system, you need to enter the system password to edit the limits. See "Locking the System," later in this section, for details.

# THE MENU SYSTEM

## 5 Profiles

### VIEWING HOURS

Use the *Viewing Hours* option to limit the total amount of time, as well as the time of day, that a user can watch programming.

1. Point to *Viewing Hours*, and press OK.



You can limit viewing seven days a week.

2. Use the digits on the remote control or point to the + or – buttons and press OK to complete the on-screen sentence. Choose the days to view, how many hours can be viewed each day (0–24 hours) and when programming can be viewed. Be sure to lock the system for these limits to take effect.

### SETTING UP SPENDING LIMITS

Select the *Spending Limit* option to indicate a per-event spending limit for Pay Per View programs.

1. Point to *Spending Limit*, and press OK.

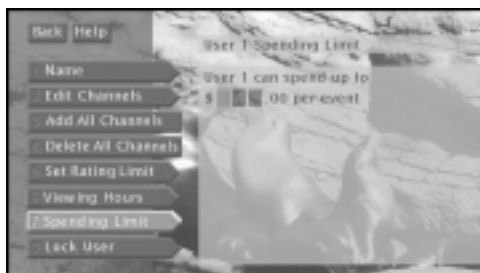

You can set a per-event spending limit for each profile.

2. Use the digits on the remote control or point to the on-screen choices and use the arrow buttons on the remote control to enter a single-program spending limit.

After a Spending Limit is set and the system is locked, you must enter the system password to purchase a Pay Per View program that costs more than your Spending Limit allows.

# THE MENU SYSTEM

## LOCKING A USER'S PROFILE

Users can be assigned a personal password to lock their profile. When a password is assigned, users must enter the password before they can view programs using that profile. Profile passwords do not allow access to, or editing of, the profile limits. You must enter the system password to edit profile limits.

1. Point to *Lock User* and press OK.
2. Use the arrow or digit buttons to select each digit of the password.

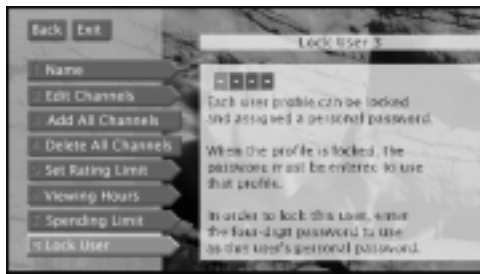

*Each user can have a password.*

## LOCKING THE SYSTEM

Locking the system puts the ratings, spending, viewing, and channel limits you have set up for each profile into effect. When you lock the system, no one can modify any of these settings without first entering the four-digit system password.

1. Point to *Lock System* and press OK.



*Locking the system protects the limits you set.*

2. Use the arrows or the digit buttons to enter a four-digit system password.
3. Enter the password a second time to confirm it. The red lock icon should be displayed in the channel banner.

In order for the changes to take effect, you must exit out of the menu

## 5 Profiles

After the system has been locked, you must enter the correct password in order to access the *Edit Users* control panel.

### Don't Forget Your Password

If you forget a **USER** password, you need to unlock the system and then assign a new user password.

If you forget the **SYSTEM** password, contact the DIRECTV authorization center.



# THE MENU SYSTEM

system.

## Unlocking the System

When the system is unlocked, the channel, spending, viewing, and ratings limits that you set are no longer in effect. To unlock:

1. Point to *Unlock System* in the *Profiles* menu and press OK.
2. Point to *Yes* and press OK to confirm that you want to unlock the system. The green unlock icon should be displayed in the channel banner.

When you attempt to access a channel that is blocked by one or more limits (and the system is locked), you will be asked to override limits by entering the four-digit system password.

If you enter the password to override a limit, all limits are unlocked until you turn off the digital satellite receiver. When you turn on the receiver again, the system will be locked, and the Family profile channel list will be selected. If you want to re-lock the system without turning off the receiver, you can select the lock icon in the channel banner.

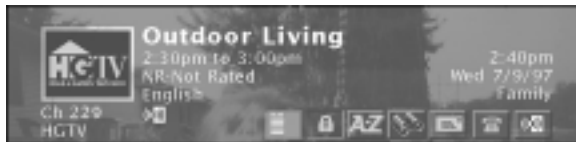

Channel banner icons are a quick way to check the current system lock status. See the note at right for more information.

## Program Unlock

If the system is locked and you want to access a blocked program without unlocking all settings, press INFO and highlight the Lock icon in the channel banner. Make sure to check the box beside "Unlock this program only," and enter the system password. This program is no longer blocked, but all other settings remain in effect. The yellow unlock icon should be displayed in the channel banner.

## 5 Profiles



Use the Lock and Unlock icons in the channel banner to lock or unlock the system. Just press INFO and select the icon to change the lock status.

**Green Unlock icon:** The system is unlocked. No limits are in effect.

Spending, viewing and other limits can be accessed and changed.

**Yellow Unlock icon:** The system is locked, but no limits are in effect. A password has been entered to override the current profile's limits. No limits can be accessed or changed. The next time the digital satellite receiver is turned on, the system will return to *Red Lock* status.

**Yellow Unlock icon with a "P":** The system is locked, but no limits are in effect for the current program. A password has been entered to override the current program's limits. No limits can be accessed or changed. After the program ends, the system will return to *Red Lock* status.

**Red Lock icon:** All limits are in effect. No limits can be accessed or changed. A password is required to override limits or access the system.

# THE MENU SYSTEM

## CHOOSING YOUR PROFILE

## 5 Profiles

Each time you turn on the digital satellite receiver, the Family profile is selected by default. To select a different profile:

1. Press the WHO•INPUT button to scroll through the profiles.



*The WHO•INPUT button toggles through the profiles.*

2. When your profile appears, enter your four-digit personal password to activate your profile.
3. If the profile is not password protected, you can just press OK to activate it.

The channel, spending, rating and viewing limits associated with the chosen profile will be active only when the system is locked.

The active profile also affects what you see in the program guides. Selecting the User Preferences icon sorts the guide to show only programs meeting the current user profile criteria.



*The name of the current user profile appears on screen in the Detail and Grid Guides.*

Press the WHO•INPUT button on the remote control to change the current profile.

# THE MENU SYSTEM

## OPTIONS

The Options menu lets you set up preferences for the look and feel of the system as well as understand how some of the features work.



*The Options menu lets you customize many system features.*

The following sections explain your options when changing your personal preferences. Follow the on-screen instructions to make changes to the system.

## INTERACTIVE SETUP

If you self-installed your satellite dish antenna, you may have already used the interactive setup to find the dish pointing coordinates, acquire and fine-tune the signal, and run a system test. If you just want to check your dish pointing coordinates or run the signal strength meter, select *Dish Pointing* from the Main menu.

## SYSTEM INFO

Select *System Info* from the Options menu to choose from a list of on-line Help topics. Point and select to find out about the specific parts of the DIRECTV System.

**Program Guide** Shows a screen-by-screen overview of the Program Guide features.

**Menu System** Shows a screen-by-screen overview of the DIRECTV System menus.

**Remote Control** Shows a descriptive list of the remote control buttons.

**Front Panel** Shows a list of the digital satellite receiver's front (top) panel features. Point to an item to see a brief description.

**Back Panel** Shows a list of the digital satellite receiver's back panel features. Point to an item to see a brief description.

**Glossary** Shows a list of common DIRECTV System and TV terms. Point to a glossary item to see a brief description.

## Options

Note that if your DIRECTV System is not equipped with Dolby Digital capability, *Dolby Digital* will not be one of the items in the Options menu.

# THE MENU SYSTEM

## LOOK AND FEEL

**Default Guide** Lets you choose which guide appears first when you press the GUIDE button on the remote control. The choices are Grid Guide or Detail Guide.

**Color Scheme** Lets you pick which colors appear in the guide and menu systems.

**Translucency** Lets you choose the translucency of the menu displays. Slide the indicator bar to make the screens more opaque or less opaque.

**Animation** Lets you select which graphics are displayed when you tune to an audio-only channel and also lets you select the animation time-out.

**Edit Fetch** Lets you choose a function for the FETCH button on the remote control: to bring up a custom menu or activate one feature.

To view the Edit Fetch menu or change the function of the FETCH button, press MENU to bring up the Main menu, select *Options*, select *Look and Feel*, then select *Edit Fetch*.

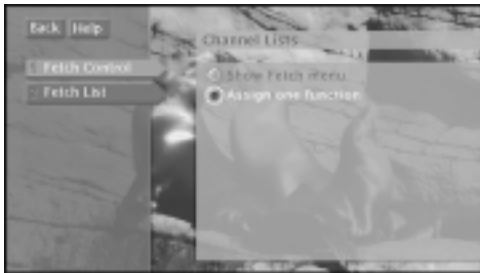

*Edit Fetch lets you combine your favorite features onto one menu, or assign one function to the FETCH button on the remote.*

- **To create a custom Fetch menu:**
  1. Press MENU to bring up the Main menu.
  2. Point to and select *Options*, *Look and Feel*, and then *Edit Fetch*.
  3. Select *Fetch Control*.
  4. Select *Show Fetch Menu*.
  5. Select *Fetch List* from the Edit Fetch menu.

Options

# THE MENU SYSTEM

6. Choose up to eight menu items to include in your customized menu by checkmarking them with the OK button.



Choose which menu items to include in your customized Fetch menu.

7. Press the left arrow button to confirm your selections and return to the menu.

When you would like to access your customized menu, press the FETCH button on the remote control.

- **To assign one function to the FETCH button:**

1. Press MENU to bring up the Main menu.
2. Point to and select *Options, Look and Feel*, and then *Edit Fetch*.
3. Select *Fetch Control*.
4. Select *Assign One Function*.
5. Select *Fetch List* from the Edit Fetch menu.
6. Choose which menu item you would like to assign to the FETCH button by pointing and selecting.

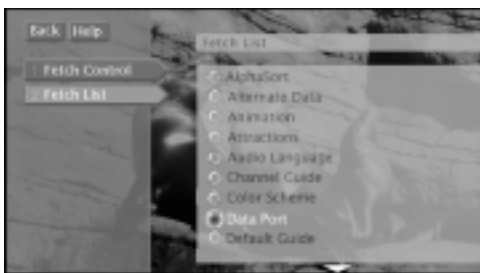

Choose which menu item to assign to the FETCH button.

7. Press the left arrow button to confirm your selection and return to the menu.

You may press the FETCH button on the remote control and execute the assigned function at any time while viewing DIRECTV® programming.

## Options

# THE MENU SYSTEM

## SYSTEM OPTIONS

**System Test** The System Test screen is accessed through the Options menu and allows you to initiate diagnostic procedures on the digital satellite receiver. Use this feature to get your access card number or when your receiver doesn't seem to be working correctly. A message screen will appear to tell you whether the system passed each test.

**New Access Card** Periodically, your program provider may issue you a replacement access card. The New Access Card setup display screen allows you to transfer information from the old card onto the new one.

Follow the on-screen instructions to initialize your new card. Once you have transferred the information to the new card, your old card becomes invalid. The access card fits into the digital satellite receiver through the front panel. Because your specific account information is stored in the access card, power failures should have no effect on your DIRECTV System.

**Set VCR Type** To use the One-Touch Record and Timer recording features, you need to tell the digital satellite receiver which VCR brand you are using, and have your VCR Controller connected (see the "Setup and Connections" section for details on connecting your VCR Controller).

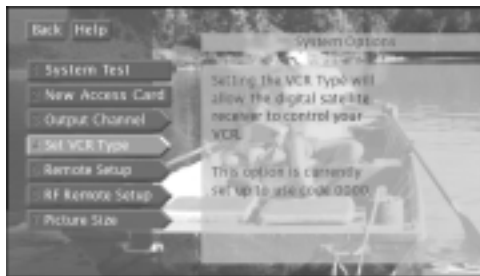

*Set VCR Type is one of the choices in the System Options menu.*

1. Use the up and down arrow and OK button to select the name of your VCR manufacturer and enter the correct code for your VCR brand.
  2. Follow the on-screen instructions to ensure that you are using the correct code.
- Some VCR brands may not be capable of being controlled by the digital satellite receiver.

## Options

If your system fails a test, run the system test several times before concluding that there is a problem. Occasional fluctuations in the phone line or satellite signal can give temporary false readings.

If you do not see your VCR manufacturer's name, select *Other* (at the bottom of the list) and enter the appropriate code from the "Using the Remote" section.

# THE MENU SYSTEM

**Output Channel** Lets you choose on which channel to view satellite programming, either channel 3 or channel 4.

**Remote Setup** Lets you choose which remote control button will be used to control the current satellite receiver.

**RF Remote Setup** Selects the code that will be used to identify your RF remote control. You can change this code (to any number between 0 and 255) if it conflicts with the code of another RF remote.

**Picture Size** Lets you choose between a standard TV screen and a Cinema option. A standard TV screen has an aspect ratio of 4:3; the Cinema option has an aspect ratio of 16:9.

## Options

## AUDIO LANGUAGE

When you select *Audio Language* from the Options menu, the highlight is moved to the Audio Language display screen.

Point to the audio language or audio type you want and press OK. The digital satellite receiver will then automatically set the audio program to the selected audio program type or language, when available.



*Audio Language allows you to choose the language in which you'd like to hear programming, when available.*

To change the audio language:

- Select *Audio Language* on the *Options* menu and highlight the desired language. Then press OK.

# THE MENU SYSTEM

## DOLBY DIGITAL\*

Dolby Digital (when available) provides six independent soundtrack channels through the optical output jack. This receiver has an SPDIF [IEC-958] digital PCM or Dolby Digital encoded output that can be connected to an external Digital Audio Receiver/Decoder equipped with a compatible optical input (see the "Setup and Connections" section for more information). With additional equipment you can enjoy more dynamic and realistic sound.

### Requirements

- Digital Audio Receiver/Decoder with digital optical input jack
- Programming with digital soundtrack
- Optical (SPDIF) cable
- Six speakers: left front, left rear (surround), right front, right rear (surround), center and sub-woofer

### Connections

The diagram at right illustrates the equipment connections and home theatre speaker arrangements. Check your equipment's user manuals for more detailed connection information. (Note: older digital equipment may not be compatible with the Dolby Digital bitstream and could cause damage to ears, headphones, or speakers. Please read the note at right for more information.)

### Menu Options

When you select *Dolby Digital* from the Options menu, select:

- Yes to send a Dolby Digital audio signal (when available) through the Digital Audio Output jack on the back of the digital satellite receiver to an optional, compatible six-channel amplifier receiver.

Depending on your audio equipment, you can then choose *Dolby Digital* output, *PCM* (pulse mode modulation), or *Autoselect*. *Autoselect* is recommended for most situations.

- No to send a digital audio stream in PCM format.

\*Dolby Digital is only available on model DRD480RE.

## Options

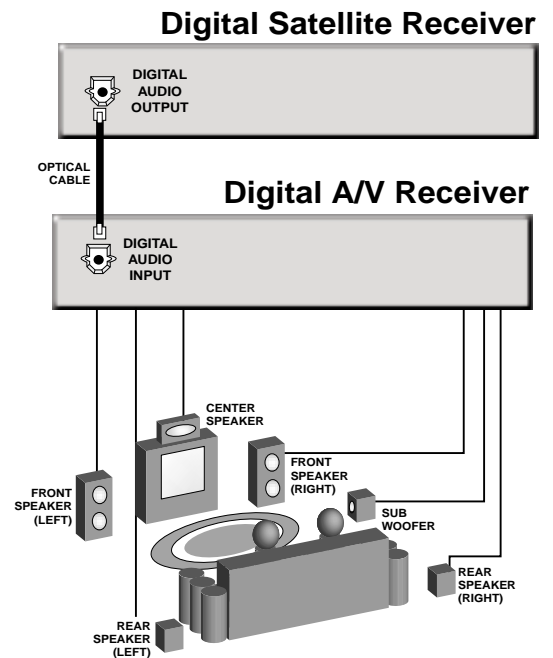

### Please Read Before Using the DIGITAL AUDIO OUT Jack

This digital satellite receiver's optical digital output jack fully complies with the international standard governing this type of jack (IEC958), and is designed for connection to a Dolby Digital (AC-3 or PCM) receiver or Dolby Digital (AC-3 or PCM) decoder. Older equipment, some of which is not fully compliant with IEC958, may not be compatible with the Dolby Digital bitstream. Such a connection using anything other than a PCM, Dolby Digital, or Dolby Pro Logic receiver or decoder could create a high noise level, causing damage to headphones or speakers.



# THE MENU SYSTEM

## ALTERNATE DATA

Selects from among the available data channels.

## UPGRADES

Your digital satellite receiver is able to receive upgrades or modifications to some of its features and functions. These modifications will occur automatically, usually at times when your receiver would likely be turned off. If your receiver is on when an upgrade or modification is sent, you may experience a disruption in reception for a minute or two. Your reception should return to normal after the modification is complete. Please consult the Upgrades Menu to find a schedule of upgrades or modifications planned by DIRECTV. The Upgrades feature is enhanced by \*RSA™ Secure.

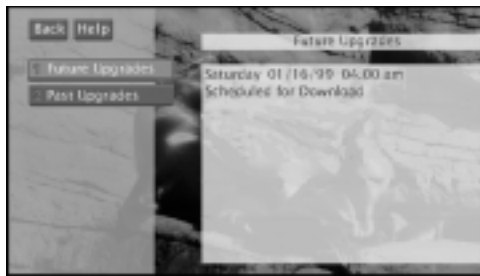

*Future Upgrades lets you review upcoming upgrades. Past Upgrades shows you the current software version number.*



*The "RSA Secure" logo ensures that only authorized upgrades or modifications are delivered to your digital satellite receiver.*

\*RSA™ Secure and the RSA™ Secure logo are trademarks of RSA Data Security, Inc.

# THE MENU SYSTEM

## DISH POINTING

The Dish Pointing menu helps you set up your digital satellite receiver and optimize your reception of the satellite signal.

### SELECTING DISH TYPE

It is important to complete each of the following steps required for your satellite dish antenna. If you do not, you will not receive proper dish pointing coordinates and will not be able to take full advantage of your DIRECTV PLUS™ System.

Specify the type of dish you are using:

1. Press MENU on the remote control to bring up the Main menu.
2. Use the arrow buttons on the remote control to highlight *Dish Pointing*, then press OK to access the dish pointing screen.
3. Use the arrows to highlight *Select Dish*, then press OK.
4. Specify the type of dish you are using: a round satellite dish or an oval satellite dish.

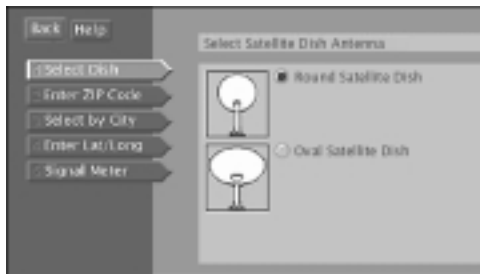

Depending on the type of dish you have, the *Select Dish* menu will prompt you for more information about your satellite dish antenna.

5. If you are using a round satellite dish, you are finished selecting your dish. Proceed to “Find Your Dish Pointing Coordinates,” next in this book, for further dish pointing instruction.

If you are using an oval satellite dish, you need to complete the next steps. Select the *Next* button to continue.

6. Specify the number of satellite locations from which your satellite dish antenna will be receiving signals. This number is equal to the number of LNBS (Low Noise Block) mounted on your dish. For example, if you have two LNBS, select *2 Satellite Location Dish*.
7. Select *Done* and proceed to “Find Your Dish Pointing Coordinates,” next in this book.

## 7 Dish Pointing

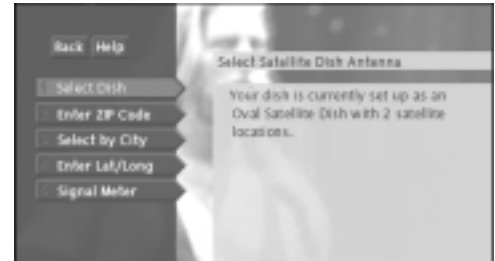

*Dish Pointing* shows you your the current settings for your satellite dish antenna.

**It is important to select the correct dish type. If you do not, you will not receive the proper dish pointing coordinates and you will not be able to take full advantage of your DIRECTV System.**

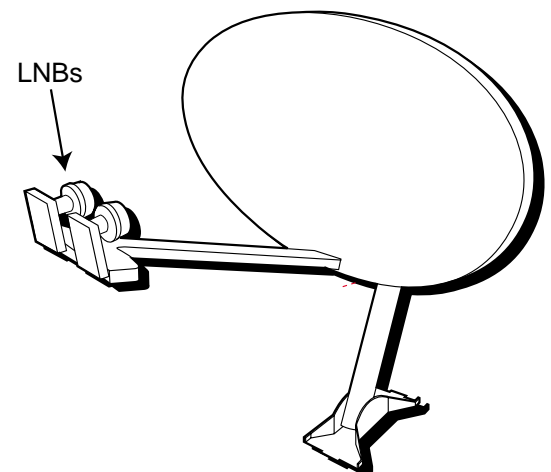

An oval satellite dish with two LNBS (not provided with all systems).

# THE MENU SYSTEM

## FIND YOUR DISH POINTING COORDINATES

If you already know your dish pointing coordinates and have placed your dish, you can proceed to the next step in this book, "Using the On-screen Signal Meter." If not, you only need to use one of the available methods (ZIP Code, City, Latitude/Longitude) to find your dish pointing coordinates.

Follow these steps to obtain your dish pointing coordinates using the ZIP Code of the dish installation location:

1. Press MENU on the remote control to bring up the Main menu.
2. Use the arrows to highlight *Dish Pointing*, then press OK to access the dish pointing screen.
3. Use the arrows on the remote control or the front panel to highlight *Enter ZIP Code*, then press OK.
4. Enter the ZIP Code for the satellite dish antenna installation location.

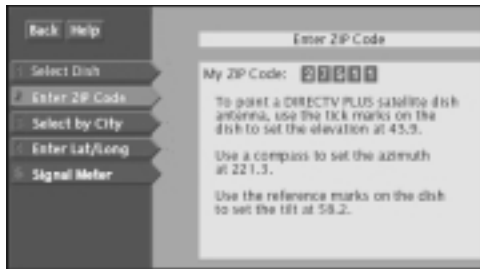

5. Record the elevation, azimuth, and tilt (oval satellite dish only) numbers below.

Elevation \_\_\_\_\_ Azimuth \_\_\_\_\_

Tilt (oval satellite dish only) \_\_\_\_\_

## 7 Dish Pointing

**Azimuth is the side- to-side direction that the satellite dish antenna is pointed.**

**Elevation is the up/down angle that the satellite dish antenna is pointed.**

**Tilt is the circular rotation of the dish itself, like the motion of a steering wheel.**

# THE MENU SYSTEM

## USING THE ON-SCREEN SIGNAL METER

The signal strength meter is used to determine whether or not you are receiving the satellite signal; it also indicates the strength of the satellite signal.

Follow these steps to bring up the on-screen signal meter:

1. Press MENU on the remote control to bring up the Main menu.
2. Use the arrow buttons on the remote control to highlight *Dish Pointing*, then press OK to access the dish pointing screen.
3. Use the arrows to highlight *Signal Meter*, then press OK.

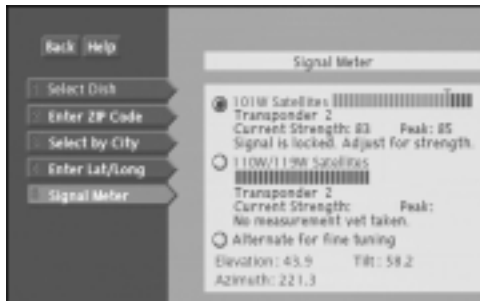

*The signal meter screen you see may look somewhat different from the one pictured above.*

4. Select a satellite location (such as 101W). If the satellite dish antenna is pointed correctly, the signal meter will show you the current signal strength and you should hear a continuous tone.
5. If you are using an oval satellite dish, select the second satellite group and obtain a signal.

Once you have a signal locked for both satellite locations (this may require some tweaking), you can select *Alternate for fine tuning* to improve your reception of both signals. When this button is selected, the signal meter alternates between the two signals every four seconds. Make small adjustments to your dish's position until both signals are satisfactory.

Please see your satellite dish antenna Installer's Guide for detailed instructions.

## 7 Dish Pointing

### Note

The "Peak Signal" indicates the highest signal strength you have obtained, which is not necessarily the highest possible signal (100). Although there is no difference in picture quality between signal strengths of 60 and 85, the higher the signal, the less likely you are to experience negative effects ("rain fade") in degraded conditions such as rain or snow.

### Important

Changing transponders is not the same as fine-tuning the dish. Although the signal strength may change when you change types of signals, this may be due to different types of signals. To fine-tune the dish, consult the Installation Guide and follow the instructions on adjusting the dish elevation, azimuth, and tilt.

# TIPS & TROUBLESHOOTING

## TIPS FOR SOLVING PROBLEMS

You may have some questions about using your DIRECTV PLUS™ System that you are unsure how to answer. This section provides the answers to such questions. You will find out how to access your video input channel, run a system test, and diagnose and correct problems.

**1** SETUP AND CONNECTIONS



**2** USING THE REMOTE



**3** PROGRAM GUIDES



**4** THE MENU SYSTEM



**5** TIPS & TROUBLESHOOTING

# TIPS & TROUBLESHOOTING

## TROUBLESHOOTING

### Wrong picture

The digital satellite receiver and most VCRs let you toggle between signals. If you don't see the signal you think you should be seeing, try using these buttons to toggle between the signals:

- Press the TV/VCR button on the VCR remote or on the VCR's front panel.
- Press the ANTENNA button on the remote control.

Taking either of the above actions lets you switch the source of the video signal from satellite signals to the off-air antenna or cable signal, and vice versa.

- You may not have installed your satellite dish antenna properly.

Refer to the dish pointing instructions in the Menu section of this book and the installation guide that came with your satellite dish antenna.

### Problems with the remote control

- Maybe something is between the remote control and the remote sensor.
- Maybe the remote control is not in DIRECTV mode. Press the DIRECTV (or, if your remote is older, SAT1) button so the remote will control the digital satellite receiver.
- Remember to press the OK button after entering a DIRECTV channel number that is less than four digits long.
- Maybe batteries in the remote control are weak, dead or installed incorrectly. Try replacing batteries. (Note that when you replace the batteries you may have to reprogram your remote to control other devices.)
- Remove batteries; press and hold the 1 button for at least 60 seconds to drain the microprocessor inside the remote control. Release number 1, replace the batteries, and (if necessary) reprogram the remote.

### Problems with Caller ID

- You cannot connect your receiver to a wireless phone jack and use the Caller ID feature. Instead, connect it directly into a phone jack.

### Blank screen

- Maybe the component connected to the input jacks is not turned on.
- Try another channel.

### Receiver will not turn on

- Check to make sure it is plugged in.
- Check the wall receptacle (or extension cord) to make sure it is "live" by plugging in something else.
- Maybe batteries in remote control are "dead."
- Maybe remote control is not aimed at remote sensor.
- Unplug the receiver. Wait five minutes. Plug it in again.

# TIPS & TROUBLESHOOTING

## Light flashes on front panel

- You have unread Caller ID messages or mail. Select *Messages* from the Main menu and go into either the Mail or Caller ID menu. If you select Caller ID, then select Caller ID List. Once you access your mail or messages, the flashing will stop.

## Turns off while playing

- Electronic protection circuit may have been activated because of a power surge. Wait 30 seconds and then turn on again. If this happens frequently, the voltage in your house may be abnormally high or low.

## TV and digital satellite receiver turn on or change channels unexpectedly

- Scheduled Watch from the Timers menu may have been activated.

## VCR turns on or off unexpectedly

- A timer may be set to record. The timer will automatically turn the VCR on and off.

## FINDING THE VIDEO INPUT CHANNEL ON YOUR TV

Note: If your TV is connected with just coaxial cables, you only need to tune to channel 3 or 4.

If you used audio/video cables to connect your TV to the digital satellite receiver, you must tune your TV to the video input channel to view DIRECTV® programming and menus. There are just as many ways to access a TV's video input channel as there are brands and models of TVs. Below are some things you can try.

- If your TV brand is RCA, GE, or PROSCAN, press TV on the remote control that came with your DIRECTV Plus™ System. Then press the WHO•INPUT button on the remote.
- If your TV brand is not RCA, GE, or PROSCAN, consult your TV Owner's Manual.

If you cannot find your TV Owner's Manual, you will have to investigate. You might access the TV's video input channel by:

- pressing a button on the remote control
- finding it through the TV's menu system
- tuning directly to it by pressing a specific channel number
- going through all channels in the list by pressing the channel up or down buttons on the TV.

The box below lists of some of the different ways manufacturers label the video input channel.

### Video Input Channel Variations

Button/switch on the TV	Button on the TV Remote	Channel #
VIDEO	VID 1	00
SIGNAL	LINE	90
VID 1	VID	91
VID 2	VIDEO	92
S-VID	S-VID	VID 1
S-VIDEO	INPUT	VID 2
	SOURCE	
	AUX	

# TIPS & TROUBLESHOOTING

## RUNNING THE SYSTEM TEST

The System Test allows you to run a basic diagnostics check on your DIRECTV PLUS™ System. If you are experiencing any trouble with your system, run the system test. It will also allow you to get your access card number or to initiate diagnostic procedures on your DIRECTV PLUS™ System.

First make sure that:

- all connections—jacks, cables, etc.—are correctly in place. See the “Setup and Connections” section for more information.
- there are batteries in the remote control, and they are working correctly.
- the access card is installed in the digital satellite receiver.

Follow these steps to run the diagnostics system test on your DIRECTV PLUS™ System.

1. Turn on your TV and the digital satellite receiver.
2. Press the DIRECTV button to put the remote control in DIRECTV mode, then press MENU to bring up the Main menu.
3. Point to and select *Options*.
4. Point to and select *System Options*.
5. Point to and select *System Test*.
6. If your system does not pass the system test, check any of these potential trouble areas: cabling, pointing the satellite dish, phone connection, and access card.
7. If you continue to have problems, call 1-800-679-4776.

You should run a system test several times before concluding that there is a problem. Occasional fluctuations in the phone line or satellite signal can give temporary false readings.

## FINE-TUNING THE SIGNAL

If you self-installed your satellite dish antenna, you may have already used the interactive setup to find the dish pointing coordinates, acquire and fine-tune the signal, and run a system test.

If you need to run the interactive setup again, select *Options* from the Main menu, then select *Interactive Setup*.

If you just want to check your dish pointing coordinates, or run the signal strength meter, select *Dish Pointing* from the Main menu.



# APPENDIX A: WARRANTY INFORMATION

## Repair Help

Thomson Consumer Electronics offers hardware repair service if you encounter any problems with your DIRECTV PLUS™ System. Many problems can be diagnosed over the phone, or if necessary a replacement unit can be shipped to you. **Please have your DIRECTV PLUS™ System model, serial number and date of purchase ready when you call.** If your unit is out of warranty, we will quote the cost of an exchange unit to you. Refer to the Warranty for the repair service phone number.

## Returning Equipment to Thomson for Repair or Exchange

If we are unable to resolve your problem over the phone we will gladly service your unit or exchange it for a new or refurbished unit. Refer to the limited warranty in this booklet to learn about your specific rights and responsibilities. *Always consult Thomson and get a Return Authorization number before returning anything.* Obtain a Return Authorization (RA) number from the telephone representative before returning your equipment to avoid delays, accounting errors, or even loss of your unit.

## Important Information to Customers Who Ship Defective Equipment to Thomson Consumer Electronics

The Thomson representative who authorizes the return of your equipment will give you an RA number over the phone. The representative will also provide you with instructions on where and how to return your unit. Write the number in large, clear characters on the outside of the box. *To avoid confusion and misunderstandings, shipments without an RA number clearly visible on the outside of the box will be returned to you at your expense.* Include a brief note describing the problem and any conversations you have had with Thomson personnel about the problem. Include your name, address and model/serial number of your unit. These numbers are located on the back of your receiver. If your DIRECTV PLUS™ System is within the warranty period, please provide a copy of the bill of sale to verify purchase date. Use the original box and packing material to protect the equipment from damage in shipment. ***For your protection, insure all shipments for full replacement value and use a reliable shipper.*** Thomson assumes no responsibility for warranty shipments from the customer to the factory if not shipped in the manner prescribed by Thomson.

# APPENDIX A: WARRANTY INFORMATION

## RCA SATELLITE SYSTEM LIMITED WARRANTY

### What your warranty covers:

- Any defect in materials or workmanship.

### For how long after your purchase:

- 90 days - Unit exchange, which includes parts and labor.
- 91 days to 1 year - Unit exchange, which includes parts only; you pay the labor.
- The warranty for rental units begins with the first rental or 45 days from date of shipment to the rental firm, whichever comes first.

### What we will do:

- **During the initial 90 days:**  
Exchange the defective portion of your satellite receiver with a new or, at our option, refurbished unit.
- **After the 90 days and within one year:**  
Exchange the defective portion of your satellite receiver with a new or, at our option, refurbished unit. We will charge you a flat exchange cost to replace a defective receiver. This charge covers the labor cost for its repair.

### How you get service:

- Call 1-800-679-4776 and have your unit's date of purchase and model/serial number ready. The model/serial number information is on the back of your receiver.
- A representative will troubleshoot your problem over the phone.
- If the representative determines that you should receive a replacement receiver you will be provided with a Return Authorization (RA) number and the location of a nearby exchange point if one exists. No returns will be accepted without the RA number.
- If the representative determines that your antenna/dish is defective he or she will arrange for its repair or replacement.

#### Option 1

1. Provide your Discover, MasterCard or Visa account number and expiration date to your phone representative. This is for security purposes only and your account will not be charged at this time.
2. We will send you a replacement unit.
3. If you return the unit to us within 14 days from the date you were provided a RA number, only items not covered by warranty will be charged to your account. If your unit is not received within 14 days, the suggested retail value of the receiver will be charged to your credit card. This amount will be credited, less a \$10 handling fee, if the unit is subsequently received.
4. Ship your defective unit back to us using the replacement unit's carton. Shipping instructions will be included on the carton along with your RA number which will allow you to easily ship the unit back to us. Make sure you insure your shipment in case of damage or loss. Include with the shipment:
  - Evidence of purchase date such as a bill of sale.
  - A brief note describing your receiver problem.
  - Your name, address and phone number.

#### Option 2

1. We will send a replacement unit to our exchange point.
2. The exchange location will notify you of its arrival.
3. Take your unit and evidence of purchase date, such as a bill of sale, to the exchange location and you will be provided the new or refurbished unit. Please retain all accessories such as the remote control hand unit.
4. If the repairs are covered by your warranty, you will not be billed.

Thomson assumes no responsibility of warranty shipments from the customer to the factory if not shipped in the manner prescribed by Thomson.

# APPENDIX A: WARRANTY INFORMATION

## To receive a replacement receiver after we have received your unit:

- Write the RA number on the outside of the carton used to return the unit. Make sure you insure your shipment in case of damage or loss.
- Carefully pack the unit using the original box and packing material if possible. Please retain all accessories that were included with your unit such as the remote control hand unit.
- Include with the shipment:
  1. Evidence of purchase date such as a bill of sale.
  2. A brief note describing your receiver problem.
  3. Your name, address and phone number.
- The representative will advise the address to mail a cashier's check or money order for payment if there are any out of warranty labor or parts charges, and you elect not to use your credit card.
- After we receive your product, a new or refurbished unit will be shipped to you.

## What your warranty *does not* cover:

- Acts of God, such as but not limited to lightning damage.
- Adjustment of customer controls.
- Damage from misuse or neglect.
- A unit that has been modified or incorporated into other products or is used for institutional or other commercial purposes.
- Batteries.
- Units purchased, serviced or operated outside the U.S.A. and Alaska.
- For units intended for use in Alaska, this warranty does not cover installation or the dish antenna. It only covers the satellite receiver.
- Loss of programming.
- Installation.
- Shipping damage if the unit was not packed and shipped in the manner prescribed by Thomson.
- Storage fees may be charged by the exchange point if you fail to pickup the replacement unit in a timely manner.

## Product Registration:

- Please complete and mail the Product Registration Card packed with your product. It will make it easier to contact you should it ever be necessary. The return of the card is not required for warranty coverage.

## How state law relates to warranty:

- This warranty gives you specific legal rights and you may have other rights that vary from state to state.

## If you purchased your product outside the United States:

- This warranty does not apply. See your dealer for warranty information.

# APPENDIX B: FCC REGULATIONS

## FCC Registration Information

Your digital satellite receiver is registered with the Federal Communications Commission and is in compliance with parts 15B and 68, FCC Rules and Regulations.

### 1. Notification to the Local Telephone Company.

On the back of this equipment is a label indicating among other information, the FCC Registration number and Ringer Equivalence Number (REN) for the equipment. You must, upon request, provide this information to your telephone company.

The REN is useful to determine the number of devices you may connect to your telephone line and still have all these devices ring when your telephone number is called. In most (but not all) areas, the sum of the RENs of all devices connected to one line should not exceed 5. To be certain of the number of devices you may connect to your line as determined by the REN, you should contact your local telephone company.

Note: This equipment may not be used on coin service provided by the telephone company. Party lines are subject to state tariffs, and therefore you may not be able to use your own telephone equipment if you are on a party line. Check with your local telephone company. Notice must be given to the telephone company upon permanent disconnection of your equipment from your line.

### 2. Rights of the Telephone Company.

Should your equipment cause trouble on your line which may harm the telephone network, the telephone company shall, where practicable, notify you that temporary discontinuance of service may be required. Where prior notice is not practicable and the circumstances warrant such action, the telephone company may temporarily discontinue service immediately. In case of such temporary discontinuance, the telephone company must: (1) promptly notify you of such temporary discontinuance (2) afford you the opportunity to correct the situation and (3) inform you of your right to bring a complaint to the Commission pursuant to procedures set forth in Subpart E of Part 68, FCC Rules and Regulations.

The telephone company may make changes in its communications facilities, equipment, operations of procedures where such action is required in the operation of its business and not inconsistent with FCC Rules and Regulations. If these changes are expected to affect the use or performance of your telephone equipment, the telephone company must give you adequate notice, in writing, to allow you to maintain uninterrupted service.

## Radio Interference

This equipment has been type tested and found to comply with the limits for a Class B Digital Device in accordance with the specifications in Part 15 of FCC Rules. These rules are designed to provide reasonable protection against radio and television interference in a residential installation. This equipment generates, uses and can radiate radio frequency energy and, if not installed and used in accordance with the instructions, may cause harmful interference to radio communications. However, there is no guarantee that interference will not occur in a particular installation. If this equipment does cause interference to radio or television reception (which you can determine by turning the equipment off and on), try to correct the interference by one or more of the following measures.

- Reorient or relocate the receiving antenna (that is, the antenna for radio or television that is "receiving" the interference).
- Change the position of the satellite receiver with respect to the radio or television equipment that is receiving interference.
- Move the satellite receiver away from equipment receiving interference.
- Plug the satellite receiver into a different wall outlet so the receiver and equipment receiving interference are on different branch circuits.

If these measures do not eliminate interference, please consult your dealer or an experienced radio/television technician for additional suggestions. Also, the Federal Communications Commission has prepared a helpful booklet, "How To Identify and Resolve Radio/TV Interference Problems". This booklet is available from the U.S. Government Printing Office, Washington, D.C. 20402. Please specify stock number 004-000-00345-4 when ordering copies.

# APPENDIX C: ACCESSORIES

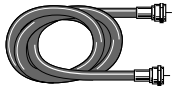

RG-6 Coaxial Burial Cable with weatherproof "F" connectors comes in a variety of lengths.

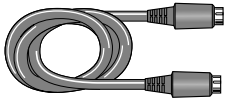

S-Video Cable comes in 12 foot lengths.

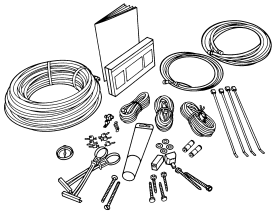

Self-Installer's Kit contains all the cable and hardware needed to install the dish and connect the system.



Remote Control replaces a lost remote. Or, order a second remote for convenience.

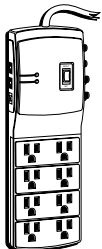

Eight outlet surge protection for cable TV, satellite systems and other electronics. Comes with a \$50,000 equipment guarantee.



Remote Controlled Rotating Outdoor/Indoor Amplified Dish Antenna features 20dB VHF and UHF signal amplification.

## Accessory Order Form

Description	Part No.	Price	Qty	Total
RG-6 Coaxial Cable				
12 feet	D912	\$12.95		
25 feet	D925	\$15.95		
50 feet	D950	\$21.95		
75 feet	D975	\$24.95		
S-Video Cable 12 feet	D913	\$11.95		
Weatherproof "F" Connector (2)	D905	\$5.95		
Optical/SPDIF Cable (3-ft)	DV3	\$15.95		
Optical/SPDIF Cable (6-ft)	DV6	\$19.95		
TVRO Bullet Amplifier	D903	\$22.95		
Self-Installer's Kit	DKIT96	\$69.95		
Remote Control CRK76SG1	240968	\$34.50		
Surge Protector	SCTV160	\$49.95		
Rotating Amplified Dish Antenna	ANT2500X	\$259.95		

Total Merchandise .....	\$ _____
Sales Tax .....	\$ _____
We are required by law to collect the appropriate sales tax for each individual state, country, and locality to which the merchandise is being sent.	
Shipping, Handling, and Insurance .....	\$ 5.00
Total Amount Enclosed .....	\$ _____
Use VISA, MasterCard, or Discover preferably. Money order or check must be in U.S. currency only. No COD or CASH.	



Detach Here

All accessories are subject to availability.  
Prices are subject to change without notice.

Please complete other side also



# APPENDIX C: ACCESSORIES

Charge your order on your VISA, MasterCard, or Discover Card by filling in below

**USE YOUR CREDIT CARD**

**IMPORTANT:** Copy complete account number from your VISA card



My card expires:

**IMPORTANT:** Copy complete account number from your MasterCard



Copy Number above your name on MasterCard:     My card expires:

**IMPORTANT:** Copy complete account number from your Discover Card



My card expires:

---

**AUTHORIZED SIGNATURE**  
(Credit card order will not be processed without signature)

Print or type your name and address clearly.



A complete and correct order will save you days of waiting.

Name: \_\_\_\_\_

Street: \_\_\_\_\_

\_\_\_\_\_ Apt: \_\_\_\_\_

City: \_\_\_\_\_

State: \_\_\_\_\_ Zip: \_\_\_\_\_

Daytime Phone Number: \_\_\_\_\_

Please make sure that both sides of this form have been filled out completely.

- Allow 4 weeks for delivery.
- All accessories are subject to availability.
- Prices are subject to change.

## Placing an Order

To place your order by phone, have your Visa, MasterCard or Discover Card ready and call the toll-free number listed below. Use this number only to place on order for accessory items listed on this order form.

**1-800-338-0376**

To place your order by mail, detach and mail the completed order form with credit card information, money order or check in US currency (made payable to Thomson Consumer Electronics, Inc.) to the following address:

**Video Accessories**  
**PO Box 8419**  
**Ronks, PA 17573**

# INDEX

- A**
- Access card 60
    - number 16
  - Accessories 75
  - All button 34
  - AlphaSort button 27, 34
  - Alternate data 63
  - ANTENNA button 19
  - Arrows on remote 19
  - Attractions Guide 31, 48
  - Audio language 61
  - AUX button 18
  - Azimuth 65
- B**
- Batteries 14
  - Binoculars Icon 27, 35
  - Buttons 18
- C**
- Caller ID 42
    - banner 43
    - list 44
    - receiving calls 43
  - Cancelling purchases 45
  - Channel banner 27
  - Channel Guide 30
  - Channel lists 51
    - add channels 52
    - delete channels 52
  - CLEAR button 19
  - Codes
    - remote control 23
  - Connections 6
    - jacks and cables 5
    - VCR Controller 14
- D**
- Default guide 28
  - Deleting calls 44
  - Deleting purchases 45
  - Detail Guide 28
  - DIRECTV button 18, 21, 38
  - Dish Pointing 64
    - coordinates 65
  - Dolby Digital 7, 13
  - DVD button 18
- E**
- Elevation 65
  - Exiting
    - menus 38, 44
    - program guides 30
- F**
- Fetch 58
  - FETCH button 18
  - Front panel light 42
- G**
- GO BACK button 18
  - Grid Guide 28
  - GUIDE button 18, 28
  - Guides. See Program guides
- I**
- Icons
    - 26, 27, 33, 34, 35, 47, 48, 49
  - INFO button 18
  - Interactive setup 16, 57, 70
- L**
- LED light 18. See also Front panel light
  - Lock Icons 27, 55
  - Locking
    - a profile 54
    - the system 27, 52, 54
  - Logo Guide 30
  - Look and feel 58
- M**
- Mail
    - checking 41
    - deleting 41
    - icon 27
  - Main menu 37
  - MENU button 19
  - Menu system 38
    - icons 49
  - Menus 39
    - Messages 41
    - Options 57
    - Profiles 51
    - Program Guide 40
    - Timers 49
  - Messages 41
    - Caller ID 44
  - Movies icon 33
  - MUTE button 18
- O**
- Options menu 39, 57
  - Other Guides
    - Attractions Guide 48
    - icon 30
- P**
- Passwords 54
  - Problems, solving 68
  - Profiles
    - channel lists 51
    - choosing 56
    - locking 54
    - menu 39, 51
    - rating limit 52
    - spending limits 53
    - unlocking 56
    - viewing hours 53
  - Program guides 25
    - anatomy 26, 40
    - Attractions Guide 31
    - Channel Guide 30
    - default 28
    - Detail Guide 28
    - exiting 30
    - Grid Guide 28
    - icons 30
    - Logo Guide 30
    - scrolling 28, 36
    - sorting 31, 32
    - tuning to a program 29
  - Programming
    - remote control 23
  - Purchases
    - cancelling 45
    - menu 39, 45
    - previewing 47
    - reviewing 45
    - spending limits 46
- R**
- Rating limit 52
  - RECORD button 21, 50
  - Recording 11
    - with timers 50
  - Remote control
    - buttons 18
    - codes 23
    - modes 21
    - programming 20
    - RF 12, 22, 61
    - setup 61
  - Repairs 71
  - Reviewing purchases 45
  - RF remote jack 12
- S**
- Scout 27, 35
  - Scrolling 28, 36
  - Set VCR type 15, 60
  - Signal meter 66
  - SKIP button 18
  - Sorting by
    - All icon 34
    - AlphaSort icon 34
    - Movies icon 33
    - Scout icon 35
    - Sports icon 33
    - User Preferences icon 32
  - Spending limits 46, 53
  - Sports icon 33
  - System
    - lock 54
    - options 60
    - test 60, 70
    - unlock 55
- T**
- Telephone icon 27
  - Themes Icon 32
  - Tilt 65
  - Timers 49
  - Topics button 32
  - Transponders 66
  - Troubleshooting 68
  - Tuning to a program 29
  - TV button 18
- U**
- Unlocking
    - a profile 56
    - the system 27, 55
  - Upgrades 63
  - User Preferences 32, 56
- V**
- VCR
    - button on remote 18
    - Controller 5, 14, 60
    - recording 19, 21, 50, 60
    - set type 15
  - VCR codes 23
  - Video input channel 11, 69
  - Viewing call list 44
  - Viewing hours limit 53
- W**
- Warranty 72
  - WHO•INPUT button 19

If your DIRECTV System needs service, please contact your dealer or the nearest Service Center from the Yellow Pages. Please do not send any products to the Indianapolis address listed in this manual or on the carton. This will only add delays in service for your product.

 **THOMSON CONSUMER ELECTRONICS**

10330 North Meridian Street  
Indianapolis, IN 46290

©1999 Thomson Consumer Electronics, Inc.  
Trademark(s)® Registered  
Marca(s) Registrada(s)  
DIRECTV and DIRECTV PLUS are trademarks of DIRECTV, Inc., a unit of Hughes Electronics Corp., and are used with permission.  
Printed in USA  
TOCOM 15467760



100%  
RECYCLED PAPER  
MINIMUM 40% POST CONSUMER

