

**HUGHES**<sup>TM</sup>

**DIRECTV<sup>®</sup> HD Receiver  
OWNER'S MANUAL**

**MODEL: HTL-HD**



**Before connecting, operating or adjusting this product,  
please read this instruction booklet carefully and completely.**

# SAFETY WARNING



**CAUTION**  
RISK OF ELECTRIC SHOCK  
DO NOT OPEN



## CAUTION:

TO REDUCE THE RISK OF ELECTRIC SHOCK DO NOT REMOVE COVER (OR BACK).  
NO USER SERVICEABLE PARTS INSIDE.  
REFER SERVICING TO QUALIFIED SERVICE PERSONNEL.



THE LIGHTNING FLASH WITH ARROWHEAD SYMBOL, WITHIN AN EQUILATERAL TRIANGLE, IS INTENDED TO ALERT THE USER TO THE PRESENCE OF UNINSULATED "DANGEROUS VOLTAGE" WITHIN THE PRODUCT'S ENCLOSURE THAT MAY BE OF SUFFICIENT MAGNITUDE TO CONSTITUTE A RISK OF ELECTRIC SHOCK TO PERSONS.



THE EXCLAMATION POINT WITHIN AN EQUILATERAL TRIANGLE IS INTENDED TO ALERT THE USER TO THE PRESENCE OF IMPORTANT OPERATING AND MAINTENANCE (SERVICING) INSTRUCTIONS IN THE LITERATURE ACCOMPANYING THE APPLIANCE.

## WARNING

TO PREVENT FIRE OR SHOCK HAZARDS, DO NOT EXPOSE THIS PRODUCT TO RAIN OR MOISTURE.

**WARNING:** Do not install this equipment in a confined space such as a book case or similar unit.

### NOTE TO CABLE/TV/SATELLITE DISH INSTALLER:

This reminder is provided to call the cable TV system/satellite dish installer's attention to Article 820-40 of the National Electric Code (U.S.A.). The code provides guidelines for proper grounding and, in particular, specifies that the cable ground shall be connected to the grounding system of the building, as close to the point of the cable entry as practical.

### REGULATORY INFORMATION : FCC PART 15

This equipment has been tested and found to comply with the limits for a Class B digital device, pursuant to Part 15 of the FCC Rules. These limits are designed to provide reasonable protection against harmful interference when the equipment is operated in a residential installation. This equipment generates, uses and can radiate radio frequency energy and, if not installed and used in accordance with the instruction manual, may cause harmful interference to radio communications.

However, there is no guarantee that interference will not occur in a particular installation. If this equipment does cause harmful interference to radio or television reception, which can be determined by turning the equipment off and on, the user is encouraged to try to correct the interference by one or more of the following measures:

- Reorient or relocate the receiving antenna.
- Increase the separation between the equipment and receiver.
- Connect the equipment into an outlet on a circuit different from that to which the receiver is connected.
- Consult the dealer or an experienced radio/TV technician for help.

### REGULATORY INFORMATION: FCC Part 68

- This product complies with Part 68 of the FCC rules and the requirements adopted by the Administrative Council for Terminal Attachment (ACTA). On the back of this product is a label that contains, among other information, the FCC registration number and Ringer Equivalent Number (REN) for this product. If requested, this information must be provided to the telephone company.
- The REN is used to determine the number of devices that may be connected to the telephone line. Excessive RENs on the telephone line may result in the devices not ringing in response to an incoming call. Typically, the sum of the RENs should not exceed five (5). To be certain of the number of devices that may be connected to the line (as determined by the total RENs) contact the local telephone company.
- If this product causes harm to the telephone network, the telephone company will notify you in advance that temporary discontinuance of service may be required. But if advance notice isn't practical, the telephone company will notify the customer as soon as possible. Also, you will be advised of your right to file a complaint with the FCC if you believe it is necessary.
- The telephone company may make changes to its facilities, equipment, operations or procedures that could affect the proper operation of this product. If this happens, the telephone company will provide advance notice so you can make the necessary modifications to maintain uninterrupted service.
- Connection to party line service is subject to state tariffs. (Contact the state public utility commission, public service commission, or corporate commission for information.)
- If trouble is experienced with this product, for repair or warranty information, please contact Hughes Network Systems, Inc. If the product is causing harm to the telephone network, the telephone company may request that you disconnect the product until the problem is resolved.
- An FCC compliant telephone cord and modular plug is provided with this equipment. This equipment is designed to be connected to the telephone network or premises wiring using a compatible modular jack which is also compliant. See installation instructions for details.

**COMPLIANCE:** The responsible party for this product's compliance is:

Hughes Network Systems, Inc. 11717 Exploration Lane, Germantown, MD 20876 Phone: 1-800-274-8995

## CAUTION

DO NOT ATTEMPT TO MODIFY THIS PRODUCT IN ANY WAY WITHOUT WRITTEN AUTHORIZATION FROM HUGHES NETWORK SYSTEMS, INC. UNAUTHORIZED MODIFICATION OR CHANGES COULD VOID THE USER'S AUTHORITY TO OPERATE THIS PRODUCT.

THIS EQUIPMENT IS INTENDED TO RECEIVE AND DECODE SIGNALS TRANSMITTED ACCORDING TO ATSC DIGITAL TELEVISION STANDARD A/53, DIRECTV SPECIFICATION AND IS INTENDED TO BE USED WITH AN APPROPRIATE ANTENNA, DISH AND DISPLAY DEVICE THAT YOU MUST PROVIDE.

### Dolby Digital®

Manufactured under license from Dolby Laboratories. "Dolby" and the double-D symbol are trademarks of Dolby Laboratories. Confidential Unpublished Works. ©1992-1997 Dolby Laboratories, Inc. All rights reserved.

### Macrovision Information

1 This product incorporates copyright protection technology that is protected by U.S. patents and other intellectual property rights. Use of this copyright protection technology must be authorized by Macrovision, and is intended for home and other limited pay-per-view uses unless otherwise authorized by Macrovision. Reverse engineering or disassembly is prohibited.

# DECLARATION OF CONFORMITY

This device complies with Part 15 of the FCC Rules. Operation is subject to the following two conditions: (1) this device may not cause harmful interference, and (2) this device must accept any interference received, including interference that may cause undesired operation.

<b>Trade Name / Model :</b>	HUGHES/ HTL-HD
<b>Responsible Party :</b>	Hughes Network Systems, Inc.
<b>Address :</b>	11717 Exploration Lane. Germantown, MD 20876
<b>Telephone :</b>	1-800-274-8995

Equipment Classification : Part 15 TV Interface Device

Type of Product(EUT) : DIRECTV® HD Receiver

Manufacturer : Hughes Network Systems, Inc.

Address : 11717 Exploration Lane.  
Germantown, MD 20876

**We hereby declare that the equipment bearing the trade and model number specified above was tested conforming to the applicable FCC Rules under the most accurate measurement standards possible, and that all the necessary steps have been taken and are in force to assure that production units of the same equipment will continue to comply with the Commission's requirements.**

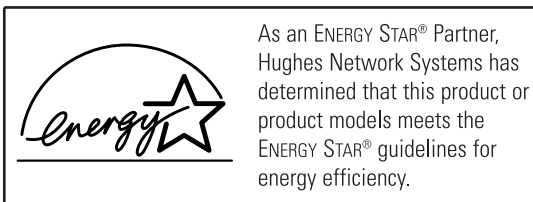

ENERGY STAR® is a U.S. registered mark.

# IMPORTANT SAFETY INSTRUCTIONS

**CAUTION: PLEASE READ AND OBSERVE ALL WARNINGS AND INSTRUCTIONS IN THIS OWNER'S MANUAL AND THOSE MARKED ON THE UNIT. RETAIN THIS BOOKLET FOR FUTURE REFERENCE.**

This set has been designed and manufactured to assure personal safety. Improper use can result in electric shock or fire hazard. The safeguards incorporated in this unit will protect you if you observe the following procedures for installation, use, and servicing.

This unit does not contain any parts that can be repaired by the user.

**DO NOT REMOVE THE CABINET COVER, OR YOU MAY BE EXPOSED TO DANGEROUS VOLTAGE. REFER SERVICING TO QUALIFIED SERVICE PERSONNEL ONLY.**

- 1. Read these instructions.** – All these safety and operating instructions should be read before the product is operated.
- 2. Keep these instructions.** – The safety, operating and use instructions should be retained for future reference.
- 3. Heed all warnings.** – All warnings on the product and in the operating instructions should be adhered to.
- 4. Follow all instructions.** – All operating and use instructions should be followed.
- 5. Do not use this apparatus near water.** – For example: near a bath tub, wash bowl, kitchen sink, laundry tub, in a wet basement; or near a swimming pool; and like.
- 6. Clean only with dry cloth.** – Unplug this product from the wall outlet before cleaning. Do not use liquid cleaners.
- 7. Do not block any ventilation openings. Install in accordance with the manufacturer's instructions.** – Slots and openings in the cabinet are provided for ventilation and to ensure reliable operation of the product and to protect it from over-heating. The openings should never be blocked by placing the product on a bed, sofa, rug or other similar surface. This product should not be placed in a built-in installation such as a bookcase or rack unless proper ventilation is provided or the manufacturer's instructions have been adhered to.
- 8. Do not install near any heat sources such as radiators, heat registers, stoves, or other apparatus (including amplifiers) that produce heat.**
- 9. Do not defeat the safety purpose of the polarized or grounding-type plug. A polarized plug has two blades with one wider than the other. A grounding type plug has two blades and a third grounding prong. The wide blade or the third prong are provided for your safety. If the provided plug does not fit into your outlet, consult an electrician for replacement of the obsolete outlet.**
- 10. Protect the power cord from being walked on or pinched particularly at plugs, convenience receptacles, and the point where they exit from the apparatus.**
- 11. Only use attachments/accessories specified by the manufacturer.**



- 12. Use only with the cart, stand, tripod, bracket, or table specified by the manufacturer, or sold with apparatus. When a cart is used, use caution when moving the cart/ apparatus combination to avoid injury from tip-over.**
- 13. Unplug this apparatus during lightning storms or when unused for long periods of time.**
- 14. Refer all servicing to qualified service personnel. Servicing is required when the apparatus has been damaged in any way, such as power- supply cord or plug is damaged, liquid has been spilled or objects have fallen into the apparatus, the apparatus has been exposed to rain or moisture, does not operate normally, or has been dropped.**

# IMPORTANT INFORMATION

Due to copyright restrictions, you may not be able to view some high-definition programs in high-definition format using this product. If HD viewing is prohibited due to copyright restrictions, you would need to connect other interfaces to view the program.

In certain markets, access to local channels requires a DIRECTV® Multi-Satellite Dish Antenna. For the most current information about the availability of local channels in your area, contact your retailer or visit [DIRECTV.com](http://DIRECTV.com). **For access to all DIRECTV High-Definition programming, a triple LNB Multi-Satellite dish antenna, along with a DIRECTV HD Receiver and High-Definition television equipment is required. Satellite dish antenna sold separately.**

Activation of programming may be subject to credit approval and requires valid service address, social security number and/or major credit card. Deposit or prepayment may be required. Programming subject to change. You must be physically located in the U.S. to subscribe to DIRECTV service. DIRECTV services not available outside the U.S. DIRECTV programming is sold separately and independently of DIRECTV System hardware. A valid programming subscription is required to operate DIRECTV System hardware. Activate your DIRECTV programming today at 1-800-DIRECTV (1-800-347-3288).

DIRECTV, Inc. DIRECTV, the Cyclone Design logo and Advanced Program Guide are trademarks of DIRECTV, Inc., a unit of Hughes Electronics Corp. and are used with permission.

# TABLE OF CONTENTS

	Safety Warning .....	1
	DECLARATION OF CONFORMITY .....	2
	IMPORTANT SAFETY INSTRUCTIONS .....	3-4
	Table of Contents .....	5-6
<b>1. Introduction</b>	1-1. A New World of Digital Entertainment .....	7
	1-2. Main Features .....	8
<b>2. Important Overview</b>	2-1. Sending Signals .....	9
	2-2. TV Signal Formats .....	10
	2-3. Display Formats .....	11
	2-4. Normal and Wide Format Signals .....	12-13
	2-5. Audio Signals .....	14-15
	2-6. On-Screen Display .....	16-17
<b>3. Setup and Connections</b>	3-1. Unpacking .....	18-19
	3-2. Back Panel of the DIRECTV® HD Receiver .....	20-21
	3-3. General Recommendations .....	22
	3-4. Connecting to Antennas .....	23-26
	3-5. TV Connection .....	27-30
	3-6. VCR Connection .....	31-32
	3-7. Audio Connection .....	33-34
<b>4. Front Panel and Remote Control</b>	4-1. Using the Front Panel of the DIRECTV® HD Receiver .....	35
	4-2. Using the Remote Control .....	36-38
	4-3. Programming the Remote Control .....	39
	4-4. Control codes .....	40-42
<b>5. Initial Setup</b> .....		43
<b>6. Basic Operation</b>	6-1. Viewing the Channel Banner .....	44-45
	6-2. Channel Surfing .....	46
	6-3. Freeze Screen .....	47
	6-4. Subscription to DIRECTV® programming and ANT/CABLE-Only operation .....	48

<b>7. Advanced Program Guide™</b>	7-1. About the Advanced Program Guide™	49
	7-2. Layout of the Advanced Program Guide™ Screen	50-51
	7-3. Moving through the Advanced Program Guide™	52-53
	7-4. Selecting a Program	54
	7-5. Getting More Program Information	55-56
	7-6. Setting a Timer/Record Event for Future Viewing	57
	7-7. Purchasing DIRECTV® Pay Per View Programs	58
	7-8. Searching for Programs by Category	59-60
	7-9. Searching for Programs by Keyword	61
<b>8. Customization</b>	8-1. Accessing the On-screen Menu	62
	8-2. The Structure of the On-Screen Menus	63
	8-3. Managing Program Purchases	64
	8-4. Checking Messages	65
	8-5. Setting a Timer/Record Event	66
	8-6. Modifying a Timer/Record Event	67
	8-7. Initializing the System	68-75
	8-8. Managing Channels	76-79
	8-9. Setting the Clock	80-81
	8-10. Setting Default Signal Out	82
	8-11. Hook-up	83
	8-12. Setting the Audio	84-88
	8-13. Choosing the Aspect Ratio	89-91
	8-14. Setting Digital Caption	92
	8-15. Setting Digital Caption Style	93
	8-16. Setting Closed Caption	94
	8-17. Advanced	95
	8-18. Running Demo	96
	8-19. Setting Locks	97-102
	8-20. Getting the System Information	103-107
	8-21. Testing the System	108-109
	8-22. Replace Card	110
	8-23. VCR Control Setup	111
	8-24. Remote Control Setup	112
<b>9. Help</b>		113-114
	Product Specifications	115
	Troubleshooting	116-119
	Warranty	Rear Cover

# 1. INTRODUCTION

## 1-1. A New World of Digital Entertainment

Welcome to the HTL-HD DIRECTV® HD Receiver, an advanced HDTV/digital satellite receiver that showcases a new generation of digital entertainment.

The DIRECTV HD Receiver delivers a variety of programs from DIRECTV and has a built-in HD Receiver that serves as a digital receiver that makes it possible to view digital programs even on your analog TV. However an analog TV will not display the HD quality.

The Advanced Program Guide™ delivered via satellite service also enables you to access and view program listings for over-the-air broadcasts and cable as well as DIRECTV® programming.

The ATSC Tuner uses Hughes' 4th generation VSB technology for improved over-the-air digital reception.

The built-in NTSC tuner with 4th digital comb filter provides optimum Video and Audio from terrestrial/cable analog programming.





## 1-2. Main Features

### Ultimate Entertainment

- **A Wide Variety of Programs**

Hundreds of channels are available by subscription from DIRECTV.

- **DIRECTV Advanced Program Guide™**

Instant access for up to seven days of program listings.

Ability to jump a day or 6 hours at a time.

Ability to search and tune by program title, key word, or category.

### Technical Flexibility

- **Seamless Tuning between Channels**

Tune seamlessly to over-the-air, cable and satellite.

- **Multiple Output Jacks**

Multiple output jacks are provided on the back panel of the DIRECTV® HD Receiver ensuring maximum connectivity to a variety of display devices.

- **Screen Format Adaptability**

Various screen formats are available including 1080i, 720p, 480p, 480i, variable 1, variable 2, variable 3, DVI, and true native modes.

- **ANT/CABLE Only Mode**

Viewing analog/digital broadcasting with an over-the-air antenna and cable service.

- **Simultaneous 480i Display Output**

Supporting simultaneous 480i Display Output for VCR-recording or viewing on an analog TV.

### Superior Performance

- **Crisp Picture**

High-definition or resolution with a 16:9 aspect ratio.

- **Superior Sound**

Sensational sound with Dolby Digital® 5.1 channels.

- **DVI-HDTV Output**

For an all-digital connection to DVI-HDTV monitors.

### Convenient Use

- **Help**

Easy-to-use on-screen menus with instant spot help and brief on-screen user's guide.

- **Hook-up**

The on-screen menus show connection schemes on the DIRECTV HD Receiver.

- **Setup Wizard**

Easy-to-use Wizard based System Setup.

- **Easy Recording to VCR**

Up to seven days of program guide information from which shows can be easily selected for automatic VCR recording.

## 2. IMPORTANT OVERVIEW

### 2-1. Sending Signals

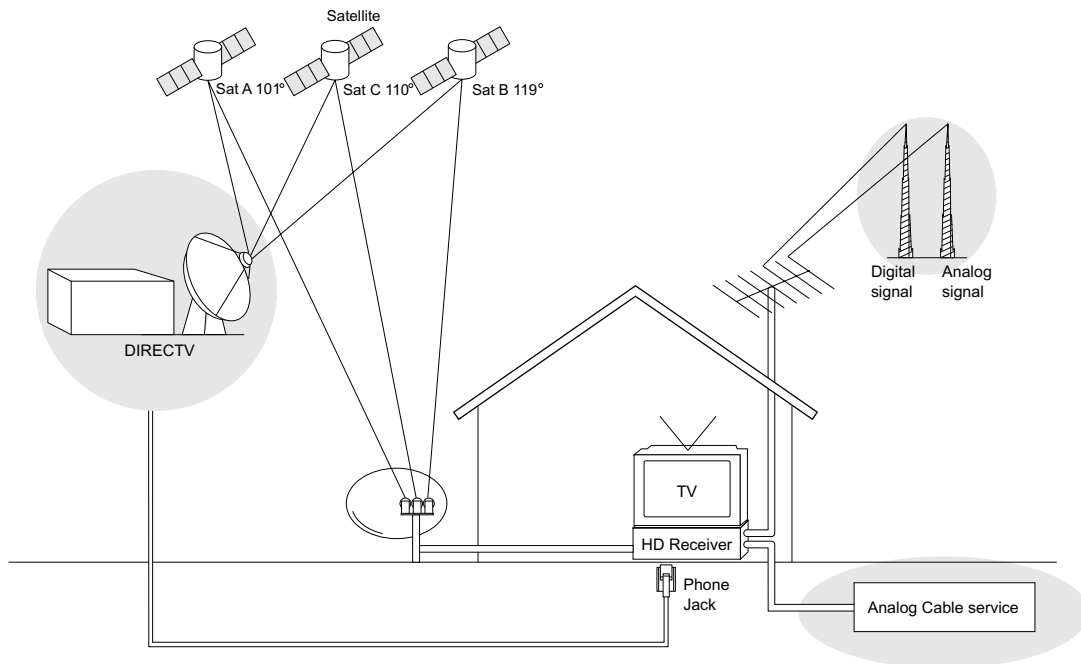

Digital broadcasting is a new way of sending programs over the airwaves with superior quality video and audio. The DIRECTV® HD Receiver enables you to take full advantage of digital broadcasting. To fully enjoy it, it is helpful to understand the ways that program signals are sent.

There are two types of TV signal formats; analog (often called NTSC format; National Television System Committee) and digital (ATSC format; Advanced Television System Committee). Digital formats are classified into three categories: High-Definition (HD), Enhanced Definition (ED), and Standard Definition (SD) according to the resolution or digital picture quality.

There are also three ways that program signals can be received; over-the-air (NTSC, ATSC), cable and satellite.

## 2-2. TV Signal Formats

**Standard Comparison Table**

Signal Format	Analog	Digital	
		SD/ED	HD
Active Lines	480	480	720 or 1080
Sound	Stereo (2 ch)	Dolby Digital® (5.1 ch) MPEG Audio (2 ch)	Dolby Digital (5.1 ch)
Aspect Ratio	4 : 3	4 : 3 or 16 : 9	16 : 9
Resolution	720 x 480	640 x 480 704 x 480	1280 x 720 1920 x 1080

The digital TV standards allow several different formats. Broadcasters can choose between four formats:

- 480p - The picture is 704 x 480 pixels, sent at 60 complete frames per second (480i is also possible, sent at 60 interlaced frames per second).
- 720p - The picture is 1280 x 720 pixels, sent at 60 complete frames per second.
- 1080i - The picture is 1920 x 1080 pixels, sent at 60 interlaced frames per second (30 complete frames per second).

(The “p” and “i” designations stand for “progressive” and “interlaced.” In a progressive format, the full picture updates every sixtieth of a second. In an interlaced format, half of the picture updates every sixtieth of a second.)

The 480i format is called SD. 480p format is called the ED format. 480i is roughly equivalent to a normal analog TV picture. The 720p and 1080i formats are called the HD formats.

Some analog televisions can display a picture 720 pixels wide by 480 pixels high, that’s a total of 345,600 pixels. HD digital signals can have a maximum resolution of 1920 x 1080, that’s 2,073,600 pixels, or six times more pixels than the older resolution. Pictures will be crisper and cleaner, with more detail in every close-up and every panorama.

## 2. IMPORTANT OVERVIEW

### 2-3. Display Formats

The DIRECTV® HD Receiver provides several display formats. Pressing the **DISPLAY FORMAT** button repeatedly on the front panel changes the display formats following order: 1080i → 720p → 480p → 480i → native → variable 1 → variable 2 → variable 3 → DVI. In **1080i, 720p, 480p, and 480i** modes, all input signal formats are converted to the chosen display format. In **native, variable 1, variable 2, and variable 3** modes, the output display format is automatically adapted depending on input signal format, as follows.

Display Format modes	Input Signal format	Output Signal format
1080i	all formats	1080i
720p	all formats	720p
480p	all formats	480p
480i	all formats	480i
native	1080i	1080i
	720p	720p
	480p	480p
	480i	480i(Component, DVI), 480p(RGB)
variable 1	1080i	1080i
	720p	720p
	480p/480i	480p
variable 2	1080i/720p	1080i
	480p/480i	480p
variable 3	1080i/720p	720p
	480p/480i	480p
DVI	all formats	changes according to monitor type

In **DVI** mode, the output display format is automatically adapted based on the preferred resolution format of the DVI-HDTV monitor. The format may be converted from the original broadcast format.

Note : The DVI mode is only available when a DVI-HDTV compatible monitor is connected to the receiver.

Note : Only one of the YPbPr, RGB or DVI-HDTV jacks is available at any one time, depending on the TYPE switch setting and DVI-HDTV connection status.

## 2-4. Normal and Wide Format Signals

When you view a high-definition picture(16:9) with 480i or 480p format setting, the **RATIO** button on the remote control changes the wide mode in the cycle of Letterbox → Cropped, → Squeezed.

When you view a standard definition picture (4:3) with 720p or 1080i format setting, the **RATIO** button on the remote control changes the wide mode in the cycle of Normal → Wide → Panorama → Zoom → CINE-Zoom. (Refer to section 8-13, ' Choosing the Aspect Ratio ' )

### WHEN YOU SET THE DISPLAY FORMAT TO SDTV (480i/480p)

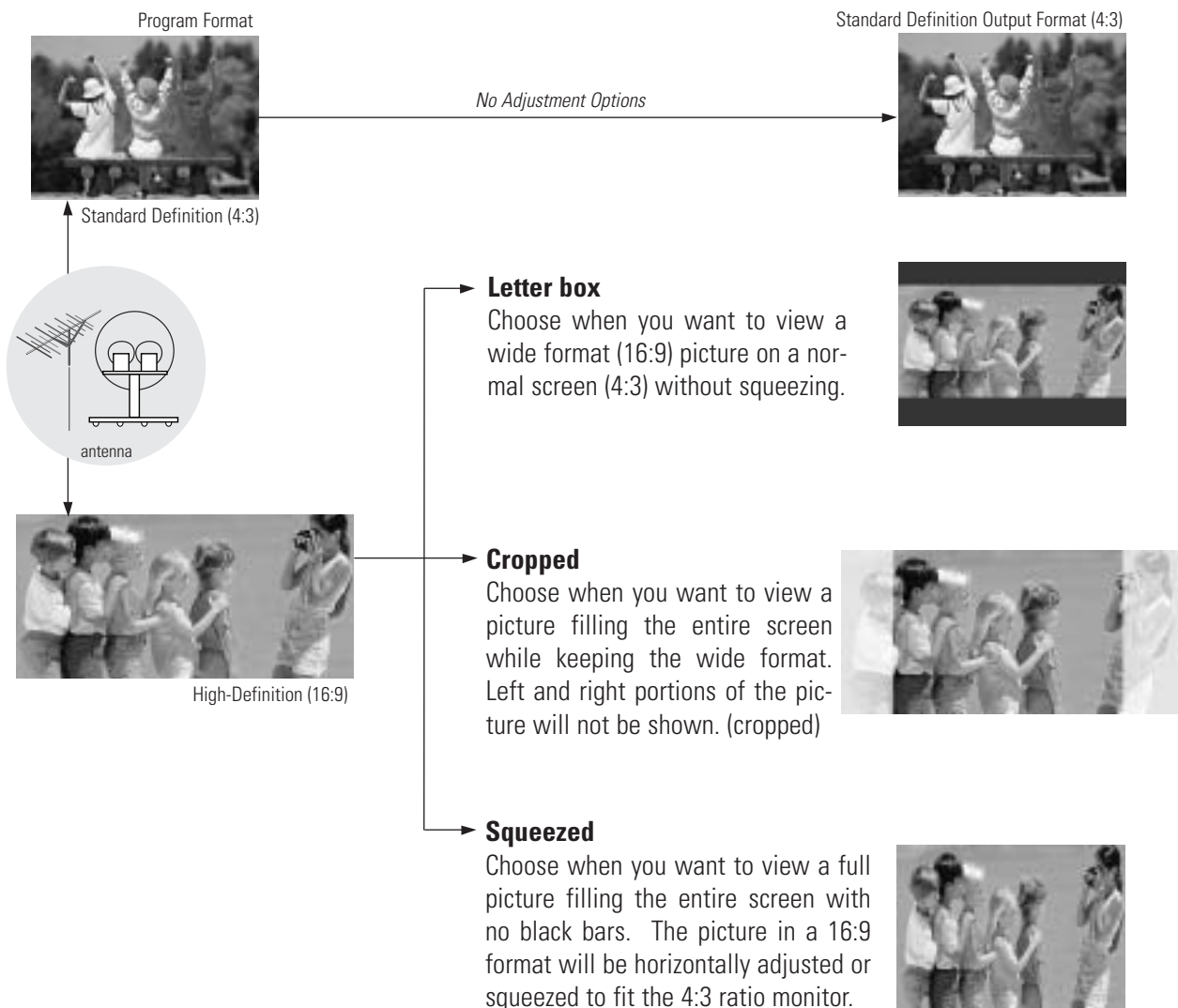

# 2. IMPORTANT OVERVIEW

## 2-4. Normal and Wide Format Signals

### WHEN YOU SET THE DISPLAY FORMAT TO HDTV (1080i/720p)

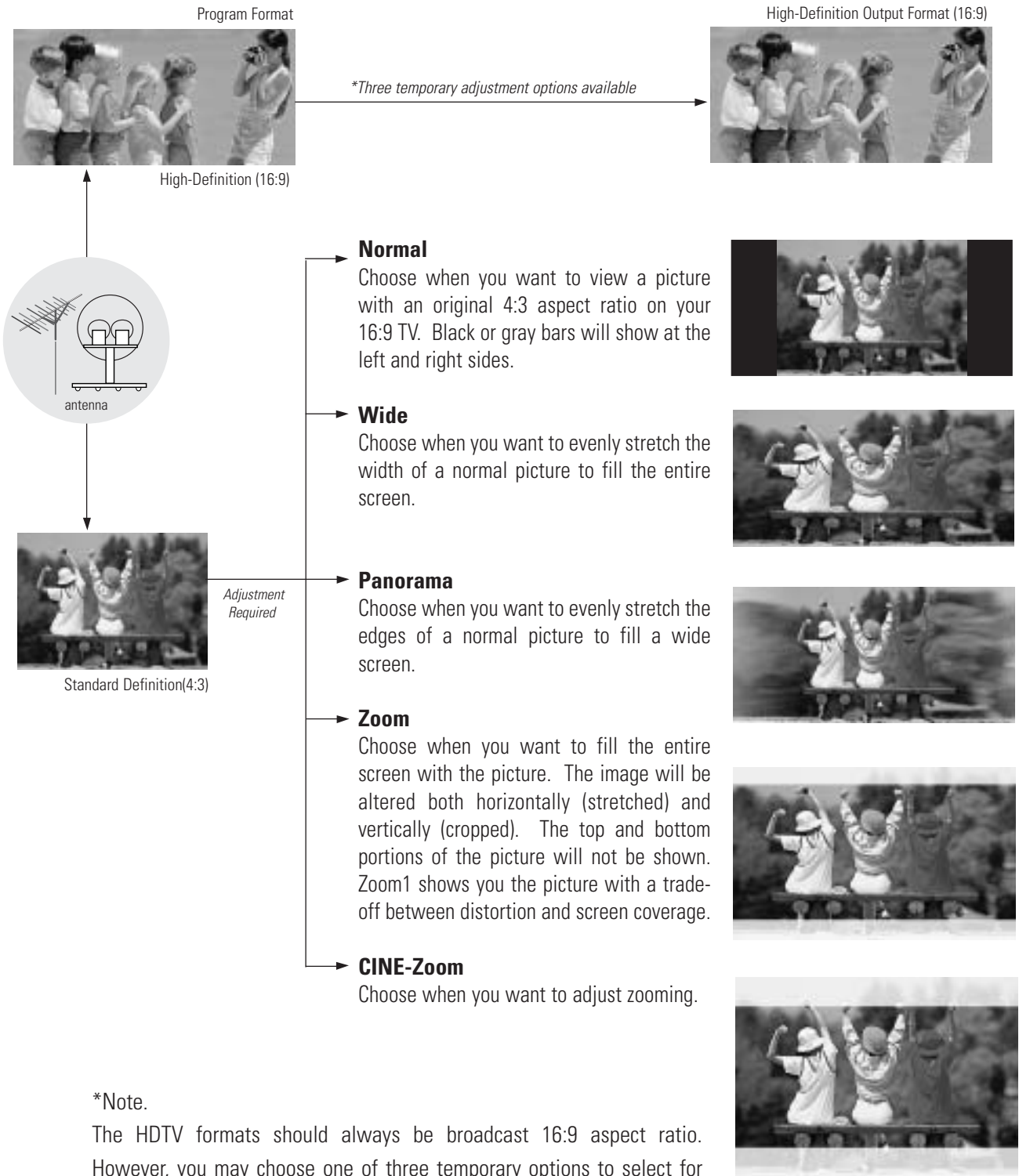

## 2-5. Audio Signals

### Digital Audio Signals

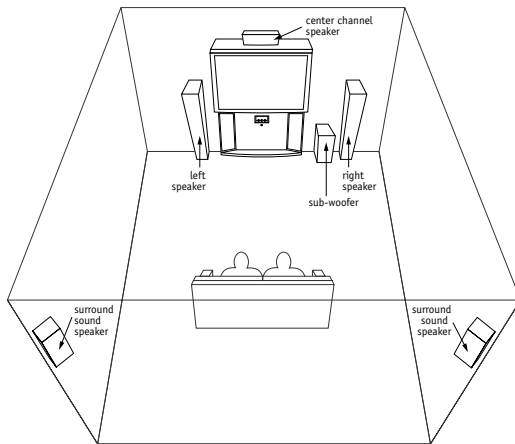

Dolby Digital Sound with 5.1 Channels

The DIRECTV® HD Receiver will be the focal center of your home entertainment system comprising a variety of components, such as TV, DVD, VCR, etc. and external audio systems. Since digital programs being broadcast contain digital-quality audio, you can create a home theater by sending audio signals from the DIRECTV HD Receiver to your audio system externally. HD digital signals use the Dolby Digital audio encoding system - the same digital sound used in many movie theaters, on DVDs, and in many home theater systems.

When you tune to a channel, the DIRECTV HD Receiver can send signals either to a Dolby Digital decoder/receiver or to a PCM (normal digital) decoder. (\* Refer to Section 3-7 Connection for Audio for making the required external connections to your system.)

#### GLOSSARY

Dolby Digital® audio, formally known as Audio Coding 3rd Generation is a coding technique that can provide up to five independent, full frequency response audio channels (three in left, center, and right, two in rear left and right,) and one low frequency effect for a sound you can feel.

## 2. IMPORTANT OVERVIEW

### 2-5. Audio Signals

#### Analog Audio Signals

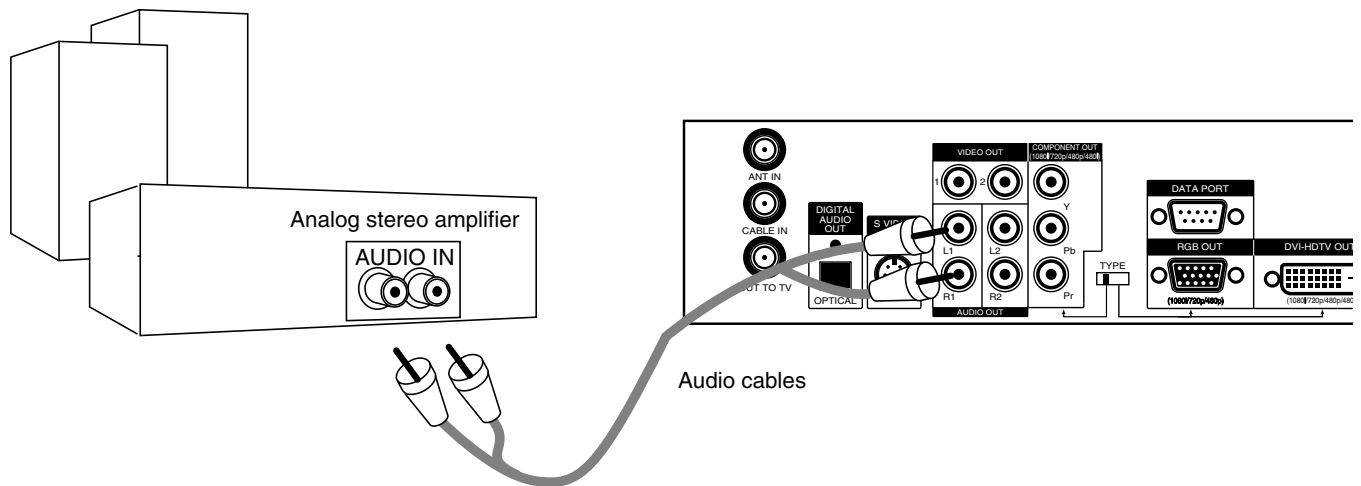

The analog audio outputs may be used to drive an external Hi-Fi audio system instead of the TV speakers. These stereo outputs are activated by setting the Analog Mode in the Audio menu to Stereo.

If you set the Analog Mode to SAP (Second Audio Program), you can hear the program's dialog in another language such as French or Spanish, if provided on the analog broadcast.



## 2-6. On-Screen Display

### Main Menu

You can adjust the setup through a user-friendly on-screen menu using the remote control. While viewing a program, the on-screen menu will appear on your TV screen if you press the **MENU** button on your remote control. The on-screen menu is operated using a simple, straight-forward 'Highlight and Select' process. You just highlight a menu item by using "▲▼◀▶" on your remote control, and select it by pressing "⊙". The on-screen menu also offers visual cues for easy guidance.



### Advanced Program Guide™

The DIRECTV Advanced Program Guide is an on-screen listing of current and future programs that are available from DIRECTV. The DIRECTV® HD Receiver offers you a comprehensive program list that contains information about programs with hundreds of channels, including analog Antenna and digital (ATSC). If you do not subscribe to DIRECTV® programming, you will not be able to see the Advanced Program Guide.



## 2. IMPORTANT OVERVIEW

### 2-6. On-Screen Display

#### Help

First, certain features and terminologies used in the on-screen menus require your basic understanding to fully utilize their capabilities. The DIRECTV® HD Receiver provides a powerful feature called “Help” that describes highlighted menu item to help you understand the features. Press and hold the “**HELP (?)**” button to display the “Help”. Once you release the button, the Help menu disappears from the screen.



Second, if you press the “**HELP (?)**” button while you are viewing a program with no menus on -screen, the DIRECTV HD Receiver provides a comprehensive on-screen user’s guide. It describes how to use your receiver.

This is, in fact, an on-line version of this Operating Guide.



# 3. SETUP AND CONNECTIONS

## 3-1. Unpacking

Make sure you have received all these items listed below with the DIRECTV® HD Receiver.

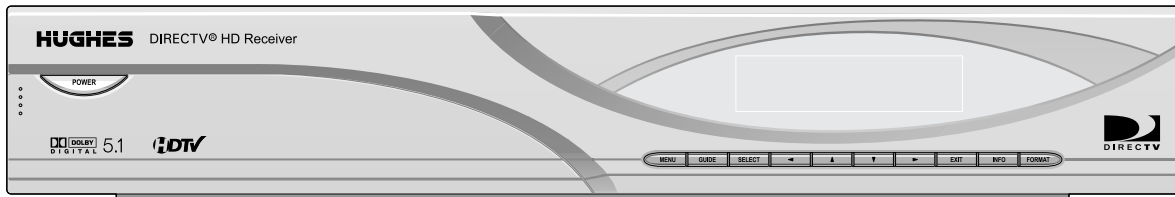

### Remote Control



### Cables

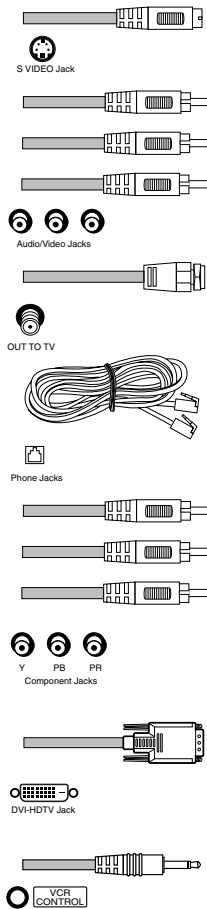

### Batteries

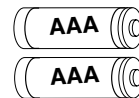

### Access Card



# 3. SETUP AND CONNECTIONS

## 3-1. Unpacking

### **DIRECTV® HD Receiver**

The DIRECTV HD Receiver is capable of receiving signals from the satellite dish, cable, and/or over-the-air antenna and sending the decoder signals to your TV.

### **Remote Control**

In addition to the DIRECTV HD Receiver, the remote control can be programmed to control many other devices.

### **Batteries**

To install the batteries, slide open the battery compartment and insert the two AAA batteries provided.

### **Component Out Jacks and Cables**

Component Cables are used to connect the DIRECTV HD Receiver to an industry standard Y/Pb/Pr compatible HD Monitor. Component jacks carry only the video signals, not the audio.

### **DVI-HDTV port and Cable**

DVI cable is used to connect the DIRECTV HD Receiver to an industry standard DVI-HDTV compatible HD monitor. A DVI jack carries only the video signals, not the audio.

### **S-Video Jack and Cable**

An S-Video jack is provided on the DIRECTV HD Receiver and is used together with audio cables. Remember to connect the left and right audio cables. An S-Video jack carries only the picture signals, not the sound.

### **Audio/Video Jacks and Cables**

The Audio/Video jacks provide good picture and sound quality. They are used for making most Audio/Video connections between components. The Audio/Video jacks may be color coded (yellow for video, red for right audio, and white for left audio). If your component has only one input for audio (mono), connect it to the left (white L/mono) audio jack on the DIRECTV HD Receiver.

### **RF (Radio Frequency) Jacks and Coaxial Cables (F-type)**

RF jacks are necessary for reception of over-the-air broadcasts, cable, and DIRECTV signals. These jacks are also required for antenna or cable connections. The RF and coaxial jacks on the DIRECTV HD Receiver are labeled: Antenna, Cable, Satellite and OUT TO TV. An RG-6 type coaxial cable is required for satellite signal distribution.

### **Telephone Jack and Cord**

A telephone line cord is required to connect the DIRECTV HD Receiver to a phone line. To subscribe to DIRECTV® programming, this phone line is required to be connected.

### **Access Card**

The Access Card is the means by which DIRECTV controls the distribution of its service. The card must be inserted into the access card slot (on the front of the DIRECTV HD Receiver) at all times to ensure reception of satellite signals.

### **VCR Controller**

The VCR Controller allows the Record function to automatically operate your VCR.

## 3-2. Back Panel of the DIRECTV® HD Receiver

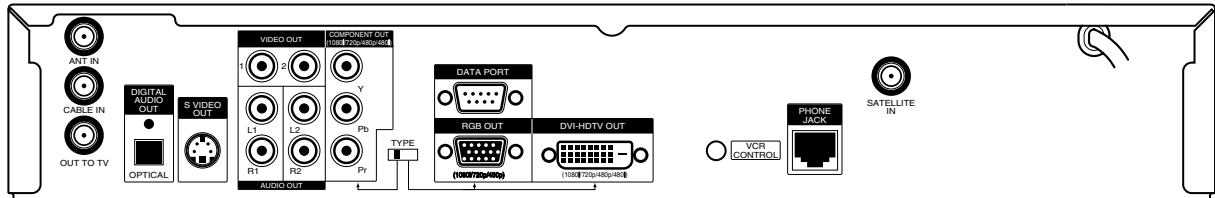

### Ant In

Is used to connect an over-the-air or terrestrial antenna.

### Cable In

Is used to connect a coaxial cable coming from your cable TV service outlet or cable box.

### Out to TV

Provides an RF connection between the DIRECTV HD Receiver and older TVs. All decoded signals are provided on channel 3 or 4 as selected in the Output Channel section of the Setup menu. When the DIRECTV HD Receiver is in the standby mode, Cable or Antenna signals are passed through as chosen in the Out to TV section of the Setup menu.

### Video Out 1,2

Is used to provide baseband composite video signal to a VCR or TV set. Video connection generally provides picture quality that is superior to RF connections. For a better quality picture connection, use the S-Video jack if it is available.

### Component Out

Is used to connect to a Y/Pb/Pr-compatible HD monitor. Three video and two audio jacks for a Y/Pb/Pr monitor need to be connected and the **TYPE** switch must be set to left position.

### RGB/DVI-HDTV Out

Is used to connect to either a RGB-compatible or DVI-HDTV compatible HD monitor. Either a RGB port for a RGB monitor or a DVI-HDTV port for a DVI-HDTV monitor need to be connected and the **TYPE** switch must be set to right position.

### Notes

- The DVI-HDTV port has a higher priority when both the RGB and DVI-HDTV ports are connected.
- For the best access to High-Definition Programming at the highest available resolution broadcast by DIRECTV, connect the DVI-HDTV output to the corresponding DVI input that supports high-bandwidth Digital Content Protection (HDCP) technology on a High-Definition Television (HDTV) or HDTV monitor. Please check your HDTV or HDTV Monitor user manual or contact the television manufacturer to find out if your HDTV or HDTV Monitor supports HDCP.)

# 3. SETUP AND CONNECTIONS

## 3-2. Back Panel of the DIRECTV® HD Receiver

### **Audio Out 1,2**

Is used to provide analog audio signals to VCR, TV set, HD Monitor, or Analog Hi-Fi System.

### **Digital Audio Out**

Is used to connect a digital optical cable from the DIRECTV HD Receiver to the Dolby Digital® receiver or decoder. Dolby Digital audio enables the viewer to experience theater-quality sound using up to 5.1 audio channels when available in the broadcast.

### **Data Port**

Can be used to communicate with certain compatible devices, such as Personal Video Recorders.

### **VCR Control**

Is used to connect the VCR controller cable to your receiver.

### **Phone Jack**

Is used to connect a phone line.

### **Satellite In**

Is used to connect a satellite dish antenna to your receiver.

### 3-3. General Recommendations



**CAUTION:** Make all connections before plugging the power supply cord into a standard 120V, 60Hz AC power outlet.

You can connect the DIRECTV® HD Receiver in a variety of configurations. The answers to the following questions will determine the correct setup for you.

- What type of antennas do you have? Satellite dish, cable, and/or over-the-air antennas.
- What type of connectors does your TV or VCR have: Y/Pb/Pr, RGB, DVI-HDTV, S-VIDEO, A/V (RCA-type), or RF coaxial?
- Do you have an external audio or audio/video system? Consider integrating the DIRECTV HD Receiver into a home theater configuration to take advantage of the audio capabilities of your Dolby Digital® System (Digital) or Hi-Fi System (Analog).
- Does your TV have Y/Pb/Pr connectors? Use it to connect your TV to the DIRECTV HD Receiver. An Y/Pb/Pr connection provides a better picture than S-VIDEO, RCA-type video, or RF connections.
- Does your TV have an S-VIDEO jack? Use it to connect your TV to the DIRECTV HD Receiver. An S-VIDEO connection provides a better picture than RCA-type video or RF connections.
- Does your TV have RCA-type A/V connectors, but no S-video jack? Use your TV's A/V connectors to connect your components. An A/V connection provides better picture and audio when compared to an RF connection.

Although there are numerous connections possible for optimum video and audio performance, try to follow the guidelines listed below when you hook up your components. Detailed hook-up instructions are provided on the following pages.

Connection	Component	Page
To Antennas	Non-Satellite Sources	23
	Round Dish (Satellite A)	24
	Oval Dish (Satellite A, B)	25
	Oval Dish (Satellite A, B, C)	26
To TV/Monitor	Analog TV	27
	HD Monitor (Y/Pb/Pr type)	28
	HD Monitor (RGB type)	29
	HD Monitor (DVI-HDTV type)	30
To A/V Systems	VCR	31-32
	Digital Audio System	33
	Analog Hi-Fi System	34



Protect your components from power surges by turning off the component and unplugging power cords when you make connections.

Protect your component from overheating by keeping the ventilation holes open and not stacking components.

# 3. SETUP AND CONNECTIONS

## 3-4. Connecting to Antennas - Non-Satellite Sources

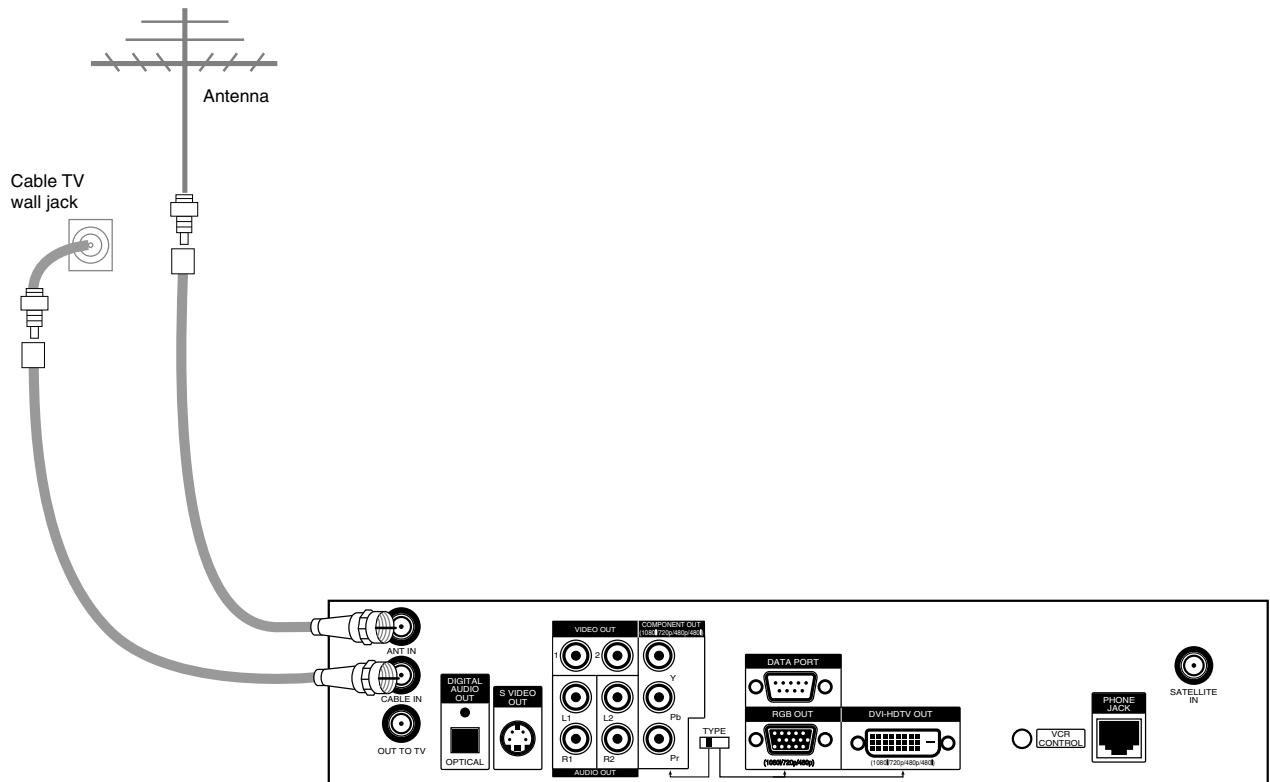

### Receiving Signals

1. Connect the "Antenna" to the "ANT IN" jack on the DIRECTV® HD Receiver using a coaxial RF cable.
2. Connect the cable TV signal to the "CABLE IN" jack on the DIRECTV HD Receiver using a coaxial RF cable.



### 3-4. Connecting to Antennas - Round Dish (Satellite A)

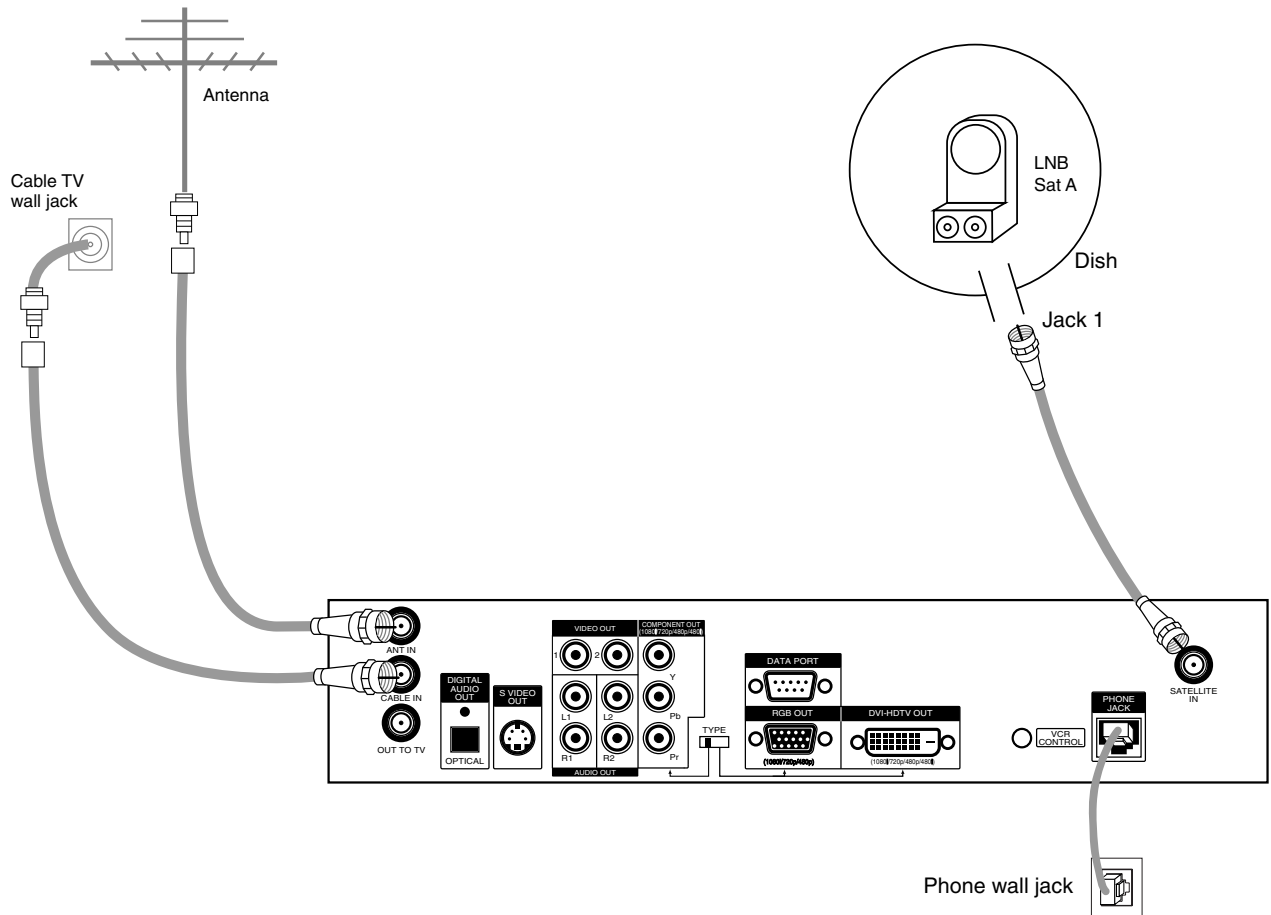

#### Receiving Signals

1. Connect the "Antenna" to the "ANT IN" jack on the DIRECTV® HD Receiver using a coaxial RF cable.
2. Connect the cable TV signal to the "CABLE IN" jack on the DIRECTV HD Receiver using a coaxial RF cable.
3. Connect the "Jack 1" of the dish antenna to the "SATELLITE IN" jack on the DIRECTV HD Receiver using a coaxial RF cable. (For proper dish installation, refer to the "Installer's Guide" provided with your satellite dish antenna. Use RG6 type cable.)
4. Connect the "Phone Wall Jack" to "PHONE JACK" on the DIRECTV HD Receiver using a phone cable.

#### NOTE

While you are a subscriber to a DIRECTV® program package, you can still view over-the-air and cable TV programs, if you make connections to the over-the-air and/or cable jacks.

#### NOTE

A triple LNB multi-satellite dish with a SAT C LNB is required to receive all DIRECTV® High-Definition programming, along with this DIRECTV HD Receiver.

# 3. SETUP AND CONNECTIONS

## 3-4. Connecting to Antennas - Oval Dish (Satellite A, B)

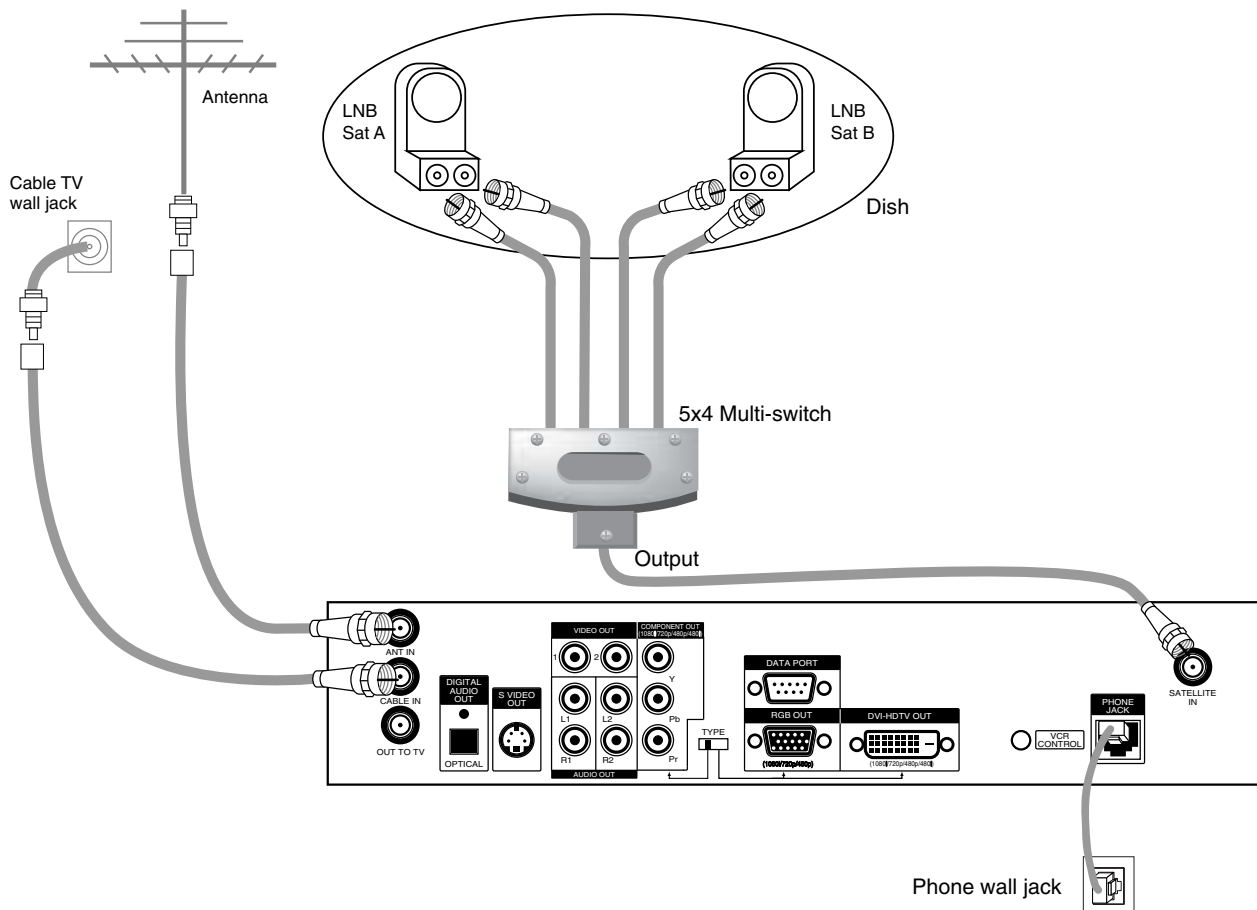

### Receiving Signals

1. Connect the "Antenna" to the "ANT IN" jack on the DIRECTV® HD Receiver using a coaxial RF cable.
2. Connect the cable TV signal to the "CABLE IN" jack on the DIRECTV HD Receiver using a coaxial RF cable.
3. Connect the "Jack 1" of the multi-switch to the "SATELLITE IN" jack on the DIRECTV HD Receiver using a coaxial RF cable. (For proper dish installation, refer to the "Installer's Guide" provided with your satellite dish antenna. Use RG6 type cable.)
4. Connect the "Phone Wall Jack" to "PHONE JACK" on the DIRECTV HD Receiver using a phone cable.

#### NOTE

While you are a subscriber to a DIRECTV® program package, you can still view over-the-air and cable TV programs, if you make connections to the over-the-air and/or cable jacks.

#### NOTE

A triple LNB multi-satellite dish with a SAT C LNB is required to receive all DIRECTV® High-Definition programming, along with this DIRECTV HD Receiver.

### 3-4. Connecting to Antennas - Oval Dish (Satellite A, B, C)

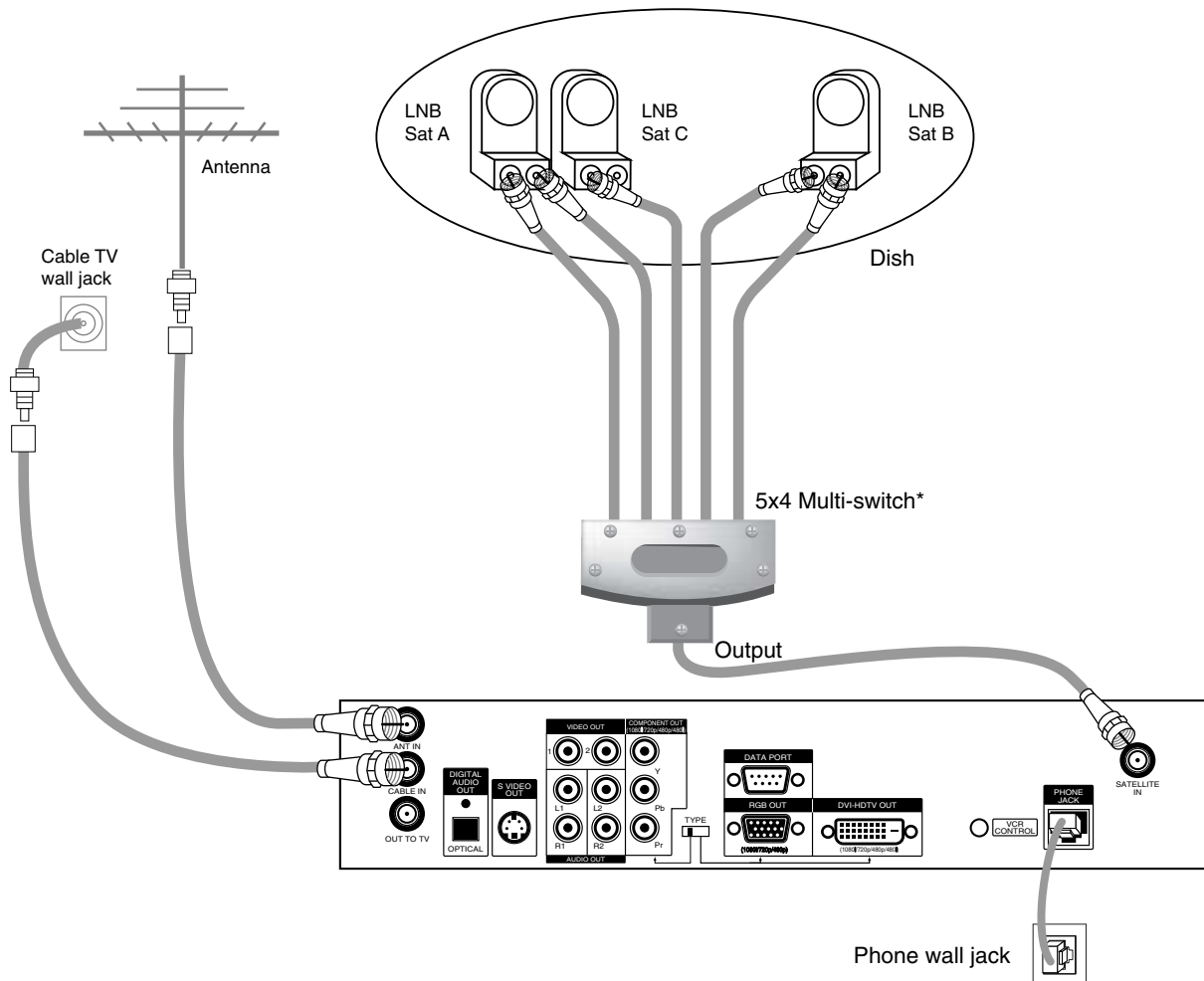

#### Receiving Signals

1. Connect the "Antenna" to the "ANT IN" jack on the DIRECTV® HD Receiver using a coaxial RF cable.
2. Connect the cable TV signal to the "CABLE IN" jack on the DIRECTV HD Receiver using a coaxial RF cable.
3. Connect "Output" of the multi-switch to the "SATELLITE IN" jack on the DIRECTV HD Receiver using a coaxial RF cable. (For proper dish installation, refer to the "Installer's Guide" provided with your satellite dish antenna).
4. Connect the "Phone Wall Jack" to "PHONE JACK" on the DIRECTV HD Receiver using a phone cable.

#### NOTE

While you are a subscriber to a DIRECTV® program package, you can still view over-the-air and cable TV programs, if you make connections to the over-the-air and/or cable jacks.

#### NOTE

A triple LNB multi-satellite dish with a SAT C LNB is required to receive all DIRECTV® High-Definition programming, along with this DIRECTV HD Receiver.

\* Sat C may also be connected via a SAT B/SAT C combiner with a 4x4 multi-switch (not supplied by HUGHES).

# 3. SETUP AND CONNECTIONS

## 3-5. TV Connection - Analog TV

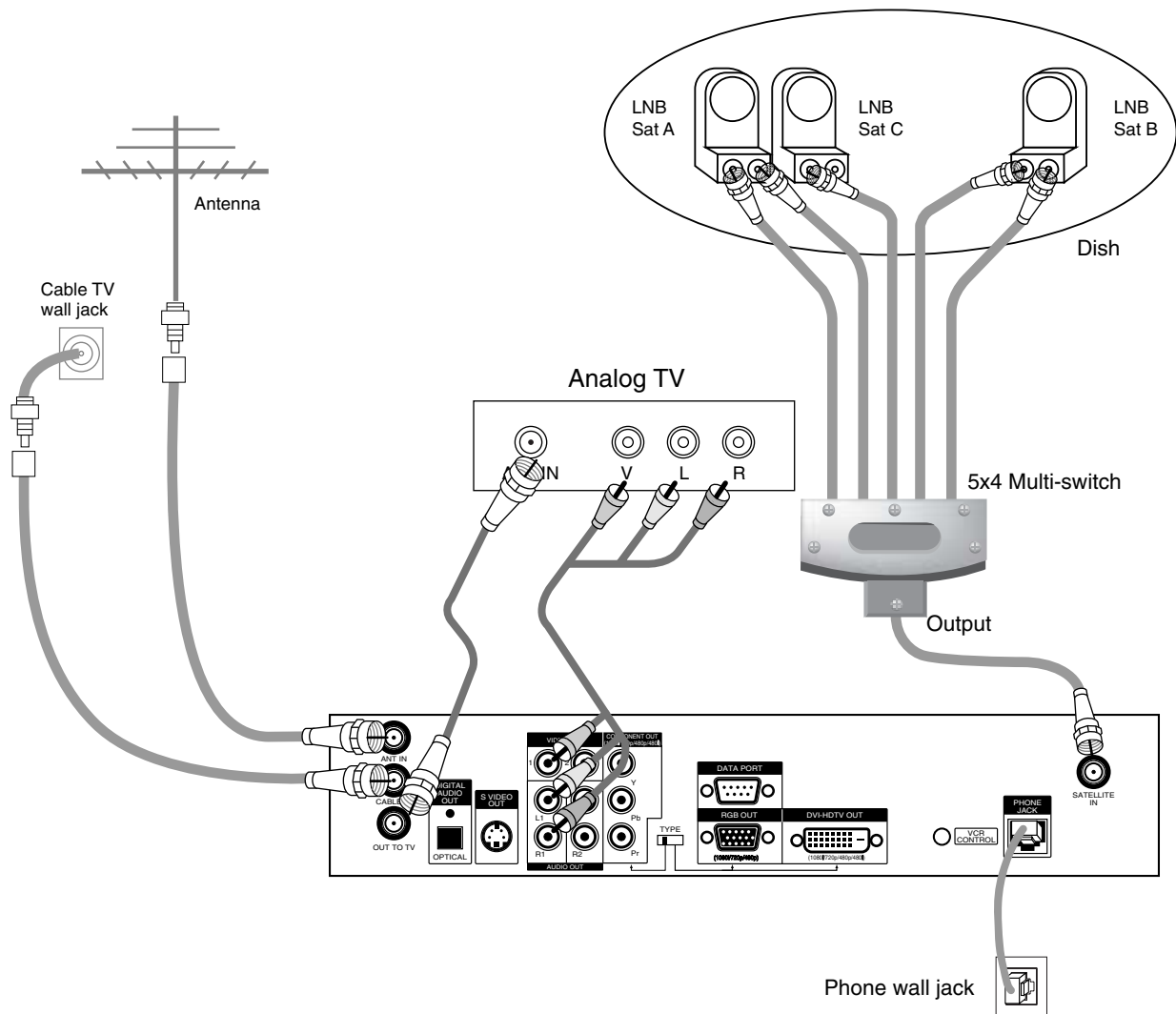

### TV Viewing

1. Connect the "OUT TO TV" jack on the DIRECTV® HD Receiver to the "ANT IN" jack on your TV using a coaxial RF cable.
2. Connect the "AUDIO OUT" and "VIDEO OUT" jacks on the DIRECTV HD Receiver to the "A/V IN" jack on your TV using RCA-type cables.
3. Select Antenna In or A/V In source on your TV. (Refer to TV user's manual.)

### 3-5. TV Connection - HD Monitor (Y/Pb/Pr type)

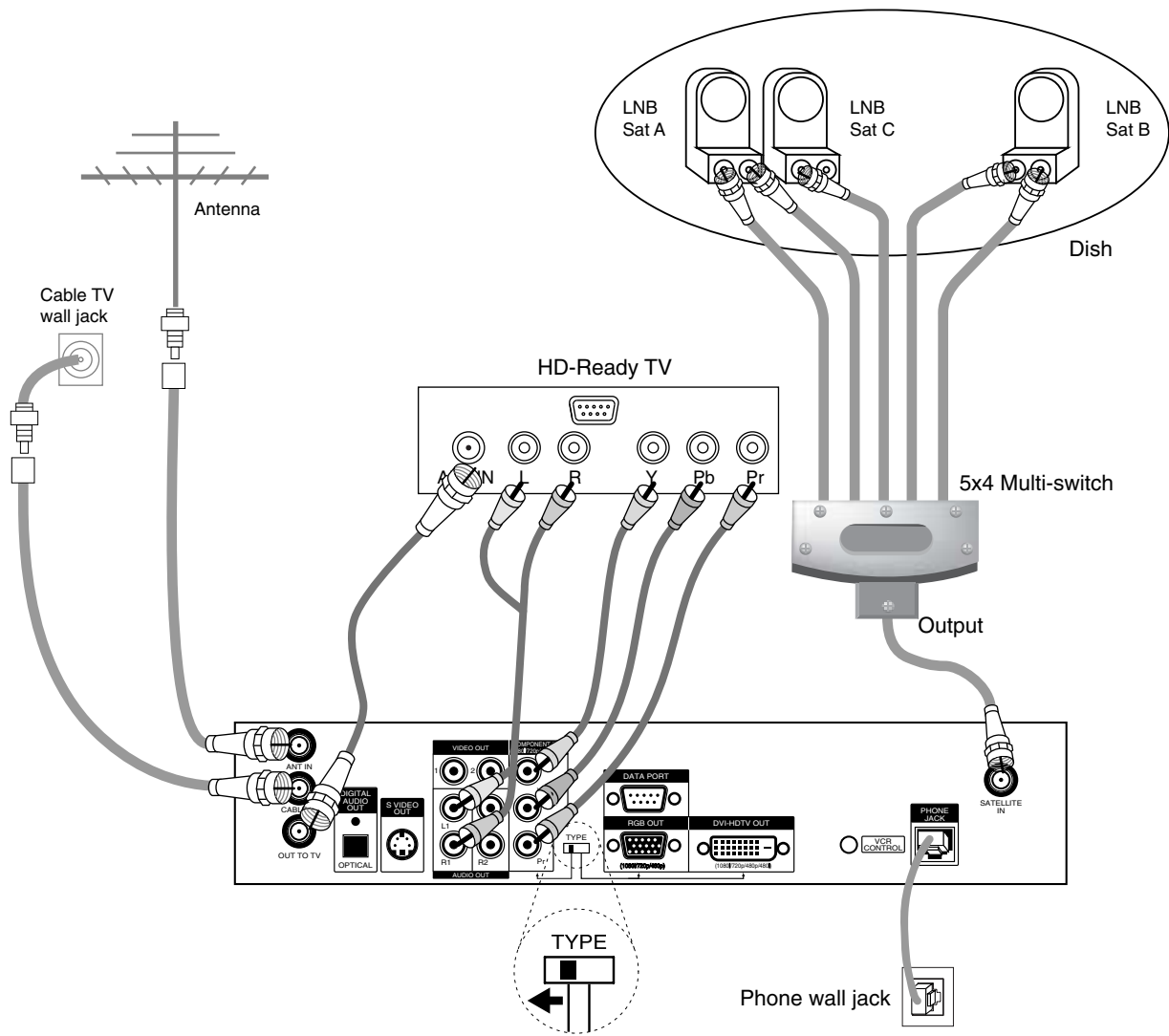

#### TV Viewing

1. Connect the "OUT TO TV" jack on the DIRECTV® HD Receiver to the "ANT IN" jack on your TV using a coaxial RF cable.
2. Connect the "COMPONENT OUT" jacks on the DIRECTV HD Receiver to the "COMPONENT IN" jacks of your TV using RCA-type cables. (The "TYPE" switch must be set toward the "Y/Pb/Pr" jacks.)
3. Connect the L/R "AUDIO OUT" jacks on the DIRECTV HD Receiver to the L/R "AUDIO IN" jacks on your TV using RCA-type cables.
4. Select Antenna In or DVI-HDTV In, source on your TV. (Refer to TV user's manual.)

# 3. SETUP AND CONNECTIONS

## 3-5. TV Connection - HD Monitor (RGB type)

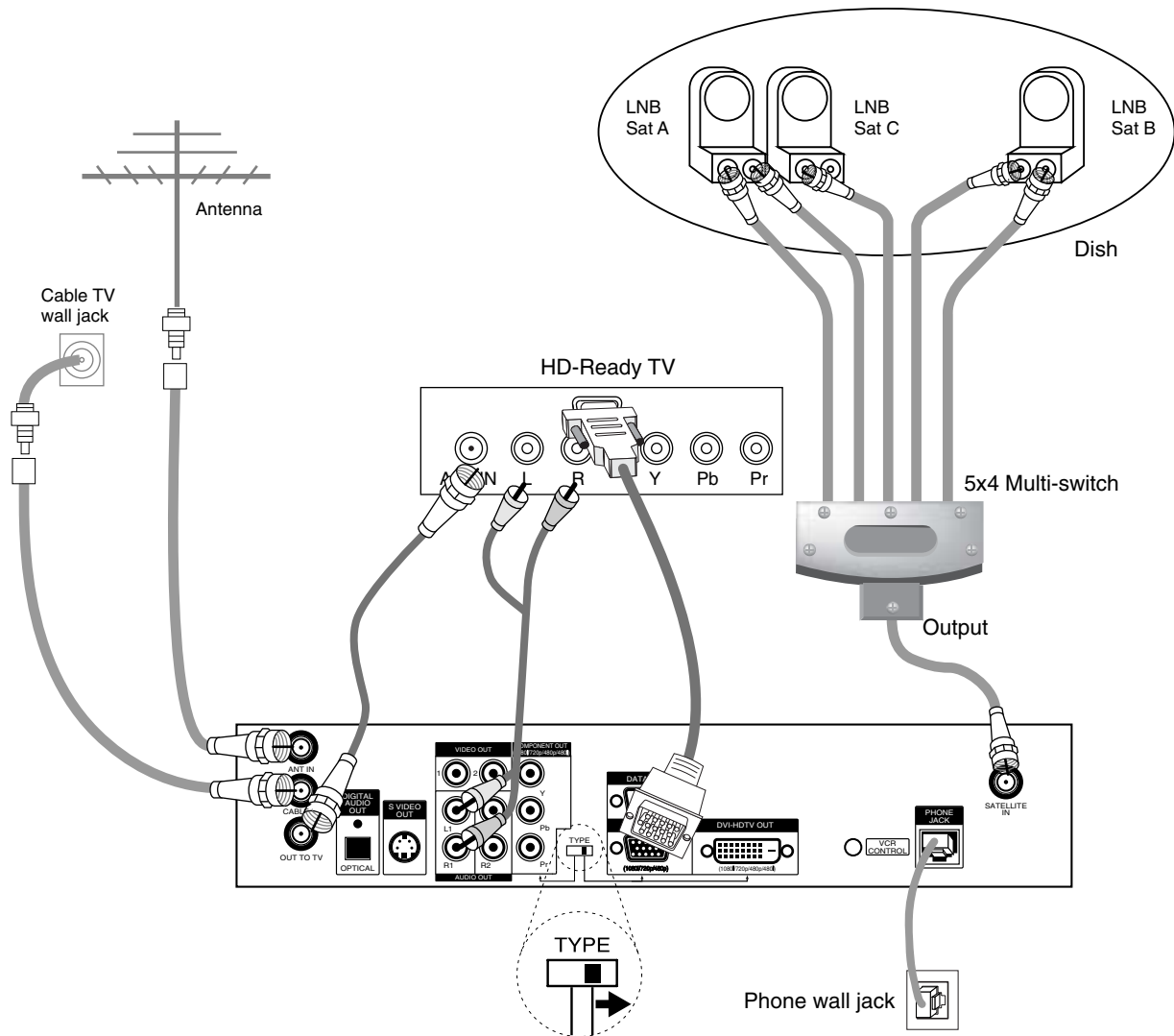

### TV Viewing

1. Connect the "OUT TO TV" jack on the DIRECTV® HD Receiver to the "ANT IN" jack on your TV using a coaxial RF cable.
2. Connect the "RGB OUT" jack on the DIRECTV HD Receiver to the "RGB IN" jack of your TV using VGA-type connector. (The "TYPE" switch must be set toward the "RGB/DVI-HDTV" jacks.)
3. Connect the L/R "AUDIO OUT" jacks on the DIRECTV HD Receiver to the L/R "AUDIO IN" jacks on your TV using RCA-type cables.

Note : The RGB OUT jack supports 480p, 720p, and 1080i formats.

4. Select Antenna In or RGB In, source on your TV. (Refer to TV user's manual.)

### 3-5. TV Connection - HD Monitor with HDCP (DVI-HDTV type)

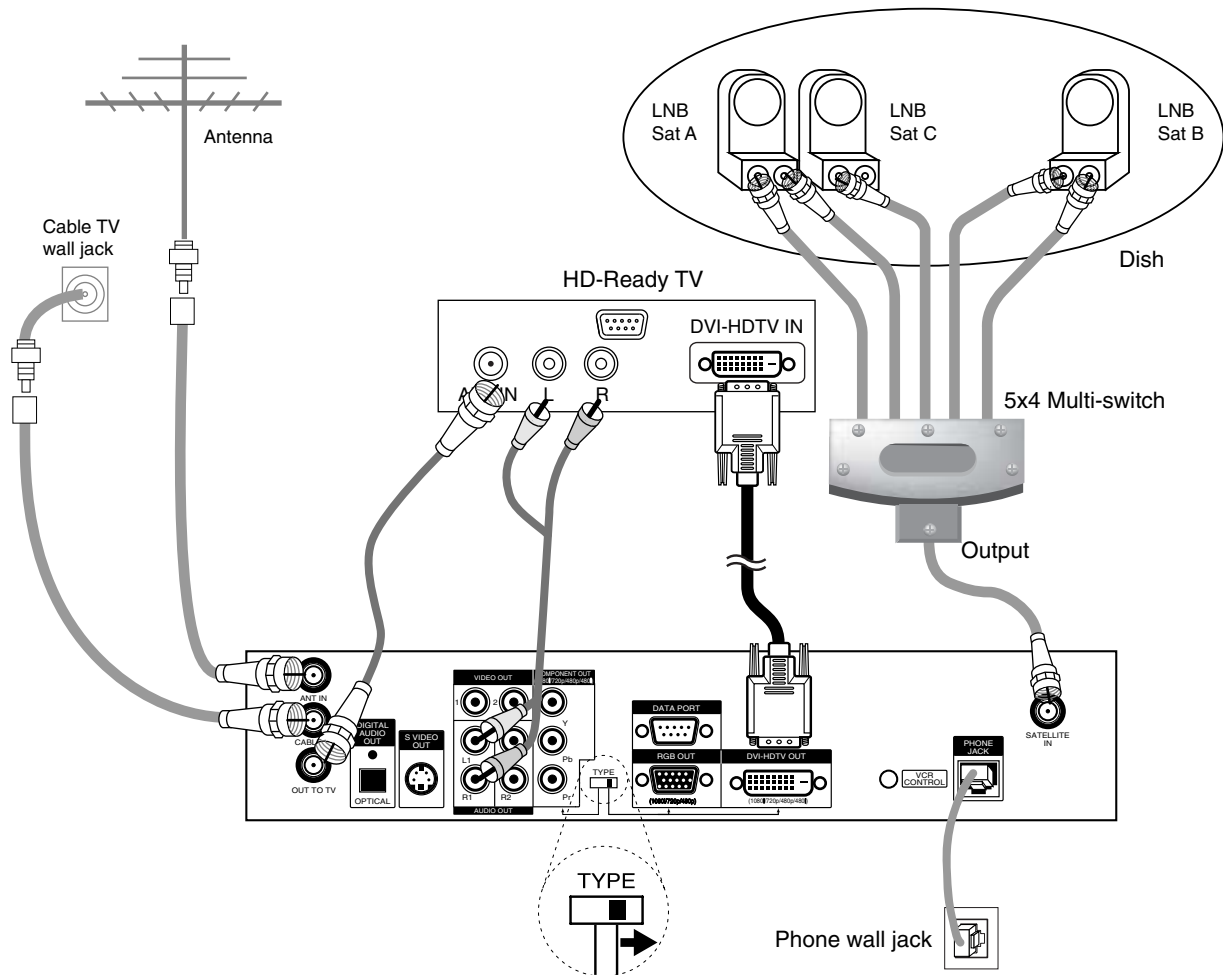

#### TV Viewing

1. Connect the "OUT TO TV" jack on the DIRECTV® HD Receiver to the "ANT IN" jack on your TV using a coaxial RF cable.
2. Connect the "DVI-HDTV OUT" jack on the DIRECTV HD Receiver to the "DVI-HDTV IN" jack of your TV using DVI-HDTV type connector. (The "TYPE" switch must be set toward the "RGB/DVI-HDTV" jacks.)
3. Connect the L/R "AUDIO OUT" jacks on the DIRECTV HD Receiver to the L/R "AUDIO IN" jacks on your TV using RCA-type cables.

Note : For the best access to high-definition programming at the highest available resolution broadcast by DIRECTV, connect the DVI-HDTV output to the corresponding DVI-HDTV input that supports high-bandwidth Digital Content Protection (HDCP) technology on a High-Definition Television (HDTV) or HDTV monitor. Please check your HDTV or HDTV Monitor user manual or contact the television manufacturer to find out if your HDTV or HDTV Monitor supports HDCP.

4. Select Antenna In or DVI-HDTV In, source on your TV. (Refer to TV user's manual.)

# 3. SETUP AND CONNECTIONS

## 3-6. VCR Connection

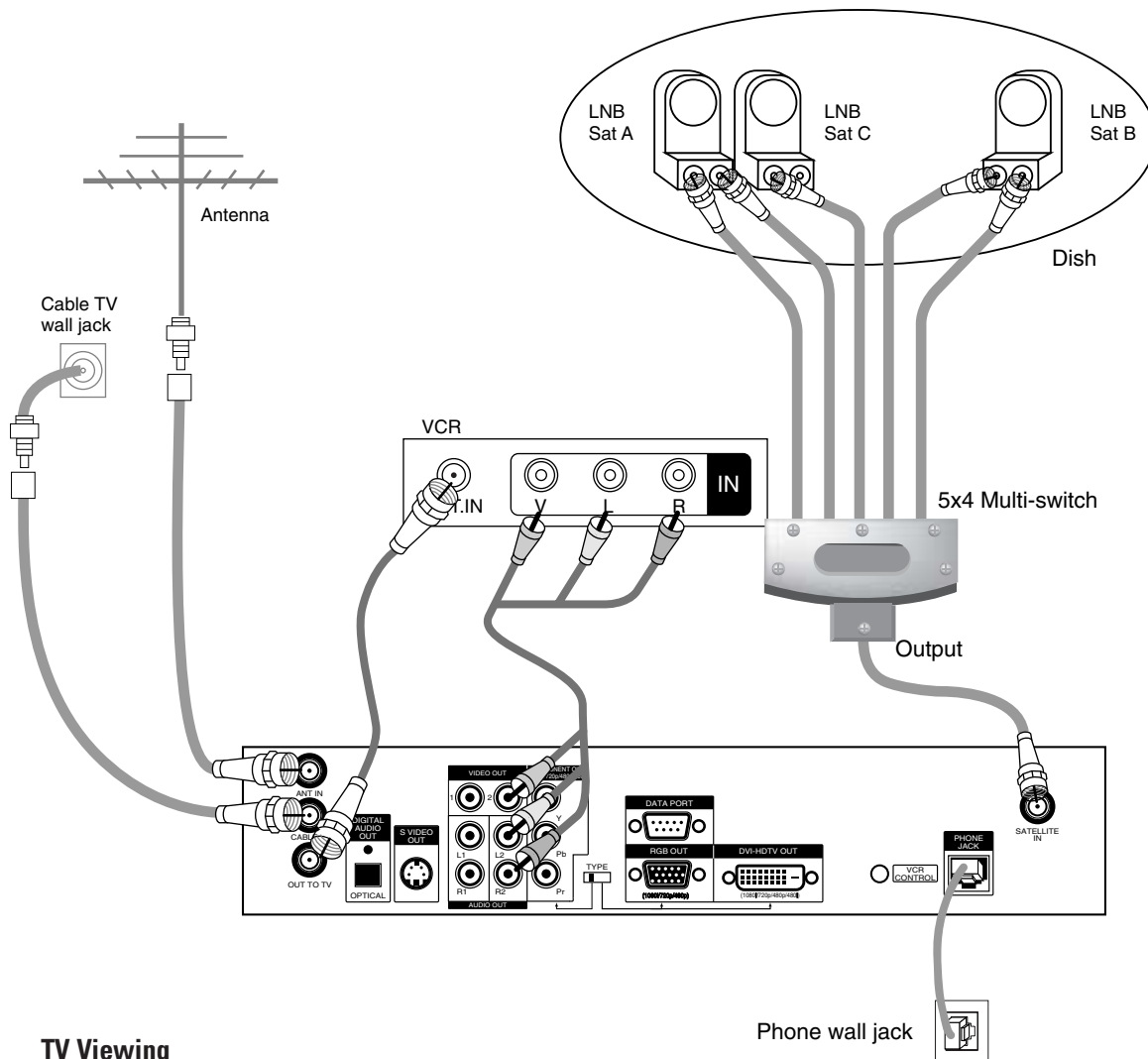

### TV Viewing

Refer to Section 3-5, 'TV Connection'.

### VCR Recording

1. Connect the "OUT TO TV" jack on the DIRECTV® HD Receiver to the "ANT IN" jack on your VCR using a coaxial RF cable.
2. Connect the "AUDIO OUT" and "VIDEO OUT" jacks on the DIRECTV HD Receiver to the "A/V IN" jacks on your VCR using RCA-type cables. (If your VCR is equipped with an S-Video jack, use the "S-Video" jack.)

Note: The OUT TO TV and VIDEO OUT(480i) 1, 2 jacks are always available sources output no matter what display format is selected.



### 3-6. VCR Connection - VCR Controller

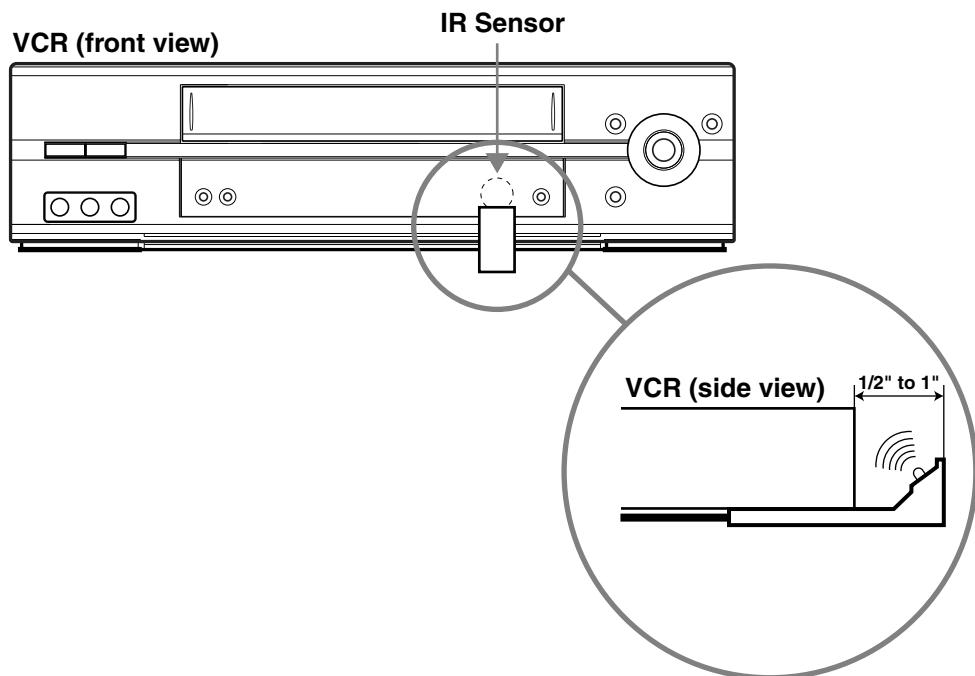
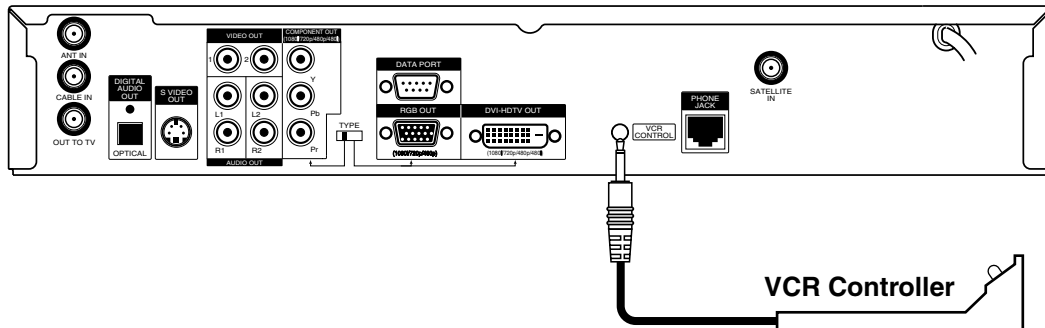

Connect the VCR Controller to allow the Timer and Rec feature to automatically operate your VCR. See “VCR Control Setup” on page 111 for information about setting up the Digital Satellite Receiver to operate with your VCR.

1. Connect the VCR Controller to the VCR CONTROL jack on the DIRECTV® HD Receiver.
2. Place the VCR Controller under and in front of the VCR. The VCR Controller must extend just on front of the infrared sensor of the VCR.

Note: If the infrared sensor is not marked on your VCR, shine a flashlight into the front panel of the VCR to locate the sensor.

# 3. SETUP AND CONNECTIONS

## 3-7. Audio Connection - Digital Audio System

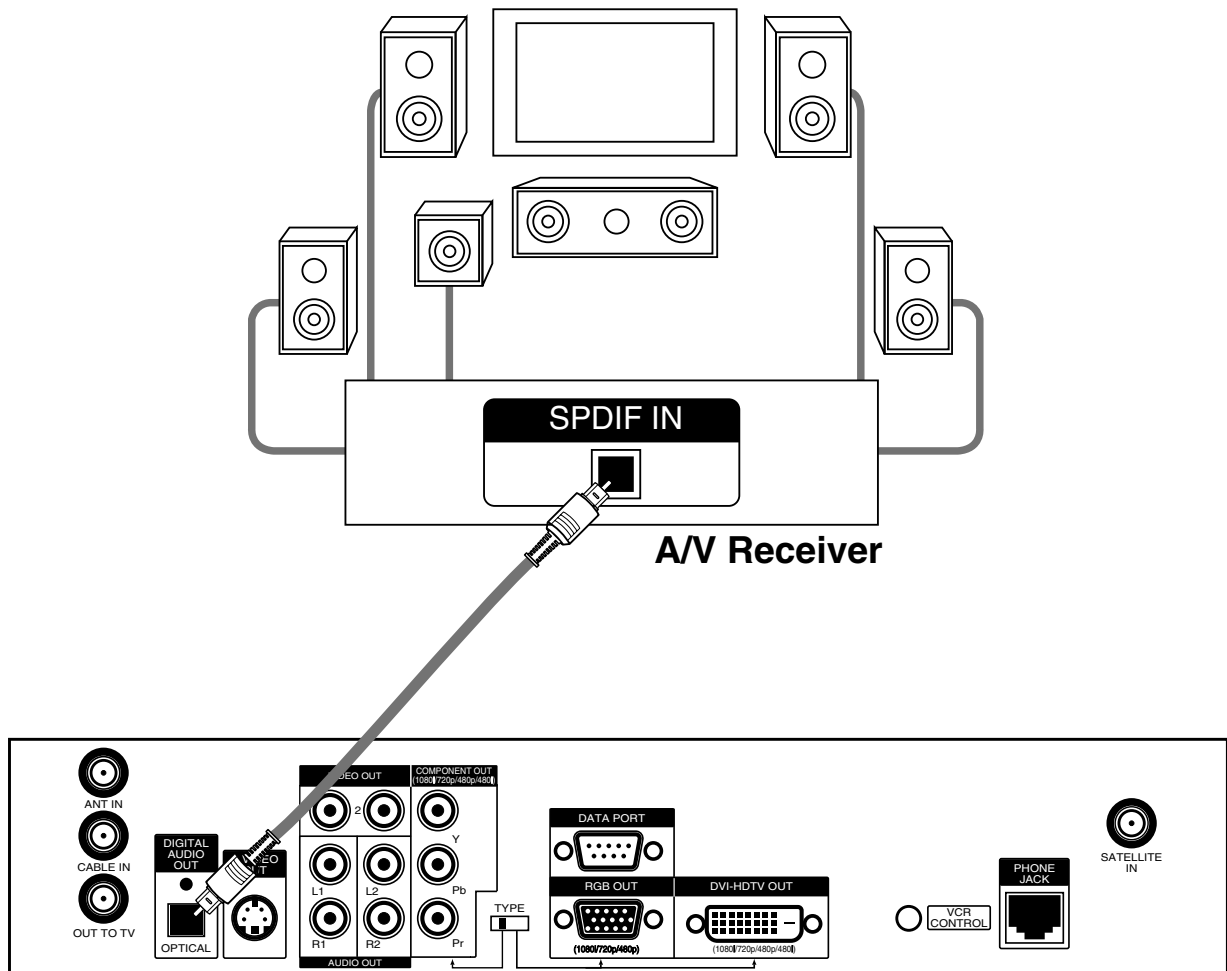

### Dolby Digital® Connection

1. Connect the "DIGITAL AUDIO OUT" jack on the DIRECTV® HD Receiver to the "SPDIF IN" jack on your Dolby Digital or Pro Logic® decoder using a digital optical cable. (A digital optical cable is not supplied.)

#### NOTE

To enjoy Dolby Digital audio when it is available in a broadcast, set the HD Receiver's Digital Output to the Dolby Digital setting (see section 8-12).

### 3-7. Audio Connection - Analog Hi-Fi System

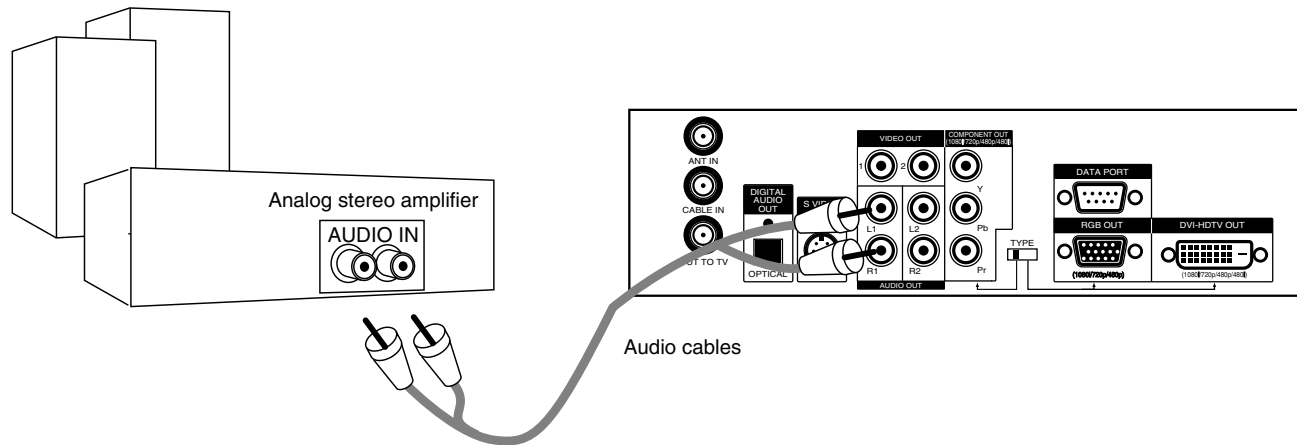

#### Hi-Fi System Connection

1. Connect the Left and Right "AUDIO OUT" jacks from the DIRECTV® HD Receiver to the Left and Right "INPUT" jacks on your Hi-Fi audio system.

#### NOTE

When viewing a digital broadcast with Dolby Digital® audio, you will be able to hear the broadcast's audio from the analog audio left and right jacks. However, a digital audio connection to a Dolby Digital audio receiver is required to enjoy Dolby Digital audio with up to 5.1 channels.

# 4. FRONT PANEL AND REMOTE CONTROL

## 4-1. Using the Front Panel of the DIRECTV® HD Receiver

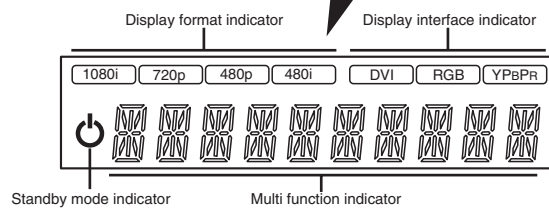
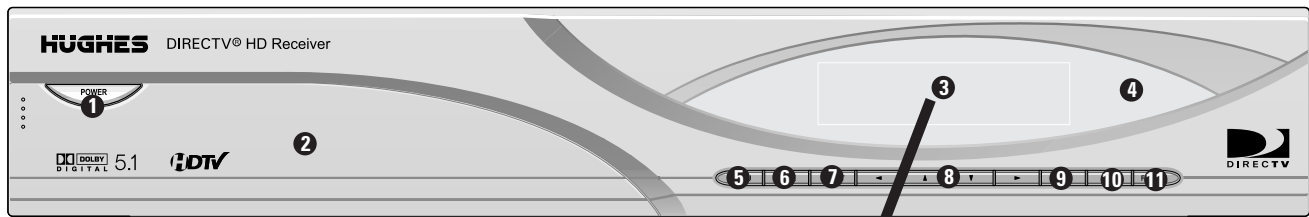

### 1 POWER

Turns the DIRECTV HD Receiver on or off.

### 2 Access Card and RESET button Door

The Access Card is the means by which DIRECTV controls the distribution of its services. The card must be inserted into the access card slot at all times to enable reception of satellite signals. The RESET button resets the HD Receiver.

### 3 Display Window

Shows DIRECTV HD Receiver status : Current output format, interface type, and channel number. Also displays artist and song information of satellite music-only channels.

### 4 Remote Control Sensor

Receives signals from the remote control.

### 5 MENU

Shows the main menu on the screen. You can return to normal viewing by pressing the **EXIT** button.

### 6 GUIDE

Shows the DIRECTV Advanced Program Guide™ screen that shows you a program schedule containing a list of current and future programs. You can also access the Advanced Program Guide via the main menu (DIRECTV Guide). You can return to normal viewing by pressing the **EXIT** button. The Guide is only available with satellite service.

### 7 SELECT

If the main menu is displayed, pressing the **SELECT** button will activate the selected MENU item. If the **SELECT** button is pressed while you are in normal viewing, the information banner will be displayed.

### 8 Arrow Keys (CH ▲/▼)

Allows you to navigate on-screen menus and to adjust the system settings and preferences. Use the arrow keys to move to a menu option and then use the **SELECT** button to access it.

### 9 EXIT

Clears all on-screen displays and returns to normal viewing from any menu.

### 10 INFO

Shows station and program information in the banner shown at the top of the screen. To remove the banner, press the button again or wait for 10 seconds. You can also change the Audio language, when available, with "◀▶".

### 11 FORMAT

Sets the output resolution to either native, 1080i, 720p, 480p, 480i, variable 1, variable 2, variable 3, or DVI formats. Choose the best display format for your TV. (Refer to Section 2-3, 'Display Formats')

## 4-2. Using the Remote Control



### 1 POWER

Turns the DIRECTV® HD Receiver on and off. If your remote control is programmed to control other components such as VCR, DVD, etc., Power will turn the component on and off. If you want to control other components from different manufacturers, you must first program your remote control. For further instructions on remote control programming, please refer to the section 4-3 of this operating guide or the Program Remote section of on-screen help.

### 2 DEVICE KEYS

Selects the device that will be controlled by the remote. For example, if your remote control is set to VCR, the **CH ▲/▼** button will change the channel number of the VCR. If you want to control other devices from different manufacturers, you must first program your remote control.

### 3 Digit Buttons (0~9)

Allows you to enter channel numbers for direct tuning or to scroll to the designated page of the program list on the Guide menu. Digit buttons can be used to enter numerical values wherever required e.g. to enter a password.

### 4 Dash (-)

Is used to enter a channel number for multiple program channels such as 2-1, 2-2, etc. A broadcaster may transmit multiple programs on a single channel. Multiple programs are distinguished by a unique sub-channel number, separated by a dash (-).

### 5 SELECT (◉)

Use with numbered buttons for instant channel selection. When you press a channel number, for example, 22, the receiver awaits another stroke for three seconds and then tunes to 22. and selecting the highlighted option in a menu with "◉". If "◉" is pressed while you are in normal viewing, the information banner is displayed.

### 6 MUTE

Is used to temporarily turn off the sound. Press again to restore the sound.

# 4. FRONT PANEL AND REMOTE CONTROL

## 4-2. Using the Remote Control



### 7 VOL ▲/▼

Increases/decreases the sound level of the TV.

### 8 CH ▲/▼

Scrolls the channels up or down while you are viewing a program, or scrolls the program list in the Guide menu page by page. Press and hold the button to speed up and continue scrolling channels.

### 9 RATIO

Changes the picture aspect ratio. When you view a picture with a wide (16:9) aspect ratio in 480i or 480p format, the button changes the displaying options in the cycle of Letterbox → Cropped → Squeezed. When you view a picture with a normal (4:3) aspect ratio in 720p or 1080i format, the button changes the screen format in the cycle of Normal → Wide → Panorama → Zoom → CINE-Zoom. When you view a picture with a wide (16:9) aspect ratio in 720p or 1080i format, the button temporarily changes the RATIO options to Standard, Expand, or Shrink. Detailed descriptions of the TV aspect ratios are given in section 2-4 or the TV Aspect Ratio of the Preference menu.

### 10 INPUT

Allows you to select programming from additional program sources connected to the satellite receiver such as a DVD player, VCR's or a terrestrial TV antenna signal. Repeatedly press INPUT to cycle through each available input source in your system.

### 11 FREEZE

Freezes the current image. With digital video sources, pressing a second time enlarges the image. Pressing again returns to the the live video.

### 12 PREV CH

Returns to the last channel viewed. Allows you to move back and forth between the last two channels viewed.

### 13 CC/DATE (Closed Caption)

Changes the Digital Caption options and the Closed Caption options of the DIRECTV HD Receiver. The digital caption mode and the closed caption mode can also be selected in the Preferences menu. You can also change the date of the Advanced Program Guide™ by pressing the CC button when the Guide is displayed.

NOTE : Closed Caption will appear only when it is provided by the broadcaster.

## 4-2. Using the Remote Control



### 14 MENU

Brings up the main menu. You can return to normal viewing by pressing the **EXIT** button or pressing the **MENU** button again.

### 15 GUIDE

Brings up the DIRECTV Advanced Program Guide, showing ALL channels. You can also access the Advanced Program Guide via the main menu. Return to normal viewing by pressing the **EXIT** button or pressing the **GUIDE** button again.

### 16 SURF

Shows the list of your surf channels. A Surf channel list can contain up to fifty channels. You can return to normal viewing by pressing the **EXIT** button or pressing the **SURF** button again. Refer to Section 6-2 for creating and customizing your own Surf channel list.

### 17 INFO

Shows station and program information in the banner shown at the top of the screen. To remove the banner, press the button again or wait for 10 seconds. You can also change the audio language, when available, with "**◀▶**".

### 18 HELP (?)

Shows the on-screen "Help" menu while you are in normal viewing. The "**HELP (?)**" button also serves when you are in an on-screen menu. To see the help description of the selected option in the menu, press and hold the "**HELP (?)**" button.

### 19 Navigation

Allows you to navigate the on-screen menus and adjust the system settings and preferences, by moving to a menu option with "**▲▼◀▶**".

### 20 EXIT

Clears all on-screen displays and returns to TV viewing from any menu.

### 21 Component Control Buttons

Provides control for DVD players, VCRs, and similar components. The remote control must be programmed for the brand of component being used. For further instructions on remote control programming, please refer to Section 4-3 of this operating guide or the Program Remote section of on-screen help.

### 22 DVD/Skip Button

Provides search control for DVD players. Press the skip "Forward" or skip "Backward" button on the remote control, a chapter (DVD) or track (CD) is skipping backward or forward correspondingly after every time the button is pressed.

# 4. FRONT PANEL AND REMOTE CONTROL

## 4-3. Programming the Remote Control

You can operate your TV, VCR, and Audio/Video receiver using your HRMC-14 remote control. Use the Code Scanning or Code Entry method to program the remote control. Code scanning may be more time-consuming, but you don't need to know manufacturer's control codes. Using the Code entry method may be quicker, but you'll need to know the correct manufacturer's control codes for each component you want to operate.

1. Aim your remote control at the component you want to use.
2. Hold down the desired device button (TV, for example).
3. Press the MUTE button for one second.
4. Release both buttons together.
5. The device button (in this example, the TV button) glows and remains lit. If the button does not light, repeat the previous steps.
6. Use one of the two programming methods described above.

### Code scanning

To use this method:

1. Repeatedly tap the top part of the CHANNEL (CH) button.
2. Continue to step through the codes until the component turns off, indicating you have found the correct component code. If you accidentally pass a code that responds or realize you may not have been aiming the remote control at the component, tap the lower part of the CHANNEL (CH) button to step backward through the codes.
3. Press the remote control POWER button to verify the proper code by turning the device on and off.
4. Press the device button (in this example, TV) again to lock in the code.

### Code Entry

To use this method:

1. Find the three-digit code or codes for the type and brand of the component you want to control (in this example, TV). Refer to section 4-4.
2. If several codes are listed, you may have to try some or all of them. After entering a code, press the remote control's POWER button to test it. The correct code turns the device on and off.
3. Press the device (DVD, VCR, AUX, TV, SAT) button again to lock the code.



## 4-4. Control codes

### TV Codes

Brands	Codes	Brands	Codes	Brands	Codes	Brands	Codes
Admiral	072 081 096 160 161	Fisher	007 057	MGA	004 024 024 028 042	Sears	004 007 015 028 030
Aiko	103	Fujitsu	028 198 210 211		070		052 057 082 094 143
Akai	070 146	Funai	028 043 052	Midland	073		160 164 167
Alaron	028	Futuretech	043	Minerva	088	Seleco	200
A Mark	112 143	GE	004 008 009 034 056	Minutz	008	Semivox	043
America Action	043		070 073 074 081 120	Mitsubishi	004 024 028 040 042	Semp	015
Amstrad	052		130 145 155 160 165		081 146 214	Sharp	004 014 019 022 028
Anam	043 054 056 080 112		161 167	Motorola	081		081 143
AOC	004 058 070 112	Gibraltar	004 073	MTC	070 004 062 101	Siemens	088
Audiovox	043 076 103 120	Goldstar/LG	004 106 110 112 119	Multitech	043	Signature	072
Baysonic	043		127 143 193	NAD	015 025	Sony	001 079 126
Bell&Howell	072	Gradiente	004 038 106	NEC	004 016 019 024 040	Soundesign	003 004 028 043
Blaupunkt	088	Grunpy	028 043		056 070 130 134	Spectricon	112
Bradford	043	Hall Mark	004	Nikei	043	Squareview	052
Brooksonic	096	Harley Davidson	028	Nikko	103	SSS	004 043
Cairn	206	Harvard	043	NTC	103	Starlight	043
Candle	002 003 004 070	Hitachi	004 007 009 010 011	Onking	043	Supre Macy	002
Capehart	058		012 023 072 075 143	Onwa	043	Supreme	001
Carver	164		158	Optimus	080	Sylvania	003 044 059 060 063
CCE	001 004 024	Harman	164	Optonica	019 081		064 070 127 160 164
Celebrity	001	Infinity	164	Orion	028 096 201 202 203	Symphonics	194 052
Cetronic	043	Inteq	073		204 205	Tandy	081
Cineral	103 120	JBL	164	Panasonic	034 056 080 164 212	Tatung	056 062
Citizen	002 003 004 043 070	JCB	001	Philco	003 004 024 056 059	Technics	034 080
	101 103 143	JCPenney	004 008 009 024 030		060 063 064 070 164	Technol Ace	028
Classic	043		065 070 101 143 156	Philips	164 093 038 005 059	Techwood	004
Concerto	004	Jensen	013		127 070 003 004 213	Teknika	002 003 004 024 028
Contec	043 050 051	JVC	001 034 038 083 199	Pioneer	025 070 004 018 023		043 072 101 103 143
Coronado	143		208		190		164
Craig	043 054 191	KEC	043	Portland	004 143 065 103	Telerent	072
Crosley	164	Kenwood	001 070	Prism	034	Tera	173
Crown	043 143	Kloss	002 059	Proscan	160 161 167 145 065	TMK	004
Curtis	004 011 070 072 081	KMC	143	Proton	004 058 112 143 171	TNCI	073
	101 120 143 164	KTV	043 070 143 154		173	Toshiba	015 030 007 040 062
CXC	043	Lodgenet	072	Quasar	034 056 080 164		101
Daewoo	004 016 043 044 076	Loewe	209 211	Radio	Shack 004 019 043 127	Universal	008 009
	103 114 120 127 128	Logik	072		143	Video Concepts	146
	136 143 192	Luxman	004	RCA	160 161 156 165 065	Vidikron	164
Daytron	004 143		007 015 052 081 160		070 004 023 024 056	Vidtech	004
Denon	011	LXI	164		074 081 152 167 145	Wards	004 008 009 019 028
Dumont	004 073		007 015 052 081 160	Realistic	007 019 043 047		060 061 063 064 072
Dynasty	043	Magnavox	003 004 022 059 060	Runco	073 130		074 143 164 165
Dynatech	062		061 063 064 070 094	Sampo	004 070 058 207	Westinghouse	120 076
Electroband	001		127 160 164	Samsung	101 004 050 089 105	Yamaha	004 070
Electrohome	024 076 120 143	Majestic	072		160 127 143 133 215	York	004
Emerson	004 005 028 043 047	Marantz	070 164	Sansei	120	Yupiteru	043
	048 050 051 070 076	Matsui	164	Sansui	096	Zenith	011 072 073 095 096
	096 120 143 151 153	Matsushita	080	Sanyo	007 020 053 057 082		103
	154 155 191	Megatron-Memorex	004 007 028 072 096	Scotch	004	Zonda	112
		Metz	088	Scott	004 028 043 048 143		

# 4. FRONT PANEL AND REMOTE CONTROL

## 4-4. Control codes

### VCR Codes

Brands	Codes	Brands	Codes	Brands	Codes	Brands	Codes
Admiral	025 053	GE	031 040 053 063 072 107 109 126 144 147 151 156	Motorola	031 053	Scott	017 037 044 112 129 131 159
Adventura	034			MTC	034 040	Sears	001 003 008 009 010 014 017 031 034 081 101
Aiko	117	GO Video	040 132 136	Multitech	024 034	Sharp	031 054 053 143
Aiwa	034 101	Goldstar/LG	001 101 012 114 123	NEC	012 023 039 043 048	Shintom	024
Akai	016 043 046 124 125 146	Harley Davidson	034	Nikko	101	Shogun	040
American Action	117	Harman Kardon	012 045	Noblex	040	Signature	034
American High	031	Harwood	024	Nordmende	043	Singer	024
Ampro	072	Hitachi	001 026 034 063 137 150 156	Olympus	031	Sony	003 031 032 034 052 056 057 058 155
Anam	031	Hughes	001	Optimus	053 101	Soundesign	034
Asha	040	HQ	034	Optonica	053 054	STS	001
Audio Dynamics	012 023 039 043	Instantreplay	031	Orion	025	Sylvania	031 034 059 067
Audiovox	101	JCL	031	Panasonic	031 066 070 133 160 161	Symphonic	034
Beaumarck	040	JCPenney	001 012 031 040 066 101 156	Pentax	001 031 063 156	Tandy	010 034
Broksonic	025 035 037 044 129 152	Jensen	043	Philco	025 031 034 067	Tatung	023 039 043
Calix	101	JVC	048 050 043 130 060 012 031 150 055 158	Philips	031 034 054 067 071 101	Teac	023 034 039 043
Canon	028 031	KEC	101 117	Pilot	101	Technics	031 070
Capehart	108	Kenwood	014 023 034 047 048	Pioneer	001 021 048		
CCE	024 117	KLH	024	Portland	108	<b>Brands</b>	<b>Codes</b>
Cineral	117	Kodak	031 101	Profitronic	040	Teknica	031 019 034 101
Citizen	101 117	Lloyd	034	Protec	024	Thomas	034
Colt	024 Craig 003 024 101 040 135	Logik	024	Quartz	002 014	TMK	040
Curtis Mathes	031 041 156	LXI	034 003 009 017 101	Quasar	031 066 070 133 160 161	To shiba	001 008 042 047 059 082 112 131
Cybernex	040	Magin	040	Radio Shack	034 123	Totevision	040 101
Daewoo	005 007 010 065 108 110 112 116 117 119	Magnasonic	117	Radix	101	Unitech	040
Daytron	108	Magnavox	067 031 034 041 064 068 154 160	Randex	101	Vector Research	012
DBX	012 023 039 043	Marantz	012 023 031 067 069	RCA	001 031 034 040 041 053 107 109 140 144 147 151 156	Video	012 034 046
Dimensia	156	Marta	101	Realistic	003 008 010 014 031 034 040 053 054 101	Videosonic	040
Dynatech	034 053	Matsui	027 030	Rico	058 078	Wards	001 003 017 024 031 034 040 053 054 131
Electrohome	059 101	Matsushita	031	Salora	014	Westinghouse	024 025
Electrohome	101	MEI	031	Samsung	032 040 102 104 107 109 112 113 115 120 122 125 159	XR-1000	024 031 034
Emerson	006 017 025 027 029 031 034 035 036 037 044 046 101 117 129 131 138 152 153 157	Memorex	003 010 014 025 031 034 040 053 072 101 102 134 139	Sanky	053	Yamaha	012 034 039 043
Fisher	003 008 009 010	MGA	045 046 059	Sansui	022 025 034 043 048 135	Zenith	025 034 048 056 058 072 080 101
Fuji	031	MGN Technology	040	Sanyo	003 010 007 014 040 102 134		
Funai	034	Minolta	001 156				
Garrard	034	Mitsubishi	001 045 046 053 059 061 162				

## 4-4. Control codes

### AUX (AUDIO)

Brands	Codes	Brands	Codes	Brands	Codes	Brands	Codes
Adcom	146 149 227 244	GE	123 216	MCS	178	Sanyo	129 157
AMC	083 084	Harmon	073 195 248 249	Mitsubishi	253	Samsung	068
Arcam	100	Haitai	119	Meridian	013 067	Scott	180 190
Audio File	093 098	Hitachi	088	NAD	128	Sharp	096 125 151 161 169
Audio Technica	221	JCPenney	109 154 178	Nakamichi	072 212 234 235		182 193
Aiwa	111 114 117 156 170	Jensen	099	Niles	236	Sherwood	089 127
	199 203 219 231 241	Jerrold	141	Onkyo	094 115 116 209 211	Sony	097 117 147 183 188
	254	JVC	112 198 252		255		192 200 237 238 253
Akal	181 233	Kenwood	096 104 119 125 148	Optimus	121 125 140 181	Soundstream	197
Anam	180		151 163 171 173 242	Panasonic	131 144 187 200	Starcom	141
Bose	064 137 219	Krell	223	Parasound	085 086 090	Symphonic	124
B & K	150 152	Lexicon	215 250	Philips	126 136 186 197	Teac	062 102 159 180
Carver	013 098 107 126 129	Luxman	066 120 205 229	Pioneer	081 093 138 165 189	Technics	131 165 184 187 200
	160 163 220 245 249	LXI	123 177		195 230 243		202 208
Clarion	151 169	Magnavox	126 162 185 186 224	Quasar	131 187	To shiba	175
Denon	101 133 191 202 208		228	RCA	109 166 213	Wards	163
	246 247	Marantz	074 105 126 128 139	Realistic	103 122 123 124 172	Yamaha	092 120 125 166 169
Englighten ed Audio	078 153		155 162 186 232		174 177 179 180 194		216 240
Fisher	107 129 157 163 176	McIntosh	251	Rotel	204 218 239	Zenith	061 222
Fosgate	228 248	Mondial	069 225	Sansui	075 126 139 196 197		
					214		

### AUX (CATV)

Brands	Codes	Brands	Codes	Brands	Codes	Brands	Codes
Hamlin	015 017 022	Oak	008 016 023	Scientific Atlanta	002 006 013	Zenith	004
Jerrold/G.I	010 021 025	Pioneer	007 026 027	TOCOM	003		

### DVD player

Brands	Codes	Brands	Codes	Brands	Codes	Brands	Codes
Alpine	009	Hitachi	011	Onkyo	207	Sharp	004
Apex Digital	075 076	Hiteker	076	Optimus	034	Sony	037 080
Arcam	065	JVC	031	Panasonic	003 039	Technics	003
Cyberhome	087	Kenwood	070	Philips	006 007 038 042 063	Theta Digital	034
Daewoo	087	Magnavox	008 038 042	Pioneer	005 010 034	To shiba	001 038 082 091 206
Denon	030 226	Marantz	006 007	Proceed	002	Yamaha	039 079
GE	035 036	McIntosh	071	RCA	035 036	Zenith	028 041
Goldstar/ LG	028 041	Mitsubishi	032	Samsung	029 040 095		
Harmon Kardon	217	NAD	077	Proscan	035 036		

### DVD-Laser Disc Player

Brands	Codes	Brands	Codes	Brands	Codes	Brands	Codes
California Audio	047	Mitsubishi	057	Quasar	047	Technics	047 051 054
Denon	043 044	NAD	057	RCA	046	To shiba	060
Fisher	047	Panasonic	047 051 054	Sharp	060	Yamaha	045 059
Kenwood	060	Philips	048	Sony	050 053		
Magnavox	048 057	Pioneer	055 057	Sanyo	052		

## 5. INITIAL SETUP

**IMPORTANT:** Check your TV owner's manual for the preferred or required video format. The appropriate format should be set using the **FORMAT** button on the front panel of the DIRECTV® HD Receiver. If the correct format is not selected, the on-screen display and video may not appear correctly or may not appear at all. If an image does not appear, check the Format setting (see section 2-3).

When you turn on the DIRECTV® HD Receiver for the first time, you will be asked if you want to set up DIRECTV® programming.

If you have chosen to subscribe to DIRECTV programming, you should initialize the system according to section 8-7. (See section 8-7 if applicable.)

If you do not have a dish, you should select "NO". This means you can receive only off-air and cable broadcasts (analog & digital).

Although this setup process will be displayed only once, you can change your selection at any time in the future using the DIRECTV Initial setup menu.

If you have chosen to subscribe to DIRECTV service, you should contact DIRECTV at 1-800-DIRECTV (or 1-800-347-3288) and order programming.

When you order programming, you need to know your access card number. To get this number, press **MENU** on the remote control, then select SYSTEM on the Menu. Select System Test on the screen, and you will see the Access Card Identifier. Another way to find the number is by taking out the access card and referring to the number printed on it.



# 6. BASIC OPERATION

## 6-1. Viewing the Channel Banner

The Channel Banner appears whenever you tune to a new channel or press the **INFO** button on the remote control while viewing a program. It displays channel and program information in the banner shown at the top of the screen. To remove the banner, press **INFO** again, **EXIT** or wait for 10 seconds.

The icons in the Channel Banner represent the status or availability of important features. The icons will be highlighted when the feature is active or available as provided by the broadcaster and service provider. The information available on the Channel Banner is described below.

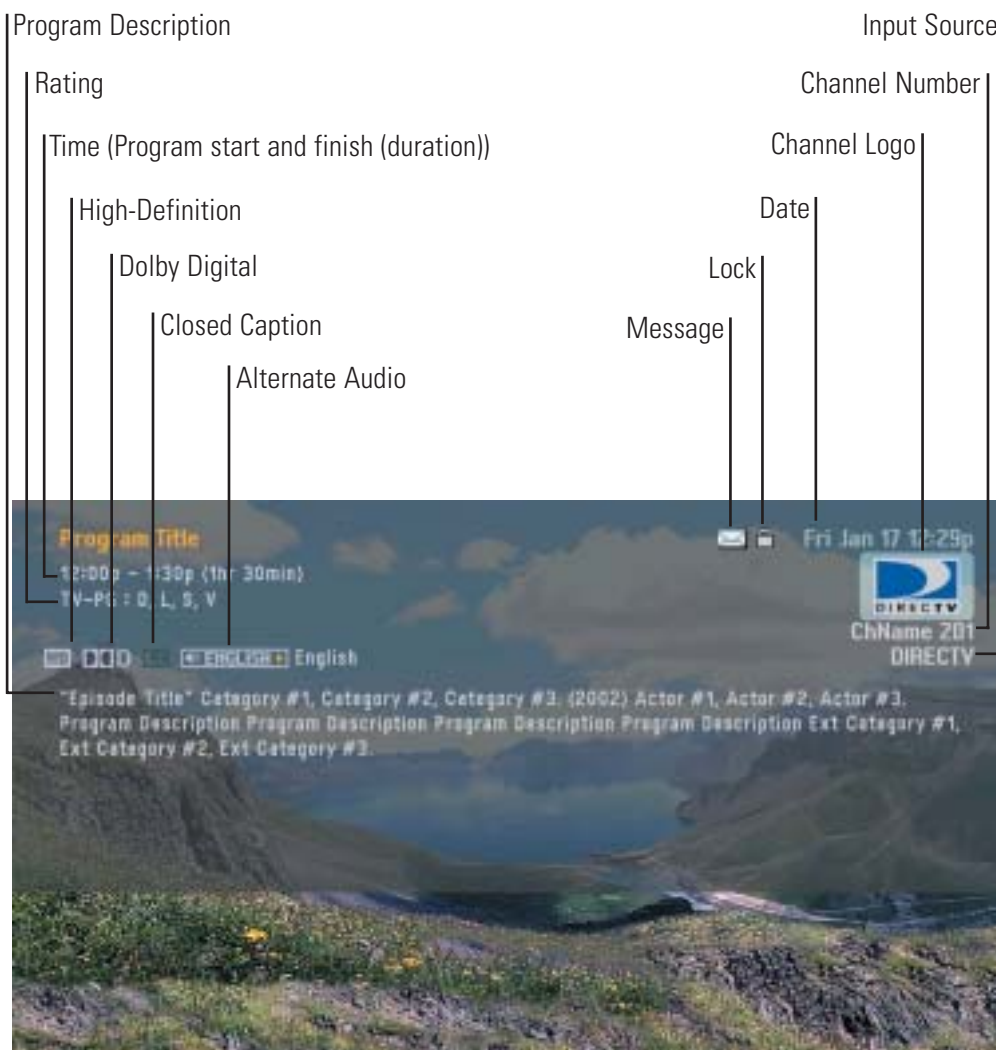

# 6. BASIC OPERATION

## 6-1. Viewing the Channel Banner

### **Input Source Icon (DIRECTV)**

Indicates from which source the current program signal is being received. The DIRECTV® HD Receiver can receive a signal from ANT, ANT/Digital, CABLE or DIRECTV.

### **Lock Icon ( )**

Indicates that the parental or spending limit lock system is activated (see section 8-19).

### **Alternate Audio ( / )\***

DIRECTV and digital channels sometimes provide multiple audio tracks, often in a different language. When multiple audio tracks are available, the Alternate Audio icon changes its appearance to indicate that you can select one of those audio setups with “◀▶” buttons.

### **Message Icon ( )**

Indicates that your DIRECTV HD Receiver has messages from DIRECTV. The message icon will appear in the channel banner to indicate that a new message has arrived or there are unread messages in the box.

### **HD Icon ( )\***

Indicates that the current program is broadcast in the HD format.

### **Dolby Digital Icon ( )\***

Indicates that the currently selected audio track is Dolby Digital® audio and may contain up to 5.1 channels depending on the broadcast.

### **CC Icon ( )\***

Indicates that the current program contains the closed caption data service.

### **Channel Logo**

Displays the logo of the current satellite channel. If a channel logo is not available, the channel name will be displayed instead.

### **Channel Number**

Displays the current channel number.

### **Start and End Time\***

Displays the start time and end time of the current program.

### **Rating\***

Displays the rating of the current program.

### **Date**

Displays the current date and time.

### **Program Description\***

Displays a brief description of the current program (if available).

### **Category\***

Displays the genre of the current program.

\* Items are based on information provided by the broadcaster or service provider. Occasionally incorrect information may be provided. For example, a service such as “HD” may be available even if the icon is not highlighted, or a service such as “Alternate Audio” may not be available even if the Icon is highlighted.

## 6-2. Channel Surfing

The surf list appears on the TV screen when you press the **SURF** button on the remote control. It enables you to surf up to 50 favorite channels that were chosen in the Edit Channel section of the Setup menu or directly added in the SURF guide as described below. The surf list consists of the channel logos or channel numbers. If the logo of a certain channel is not available, the channel number is displayed instead.

You are also able to add or delete the logo of a channel on the surf list by pressing the **INFO** button on the remote. A dialog box will ask what you want to do with the highlighted logo area: you can replace the highlighted logo area with the current channel, or delete it.

You can easily move the highlight on the surf list using “▲▼◀▶” on the remote control. The next page is accessible by using **PAGE ▲/▼** button on the remote. You can tune to a favorite channel by pressing “⊙”. Or the **EXIT** button on the remote will clear the surf list and take you back to the current channel.



Scroll Bar

# 6. BASIC OPERATION

## 6-3. Freeze Screen

Pressing the **FREEZE** button freezes the current image. Pressing the **FREEZE** button again enlarges the image. The image can then be scanned vertically and horizontally. Pressing the **FREEZE** button once again returns the image to live video.

### FREEZE Mode Screen



### Multi-Freeze Mode Screen



#### NOTE

The Multi-Freeze mode is only available for digital channels.



## **6-4. Subscription to DIRECTV® programming and ANT/CABLE-Only operation**

The DIRECTV® HD Receiver is designed to receive signals from DIRECTV, ANT and/or CABLE sources. If you are a DIRECTV customer, you can enjoy programming provided by DIRECTV.

You can also receive the analog and digital over-the-air broadcasts, with the benefit of the Advanced Program Guide™ which is an integrated electronic program guide. The Advanced Program Guide provides program listings and information on analog and digital channels from over-the-air local stations as well as DIRECTV channels. You can easily navigate and tune to hundreds of channels from various signal sources with the Advanced Program Guide.

If you don't subscribe to DIRECTV® programming, however, the function of the DIRECTV HD Receiver will be limited to receiving signals only from ANT and/or CABLE. You can still enjoy HD services provided by over-the-air digital broadcast along with the conventional analog broadcast. Without the DIRECTV service, however, no electronic program guide is available.

# 7. ADVANCED PROGRAM GUIDE™

## 7-1. About the Advanced Program Guide™

The DIRECTV Advanced Program Guide™, contains schedule and program information for all DIRECTV® channels. The Advanced Program Guide also provides local over-the-air channels information including both conventional analog and digital channels if you receive satellite service.

Helping you to find a program easily and conveniently, the Advanced Program Guide allows you to view schedule and descriptive program information for the channels. The receiver offers 10 different channel lists: ALL, CUSTOM, SURF and CATEGORY (MOVIES, SPORTS, SPECIALS, SERIES, NEWS, MY CATEGORY 1 and MY CATEGORY 2). You may edit the CUSTOM and SURF channel lists to customize and design your favorite channels, respectively. In addition, you can easily find specific programs by using the CATEGORY search or KEYWORD search functions. An explanation of each channel list is described in Section 7-2.

You can display or exit the Advanced Program Guide in several ways.

### **To display the Advanced Program Guide:**

- Press the **GUIDE** button on your remote control.

or

- Press the **MENU** button on the remote control and select the DIRECTV menu. Several options will appear. Choose the Guide option (MENU → DIRECTV → Guide).

### **To exit the Advanced Program Guide:**

- Press the **EXIT** button to return to the last channel you were tuned to.

or

- When any currently broadcasted program is highlighted, pressing “⊙” will make the guide screen disappear and tune to that channel.

### **In the Advanced Program Guide, you can also show or hide the Guide menu.**

#### **To show or hide the Guide menu:**

- Press the **GUIDE** button on your remote control in the Advanced Program Guide. The panels on the left disappear and you can see the Guide menu. The first press shows the Guide menu at the far left. Pressing the button a second time makes the Guide menu disappear.

## 7-2. Layout of the Advanced Program Guide™ Screen

The on-screen guide maintains ten different channel lists, each of which shows you only those channels and programs that belong to that channel list. The meaning and generation of each channel list is described below

Note: When viewing the Program Guide, press the **GUIDE** button on the remote control to view the items below in the Guide menu (see section 7-1).

### ALL

As the default guide type when pressing the GUIDE button, the ALL category shows program listings for all channels to which you may subscribe. The guide shows DIRECTV® channels that your dish antenna can receive, and over-the-air channels that you have selected to add into the channel list during the initial setup procedure. Program details for non-satellite channels may not be available depending on the satellite service provider.

### CUSTOM

Shows the program listings that belong to the CUSTOM channel list. You can customize the CUSTOM channel list by hiding channels from the All Channel List that you do not wish to view (see section 8-8).

### SURF

Shows program listings only for those channels in the SURF channel list. You can generate a SURF channel list, which is a short list of channels you tune to most frequently, by setting a favorite icon to the channels from the menu sequence MENU → SETUP → Surf List/Ch. Edit (see section 8-8).

### CATEGORY (MOVIES/SPORTS/SPECIALS/SERIES/NEWS)

Lists only Movies/Sports/Specials/Series/News programs from channels in the All channel list. The DIRECTV® HD Receiver generates the list automatically based on the category information for programs appearing within the next few hours in the Advanced Program Guide™.

### MY CATEGORY 1/ MY CATEGORY 2

Shows only user-defined programs. You can edit MY CATEGORY 1, MY CATEGORY 2 list from the menu sequence Guide → My Category → EDIT (see section 7-8).



# 7. ADVANCED PROGRAM GUIDE™

## 7-2. Layout of the Advanced Program Guide™ Screen

The guide screen also provides two search menus:

### Category

Searches for programs that belong to a given category. The DIRECTV HD Receiver first shows you currently applicable categories and allows you to search for programs in that category (see section 7-8).

### Keyword

Searches for programs that have or are related to a specific keyword. You can choose a keyword for program titles or credit titles (for example, actor/actress, director, writer, awards, etc.) (see section 7-9).

When accessing an on-screen guide, you will always return to the guide menu, one of the 10 channel lists or one of the two search menus, that you have previously viewed.



### NOTE

After first installing satellite service, it may take several hours before all program information is fully available in the Advanced Program Guide™.

## 7-3. Moving through the Advanced Program Guide™

The Advanced Program Guide™ is operated based on a simple and straightforward “Highlight and Select” process.

1. Use “▲▼◀▶” on your remote control to navigate the guide screen.
2. Press “⊙” to select or execute the highlighted menu or function.

The on-screen guide shows you program listings for six channels within a one and one half hour time slot, for example: 6:00-7:30. In order to view a list of future programs or other channels, you may continuously press “▲▼◀▶” to scroll horizontally or vertically. This may take a while to reach a specific channel or program, if the channel or program is listed far from the currently highlighted program. The Advanced Program Guide thus offers you shortcuts to minimize your effort in navigating channels and time slots.

### Line Scrolling

You can reach other time slots or channels that are currently hidden from the screen using the arrow buttons “▲▼◀▶”. Move horizontally to reach other time slots and move vertically to reach other channels.

### Page Scrolling

You can move through channels faster by scrolling page-by-page with the **PAGE ▼/▲** buttons on the remote control. Each button stroke scrolls one page up or down.

### Date Scrolling

Pressing the **CC** button on the remote control to jump to the Date Change Box. Alternatively, you can move the highlight to the Date Change Box and change the date to jump to the time slot of that day. Pressing “◀◀” button will show you a previous 6 hours guide.

#### NOTE

Press the **GUIDE** button to return immediately to the guide menus, the left-most column of the guide screen. This is very useful when the highlight is located far from the current time and you want to return to the guide menus.

# 7. ADVANCED PROGRAM GUIDE™

## 7-3. Moving through the Advanced Program Guide™

### Direct Jumping

You can quickly jump to a page that contains a specific channel by directly entering a channel number using the digit buttons “0-9” on the remote control.

Pressing “⊙” following the digit button strokes will move to the channel immediately.

### Picture In Guide view

You can preview the highlighted channel in the Picture In Guide at left-top window.

You can also quickly jump to a Picture In Guide window by pressing the **PREV CH** button on the remote control. This press moves the highlight to the Picture In Guide at the left-top. Pressing the **CH ▲/▼** button takes you to another TV channel. Pressing the ‘⊙’ button returns you to TV viewing.



### NOTE

Press the **GUIDE** button to return immediately to the guide menus, the left-most column of the guide screen. This is very useful when the highlight is located far from the current time and you want to return to the guide menus.

## 7-4. Selecting a Program

The top region of the guide screen displays the schedule and program information of the currently highlighted program. You can also see other detailed information about the program by pressing the **INFO** button.

When you select the highlighted program by pressing "⊙", what happens or appears next depends on whether the highlighted program is currently on-air or scheduled in the future, and whether or not it is a pay-per-view program.

### **Current Program / non Pay-Per-View**

If the selected program is a current program and not one of the PPV programs, you will tune directly to the program.

### **Current Program / DIRECTV® Pay-Per-View**

If the selected program is a current pay per view program, you will be asked if you want to purchase this program.

### **Future Program / non Pay-Per-View**

If the selected program is scheduled in the future and is not a PPV, you will be offered a dialog box that enables you to reserve this program for watching. If you select Timer option in the Guide menu, this program is put on the Timer/Record List and you will be reminded by a message at the bottom of the screen 10 seconds before its airing time.

### **Future Program / DIRECTV® Pay-Per-View**

If the selected program is a pay-per-view program scheduled in the future, you will also be asked if you want to purchase this program. Once you confirm the purchase, this program is put on the Purchase list. You can view the Purchase list from the menu sequence Menu → DIRECTV → Purchase List and cancel any purchase on the list anytime before its airing time.

A continuous connection to a land-based phone line is required to perform this function with your remote control.

(Note: Pay-per-view programs can only be purchased within the 24 hours of the program times.)

# 7. ADVANCED PROGRAM GUIDE™

## 7-5. Getting More Program Information

Pressing the **INFO** button will display available additional information about the highlighted program. Depending on the broadcaster and service provider, information may include actor and role relationships, original material, production studio, the date on which the program was first shown, and so on.

### To display program details:

1. Move the highlight to a desired program using “▲▼◀▶” on the remote control.
2. Press the **INFO** button on the remote control to display the available additional information.



3. To move the highlight to the left menu bar, press “◀” on remote control. To return to the additional information box, press “▶”.
4. To view this TV program, move the highlight to the left menu bar, move the highlight to the “View” menu, located on the left side of the additional information box, and press “⊙”.





## 7-5. Getting More Program Information

5. If you want to check any other broadcasting schedules for this same program, move the highlight to the “Showings” menu, located on the left side of the additional information box, and press “⊙”.



6. To return to the previous guide screen, Move the highlight to the “Back” menu, located on the left side of the additional information box, and press “⊙”.



# 7. ADVANCED PROGRAM GUIDE™

## 7-6. Setting a Timer/Record Event for Future Viewing

If you want to view a program scheduled in the future, you can put that program on the Timer/Record List so that program will be automatically tuned.

A timer event will automatically tune to the selected channel at the specified time. A Record event will also turn on the DIRECTV® HD Receiver if it is turned off and will automatically control your VCR to record the program; if the VCR Controller is correctly set up (see sections 3-6 and 8-23).

Timer/Record Events may also be manually set through the menu (see section 8-5).

### To schedule a future viewing :

1. Move the highlight to a future program you want to watch using “▲▼◀▶” on the remote control.
2. Press the “⊙” button on the remote control to display the available additional information.
3. Pressing “◀” will move the highlight to the “Timer” menu, located on the left side of the additional information box, then press “⊙”.
4. A dialog box will appear for your review.
5. Move the highlight to the “OK” option in the dialog box and press “⊙” to confirm.



### NOTE

A reminder message will appear at the bottom of the screen 10 seconds before the reserved program actually starts. The receiver will automatically tune to the program if you do not cancel it.

Pay per view programs can only be purchased within 24 hours of the program times.

6. The program name will be preceded by the Timer mark. If you want to cancel any reservation, execute the menu sequence MENU → DIRECTV → Timer/Record List and press “⊙” when the highlight is on the reservation.

## 7-7. Purchasing DIRECTV® Pay Per View Programs

If you subscribe to DIRECTV® programming, you may preview pay per view movies on channel 200, the DIRECTV promo channel, to determine if you would like to purchase them.

### To purchase Pay Per View (PPV) programs:

1. From the program guide, press **INFO** button to see detailed information about the selected program. If this program is a pay per view program, the "PURCHASE" menu will be appear at left-menu. Selecting the "PURCHASE" menu will show you the dialog box.
2. Move the highlight to the right to "Buy" in the dialog box and press "⊙".  
Another pop-up box will be displayed to verify your purchase.  
(A continuous connection to a land based phone line is required to order PPV with your remote control.)



# 7. ADVANCED PROGRAM GUIDE™

## 7-8. Searching for Programs by Category

You can search for specific programs by categories. The category information of each program is provided by the Advanced Program Guide™ so that you can choose one of them to search for matching programs. You can also set a search range of One Day or One Week. In the search result one program may have multiple showings on different channels and/or at different time slots.

Note : You can also specify an user-defined category using "MY CATEGORY".

### To search programs by Category :

1. While viewing the Program Guide, press the **GUIDE** button on the remote control to view the Guide menu.
2. Highlight the SEARCH in the guide menu. Pressing "⊙" will show search sub-menu. Select Category sub-menu and press "⊙". The Category Search screen consist of two columns: the first column from the left shows the category names, and the right column lists programs resulting from a category search.
3. Move the highlight to the category column. If a category has a sub-category, the arrow (▶) mark will be displayed at the left side. Pressing "⊙" will move to the sub-category list. When the highlight is on the selected category name, pressing "⊙" will move the highlight to 'Search' button. Pressing "⊙" again will start the search process.
4. Programs resulting from the search will be listed in the right column. The highlight goes to the top program on the list and its program information will be displayed at the top region of the guide screen. You can see program information on each program by moving the highlight using "▲▼".
5. In the result column, pressing "▲" will move the highlight to the top-most tab. You can select one of the tab menus (Program, Channel and Adver. tab ). Selecting Program tab will show searched programs, selecting the Channel tab will show searched Channels and the Adver. tab selection will show searched Advertisements.  
(Note : If the result list is too big and it is difficult to navigate the list, press **SURF** button on the remote control. It will show the 'Quick Jump' pop-up box, and is easy to move to some location within the total list.)
6. If you choose a program and press "⊙", the detailed information screen will be displayed.



## 7-8. Searching for Programs by Category

When you search for programs by category, you can also use the user-defined "MY CATEGORY" feature. You may specify two user-defined categories. One is the "MY CATEGORY1" and the other is the "MY CATEGORY2". These categories can also be modified in the EDIT menu (in the guide menu->My CATEGORY->EDIT).

Note : You can also specify an user-defined category using "MY CATEGORY".

### To search programs by MY CATEGORY :

1. While viewing the Program Guide, press the GUIDE button on the remote control to view the Guide menu.
2. Highlight the MY CATEGORY in the guide menu. Pressing "⊙" will show search sub-menu. Select EDIT sub-menu and press "⊙". The My Category Edit screen consist of two columns: the first column from the left shows the category names, and the right column shows the selected category name.
3. Select the MY CATEGORY1 or MY CATEGORY2 using "◀▶". And move the highlight to the category column. If a category has sub-category, the arrow (▶) mark will be displayed at the left side. Pressing "⊙" will move to the sub-category list. When the highlight is on the selected category name, pressing "⊙" will move the highlight to 'Save' button. Pressing "⊙" again will modify the "MY CATEGORY1" or the "MY CATEGORY2".
4. If you select the "MY CATEGORY1" or the "MY CATEGORY2", the guide screen will list only user-defined programs in the All channel list.



# 7. ADVANCED PROGRAM GUIDE™

## 7-9. Searching for Programs by Keyword

You can also search for programs by keywords which can be found in program titles or credit titles such as actor/actress name, director name, etc.

### To search programs by keyword:

1. While viewing the Program Guide, press the **GUIDE** button on the remote control to view the Guide menu.
2. Highlight SEARCH in the guide menu. Pressing "⊙" will show the search sub-menu. Select the Keyword sub-menu and press "⊙". The Keyword Search screen consists of two columns: the first column from the left is the key input box, and the right column lists programs found from a keyword search.
3. Enter a word using the on screen keyboard. Highlight the first letter and press "⊙" to type it in.
4. While entering a word, the '**Candidate**' pop-up box will show eight candidate keywords. Press 0-9 button on the remote control to enter a word quickly.
5. When a word is complete or even when only a partial word is typed in, you may move the highlight to the Search button with "▶", and press "⊙" start the search.
6. The programs resulting from the search will be listed in the right column. Program information will be displayed at the top region of the guide screen. You can see program information on each program by moving the highlight using "▲▼".
7. In the result column, pressing "▲" will move the highlight to the top-most tab. You can select one of tab menus(Program, Channel and Adver. tab ). Selecting Program tab will show searched programs, selecting Channel tab will show searched Channels and selecting Adver. tab will show searched Advertisements.
8. If you choose a program and press "⊙", detailed information about the program will be displayed.



# 8. CUSTOMIZATION

## 8-1. Accessing the On-screen Menu

In the menu system, there are several ways to customize the settings provided. To navigate the menu levels, you will see “⊙” or “▶” on the right side of the menu label to help you go to the next level.

### To display and exit the Menu:

Press the **MENU** button on the remote control to display the menu. A second press of the **MENU** button or a press of the **EXIT** button will take you back to TV viewing.

### To go to the next level:

Press “⊙” or “▶” on the remote control.

### To go back to the previous level:

Press “◀” or **MENU** button on the remote control.



# 8. CUSTOMIZATION

## 8-2. The Structure of the On-Screen Menus

---

<b>DIRECTV</b>	Guide Purchase List Mail List Timer/Record Timer/Record List Initial Setup
<b>SETUP</b>	Channel Scan Manual Ch. Add Surf List/Ch. Edit Clock Out to TV Hook-up Help
<b>AUDIO</b>	Digital Output Audio Mode Dolby Digital Audio Language
<b>PREFERENCE</b>	TV Aspect Ratio DTV Caption DTV Caption Style Closed Caption Advanced Demo
<b>LOCK</b>	Lock System Block Channel Movie Rating TV Rating – Children TV Rating – General Spending Limit
<b>SYSTEM</b>	System Info System Test Replace Card VCR Control Setup Remote Control

---



## 8-3. Managing Program Purchases

### Purchase List

Shows a history of recently purchased programs and display upcoming DIRECTV® Pay Per View purchases.

Upcoming DIRECTV® Pay Per View purchases can be canceled. You may do this by selecting the program. A pop-up screen will ask you if you want to cancel the program.

If you select a past DIRECTV® Pay Per View purchase, you can see each charge of the PPV programs purchased and shown.

### To review programs in the Purchase List:

1. Press the **MENU** button on the Remote Control to display the on-screen menu.
2. Select the DIRECTV menu by pressing “**⊙**” on the remote control.
3. Scroll down to the Purchase List using “**⊙**”.
4. Move the highlight to the right with “**⊙**” to scroll the purchase list.
5. Press “**⊙**” to return to the previous level or press the **EXIT** button on the remote control to return to TV viewing.

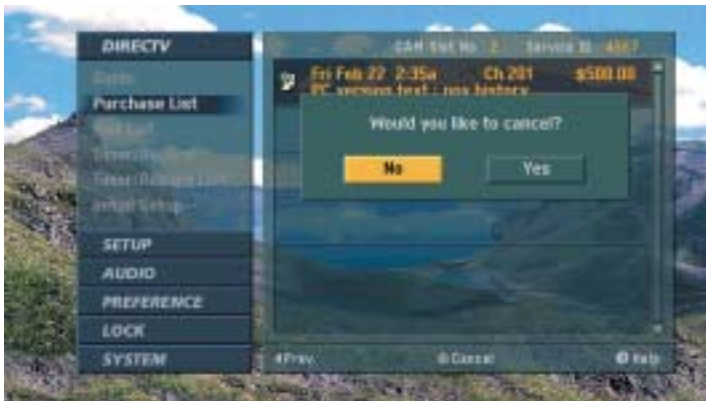

### NOTE

**CAM:** Conditional Access Module, usually referred to as the access card. A removable, electronic subassembly provides conditional access control of the subscriber terminal.

**CAM Slot No:** The CAM slot number indicates which slot the purchase occupied. A satellite service provider customer service representative may use these slot numbers to help resolve billing issues.

# 8. CUSTOMIZATION

## 8-4. Checking Messages

Allows you to view the messages that are sent from DIRECTV. For example, you may receive a message requesting your attention to a new service or special program offering.

### To check the Mail Box:

1. Press the **MENU** button on the Remote Control to display the on-screen menu.
2. Select the DIRECTV® menu by pressing “**⊙**” on the remote control.
3. Scroll down to the Mail List menu using “**▼**”.
4. Move the highlight to the right with “**▶**” to select a mail item from the list.
5. Press “**⊙**” and the full text of the mail will be displayed in the pop-up dialogue box.
6. Select “Delete” on the pop-up box if you want to delete it.
7. Press “**◀**” to return to the previous level or press the **EXIT** button on the remote control if you want to return to TV viewing.



### NOTE

The Message icon will be displayed in the Channel Banner only when at least one unread message is in the mail list.

## 8-5. Setting a Timer/Record Event

Allows you to set up a timer or record event manually. You can see the event list in the Timer/Record List menu (DIRECTV → Timer/Record List). You can also set a one time Time/Record event in the Guide (see section 7-6).

A Timer event will automatically tune to the selected channel at the selected time. A Record event will also turn on the DIRECTV® HD Receiver if it is turned off and will automatically control your VCR to record the program if the VCR Controller is correctly set up (see sections 3-6 and 8-23).

### To add a program to the Timer/Record List :

1. Press the **MENU** button on the Remote Control to display the on-screen menu.
2. Select the **DIRECTV** menu by pressing “⊙” on the remote control.
3. Scroll down to the Timer/Record menu using “▼”.
4. Press “▶” or “⊙”. The pop-up dialogue box will be displayed.
5. Select a Type option, either Timer or Record.  
Then select a Channel, Date, Time, Duration and Repeat options.
6. Pressing “⊙” will show the confirm dialogue box. Press “⊙” again.
7. After adding a program, you can check the new item in the Timer/Record List (see next page ‘8-6. Modifying a Timer/Record Event’.)
8. Press **MENU** button to return to the previous level or press the **EXIT** button on the remote control if you want to return to TV viewing.

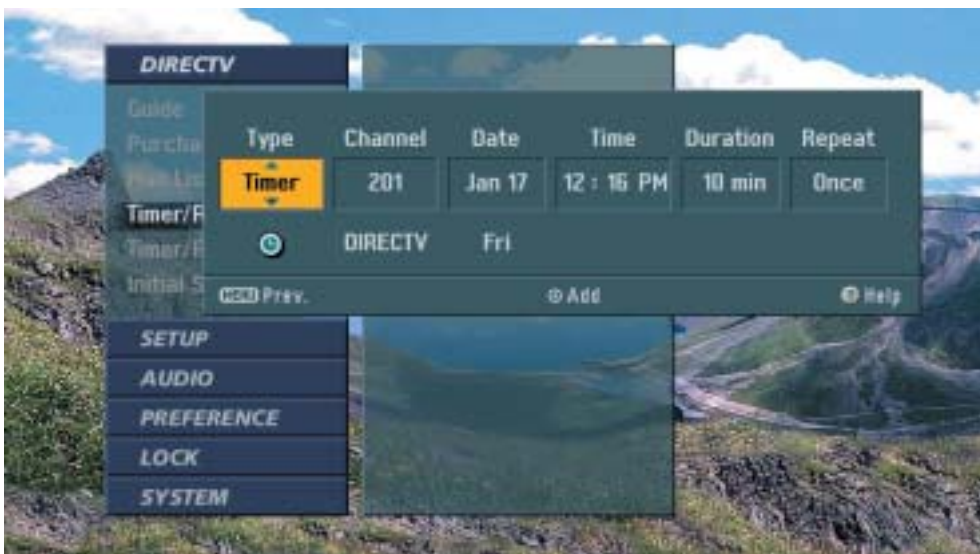

# 8. CUSTOMIZATION

## 8-6. Modifying a Timer/Record Event

The Timer/Record List shows the programs you have reserved in the Guide menu or in the Timer/Record menu. You may cancel any program in the list by selecting the program. You may also modify any event in the list that was created in the Timer/Event menu.

### To modify or delete a program in the Timer/Record List:

1. Press the **MENU** button on the Remote Control to display the on-screen menu.
2. Select the DIRECTV menu by pressing "⊙" on the remote control.
3. Scroll down to Timer/Record List using "▼".
4. Move the highlight to the right with "▶" to select a program from the list.
5. Press "⊙" and the pop-up dialogue box will be displayed.
6. Select "Delete" in the pop-up box if you want to cancel, then the highlight will return to the list.  
Or  
Select "Modify" in the pop-up box if you want to modify type, channel, date, time, duration and repeat options. The Timer/Record dialogue will appear for modification.  
(Note : If the program was reserved in the Guide menu, "Modify" can not be selected.)
7. Press "◀" to return to the previous level or press the **EXIT** button on the remote control if you want to return to TV viewing.



## 8-7. Initializing the System

### About Initial Setup

The DIRECTV® HD Receiver is capable of receiving three types of signals; ANT, CABLE and DIRECTV® programming if you are a DIRECTV customer. Initial Setup lets you initialize your system to function properly with your dish antenna.

### Setup Wizard

Provides whole sequential process from dish selection (Step 1) to channel setup (Step 5).

### Step 1. Dish Setup

As first step, you should select one of three dish setup modes ( Manual Selection/Auto Detection /No Dish ).

Manual Selection allows you to select the correct dish type among three different types available; Round Dish for Satellite Network A only, Oval Dish for Satellite Networks A and B, or Oval Dish for Satellite Networks A, B, and C. For advice on selecting a dish that will provide the services that you desire, contact DIRECTV (1-800-DIRECTV) or your local DIRECTV retail expert. If you already have a dish, refer to its user's guide to determine its type. To receive all available HD programming, you should install and select the Oval dish type (Oval dish (Sat A, B, C)).

The Auto Detection feature will help you select your dish if you are unsure of your dish type.

If you are not a DIRECTV customer and want to view programming only from Antenna/Cable, then select the No Dish Mode.



# 8. CUSTOMIZATION

## 8-7. Initializing the System

### To Select your dish type in Manual Selection:

1. Press the **MENU** button on the Remote Control to display the on-screen menu.
2. Select the DIRECTV® menu by pressing “⊙” on the remote control.
3. Scroll down to Initial Setup using “▼”.
4. Move the highlight to the right with “▶” to choose Setup Wizard.
5. Press “⊙” and the Setup Wizard menu will be displayed.
6. Select the Manual Selection option and press “⊙”.
7. In the Manual Selection screen, select your dish type using “▲▼”.
8. Press “⊙” to move to the next step of the initial setup.

### Step 2. Dish Positioning

Your Location provides the coordinates of elevation, azimuth, and tilt based upon your ZIP code. Elevation is the up/down angle of the dish. Azimuth is the side-to-side direction, while tilt is the circular rotation of the dish itself around the pointing axis. Full instructions for the installation of your dish are provided with your satellite dish antenna.

### To enter your location:

1. Enter your ZIP code using the digit buttons on the remote control.
2. Press “⊙” to show the elevation, azimuth and tilt.  
Point your dish properly with the azimuth, elevation and tilt values given.
3. Press “⊙” to move to the next step of the initial setup.



## 8-7. Initializing the System

### Step 3. Signal Strength

Depending on the Dish Type you have selected, the Signal Strength menu shows you up to three signal strength bars for Satellite Networks A, B, and C, in order to help you adjust the dish to the correct position with the elevation, azimuth, and tilt values obtained from the Your Location menu. While the maximum signal strength is 100, there will be no apparent difference in picture quality between signal strengths of 60 to 85. The higher the signal, the less likely you are to experience picture quality degradation during adverse weather conditions such as heavy rain or snow.

A transponder is a receiver/transmitter on the satellite. It receives signals from DIRECTV and retransmits them to your dish. The DIRECTV® HD Receiver is capable of displaying the signal strength of most transponders by using the following method.

#### To see the signal strength:

1. Move the highlight to select the desired satellite using “◀▶”.
2. Set an each transponder using “▲▼”
3. Press “⊙” to move to the next step of the initial setup.



#### NOTE

Depending on your location in the United States, certain transponders may not be available. It is normal for the signal strength level of a few transponders to be at zero.

#### NOTE

If you have selected an Oval Dish and SAT B and/or SAT C do not display a signal strength on any transponder, re-check your dish installation or perform Step 1: Dish Setup again.

# 8. CUSTOMIZATION

## 8-7. Initializing the System

### Step 4. Add Local Network

Adds program information for channels available over the air (terrestrial) in a selected local area as defined by the satellite service provider. You can select two distinct areas by ZIP code to view the channels being broadcast from both areas. This is useful if you live between two major broadcast centers and are capable of receiving signals from both. After this Channel Setup process, the channel list of over the air stations will be added to the guide.

#### To Add Local Network:

1. If you want to add over the air digital and analog channels to your guide, you must select "YES", then the next input screen will be displayed.  
NOTE: If you select "NO", you don't need to do the following procedure.
2. Press "⊙" if your ZIP code is correct for the primary local channels. The channel search progress will be shown.
3. If the ZIP code is missing or incorrect, select the ZIP code for your city using "▼" and pressing "⊙".
4. If you want to add secondary local channels from another area, enter a secondary ZIP code using the digit buttons on the remote control and press "⊙".
5. Repeat steps 2 to 4.
6. Press "⊙" to move to the next step of the initial setup.
7. Press "◀" to return to the previous level or press the **EXIT** button on the remote control if you want to return to TV viewing.

Note : The Add Local Network feature only adds station and program information to the guide. Depending on your location, such stations may be received by connecting an antenna to the ANT IN jack (see section 3-4).

If off-air digital and analog channel data is selected "YES", then some local analog (NTSC) and digital (ATSC) channels may appear in the GUIDE for which reception may be poor or not viewable. To hide these channels, refer to section 8-8 Managing Channels and section 7-2 Advanced Program Guide.





## 8-7. Initializing the System

### Step 5. Create Channel list

The Setup wizard will show the summary screen of the setup sequence.



The next page will create the channel list automatically.



When the Setup Wizard function is complete, press the “ $\odot$ ” button on the remote control to finish the Initial Setup.

# 8. CUSTOMIZATION

## 8-7. Initializing the System

### Dish Setup Status

Shows the dish type and up to two distinct areas by ZIP code.

#### To see the dish setup status:

1. Press the **MENU** button on the Remote Control to display the on-screen menu.
2. Select the DIRECTV® menu by pressing “**⊙**” on the remote control.
3. Scroll down to the Initial Setup using “**▼**”.
4. Move the highlight to the right with “**▶**” to select Dish Setup Status.
5. Move the highlight to Dish Setup Status and press “**⊙**”. The Dish Information dialogue box will be displayed.
6. Press “**◀**” to return to the previous menu.



## 8-7. Initializing the System

### Dish Positioning

Provides the coordinates of elevation, azimuth, and tilt based upon your ZIP code. Elevation is the up/down angle of the dish. Azimuth is the side-to-side direction, while tilt is the circular rotation of the dish itself around the pointing axis. Full instructions for the installation of your dish are provided with your satellite dish antenna.

#### To enter your location:

1. Press the **MENU** button on the Remote Control to display the on-screen menu.
2. Select the DIRECTV® menu by pressing “**⊙**” on the remote control.
3. Scroll down to Initial Setup using “**▼**”.
4. Move the highlight to the right with “**▶**” to select Dish Positioning.
5. Move the highlight to Dish Position and press “**⊙**”. The positioning dialogue box will be displayed.
6. Enter your ZIP code using the digit buttons on the remote control.
7. Press “**⊙**” to show the elevation, azimuth and tilt.  
Point your dish properly with the azimuth, elevation and tilt values given.
8. Press “**◀**” to return to the previous menu.



# 8. CUSTOMIZATION

## 8-7. Initializing the System

### Signal Strength

Depending on the Dish Type that is selected, the Signal Strength menu shows you up to three signal strength bars for Satellite Networks A, B, and C, in order to help you adjust the dish to the correct position with the elevation, azimuth, and tilt values obtained from the Your Location menu. While the maximum signal strength is 100, there will be no apparent difference in picture quality between signal strengths of 60 to 85. The higher the signal, the less likely you are to experience picture quality degradation during adverse weather conditions such as heavy rain or snow.

A transponder is a receiver/transmitter on the satellite. It receives signals from DIRECTV and retransmits them to your dish. The DIRECTV® HD Receiver is capable of displaying the signal strength of most transponders by using the following method.

#### To see the dish setup status:

1. Press the **MENU** button on the Remote Control to display the on-screen menu.
2. Select the DIRECTV® menu by pressing “**⊙**” on the remote control.
3. Scroll down to Initial Setup menu using “**▼**”.
4. Move the highlight to the right with “**▶**” to select Signal Strength.
5. When the highlight is on the Signal Strength, press “**⊙**”. The signal strength dialogue box will be displayed.
6. Move the highlight to select the desired transponder and satellite.
7. Press “**◀**” to return to previous menu.



#### NOTE

Depending on your location in the United States, certain transponders may not be available. It is normal for the signal strength level of a few transponders to be at zero.

## 8-8. Managing Channels

### Channel Scan (Channel Search)

Automatically finds all channels (both analog and digital) available through the antenna and cable inputs, and stores all the active channels in the channel list. Inactive or weak channels may not appear in the list. In that case, add missing channels manually in the Manual Ch. Add menu. The channel list created here can be seen in the Surf List/Ch. Edit menu.

#### To scan the channels:

1. Press the **MENU** button on the Remote Control to display the on-screen menu.
2. Scroll down using “▼” on the remote control.
3. Select the Setup menu by pressing “⊙”.
4. Channel Scan will be automatically highlighted.
5. Move the highlight to the right with “▶” to display the channel find box.
6. Select “Start” button and press “⊙” and the moving yellow bar will indicate the progress scanning the channels. When the scanning process begins, “Start” will change to “Next”. If you press “Next”, the scanning of the current signal source will be ignored and the scanning of the next signal source will proceed.
7. When the scanning is completed, the scanned result will be stored.
8. Press the **EXIT** button on the remote control if you want to return to TV viewing.

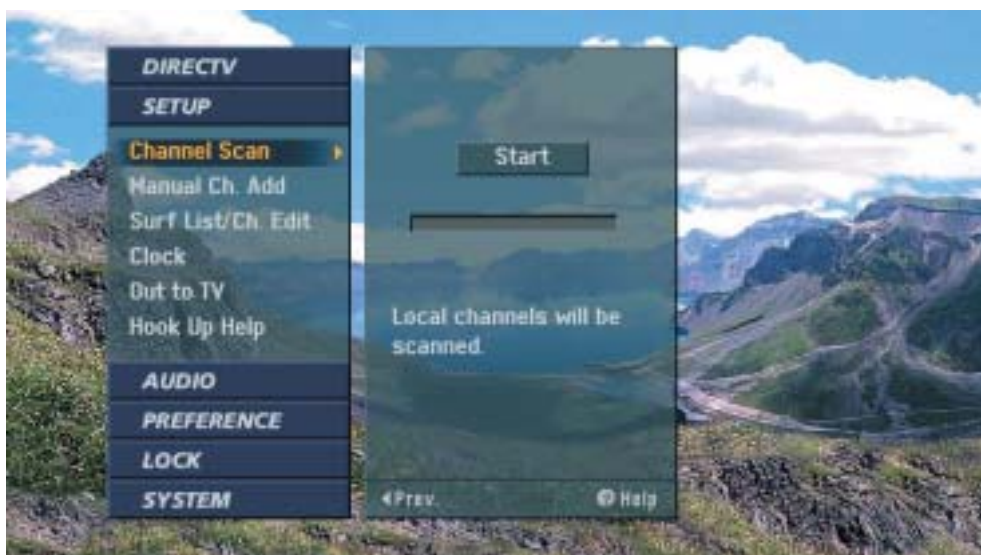

# 8. CUSTOMIZATION

## 8-8. Managing Channels

### Manual Ch. Add

Manually adds a channel to your channel list without rescanning all the channels again. Channel Scan may not pick up every channel that is available on Air and Cable. Therefore, it may be necessary for you to add channels manually using this feature.

Note :The Manual Channel Add feature is not available in ANT/CABLE mode. Use the Channel Scan and Surf List/Ch. Edit menus to add channels in the ANT/CABLE mode.

### To add the channels missed in your channel list:

1. Press the **MENU** button on the remote control to display the on-screen menu.
2. Scroll down using “▼” on the remote control.
3. Select the Setup menu by pressing “⊙”.
4. Scroll down to Manual Ch. Add using “▼”.
5. Move the highlight to the right with “▶” to display the channel add box.
6. Enter the channel number desired using the digit buttons on the remote control.
7. Press “⊙” and the pop-up box of the result will be displayed.
8. Press the **EXIT** button on the remote control to return to TV viewing.

Note : Over-the-air local digital channels (ATSC) may have different channel assignments than their analog (NTSC) broadcast counterparts.

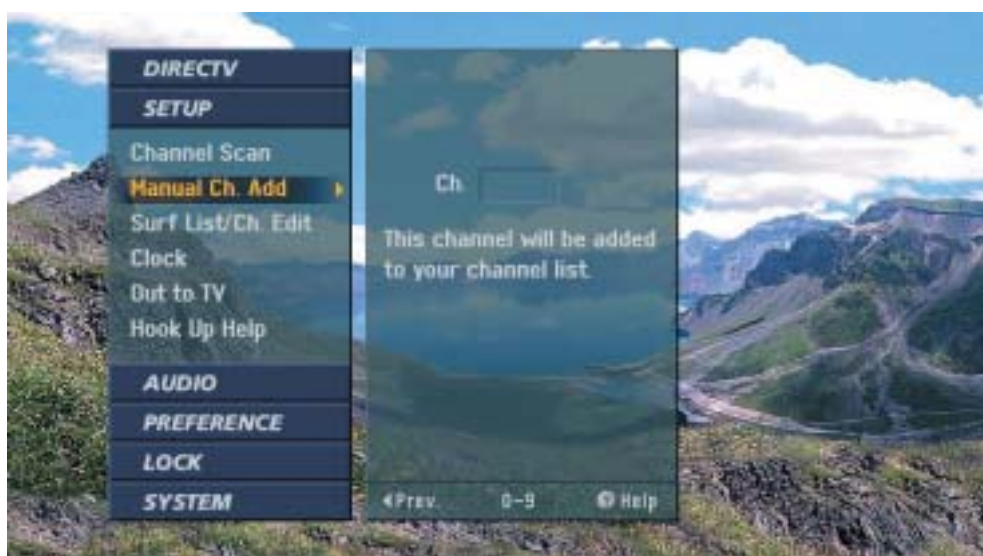

## 8-8. Managing Channels

### Surf List/Ch. Edit

The default channel list is made in the Channel Scan menu. Surf List/Ch. Edit allows you to create two other types of channel lists; custom list and surf list. A custom list can be created by toggling each channel on or off with "⊙". Once a channel is highlighted, you will be able to see whether the channel is currently shown or hidden by referring to the small window at the top-left corner of the screen.

To create your own surf list, with up to 50 favorite channels, press the **SURF** button on the remote control when a channel is highlighted.

#### To edit the channel list:

1. Press the **MENU** button on the remote control to display the on-screen menu.
2. Scroll down using "▼" on the remote control.
3. Select the Setup menu by pressing "⊙".
4. Scroll down to Surf List/Ch. Edit using "▼".
5. Press "▶" to display the channel editing screen.

#### *To create a custom list:*

1. Use "▲▼◀▶" to move the highlight on the channel editing menu.
2. Choose "Shown" or "Hidden" by pressing "⊙".

The screen shown at the top left will indicate if the highlighted channel is shown or hidden.

#### *To create a surf list:*

1. Use "▲▼◀▶" to move the highlight on the channel editing menu.
  2. Choose "Surf" or "No Surf" using the **SURF** button on the remote control.
6. Press the **MENU** button to return to the previous screen or press the **EXIT** button on the remote control to return to TV viewing.

#### **NOTE**

Use the "Show All" button to show all the channels.

Use the "Hide All" button to hide all the channels.

# 8. CUSTOMIZATION

## 8-8. Managing Channels





## 8-9. Setting the Clock

### Clock (Auto)

Enables adjustment of the time zone and activation of daylight savings time. Normally, your clock is set using signals transmitted by DIRECTV.

#### To set auto clock:

1. Press the **MENU** button on the Remote Control to display the on-screen menu.
2. Scroll down using “▼” on the remote control.
3. Select the Setup menu by pressing “⊙”.
4. Scroll down to Clock using “▼”.
5. Move the highlight to the right with “▶”.
6. Select your time zone by pressing “▶” repeatedly.
7. Scroll down to Daylight Saving and press “▶” to switch daylight saving on or off.
8. If you want to reset the clock, scroll up again to “Auto Set” and press “⊙”.
9. Press the **MENU** button to return to the previous menu or press the **EXIT** button on the remote control to return to TV viewing.

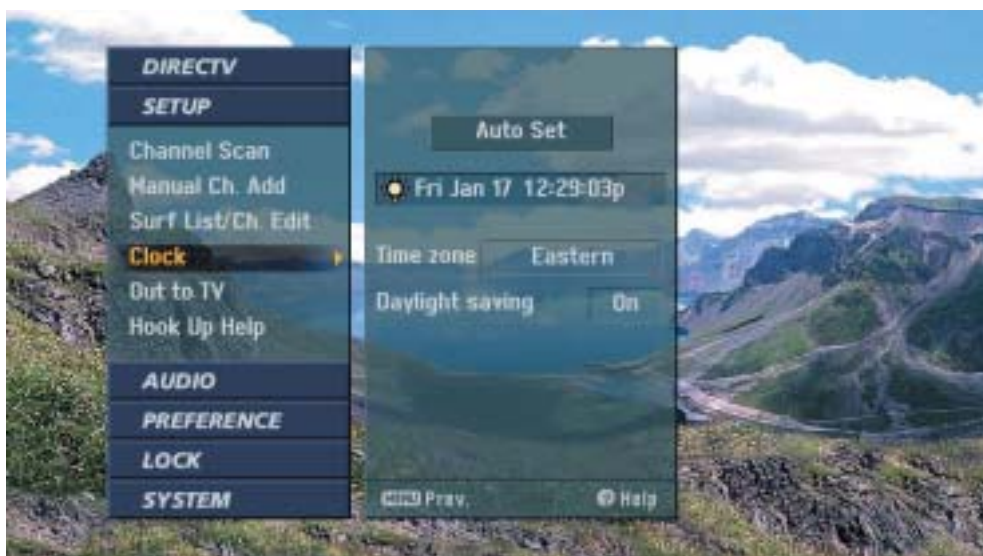

# 8. CUSTOMIZATION

## 8-9. Setting the Clock

### Clock (Manual)

Enables you to set the time manually for the ANT/CABLE source only.

#### To set clock manually:

1. Press the **MENU** button on the Remote Control to display the on-screen menu.
2. Scroll down using “▼” on the remote control.
3. Select the Setup menu by pressing “⊙”.
4. Scroll down to Clock using “▼”.
5. Move the highlight to the right with “▶”.
6. Use “▲▼” to move the highlight in the entry boxes.
7. Set the Year, Date and Time using the number buttons on the remote control.
8. Press **MENU** button to return to the previous screen or press the **EXIT** button on the remote control to return to TV viewing.



## 8-10. Setting Default Signal Out

### Output Channel

If you use the OUT TO TV jack, select channel 3 or 4 to send RF signal from your DIRECTV® HD Receiver to your TV. Your TV must be tuned to the selected channel to display the picture.

### Loop Through

A signal from CABLE IN or ANT IN jacks is passed through to the OUT TO TV jack when your HD Receiver is in the standby (power off) mode.

### To set Out to TV settings of the DIRECTV HD Receiver:

1. Press the **MENU** button on the Remote Control to display the on-screen menu.
2. Scroll down using “▼” on the remote control.
3. Select the Setup menu by pressing “⊙”.
4. Scroll down to Out to TV using “▼”.
5. Move the highlight to the right with “▶”.
6. Select your output channel to Channel 3 or Channel 4 with “◀▶”.  
Select your default signal source to Antenna or Cable with “◀▶”.
7. Press the **MENU** button to return to the previous menu or press the **EXIT** button on the remote control to return to TV viewing.

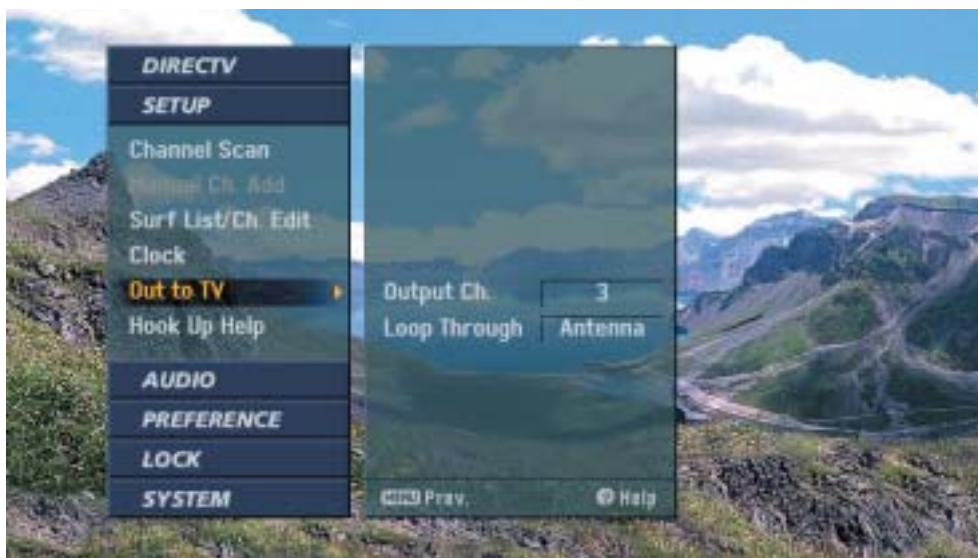

# 8. CUSTOMIZATION

## 8-11 Hook-up Help

Graphically depicts possible ways to connect the DIRECTV® HD Receiver to your dish antenna and other components. Since the connection that is best for you depends on the components in your system, keep in mind that an alternative connection may also be possible.

### To see Hook-up:

1. Press the **MENU** button on the remote control to display the on-screen menu.
2. Scroll down using “▼” on the remote control.
3. Select the Setup menu by pressing “⊙”.
4. Scroll down to Hook-up using “▼”.
5. Press “▶” to display the Hook-up diagrams.  
Seven possible hook-up connections will be shown.
6. Scroll up and down the hook-up figure options shown to determine the correct connections for your system.
7. Press the **MENU** button to return to the previous screen or press the **EXIT** button on the remote control to return to TV viewing.

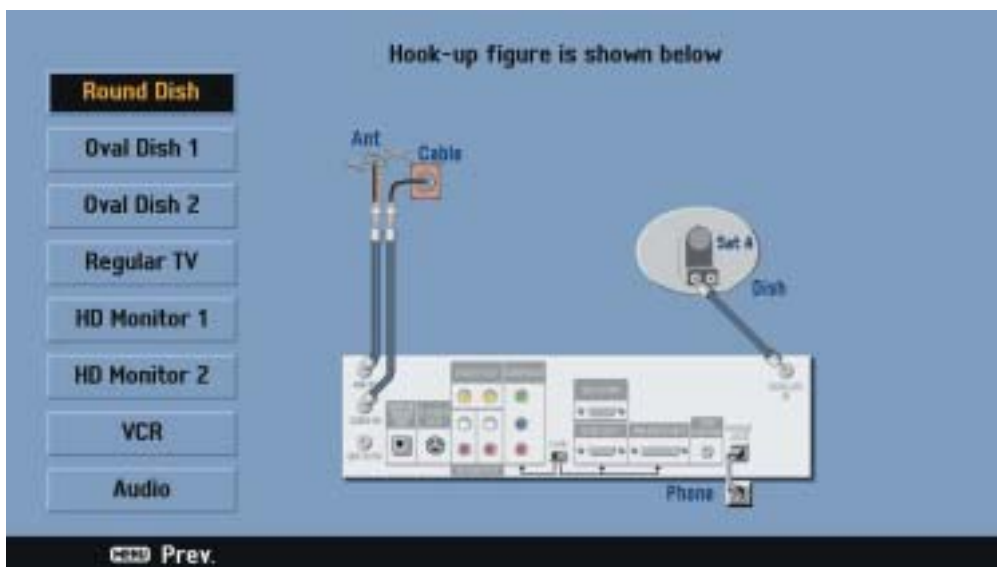

## 8-12. Setting the Audio

### Digital Output

If you are using an external audio system that supports Dolby Digital® audio, select Dolby Digital audio mode. If you are using an external audio system that has a PCM only decoder, select PCM (Digital). If you are not using an external audio system, select OFF.

 Do not select the Dolby Digital setting if connecting to an audio system that is not capable of decoding Dolby Digital audio. Doing so may cause the audio receiver to create high-pitched noise that could potentially cause harm to audio equipment.

### To set the digital audio mode:

1. Press the **MENU** button on the Remote Control to display the on-screen menu.
2. Scroll down using “▼” on the remote control.
3. Select the Audio menu by pressing “⊙”.
4. Digital Output will be automatically highlighted.
5. Move the highlight to the right with “▶”.
6. Select one of the three options and press “⊙” to return to the previous level.
7. Press the **EXIT** button on the remote control to return to TV viewing.



# 8. CUSTOMIZATION

## 8-12. Setting the Audio

### PCM (Digital)

Pulse Code Modulation (PCM) decoders support L/R stereo only. If selected, audio outputs are decoded and transmitted to the Digital Output (SPDIF) in PCM mode.

### Dolby Digital® Audio

Dolby Digital® audio, formerly known as Audio Coding 3rd Generation or 5.1 channel audio, is a coding technique that provides up to five independent, full frequency response audio channels and one low frequency bass channel.

#### NOTE

Refer to section 2-5 to see more detailed information.

#### NOTE

Please make sure that your A/V amplifier supports Dolby Digital decoding, as not all A/V amplifiers support 5.1 decoding.



## 8-12. Setting the Audio

### Audio Mode

Allows you to choose the default audio mode when a program is broadcasting in analog format.

When you view a program broadcast in mono, you will hear only mono sound, even though stereo mode is set. When Second Audio Program "SAP" mode is set, the program's second audio program is broadcast in mono, if provided.

### To Set the Analog Audio Mode:

1. Press the **MENU** button on the Remote Control to display the on-screen menu.
2. Scroll down using "▼" on the remote control.
3. Select the Audio menu by pressing "⊙".
4. Scroll down to Audio Mode using "▼".
5. Move the highlight to the right with "▶".
6. Select one of the three options and press "⊙" to return to the previous level.
7. Press the **EXIT** button on the remote control to return to TV viewing.



# 8. CUSTOMIZATION

## 8-12. Setting the Audio

### Dolby Digital® Audio

Allows you to choose a Dolby Digital® audio mode according to which analog audio output port you use to adjust the adequate audio level. If you connect audio line output to your TV, select 'Line Mode'. If you use the OUT TO TV port to connect to your TV, select 'RF Mode'.

### To set the Dolby Digital:

1. Press the **MENU** button on the Remote Control to display the on-screen menu.
2. Scroll down using "▼" on the remote control.
3. Select the Audio menu by pressing "⊙".
4. Scroll down to Dolby Digital using "▼".
5. Move the highlight to the right with "▶".
6. Select the Line Mode or RF Mode option and press "⊙" to return to the previous level.
7. Press the **EXIT** button on the remote control to return to TV viewing.





## 8-12. Setting the Audio

### Audio Language

If available, allows you to hear a program in other languages if the program is broadcast in digital format. You may select a language while you are viewing a program by selecting an option on the audio language box in the channel banner and pressing “◀ ▶” repeatedly to select the desired language.

### To set the digital audio language:

1. Press the **MENU** button on the Remote Control to display the on-screen menu.
2. Scroll down using “▼” on the remote control.
3. Select the Audio menu by pressing “⊙”.
4. Scroll down to Audio Language using “▼”.
5. Move the highlight to the right with “▶”.
6. Select one of the eight language options and press “⊙” to return to the previous level.
7. Press the **EXIT** button on the remote control to return to TV viewing.



# 8. CUSTOMIZATION

## 8-13. Choosing the Aspect Ratio

Allows you to choose the screen format. When you view a high-definition picture using the video 480i or 480p output format, you can choose Letterbox, Cropped or Squeezed.

When you view a standard-definition picture using the 720p or 1080i output format, you can choose Normal, Wide, Panorama, Zoom or Cine-Zoom. When you view a high-definition picture using the 720p or 1080i output format, you can temporarily choose Standard, Expand, Shrink.

(Refer to section 2-4 Normal and Wide Format Signals.)

### Choosing the screen format of your TV:

1. Press the **MENU** button on the Remote Control to display the on-screen menu.
2. Scroll down using “▼” on the remote control.
3. Select the Preference menu by pressing “⊙”.
4. TV Aspect Ratio will be automatically highlighted.
5. Move the highlight to the right with “▶”.
6. Select one of the options and press “⊙” to return to the previous level.
7. Press the **EXIT** button on the remote control to return to TV viewing.

Note : The **RATIO** button on the remote control may also be used to toggle through the available aspect ratio settings of the current content and output format.



## 8-13. Choosing the Aspect Ratio

Modes for viewing high-definition content (16:9) WHEN OUTPUT FORMAT IS 480i OR 480p MODE :

### **Letter Box**

Use for a picture with an original 16:9 aspect ratio (in a wide format). Letterbox mode will shrink the picture to fill the screen, with black (or gray) bars appearing at the top and bottom of the screen.

### **Cropped**

Use for a picture filling the entire screen by cropping (removing) the left and right portions of the picture.

### **Squeezed**

Use for a full picture filling the entire screen with no black/gray bars. The picture in a 16:9 format will be horizontally adjusted or squeezed to fit the 4:3 ratio monitor.

Modes for viewing normal image (4:3) on a wide TV (16:9) display WHEN OUTPUT FORMAT IS 720p OR 1080i MODE :

### **Normal**

Use for a picture with an original 4:3 aspect ratio on your 16:9 monitor, with black/gray bars appearing at the left and right sides.

### **Wide**

Use for a picture adjusted horizontally (in a linear proportion) to fill the entire screen.

### **Panorama**

Use to adjust a picture in a non-linear proportion (more at both sides) to create a spectacular view.

### **Zoom**

Use when you want to fill the entire screen with no black/gray bars appearing. The image will be altered both horizontally (stretched) and vertically (cropped). The top and bottom portions of the picture will be cut.

### **CINE-Zoom**

Use to adjust zooming. The picture can be adjusted in multiple steps to provide the best display for many program formats on your display device.

# 8. CUSTOMIZATION

## 8-13. Choosing the Aspect Ratio

Modes for viewing high-definition content (16:9) WHEN OUTPUT

FORMAT IS 720p OR 1080i MODE :

*(Note: you may choose one of three picture appearance options for your preference)*

### **Standard**

Choose when you want to view a picture with no adjustment.

### **Expand**

Choose when you want to view a picture in the 16:9 ratio. The picture will be horizontally adjusted or expanded to fit 16:9 ratio size. Left and right portions of the picture will not be shown.

### **Shrink**

Choose when you want to view a picture in the 4:3 ratio. The picture will be horizontally adjusted or squeezed to fit 4:3 ratio size. Black or gray bars will show at the left and right side.

### **Aspect Ratio Summary**

<b>Program Format</b>	<b>Output Format</b>	<b>Available Aspect Ratio</b>
SD(480i/p) 4 : 3	SD(480i/p) 4 : 3	No Adjustment Options
HD(720p/1080i) 16 : 9	SD(480i/p) 4 : 3	Letter Box, Cropped, Squeezed
SD(480i/p) 4 : 3	HD(720p/1080i) 16 : 9	five Aspect Ratio controls (Normal, Wide, Panorama, Zoom, Cine-Zoom)
HD(720p/1080i) 16 : 9	HD(720p/1080i) 16 : 9	three temporary Aspect Ratio controls (Standard, Expand, Shrink)

#### **NOTE**

The aspect ratio setting changes both the high-definition outputs (Component, RGB/DVI-HDTV) and the standard-definition outputs (Video 1/2, S-Video, Out to TV). When using a VCR or DVR to record programming from the standard definition outputs, make sure the correct aspect ratio is selected.

## 8-14. Setting Digital Caption

Allows you to select a mode for displaying Digital Caption Data. In the Digital Caption Service, Services 1-6 typically represent different Language Services, if available.

### Service 1

Service 1 is designated as the Primary Caption Service. This service contains the verbatim, or near-verbatim captions for the primary language being spoken in the accompanying program audio.

### Service 2

Service 2 is designated as the Secondary Language Service. This service contains captions in a secondary language which are translations of the captions in the Primary Caption Service.

### Services 3-6

The other services are not pre-assigned. It is up to the discretion of the individual caption provider to utilize the remaining service channels.

#### To set DTV Caption:

1. Press the **MENU** button on the Remote Control to display the on-screen menu.
2. Scroll down using “▼” on the remote control.
3. Select the Preference menu by pressing “⊙”.
4. Scroll down to DTV Caption using “▼”.
5. Move the highlight to the right with “▶”.
6. Select one of options and press “⊙” to return to the previous level.
7. Press the **EXIT** button on the remote control to return to TV viewing.



# 8. CUSTOMIZATION

## 8-15. Setting Digital Caption Style

Allows you to customize the caption style to your preference by allowing you to change: Font, Edge Type, Color, etc.

Note : If the Style setting is "Set By Program" the captions will appear as defined by the program provider.

### To set DTV Caption Style:

1. Press the **MENU** button on the Remote Control to display the on-screen menu.
2. Scroll down using "▼" on the remote control.
3. Select the Preference menu by pressing "⊙".
4. Scroll down to DTV Caption Style using "▼".
5. Move the highlight to the right with "▶" to move to the caption style box.
6. Select each value from Style to Edge Color.  
Move the highlight using "▼▲", and Select a value for each option with "◀▶".
7. Press the **MENU** button on the remote control to return to the previous level.  
Press the **EXIT** button on the remote control to return to TV viewing.



## 8-16. Setting Closed Caption

Allows you to select a mode for displaying analog Closed Caption Data. In the Analog Caption Service, Captions 1-4 display program's dialog, and Text 1-4 display for a data service information. (Note: Closed Captions will appear only when they are provided by the broadcaster.)

### **Caption1 (CC1)**

CC1 is the primary caption service that synchronizes the captioning language with the sound, used by most broadcasters. The captioning is displayed in the same language as the program's dialog.

### **Caption2 (CC2)**

CC2 is the special non-synchronous caption service that does not need to be in sync with the sound and may provide simplified captioning, which is usually delayed.

### **Caption3 (CC3)**

CC3 serves as an alternate captioning service channel. The captioning is often a secondary language translation such as French, Spanish, simplified English or displayed at a slower rate.

### **Caption4 (CC4)**

CC4 is another special non-synchronous caption service that does not need to be in sync with the sound and may provide simplified captioning, usually delayed.

### **Text 1-4**

Text1-4 usually display information at the bottom position and is used for a data service, generally not program related.

### **To set Closed Caption:**

1. Press the MENU button on the Remote Control to display the on-screen menu.
2. Scroll down using "▼" on the remote control.
3. Select the Preference menu by pressing "⊙".
4. Scroll down to Closed Caption using "▼".
5. Move the highlight to the right with "▶".
6. Select one of options and and press "⊙" to return to the previous level.
7. Press the **EXIT** button on the remote control to return to TV viewing.



# 8. CUSTOMIZATION

## 8-17. Advanced

### Advanced Setup

Allows you to configure special settings such as the background matte color for wide aspect ratio programming, the channel banner time-out period and the contrast range of DVI output.

#### To set advanced Setup Menu:

1. Press the **MENU** button on the Remote Control to display the on-screen menu.
2. Scroll down using "▼" on the remote control.
3. Select the Preference menu by pressing "⊙".
4. Scroll down to Advanced using "▼".
5. Move the highlight to the right with "▶"
6. Select your default background Matte Color which appears with certain aspect ratio settings with "◀ ▶".  
Or  
Select a time-out duration for the Information banner either, 'Short' or 'Long'.  
Or  
Select a Banner style of "Small", "Medium" or "Large" to be displayed when changing channels or pressing the INFO button.  
Or  
Select each DVI Level between 'Standard' which is recommended for most TVs or 'Expand' which is recommended for most digital monitors.
7. Press the **MENU** button on the remote control to return to the previous level.  
Press the **EXIT** button on the remote control to return to TV viewing.





## 8-18. Running Demo

Shows you how to navigate through the on-screen menus of the DIRECTV® HD Receiver.

### To run Demo:

1. Press the **MENU** button on the Remote Control to display the on-screen menu.
2. Scroll down using “▼” on the remote control.
3. Select the Preference menu by pressing “⊙”.
4. Scroll down to Demo using “▼”.
5. Press “▶” to display the Demo screen.  
Demo will run automatically.
6. Press “◀” anytime to return to the previous screen or press the **EXIT** button on the remote control to return to TV viewing.



# 8. CUSTOMIZATION

## 8-19. Setting Locks

### Lock System

Allows you to set up specific channels, ratings and spending limits through blocking schemes. Also allows you to activate or disable all of the lock schemes previously set up. A password is required to gain access to this menu if the lock system is activated. You can change the password by inputting a new password twice. When the system is unlocked, the Block Channel, Program Rating and Spending Limits are not effective.

### To activate or deactivate the Lock System:

1. Press the **MENU** button on the Remote Control to display the on-screen menu.
2. Scroll down using “▼” on the remote control.
3. Select the Lock menu by pressing “⊙”.
4. If unlocked, Lock System will be automatically highlighted, otherwise requires a password.

### To lock the system:

1. Move the highlight to the right with “▶” in Lock On/Off box.
2. Switch On or Off by using “▶” Whenever you switch the lock system on, you need to enter the password as a reminder.

### To set the password:

1. Move the highlight to the Set Password with “▼”.
  2. Enter the password by using the digit buttons on the remote control.
  3. Enter the password again for verification.
5. Press “◀” to return to the previous screen or press the **EXIT** button on the remote control to return to TV viewing.



## 8-19. Setting Locks

### Block Channel

Blocks any channels that you do not want to view or that you do not want your kids to watch. If you tune in a blocked channel, a black screen with a pop-up screen will appear. You will have to enter the correct password to view the channel. Once you turn off your DIRECTV® HD Receiver, Block Channel will automatically be reactivated.

#### To block channels:

1. Press the **MENU** button on the Remote Control to display the on-screen menu.
2. Scroll down using “▼” on the remote control.
3. Select the Lock menu by pressing “⊙”.
4. Scroll down to Block Channel using “▼”.
5. Press “▶” to display the Block Channel screen.
6. Use “▲▼◀▶” to move the highlight in the channel editing screen.
7. Toggle Blocked or Unblocked using “⊙”.  
The screen shown at the top left will indicate if the highlighted channel is blocked or unblocked.
8. Press “◀” to return to the previous screen or press the **EXIT** button on the remote control to return to TV viewing.



#### NOTE

When you tune to a blocked channel, a password is required for access.

The Channel Block feature should not be used as the only parental control. Since station assignments may change from time to time, controls such as rating and spending limits should always be used as the primary parental control. Additionally, the Channel Block settings may be reset if there is an interruption to the AC power (such as if set is unplugged or there is a power failure).

# 8. CUSTOMIZATION

## 8-19. Setting Locks

### Movie Rating

Blocks movies according to the movie ratings limit, as defined by the Motion Picture Association of America, so children cannot view certain movies. You can set the ratings limit by blocking out all the movies with the ratings above a specified level. Keep in mind that the movie ratings limit applies only to movies shown on TV, not TV programs such as soap operas.

### To block movie programs:

1. Press the **MENU** button on the Remote Control to display the on-screen menu.
2. Scroll down using “▼” on the remote control.
3. Select the Lock menu by pressing “⊙”.
4. Scroll down to Movie Rating using “▼”.
5. Select the level you want using “▲▼” and press “⊙” to return to the previous level.
6. Press the **EXIT** button on the remote control to return to TV viewing.



### NOTE

#### MOVIE/MPAA rating

**G:** General Audiences

All ages admitted.

**PG:** Parental Guidance Suggested.

Some material may not be suitable for children.

**PG-13:** Parents Strongly Cautioned

Some material may not be appropriate for children under 13.

**R:** Restricted Under 17 requires parent or adult guardian present.

**NC-17:** No viewers 17 and under.

**X:** No viewers 17 and under.

### NOTE

The Lock feature relies on correct rating information to be provided by broadcasters and service providers. If broadcast rating information is missing or incorrect, the Lock feature cannot function as designed.

## 8-19. Setting Locks

### TV Rating for Children's Programs

Keeps children from watching certain children's TV programs according to the ratings limit as defined by the TV Parental Guidelines Monitoring Board. This rating applies only to TV programs for children. Unless you block TV programs intended for mature audiences in the TV Rating – General menu, your children may view those programs.

#### To block TV programs:

1. Press the **MENU** button on the Remote Control to display the on-screen menu.
2. Scroll down using “▼” on the remote control.
3. Select the Lock menu by pressing “⊙”.
4. Scroll down to TV Rating-Children using “▼”.
5. Select Age or Content, if you want to lock a TV program based on age or content.
6. Select the level you want using “▲▼” and press “⊙” to return to the previous level.
7. Press the **EXIT** button on the remote control to return to TV viewing.



#### NOTE

##### TV Rating Children Programs

**TV-Y:** All Children.

This program is designed to be appropriate for all children.

**TV-Y7:** Directed to Older Children.

This program is designed for children age 7 and above.

# 8. CUSTOMIZATION

## 8-19. Setting Locks

### TV Rating for General Programs

Blocks TV programs that you and your family do not wish to watch, based on the rating scheme defined by the TV Parental Guidelines Monitoring Board.

#### To block TV programs:

1. Press the **MENU** button on the Remote Control to display the on-screen menu.
2. Scroll down using “▼” on the remote control.
3. Select the Lock menu by pressing “⊙”.
4. Scroll down to TV Rating-General using “▼”.
5. Select Age or Content, if you want to lock a TV program based on age or content.
6. Select the level you want using “▲▼” and press “⊙” to return to the previous level.
7. Press the **EXIT** button on the remote control to return to TV viewing.



#### NOTE

### TV Rating for General Programs

**TV-G:** General Audience.

Most parents would find this program suitable for all ages.

**TV-PG:** Parental Guidance Suggested.

This program contains material that parents may find unsuitable for younger children.

**TV-14:** Parents Strongly Cautioned.

This program contains some material that many parents would find unsuitable for children under 14 years of age.

**TV-MA:** Mature Audience Only.

This program is specifically designed to be viewed by adults and therefore may be unsuitable for children under 17.

## 8-19. Setting Locks

### Spending Limit

Sets a spending limit for individual Pay Per View (PPV) programs. After a spending limit is set and the system is locked, you must enter the password to purchase a PPV program that costs more than your spending limit allows. The system will temporarily unlock the limit you previously set. Once the receiver is turned off and then turned back on, the lock will be reactivated.

#### To set the spending limit of each PPV program:

1. Press the **MENU** button on the Remote Control to display the on-screen menu.
2. Scroll down using “▼” on the remote control.
3. Select the Lock menu by pressing “⊙”.
4. Scroll down to Spending Limit using “▼”.
5. Move the highlight to the right with “▶”.
6. Enter the maximum amount of money to be spent on each PPV program.
7. Press “⊙” to return to the previous level.
8. Press the **EXIT** button on the remote control to return to TV viewing.



# 8. CUSTOMIZATION

## 8-20. Getting the System Information

### General Info

Shows you general information about your DIRECTV® HD Receiver.

#### To view General information in the HD Receiver:

1. Press the **MENU** button on the Remote Control to display the on-screen menu.
2. Scroll down using “▼” on the remote control.
3. Select the System menu by pressing “⊙”.
4. System Info will be automatically highlighted.
5. Move the highlight to the right with “▶” to display the information option box.
6. General Info will be automatically highlighted.
7. Press “⊙” and the pop-up dialogue box will be displayed.
8. Press the **EXIT** button on the remote control to return to TV viewing.





## 8-20. Getting the System Information

### Feature List

When in Satellite mode, allows you to see which major features are available for your DIRECTV® HD Receiver.

#### To view Feature list in the HD Receiver:

1. Press the **MENU** button on the Remote Control to display the on-screen menu.
2. Scroll down using “▼” on the remote control.
3. Select the System menu by pressing “⊙”.
4. System Info will be automatically highlighted.
5. Move the highlight to the right with “▶” to display the information option box.
6. Scroll down using “▼” on the remote control to select Feature List.
7. Press “⊙” and the pop-up dialogue box will be displayed.
8. You can see the feature list on the right side of the menu.
9. Press the **EXIT** button on the remote control to return to TV viewing.



# 8. CUSTOMIZATION

## 8-20. Getting the System Information

### Tuner List

When in Satellite mode, shows you what kind of tuners are built in your DIRECTV® HD Receiver.

### To upgrade the software in the HD Receiver:

1. Press the **MENU** button on the Remote Control to display the on-screen menu.
2. Scroll down using “▼” on the remote control.
3. Select the System menu by pressing “⊙”.
4. System Info will be automatically highlighted.
5. Move the highlight to the right with “▶” to display the information option box.
6. Scroll down using “▼” on the remote control to select Tuner List.
7. Press “⊙” and the pop-up dialogue box will be displayed.
8. You can see the Tuner list on the right side of the menu.
9. Press the **EXIT** button on the remote control to return to TV viewing.



## 8-20. Getting the System Information

### System Upgrade

When in Satellite mode, shows you the current software version. If there is a software upgrade planned, you will be notified by a pop-up box on your TV screen and the pop-up box will ask you if you want to upgrade your system.

#### To upgrade the software in the DIRECTV® HD Receiver:

1. Press the **MENU** button on the Remote Control to display the on-screen menu.
2. Scroll down using “▼” on the remote control.
3. Select the System menu by pressing “⊙”.
4. System Info will be automatically highlighted.
5. Move the highlight to the right with “▶” to display the information option box.
6. Scroll down to System Upgrade using “▼”.
7. Press “⊙”, then you can see the current software version on the right side of the menu.  
The next version will be seen if DIRECTV plans to upgrade the software.
8. Press the **EXIT** button on the remote control to return to TV viewing.

The DIRECTV HD Receiver is able to receive upgrades or modifications to some of its features and functions via satellite service. These modifications will automatically be made, usually at times when the receiver would likely be turned off. If your receiver is on when an upgrade or modification is sent, you may experience a disruption in reception for a minute or two. Your reception should return to normal after the modification is complete. Your receiver must be plugged in and connected to satellite service to receive any upgrades. Please consult the Upgrade Menu to find a schedule of upgrades or modifications planned by DIRECTV.  
(Note: Do not unplug your receiver while an upgrade is in progress. )



# 8. CUSTOMIZATION

## 8-20. Getting the System Information

### Basic Test

When in Satellite mode, diagnoses essential system components of your DIRECTV® HD Receiver. Once the Basic System Test is done, your HD Receiver's status will be displayed. If any problems are detected, a short message will be displayed.

### To test basic items in the HD Receiver :

1. Press the **MENU** button on the Remote Control to display the on-screen menu.
2. Scroll down using "▼" on the remote control.
3. Select the System menu by pressing "⊙".
4. Scroll down to System Test using "▼".
5. Move the highlight to the right with "▶" to display the system test option box.
6. "Basic Test" Info will be automatically highlighted.
7. Press "⊙" and the pop-up dialogue box will be displayed.
8. Press "⊙" to activate the System Basic test.  
It will run automatically from DIRECTV Tuner to Phone Connection and if there is any problem in your system, the pop-up box will be displayed.
9. Press the **EXIT** button on the remote control to return to TV viewing.



## 8-21. Testing the System

### Satellite Dish Antenna (Outdoor Unit) Test

When in Satellite mode, diagnoses the Satellite Dish Antenna (LNB and Satellite Antenna) connected to the HD Receiver.

Once the Satellite Dish Antenna (Outdoor Unit) Test is done, Satellite signal status will be displayed. If any problems are detected, a short message will be displayed.

#### To test the Outdoor Unit :

1. Press the **MENU** button on the Remote Control to display the on-screen menu.
2. Scroll down using “▼” on the remote control.
3. Select the System menu by pressing “⊙”.
4. Scroll down to System Test using “▼”.
5. Move the highlight to the right with “▶” to display the system test option box.
6. Scroll down to Outdoor Unit Test using “▼” on the remote control.
7. Press “⊙” and the pop-up dialogue box will be displayed.
8. Press “⊙” to activate the system outdoor unit test.  
It will run automatically and if there is any problem in your system, the pop-up box will be displayed.
9. Press the **EXIT** button on the remote control to return to TV viewing.



# 8. CUSTOMIZATION

## 8-21. Testing the System

### Transponder Test

When in Satellite mode, diagnoses all transponder signals of each Satellite. Once the Transponder Test is done, all transponder signal status of the selected Satellite will be displayed.

#### To test the Transponder:

1. Press the **MENU** button on the Remote Control to display the on-screen menu.
2. Scroll down using “▼” on the remote control.
3. Select the System menu by pressing “⊙”.
4. Scroll down to System Test using “▼”.
5. Move the highlight to the right with “▶” to display the system test option box.
6. Scroll down to Transponder Test using “▼” on the remote control.
7. Press “⊙” and the pop-up dialogue box will be displayed.
8. Select one of SAT A/SAT B/SAT C with “◀▶”.
9. Move the highlight to the Start Button and press “⊙” to activate the system transponder test. It will run automatically and if there is any problem in your system, the pop-up box will be displayed.
10. Press **MENU** button to return to the previous level or press the **EXIT** button on the remote control to return to TV viewing.

Note : Depending on your location in the United States, certain transponders may not be available. It is normal for the signal strength level of a few transponders to be at zero.

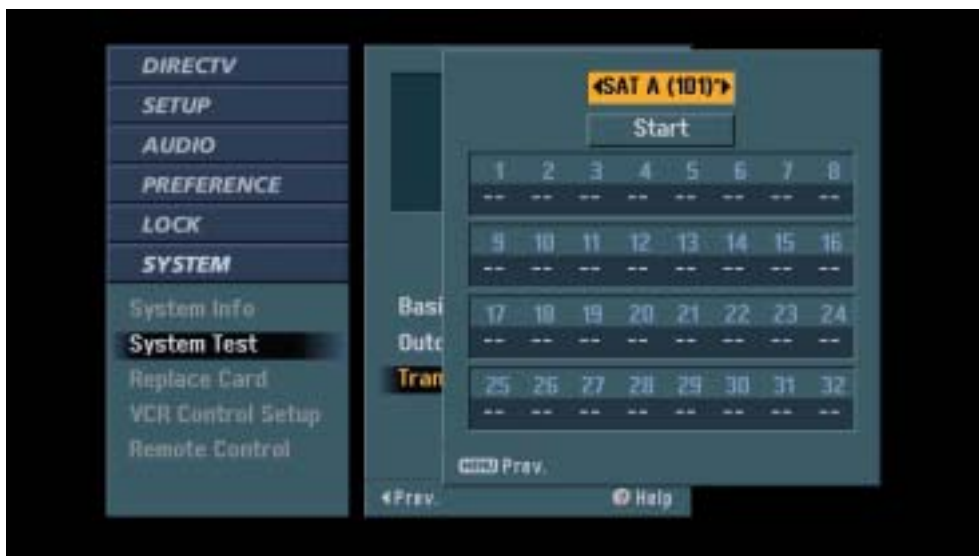

## 8-22. Replace Card

If you are a DIRECTV customer, DIRECTV may issue you a replacement access card periodically when in Satellite mode. This menu enables you to transfer information, such as the record of your purchases, from the old card onto a new one. The access card fits into the slot on the front panel of the DIRECTV® HD Receiver.

 Once you proceed past “Read the old card”, “Replace Card” cannot be cancelled.

### To replace the card :

1. Press the **MENU** button on the Remote Control to display the on-screen menu.
2. Scroll down using “▼” on the remote control.
3. Select the System menu by pressing “⊙”.
4. Scroll down to Replace Card using “▼”.
5. Pressing “⊙”. Replace Card Wizard will be displayed.
6. If you want the process to proceed, follow the instructions in the Replace Card Wizard.
7. Press the **EXIT** button on the remote control to return to TV viewing.



# 8. CUSTOMIZATION

## 8-23. VCR Control Setup

Allows you to set up the DIRECTV® HD Receiver to control your VCR for automatic recording when used with the Record feature (see section 8-5).

### To set up the VCR Control:

1. Press the **MENU** button on the Remote Control to display the on-screen menu.
2. Scroll down using “▼” on the remote control.
3. Select the System menu by pressing “⊙”.
4. Scroll down to VCR Control Setup using “▼”.
5. Pressing “⊙”. **VCR Control Setup Wizard** will be displayed.
6. If you want the process to proceed, follow the instructions in the VCR Control Setup Wizard.
7. Press the **EXIT** button on the remote control to return to TV viewing.





## 8-24. Remote Control Setup

Your DIRECTV® HD Receiver's remote control can send signals to the HD Receiver.

You can choose to assign one of four remote ID's for IR (Infrared) Control. This can be useful if you have more than one HNS satellite receiver in your home.



# 9. HELP

## 9-1. Help

The Help feature is designed to let you understand each function of the Menu and Advanced Program Guide™ in an easy and convenient way. When you navigate through the Menu and the Advanced Program Guide, press and hold the **"HELP (?)"** button on your remote control if you want information about the highlighted item. The information will be displayed on the right side of the TV screen.

Simply press and hold **"HELP (?)"** button to see the helpful information.

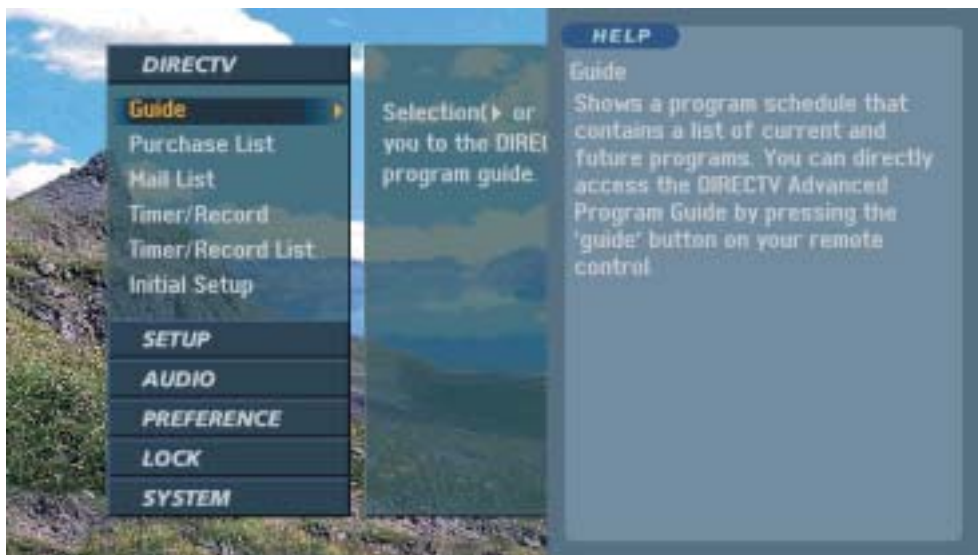

### NOTE

Pressing the **"HELP (?)"** button on your remote control with no menu on-screen, will activate the overall Help feature. However, when the MENU or the Advanced Program Guide is already displayed, pressing the **"HELP (?)"** button will activate the specific Help feature.

## 9-1. Help

The Help is an on-screen version of this Operating Guide. You can review many features of the DIRECTV® HD Receiver by navigating through a simple structure. It contains a brief overview of the DIRECTV HD Receiver, the use and programming of the remote control, a functional explanation of the front and back panel, and an instructive note about the Menu and the Advanced Program Guide™.

### To see the Help feature:

1. Press the “**HELP (?)**” button on the remote control to display the Help screen.
2. Scroll up and down to select Help menu items using “**▲▼**” on the remote control.
3. Move the highlight using “**▲▼◀▶**”.  
The explanations of the highlighted item will be displayed on the right side or at the bottom of the screen.
4. Press the **EXIT** button on the remote control if you want to return to TV viewing.



# PRODUCT SPECIFICATIONS

Specifications For Model No. HTL-HD

---

<b>Television System</b>	NTSC, Analog American Standard (480i) ATSC, Digital TV standard (1080i, 720p, 480p, 480i) DIRECTV
--------------------------	---

---

<b>Channel Coverage</b>	
Digital TV	1-69
VHF	2-13
UHF	14-69
CATV	1-125
DIRECTV	variable

---

<b>Inputs/Outputs</b>	
ATSC/NTSC RF Inputs	Antenna (1), Cable TV (1) ( <i>Terrestrial</i> )
RF Output	Out To TV (1) ( <i>selectable Channel 3 or 4</i> )
DIRECTV RF Input	Satellite In (1)
DVI-HDTV Output	DVI-HDTV Out (1), DVI-D Single Link connector 1080i, 720p, 480p, 480i digital RGB EIA-861 Compliant, HDCP 1.0 Compliant
RGB Output	15-pin Connector (1) 1080i, 720p, 480p RGB
Component Video Output	Component Out (1), Phono Jack connector 1080i, 720p, 480p, 480i YPbPr
S-Video Output	S-Video Out (1), 4-pin Mini-DIN 480i Y/C
Video Output	Video Out (2), Phono Jack connector 480i Composite NTSC
Digital Audio	Optical ( <i>selectable Dolby Digital® or PCM output</i> )
Analog Audio	Audio Out (2) ( <i>Fixed Output Level</i> )
Access Card	Smart Card (Slot on the front)
Data Port	9-pin Serial Port (1)
VCR Control	IR blaster (1)

---

<b>Supplied Accessories</b>	
Remote Control	
Batteries	AAA type Batteries (2)
Cables	DVI-D Single Link Cable (1) Component Cable (1) S-Video Cable (1) Audio/Video Cable (1) RF Cable (1) Telephone Cable (1) VCR Controller (1)

---

<b>Dimension</b>	430mm (W) x 69mm (H) x 326mm (D) (Excluding Feet)
------------------	---

---

<b>Mass</b>	3.84kg
-------------	--------

---

<b>Power Requirements</b>	AC 120V, 60Hz
---------------------------	---------------

---

<b>Power Consumption</b>	40W (Maximum) 20W (Standby: Single LNB)
--------------------------	--

---

Design and specifications are subject to change without notice.

# TROUBLESHOOTING

Hughes and DIRECTV are dedicated to providing you with quality support and customer service. If you have questions or difficulties that you cannot resolve using the tips in this troubleshooting section, consult your dealer or call DIRECTV at 1-800-531-5000 regarding problems with DIRECTV Service problems and Hughes Customer Care Center at : 1-800-274-8995 regarding your DIRECTV® HD Receiver.

SYMPTOMS	SOLUTIONS
No power.	<ul style="list-style-type: none"> <li>- Is the AC power cord plugged in?</li> </ul>
No signal.	<ul style="list-style-type: none"> <li>- Check your antenna input or location.</li> <li>- Check your cable input.</li> <li>- Check your satellite input or set up.</li> </ul>
No picture. Macroblocking in picture. No Signal message. Searching for satellite signal. Please standby OSD/VFD.	<ul style="list-style-type: none"> <li>- Make sure that the correct format is selected.</li> <li>- Press the <b>DISPLAY FORMAT</b> button on the front panel to change formats. (see section 4-1)</li> <li>- Make sure that the right component type is selected.              If the DIRECTV®HD Receiver is connected to your monitor or TV via Y/Pb/Pr port on the back panel, the "TYPE" switch must be flipped to the left. Otherwise, you may not be able to see a picture. (see section 3-5)              If the DIRECTV HD Receiver is connected to your monitor or TV via RGB/DVI-HDTV port on the back panel, the "TYPE" switch must be flipped to the right. Otherwise, you may not be able to see a picture. (see section 3-5).</li> <li>- Make sure the Initial Setup process has been performed (see section 8-7).</li> <li>- Select the Channel Scan or Manual Channel Add functions if you have not already done so (see section 8-8).</li> <li>- If you are only receiving a few satellite channels, you may need to call your service provider to have your programming activated.</li> <li>- Check to make sure all the cables are installed correctly and that the proper source is selected on your TV. For example, channel 3 or 4, 480i.</li> <li>- The satellite or digital TV signal strength may be low. Check the signal strength and adjust the satellite dish or TV antenna as recommended by the dish or antenna installation instructions (see section 8-7).</li> <li>- Make sure the broadcaster or service provider is supplying programming on the selected channel. Use the SIGNAL button to check for digital video signals (see section 4-2).</li> <li>- You may be trying to access a pay per view program. Follow the on-screen instructions to order the program.</li> <li>- Due to copyright restrictions, you may not be able to view some high-definition programs in the high-definition format.</li> <li>- Make sure the Access Card is inserted correctly.</li> <li>- For more information about connections, please refer to Section 3 of this manual.</li> </ul>

# TROUBLESHOOTING

SYMPTOMS	SOLUTIONS
The Program Guide shows channels I don't receive.	<ul style="list-style-type: none"> <li>- Contact your service provider to subscribe to all available channels.</li> <li>- Adjust your antenna or satellite dish to receive all available channels. (see section 3-4)</li> <li>- Use the Custom Guide feature to select channels that you receive. (see section 7-2)</li> <li>- Whenever you access the GUIDE, make sure you select the CUSTOM guide (see section 7-2) to show only channels not HIDDEN (see section 8-8). In order to ensure that you do not miss any new channel additions or special programming, when entering the GUIDE, it will default to ALL.</li> </ul>
Cannot receive high-definition channels.	<ul style="list-style-type: none"> <li>- Make sure that a multi-sat dish is used to receive all available HD satellite services (see section 3-4).</li> <li>- Make sure there is a good signal strength on available satellites or off-air antenna (see section 8-7 or press the SIGNAL button on the remote control).</li> </ul>
Normal picture but no sound.	<ul style="list-style-type: none"> <li>- Check volume levels.</li> <li>- Make sure the TV or Amp is not muted.</li> <li>- Check that the DIRECTV® HD Receiver is connected properly. (see section 3-7)</li> </ul>
Picture is distorted.	<ul style="list-style-type: none"> <li>- Make sure the proper format is selected. (see section 2-3)</li> <li>- Make sure the proper aspect ratio is selected. (see section 2-4)</li> <li>- Make sure the video output is connected to the TV. (see section 3-5)</li> <li>- Adjust the aspect ratio setting of your TV or monitor if available.</li> </ul>
Video image does not fill the TV screen.	<ul style="list-style-type: none"> <li>- Check the HD Receiver's Aspect Ratio setting (see section 8-13), press the RATIO button on the remote control, or check your TV's aspect ratio setting.</li> <li>- Check with your service provider or local broadcaster to confirm if a full video image is broadcast.</li> </ul>
Available channels are missing.	<ul style="list-style-type: none"> <li>- If you are a DIRECTV customer, you can add a channel by running the "Manual Ch. Add" from the SETUP menu or find all available channels by running the "Channel Scan" in the SETUP menu. (see section 8-8)</li> <li>- Otherwise, if the DIRECTV Receiver is in the ANT/CABLE mode, you can find available channels by running the "Channel Scan" in the SETUP menu. (see section 8-8)</li> </ul>
A previously available channel is no longer available.	<ul style="list-style-type: none"> <li>- Digital channels can be dynamically changed by broadcasters and service providers. A channel that may have been available in the past may have been moved or deleted. Consult your local broadcaster or service provider.</li> </ul>
4:3 Aspect ratio cannot be selected.	<ul style="list-style-type: none"> <li>- Aspect ratio depends on both the incoming program format and the <b>DISPLAY FORMAT</b> setting. Once the button for the format is set to a standard definition (480i/480p) and the incoming program is standard definition, the aspect ratio can not be adjusted and a warning message will appear on the screen. (see section 8-13)</li> </ul>

SYMPTOMS	SOLUTIONS
Aspect Ratio setting is re-set after the channel is changed.	<ul style="list-style-type: none"> <li>- When the Format is set to a high-definition setting (720p/1080i) and the incoming program is in high-definition, the Aspect Ratio setting can only be adjusted temporarily.</li> </ul>
The remote control is not responding.	<ul style="list-style-type: none"> <li>- Make sure the batteries are fresh and installed properly.</li> <li>- Point the remote control unit at the remote control sensor.</li> <li>- Check if the correct function (TV or SAT) on the remote control is selected.</li> <li>- Make sure the correct Remote Control type and code are set for both the remote and receiver. (see section 8-24)</li> </ul>
The timer does not work.	<ul style="list-style-type: none"> <li>- Make sure the clock is set properly. (see section 8-9)</li> </ul>
You forget your password.	<ul style="list-style-type: none"> <li>- If you subscribe to satellite service, contact your service provider to arrange for the password to be re-set</li> <li>- If you do not subscribe to satellite service and the DIRECTV HD Receiver is in the ANT/CABLE mode, enter the master password "7777".</li> </ul>
If a white bar is shown at the top position on the display device	<ul style="list-style-type: none"> <li>- Use the Component Output.</li> <li>- Adjust the scan range of your display device.</li> </ul>
Weak Sound	<ul style="list-style-type: none"> <li>- If connected to a TV using the "OUT TO TV" jack, set RF mode of "Dolby Digital" menu. (MENU → Audio → Dolby Digital)</li> </ul>
Conflicting digital channel numbers.	<ul style="list-style-type: none"> <li>- Press the <b>SIGNAL</b> button on the remote control, the physical channel number will be shown.</li> <li>- Press the <b>INFO</b> button on the remote control, the logical channel number will be shown in the channel banner.</li> </ul>
Cannot tune to a station	<ul style="list-style-type: none"> <li>- If you receive more than one station with the same channel number (such as channel 8 from satellite and channel 8 from over-the-air) entering "8" the first time will tune to satellite channel 8, entering "8" a second time will tune to analog channel 8, and so on.</li> </ul>
Channel content does not match that shown displayed in the GUIDE or INFO banner.	<ul style="list-style-type: none"> <li>- Please confirm that the Dish mode is set to the correct type using Auto Detection for Dish type (see section 8-7) or confirm your dish connections (see section 3-4).</li> </ul>

# TROUBLESHOOTING

SYMPTOMS	SOLUTIONS
<p>Closed captions are not displayed. Two sets of overlapping captions appear. Closed captions are not shown using my custom styles.</p>	<ul style="list-style-type: none"> <li>- Most recent TVs also include captioning capability, which you may independently set (see TV manual for details). If the captions are ON for both TV and this product, you may see overlapping captions. In this case, please turn off captioning on the TV or this product (see section 8-14).</li> <li>- When using the DVI-HDTV or RGB connections, captioning must be displayed using this product (see section 8-14). This may also be necessary, when FORMAT is set to modes other than 480i for YPbPr connection.</li> <li>- Depending on broadcast provider, different types of captioning may be available. According to your preferences, you will need to set your Caption settings for Analog and Digital modes.</li> <li>- By selecting both Analog on (for instance, CC1) and Digital CC on (for instance Service1) by pressing the CC button on the remote or by accessing settings outlined in 8-14 to 8-16), both types captioning will be displayed automatically, based on broadcast provider information.</li> <li>- Custom styles (described in 8-15) only are applied to some digital broadcasts with Digital Captions. Depending on the broadcast, you may need to set the Analog captions to OFF to view the Digital Captions.</li> </ul>
<p>Cannot receive audio with 5.1 channels.</p>	<ul style="list-style-type: none"> <li>- Dolby Digital 5.1 audio requires the use of the digital audio output connection with a compatible Dolby Digital A/V Receiver (see section 3-7 Digital Audio System).</li> <li>- Confirm that you have set the Audio → Digital Output setting to Dolby Digital mode (see section 8-12).</li> <li>- Availability of 5.1 audio will depend on the broadcast provider and is not available for analog broadcast sources. Although Dolby Digital can support up to 5.1 channels, some broadcasts may only be available in stereo.</li> </ul>
<p>Programming which appears to exceed my Lock settings is not blocked.</p>	<ul style="list-style-type: none"> <li>- Please confirm Lock has been enabled with your preferred limits (see section 8-19).</li> <li>- Depending on broadcast provider, not all programming may contain rating information necessary to block certain programming.</li> </ul>
<p>Additional problems.</p>	<ul style="list-style-type: none"> <li>- Press the <b>RESET</b> button (see section 4-1).</li> </ul>



## Limited Warranty

Your DIRECTV® HD Receiver, and Remote Control manufactured by Hughes Network Systems (HNS) are warranted against defects in materials and workmanship for parts and labor in accordance with the following provisions:

<b>Part</b>	<b>HTL-HD Satellite Receiver</b>	<b>HRMC-14 Remote Control</b>
<b>Warranty Period</b>	<b>1 year parts, 90 days labor.</b>	<b>90 days parts</b>

This limited warranty does not cover:

- a unit that has been modified
- damage from misuse, negligence, or accident
- any installation, or damages caused by installation
- shipments to HNS that are damaged in transit
- removal and reinstallation of equipment for repair
- loss of programming
- cost of shipping to HNS
- batteries or cables after installation
- acts of God

This limited warranty is not transferable and is valid only in the United States.

### Exclusions and Limitations

This limited warranty is in lieu of all other warranties, whether express, implied, or statutory, including, without limitation, the implied warranties of merchantability and fitness for a particular purpose. HNS shall not be liable for damages in excess of the purchase price of the product less reasonable amount for use and wear, or for any incidental, special, punitive, or consequential damages of any nature whatsoever, or for any delays, loss of use, time, profits, revenue or savings, any commercial loss, inconvenience, damage to your or to other person's property, arising from the use or inability to use the product, or otherwise for any failure to perform.

HNS neither assumes nor authorizes any customer care center or any other person or entity to assume any other obligation or liability beyond that which is provided for in this limited warranty. No oral or written information or advice given by HNS, its dealers, distributors, agents or employees, shall create a warranty or in any way increase the scope of this warranty.

Some states do not allow the exclusion or limitation of incidental or consequential damages, or limitations of implied warranties, so the above limitations or exclusions may not apply to you.

### Service

If you have any questions or encounter any problems, you may contact your authorized HNS dealer or call our Customer Care Center, at 1-800-274-8995. To ensure prompt and efficient service, please have your model and serial numbers handy. In the event of repair or replacement, you will need these numbers, along with your bill of sale.

### Return Procedures

If your equipment requires repair or replacement, you may:

- contact your authorized HNS dealer or call our Customer Care Center to find the authorized service center nearest you.

OR

- choose the "replace after receipt" option, whereby you must ship HNS your defective equipment and, once your unit is received, a new or refurbished unit (at the sole discretion of HNS) will be shipped to you.

### Packing Instructions for Equipment to be Returned

Call the Customer Care Center. The Customer Care technician will give you an RMA (Return Merchandise Authorization) and a mailing address for returning your unit.

If you are returning the HD satellite receiver, **please keep your access card and return only the HD satellite receiver.**

Pack the unit in the original box and packing material, if possible, or in other packaging that provides adequate protection for shipping. Include your name and address, the model number, the serial number, and a copy of the bill of sale.

Write: "Attention: RMA #" (the number given to you by the Customer Care technician) on the return shipping label.

Insure the shipment for the full replacement value.