

SPECIFICATIONS CHANGE-OUT PLUGS

Series A

- 2-9 Pole Configurations
- 2-4 Pole; #14 AWG, 12 AWG, 10 AWG
- 5-9 Pole; #18 AWG
- Nylon or Zinc Diecast Hardware

Series B

- 2-8 Pole Configurations
- 2-7 Pole; #10 AWG
- 8 Pole; #14 AWG
- Anodized Aluminum Hardware



TECHNICAL DATA

Agency Approvals

UL Recognition:
CSA Recognition:

File #E169897
File #LR13963

Electrical Data

Current Rating:
Voltage Rating:
Dielectric Withstand Voltage:

See chart with part number detail
See chart with part number detail
2200 VAC

Environmental Data

Protection:

Temperature Range:

NEMA 1, 3, 4, 6P and 13; IEC IP 68
(Nylon: NEMA 4X, Hose down pressure 1000 PSI)
-20°C to +105°C

Material Data



Body:
Cable:
Contacts:
Coupling Nut:

Black flame resistant PVC, Neoprene
STOOW, SO
Series A Machined Brass; Series B copper
Series A Zamak, nylon 6/6 weather stabilized
Series B Machined Aluminum

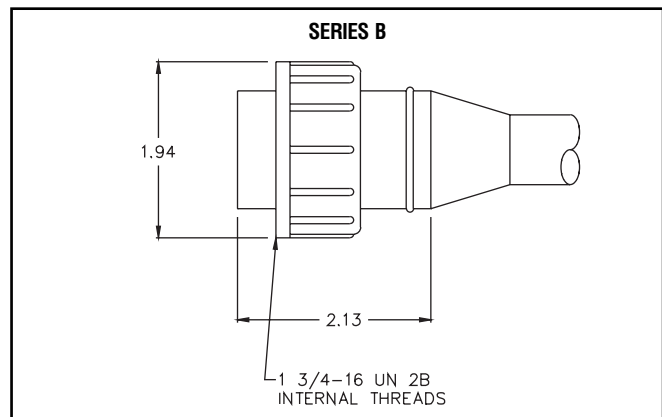
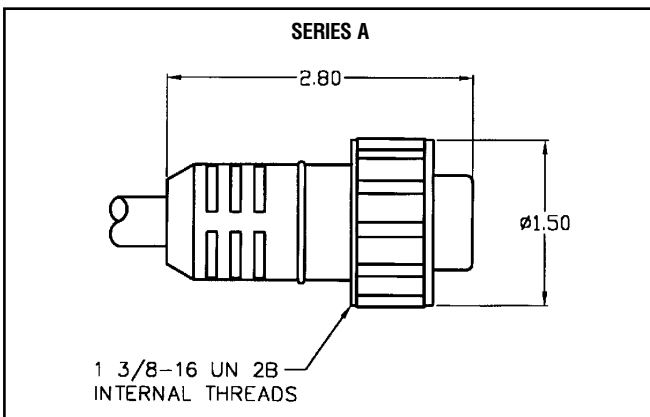

DIMENSIONS





CHANGE-OUT SERIES A STOOW FEMALE PLUGS WITH ZINC DIECAST COUPLING NUT

POLES	FACE VIEW FEMALE	COLOR CODE	RATING	AWG	CABLE LENGTH	PART NUMBER
2		1. Black 2. White	600V, 18A	14	6' 12' 18'	X8651-49P X8651-50P X8651-51P
3		1. Black 2. White 3. Green	600V, 18A	14	6' 12' 18'	X8652-48P X8652-49P X8652-50P
4		1. Black 2. Green 3. Red 4. White	600V, 15A	14	6' 12' 18'	X8653-44P X8653-45P X8653-46P

CHANGE-OUT SERIES A STOOW MALE PLUGS WITH ZINC DIECAST COUPLING NUT



POLES	FACE VIEW MALE	COLOR CODE	RATING	AWG	CABLE LENGTH	PART NUMBER
2		1. Black 2. White	600V, 18A	14	6' 12' 18'	X8651-52P X8651-53P X8651-54P
3		1. Black 2. White 3. Green	600V, 18A	14	6' 12' 18'	X8652-51P X8652-52P X8652-53P
4		1. Black 2. Green 3. Red 4. White	600V, 15A	14	6' 12' 18'	X8653-47P X8653-48P X8653-49P

CHANGE-OUT SERIES A STOOW FEMALE PLUGS WITH NYLON COUPLING NUT



POLES	FACE VIEW FEMALE	COLOR CODE	RATING	AWG	CABLE LENGTH	PART NUMBER
2		1. Black 2. White	600V, 18A	14	6' 12' 18'	X8651-78P X8651-80P X8651-82P
3		1. Black 2. White 3. Green	600V, 18A	14	6' 12' 18'	X8652-92P X8652-94P X8652-96P
4		1. Black 2. Green 3. Red 4. White	600V, 15A	14	6' 12' 18'	X8653-92P X8653-94P X8653-96P

Note: Special lengths available upon request — consult factory.



CHANGE-OUT SERIES A STOOW MALE PLUGS WITH NYLON COUPLING NUT

POLES	FACE VIEW MALE	COLOR CODE	RATING	AWG	CABLE LENGTH	PART NUMBER
2		1. Black 2. White	600V, 18A	14	6' 12' 18'	X8651-79P X8651-81P X8651-83P
3		1. Black 2. White 3. Green	600V, 18A	14	6' 12' 18'	X8652-93P X8652-95P X8652-97P
4		1. Black 2. Green 3. Red 4. White	600V, 15A	14	6' 12' 18'	X8653-93P X8653-95P X8653-97P

CHANGE-OUT SERIES A STOOW FEMALE PLUGS WITH ZINC DIECAST COUPLING NUT



POLES	FACE VIEW FEMALE	COLOR CODE	RATING	AWG	CABLE LENGTH	PART NUMBER
2		1. Black 2. White	600V, 25A	12	6' 12' 18'	X8651-528P X8651-529P X8651-644P
3		1. Black 2. White 3. Green	600V, 25A	12	6' 12' 18'	X8652-528P X8652-529P X8652-644P
4		1. Black 2. Green 3. Red 4. White	600V, 20A	12	6' 12' 18'	X8653-528P X8653-529P X8653-644P

CHANGE-OUT SERIES A STOOW MALE PLUGS WITH ZINC DIECAST COUPLING NUT



POLES	FACE VIEW MALE	COLOR CODE	RATING	AWG	CABLE LENGTH	PART NUMBER
2		1. Black 2. White	600V, 25A	12	6' 12' 18'	X8651-516P X8651-517P X8651-640P
3		1. Black 2. White 3. Green	600V, 25A	12	6' 12' 18'	X8652-516P X8652-517P X8652-640P
4		1. Black 2. Green 3. Red 4. White	600V, 20A	12	6' 12' 18'	X8653-516P X8653-517P X8653-640P

Note: Special lengths available upon request — consult factory.



CHANGE-OUT SERIES A STOOW FEMALE PLUGS WITH NYLON COUPLING NUT

POLES	FACE VIEW FEMALE	COLOR CODE	RATING	AWG	CABLE LENGTH	PART NUMBER
2		1. Black 2. White	600V, 25A	12	6' 12' 18'	X8651-1528P X8651-1529P X8651-1644P
3		1. Black 2. White 3. Green	600V, 25A	12	6' 12' 18'	X8652-1528P X8652-1529P X8652-1644P
4		1. Black 2. Green 3. Red 4. White	600V, 20A	12	6' 12' 18'	X8653-1528P X8653-1529P X8653-1644P

CHANGE-OUT SERIES A STOOW MALE PLUGS WITH NYLON COUPLING NUT



POLES	FACE VIEW MALE	COLOR CODE	RATING	AWG	CABLE LENGTH	PART NUMBER
2		1. Black 2. White	600V, 25A	12	6' 12' 18'	X8651-1516P X8651-1517P X8651-1640P
3		1. Black 2. White 3. Green	600V, 25A	12	6' 12' 18'	X8652-1516P X8652-222P X8652-1640P
4		1. Black 2. Green 3. Red 4. White	600V, 20A	12	6' 12' 18'	X8653-1516P X8653-1517P X8653-1640P

CHANGE-OUT SERIES A STOOW FEMALE PLUGS WITH ZINC DIECAST COUPLING NUT



POLES	FACE VIEW FEMALE	COLOR CODE	RATING	AWG	CABLE LENGTH	PART NUMBER
2		1. Black 2. White	600V, 30A	10	6' 12' 18'	X8651-645P X8651-646P X8651-647P
3		1. Black 2. White 3. Green	600V, 30A	10	6' 12' 18'	X8652-645P X8652-646P X8652-647P
4		1. Black 2. Green 3. Red 4. White	600V, 25A	10	6' 12' 18'	X8653-645P X8653-646P X8653-647P

Note: Special lengths available upon request — consult factory.



CHANGE-OUT SERIES A STOOV MALE PLUGS WITH ZINC DIECAST COUPLING NUT

POLES	FACE VIEW MALE	COLOR CODE	RATING	AWG	CABLE LENGTH	PART NUMBER
2		1. Black 2. White	600V, 30A	10	6' 12' 18'	X8651-641P X8651-642P X8651-643P
3		1. Black 2. White 3. Green	600V, 30A	10	6' 12' 18'	X8652-641P X8652-642P X8652-643P
4		1. Black 2. Green 3. Red 4. White	600V, 25A	10	6' 12' 18'	X8653-641P X8653-642P X8653-643P

CHANGE-OUT SERIES A STOOV FEMALE PLUGS WITH NYLON COUPLING NUT



POLES	FACE VIEW FEMALE	COLOR CODE	RATING	AWG	CABLE LENGTH	PART NUMBER
2		1. Black 2. White	600V, 30A	10	6' 12' 18'	X8651-1645P X8651-1646P X8651-1647P
3		1. Black 2. White 3. Green	600V, 30A	10	6' 12' 18'	X8652-1645P X8652-1646P X8652-1647P
4		1. Black 2. Green 3. Red 4. White	600V, 25A	10	6' 12' 18'	X8653-1645P X8653-1646P X8653-1647P

CHANGE-OUT SERIES A STOOV MALE PLUGS WITH NYLON COUPLING NUT



POLES	FACE VIEW MALE	COLOR CODE	RATING	AWG	CABLE LENGTH	PART NUMBER
2		1. Black 2. White	600V, 30A	10	6' 12' 18'	X8651-1641P X8651-1642P X8651-1643P
3		1. Black 2. White 3. Green	600V, 30A	10	6' 12' 18'	X8652-1641P X8652-1642P X8652-1643P
4		1. Black 2. Green 3. Red 4. White	600V, 25A	10	6' 12' 18'	X8653-1641P X8653-1642P X8653-1643P

Note: Special lengths available upon request — consult factory.

CHANGE-OUT SERIES A "SO" FEMALE PLUGS WITH ZINC DIECAST COUPLING NUT





POLES	FACE VIEW FEMALE	COLOR CODE	RATING	AWG	CABLE LENGTH	PART NUMBER
5		1. Red 2. White 3. Black 4. Orange 5. Green	300V, 6A	18	6' 12' 18'	X8872-5A X8872-7A X8872-9A
6		1. Red 2. White 3. Black 4. Blue 5. Orange 6. Green	300V, 6A	18	6' 12' 18'	X8871-5A X8871-7A X8871-9A
7		1. Red 2. White 3. Black 4. Blue 5. Orange 6. Green 7. White-Black	300V, 5A	18	6' 12' 18'	X8870-5A X8870-8A X8870-10A

CHANGE-OUT SERIES A "SO" MALE PLUGS WITH ZINC DIECAST COUPLING NUT





POLES	FACE VIEW MALE	COLOR CODE	RATING	AWG	CABLE LENGTH	PART NUMBER
5		1. Red 2. White 3. Black 4. Orange 5. Green	300V, 6A	18	6' 12' 18'	X8872-6A X8872-8A X8872-10A
6		1. Red 2. White 3. Black 4. Blue 5. Orange 6. Green	300V, 6A	18	6' 12' 18'	X8871-6A X8871-8A X8871-10A
7		1. Red 2. White 3. Black 4. Blue 5. Orange 6. Green 7. White-Black	300V, 5A	18	6' 12' 18'	X8870-6A X8870-9A X8870-11A

Note: Special lengths available upon request — consult factory.

CHANGE-OUT SERIES A "SO" FEMALE PLUGS WITH NYLON COUPLING NUT

POLES	FACE VIEW FEMALE	COLOR CODE	RATING	AWG	CABLE LENGTH	PART NUMBER
5		1. Red	300V, 6A	18	6'	X8872-15A
		2. White			12'	X8872-17A
		3. Black			18'	X8872-19A
		4. Orange				
		5. Green				
6		1. Red	300V, 6A	18	6'	X8871-21A
		2. White			12'	X8871-23A
		3. Black			18'	X8871-25A
		4. Blue				
		5. Orange				
		6. Green				
7		1. Red	300V, 5A	18	6'	X8870-16A
		2. White			12'	X8870-18A
		3. Black			18'	X8870-20A
		4. Blue				
		5. Orange				
		6. Green				
		7. White-Black				
9		1. Green	110V, 3A	18	6'	X8980-7
		2. Red				
		3. White				
		4. Black				
		5. Red-Black				
		6. White-Black				
		7. Blue				
		8. Orange				
		9. Green-Black				

CHANGE-OUT SERIES A "SO" MALE PLUGS WITH NYLON COUPLING NUT

POLES	FACE VIEW MALE	COLOR CODE	RATING	AWG	CABLE LENGTH	PART NUMBER
5		1. Red	300V, 6A	18	6'	X8872-16A
		2. White			12'	X8872-18A
		3. Black			18'	X8872-20A
		4. Orange				
		5. Green				
6		1. Red	300V, 6A	18	6'	X8871-22A
		2. White			12'	X8871-24A
		3. Black			18'	X8871-26A
		4. Blue				
		5. Orange				
		6. Green				
7		1. Red	300V, 5A	18	6'	X8870-17A
		2. White			12'	X8870-19A
		3. Black			18'	X8870-21A
		4. Blue				
		5. Orange				
		6. Green				
		7. White-Black				
9		1. Green	110V, 3A	18	6'	X8980-10
		2. Red				
		3. White				
		4. Black				
		5. Red-Black				
		6. White-Black				
		7. Blue				
		8. Orange				
		9. Green-Black				

Note: Special lengths available upon request — consult factory.

CHANGE-OUT SERIES B "SO" FEMALE PLUGS WITH MACHINED ALUMINUM COUPLING NUT

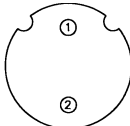
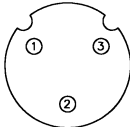
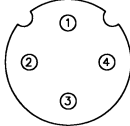
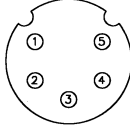
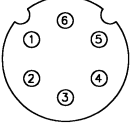
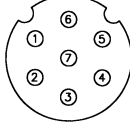
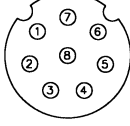
POLES	FACE VIEW FEMALE	COLOR CODE	RATING	AWG	CABLE LENGTH	PART NUMBER
2		1. White 2. Black	600V, 25A	10	6' 12' 18'	X8881-5 X8881-7 X8881-9
3		1. Black 2. White 3. Green	600V, 25A	10	6' 12' 18'	X8880-5 X8880-7 X8880-9
4		1. Red 2. White 3. Black 4. Green	600V, 20A	10	6' 12' 18'	X8879-5 X8879-7 X8879-9
5		1. Red 2. White 3. Black 4. Orange 5. Green	600V, 20A	10	6' 12' 18'	X8878-5 X8878-7 X8878-9
6		1. Red 2. White 3. Black 4. Blue 5. Orange 6. Green	600V, 20A	10	6' 12' 18'	X8877-7 X8877-9 X8877-11
7		1. Red 2. White 3. Black 4. Blue 5. Orange 6. Green 7. White-Black	600V, 18A	10	6' 12' 18'	X8876-7 X8876-9 X8876-11
8		1. Red 2. White 3. Black 4. White-Black 5. Blue 6. Orange 7. Green 8. Red-Black	600V, 11A	14	6' 12' 18'	X8916-5 X8916-6 X8916-7

Note: Special lengths available upon request — consult factory.

CHANGE-OUT SERIES B "SO" MALE PLUGS WITH DIECAST ALUMINUM COUPLING NUT

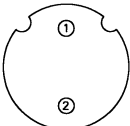
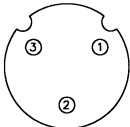
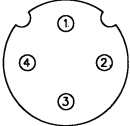
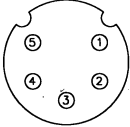
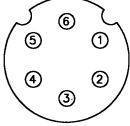
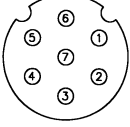
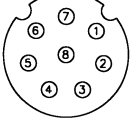
POLES	FACE VIEW MALE	COLOR CODE	RATING	AWG	CABLE LENGTH	PART NUMBER
2		1. White 2. Black	600V, 25A	10	6' 12' 18'	X8881-6B X8881-8B X8881-10B
3		1. Black 2. White 3. Green	600V, 25A	10	6' 12' 18"	X8880-6B X8880-8B X8880-10B
4		1. Red 2. White 3. Black 4. Green	600V, 20A	10	6' 12' 18'	X8879-6B X8879-8B X8879-10B
5		1. Red 2. White 3. Black 4. Orange 5. Green	600V, 20A	10	6' 12' 18'	X8878-6B X8878-8B X8878-10B
6		1. Red 2. White 3. Black 4. Blue 5. Orange 6. Green	600V, 20A	10	6' 12' 18'	X8877-8B X8877-10B X8877-12B
7		1. Red 2. White 3. Black 4. Blue 5. Orange 6. Green 7. White-Black	600V, 18A	10	6' 12' 18'	X8876-8B X8876-10B X8876-12B
8		1. Red 2. White 3. Black 4. White-Black 5. Blue 6. Orange 7. Green 8. Red-Black	600V, 11A	14	6' 12' 18'	X8916-8B X8916-9B X8916-10B

Note: Special lengths available upon request — consult factory.