

Operating instructions for your

Cobra®

75 WXST

COMPACT REMOTE MOUNT CB RADIO WITH SOUNDTRACKER

Cobra®

COBRA ELECTRONICS CORPORATION
6500 W. Cortland Street
Chicago, Illinois 60707

www.cobra.com

SOUNDTRACKER®
SYSTEM

“Cuts Noise Coming In... Strengthens Signals Going Out”



How to use your

Cobra® 75WXST

CITIZENS BAND RADIO WITH SOUNDTRACKER®

CONTENTS:

Introduction	3	Operation (continued)	
Features	3	Transmit / Receive.....	17
Technical Support and service	3	One Touch Channel 9 & 19.....	18
Controls and Indicators	4/5	Key Lock.....	18
Included with your 75WX	6	Frequency Display.....	19
Installation	7	All Channel Scan.....	20
Connector Box Location.....	7	Weather Channel.....	21
Mounting Connector Box.....	8	Channel Saver.....	21
Microphone Hanger.....	9	Memory Channels.....	22
Antenna.....	10	Dual Watch.....	23
Speakers.....	11	How your CB can serve you	24
Noise Interference.....	11	A few rules you should know.....	24
SoundTracker® System.....	11	Weather Channel Messages.....	25
Operation	12	Channel 9 Emergency Messages.....	26
Turning your CB On.....	12	CB 10 Codes.....	27
Activating SoundTracker.....	12	Frequency Ranges	28
Testing SoundTracker.....	13	Specifications	29
Setting the Squelch.....	14	Warranty Information	30
Selecting a Channel.....	15	Optional Accessories	31
LCD Readout.....	16		

INTRODUCTION

The Cobra 75WXST is the ultimate in handheld CB receivers, specially designed with SoundTracker®, which practically eliminates annoying static to deliver crisp, clear sound quality. The compact, state-of-the-art design provides consistent, outstanding performance in almost all conditions or situations. For ultimate satisfaction and performance from your Cobra 75WXST, please review these operating instructions fully, prior to use.

FEATURES

- SoundTracker System
- 40 CB Radio Channels
- 10 Weather Channels
- One-touch Emergency Channel 9
- Remote Mount Installation System
- Full Featured LCD Display Panel
- Squelch Control
- Key Lock
- Channel Saver Circuitry
- Dual Watch Channel Monitor
- Full Channel Scan
- Four Memory Locations
- 10-Foot Flexible Cord
- Quick Disconnect

TECHNICAL SUPPORT

For technical assistance, please call our Automated Help Desk which can assist you by answering the most frequently asked questions about Cobra products.

(773) 889-3087

24 hours a day, 7 days a week.

A consumer Service Representative can be reached through this number

8:00 am - 5:30 pm, Monday through Friday, Central Time.

INTRODUCTION

CONTROLS AND INDICATORS



INTRODUCTION

CONTROLS AND INDICATORS

5

1. SoundTracker® Key
2. Memory Key
3. Channel 9 / 19 Key / Memory Location 1 Key
4. LCD Display Panel
5. Dual Watch / Memory Location 2 Key
6. Scan / Memory Location 3 Key
7. CB-Weather Channel / Memory Location 4 Key
8. On / Off / Volume Control
9. Lock Key
10. Squelch Control
11. Channel Up
12. Channel Down
13. PTT (Push-To-Talk) Key
14. Microphone
15. Speaker

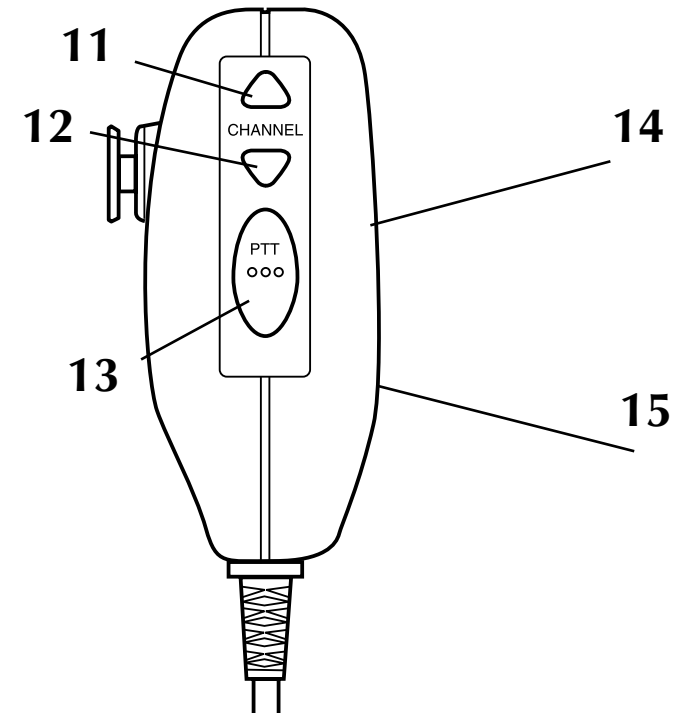

INTRODUCTION

COMPONENTS INCLUDED

6

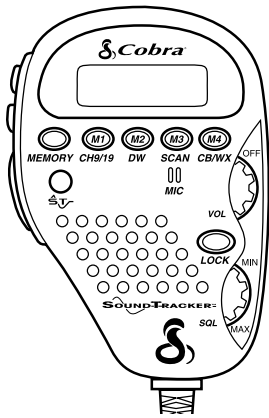

75WXST Transceiver

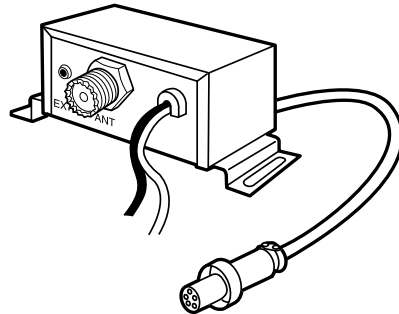

Connector Box

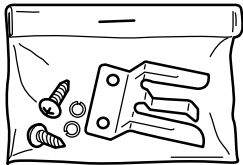

Installation Hardware



Operating Manual

INSTALLATION

CONNECTOR BOX LOCATION

7

LOCATION

Mount your Cobra 75WXST Connector Box in a convenient location, away from moisture and direct sunlight, in a location that will not interfere with driving.

Cobra suggests mounting it either under the front seat or on the fire wall.

UNDER THE FRONT SEAT INSTALLATION

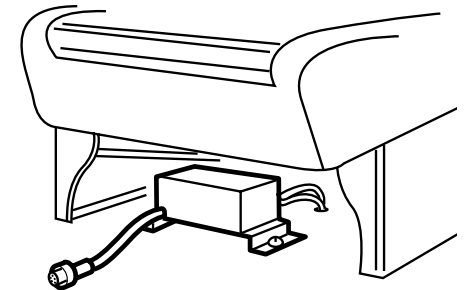

FIRE WALL INSTALLATION

NOTE: Do not mount under the hood, near heat ducts, in direct line of the car's heater or near gas and brake pedals.

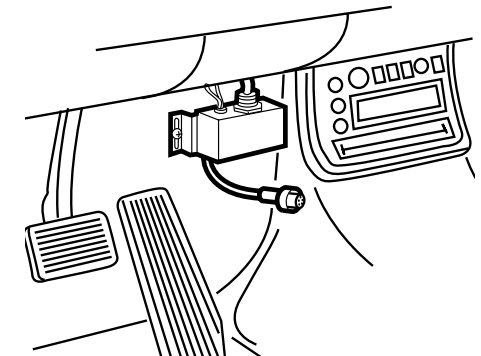

INSTALLATION

CONNECTOR BOX

8

MOUNTING CONNECTOR BOX

1. Hold the Cobra 75WXST Connector Box in exact location desired for mounting.
2. Using it as a template, mark the location for the mounting screws (included).

NOTE: Make certain that nothing will interfere with the installation of the mounting screws, before drilling holes.

3. Drill and mount the Connector Box as shown.

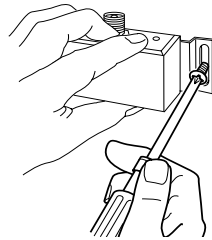
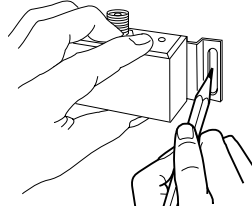

CONNECTING WIRES

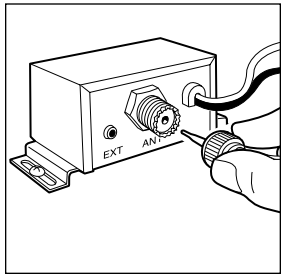

4. Connect the antenna cable plug.

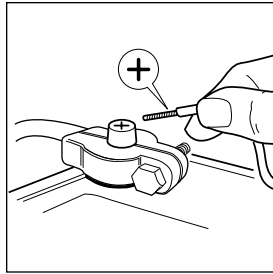

5. Connect the red wire marked "BATT" (+) directly to the positive side of the battery or to a connection on the fuse box that is always on.

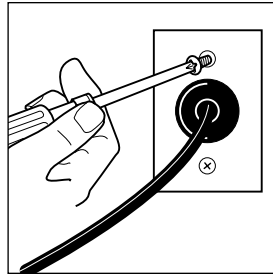

6. Connect the black leader marked "Ground" to the negative side of the car, usually the chassis. Any other location with good electrical contact (paint removed) will also work.

INSTALLATION

MICROPHONE HANGER

9

INSTALLING MICROPHONE HANGER

1. Hold the microphone hanger in location desired for mounting. Make certain that nothing will interfere with the hanger's installation.
2. Mark the location for the three mounting screws (included).
3. Drill and mount the microphone hanger as shown.

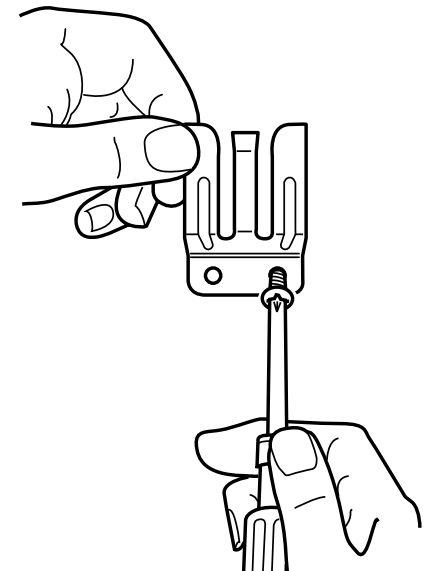
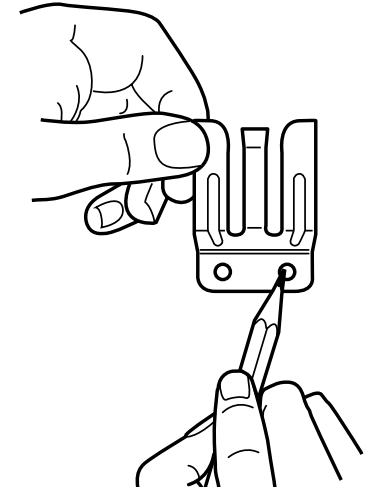

INSTALLATION

CB ANTENNA

10

Be sure the antenna is properly connected to the radio before transmitting. Prolonged transmitting without an antenna, or use of a poorly matched antenna, could cause damage to the transmitter.

For the most reliable operation and maximum range, Cobra recommends using a vertically polarized, quarter-length whip antenna (illustration 1).

Shorter, loaded-type whips are adequate when maximum range is not required (illustration 2).

NOTE: Mobile installations (cars, trucks, boats, etc) should be made only with a non-directional antenna system.

- A standard antenna connector (Type SO-239) is provided on the Connector Box for easy connection to a standard PL-259 cable termination.
- Cobra antenna models are recommended; see your local CB dealer or order directly from Cobra.
- For maximum efficiency in boat installations, a ground plate is required, unless the vessel has a steel hull. Consult your CB dealer for information regarding an adequate grounding system.

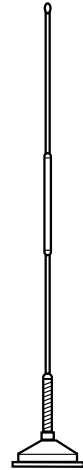

Illustration 1

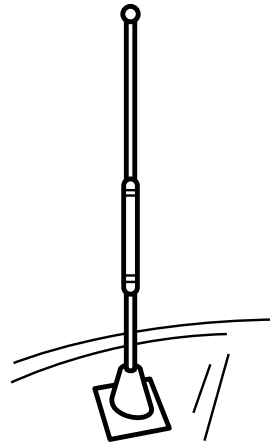
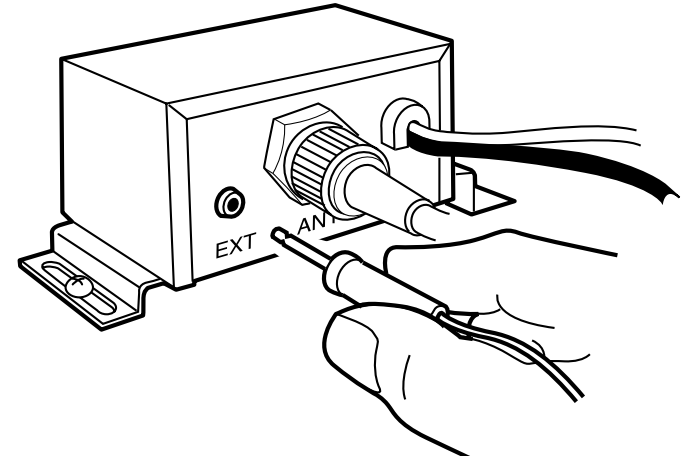

Illustration 2

INSTALLATION

SPEAKERS/NOISE INTERFERENCE

11



1. Mount external speaker in desired location as shown
2. Plug into the back of the Connector Box

*The external speaker should have 4-8 ohms impedance and be able to handle at least 4 watts.

IGNITION NOISE INTERFERENCE

The alternator and ignition system in your vehicle may limit your ability to receive low signal levels.

Other noise interference can be the result of several different installation variables. Consult your Cobra dealer or a 2-way radio technician to help locate and correct the source of severe noise interference.

SOUNDTRACKER® SYSTEM

While previous systems only “blanked out” or limited noise in higher sound frequencies, the revolutionary new SoundTracker® System actually reduces noise while leaving the signal in the reception mode.

In transmission mode, it actually strengthens the signal, providing you with a significant reduction in noise.

OPERATION

TURNING ON/ACTIVATING SOUNDTRACKER®

12

TURNING YOUR CB ON

1. Rotate the power ON-OFF Volume Control clockwise.
2. Open the Squelch Control counterclockwise until noise is heard.
3. Adjust volume to a comfortable level.

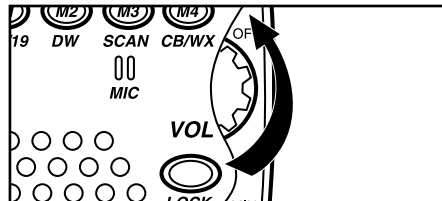
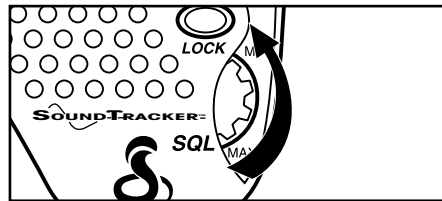
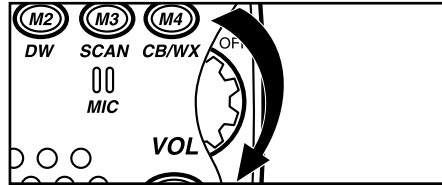

ACTIVATING SOUNDTRACKER®

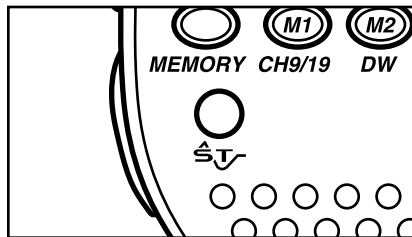

1. Depress the SoundTracker® key.
2. **ST** will be displayed on the LCD readout.

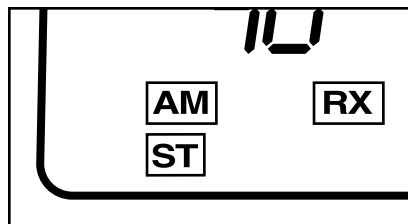

OPERATION

TESTING SOUNDTRACKER®

13

TESTING SOUNDTRACKER®

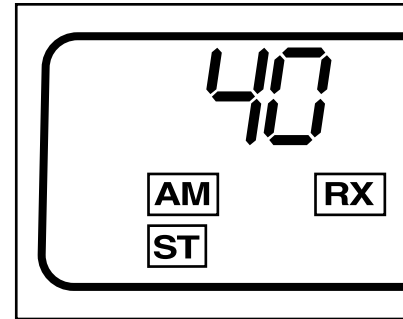

1. Select any unused channel on your CB

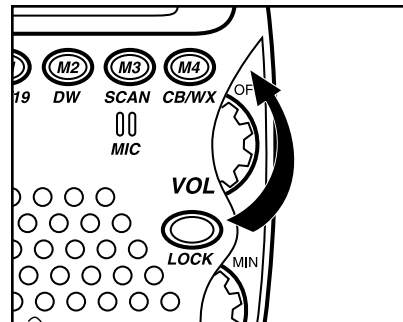

3. Turn the volume up louder than your normal listening level.

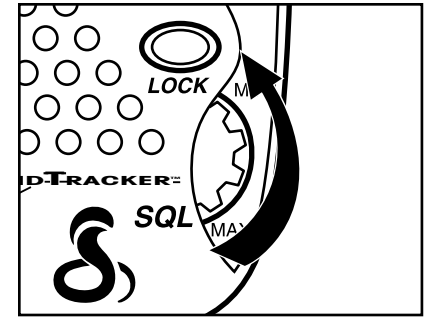

2. Open the squelch control fully by turning the knob counterclockwise until it stops.

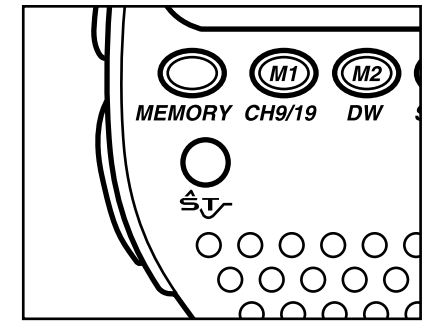

5. Depress the SoundTracker® key. Notice the significant reduction in noise.

OPERATION

SETTING THE SQUELCH

14

SETTING THE SQUELCH

Think of your Squelch Control as a gate for incoming signals. If you turn the Squelch Control fully clockwise, you effectively close the “gate” and no signals will pass through. If you turn the Squelch control fully counterclockwise, you open the gate and all signals come through.

To achieve the **Desired Squelch Setting (DSS)**:

1. Turn SoundTracker on

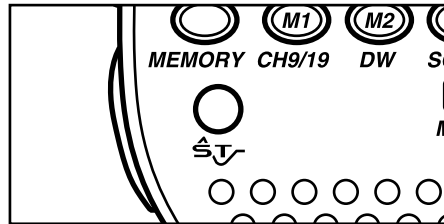

2. Turn the Squelch Control (SQL) counterclockwise until you hear nothing but static.

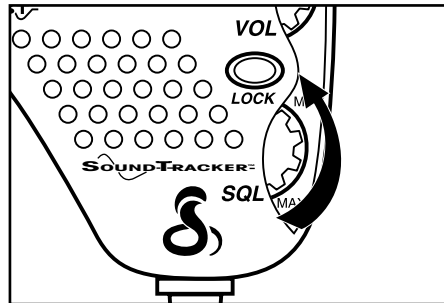

3. Slowly turn the Squelch Control back clockwise, just until the static stops. This is the optimum receiving level, **Desired Squelch Setting (DSS)** allowing only strong signals to come through.

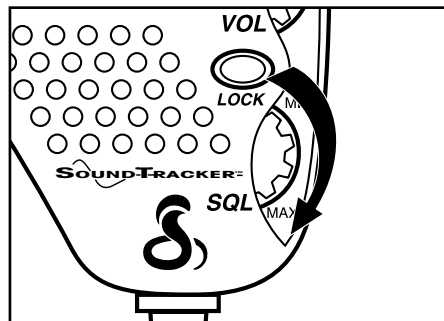

OPERATION

SELECTING A CHANNEL

15

SELECTING A CHANNEL

1. Change channels by pressing either the channel ▲ up or channel ▼ down key.

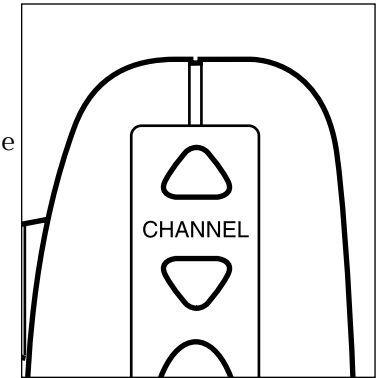

2. To quick-advance channels, press and hold either key.

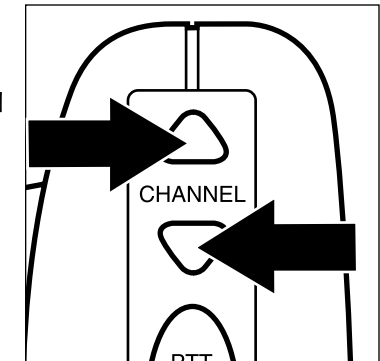

OPERATION

LCD READOUT

16

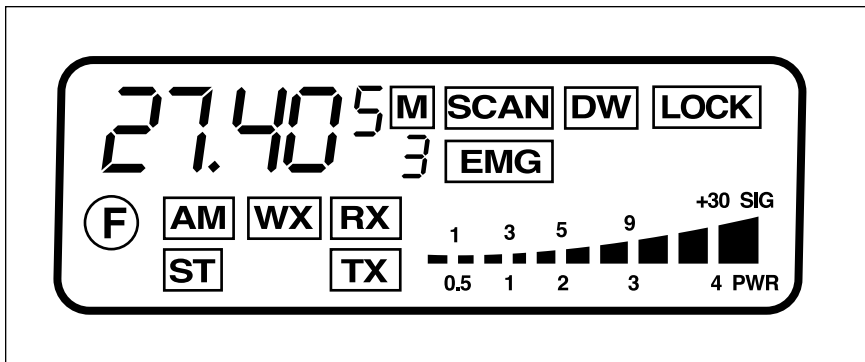

LCD DISPLAY

Your Cobra 75WXST CB is designed with a liquid crystal display that indicates channel number, frequency and the operating mode.

2 digit channel display 5 digit frequency display

- F** = Function Key Indicator
- ST** = SoundTracker® Indicator
- AM** = Amplitude Modulation
- WX** = Weather Station
- TX** = Transmit Indicator
- RX** = Receive Indicator
- M** = Memory Indicator

Memory Channel Number

- Scan** = Scan Indicator
- DW** = Dual Watch Indicator
- EMG** = Emergency Channel 9
- SAVE** = Lock Key Indicator
- LOCK** = Battery Low Indicator

Signal Strength Meter

NOTE: To avoid damaging the LCD display, do not subject your CB radio to extreme temperatures (below -5°F or above 140°F) for extended periods of time.

OPERATION

TRANSMIT/RECEIVE

17

TO RECEIVE

1. Your 75WXST is automatically in receive mode.

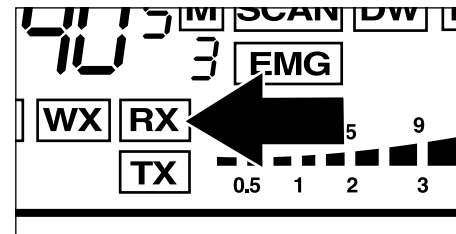

TO TRANSMIT

2. Press the Press-To-Talk (PTT) key.

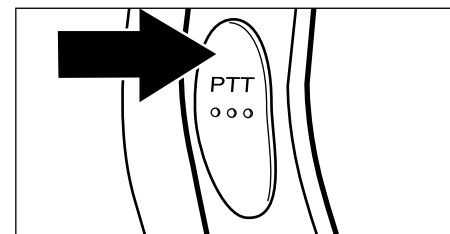

3. Hold the microphone about 2 inches from your mouth and speak in a normal voice.

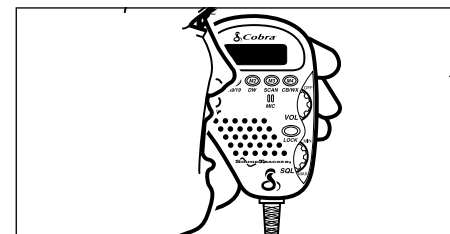

4. Release the PTT button and you will automatically be in receive mode again.

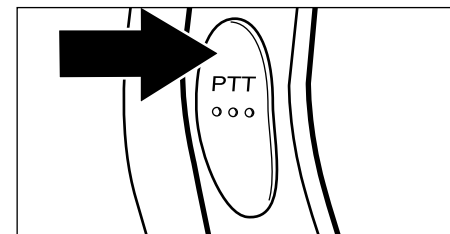

OPERATION

ONE TOUCH CHANNEL 9 AND 19/KEY LOCK

18

EMERGENCY CHANNEL 9 OR INFORMATION CHANNEL 19

1. To access emergency channel 9, press the Channel 9/19 key once.

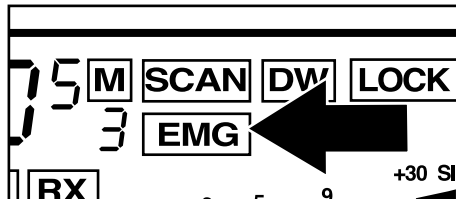

2. To access information channel 19, press the Channel 9/19 key a second time.

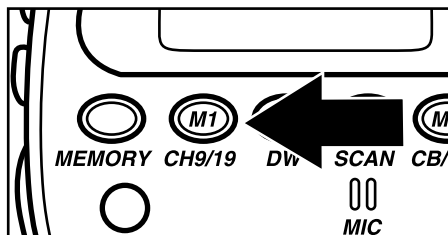

3. Press again to return to the original channel selected.

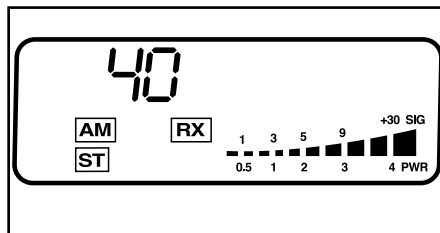

KEY LOCK

1. Press Key Lock button to prevent unintentional channel changing; Press a second time to deactivate.

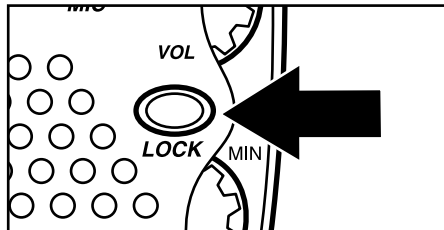

OPERATION

FREQUENCY DISPLAY

19

5 DIGIT FREQUENCY DISPLAY

1. Push and hold Memory key for approximately 3 seconds.

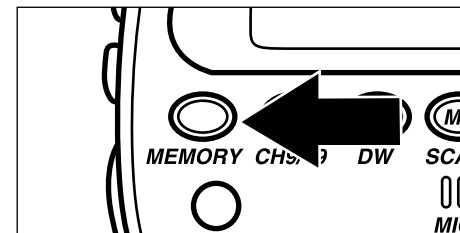

2. Display will change to the 5 digit frequency of the channel selected.

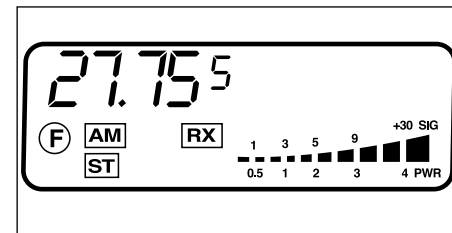

3. Push and hold Memory key until display changes back.

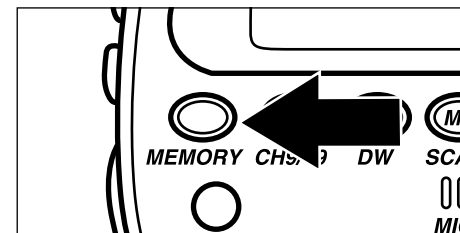

OPERATION

CHANNEL SCAN

20

ALL CHANNEL SCAN

1. Set **Desired Squelch Setting (DSS)**.

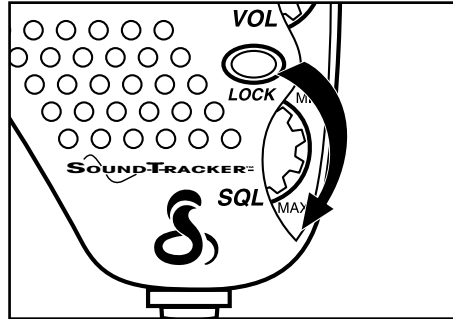

2. Press Scan key. When activity is found on a channel scanning will stop.

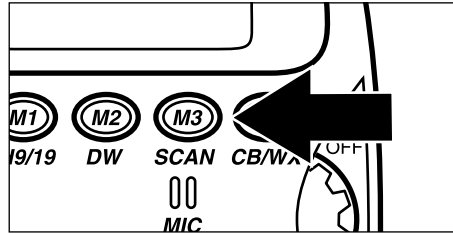

Five seconds after the activity stops, the 75WXST will resume scanning.

3. Press any key to stop scanning sequence.

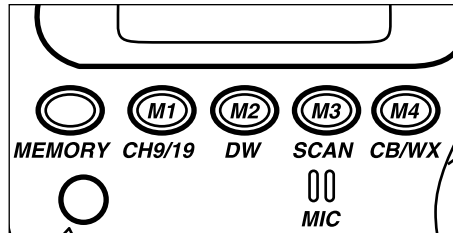

OPERATION

WEATHER CHANNELS/CHANNEL SAVER

21

WEATHER CHANNELS

1. Press the CB/WX key.

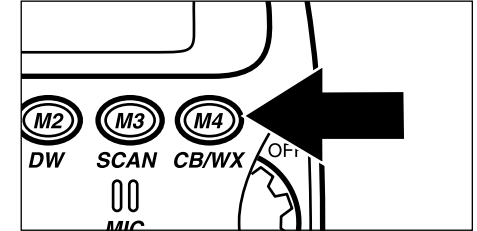

2. Press Up/Down Channel keys to change stations.

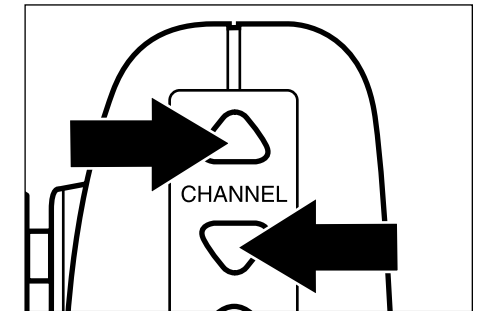

3. Press the CB/WX key again to resume normal CB operation.

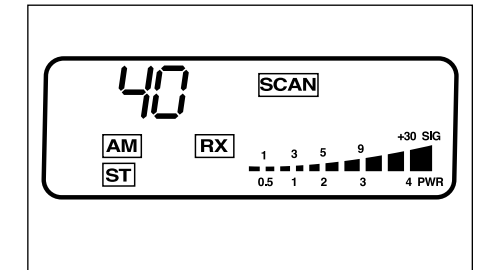

CHANNEL SAVER FEATURE

Automatically retains the last channel used when CB is turned off and returns you to that channel when CB is turned back on.

To retain the last channel when the vehicle is turned off, the "red wire" must be directly connected to either:

1. Positive (+) battery terminal.
2. Connection on the fuse box that is always on.

OPERATION

MEMORY CHANNELS

22

SAVING CHANNELS IN MEMORY

1. Navigate to desired channel to store in memory.
2. Press and RELEASE the Memory key.
3. Press and hold the desired Memory Location key until selected channel is locked into memory.

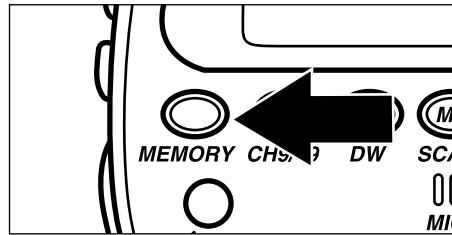
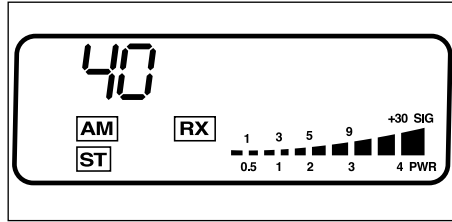

RETRIEVING CHANNELS FROM MEMORY

1. Press and release the Memory key.
2. Press and RELEASE the desired Memory Location key.

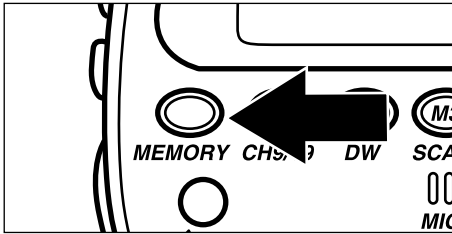

OPERATION

DUAL WATCH

23

DUAL WATCH

Allows you to simultaneously monitor any two preselected channels at one time.

1. Adjust **Desired Squelch Setting (DSS)**.
2. Set CB to one of the stations you wish to monitor.
3. Push and hold the DW key until a beep is heard.
4. Repeat steps 2 and 3 to select the second channel you want monitored.

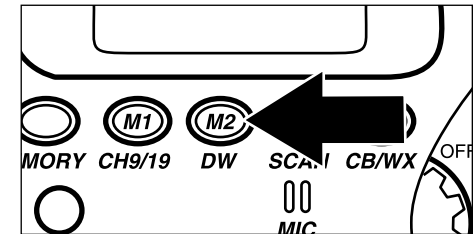
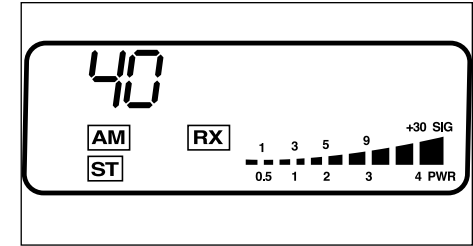
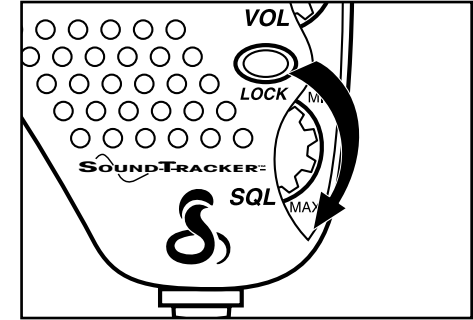

The HH75WXST will monitor both channels until it receives an incoming message.

NOTE: Five seconds after the incoming message stops, it will again scan and monitor both channels.

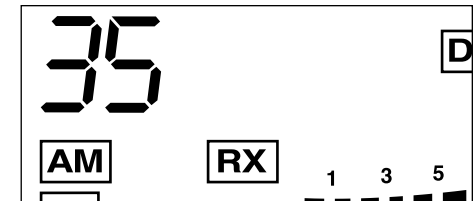

HOW YOUR CB CAN SERVE YOU

- Warn of traffic tie-ups ahead.
- Provide weather and road information.
- Provide help fast in the event of an emergency or breakdown.
- Suggest good spots to eat and sleep.
- Make long trips more interesting and help keep you awake.
- Make friends as you travel.
- Provide “local information” to find your destination.
- Communicate with friends and family during outdoor activities.
- Help law enforcement officers by reporting drunk and reckless drivers.

A FEW RULES YOU SHOULD KNOW

1. You are not allowed to carry on a conversation with another station for more than five minutes at a time without taking a one-minute break to give others a chance to use the channel.
2. You are not allowed to blast others off the air by overpowering them with illegally amplified transmitter power or illegally high antennas.
3. You can't use the CB to promote illegal activities.
4. You are not allowed to use profanity.
5. You may not play music through your CB.
6. You may not use your CB to sell merchandise or professional service.

WEATHER CHANNEL MESSAGES

You can receive up to the minute local area weather reports provided by NOAA (National Oceanic Atmospheric Administration) 24 hours a day, 7 days a week. An agency of the U.S. Department of Commerce, NOAA warns of dangerous weather, charts our seas and skies, guides our use and protection of ocean and coastal resources and conducts research to improve our understanding and stewardship of the environment.

The National Weather Service operates about 380 stations. Approximately 90 percent of the Nation's population is within listening range of a NOAA Weather Radio broadcast.

A similar network of about 15 stations using the same frequencies broadcast continuous weather information across much of southern Canada.

If you have a question concerning NOAA Weather Radio or wish to receive a listing of NOAA Weather Radio receiver locations, please contact your nearest National Weather Service Office, or write to National Weather Service (Attn: W/OM11), National Oceanic and Atmospheric Administration, Silver Spring, MD. 20910.

Note: Some areas may not have a broadcast tower within the transmission range of your 75WX.

USE CHANNEL 9 FOR EMERGENCY ONLY

Operating Procedure for Emergency Communications

1. For **EMERGENCY** communications, **set radio to Ch. 9**. For non-emergency communications, select desired Channel by rotating the CHANNEL UP/DOWN tuning knob until reaching the desired Channel.

Be sure the antenna is properly connected to the radio before transmitting. Prolonged transmitting without an antenna, or use of a poorly matched antenna, could cause damage to the transmitter.

2. When asking for aid on Channel 9 it is suggested that you request a **REACT** base to respond by saying "Break Channel 9 for a REACT base" and provide the **CB DISTRESS DATA (called "CLIP")**:

CALL SIGN-Identify yourself and vehicle.

LOCATION-Be exact.

INJURIES-Number. Type. Trapped?

PROBLEM- Give details and help required. Air **CLIP** repeatedly so any monitor can aid you.

If you don't receive a response on Ch. 9; try Ch.14 or 19.

FCC gives the following examples of permitted and prohibited types of communications for use on Channel 9. These are guidelines and are not intended to be all-inclusive.

Permitted	Example Message
Yes	"A tornado sighted six miles north of town."
No	"This is observation post number 10. No tornado sighted."
Yes	"I am out of gas on Interstate 95 at mile marker 121."
No	"I am out of gas in my driveway."
Yes	"There is a four-car collision at Exit 10 on the Beltway, send police and ambulance."
No	"Traffic is moving smoothly on the Beltway."
Yes	"Base to Unit 1, the Weather Bureau has just issued a thunderstorm warning. Bring the sailboat into port."
No	"Attention all motorists. The Weather Bureau advises that the snow tomorrow will accumulate 4 to 6 inches."
Yes	"There is a fire in the building on the corner of 6th and Main Streets."
No	"This is Halloween patrol unit number 3. Everything is quiet here."

CB 10-CODES

Citizens Band radio operators have largely adopted the "10-code" for standard questions and answers. Its use permits faster communications and better understanding in noisy areas. The following table lists some of the more common codes and their meanings:

Code	Meaning	Code	Meaning
10-1	Receiving poorly	10-37	Wrecker needed at
10-2	Receiving well	10-38	Ambulance needed at
10-3	Stop transmitting	10-39	Your message delivered
10-4	OK, message received	10-41	Please turn to channel
10-5	Relay message	10-42	Traffic accident at
10-6	Busy, stand by	10-43	Traffic Tie up at
10-7	Out of service, leaving air	10-44	I have a message for you
10-8	In service, subject to call	10-45	All units within range please report
10-9	Repeat message	10-50	Break channel
10-10	Transmission completed, standing by	10-60	What is next message number?
10-11	Talking too rapidly	10-62	Unable to copy, use phone
10-12	Visitors present	10-63	Net directed to
10-13	Advise Weather/Road conditions	10-64	Net clear
10-16	Make pick up at	10-65	Awaiting your next message/assignment
10-17	Urgent business	10-67	All units comply
10-18	Anything for us?	10-70	Fire at
10-19	Nothing for you, return to base	10-71	Proceed with transmission in sequence
10-20	My location is	10-77	Negative contact
10-21	Call by telephone	10-81	Reserve hotel room for
10-22	Report in person to	10-82	Reserve room for
10-23	Stand by	10-84	My telephone number is
10-24	Completed last assignment	10-85	My address is
10-25	Can you contact	10-91	Talk closer to mike
10-26	Disregard last information	10-93	Check my frequency on this channel
10-27	I am moving to channel	10-94	Please give me a long count
10-28	Identify your station	10-99	Mission completed, all units secure
10-29	Time is up for contact	10-200	Police needed at
10-30	Does not conform to FCC rules		
10-32	I will give you a radio check		
10-33	EMERGENCY TRAFFIC		
10-34	Trouble at this station		
10-35	Confidential information		
10-36	Correct time is		

FREQUENCY RANGE

Your COBRA transceiver represents one of the most advanced AM two-way radios used as a Class D station in the Citizens Radio Service. This unit features advanced Phase Lock Loop (PLL) circuitry providing complete coverage of all 40 CB channels and 10 weather channels as shown below.

CB Channel	Channel Freq. in MHz	CB Channel	Channel Freq. in MHz	Weather Channel	Weather Freq. in MHz
1	26.965	21	27.215		
2	26.975	22	27.225	1	162.550
3	26.985	23	27.255	2	162.400
4	27.005	24	27.235	3	162.475
5	27.015	25	27.245	4	162.425
6	27.025	26	27.265	5	162.450
7	27.035	27	27.275	6	162.500
8	27.055	28	27.285	7	162.525
9	27.065	29	27.295	8	161.650
10	27.075	30	27.305	9	161.775
11	27.085	31	27.315	0	163.275
12	27.105	32	27.325		
13	27.115	33	27.335		
14	27.125	34	27.345		
15	27.135	35	27.355		
16	27.155	36	27.365		
17	27.165	37	27.375		
18	27.175	38	27.385		
19	27.185	39	27.395		
20	27.205	40	27.405		

This device complies with part 15 of the FCC rules. Operation is subject to the following conditions:

1. This device may not cause harmful interference
2. This device must accept any interference received, including interference that may cause undesired operation.

75WXST SPECIFICATIONS

GENERAL

CHANNELS

CB - 40 CH

WEATHER - 10 CH

FREQUENCY RANGE

CB - 26.965 TO 27.405 MHZ

WEATHER - 161.650 TO 163.275 MHZ

FREQUENCY TOLERANCE

0.005 %

FREQUENCY CONTROL

PLL (PHASE LOCK LOOP) SYNTHESIZER

OPERATING TEMPERATURE RANGE

-30° C TO + 65° C

MICROPHONE

ELECTRET, PUSH-TO-TALK

INPUT VOLTAGE

12 VDC, EXTERNAL

ANTENNA CONNECTOR

S0-239

METER

LCD DISPLAY, ICONS

WEIGHT

1 lb.

TRANSMITTER

POWER OUTPUT

4.0 W AT 13.8 VDC

MODULATION

AM

FREQUENCY RESPONSE

300 - 3000 HZ AT -6 DB

OUTPUT IMPEDANCE

50 OHMS, UNBALANCED

RECEIVER

CB

SENSITIVITY

LESS THAN 1 μ V FOR 10 DB S/N

IF FREQUENCY

DUAL CONVERSION

AUDIO OUTPUT

1 ST - 10.690 MHZ, 2ND - 455 KHZ

FREQUENCY RESPONSE

500 mW MAXIMUM AT 10 % DISTORTION

2ND IF IMAGE REJECTION

300 - 3000 HZ AT -6 DB

ADJACENT CH. REJECTION

GREATER THAN 60 DB

AUTOMATIC NOISE LIMITER

50 DB MIN.

FREQUENCY CONTROL

BUILT- IN

PLL (PHASE LOCK LOOP)

WEATHER

SENSITIVITY

LESS THAN 1 μ V FOR 12 DB SINAD

IF FREQUENCY

DUAL CONVERSION

1st: -10.690 MHZ

2nd: -455 KHZ

AUDIO OUTPUT

MAXIMUM 500 mW AT 10 % DISTORTION

FREQUENCY RESPONSE

300 - 3000 HZ AT -6 DB

EMERGENCY ALERT TONE

1050 HZ, TONE DECODER

LIMITED TWO YEAR WARRANTY

COBRA ELECTRONICS CORPORATION warrants that its COBRA CB Radios, and the component parts thereof, will be free of defects in workmanship and materials for period of two (2) years from the date of first consumer purchase.

This warranty may be enforced by the first consumer purchaser, provided that the product is utilized within the U.S.A.

COBRA will, without charge, repair or replace, at its option, defective CB radios, products or component parts upon delivery to the COBRA factory Service Department, accompanied by proof of the date of first consumer purchase, such as a duplicated copy of a sales receipt.

You must pay any initial shipping charges required to ship the product for warranty service, but the return charges will be at Cobra's expense, if the product is repaired or replaced under warranty. For further details concerning procedures for obtaining service, see the "If You Think You Need Service" section of the Owner's Manual.

Exclusions: This limited warranty does not apply; 1) to any product damaged by accident; 2) in the event of misuse or abuse of the product or as a result of unauthorized alterations or repairs; 3) if the serial number has been altered, defaced or removed; 4) if the owner of the product resides outside the U.S.A.

All implied warranties, including warranties of merchantability and fitness for a particular purpose are limited in duration to the length of this warranty.

COBRA shall not be liable for any incidental, consequential or other damages; including, without limitation, damages resulting from loss of use or cost of installation.

Some states do not allow limitations on how long an implied warranty lasts and/or do not allow the exclusion or limitation of incidental or consequential damages, so the above limitations may not apply to you.

COBRA ELECTRONICS CORPORATION
6500 W. Cortland Street
Chicago, Illinois 60707

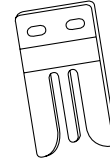

Replacement
Microphone Bracket
For in vehicle use
741-080-9-001



Dynamic External Speaker
HG S100

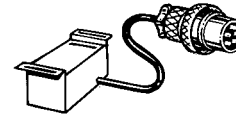

Remote Connector Box
AC-701



Noise Canceling
External Speaker
HG S300

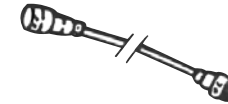

4 Foot Extension Cord
AC-702

Optional Accessories

You can find accessories at your local Cobra dealer, or in the U.S.A. you can order directly from Cobra.

Ordering From U.S.A.
Call 773-889-3087 for pricing or visit www.cobra.com.

To order online
please visit our website:
www.cobra.com