



## **Cisco IAD2430 Series Integrated Access Devices Hardware Installation Guide**

### **Americas Headquarters**

Cisco Systems, Inc.  
170 West Tasman Drive  
San Jose, CA 95134-1706  
USA  
<http://www.cisco.com>  
Tel: 408 526-4000  
800 553-NETS (6387)  
Fax: 408 527-0883

THE SPECIFICATIONS AND INFORMATION REGARDING THE PRODUCTS IN THIS MANUAL ARE SUBJECT TO CHANGE WITHOUT NOTICE. ALL STATEMENTS, INFORMATION, AND RECOMMENDATIONS IN THIS MANUAL ARE BELIEVED TO BE ACCURATE BUT ARE PRESENTED WITHOUT WARRANTY OF ANY KIND, EXPRESS OR IMPLIED. USERS MUST TAKE FULL RESPONSIBILITY FOR THEIR APPLICATION OF ANY PRODUCTS.

THE SOFTWARE LICENSE AND LIMITED WARRANTY FOR THE ACCOMPANYING PRODUCT ARE SET FORTH IN THE INFORMATION PACKET THAT SHIPPED WITH THE PRODUCT AND ARE INCORPORATED HEREIN BY THIS REFERENCE. IF YOU ARE UNABLE TO LOCATE THE SOFTWARE LICENSE OR LIMITED WARRANTY, CONTACT YOUR CISCO REPRESENTATIVE FOR A COPY.

The following information is for FCC compliance of Class A devices: This equipment has been tested and found to comply with the limits for a Class A digital device, pursuant to part 15 of the FCC rules. These limits are designed to provide reasonable protection against harmful interference when the equipment is operated in a commercial environment. This equipment generates, uses, and can radiate radio-frequency energy and, if not installed and used in accordance with the instruction manual, may cause harmful interference to radio communications. Operation of this equipment in a residential area is likely to cause harmful interference, in which case users will be required to correct the interference at their own expense.

The following information is for FCC compliance of Class B devices: The equipment described in this manual generates and may radiate radio-frequency energy. If it is not installed in accordance with Cisco's installation instructions, it may cause interference with radio and television reception. This equipment has been tested and found to comply with the limits for a Class B digital device in accordance with the specifications in part 15 of the FCC rules. These specifications are designed to provide reasonable protection against such interference in a residential installation. However, there is no guarantee that interference will not occur in a particular installation.

Modifying the equipment without Cisco's written authorization may result in the equipment no longer complying with FCC requirements for Class A or Class B digital devices. In that event, your right to use the equipment may be limited by FCC regulations, and you may be required to correct any interference to radio or television communications at your own expense.

You can determine whether your equipment is causing interference by turning it off. If the interference stops, it was probably caused by the Cisco equipment or one of its peripheral devices. If the equipment causes interference to radio or television reception, try to correct the interference by using one or more of the following measures:

- Turn the television or radio antenna until the interference stops.
- Move the equipment to one side or the other of the television or radio.
- Move the equipment farther away from the television or radio.
- Plug the equipment into an outlet that is on a different circuit from the television or radio. (That is, make certain the equipment and the television or radio are on circuits controlled by different circuit breakers or fuses.)

Modifications to this product not authorized by Cisco Systems, Inc. could void the FCC approval and negate your authority to operate the product.

The Cisco implementation of TCP header compression is an adaptation of a program developed by the University of California, Berkeley (UCB) as part of UCB's public domain version of the UNIX operating system. All rights reserved. Copyright © 1981, Regents of the University of California.

NOTWITHSTANDING ANY OTHER WARRANTY HEREIN, ALL DOCUMENT FILES AND SOFTWARE OF THESE SUPPLIERS ARE PROVIDED "AS IS" WITH ALL FAULTS. CISCO AND THE ABOVE-NAMED SUPPLIERS DISCLAIM ALL WARRANTIES, EXPRESSED OR IMPLIED, INCLUDING, WITHOUT LIMITATION, THOSE OF MERCHANTABILITY, FITNESS FOR A PARTICULAR PURPOSE AND NONINFRINGEMENT OR ARISING FROM A COURSE OF DEALING, USAGE, OR TRADE PRACTICE.

IN NO EVENT SHALL CISCO OR ITS SUPPLIERS BE LIABLE FOR ANY INDIRECT, SPECIAL, CONSEQUENTIAL, OR INCIDENTAL DAMAGES, INCLUDING, WITHOUT LIMITATION, LOST PROFITS OR LOSS OR DAMAGE TO DATA ARISING OUT OF THE USE OR INABILITY TO USE THIS MANUAL, EVEN IF CISCO OR ITS SUPPLIERS HAVE BEEN ADVISED OF THE POSSIBILITY OF SUCH DAMAGES.

CCDE, CCENT, Cisco Eos, Cisco Lumin, Cisco Nexus, Cisco StadiumVision, Cisco TelePresence, Cisco WebEx, the Cisco logo, DCE, and Welcome to the Human Network are trademarks; Changing the Way We Work, Live, Play, and Learn and Cisco Store are service marks; and Access Registrar, Aironet, AsyncOS, Bringing the Meeting To You, Catalyst, CCDA, CCDP, CCIE, CCIP, CCNA, CCNP, CCSP, CCVP, Cisco, the Cisco Certified Internetwork Expert logo, Cisco IOS, Cisco Press, Cisco Systems, Cisco Systems Capital, the Cisco Systems logo, Cisco Unity, Collaboration Without Limitation, EtherFast, EtherSwitch, Event Center, Fast Step, Follow Me Browsing, FormShare, GigaDrive, HomeLink, Internet Quotient, IOS, iPhone, iQuick Study, IronPort, the IronPort logo, LightStream, Linksys, MediaTone, MeetingPlace, MeetingPlace Chime Sound, MGX, Networkers, Networking Academy, Network Registrar, PCNow, PIX, PowerPanels, ProConnect, ScriptShare, SenderBase, SMARTnet, Spectrum Expert, StackWise, The Fastest Way to Increase Your Internet Quotient, TransPath, WebEx, and the WebEx logo are registered trademarks of Cisco Systems, Inc. and/or its affiliates in the United States and certain other countries.

All other trademarks mentioned in this document or website are the property of their respective owners. The use of the word partner does not imply a partnership relationship between Cisco and any other company. (0809R)

*Cisco IAD2430 Series Integrated Access Devices Hardware Installation Guide*  
Copyright © 2003 - 2008 Cisco Systems, Inc. All rights reserved.



# CONTENTS

<b>Preface</b>	<b>vii</b>
Audience	vii
Organization	vii
Conventions	viii
Safety Warnings	viii
Warning Definition	ix
Product Serial Number Location	xiv
Accessibility	xv
Related Documentation	xvi
Obtaining Documentation and Submitting a Service Request	xvi

---

**CHAPTER 1**

<b>Overview of Cisco IAD2430 Series IADs</b>	<b>1</b>
Overview	1
Cisco IAD2430-24FXS IAD	3
Cisco IAD2431-8FXS IAD	3
Cisco IAD2431-16FXS	4
Cisco IAD2431-1T1E1 IAD	4
Cisco IAD2432-24FXS IAD	5
Cisco IAD2435-8FXS IAD	5
Physical Description	6
LEDs	7
Chassis Grounding	9
Memory	9
Port Numbering Conventions	9
Specifications	10
Software Elements	10
Configuration Connections	10
Configuration Methods	10
Automated Configuration	10
Manual Configuration	11
Interfaces and Service Capabilities	11
Configuration Options	13

Deployment Options 13

**CHAPTER 2**

**Planning Your Installation 1**

- Location and Mounting Requirements 1
  - Temperature Control and Ventilation 1
    - Rack-Mounted Installation 1
    - Wall-Mounted Installation 2
    - Desktop Installation 2
  - Access to Chassis 2
  - Chassis Grounding 2
  - Power Source 2
  - Cable Types 3
- Distance Limitations for Interface Cables 4
  - Fast Ethernet Maximum Distance 4
  - T1/E1-WAN Port Maximum Distances 4
  - Serial Port Maximum Distances (WIC/VIC Cards) 4
  - T1/E1-PBX Digital Voice Port Maximum Distances 6
  - FXS Analog Voice Port Maximum Distance 6
  - FXO Analog Voice Port Maximum Distance 6
- Interference Considerations 6

**CHAPTER 3**

**Installing Cisco IAD2430 Series IADs 1**

- Safety Recommendations 2
  - Maintaining Safety with Electricity 2
  - General Safety Practices 2
  - Safety Tips 2
  - Preventing Electrostatic Discharge Damage 3
- Site Log 3
- Keeping Track—Checklist 3
  - Installation Checklist 4
- Mounting Tools and Equipment 4
- Unpacking and Inspection 5
- Rack-Mounting the Chassis 6
  - Mounting Screws 7
  - Attaching the Brackets 7
  - Installing the Cisco IAD2430 Series IADs in a Rack 8
- Wall-Mounting the Chassis 9
  - Wall-Mounting the Cisco IAD2430, Cisco IAD2431, and Cisco IAD2432 IADs 9



- Desktop-Mounting the Chassis 14
  - Setting the Cisco IAD2435 on a Desktop 14
- Installing the Ground Connection 14
- Installing a WAN or Voice Card 17
- Connecting Cables 18
  - LAN and Power Cables 19
    - Connecting the Input Power 21
      - Cable 21
      - Procedure 21
      - Connecting Input Power on the Cisco IAD2435 IAD 21
  - Connecting the Console Port to a PC or an ASCII Terminal 22
    - Cable 22
    - Procedure 22
  - Connecting the Auxiliary Port to a Modem 23
    - Cable 23
    - Procedure 23
  - Connecting the Fast Ethernet Port to the Fast Ethernet Switch 23
    - Cable 23
    - Procedure 23
- WAN and Voice Cables 24
  - Connecting the RJ-21 Cable in the Velcro Harness 25
  - Connecting a Serial Interface Port to a CSU/DSU or a Synchronous Modem 27
    - Cable 28
    - Procedure 28
  - Connecting a T1/E1-WAN Port to the Network Demarcation Device 28
    - Cable 29
    - Procedure 29
  - Connecting the Analog Voice Interface to a Distribution Panel 29
    - Cable 29
    - Procedure 30
  - Connecting the Digital Voice Port to a T1/E1-PBX 30
    - Cable 30
    - Procedure 30
- Ports, Connectors, and Pinouts 31

- Remote Terminal Connections (If Applicable) 31
  - Connecting to a Modem 32
  - Connecting to a Remote PC 32
  - Connecting to a Remote ASCII Terminal 32
- Connecting Backup Power 33
  - Connecting a Backup Battery to a DC-Powered IAD 33
  - Connecting an Uninterruptible Power Supply UPS to an AC-Powered Cisco IAD2430 Series IAD 34

**CHAPTER 4**

**Powering On Cisco IAD2430 Series IADs 1**

- Checklist for Power-On 1
- Power-On Procedure 1
- Initial Configuration Procedures 2
  - Cisco IOS CLI 3
  - Setup Command Facility 4
  - Manual Configuration 6
  - Obtaining Your Network Information 6
  - Setting the Fast Ethernet Port IP Address 6
  - Configuring a T1/E1 Port for a WAN Connection 7
  - Configuring Digital Voice 8
  - Verifying and Saving Your Configuration 8
- Troubleshooting 9

**INDEX**



## Preface

---

This preface describes the audience, organization, and conventions of this publication, and describes how to obtain additional documentation.

## Audience

This publication is designed for people who have some experience installing networking equipment such as routers, servers, and switches. The person installing Cisco IAD2430 series integrated access devices (IADs) should be familiar with networks and telephony equipment as well as with electronic circuitry and wiring practices and have experience as an electronic or electromechanical technician.



**Warning**

---

**Only trained and qualified personnel should be allowed to install, replace, or service this equipment.**  
Statement 1030

---

## Organization

*Table 1 Major Sections of This Guide*

Chapter	Title	Description
Chapter 1	<a href="#">Overview of Cisco IAD2430 Series IADs</a>	Features and specifications of Cisco IAD2430 series integrated access devices.
Chapter 2	<a href="#">Planning Your Installation</a>	Environmental requirements and cable routing considerations.
Chapter 3	<a href="#">Installing Cisco IAD2430 Series IADs</a>	Instructions for installing Cisco IAD2430 series integrated access devices and connecting the cables.
Chapter 4	<a href="#">Powering On Cisco IAD2430 Series IADs</a>	Powering up Cisco IAD2430 series IADs and preparing for configuration.

# Conventions

**Table 2** *Installation Guide Conventions*

Convention	Description
<b>boldface font</b>	Commands and keywords.
<i>italic font</i>	Variables for which you supply values.
[ ]	Keywords or arguments that appear within square brackets are optional.
{x   y   z}	A choice of required keywords appears in braces separated by vertical bars. You must select one.
screen font	Examples of information displayed on the screen.
<b>boldface screen font</b>	Examples of information you must enter.
< >	Nonprinting characters, for example passwords, appear in angle brackets in contexts where italic font is not available.
[ ]	Default responses to system prompts appear in square brackets.



## Note

Means *reader take note*. Notes contain helpful suggestions or references to materials not contained in this publication.



## Timesaver

Means *the described action saves time*. You can save time by performing the action described in the paragraph.



## Caution

Means *reader be careful*. In this situation, you might do something that could result in equipment damage or loss of data.



## Tip

Means *the following information will help you solve a problem*. The tips information might not be troubleshooting or even an action, but could be useful information, similar to a Timesaver.

# Safety Warnings

Safety warnings appear throughout this publication in procedures that, if performed incorrectly, may harm you. A warning symbol precedes each warning statement. To see translations of the warnings that appear in this publication, see the *Cisco IAD2430 Series Regulatory Compliance and Safety Information* document that accompanied your router or go to the following URL:

[http://www.cisco.com/en/US/products/hw/gatecont/ps887/prod\\_installation\\_guides\\_list.html](http://www.cisco.com/en/US/products/hw/gatecont/ps887/prod_installation_guides_list.html)



## Warning Definition



Warning

### IMPORTANT SAFETY INSTRUCTIONS

This warning symbol means danger. You are in a situation that could cause bodily injury. Before you work on any equipment, be aware of the hazards involved with electrical circuitry and be familiar with standard practices for preventing accidents. To see translations of the warnings that appear in this publication, refer to the translated safety warnings that accompanied this device. Statement 1071

### SAVE THESE INSTRUCTIONS

Waarschuwing

### BELANGRIJKE VEILIGHEIDSINSTRUCTIES

Dit waarschuwingssymbool betekent gevaar. U verkeert in een situatie die lichamelijk letsel kan veroorzaken. Voordat u aan enige apparatuur gaat werken, dient u zich bewust te zijn van de bij elektrische schakelingen betrokken risico's en dient u op de hoogte te zijn van de standaard praktijken om ongelukken te voorkomen. Voor een vertaling van de waarschuwingen die in deze publicatie verschijnen, dient u de vertaalde veiligheidswaarschuwingen te raadplegen die bij dit apparaat worden geleverd.

Opmerking **BEWAAR DEZE INSTRUCTIES.**

Varoitus

### TÄRKEITÄ TURVALLISUUTEEN LIITTYVIÄ OHJEITA

Tämä varoitusmerkki merkitsee vaaraa. Olet tilanteessa, joka voi johtaa ruumiinvammaan. Ennen kuin työskentelet minkään laitteiston parissa, ota selvää sähkökytkentöihin liittyvistä vaaroista ja tavanomaisista onnettomuuksien ehkäisykeinoista. Tässä asiakirjassa esitettyjen varoitusten käännökset löydät laitteen mukana toimitetuista ohjeista.

Huomautus **SÄILYTÄ NÄMÄ OHJEET**

Attention

### IMPORTANTES INFORMATIONS DE SÉCURITÉ

Ce symbole d'avertissement indique un danger. Vous vous trouvez dans une situation pouvant causer des blessures ou des dommages corporels. Avant de travailler sur un équipement, soyez conscient des dangers posés par les circuits électriques et familiarisez-vous avec les procédures couramment utilisées pour éviter les accidents. Pour prendre connaissance des traductions d'avertissements figurant dans cette publication, consultez les consignes de sécurité traduites qui accompagnent cet appareil.

Remarque **CONSERVEZ CES INFORMATIONS**

Warnung

### WICHTIGE SICHERHEITSANWEISUNGEN

Dieses Warnsymbol bedeutet Gefahr. Sie befinden sich in einer Situation, die zu einer Körperverletzung führen könnte. Bevor Sie mit der Arbeit an irgendeinem Gerät beginnen, seien Sie sich der mit elektrischen Stromkreisen verbundenen Gefahren und der Standardpraktiken zur Vermeidung von Unfällen bewusst. Übersetzungen der in dieser Veröffentlichung enthaltenen Warnhinweise sind im Lieferumfang des Geräts enthalten.

Hinweis **BEWAHREN SIE DIESE SICHERHEITSANWEISUNGEN AUF**

**Avvertenza    IMPORTANTI ISTRUZIONI SULLA SICUREZZA**

Questo simbolo di avvertenza indica un pericolo. La situazione potrebbe causare infortuni alle persone. Prima di intervenire su qualsiasi apparecchiatura, occorre essere al corrente dei pericoli relativi ai circuiti elettrici e conoscere le procedure standard per la prevenzione di incidenti. Per le traduzioni delle avvertenze riportate in questo documento, vedere le avvertenze di sicurezza che accompagnano questo dispositivo.

**Nota    CONSERVARE QUESTE ISTRUZIONI**

**Advarsel    VIKTIGE SIKKERHETSINSTRUKSJONER**

Dette varselssymbolet betyr fare. Du befinner deg i en situasjon som kan forårsake personskade. Før du utfører arbeid med utstyret, bør du være oppmerksom på farene som er forbundet med elektriske kretssystemer, og du bør være kjent med vanlig praksis for å unngå ulykker. For å se oversettelser av advarslene i denne publikasjonen, se de oversatte sikkerhetsvarslene som følger med denne enheten.

**Merk    TA VARE PÅ DISSE INSTRUKSJONENE**

**Aviso    INSTRUÇÕES IMPORTANTES DE SEGURANÇA**

Este símbolo de aviso significa perigo. O utilizador encontra-se numa situação que poderá ser causadora de lesões corporais. Antes de iniciar a utilização de qualquer equipamento, tenha em atenção os perigos envolvidos no manuseamento de circuitos eléctricos e familiarize-se com as práticas habituais de prevenção de acidentes. Para ver traduções dos avisos incluídos nesta publicação, consulte os avisos de segurança traduzidos que acompanham este dispositivo.

**Nota    GUARDE ESTAS INSTRUÇÕES**

**¡Advertencia!    INSTRUCCIONES IMPORTANTES DE SEGURIDAD**

Este símbolo de aviso indica peligro. Existe riesgo para su integridad física. Antes de manipular cualquier equipo, considere los riesgos de la corriente eléctrica y familiarícese con los procedimientos estándar de prevención de accidentes. Vea las traducciones de las advertencias que acompañan a este dispositivo.

**Nota    GUARDE ESTAS INSTRUCCIONES**

**Varning!    VIKTIGA SÄKERHETSANVISNINGAR**

Denna varningssignal signalerar fara. Du befinner dig i en situation som kan leda till personskada. Innan du utför arbete på någon utrustning måste du vara medveten om farorna med elkretsar och känna till vanliga förfaranden för att förebygga olyckor. Se översättningarna av de varningsmeddelanden som finns i denna publikation, och se de översatta säkerhetsvarningarna som medföljer denna anordning.

**OBS!    SPARA DESSA ANVISNINGAR**

**Figyelem FONTOS BIZTONSÁGI ELOÍRÁSOK**

**Ez a figyelmeztető jel veszélyre utal. Sérülésveszélyt rejto helyzetben van. Mielott bármely berendezésen munkát végezte, legyen figyelemmel az elektromos áramkörök okozta kockázatokra, és ismerkedjen meg a szokásos balesetvédelmi eljárásokkal. A kiadványban szereplo figyelmeztetések fordítása a készülékhez mellékelt biztonsági figyelmeztetések között található; a fordítás az egyes figyelmeztetések végén látható szám alapján keresheto meg.**

**ORIZZE MEG EZEKET AZ UTASÍTÁSOKAT!**

**Предупреждение ВАЖНЫЕ ИНСТРУКЦИИ ПО СОБЛЮДЕНИЮ ТЕХНИКИ БЕЗОПАСНОСТИ**

**Этот символ предупреждения обозначает опасность. То есть имеет место ситуация, в которой следует опасаться телесных повреждений. Перед эксплуатацией оборудования выясните, каким опасностям может подвергаться пользователь при использовании электрических цепей, и ознакомьтесь с правилами техники безопасности для предотвращения возможных несчастных случаев. Воспользуйтесь номером заявления, приведенным в конце каждого предупреждения, чтобы найти его переведенный вариант в переводе предупреждений по безопасности, прилагаемом к данному устройству.**

**СОХРАНИТЕ ЭТИ ИНСТРУКЦИИ**

**警告 重要的安全性说明**

此警告符号代表危险。您正处于可能受到严重伤害的工作环境中。在您使用设备开始工作之前，必须充分意识到触电的危险，并熟练掌握防止事故发生的标准工作程序。请根据每项警告结尾提供的声明号码来找到此设备的安全性警告说明的翻译文本。

请保存这些安全性说明

**警告 安全上の重要な注意事項**

「危険」の意味です。人身事故を予防するための注意事項が記述されています。装置の取り扱い作業を行うときは、電気回路の危険性に注意し、一般的な事故防止策に留意してください。警告の各国語版は、各注意事項の番号を基に、装置に付属の「Translated Safety Warnings」を参照してください。

これらの注意事項を保管しておいてください。

**주의 중요 안전 지침**

이 경고 기호는 위험을 나타냅니다. 작업자가 신체 부상을 일으킬 수 있는 위험한 환경에 있습니다. 장비에 작업을 수행하기 전에 전기 회로와 관련된 위험을 숙지하고 표준 작업 관례를 숙지하여 사고를 방지하십시오. 각 경고의 마지막 부분에 있는 경고문 번호를 참조하여 이 장치와 함께 제공되는 번역된 안전 경고문에서 해당 번역문을 찾으십시오.

이 지시 사항을 보관하십시오.

**Aviso INSTRUÇÕES IMPORTANTES DE SEGURANÇA**

Este símbolo de aviso significa perigo. Você se encontra em uma situação em que há risco de lesões corporais. Antes de trabalhar com qualquer equipamento, esteja ciente dos riscos que envolvem os circuitos elétricos e familiarize-se com as práticas padrão de prevenção de acidentes. Use o número da declaração fornecido ao final de cada aviso para localizar sua tradução nos avisos de segurança traduzidos que acompanham o dispositivo.

**GUARDE ESTAS INSTRUÇÕES****Advarsel VIGTIGE SIKKERHEDSANVISNINGER**

Dette advarselssymbol betyder fare. Du befinder dig i en situation med risiko for legemeskade. Før du begynder arbejde på udstyr, skal du være opmærksom på de involverede risici, der er ved elektriske kredsløb, og du skal sætte dig ind i standardprocedurer til undgåelse af ulykker. Brug erklæringsnummeret efter hver advarsel for at finde oversættelsen i de oversatte advarsler, der fulgte med denne enhed.

**GEM DISSE ANVISNINGER**

تحذير

إرشادات الأمان الهامة

يوضح رمز التحذير هذا وجود خطر. وهذا يعني أنك متواجد في مكان قد ينتج عنه التعرض لإصابات. قبل بدء العمل، احذر مخاطر التعرض للصدمات الكهربائية وكن على علم بالإجراءات القياسية للحيلولة دون وقوع أي حوادث. استخدم رقم البيان الموجود في آخر كل تحذير لتحديد مكان ترجمته داخل تحذيرات الأمان المترجمة التي تأتي مع الجهاز. قم بحفظ هذه الإرشادات

**Upozorenje VAŽNE SIGURNOSNE NAPOMENE**

Ovaj simbol upozorenja predstavlja opasnost. Nalazite se u situaciji koja može prouzročiti tjelesne ozljede. Prije rada s bilo kojim uređajem, morate razumjeti opasnosti vezane uz električne sklopove, te biti upoznati sa standardnim načinima izbjegavanja nesreća. U prevedenim sigurnosnim upozorenjima, priloženima uz uređaj, možete prema broju koji se nalazi uz pojedino upozorenje pronaći i njegov prijevod.

**SAČUVAJTE OVE UPUTE****Upozornění DŮLEŽITÉ BEZPEČNOSTNÍ POKYNY**

Tento upozorňující symbol označuje nebezpečí. Jste v situaci, která by mohla způsobit nebezpečí úrazu. Před prací na jakémkoliv vybavení si uvědomte nebezpečí související s elektrickými obvody a seznamte se se standardními opatřeními pro předcházení úrazům. Podle čísla na konci každého upozornění vyhledejte jeho překlad v přeložených bezpečnostních upozorněních, která jsou přiložena k zařízení.

**USCHOVEJTE TYTO POKYNY**

Προειδοποίηση	<p><b>ΣΗΜΑΝΤΙΚΕΣ ΟΔΗΓΙΕΣ ΑΣΦΑΛΕΙΑΣ</b></p> <p>Αυτό το προειδοποιητικό σύμβολο σημαίνει κίνδυνο. Βρίσκεστε σε κατάσταση που μπορεί να προκαλέσει τραυματισμό. Πριν εργαστείτε σε οποιοδήποτε εξοπλισμό, να έχετε υπόψη σας τους κινδύνους που σχετίζονται με τα ηλεκτρικά κυκλώματα και να έχετε εξοικειωθεί με τις συνήθειες πρακτικές για την αποφυγή ατυχημάτων. Χρησιμοποιήστε τον αριθμό δήλωσης που παρέχεται στο τέλος κάθε προειδοποίησης, για να εντοπίσετε τη μετάφρασή της στις μεταφρασμένες προειδοποιήσεις ασφαλείας που συνοδεύουν τη συσκευή.</p> <p><b>ΦΥΛΑΞΤΕ ΑΥΤΕΣ ΤΙΣ ΟΔΗΓΙΕΣ</b></p>
אזהרה	<p><b>הוראות בטיחות חשובות</b></p> <p>סימן אזהרה זה מסמל סכנה. אתה נמצא במצב העלול לגרום לפציעה. לפני שתעבוד עם ציוד כלשהו, עליך להיות מודע לסכנות הכרוכות במגעלים חשמליים ולהכיר את הנהלים המקובלים למניעת תאונות. השתמש במספר ההוראה המסופק בסופה של כל אזהרה כדי לאתר את התרגום באזהרות הבטיחות המתורגמות שמצורפות להתקן.</p> <p><b>שמור הוראות אלה</b></p>
Opomena	<p><b>ВАЖНИ БЕЗБЕДНОСНИ НАПАТСТВИЈА</b></p> <p>Симболот за предупредување значи опасност. Се наоѓате во ситуација што може да предизвика телесни повреди. Пред да работите со опремата, бидете свесни за ризикот што постои кај електричните кола и треба да ги познавате стандардните постапки за спречување на несреќни случаи. Искористете го бројот на изјавата што се наоѓа на крајот на секое предупредување за да го најдете неговиот период во преведените безбедносни предупредувања што се испорачани со уредот.</p> <p><b>ЧУВАЈТЕ ГИ ОБИЕ НАПАТСТВИЈА</b></p>
Ostrzeżenie	<p><b>WAŻNE INSTRUKCJE DOTYCZĄCE BEZPIECZEŃSTWA</b></p> <p>Ten symbol ostrzeżenia oznacza niebezpieczeństwo. Zachodzi sytuacja, która może powodować obrażenia ciała. Przed przystąpieniem do prac przy urządzeniach należy zapoznać się z zagrożeniami związanymi z układami elektrycznymi oraz ze standardowymi środkami zapobiegania wypadkom. Na końcu każdego ostrzeżenia podano numer, na podstawie którego można odszukać tłumaczenie tego ostrzeżenia w dołączonym do urządzenia dokumencie z tłumaczeniami ostrzeżeń.</p> <p><b>NINIEJSZE INSTRUKCJE NALEŻY ZACHOWAĆ</b></p>
Upozornenie	<p><b>DÔLEŽITÉ BEZPEČNOSTNÉ POKYNY</b></p> <p>Tento varovný symbol označuje nebezpečenstvo. Nachádzate sa v situácii s nebezpečenstvom úrazu. Pred prácou na akomkoľvek vybavení si uvedomte nebezpečenstvo súvisiace s elektrickými obvodmi a oboznámte sa so štandardnými opatreniami na predchádzanie úrazom. Podľa čísla na konci každého upozornenia vyhľadajte jeho preklad v preložených bezpečnostných upozorneniach, ktoré sú priložené k zariadeniu.</p> <p><b>USCHOVAJTE SI TENTO NÁVOD</b></p>



Warning

**Only trained and qualified personnel should be allowed to install, replace, or service this equipment.**

Statement 1030



Warning

**Do not use this product near water; for example, near a bath tub, wash bowl, kitchen sink or laundry tub, in a wet basement, or near a swimming pool.** Statement 1035



Warning

**Never install telephone jacks in wet locations unless the jack is specifically designed for wet locations.** Statement 1036



Warning

**Never touch uninsulated telephone wires or terminals unless the telephone line has been disconnected at the network interface.** Statement 1037



Warning

**Avoid using a telephone (other than a cordless type) during an electrical storm. There may be a remote risk of electric shock from lightning.** Statement 1038



Warning

**To report a gas leak, do not use a telephone in the vicinity of the leak.** Statement 1039



Warning

**Do not work on the system or connect or disconnect cables during periods of lightning activity.**

Statement 1001



Warning

**Ultimate disposal of this product should be handled according to all national laws and regulations.**

Statement 1040



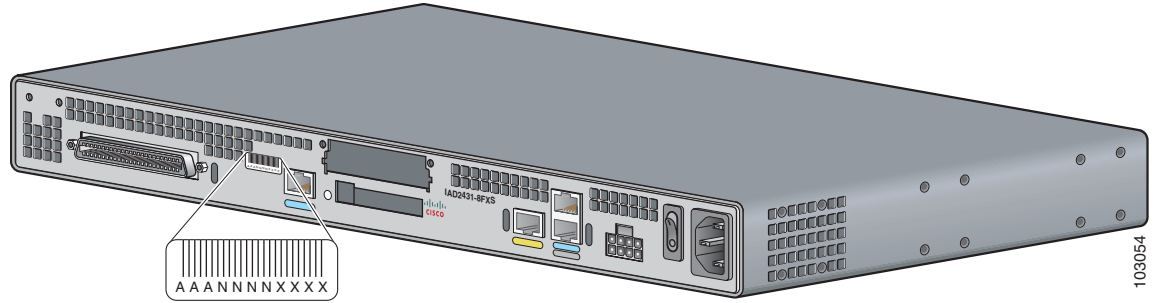
Warning

**This equipment must be installed and maintained by service personnel as defined by AS/NZS 3260. Incorrectly connecting this equipment to a general-purpose outlet could be hazardous. The telecommunications lines must be disconnected 1) before unplugging the main power connector or 2) while the housing is open, or both.** Statement 1043

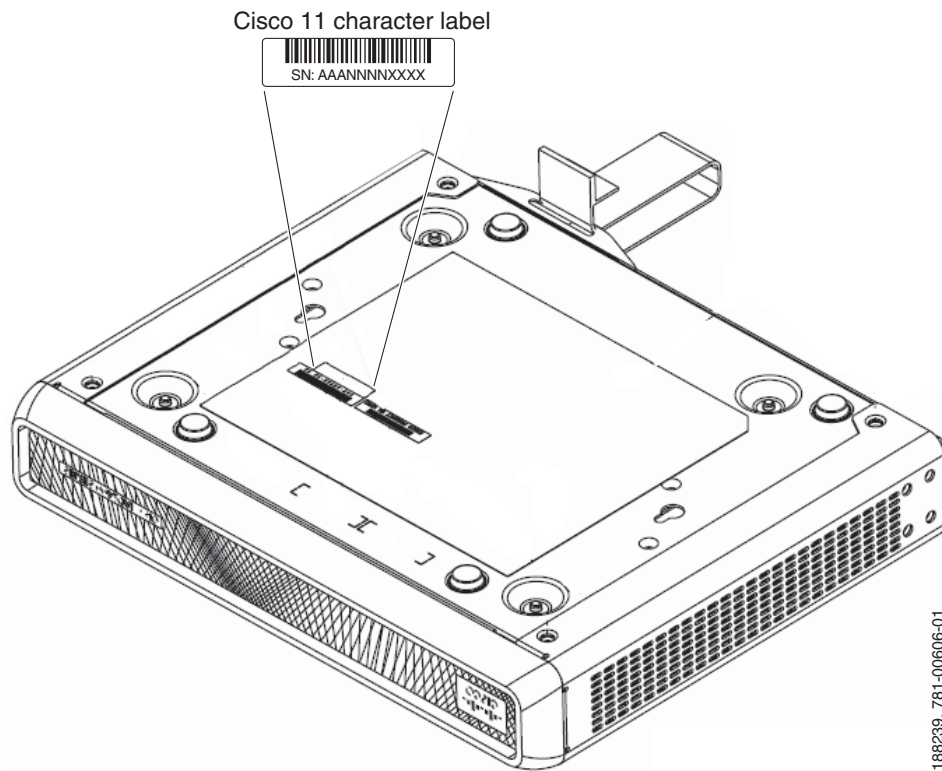
## Product Serial Number Location

The serial number label for the Cisco IAD2430 series routers (Cisco IAD2430 through Cisco IAD2432) is located on the back of the chassis, near the compliance label. The size of the serial number label is 0.25 x 1 inch (0.635 x 2.54 centimeters). It has the letters “SN:” followed by eleven characters. (See [Figure 0-1](#).) The serial number label for the Cisco IAD2435 series IAD is located on the bottom of the chassis, near the compliance label. (See [Figure 0-2](#).)

**Figure 0-1 Serial Number Location on Cisco IAD2430 Series Routers**



**Figure 0-2 Serial Number Location on Cisco IAD2435-8FXS Routers**



## Accessibility

These integrated access devices can be configured using the Cisco command-line interface (CLI). The CLI conforms to code 508 because it is text based and it relies on a keyboard for navigation. All functions of the router can be configured and monitored through the CLI.

For a complete list of guidelines and Cisco products' adherence to accessibility, see Cisco Accessibility Products at the following URL:

<http://www.cisco.com/web/about/responsibility/accessibility/products>

## Related Documentation

The Cisco IOS software running your Cisco integrated access device includes extensive features and functionality. For information that is beyond the scope of this document, or for additional information, use the resources listed in [Table 3 on page xvi](#).



**Timesaver**

Make sure that you have access to the documents listed in [Table 3](#). See the “[Obtaining Documentation and Submitting a Service Request](#)” section on [page xvi](#) for information about obtaining these documents.

**Table 3**      *Related and Referenced Documents*

Cisco Product	Document Title and URL
Cisco IAD2430 series	<ul style="list-style-type: none"> <li>• <a href="#">Cisco IAD2430 Series Integrated Access Devices Hardware Installation Guide</a> (this book)</li> <li>• <a href="#">Cisco IAD2430 Series Quick Start Guide</a></li> <li>• <a href="#">Cisco IAD2430 Series Integrated Access Devices Software Configuration Guide</a></li> <li>• <a href="#">Cisco IAD2430 Series Regulatory Compliance and Safety Information</a></li> </ul>
Cisco IOS software <sup>1</sup>	<ul style="list-style-type: none"> <li>• <a href="#">Cisco IAD2430 Series Integrated Access Device—Release Notes</a></li> </ul>

1. See the modular reference publications that correspond to the Cisco IOS software release installed on your Cisco IAD2430 series integrated access device.

## Obtaining Documentation and Submitting a Service Request

For information on obtaining documentation, submitting a service request, and gathering additional information, see the monthly *What's New in Cisco Product Documentation*, which also lists all new and revised Cisco technical documentation, at:

<http://www.cisco.com/en/US/docs/general/whatsnew/whatsnew.html>

Subscribe to the *What's New in Cisco Product Documentation* as a Really Simple Syndication (RSS) feed and set content to be delivered directly to your desktop using a reader application. The RSS feeds are a free service and Cisco currently supports RSS version 2.0.





# CHAPTER 1

## Overview of Cisco IAD2430 Series IADs

---

This chapter provides a brief description of Cisco IAD2430 series integrated access devices (IADs) and contains the following sections:

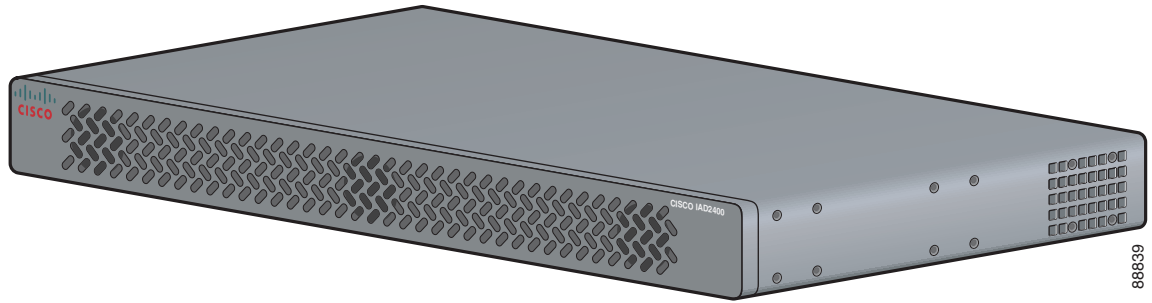
- [Overview, page 1-1](#)
- [Physical Description, page 1-6](#)
- [LEDs, page 1-7](#)
- [Chassis Grounding, page 1-9](#)
- [Memory, page 1-9](#)
- [Port Numbering Conventions, page 1-9](#)
- [Specifications, page 1-10](#)
- [Software Elements, page 1-10](#)
- [Interfaces and Service Capabilities, page 1-11](#)
- [Deployment Options, page 1-13](#)

### Overview

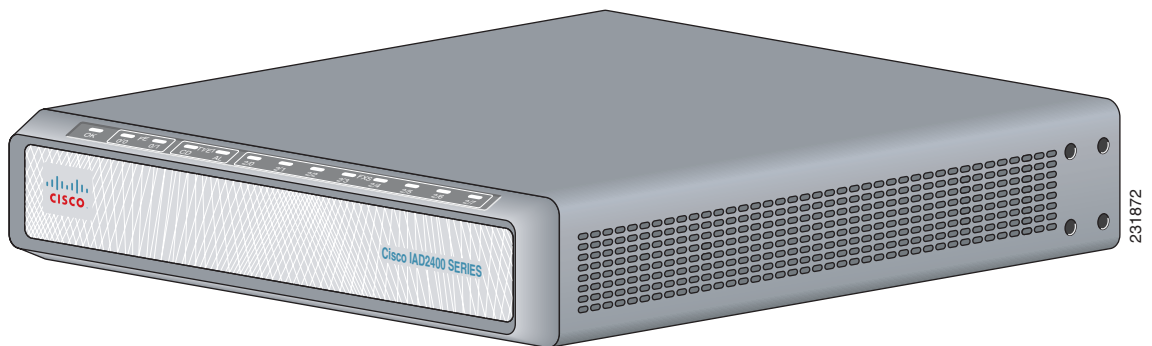
The Cisco IAD2430 series IADs aggregate multiple channels of data and voice or fax user-side traffic for transport over single or multiple WAN uplinks. Voice or fax traffic is transported by VoIP or by Voice over Asynchronous Transfer Mode (VoATM). All platforms support Media Gateway Control Protocol (MGCP), the signaling protocol H.323, and Session Initiation Protocol (SIP).

The Cisco IAD2430, Cisco IAD2431, and Cisco IAD2432 series routers consist of five models with a common front panel (Figure 1). The Cisco IAD2435 series router consists of one model (Cisco IAD2435-8FXS) with a different front panel (Figure 2). The Cisco IAD2430, Cisco IAD2431, and Cisco IAD2432 series routers include a slot for the external flash memory card, as well as console, auxiliary, and flash (CF) memory ports. The front panel, labeled “Cisco IAD2400 Series,” is identical for all models. However, the back panels, labeled by specific model number, vary considerably, depending on interfaces, ports, and options. Analog voice ports use an RJ-21 interface.

**Figure 1-1 Cisco IAD2430 Series IADs Front Panel**



**Figure 1-2 Cisco IAD2435 Series IADs Front Panel**



The Cisco IAD2430 series IADs support the following interfaces:

- 10/100BASE-T LAN connection
- T1/E1 port connections
- RJ-21 analog voice interface
- WAN interface card/voice interface card (WIC/VIC) options
- External/internal flash memory

The Cisco IAD2430 series IADs can be mounted in a rack, on a wall, or a desktop.



**Warning**

**There is the danger of explosion if the battery is replaced incorrectly. Replace the battery only with the same or equivalent type recommended by the manufacturer. Dispose of used batteries according to the manufacturer's instructions.** Statement 1015



**Warning**

**This unit is intended for installation in restricted access areas. A restricted access area can be accessed only through the use of a special tool, lock and key, or other means by security.** Statement 1017



**Warning**

**No user-serviceable parts inside. Do not open.** Statement 1073

**Warning**

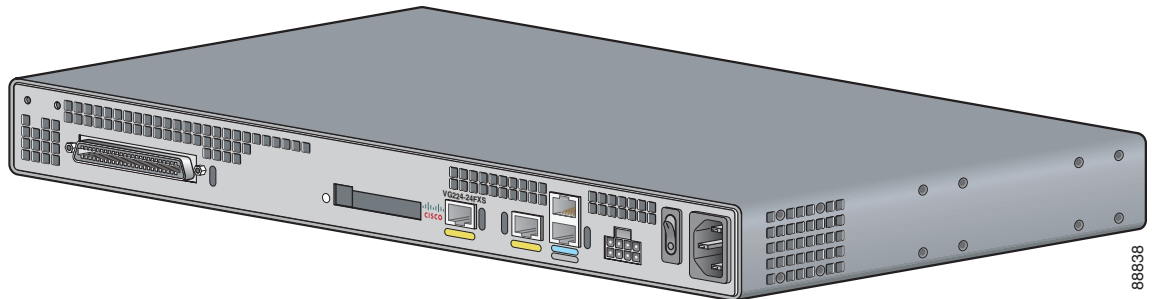
**Ultimate disposal of this product should be handled according to all national laws and regulations.**  
Statement 1040

## Cisco IAD2430-24FXS IAD

The Cisco IAD2430-24FXS IAD provides 24 analog foreign exchange station (FXS) ports with two 10/100BASE-T ports. The chassis (Figure 1-3) has the following interfaces:

- RJ-21 analog voice interface
- Two 10/100BASE-T ports
- External flash memory slot
- AC and DC power inputs

**Figure 1-3** Cisco IAD2430-24FXS Chassis

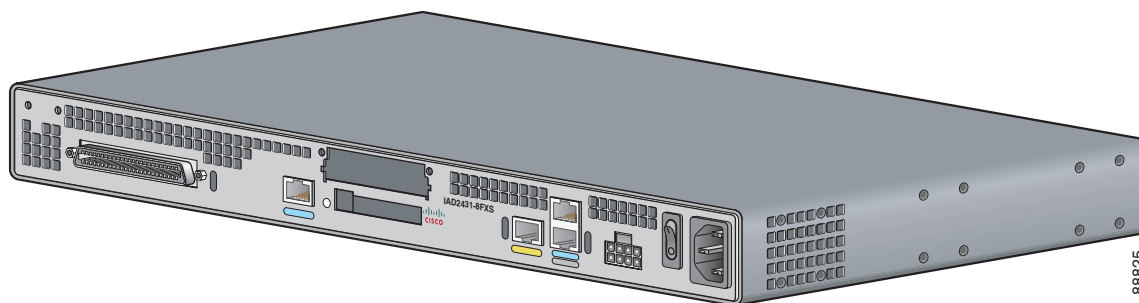


## Cisco IAD2431-8FXS IAD

The Cisco IAD2431-8FXS IAD (Figure 1-4) provides eight analog FXS ports, two 10/100BASE-T ports, and one T1/E1 WAN port. The chassis has the following interfaces:

- RJ-21 analog voice interface
- One T1/E1 port
- One 10/100BASE-T port
- One WIC/VIC slot
- External flash memory
- AC and DC power inputs

**Figure 1-4** Cisco IAD2431-8FXS Chassis

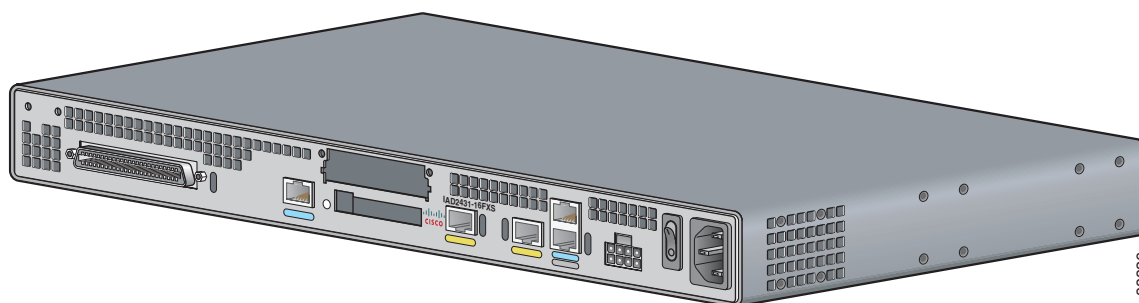


## Cisco IAD2431-16FXS

The Cisco IAD2431-16FXS IAD (Figure 1-5) provides sixteen analog FXS ports with two 10/100BASE-T ports and two T1/E1 WAN ports. The chassis has the following interfaces:

- RJ-21 analog voice interface
- One T1/E1 port
- Two 10/100BASE-T ports
- One WIC/VIC slot
- External flash memory
- AC and DC power inputs

**Figure 1-5** Cisco IAD2431-16FXS Chassis

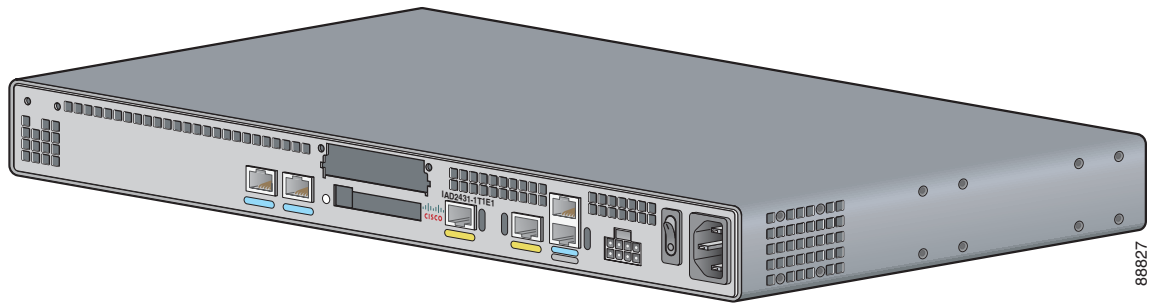


## Cisco IAD2431-1T1E1 IAD

The Cisco IAD2431-1T1E1 IAD (Figure 1-6) provides one T1/E1 connection to a PBX, one T1/E1 WAN port, and two 10/100BASE-T ports. The chassis has the following interfaces:

- Two T1/E1 ports
- Two 10/100BASE-T ports
- One WIC/VIC slot
- External flash memory
- AC and DC power inputs

**Figure 1-6** Cisco IAD2431-1T1E1 Chassis

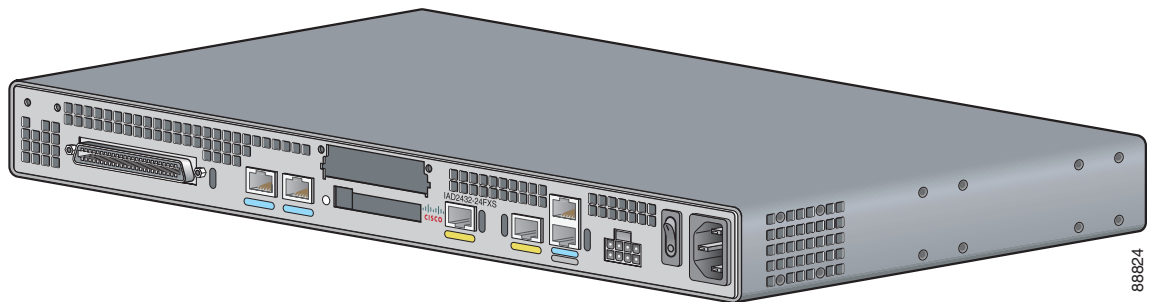


## Cisco IAD2432-24FXS IAD

The Cisco IAD2432-24FXS IAD (Figure 1-7) provides 24 analog FXS ports, two 10/100BASE-T ports, and two T1/E1 WAN ports. The chassis has the following interfaces:

- RJ-21 analog voice interface
- Two T1/E1 ports
- Two 10/100BASE-T ports
- One WIC/VIC slot
- External flash memory
- AC and DC power inputs

**Figure 1-7** Cisco IAD2432-24FXS Chassis

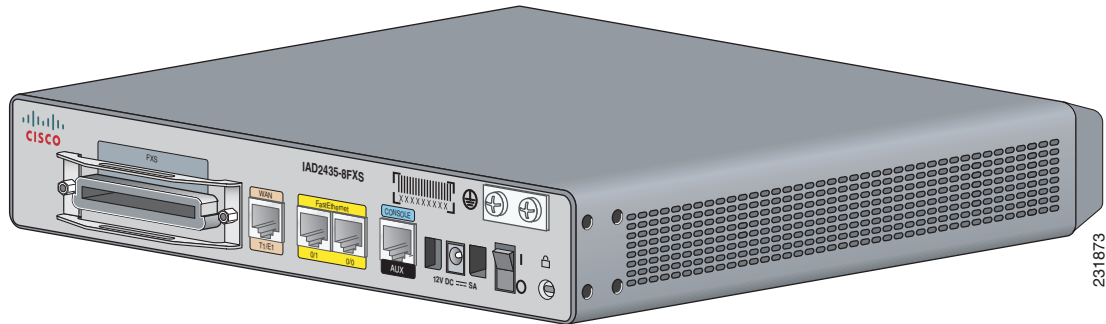


## Cisco IAD2435-8FXS IAD

The Cisco IAD2435-8FXS IAD (Figure 1-8) provides eight analog FXS ports, two Fast Ethernet ports, and one T1/E1 WAN port. The chassis has the following interfaces:

- RJ-21 analog voice interface
- One T1/E1 port
- Two Fast Ethernet ports
- AC and DC power inputs

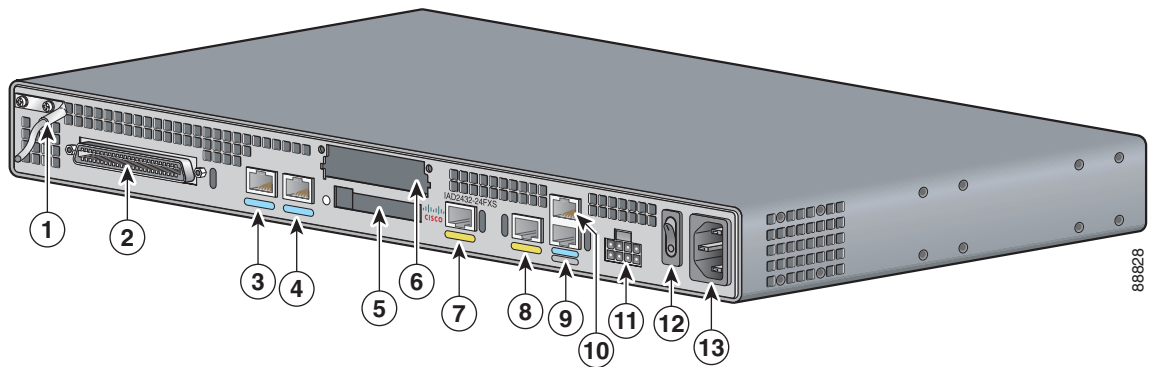
Figure 1-8 Cisco IAD2435-8FXS Chassis



## Physical Description

Figure 1-9 and Figure 1-10 show the function options of the two IAD243x chassis. All interface slots are on the back of the chassis.

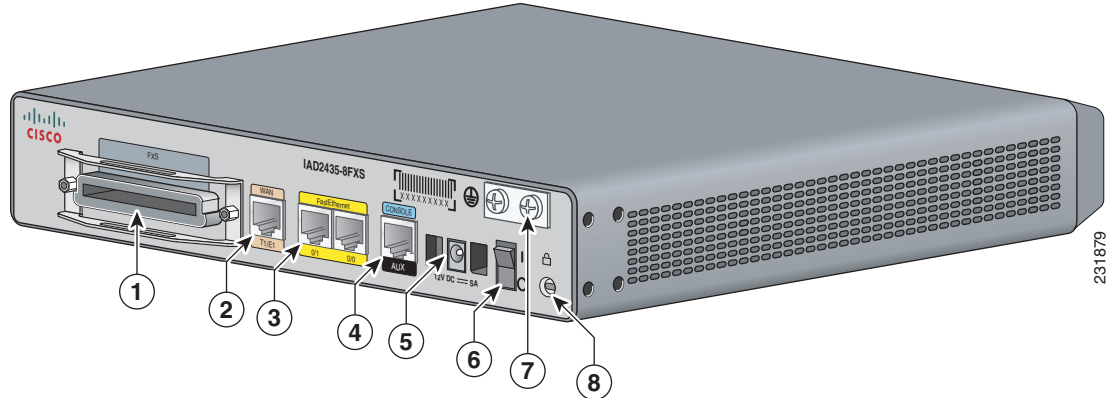
Figure 1-9 Cisco IAD2430 Series IAD Back Panel Function Options



1	Chassis ground connection	2	RJ-21 connector	3	T1/E1 port 1
4	T1/E1 port 0	5	Flash memory slot	6	WIC/VIC slot
7	10/100BASE-T port 1	8	10/100BASE-T port 0	9	AUX port
10	Console port	11	DC power input <sup>1</sup>	12	On/off switch
13	AC power input				

1. This is not a redundant failover power supply connection. You must use either DC or AC.

**Figure 1-10 Cisco IAD2435 Series IAD Back Panel Function Options**



<b>1</b>	RJ-21 connector	<b>2</b>	T1/E1 WAN uplink	<b>3</b>	Fast Ethernet port 1 Fast Ethernet port 0
<b>4</b>	Serial port—console or auxiliary	<b>5</b>	Power connector	<b>6</b>	On/off switch
<b>7</b>	Chassis ground connection	<b>8</b>	Kensington security slot		



**Note**

A Kensington security slot is located on the router back panel. To secure the router to a desktop or other surface, use the Kensington lockdown equipment.



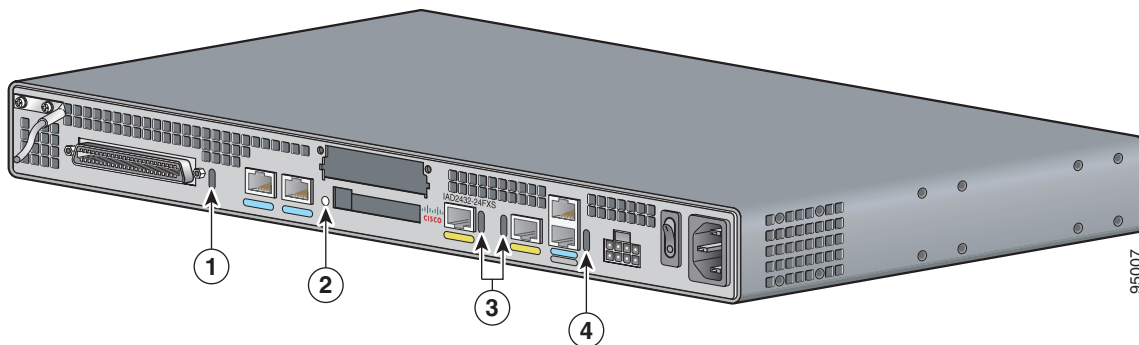
**Note**

The FE built-in switch ports provide connections to 10/100BASE-T (10/100-Mbps) Fast Ethernet networks.

## LEDs

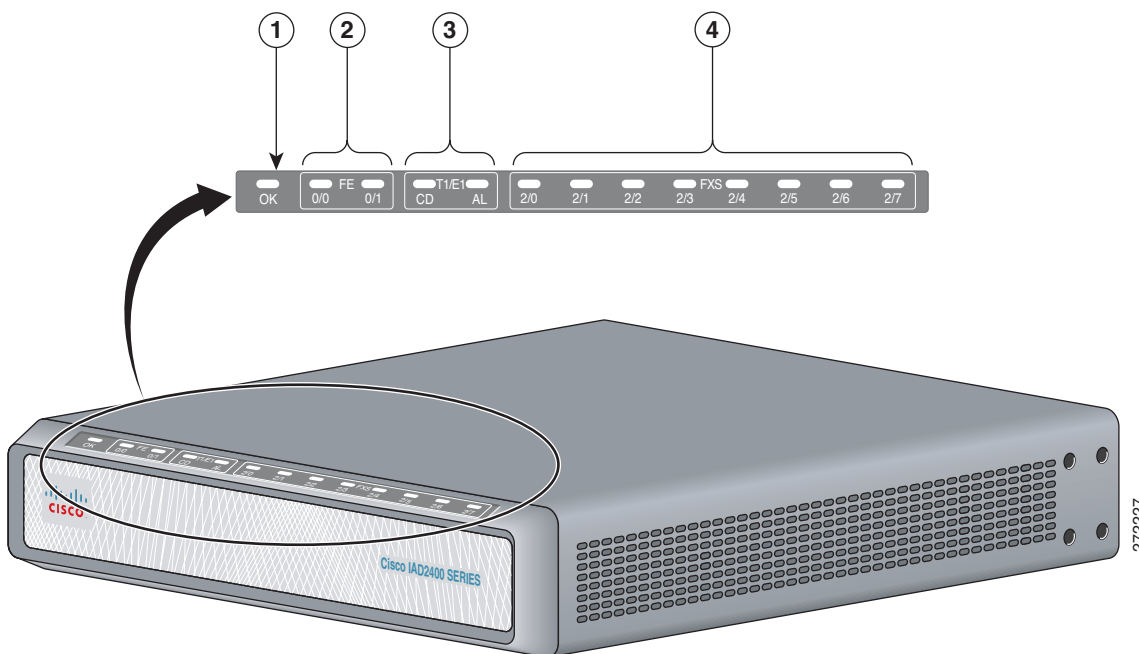
The LEDs are located on the back panel of the Cisco IAD2430 series IADs. [Figure 1-11](#) shows LEDs for the Cisco IAD2430 series IADs. The LEDs for the Cisco IAD2435 series IADs are located on the front of the chassis. [Figure 1-12](#) shows LEDs for the Cisco IAD2435 series IADs.

Figure 1-11 Cisco IAD2400 Series LEDs (Cisco 2432-24FXS shown)



No	LED/Color	Description
1	ACT—green	Green indicates activity—when any of the 24 voice ports is active in a call (off hook) or when one of the analog ports is in use
	Status—green	Green when accessing IAD
2	CF (Slot 0)—green	Green when accessing read or write function
3	Link—green	Indicates link activity
	100—green	100BASE-T is active
	FDX—green	Green when full duplex is active, off when in half-duplex mode
4	ACT—green	Blinking green during packet transfer and interrupts
	SYS—green	Blinking green for power-on and self-test, then solid green
	PWR—green	Solid green when system has power

Figure 1-12 Cisco IAD2435 Series LEDs





No	LED/Color	LED Color and Description
1	PWR OK—green	Off—no power Steady on—normal operation Slow blink—boot up phase or in ROMMON monitor mode
2	FE ports 0/1—green	Off—No link Steady on—link Blinking—TXD/RXD data
3	T1/E1 (carrier detect)—green T1/E1 AL—Amber	Off—no Carrier Detect Steady on—Carrier Detect Off—no Alarm condition Steady on—Alarm condition
4	FXS ports 0 through 7—green	Off—On hook Steady On—Off hook

## Chassis Grounding

Chassis grounding is provided through the power cable, which uses a standard grounding plug. The chassis is also equipped with two 4 x 0.7 screw terminals for chassis grounding. The accessory kit contains a crimp-type ground lug that attaches to the two screw terminals. For more information, see the [“Installing the Ground Connection”](#) section on page 3-14.

## Memory

The Cisco IAD2430 series routers contain flash memory and main memory.

Onboard flash memory contains the Cisco IOS software image, boot flash contains the ROMMON boot code, and counterfeit prevention contains the cookie configuration.

The default flash memory for the Cisco IAD2430 series IADs is 128 MB. Onboard CPU memory is 256 MB.

## Port Numbering Conventions

Port numbering conventions for Cisco IAD2430, IAD2431, and IAD2432 series IADs are as follows:

- An external flash memory card is numbered CF 0.
- The 10/100BASE-T ports are numbered 10/100BASE-T 0/0 and 10/100BASE-T 0/1, from right to left.
- The T1/E1 ports are numbered T1 1/0 or E1 1/0 and T1 1/1 or E1 1/1, from right to left.
- The slot for WICs and VICs is numbered slot 0. WIC and VIC interfaces are numbered by interface with this slot number and an interface number, beginning with 0 and numbered from right to left.
- FXS voice port numbering begins at 2/0 and extends to 2/7, 2/15, or 2/23, depending on the number of voice ports.

Port numbering conventions for the Cisco IAD2435 series IAD are as follows:

- Fast Ethernet ports are numbered 0 and 1, from left to right.
- The controller T1/E1 port is numbered T1 0 or E1 0, from left to right.
- FXS voice port numbering begins at 0 and reaches a maximum of 7, depending on the number of voice ports, from left to right.

## Specifications

For the Cisco IAD2430 series hardware and electrical specifications, see the Cisco IAD2430 series data sheets at the following URL:

[http://www.cisco.com/en/US/prod/collateral/voicesw/ps6790/gatecont/ps887/ps5321/product\\_data\\_sheet09186a008019aded.html](http://www.cisco.com/en/US/prod/collateral/voicesw/ps6790/gatecont/ps887/ps5321/product_data_sheet09186a008019aded.html)

## Software Elements

The operating system for the Cisco IAD2430 series IADs is the Cisco IOS software that resides in flash memory.

## Configuration Connections

You can use an ASCII terminal or a PC to configure a Cisco IAD2430 series IAD. The configuration can be performed in several ways:

- Locally, with a direct connection through the serial port
- Remotely, with a connection through the serial port and a modem
- Through Telnet and TFTP

## Configuration Methods

You can configure a Cisco IAD2430 series IAD automatically using the Simple Network-Enabled Auto-Provision (SNAP) option, or you can configure the Cisco IAD2430 series IAD manually using several methods listed in “Manual Configuration” section on page 1-11.

## Automated Configuration

If your Cisco IAD2430 series IAD was ordered with the SNAP option, no on-site configuration is required. When the Cisco IAD is powered on and connected to the WAN, the SNAP application downloads the applicable configuration files automatically. For additional information about SNAP, see the following URL:

<http://www.cisco.com/univercd/cc/td/doc/product/software/ios122/122newft/122t/122t8/ftapiad8.htm>

**Note**

---

The SNAP option is not available on the Cisco IAD2435 IAD.

---

## Manual Configuration

When you install a Cisco IAD2430 series IAD, see the “[Power-On Procedure](#)” section on page 4-1 for the initial configuration. This configuration sets the basic communication parameters. After the Cisco IAD is operating and able to communicate, use the procedures in the [Cisco IAD2430 Series Software Configuration Guide](#) to configure the specific services and functions, or to make changes to the existing configuration.

You can use any of several manual methods for configuring a Cisco IAD2430 series IAD:

- System configuration dialog
- Configuration mode—Cisco IOS software command-line interface (CLI)
- **setup** command facility—Remote configuration through a LAN or WAN
- SNMP-based application—CiscoView or HP OpenView
- HTTP-based configuration server—Provides access to the CLI from a web browser

## Interfaces and Service Capabilities

[Table 1-1](#) describes the various physical ports and the services that each port type supports, including the following.

- Two administrative ports—One console and one auxiliary.




---

**Note**

The Cisco IAD2435 IAD provides a connection to the terminal or PC for software configuration or troubleshooting. The console port may be configured as a virtual auxiliary port for dial backup and remote management.

---

- One or two 10/100BASE-T LAN ports.
- One or two Fast Ethernet ports.
- The Cisco IAD2431 and Cisco IAD2432 IADs for a T1/E1 WAN interface are equipped with one or two T1/E1 WAN ports.
- Cisco IAD2430 series IADs for an analog voice user interface are equipped with an RJ-21 port for connection to a distribution panel.
- Cisco IAD2432 IADs for a digital voice user interface are equipped with a T1/E1 port for connection to a PBX.




---

**Caution**

All Cisco IAD2430 series IADs are customer premises equipment (CPE) only.

---

**Table 1-1 Cisco IAD2430 Series Interfaces and Service Capabilities**

Port	Interface Configurations	Interface To	Services Supported	Details
Console port 0/0	EIA/TIA-232 asynchronous serial (DCE)	ASCII terminal Personal computer	Local administrative access	RJ-45 physical interface <b>Note</b> The serial port on the Cisco IAD2435 acts as either console or auxiliary.
Auxiliary port 0/1	EIA/TIA-232 asynchronous serial (DTE)	Modem	Remote administrative access Data backup	RJ-45 physical interface <b>Note</b> The serial port on the Cisco IAD2435 acts as either console or auxiliary.
Fast Ethernet ports 0/0, 0/1	10/100BASE-T (802.3)	LAN	Data	RJ-45 physical interface
RJ-21—8, 16, or 24 analog FXS voice ports Ports 2/0 to 2/23 Ports 0 to 7 (IAD2435 only)	FXS (loop-start or ground-start)	Analog phone, fax, or modem Network side of key system Network side of analog PBX	Analog voice/fax or modem	Provides battery RJ-21 physical interface 8-port FXS, on premise only 16-port FXS, on premise only 24-port FXS, on premise only
T1/E1 trunk ports 0,1	Channelized T1/E1	WAN Carrier network	Service types: <ul style="list-style-type: none"> <li>ATM</li> <li>Cisco HDLC<sup>1</sup></li> <li>PPP</li> </ul> Transport types: <ul style="list-style-type: none"> <li>TDM<sup>2</sup> trunk</li> <li>Leased lines</li> </ul>	Built-in CSU/DSU <sup>3</sup> T1.403-compliant RJ-48C/CA81A physical interface Supports as many as 24 DS0s
WIC/VIC slot S0 (serial)	HDLC-based data	WAN Carrier network User equipment	Cisco HDLC PPP VoIP over PPP	Physical interfaces: <ul style="list-style-type: none"> <li>EIA/TIA-232</li> <li>EIA/TIA-530/530A</li> <li>EIA/TIA-449</li> <li>V.35</li> <li>X.21</li> </ul>
CF <sup>4</sup> Slot 0			Flash memory	Flash memory card

1. HDLC = High-Level Data Link Control
2. TDM = time-division multiplexing
3. CSU/DSU = channel service unit/data service unit
4. CF = Flash memory

## Configuration Options

The following interface options are available in Cisco IAD2430 series IADs:

**Table 1-2 Configuration Options**

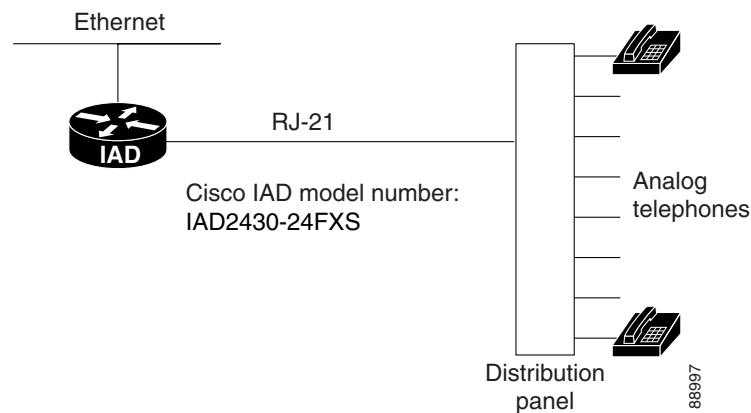
Cisco IAD2430 Series	RJ-21 <sup>1</sup>	T1/E1 <sup>2</sup>	FE <sup>3</sup>	WIC/VIC <sup>4</sup>	CF <sup>5</sup>
IAD2430-24FXS	Yes	None	2	N/A	External
IAD2431-8FXS	Yes	1	1	Yes	External
IAD2431-16FXS	Yes	1	2	Yes	External
IAD2431-1T1E1	No	2	2	Yes	External
IAD2432-24FXS	Yes	2	2	Yes	External
IAD2435-8FXS	Yes	1	2	N/A	N/A

1. Analog voice interface.
2. T1/E1 ports.
3. 10/100BASE-T ports.
4. WAN interface card (data); voice interface card (voice).
5. Flash (CF) memory.

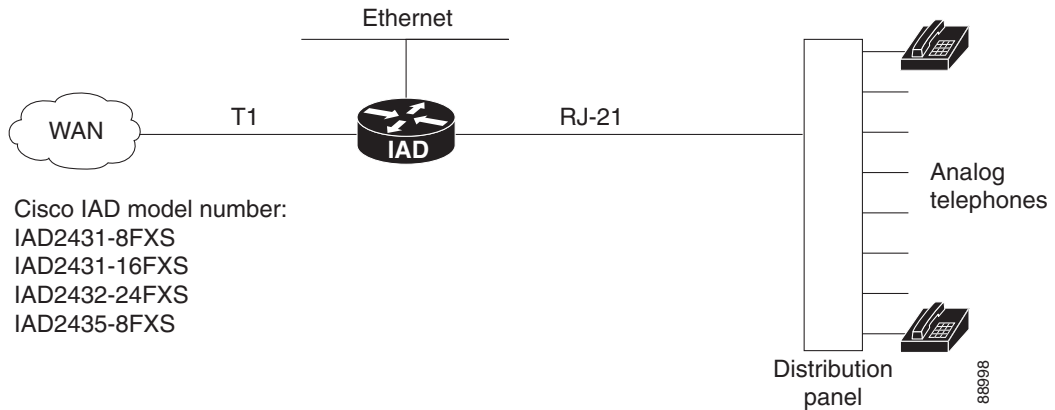
## Deployment Options

Figure 1-13 through Figure 1-16 show some typical deployment scenarios for the Cisco IAD2430 series integrated access devices (IADs).

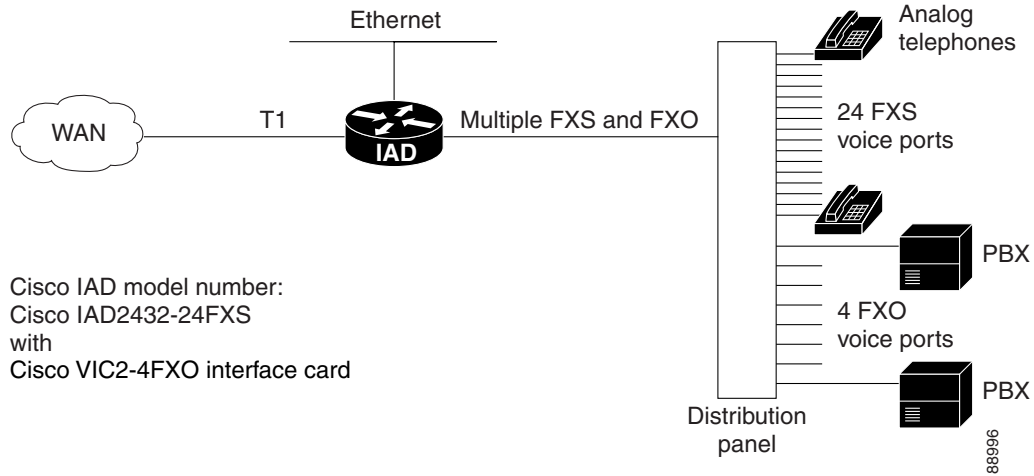
**Figure 1-13 Analog FXS User Interfaces with Metro Ethernet WAN Interface**



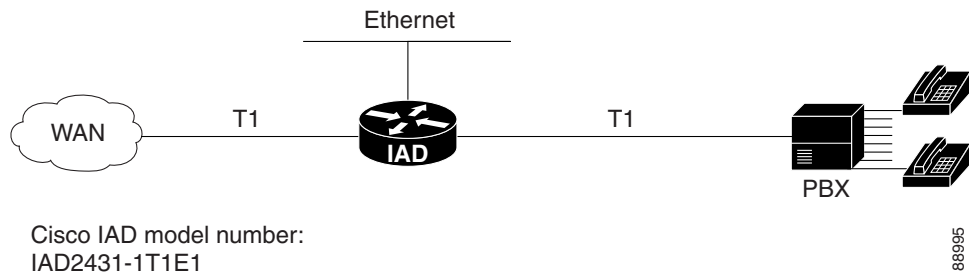
**Figure 1-14 T1/E1 WAN Interface with Analog FXS User Interfaces**



**Figure 1-15 WAN Interface with Analog FXS and FXO User Interfaces**



**Figure 1-16 T1/E1 with T1/E1 Interface to PBX**





## CHAPTER 2

# Planning Your Installation

---

Before you install your Cisco IAD2430 series integrated access device (IAD), see the information in this chapter:

- [Location and Mounting Requirements, page 2-1](#)
- [Distance Limitations for Interface Cables, page 2-4](#)
- [Interference Considerations, page 2-6](#)

## Location and Mounting Requirements

The three mounting possibilities for your Cisco IAD are as follows:

- Rack mounting
- Wall mounting
- Desktop mounting

The mounting location must provide the following:

- Access to the chassis
- Access to a suitable power source
- Access to an appropriate earth ground
- Allowance for adequate heat dissipation and airflow around the chassis

## Temperature Control and Ventilation

For proper cooling, the installation location (room, closet, or cabinet) for the Cisco IAD2430 series IAD should always be well ventilated and provide adequate air circulation. The room temperature should be maintained at from 32 to 122°F (0 to 50°C).



**Note**

---

The Cisco IAD2430, IAD2431, and IAD2432 series IAD chassis is designed for front-to-back airflow.

---

### Rack-Mounted Installation

If the Cisco IAD is installed in an enclosed rack with a ventilation fan at the top, make sure that heated air drawn upward from other equipment does not prevent adequate cooling.

**Caution**

Enclosed racks must have adequate ventilation. An enclosed rack should never be overcrowded and should have louvers and a fan.

If you install the chassis by using slide rails, check for blocked ventilation ports when the chassis is positioned in the rack or cabinet. Make sure that the ventilation ports of the Cisco IAD are not blocked.

**Tip**

Baffles can help isolate exhaust air from intake air. Baffles also help draw cooling air through the cabinet. The best location for the baffles depends on the airflow patterns in the rack. You can test the airflow by experimenting with various equipment arrangements.

## Wall-Mounted Installation

If you install the Cisco IAD on a wall, there should be plenty of space on both sides for adequate airflow through the chassis.

## Desktop Installation

If you place the unit on a desktop, do not stack other equipment or paper on the chassis. Allow plenty of space for air circulation (front to back). Inadequate ventilation can result in equipment overheating and damage.

## Access to Chassis

Allow space at the back of the chassis for cable connections. Also consider the need to access the chassis for future upgrades, maintenance, and troubleshooting.

## Chassis Grounding

Chassis grounding is provided through the power cable, which uses a standard grounding plug. However, the chassis also requires a reliable earth ground, using the earth ground lug and hardware provided. For more information, see the [“Installing the Ground Connection”](#) section on page 3-14.

## Power Source

A Cisco IAD2430 series IADs with AC power supply autoselects either 100- to 127-V or 200- to 240-V operation. The Cisco IADs with AC power supply include a 6-foot (1.8-meter) electrical power cord. (A label near the power cord indicates the correct voltage, frequency, current draw, and power dissipation.)

The Cisco IAD2435 IAD connects to a 60-W, 12-VDC power adapter with the following specifications:

- Input voltage—85 to 264 VAC
- Input frequency—47 to 63 Hz
- Power output—60 W maximum
- Output voltage—+12 VDC



**Caution**

The Cisco IAD2430 series chassis provides inputs for both AC and DC power. Design your installation to use only one type of power. *Do not use AC and DC power at the same time.* If you do, the unit stops operating, and you need to reboot it with only a single power source.

If you suspect that your AC power is not clean—for example, if lights flicker often or if there is machinery with large motors nearby—have a qualified person test the power. Install a power conditioner if necessary.

Please read all the warnings and cautions before applying power to your Cisco IAD.

**Warning**

**Do not work on the system or connect or disconnect cables during periods of lightning activity.** Statement 1001

**Warning**

**Read the installation instructions before you connect the system to its power source.** Statement 1004

**Warning**

**This product relies on the building's installation for short-circuit (overcurrent) protection. Ensure that the protective device is rated not greater than: 120 VAC, 15A U.S. (240 VAC, 10A international)** Statement 1005

**Warning**

**The device is designed for connection to TN and IT power systems.** Statement 1007

**Warning**

**This unit is intended for installation in restricted access areas. A restricted access area can be accessed only through the use of a special tool, lock and key, or other means by security.** Statement 1017

## Cable Types

The cable types that you use depends on which Cisco 2430 series IAD you are using. For more information see the [“Interfaces and Service Capabilities”](#) section on page 1-11.

- Fast Ethernet cables RJ-45-to-RJ-45 straight-through cables
- Analog voice cables (RJ-21)
- T1/E1 interface cable (RJ-48)
- Synchronous serial cables
  - EIA/TIA-232 (DCE/DTE)
  - EIA/TIA-449 (DCE/DTE)
  - V.35 (DCE/DTE)
  - X.21 (DCE/DTE)
  - EIA/TIA-530/EIA/TIA-530A (DCE/DTE)

Before you connect a device to the synchronous serial port (labeled SERIAL 0), you need to know the following:

- Type of device, DTE or DCE, you are connecting to the synchronous serial interface
- Type of connector, male or female, required to connect at the device
- Signaling standard required by the device

## Distance Limitations for Interface Cables

When planning your installation, consider distance limitations and potential electromagnetic interference (EMI) as defined by the Electronic Industries Association (EIA). Distance limitation information is included for the following IAD ports:

- [Fast Ethernet Maximum Distance, page 2-4](#)
- [T1/E1-WAN Port Maximum Distances, page 2-4](#)
- [Serial Port Maximum Distances \(WIC/VIC Cards\), page 2-4](#)
- [T1/E1-PBX Digital Voice Port Maximum Distances, page 2-6](#)
- [FXS Analog Voice Port Maximum Distance, page 2-6](#)
- [FXO Analog Voice Port Maximum Distance, page 2-6](#)

### Fast Ethernet Maximum Distance

The maximum segment distance for Fast Ethernet is 330 feet (100 meters) (specified in IEEE 802.3).

### T1/E1-WAN Port Maximum Distances

[Table 2-1](#) shows the distance limitations for T1/E1 signals (specified in ANSI T1.403).

**Table 2-1 T1/E1- WAN Port Distance Limitations**

Signal Rate	Distance (Feet)	Distance (Meters)
T1/E1 (CSU)	6200	1890

### Serial Port Maximum Distances (WIC/VIC Cards)

[Table 2-2](#) shows the standard relationship between signal rate and maximum distance for EIA/TIA-232 signals.

**Table 2-2 EIA/TIA-232 Speed and Distance Limitations**

Signal Rate	Distance (Feet)	Distance (Meters)
2400	200	60
4800	100	30
9600	50	15

**Table 2-2** EIA/TIA-232 Speed and Distance Limitations (continued)

Signal Rate	Distance (Feet)	Distance (Meters)
19200	25	7.6
38400	12	3.4
56000	8.6	2.6

**Caution**

EIA/TIA-232 is often used at greater distances than specified in [Table 2-2 on page 2-4](#). If you understand the electrical problems that can arise and can compensate for them, you might still obtain good results; however, we recommend that you keep your cable runs within the standard-defined distances.

[Table 2-3](#) shows the standard relationship between signal rate and maximum distance for EIA/TIA-449, V.35, and X.21 signals.

**Table 2-3** EIA/TIA-449, V.35, and X.21 Speed and Distance Limitations

Signal Rate	Distance (Feet)	Distance (Meters)
2400	4100	1250
4800	2050	625
9600	1025	312
19200	513	156
38400	256	78
56000	102	31
T1/E1 (1544000)	50	15

**Caution**

The EIA/TIA-449 and V.35 interfaces support data rates up to 2.048 megabits per second (Mb/s). Exceeding this maximum could result in loss of data and is not recommended.

[Table 2-4](#) shows the standard relationship between signal rate and maximum distance for EIA/TIA-530 and EIA/TIA-530A signals.

**Table 2-4** EIA/TIA-530/EIA/TIA-530A Speed and Distance Limitations

Signal Rate	Distance (Feet)	Distance (Meters)
Up to 90000	3940	1200
110000	460	140
120000	425	130
130000	395	120
1000000	330	100
T1/E1 (1544000)	230	70

## T1/E1-PBX Digital Voice Port Maximum Distances

Table 2-5 shows the maximum distances between the digital voice port of a Cisco IAD and a digital PBX.

**Table 2-5** *Digital Voice Port Speed and Distance Limitations*

Signal Rate	Distance (Feet)	Distance (Meters)
T1/E1 (CSU)	3000	915

## FXS Analog Voice Port Maximum Distance

The maximum distance for a Foreign Exchange System (FXS) is established by a total allowable loop resistance, including off-hook phone or terminal equipment, of 600 ohm. The maximum distance is 100 meters away from the system as a limitation of Ethernet.

## FXO Analog Voice Port Maximum Distance

The maximum distance is determined by the distance between the PBX or other equipment that provides battery and the connection to the FXO voice port.

## Interference Considerations

When you run cables for any significant distance in an electromagnetic field, interference can occur between the electromagnetic field and the signals on the cables. This has two implications for installing terminal plant cabling:

- Unshielded plant cabling can emit radio interference.
- Strong electromagnetic interference (EMI), especially that caused by lightning or radio transmitters, can destroy the EIA/TIA-232 drivers and receivers in the Cisco IAD.

If you use twisted-pair cables with a good distribution of grounding conductors in your plant cabling, emitted radio interference is unlikely.

If you have cables that exceed the recommended distances, or if you have cables that pass between buildings, give special consideration to the effect of lightning strikes or ground loops. If your site has these characteristics, consult experts in lightning suppression and shielding. The electromagnetic pulse caused by lightning or other high-energy phenomena can easily couple enough energy into unshielded conductors to destroy electronic devices.

Without pulse meters and other special equipment, most data centers cannot resolve the infrequent but potentially catastrophic problems just described. Take precautions to avoid these problems by providing a properly grounded and shielded environment and by installing electrical surge suppression.

If you remove any module, you must either install a module in its place or install a cover plate over the opening. All module openings must be either occupied or covered to prevent electromagnetic interference.

For advice on the prevention of electromagnetic interference, consult experts in radio frequency interference (RFI).



# CHAPTER 3

## Installing Cisco IAD2430 Series IADs

---

This chapter contains the procedures for installing your Cisco IAD2430 series integrated access device (IAD) and consists of the following sections:

- [Safety Recommendations, page 3-2](#)
- [Site Log, page 3-3](#)
- [Keeping Track—Checklist, page 3-3](#)
- [Mounting Tools and Equipment, page 3-4](#)
- [Unpacking and Inspection, page 3-5](#)
- [Rack-Mounting the Chassis, page 3-6](#)
- [Wall-Mounting the Chassis, page 3-9](#)
- [Desktop-Mounting the Chassis, page 3-14](#)
- [Installing the Ground Connection, page 3-14](#)
- [Installing a WAN or Voice Card, page 3-17](#)
- [Connecting Cables, page 3-18](#)
- [Ports, Connectors, and Pinouts, page 3-31](#)
- [Remote Terminal Connections \(If Applicable\), page 3-31](#)
- [Connecting Backup Power, page 3-33](#)



### Tip

---

While you perform this installation, record your progress and site information. See the suggested format in the “[Keeping Track—Checklist](#)” section on [page 3-3](#).

---



### Warning

---

**Only trained and qualified personnel should be allowed to install, replace, or service this equipment.** Statement 1030

---



### Warning

---

**Read the installation instructions before connecting the system to the power source.** Statement 1004

---

# Safety Recommendations

The following information is included to alert you to safety recommendations and best practices when working with this equipment.

## Maintaining Safety with Electricity

Follow these guidelines when working on equipment powered by electricity.



Warning

**Do not work on the system or connect or disconnect cables during periods of lightning activity.**

Statement 1001



Warning

**Blank faceplates and cover panels serve three important functions: they prevent exposure to hazardous voltages and currents inside the chassis; they contain electromagnetic interference (EMI) that might disrupt other equipment; and they direct the flow of cooling air through the chassis. Do not operate the system unless all cards, faceplates, front covers, and rear covers are in place.** Statement 1029

## General Safety Practices

Follow these guidelines to ensure personal safety and protect the equipment:

- Keep the chassis area clear and dust-free during and after installation.
- Put the removed chassis cover in a safe place.
- Keep tools away from walk areas where you and others could fall over them.
- Do not wear loose clothing that could get caught in the chassis.
- Wear safety glasses if you are working under any conditions that might be hazardous to your eyes.



Warning

**This equipment must be installed and maintained by service personnel as defined by AS/NZS 3260. Incorrectly connecting this equipment to a general-purpose outlet could be hazardous. The telecommunications lines must be disconnected 1) before unplugging the main power connector or 2) while the housing is open, or both.** Statement 1043

## Safety Tips

Use these tips as safety guidelines when installing or working around this equipment.

- Locate the emergency power-off switch for the room in which you are working. Then, if an electrical accident occurs, you can act quickly to turn off the power.
- Disconnect all power before installing or removing a chassis.
- Do not work alone if potentially hazardous conditions exist.
- Never assume that power is disconnected from a circuit. Always check.

- Look carefully for possible hazards in your work area, such as moist floors, ungrounded power extension cables, and missing safety grounds.
- If an electrical accident occurs, proceed as follows:
  - Use caution; do not become a victim yourself.
  - Turn off power to the system.
  - If possible, send another person to get medical aid. Otherwise, assess the condition of the victim and then call for help.
  - Determine if the person needs rescue breathing or external cardiac compressions; then take appropriate action.

## Preventing Electrostatic Discharge Damage

Electrostatic discharge (ESD) can damage equipment and impair electrical circuitry. ESD occurs when electronic components are improperly handled; it can result in complete or intermittent failures.

Always follow ESD-prevention procedures when removing and replacing components.

- Ensure that the chassis is electrically connected to earth ground.
- Wear an ESD-preventive wrist strap, ensuring that it makes good skin contact.
- Connect the clip to the ESD-strap connection jack (to the left of the power switch on the back of the chassis) or to an unpainted chassis frame surface.



### Caution

For safety, periodically check the resistance value of the antistatic strap, which should be between 1 and 10 megohm (Mohm).

## Site Log

We recommend that you maintain a Site Log to record all actions relevant to the system. Site Log entries might include the following:

- Installation—Print a copy of the Installation Checklist and insert it into the Site Log.
- Upgrades and maintenance—Use the Site Log to record ongoing maintenance and expansion history. Update the Site Log to reflect the following:
  - Configuration changes
  - Maintenance schedules, requirements, and procedures performed
  - Comments, notes, and problems
  - Changes and updates to the Cisco IOS software

## Keeping Track—Checklist

We recommend that you use an installation checklist and maintain a Site Log.

## Installation Checklist

The Installation Checklist (see [Figure 3-1](#)) lists the tasks for installing a Cisco IAD. Print a copy of this checklist and mark the entries as you complete each task. For each Cisco IAD, include a copy of the Installation Checklist in your Site Log.

**Figure 3-1** Installation Checklist

Installation Checklist for site \_\_\_\_\_

Cisco IAD name/serial number \_\_\_\_\_

Task	Verified by	Date
Background information placed in Site Log		
Environmental specifications verified		
Site power voltages verified		
Installation site prepower check completed		
Required tools available		
Additional equipment available		
Cisco IAD received		
Quick start guide received		
Regulatory compliance and safety information received		
Information packet, warranty card, and Cisco.com card received		
Software version verified		
Rack, desktop, or wall mounting of chassis completed		
Initial electrical connections established		
ASCII terminal attached to console port		
Modem attached to console port (for remote configuration)		
Signal distance limits verified		
Startup sequence steps completed		
Initial operation verified		

## Mounting Tools and Equipment

Obtain the following tools and parts needed for installing a Cisco IAD2430 series IAD:

- Standard flat-blade screwdriver as required for attaching brackets to rack or wall.
- Phillips screwdriver for attaching brackets to the IAD.
- Mounting brackets and screws for 24-inch rack, if required.
  - Four telco machine screws for installing the chassis in a rack (use the screw size required by the rack).
- Screws and anchors for wall mounting, if required.



- Eight wood screws or other fasteners for installing the chassis on a wall. An additional starter screw can be used to facilitate wall-mounting (does not include Cisco IAD2435 IAD).
- For Cisco IAD2435 IAD—two number-six, 3/4-inch (M3.5 x 20-mm) screws.
- ESD-preventive wrist strap

In addition, you might need the following external equipment:

- Console terminal, or personal computer with terminal emulation software
- PC running terminal emulation software for administrative access
- Modem for remote access
- Analog voice RJ-21 cable
- Digital voice RJ-48 T1/E1 cable
- Serial, RJ-48, or RJ-45 cables for connecting WAN interface cards (WICs) or voice interface cards (VICs)
- CSU/DSU for the serial interfaces
- Ethernet switch
- Modem for remote configuration

**Note**

---

Serial cables use the Cisco 12-in-1 connector on the WAN connection end.

---

## Unpacking and Inspection

Do not unpack the Cisco IAD2430 series IAD until you are ready to install it. If the installation site is not ready, keep the chassis in its shipping container to prevent accidental damage.

The IAD, cables, and any optional equipment you ordered might be shipped in more than one container. When you unpack each shipping container, check the packing list to ensure that you received all the following items:

- Cisco IAD2430 series IAD
- Power cord

**Note**

---

Power cords vary, depending upon local requirements.

---

- RJ-45-to-DB-25 adapter cable (labeled CON)
- RJ-45-to-DB-9 adapter cable (labeled AUX)
- Rack-mounting brackets for 19-inch rack (one pair) with screws for attaching to chassis

**Note**

---

Rack-mount brackets for 19-inch rack, NEBS grounding kit, and chassis guard for wall-mounting applications are not included with the Cisco IAD2435-8FXS.

---

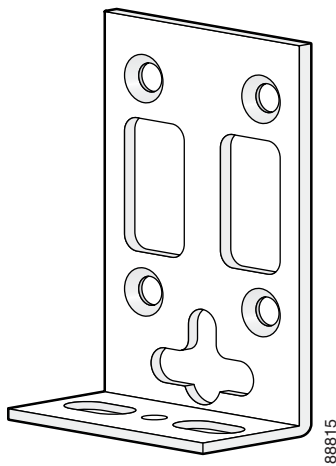
- Grounding lug and fasteners

Inspect all items for shipping damage. If anything appears damaged, or if you encounter problems when installing or configuring your system, contact a customer service representative. (See the “[Obtaining Documentation and Submitting a Service Request](#)” section on page xvi.)

## Rack-Mounting the Chassis

Your chassis ship with a pair of brackets for use with a 19-inch rack or for use for wall mounting on the wall (see [Figure 3-9](#)) (Brackets are not included with the Cisco IAD2435 IAD chassis (see [Figure 3-3](#)), but can be ordered through Cisco.). The bracket is shown in [Figure 3-2](#).

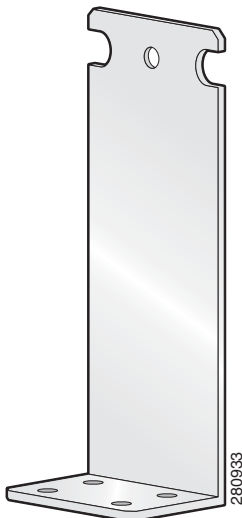
**Figure 3-2** Quick Installation Bracket for all Cisco IAD2430 Series Routers Except for Cisco IAD2435 IAD



**Note**

Rack-mount brackets for 19-inch rack, NEBS grounding kit, and chassis guard for wall-mounting applications are not included with the Cisco IAD2435-8FXS.

**Figure 3-3** Quick Installation Bracket for Cisco IAD2435-8FXS Routers



## Mounting Screws

Two sets of mounting screws are provided, in separate packages (Mounting screws are not included with the Cisco IAD2435 IAD chassis). Take care to use each screw type, and washers as needed, in the appropriate locations. [Table 3-1](#) clarifies the differences between rack-mounting and wall-mounting screws.

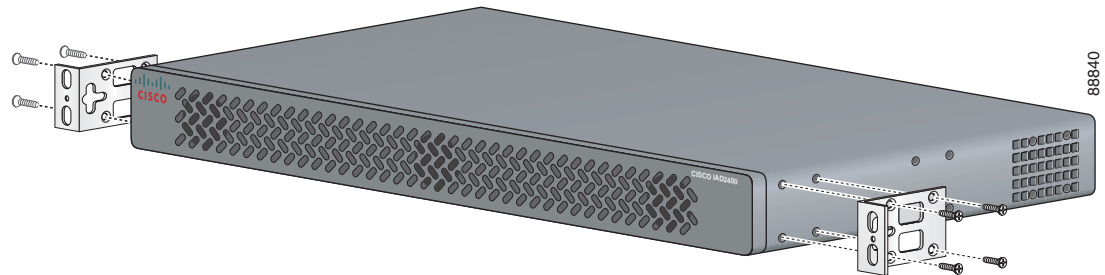
**Table 3-1** Rack-Mounting Screws Versus Wall-Mounting Screws

Rack Mounting	Wall Mounting
<ul style="list-style-type: none"> <li>Eight countersunk Phillips head screws (four per bracket).</li> </ul>	<ul style="list-style-type: none"> <li>Four 6–32 slotted hex screws (two per bracket) and four plastic washers.</li> </ul>
<ul style="list-style-type: none"> <li>Washers are not required.</li> </ul>	<ul style="list-style-type: none"> <li>Washers are required.</li> </ul>

## Attaching the Brackets

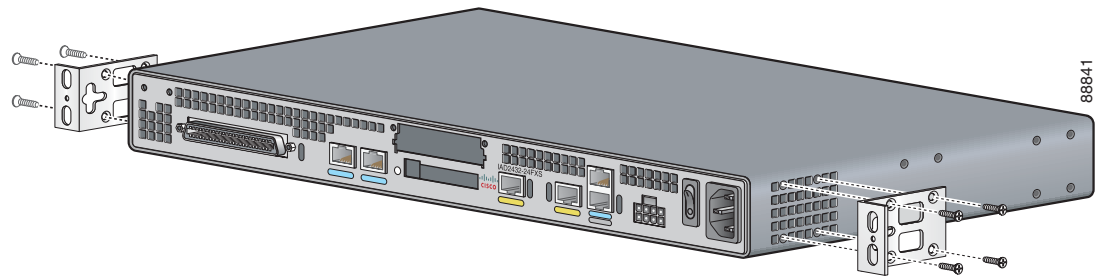
To install the chassis in a rack with the front panel forward, attach the brackets as shown in [Figure 3-4](#).

**Figure 3-4** 19-Inch Rack Installation—Front Panel Forward



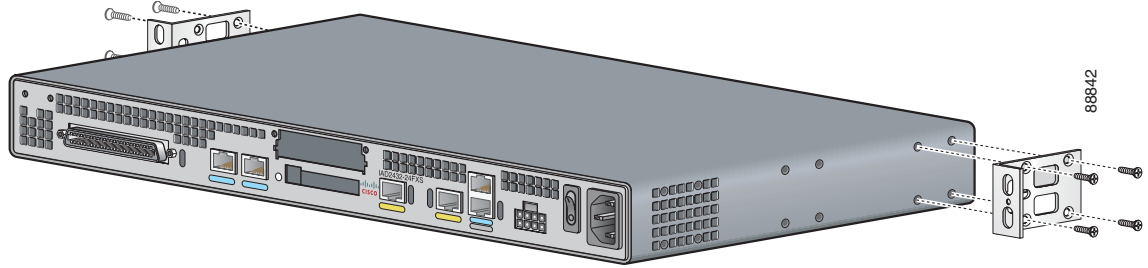
To install the chassis in a rack with the back panel forward, attach the brackets as shown in [Figure 3-5](#).

**Figure 3-5** 19-Inch Rack Installation—Back Panel Forward



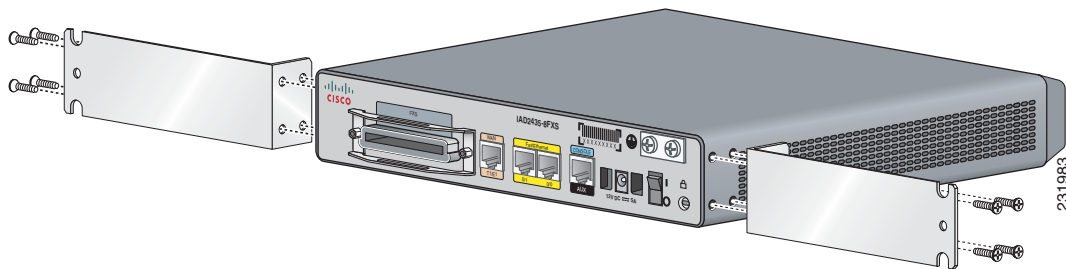
To install the chassis in a center-mount telco rack, attach the brackets as shown in [Figure 3-6](#).

**Figure 3-6 Telco 19-Inch Rack Installation—Back Panel Forward**



To install the Cisco IAD2435 chassis in a rack with the back panel forward, attach the brackets as shown in [Figure 3-7](#).

**Figure 3-7 IAD2435 Rack Installation with Back Panel Forward**



## Installing the Cisco IAD2430 Series IADs in a Rack

The following warning applies only when the unit is rack-mounted:



### Warning

To prevent bodily injury when mounting or servicing this unit in a rack, you must take special precautions to ensure that the system remains stable. The following guidelines are provided to ensure your safety:

This unit should be mounted at the bottom of the rack if it is the only unit in the rack.

When mounting this unit in a partially filled rack, load the rack from the bottom to the top with the heaviest component at the bottom of the rack.

If the rack is provided with stabilizing devices, install the stabilizers before mounting or servicing the unit in the rack.  
Statement 1006



### Warning

Take care when connecting units to the supply circuit so that wiring is not overloaded. Statement 1018

To rack-mount the chassis, follow these steps:

- Step 1** Choose one of the methods shown in [Figure 3-4 on page 3-7](#), [Figure 3-5 on page 3-7](#), [Figure 3-6 on page 3-8](#), or [Figure 3-7 on page 3-8](#), and attach the long side of the mounting brackets to the chassis, as shown.

**Caution**

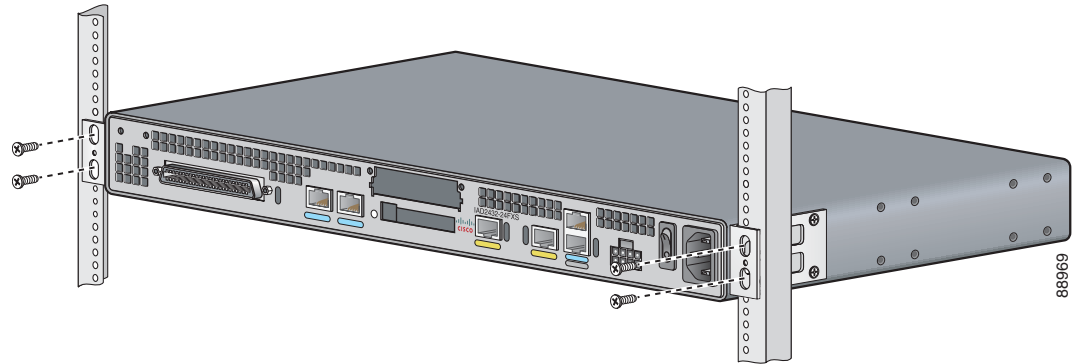
Make sure to use the correct screws for this mounting option (see [Table 3-1 on page 3-7](#)).

Screws are included for attaching the brackets to the chassis, but not for installing the chassis in a rack or on a wall. You need four additional machine screws to install the chassis in a rack. Use the screw size required by your rack. After the brackets are secured to the chassis, you can rack-mount the chassis.

**Step 2**

Using screws that you provide, attach the chassis to the rack as shown in [Figure 3-8 on page 3-9](#).

**Figure 3-8 Attaching the Chassis to the 19-Inch Rack**



## Wall-Mounting the Chassis

The following warning applies only when the unit is wall-mounted:

**Warning**

**This unit is intended to be mounted on a wall. Please read the wall-mounting instructions carefully before beginning installation. Failure to use the correct hardware or to follow the correct procedures could result in a hazardous situation to people and damage to the system.** Statement 248

## Wall-Mounting the Cisco IAD2430, Cisco IAD2431, and Cisco IAD2432 IADs

**Caution**

You can wall-mount the Cisco IAD2430, Cisco IAD2431, or Cisco IAD2432 IAD with either the right side or the left side facing up; however, the front and back panels must be vertical.

To wall-mount the chassis, follow this procedure:

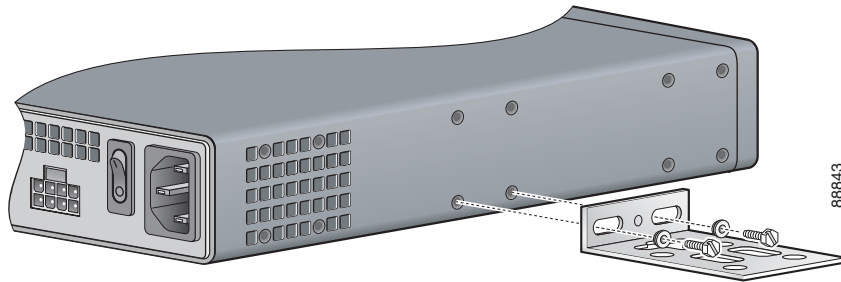
**Step 1**

Attach the short side of one bracket to the chassis, as shown in [Figure 3-9](#), using two 6-32 x 1/4 slotted hex screws (provided). Be sure to use a plastic washer (provided) with each screw; the narrow end of the washer must fit into the bracket slot, facing the chassis.

**Caution**

Be sure to use the correct screws and plastic washers for this mounting option. (See [Table 3-1 on page 3-7](#).)

**Figure 3-9 Attaching the Brackets for Wall-Mounting**



**Step 2** Attach the second bracket to the opposite side of the chassis.

**Step 3** Attach the router to the wall using the brackets previously attached and using attachment hardware that you provide as follows:

- You can install a starter screw in the wall, and hook the bracket keyhole over the screw. This holds the unit in place for easy installation of the attachment screws.
- Attach both brackets to the wall.

**Note**

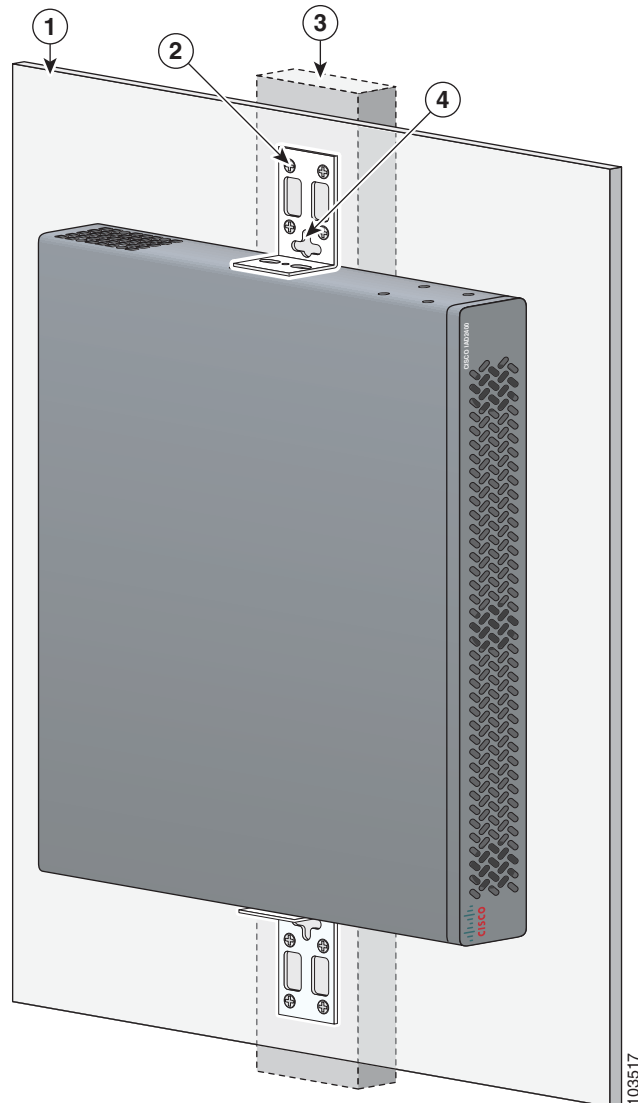
For attaching to a wall stud, each bracket requires two number 10 wood screws (round- or pan-head) with number 10 washers, or two number 10 washer-head screws. The screws must be long enough to penetrate at least 3/4-inch (20-mm) into the supporting wood or metal wall stud.

**Note**

For hollow-wall mounting, each bracket requires two wall anchors with washers. Wall anchors and washers must be size number 10.

- [Figure 3-10](#) shows the orientation required for installation.

Figure 3-10 Wall-Mounting the Chassis



1	Wall	2	Bracket
3	Wall stud	4	Keyhole for starter screw

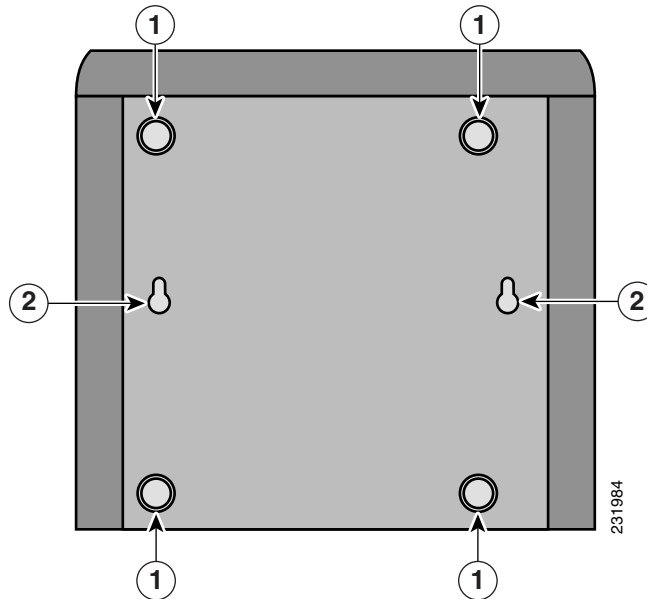
## Wall-Mounting the Cisco IAD2435 IADs

You can mount the router on a wall or other vertical surface by using the molded mounting brackets on the bottom of the router and two number-six, 3/4-inch (M3.5 x 20-mm) screws. You must provide the screws. [Figure 3-11](#) shows the screw holes.

**Caution**

If you are mounting the router on drywall, use two hollow-wall anchors (1/8 inch with 5/16-inch drill bit, or M3 with 8-mm drill bit) to secure the screws. If the screws are not properly anchored, the strain of the network cable connections could pull the router from the wall.

**Figure 3-11** Screw Holes for Wall-Mounting the IAD2435



<b>1</b>	Rubber feet	<b>2</b>	Screw holes
----------	-------------	----------	-------------

The following conditions must be met when you mount the router:

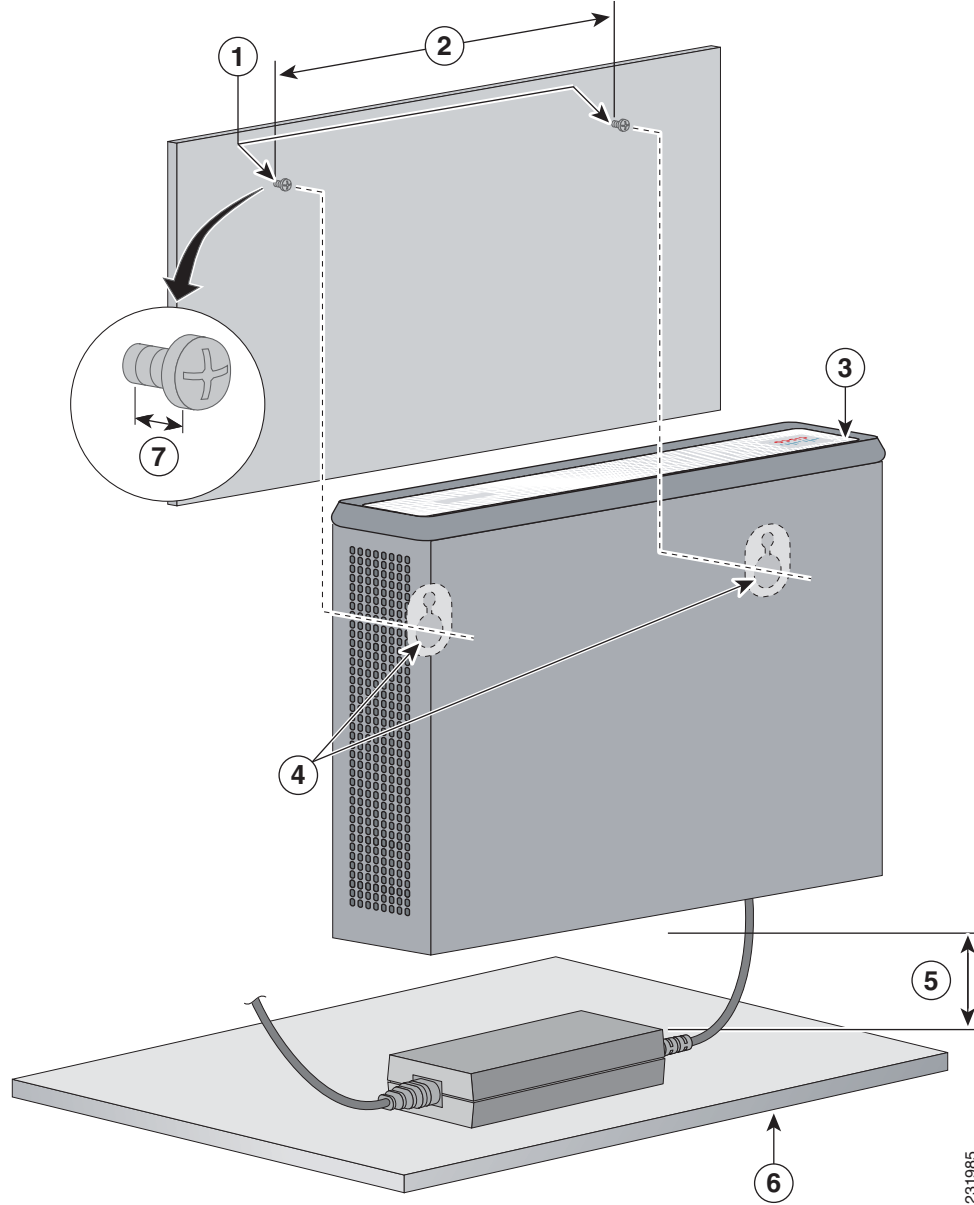
- Because you will use the LEDs as status and problem indicators, the LEDs on the front panel must face upward and must be easily visible.
- The back panel must face downward to reduce strain on the cable connections.
- The external 60-W power supply adapter must rest on a horizontal surface such as the floor or a table. If the power supply is not supported, it could place strain on the powersupply cable and cause it to disconnect from the connector on the router back panel.

To wall-mount the Cisco IAD2435 IADs, follow these steps:

- 
- Step 1** Secure two screws 7 5/8 inches (19.35 centimeters) apart into a wall and 1/8 inch (0.32 centimeter) from the wall.
- Step 2** Hang the router on the screws as shown in [Figure 3-12](#).
- Step 3** Place the power supply on a horizontal surface.



Figure 3-12 Mounting the IAD2435 Router on a Wall



231985

<b>1</b>	Two number-six, 3/4-in. screws	<b>2</b>	Distance between the two screws (7 5/8 in. [19.35 cm])
<b>3</b>	Cisco IAD2435 router	<b>4</b>	Mounting brackets
<b>5</b>	Maximum distance between the router and the external 60-W power supply adapter (6 ft [1.8 m])	<b>6</b>	Horizontal surface for placing the external 60-W power supply adapter
<b>7</b>	Distance between the screw and the wall (1/8 in. [0.32 cm])		

## Desktop-Mounting the Chassis

**Step 1** Verify that a suitable AC power outlet is available.



**Caution**

Do not plug this unit into an AC outlet that does not have a UL-certified receptacle that is properly tied into the building ground.

**Step 2** Place the four rubber feet (from the accessory kit) in the four indentations on the underside of the chassis. This helps provide proper airflow through and around the chassis.

**Step 3** Place the Cisco IAD on the desktop.



**Caution**

Do not place anything on top of the chassis that weighs more than 10 lb (4.5 kg). Excessive weight on top can damage the chassis.

## Setting the Cisco IAD2435 on a Desktop

You can place Cisco IAD2435 on a desktop.



**Caution**

Do not place anything on top of the router that weighs more than 5 pounds (2.25 kg), and do not stack routers on a desktop. Excessive distributed weight of more than 5 pounds, or pound point load of 5 pounds on top could damage the chassis.

## Installing the Ground Connection



**Warning**

**This equipment must be grounded. Never defeat the ground conductor or operate the equipment in the absence of a suitably installed ground conductor. Contact the appropriate electrical inspection authority or an electrician if you are uncertain that suitable grounding is available.** Statement 1024



**Warning**

**AC connected units must have a permanent ground connection in addition to the power cable ground wire. NEBS-compliant grounding satisfies this requirement.** Statement 284



**Warning**

**This equipment needs to be grounded. Use a green and yellow 12 to 14 AWG ground wire to connect the host to earth ground during normal use.** Statement 242

**Warning**

**The importance of proper grounding cannot be overemphasized. It will minimize the potential for damage to your system and maximize safety at the system site. We recommend you consult a licensed electrician or your local electric utility company if you have any questions.** Statement 269

**Warning**

**A ground wire must always be a single piece of wire. Never splice two wires together for a ground. Corrosion and weathering can lead to a poor connection at the splice, making the ground ineffective and dangerous.** Statement 270

**Warning**

**Use copper conductors only.** Statement 1025

**Warning**

**Installation of the equipment must comply with local and national electrical codes.** Statement 1074

You must connect the chassis to a reliable earth ground; the ground wire must be installed in accordance with local electrical safety standards.

- For NEBS-compliant grounding, use size AWG 6 (13 mm<sup>2</sup>) wire and the ground lug provided in the accessory kit.
- For NEC-compliant grounding, use size AWG 14 (2 mm<sup>2</sup>) or larger wire and an appropriate user-supplied ring terminal.
- For EN/IEC 60950-compliant grounding, use size AWG 18 (1 mm<sup>2</sup>) or larger wire and an appropriate user-supplied ring terminal.

To ground the chassis, follow these steps:

**Step 1** Locate a suitable ground location.

**Tip**

Use a multimeter to measure the resistance between various ground locations, such as the following:

- Between the ground of a junction box (outlet) and the ground of a power tap
- Between the ground of a junction box and a metal water pipe
- Between the Cisco IAD chassis and the ground of a power tap
- Between the Cisco IAD chassis and the ground of a junction box

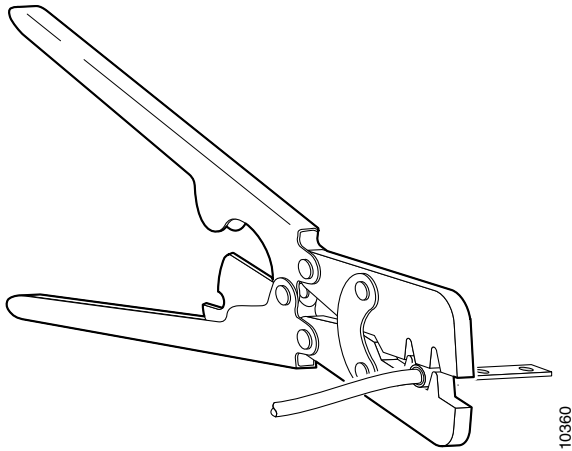
A good ground connection should read between 0.0 and 0.5 ohm.

**Step 2** Strip one end of the ground wire to the length required for the ground lug or terminal.

- For the NEBS ground lug—approximately 0.75 inch (20 millimeters)
- For user-provided ring terminal—as required

**Step 3** Crimp the ground wire to the ground lug or ring terminal, using a crimp tool of the appropriate size. (See [Figure 3-13](#).)

**Figure 3-13** Crimping a Ground Lug onto the Ground Wire

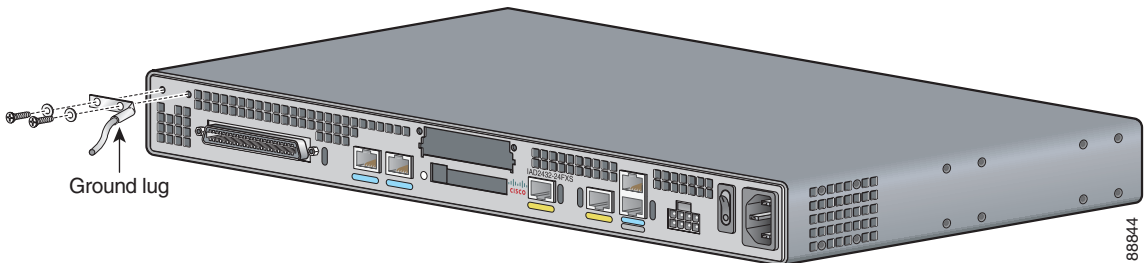


**Step 4** Attach the ground lug or ring terminal to the chassis as shown in [Figure 3-14](#), [Figure 3-15](#), or [Figure 3-16](#). For the ground lug, use the two screws with captive locking washers provided. For a ring terminal, use one of the screws provided. Use a number 2 Phillips screwdriver, and tighten the screws to a torque of 8 to 10 in-lb (0.9 to 1.1 N-m).

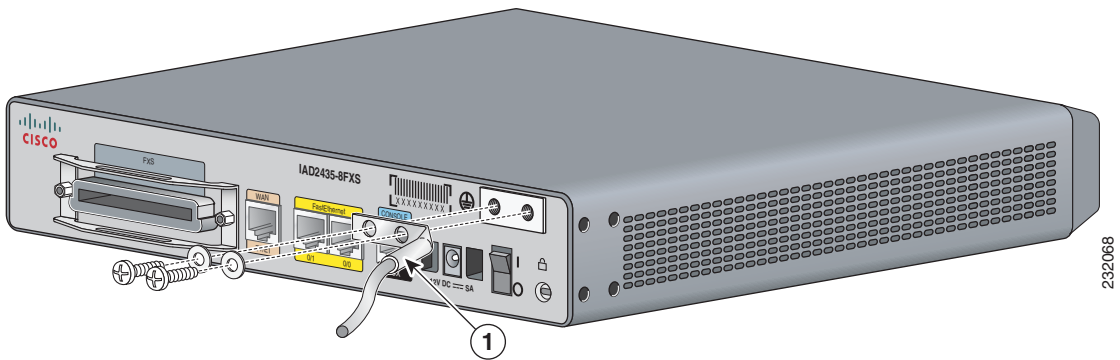


**Note** You can orient the crimped end of the ground lug in either direction (right or left).

**Figure 3-14** NEBS-Compliant Chassis Ground Connection Using Ground Lug

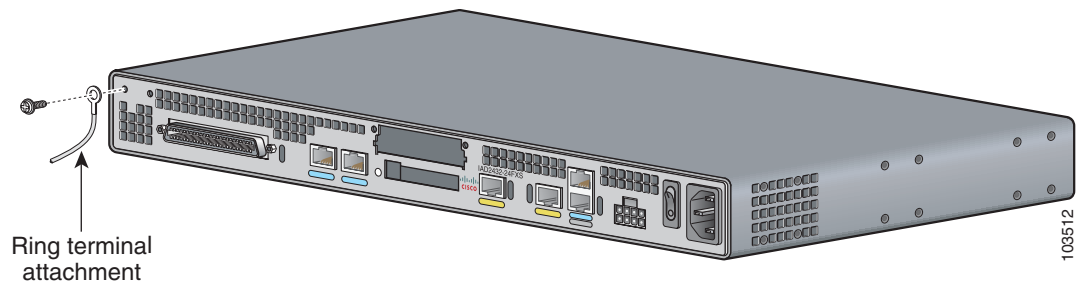


**Figure 3-15** Ground Lug Location on the Cisco IAD2435 IAD



<b>1</b>	Grounding lug	
----------	---------------	--

**Figure 3-16** Chassis Ground Connection Using Ring Terminal



**Step 5** Connect the other end of the ground wire to a grounding point at your site.

## Installing a WAN or Voice Card

The Cisco IAD2430 series IADs include a slot for a WAN interface card (WIC) or a voice interface card (VIC).



**Note**

The Cisco IAD2435 router is a fixed-configuration router and does not support interface cards.

The following WICs and VICs (also used by the Cisco 2600 series and Cisco 3600 series routers) are supported in releases of the Cisco IAD2430 series IADs:

- WIC-1T
- WIC-2T
- WIC-1DSU-T1/E1
- VIC2-2FXS
- VIC2-4FXS
- VIC2-2FXO
- VIC2-4FXO
- VIC2-2BRI-NT/TE
- WIC-1ADSL
- WIC-1SHDSL-V2
- WIC-1ADSL-DG
- VWIC-2MFT-T1/E1
- VWIC-2MFT-E1



**Warning**

**For connections outside the building where the equipment is installed, the following ports must be connected through an approved network termination unit with integral circuit protection. FXS/T3/E3. Statement 1044**

**Note**


---

Contact your Cisco account representative for the most recent, supported cards.

---

For detailed information on installing and connecting interface cards, see “Installing WAN and Voice Interface Cards in Cisco Modular Routers,” in the *Cisco Interface Cards Installation Guide*, at the following URL:

[http://www.cisco.com/univercd/cc/td/doc/product/access/acs\\_mod/cis2600/hw\\_inst/wic\\_inst/wic\\_doc/index.htm](http://www.cisco.com/univercd/cc/td/doc/product/access/acs_mod/cis2600/hw_inst/wic_inst/wic_doc/index.htm)

**Caution**


---

WAN and voice interface cards do not support online insertion and removal (hot swapping). Before inserting a card into the Cisco IAD chassis, you must turn off electrical power and disconnect network cables.

Always use an ESD-preventive wrist strap before handling cards.

---

To install a WIC or VIC, follow these steps:

- 
- Step 1** Use a number 2 Phillips screwdriver to remove the screws holding the metal plate over the card slot cover. Remove the plate.
  - Step 2** Holding the interface card by the edges, line up the card with the guides on both sides of the slot.
  - Step 3** Insert the card in the slot. Push until it is firmly seated in the connector and the front panel of the card is flush with the back panel of the Cisco IAD.
  - Step 4** Use the screwdriver to tighten the captive screws on the card.
- 

## Connecting Cables

Cisco IAD ports are color-coded for identification.

**Warning**


---

**Do not work on the system or connect or disconnect cables during periods of lightning activity.** Statement 1001]

---

**Warning**


---

**This product relies on the building's installation for short-circuit (overcurrent) protection. Ensure that the protective device is rated not greater than: 120 VAC, 15A (240 VAC, 10A international)** Statement 1005

---

**Warning**


---

**To prevent accidental discharge in the event of a power line cross, route on-premise wiring away from power cables and off-premise wiring, or use a grounded shield to separate the on-premise wiring from the power cables and off-premise wiring. A power line cross is an event, such as a lightning strike, that causes a power surge. Off-premise wiring is designed to withstand power line crosses. On-premise wiring is protected from power line crosses by a device that provides overcurrent and overvoltage protection. Nevertheless, if the on-premise wiring is in close proximity**

---

**to, or not shielded from, the off-premise wiring or power cables during a lightning strike or power surge, the on-premise wiring can carry a dangerous discharge to the attached interface, equipment, and nearby personnel.** Statement 338

Table 3-2 shows the results of the NEBS Type 1/3 power line cross tests performed on the Cisco IAD2430 series FXS ports.

**Table 3-2 Results of the NEBS Power Line Cross Tests on FXS Ports**

NEBS Tests	Results
50 V/0.33 A; 15 minutes	Passed
100 V/0.17 A; 15 minutes	Passed
200 V/1.00 A; 1-second pulses, 60 repetitions	Passed



**Note**

The installation must comply with all applicable codes.

## LAN and Power Cables

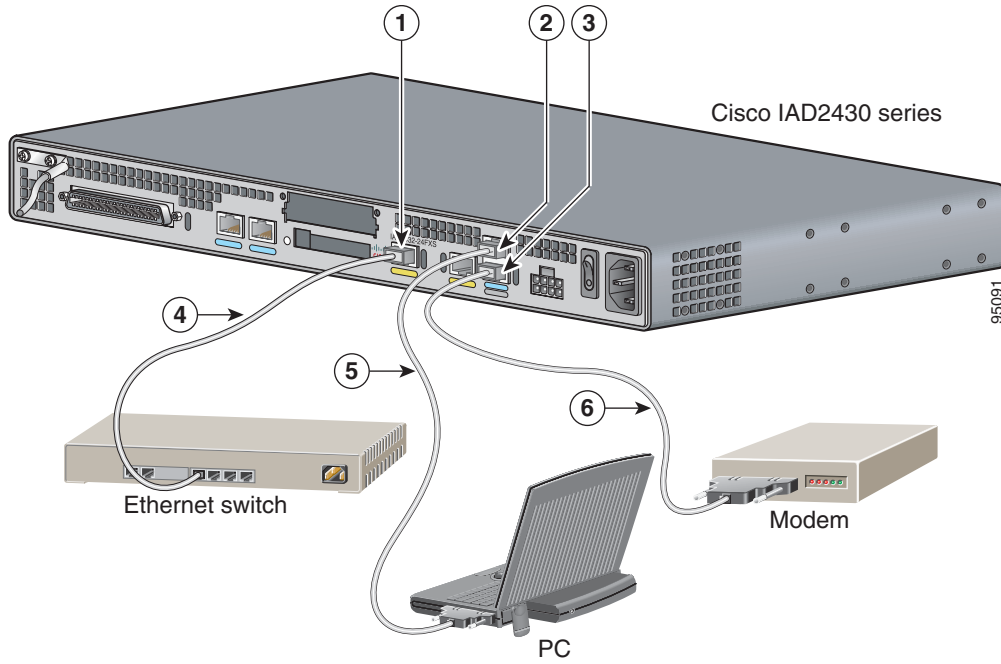
The LAN and power cables and connections are described in Table 3-3 and shown in Figure 3-17 and Figure 3-18.

**Table 3-3 LAN, Administrative Access, and Power Cable Selection**

Port or Connection	Color or Type	Connected To	Cable
Fast Ethernet	Yellow	Fast Ethernet switch	Straight-through Fast Ethernet cable (not included)
Console	Light blue	PC or ASCII terminal communication (COM) port	RJ-45-to-DB-9 console cable (included)
Auxiliary	Black	Modem for remote access	RJ-45-to-DB-25 auxiliary cable (included)
Power (not shown)	Power	100–240 VAC, 50–60 Hz	Grounding power cord (included) <sup>1</sup>

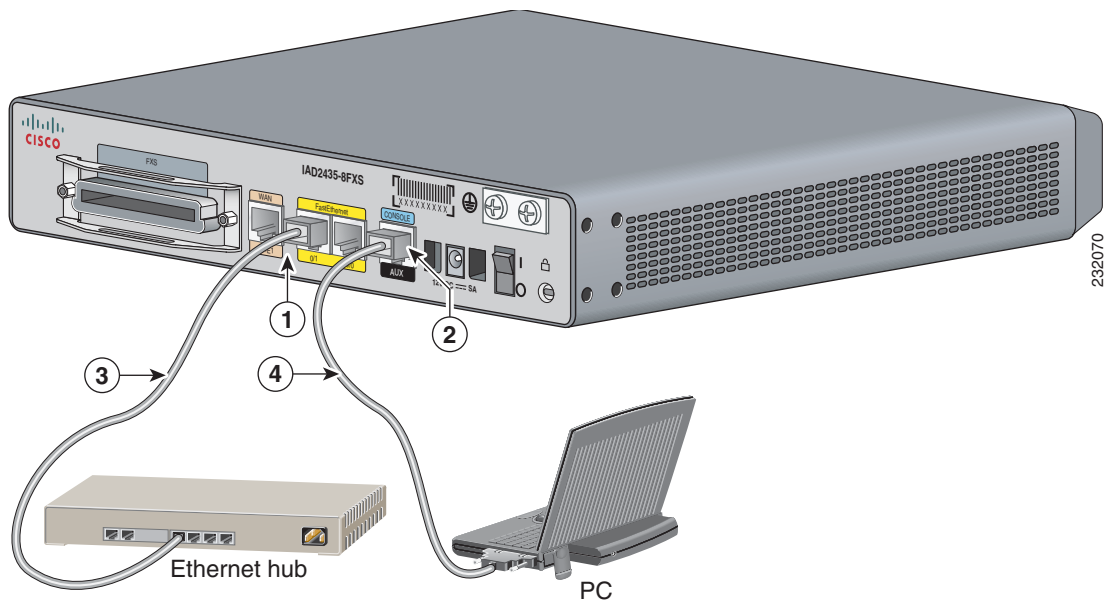
1. Power cables vary to meet local requirements.

Figure 3-17 LAN and Administrative Access Connections



1	Fast Ethernet port	2	Console port
3	AUX port	4	Fast Ethernet (straight-through)
5	RJ-45-to-DB-9 console cable	6	RJ-45-to-DB-25 auxiliary cable

Figure 3-18 LAN, Administrative Access, and Connections (Cisco IAD2435 IAD)





<b>1</b>	Fast Ethernet port	<b>2</b>	Serial port—console or auxiliary
<b>3</b>	Fast Ethernet (straight-through)	<b>4</b>	RJ-45-to-DB-9 console cable

## Connecting the Input Power

To connect input power to the Cisco IAD, use the procedure in this section.



### Caution

The Cisco IAD2430 series chassis provides inputs for both AC and DC power. Design your installation to use only one type of power. *Do not use AC and DC power at the same time.* If you do, the unit stops operating, and you must reboot it with only a single power source.

## Cable

The AC power cable is used for this application.

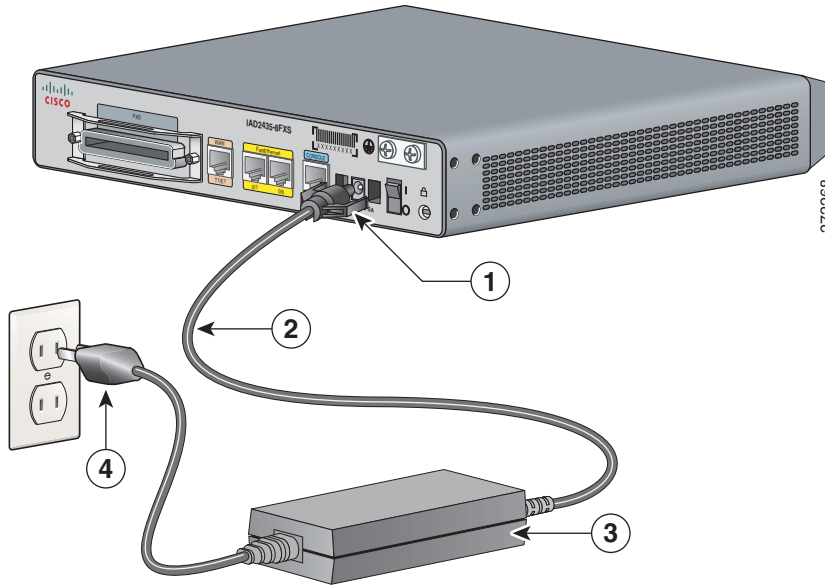
## Procedure

- 
- Step 1** Connect the AC power cable (supplied) to the recessed power plug on the back of the concentrator.
  - Step 2** Plug the cable into a power source with a voltage of 100 to 240 VAC.
- 

## Connecting Input Power on the Cisco IAD2435 IAD

To connect input power to the Cisco IAD2435, perform the following steps:

- 
- Step 1** Connect the router to an AC power outlet as shown in [Figure 3-19](#).
  - Step 2** To secure the power cord to the router, attach the power lock clip to the power cord, and slide the clip to the end of the DC plug. See location 1 in [Figure 3-19](#).
-

**Figure 3-19** Connecting the External Power Supply to the Cisco IAD2435

1	Power lock clip	2	Power cord
3	Power adapter	4	AC plug

## Connecting the Console Port to a PC or an ASCII Terminal

To connect the console port to a PC that is running terminal emulation software, use the procedure in this section.



### Note

The console port does not support hardware flow control.

## Cable

Use an RJ-45-to-DB-9 console cable (see location 5 in [Figure 3-17 on page 3-20](#)).

## Procedure

- 
- Step 1** Connect the cable between the Cisco IAD console port and the serial port on the PC or ASCII terminal.
- Step 2** Configure the terminal emulation software requirements:
- 9600 baud
  - 8 data bits
  - 1 stop bit
  - no parity

- no flow control
- 

## Connecting the Auxiliary Port to a Modem

To connect the auxiliary port to a modem, use the procedure in this section.

### Cable

Use an RJ-45-to-DB-25 auxiliary cable (labeled Modem).

### Procedure

- 
- Step 1** Connect the cable from the auxiliary port (black) to the DB-25 port on the modem. (See location 6 in [Figure 3-17 on page 3-20](#).)
- Step 2** Configure the modem:
- Match the transmission speed of the auxiliary port (default is 9600 baud).
  - Set the hardware flow control for Data Carrier Detect (DCD) and Data Terminal Ready (DTR) operation.

**Note**

The baud rate for the auxiliary (and console) port can be configured in software for 1200, 2400, 4800, 19200, 38400, 57600, or 115200.

---

## Connecting the Fast Ethernet Port to the Fast Ethernet Switch

To connect a Fast Ethernet port to the Fast Ethernet switch, use the procedure in this section.

### Cable

Use a straight-through Fast Ethernet cable (not included).

### Procedure

- 
- Step 1** Connect the cable from a Fast Ethernet port to an available port on the Fast Ethernet switch. (See location 4 in [Figure 3-17 on page 3-20](#).)
- Step 2** Connect the second cable if it is required.

**Note**

Not all models have two ports.

---

## WAN and Voice Cables


**Warning**

For connections outside the building where the equipment is installed, the following ports must be connected through an approved network termination unit with integral circuit protection.  
**FXS/T3/E3** Statement 1044


**Note**

The following warning also applies to Cisco IAD2430 units that have an RJ-21 interface.


**Warning**

Before opening the unit, disconnect the telephone-network cables to avoid contact with telephone-network voltages. Statement 1041


**Warning**

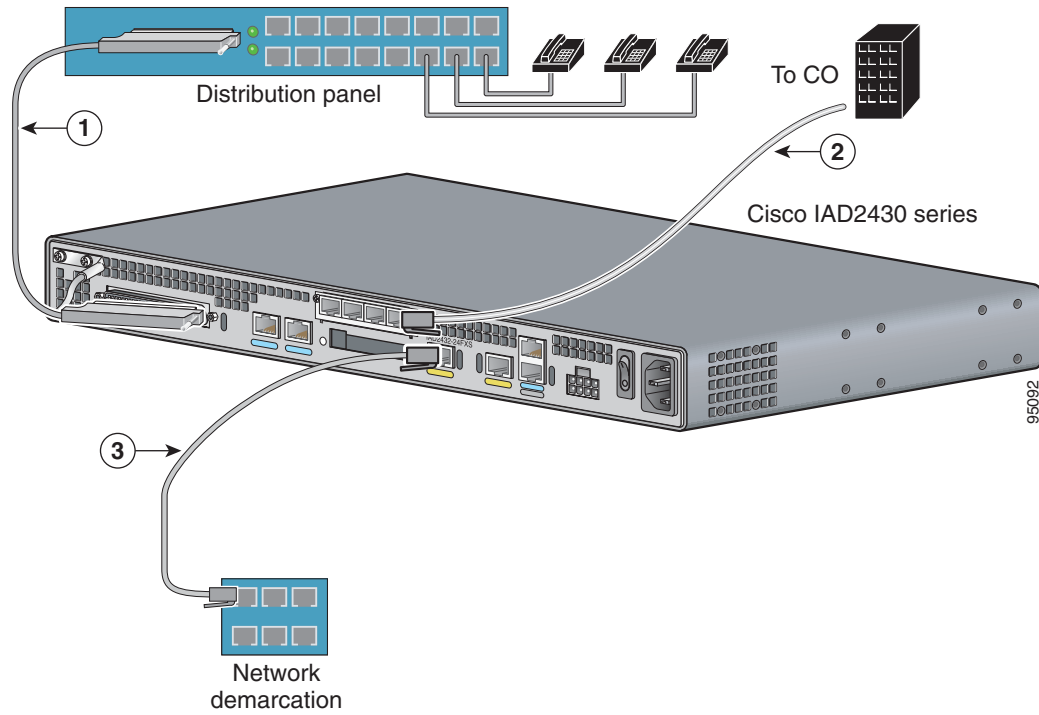
This equipment contains a ring signal generator (ringer), which is a source of hazardous voltage. Do not touch the RJ-11 (phone) port wires (conductors), the conductors of a cable connected to the RJ-11 port, or the associated circuit-board when the ringer is active. The ringer is activated by an incoming call. Statement 1042

These cables and connections are described in [Table 3-4 on page 3-24](#) and shown in [Figure 3-20 on page 3-25](#).

**Table 3-4** WAN and Voice Cable Selection

Port or Interface		Color or Type	Connected To	Cable
T1/E1	WAN	Light green	WAN	RJ-48 T1/E1 cable (not included)
T1/E1	Digital voice	RJ-48C	Digital PBX	RJ-48 T1/E1 cable (not included)
Analog voice	FXS	RJ-21	Distribution panel	RJ-21-to-RJ-21 straight-through cable (not included)
WIC-2T	Serial	Cisco 12-in-1 serial port connector	CSU/DSU and serial network or equipment	Serial transition cable matching signaling protocol (EIA/TIA-232, EIA/TIA-449, V.35, X.21, or EIA-530) and operating mode (DTE or DCE) (not included)
WIC-1DSU-T1/E1	WAN	Light green	WAN	RJ-48 T1/E1 cable (not included)
VIC2-4FXO	FXO	RJ-11	Station side of analog PBX	RJ-11 cable (not included)

**Figure 3-20 WAN and Voice Connections**

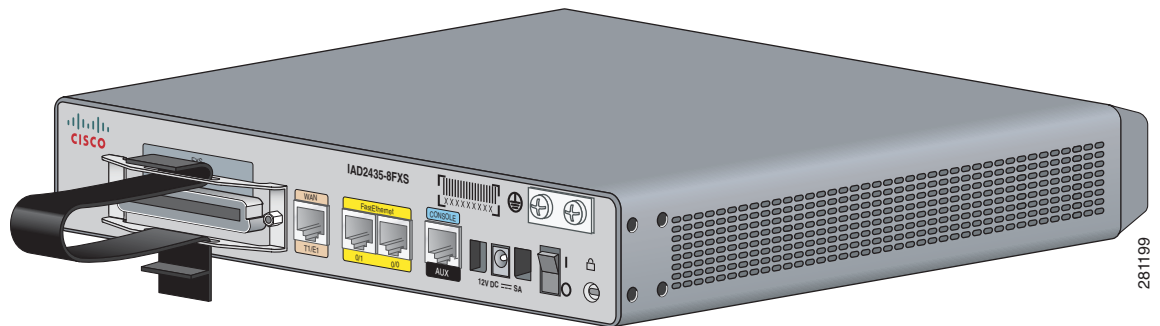


<b>1</b>	RJ-21 cable	<b>2</b>	RJ-45 cable (through a patch panel) to central office (CO)
<b>3</b>	RJ-48 straight-through cable		

## Connecting the RJ-21 Cable in the Velcro Harness

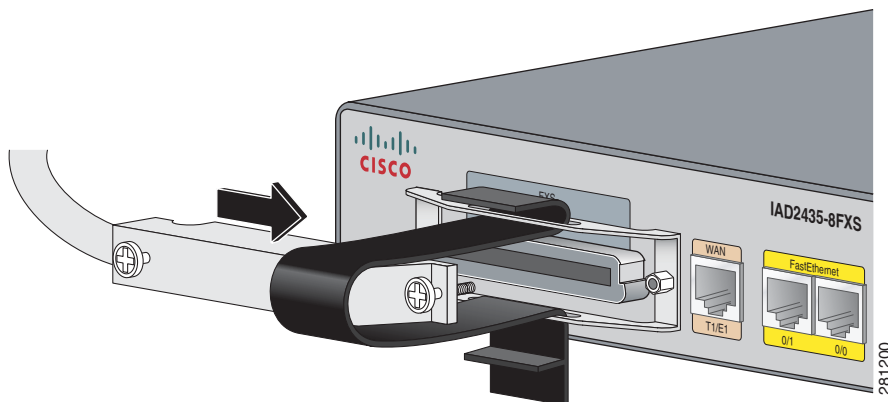
For the Cisco IAD2430 series models that have a Velcro harness available for the RJ-21 cable (see [Figure 3-21](#)), follow these steps:

**Figure 3-21 Cisco IAD2430 Series RJ-21 Velcro Harness**



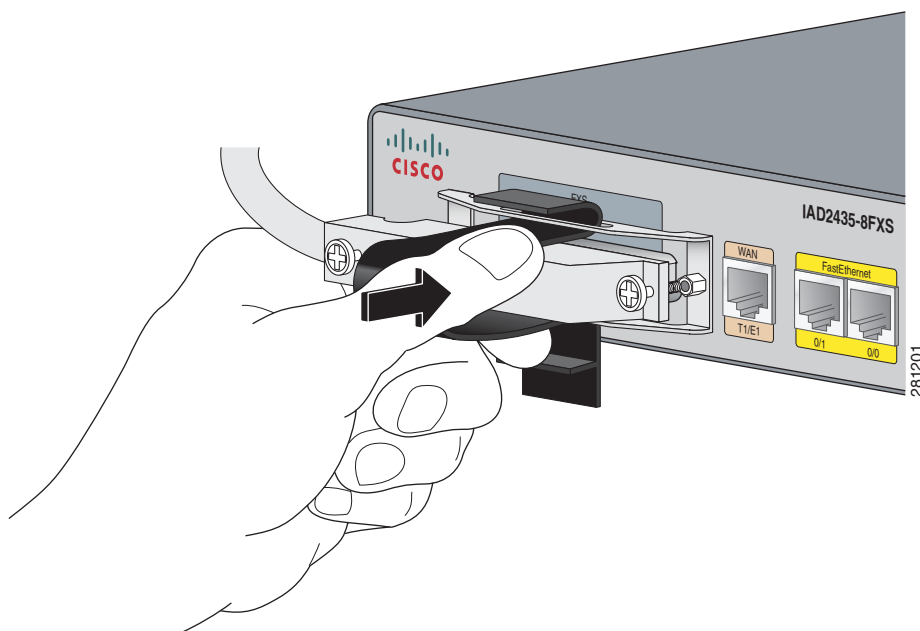
**Step 1** Slip the RJ-21 cable connector through the Velcro strap (see [Figure 3-22](#)).

**Figure 3-22** Sliding the RJ-21 Cable Through the Velcro Harness

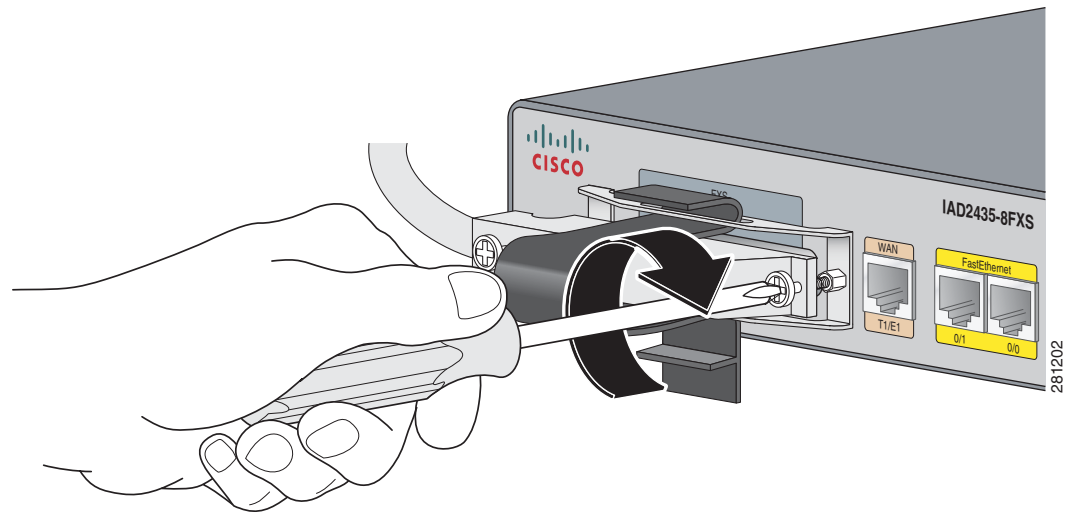


- Step 2** Push the male RJ-21 cable connector into the slot of the female RJ-21 connection on the router. Push the male RJ-21 cable firmly until the RJ-21 security clips are firmly seated (see [Figure 3-23](#)).

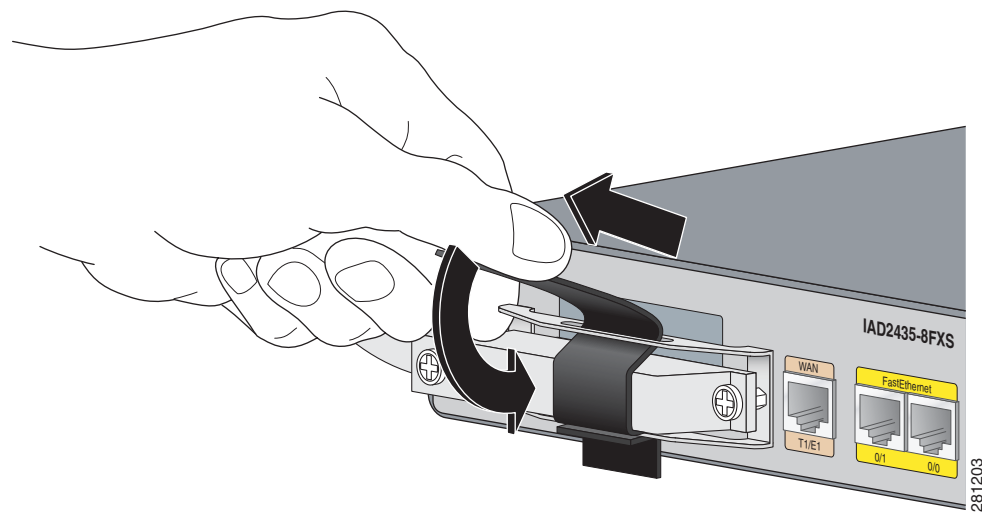
**Figure 3-23** Pushing the RJ-21 Cable in to the Cisco IAD2435 IAD



- Step 3** Use a number 2 (flat or Phillips screwdriver) to attach the captive screws on the RJ-21 male connector (see [Figure 3-24](#)).

**Figure 3-24** Tightening the Captive Screws

**Step 4** Pull the Velcro strap up until tight, then down and affix the strap to other Velcro side (see [Figure 3-25](#)).

**Figure 3-25** Tightening the Velcro Strap

## Connecting a Serial Interface Port to a CSU/DSU or a Synchronous Modem

Use the procedure in this section to connect the serial interface port to a CSU/DSU or to a synchronous modem.

The serial port (S0) can operate as follows:

- DTE or DCE with the following signaling:
  - EIA/TIA-232
  - EIA-TIA-449
  - V.35

- X.21
- DTE only with EIA/TIA -530 signaling

**Note**

DTE ports require external clocking provided by a DCE device such as a CSU/DSU.

**Cable**

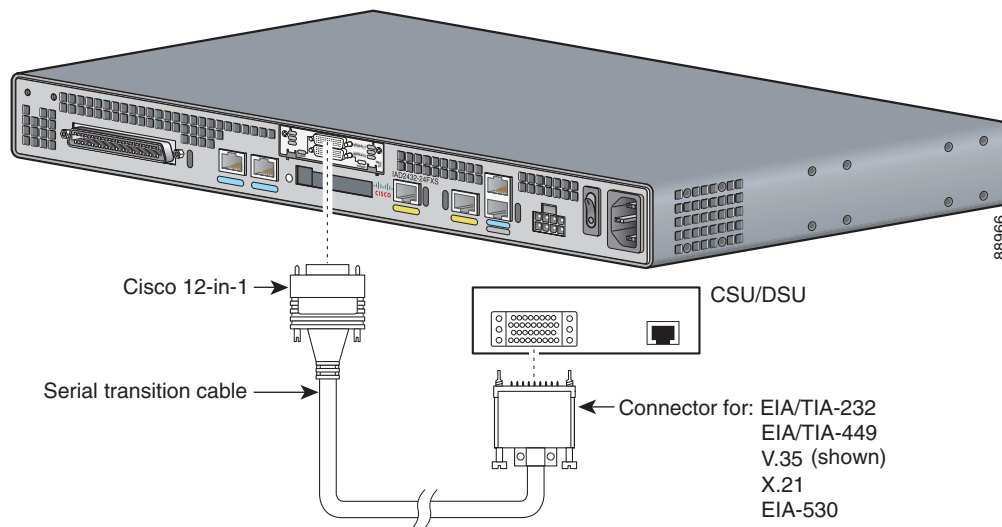
The type of cable you connect to the serial port automatically sets the port for DTE or DCE operation and establishes the signaling standard.

**Procedure**

Use the procedure in this section to connect external equipment to the Cisco 2430 series IAD.

- Step 1** Connect the appropriate serial interface cable between the WAN serial port and the serial port connector (see [Figure 3-26](#)).

**Figure 3-26 Serial Port Connection**



- Step 2** Connect the external equipment (CSU/DSU or other serial device).

**Connecting a T1/E1-WAN Port to the Network Demarcation Device**

To connect the T1/E1 port to a network demarcation device, use the procedure in this section.

**Warning**

**To avoid electric shock, do not connect safety extra-low voltage (SELV) circuits to telephone-network voltage (TNV) circuits. LAN ports contain SELV circuits, and WAN ports contain TNV circuits. Some LAN and WAN ports both use RJ-45 connectors. Use caution when connecting cables.** Statement 1021



**Warning**

**Hazardous network voltages are present in WAN ports regardless of whether power to the router is OFF or ON. To avoid electric shock, use caution when working near WAN ports. When detaching cables, detach the end away from the router first.** Statement 1026

**Note**

The T1/E1-WAN port has a built-in CSU/DSU for connecting to a service provider's network interface.

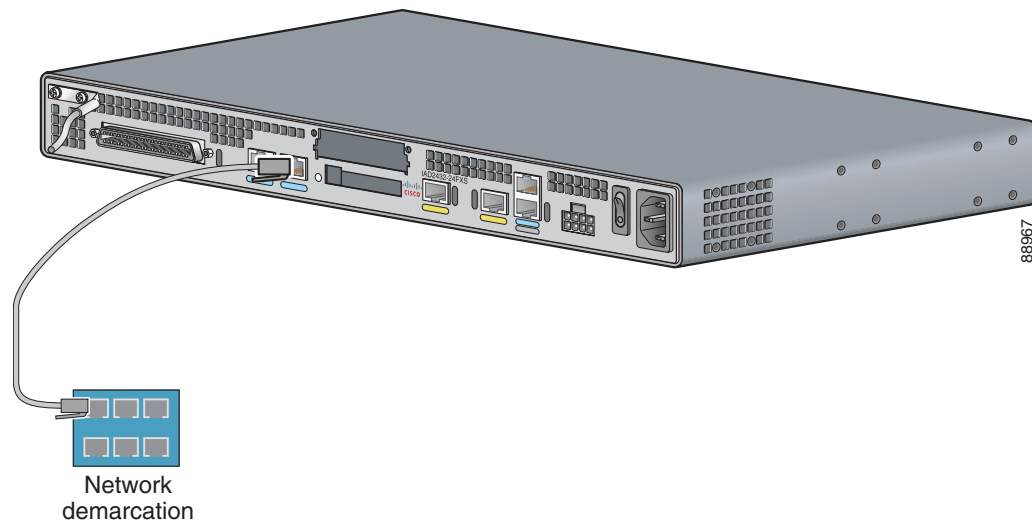
## Cable

Use an RJ-48 T1/E1 cable (not included).

## Procedure

- Step 1** Connect the RJ-48 T1/E1 cable to the T1-WAN port (marked T1-WAN on a light-green label).
- Step 2** Connect the RJ-48C/CA81A jack to the network demarcation device (telco demarcation or equivalent). (See [Figure 3-27](#).)

**Figure 3-27 T1/E1 Port to Network Connection**



## Connecting the Analog Voice Interface to a Distribution Panel

To connect the multiport analog voice interface to a distribution panel, which connects to telephones, faxes, or analog PBX equipment, use the procedure in this section.

## Cable

Use an RJ-21 cable with Amphenol 50-pin connectors (not included).

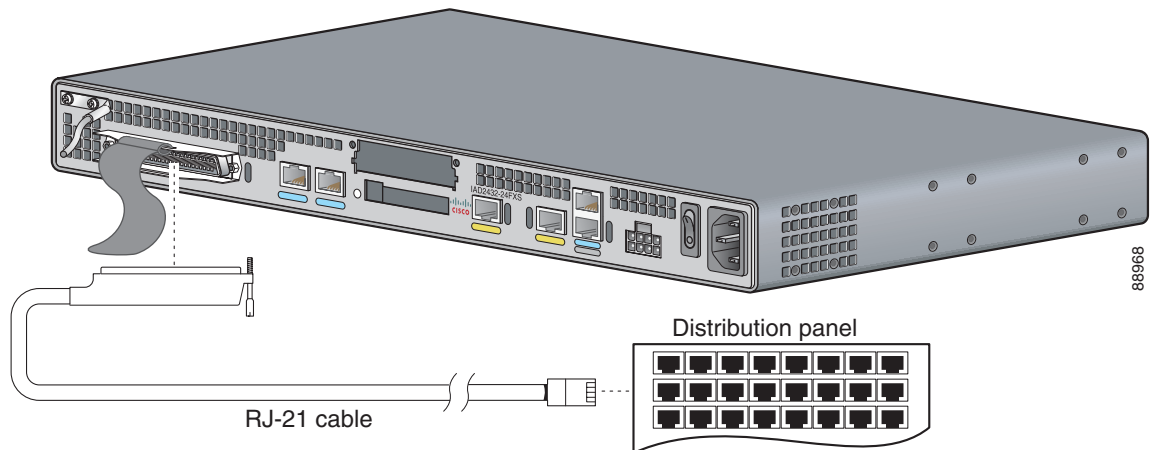
**Warning**

This equipment contains a ring signal generator (ringer), which is a source of hazardous voltage. Do not touch the RJ-11 (phone) port wires (conductors), the conductors of a cable connected to the RJ-11 port, or the associated circuit-board when the ringer is active. The ringer is activated by an incoming call. Statement 1042

**Procedure**

- Step 1** Connect the RJ-21 cable from the analog voice multiport to the distribution panel. See [Figure 3-28](#).

**Figure 3-28** Analog Voice Connection



- Step 2** Use the strap to secure the cable in place.

**Connecting the Digital Voice Port to a T1/E1-PBX**

To connect the digital voice port to a digital PBX, use the procedure in this section.

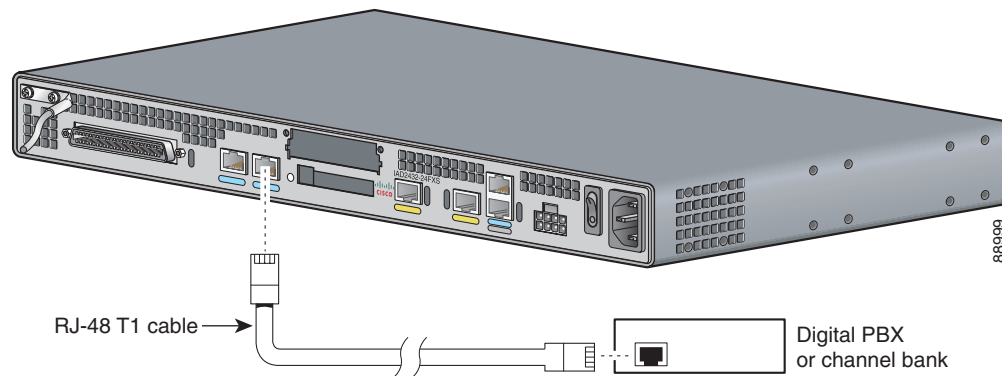
**Cable**

Use an RJ-48 T1/E1 cable (not included).

**Procedure**

- Step 1** Connect the RJ-48 T1/E1 cable to the T1/E1 port. See [Figure 3-29](#).

Figure 3-29 Digital Voice Connection



**Step 2** Connect the RJ-48 jack to the digital telephone equipment (PBX).

## Ports, Connectors, and Pinouts

Table 3-5 summarizes the cable connections between Cisco IADs and the network and user interfaces.

**Table 3-5** Cable Use Reference Table

Cisco IAD Port	Port Color	Connector/Cable	Interface To
Console	Light blue	RJ-45/rollover	PC
			ASCII terminal
Auxiliary	Black	RJ-45/rollover	Modem
Fast Ethernet	Yellow	RJ-45/Fast Ethernet	LAN
Serial 0	Blue	Cisco 12-in-1 serial cable	EIA/TIA-530
			EIA/TIA-530A
			EIA/TIA-232
			EIA/TIA-449
			V.35
			X.21
T1/E1-WAN	Light green	RJ-48/Straight-through	T1/E1 trunk
T1/E1-PBX digital voice	Black	RJ-48/Straight-through	Digital PBX, T1/E1
Analog voice multiport	Gray	RJ-21X/50-conductor	Distribution panel for analog telephone, fax, PBX, or central office line

## Remote Terminal Connections (If Applicable)

If you are configuring a Cisco IAD from a remote location, connect the modem and the remote PC or terminal to the telephone network as described in this section.

## Connecting to a Modem

To connect the local modem and the remote modem to live telephone outlets, use standard telephone cables.

## Connecting to a Remote PC

To link a Cisco IAD to a remote PC, follow these steps.

**Note**

---

The remote PC must be running terminal emulation software.

---

**Step 1** Connect the remote PC and modem.

**Step 2** Set the PC terminal emulation software requirements:

- 9600 baud
- 8 data bits
- 1 stop bit
- no parity
- no flow control

**Step 3** Key in and dial the telephone number of the Cisco IAD external modem.

---

## Connecting to a Remote ASCII Terminal

To link a Cisco IAD to a remote ASCII terminal, such as a VT100, follow these steps:

---

**Step 1** Connect the remote ASCII terminal and modem.

**Step 2** Set the terminal requirements:

- 9600 baud
- 8 data bits
- 1 stop bit
- no parity
- no flow control

**Step 3** Key in the telephone number of the Cisco IAD external modem, or, if you are using a Hayes-compatible modem, enter **ATDT** and the number to be dialed.

---

## Connecting Backup Power

Cisco IAD2430 series IADs can be installed with optional backup power. Backup power to a DC-powered IAD is provided by a battery backup system; see the “[Connecting a Backup Battery to a DC-Powered IAD](#)” section on page 3-33 section for connection instructions. Backup power to an AC-powered IAD is provided by an uninterruptible power supply (UPS); see the “[Connecting an Uninterruptible Power Supply UPS to an AC-Powered Cisco IAD2430 Series IAD](#)” section on page 3-34 for connection instructions.



### Note

UPS functionality is not available on the IAD2435 IAD.



### Caution

The Cisco IAD2430 series IAD chassis provides inputs for both AC and DC power. Design your installation to use only one type of power. *Do not use AC and DC power at the same time.* If you do, the unit stops operating, and you must reboot it with only a single power source.

See [Table 3-6](#) for the maximum power requirements for each Cisco IAD2430 IAD model.

**Table 3-6** Maximum Power Requirements

Cisco IAD2430 Model	Power Consumption (Watts)
IAD2431-8FX	50
IAD2431-16FXS	60
IAD2432-24FXS	70
IAD2431-1T1E1(no FXS analog ports)	35
IAD2430-24FXS (no TI/E1 or WIC slot)	60
IAD2435-8FXS (no WIC slot)	60

## Connecting a Backup Battery to a DC-Powered IAD

Connect a 12-volt backup battery to the DC input connector on your Cisco IAD2430 series router. Before you install a backup battery, be sure to read the installation instructions for the backup battery equipment.

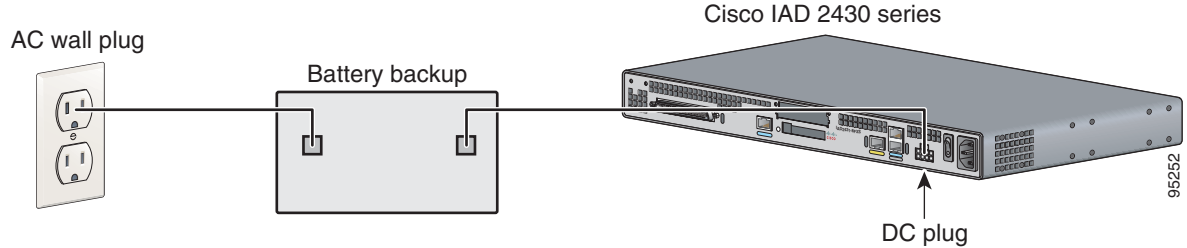
[Figure 3-30](#) shows a setup using an external backup battery.



### Note

[Figure 3-30](#) shows one possible setup; please review your backup battery documentation before you set up your system.

Figure 3-30 Connecting a Backup Battery to a DC-Powered Cisco IAD

**Caution**

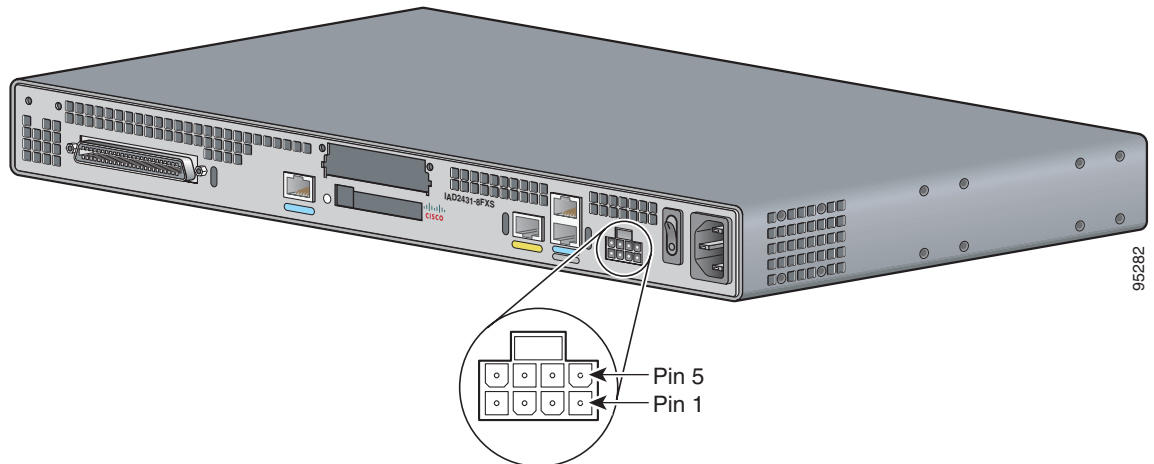
Use a backup battery only if you are *not* using AC to power your Cisco IAD2430 series IAD. *Do not use AC and DC power at the same time.* If you do, the unit stops operating, and you must reboot it with only a single power source

Figure 3-31 shows the DC power connector. See Table 3-7 for pinout information for the DC power connector on Cisco IAD2430 series IADs.

Table 3-7 Pinouts for DC Power Connector

Pin Number	Description	Pin Number	Description
1	GND (input enable)	5	ON_BAT (battery is on)
2	+12V (power)	6	+12V (power)
3	REP_BAT (replace battery)	7	LOW_BAT (battery is low)
4	GND (power return)	8	GND (power return)

Figure 3-31 DC Power Connector



## Connecting an Uninterruptible Power Supply UPS to an AC-Powered Cisco IAD2430 Series IAD

Connect an uninterruptible power supply (UPS) to the AC input on your Cisco IAD2430 series IAD. Before you install a UPS, be sure to read the installation instructions for the UPS.



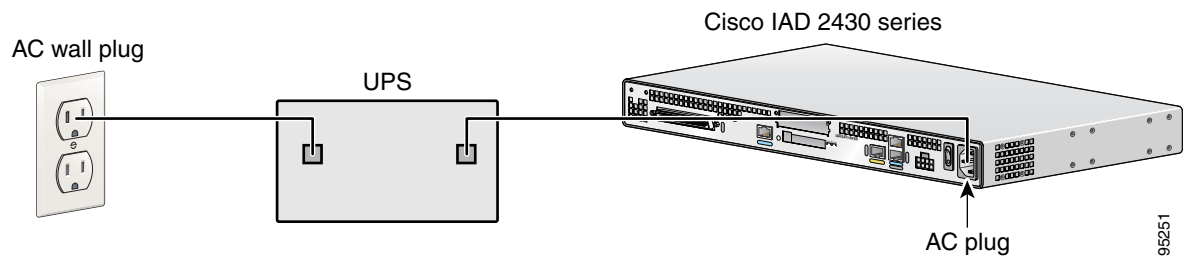
**Note** UPS functionality is not available on the Cisco IAD2435 IAD.

Figure 3-32 shows a setup using a UPS.



**Note** Figure 3-32 shows one possible setup; please review your UPS documentation before you set up your system.

**Figure 3-32** Connecting a UPS to an AC-Powered Cisco IAD









## CHAPTER 4

# Powering On Cisco IAD2430 Series IADs

---

To power on your Cisco IAD2430 series integrated access device (IAD), perform the following tasks in the order listed, as required:

- [Checklist for Power-On, page 4-1](#)
- [Power-On Procedure, page 4-1](#)
- [Initial Configuration Procedures, page 4-2](#)
- [Troubleshooting, page 4-9](#)

## Checklist for Power-On

You can power on a Cisco IAD if it meets the requirements described in [Chapter 3, “Installing Cisco IAD2430 Series IADs”](#):

- The chassis is securely mounted.
- The power cable is connected.
- The interface cables are connected.

## Power-On Procedure

Perform the following procedure to power on your Cisco IAD and verify that it completes its initialization and self-test. When this is finished, the Cisco IAD is ready to configure.

To power on the Cisco IAD, follow these steps::

- 
- Step 1** Power on your terminal or PC, and configure it for 9600 bps, 8 data bits, 1 stop bit, no parity, and no flow control.
- Step 2** Move the Cisco IAD power switch to the ON position (Cisco IAD2430 through Cisco IAD2432 IADs only).

The green LED beside the auxiliary (AUX) port should come on, and the fan should operate.



---

**Note** The Cisco IAD2435 IAD does not have a fan.

---

To power on the Cisco IAD2435 IAD, plug in the external power supply (see [Figure 3-19](#)).

The following message appears at the end of the boot-up messages:

```
--- System Configuration Dialog ---
Continue with configuration dialog? [yes/no]:
```

**Step 3** Enter **no** to proceed with manual configuration by using the command-line interface (CLI):

```
Would you like to enter the initial configuration dialog? [yes/no]: no
Would you like to terminate autoinstall? [yes]
```

**Step 4** Press **Return** to terminate autoinstall and continue with manual configuration.

Several messages appear, ending with lines similar to the following:

```
...
Copyright (c) 2008 by cisco Systems, Inc.
Compiled <date> <time> by <person>
```

**Step 5** Press **Return** to bring up the Router> prompt:

```
...
flashfs[4]: Initialization complete.
Router>
```

**Step 6** Enter privileged EXEC mode:

```
Router> enable
Router#
```

**Step 7** Continue with the, “[Initial Configuration Procedures](#)” section on page 4-2.



**Note**

If the `rommon 1>` prompt appears, your system has booted in ROM monitor mode. For information on the ROM monitor, see the router rebooting and ROM monitor information in the [Cisco IOS Configuration Fundamentals Configuration Guide](#) for your Cisco IOS software release.

## Initial Configuration Procedures

This section describes how to prepare the Cisco IAD2430 IAD series IAD to perform basic communication functions. You may initially configure your router by using the Cisco IOS command-line interface (CLI) or by using the setup command facility. To create the initial configuration, the setup command facility prompts you for basic information about your router and network.



**Note**

If you ordered your Cisco IAD2430 series IAD with the Simple Network-Enabled Auto-Provision (SNAP) option, no on-site configuration is required. If the Cisco IAD is connected to the WAN, the SNAP application downloads and installs the applicable files, and configures the Cisco IAD automatically. No additional configuration should be required. For additional information about SNAP, see the [Simple Network-Enabled Auto-Provisioning for Cisco 2420 Series IADs](#) feature module at the following URL:

<http://www.cisco.com/univercd/cc/td/doc/product/software/ios122/122newft/122t/122t8/ftapiad8.htm>

## Cisco IOS CLI

To configure the initial router settings using the Cisco IOS CLI, follow these steps:

- Step 1** Set up a console connection to your router. The following message is displayed:

```
...
router con0 is now available
```

- Step 2** Press **Return** or **Enter**. The following message is displayed:

```
Cisco Configuration Professional Express (Cisco CP Express) is installed on this device.
This feature requires the one-time use of the username "cisco"
with the password "cisco." The default username and password have a privilege level of 15.
```

```
Please change these publicly known initial credentials using Cisco CP Express or the Cisco
IOS CLI.
```

```
Here are the Cisco IOS commands.
```

```
username <myuser> privilege 15 secret 0 <mypassword>
no username cisco
```

```
Replace <myuser> and <mypassword> with the username and password you want to use.
```

```
For more information about Cisco CP please follow the instructions in the QUICK START
GUIDE for your router...
```

```
...
User Access Verification
Username:
```

- Step 3** Enter the username *cisco*, and press **Return** or **Enter**. The following prompt is displayed:

```
Password:
```

- Step 4** Enter the password *cisco*, and press **Return** or **Enter**. The following prompt is displayed:

```
Router#
```

A message is displayed that is similar to the first warning message. The message directs you to change the username and password.

You are now in privileged EXEC mode.



**Note** You must change the username and password before you log off the router. You cannot use the username *cisco* or password *cisco* after you log off from this session.

- Step 5** To change the username and password, enter the following at the prompt:

```
username username privilege 15 secret 0 password
```

*Username* and *password* are the username and password that you wish to use.



**Note** Use the **copy running-config startup-config** command at the privileged EXEC mode prompt (Router#) to save the configuration to NVRAM.

Verify the initial configuration. See the [“Verifying and Saving Your Configuration”](#) section on page 4-8.

## Setup Command Facility

The setup command facility guides you through the configuration process by prompting you for the specific information that is needed to configure your system. Use the setup command facility to configure a hostname for the router, to set passwords, and to configure an interface for communication with the management network.

To use the setup command facility, you will need to set up a console connection with the router and enter the privileged EXEC mode.

To configure the initial router settings by using the setup command facility, follow these steps:

---

**Step 1** Set up a console connection to your router, and enter privileged EXEC mode. For instructions on how to enter privileged EXEC mode see [Step 1](#) through [Step 4](#) in the “Cisco IOS CLI” section on page 4-3.

**Step 2** In privileged EXEC mode, at the prompt, enter **setup**.

```
yourname# setup
```

The following message is displayed:

```
--- System Configuration Dialog ---
```

```
Continue with configuration dialog? [yes/no]:
```

You are now in the setup command facility.

The prompts in the setup command facility vary, depending on your router model, on the installed interface modules, and on the software image. The following steps and the user entries (in bold) are shown as examples only.




---

**Note** If you make a mistake while using the setup command facility, you can exit and run the setup command facility again. Press **Ctrl-C**, and enter the **setup** command at the privileged EXEC mode prompt (Router#).

---

**Step 3** To proceed by using the setup command facility, enter **yes**:

```
Continue with configuration dialog? [yes/no]: yes
```

**Step 4** When the following messages appear, enter **yes** to enter basic management setup:

```
At any point you may enter a question mark '?' for help.
Use ctrl-c to abort configuration dialog at any prompt.
```

```
Default settings are in square brackets '[]'.
```

```
Basic management setup configures only enough connectivity
for management of the system, extended setup will ask you
to configure each interface on the system
```

```
Would you like to enter basic management setup? [yes/no]: yes
```

**Step 5** Enter a hostname for the router (this example uses Router):

```
Configuring global parameters:
Enter host name [Router]: Router
```

**Step 6** Enter an enable secret password. This password is encrypted (more secure) and cannot be seen when viewing the configuration.

```
The enable secret is a password used to protect access to
```

privileged EXEC and configuration modes. This password, after entered, becomes encrypted in the configuration.

Enter enable secret: **xxxxxxx**

- Step 7** Enter an enable password that is different from the enable secret password. This password is not encrypted (less secure) and can be seen when viewing the configuration.

The enable password is used when you do not specify an enable secret password, with some older software versions, and some boot images.

Enter enable password: **xxxxxxx**

- Step 8** Enter the virtual terminal password, which prevents unauthenticated access to the router through ports other than the console port:

The virtual terminal password is used to protect access to the router over a network interface.

Enter virtual terminal password: **xxxxxxx**

- Step 9** Respond to the following prompts as appropriate for your network:

```
Configure SNMP Network Management? [yes]:
Community string [public]:
```

A summary of the available interfaces is displayed.

- Step 10** Choose one of the available interfaces for connecting the router to the management network:

```
Enter interface name used to connect to the
management network from the above interface summary: fastethernet0/0
```

- Step 11** Respond to the following prompts as appropriate for your network:

```
Configuring interface FastEthernet0/0:
Use the 100 Base-TX (RJ-45) connector? [yes]: yes
Operate in full-duplex mode? [no]: yes
Configure IP on this interface? [yes]: yes
IP address for this interface: 172.1.2.3
Subnet mask for this interface [255.255.0.0] : 255.255.0.0
Class B network is 172.1.0.0, 26 subnet bits; mask is /16
```

The configuration is displayed:

The following configuration command script was created:

```
hostname Router
enable secret 5 $1$D5P6$PYx41/lQIASK.HcSbf05q1
enable password xxxxxx
line vty 0 4
password xxxxxx
snmp-server community public
!
no ip routing
!
interface FastEthernet0/0
no shutdown
speed 100
duplex auto
ip address 172.1.2.3 255.255.0.0
!
```

- Step 12** Respond to the following prompts. Enter **2** to save the initial configuration.

```
[0] Go to the IOS command prompt without saving this config.
[1] Return back to the setup without saving this config.
[2] Save this configuration to nvram and exit.
```

```

Enter your selection [2]: 2
Building configuration...
Use the enabled mode 'configure' command to modify this configuration.

Press RETURN to get started! RETURN

The user prompt is displayed.
Router>

```

- Step 13** Verify the initial configuration. See the “[Verifying and Saving Your Configuration](#)” section on page 4-8 for verification procedures.
- 

## Manual Configuration

To configure the Cisco IAD from a console (locally or remotely), see the *Cisco IAD2430 Series Software Configuration Guide* for the configuration instructions. To configure it remotely through Telnet, continue to the “[Setting the Fast Ethernet Port IP Address](#)” section on page 4-6 to set a Fast Ethernet (100BASE-T) port IP address.

For information about obtaining any referenced documentation, see the “[Obtaining Documentation and Submitting a Service Request](#)” section on page xvi.

This section shows how to prepare the Cisco IAD to perform basic communication functions through its 10/100BASE-T and WAN interfaces.

Perform the following initial configuration procedures, as applicable:

- [Obtaining Your Network Information](#), page 4-6
- [Setting the Fast Ethernet Port IP Address](#), page 4-6
- [Configuring a T1/E1 Port for a WAN Connection](#), page 4-7
- [Configuring Digital Voice](#), page 4-8
- [Verifying and Saving Your Configuration](#), page 4-8

## Obtaining Your Network Information

Gather the following information, as applicable, before you begin the configuration process:

- For 10/100BASE-T ports: IP address
- For T1/E1 ports: clock source, framing, line code, cable length

## Setting the Fast Ethernet Port IP Address

To configure the Cisco IAD remotely through a Fast Ethernet connection, connect the 10/100BASE-T port to a live Ethernet connection by using a standard Ethernet cable with RJ-45 connectors. Then complete this procedure to set the IP address for the port. After setting the address, you can configure the Cisco IAD remotely through a Telnet connection.

	Command	Purpose
Step 1	Router# <b>configure terminal</b>	Enters global configuration mode.
Step 2	Router(config)# <b>enable password</b> <i>password</i>	Sets a password for the privileged EXEC mode.
Step 3	Router(config)# <b>interface FastEthernet 0/0</b>	Enters interface configuration mode.
Step 4	Router(config-if)# <b>ip address</b> <i>IP-address subnet-mask</i>	Enters the IP address and subnet mask for the Fast Ethernet (10/100BASE-T) port.
Step 5	Router(config-if)# <b>no shutdown</b>	Activates the 10/100BASE-T port.
Step 6	Router(config-if)# <b>exit</b>	Returns to global configuration mode.
Step 7	Router(config)# <b>line vty 0 4</b>	Enters line configuration mode.
Step 8	Router(config-line)# <b>password</b> <i>password</i>	Sets a password for remote access to the Cisco IAD.
Step 9	Router(config-line)# <b>end</b>	Returns to privileged EXEC mode.
Step 10	Router# <b>copy system:running-config nvram:startup-config</b>	Saves the configuration.

## Configuring a T1/E1 Port for a WAN Connection

The T1/E1 port supports balanced T1/E1 according to ANSI T1.403 and has a built-in CSU/DSU.

To configure basic T1/E1 controller settings to support Point-to-Point Protocol (PPP), High-Level Data Link Control (HDLC), or Frame Relay (FR), follow these steps, beginning in global configuration mode:

	Command	Purpose
Step 1	Router(config)# <b>controller T1/E1 1/0</b>	Enters controller configuration mode by controller number. Slot and port numbers vary.
Step 2	Router(config-ctrl)# <b>clock source</b> { <b>internal</b>   <b>line</b>   <b>loop-timed</b> }	Configures the controller clock source for a DS1 link.  If the clock source is a network device attached to the T1/E1 port that you are configuring now, select the <b>line</b> option. For any other clock source (internal or a network device attached to any other port), select the <b>internal</b> option.
Step 3	Router(config-ctrl)# <b>description</b> <i>line</i>	Enters a description of the controller, such as the destination or its application. The description can be as many as 80 characters long.
Step 4	Router(config-ctrl)# <b>cablelength short</b> { <b>133</b>   <b>266</b>   <b>399</b>   <b>533</b>   <b>655</b> } or Router(config-ctrl)# <b>cablelength long</b> { <b>gain26</b>   <b>gain36</b> } { <b>-15db</b>   <b>-22.5db</b>   <b>-7.5db</b>   <b>0db</b> }	Configures the cable length if the length is 655 ft (200 m) or shorter.  or Configures the receive gain and transmit attenuation if the cable length is longer than 655 ft (200 m).
Step 5	Router(config-ctrl)# <b>framing</b> { <b>sf</b>   <b>esf</b> }	If necessary, changes the DS1 link framing format. The default is SuperFrame ( <b>sf</b> ).
Step 6	Router(config-ctrl)# <b>linecode</b> { <b>ami</b>   <b>b8zs</b> }	If necessary, changes the line encoding format for the DS1 link. The default is <b>ami</b> .

	Command	Purpose
Step 7	Router(config-ctrl)# <b>no shutdown</b>	Activates the T1/E1 controller.
Step 8	Router(config-ctrl)# <b>exit</b>	Exits controller configuration mode.
Step 9	Router(config)# <b>exit</b>	Exits configuration mode.
Step 10	Router# <b>show controller T1/E1 1/0</b>	Verifies the controller configuration. Slot and port numbers vary.

## Configuring Digital Voice

To configure basic T1/E1 controller settings to support PPP, High-Level Data Link Control (HDLC), or Frame Relay (FR), follow these steps, beginning in global configuration mode:

	Command	Purpose
Step 1	Router(config)# <b>controller T1/E1 1/0</b>	Enters controller configuration mode by controller number. Slot and port numbers vary.
Step 2	Router(config-ctrl)# <b>mode cas</b>	Configures channel-associated signaling.
Step 3	Router(config-ctrl-cas)# <b>framing esf</b>	Configures framing.
Step 4	Router(config-ctrl-cas)# <b>linecode b8zs</b>	Configures line encoding format.
Step 5	Router(config-ctrl-cas)# <b>framing {sf   esf}</b>	If necessary, changes the DS1 link framing format. The default is SuperFrame (sf).
Step 6	Router(config-ctrl-cas)# <b>ds0-group 1 timeslots 1-24 type e&amp;m-immediate-start</b>	Configures the DS0 group.
Step 7	Repeat Step 3 through Step 6 for each additional DS0 group.	Configures additional DS0 groups on the T1/E1 interface. You can configure as many as 24 DS0 groups on a T1/E1.
Step 8	Router(config-ctrl-cas)# <b>exit</b>	Exits controller configuration mode.
Step 9	Router(config-ctrl)# <b>no shutdown</b>	Activates the T1/E1 controller.
Step 10	Router(config-ctrl)# <b>exit</b>	Exits controller configuration mode.
Step 11	Router(config)# <b>exit</b>	Exits configuration mode.
Step 12	Router# <b>show controller T1/E1 1/0</b>	Verifies the controller configuration. Slot and port numbers vary.

For additional information about configuring specific features, see the following references:

- For PPP, HDLC, or FR, consult the online master index for the Cisco IOS release you are using.
- For loopback diagnostics, or for configuring controller channel groups, channel-associated signaling (CAS) voice groups, or time-division multiplexing (TDM) cross-connects, see the *Cisco IAD2430 Series Integrated Access Devices Software Configuration Guide*.

## Verifying and Saving Your Configuration

To verify the configuration and save it in NVRAM so that the configuration remains in effect if the Cisco IAD is restarted, enter the following commands:



	Command	Purpose
Step 1	Router# <code>show running-config</code>	Displays the current operating configuration, including any changes you have just made.
Step 2	Router# <code>show startup-config</code>	Displays the configuration currently stored in NVRAM.
Step 3	Router# <code>show controller T1/E1 1/0</code>	Displays the configuration of the T1/E1 network interface controller. Slot and port numbers may vary.
Step 4	Router# <code>copy running-config startup-config</code>	Writes the current running configuration to NVRAM, where it overwrites the startup configuration and becomes the new startup configuration.  <b>Note</b> If you reboot the Cisco IAD or turn off the power before you complete this step, you lose the configuration.

## Troubleshooting

This section describes possible mechanical problems and corrective actions.

If there appears to be a malfunction, first check all cables and connections. If these are in order, see [Table 4-1](#) for specific problems and solutions.

For problems with the configuration, see the *Cisco IAD2430 Series Software Configuration Guide* at the following URL:

[http://www.cisco.com/en/US/products/hw/gatecont/ps887/prod\\_technical\\_documentation.html](http://www.cisco.com/en/US/products/hw/gatecont/ps887/prod_technical_documentation.html)

**Table 4-1**      **Troubleshooting the Cisco IAD**

Symptom	Possible Cause	Corrective Action
Power LED and fan are off	Power source turned off	Turn on power source.
	Faulty power cable	Check/replace power cable.
	Faulty power source	Check/correct input power.
	Faulty internal power supply	Contact Cisco <sup>1</sup> or your Cisco reseller.
Power LED on; fan off	Faulty Cisco IAD	Contact Cisco <sup>1</sup> Technical Assistance Center or your Cisco reseller.
Power LED off; fan on	Faulty Cisco IAD	Contact Cisco <sup>1</sup> or your Cisco reseller.
No initialization response from Cisco IAD	Faulty modem console terminal	Check/replace modem/terminal.
	Faulty cabling to terminal	Check/replace cable.
	Faulty Cisco IAD	Contact Cisco <sup>1</sup> or your Cisco reseller.
Unit shuts off after operating for some time	Overheating	Check ventilation.
	Faulty Cisco IAD	Contact Cisco <sup>1</sup> or your Cisco reseller.
Console screen display freezes	Console fault	Reset/replace console.
	Software error	Repeat power-on procedure.
	Faulty Cisco IAD	Contact Cisco <sup>1</sup> or your Cisco reseller.

1. See the “[Obtaining Documentation and Submitting a Service Request](#)” section on page xvi.



## INDEX

---

### Numerics

- 19-Inch Rack Installation—Front Panel Forward [3-7](#)
- 19-Inch Rack Installation—Rear Panel Forward [3-7](#)

---

### A

- AC power requirements [2-3, 3-21](#)
- analog voice ports [3-29](#)
- ASCII terminal, connecting [3-32](#)
- auxiliary port [3-23](#)

---

### B

- backup battery [3-33, 3-34](#)
- brackets [3-6, 3-9, 3-10](#)

---

### C

- cable
  - distance limitations [2-4 to ??](#)
- cable use reference table [3-31](#)
- caution messages
  - exceeding EIA/TIA-449 distance limitations [2-5](#)
  - exceeding V.35 distance limitations [2-5](#)
  - for desk and table mounting [3-14](#)
- checklist, installation [3-4](#)
- Cisco IAD2430-24FXS Chassis [1-3](#)
- Cisco IAD2431-16FXS chassis [1-4, 1-5, 1-6](#)
- Cisco IAD2431-1T1E1 chassis [1-5](#)
- Cisco IAD2431-8FXS chassis [1-4](#)
- Cisco IAD2432-24FXS chassis [1-5, 1-6](#)
- Cisco IOS software [1-10](#)

- Cisco IOS software documentation [iii-xvi](#)
- clocking, external [3-28](#)
- computer, for configuration [3-5](#)
- configuration methods [1-10, 1-11](#)
  - [1-10](#)
- connecting ports [3-23, 3-27, 3-28, 3-30](#)
- console port
  - PC connection [3-22](#)
- console terminal [3-5](#)
- controls, descriptions of [1-6](#)
- cooling recommendations [2-2](#)
- crimping the ground lug onto the Ground wire [3-16](#)
- CSU/DSU [3-5, 3-29](#)

---

### D

- demarcation device [3-28](#)
- digital voice connection [3-31](#)
- digital voice-port connections [3-30](#)
- distance limitations for cables [2-4 to 2-6](#)
- documentation [iii-xvi](#)

---

### E

- EIA/TIA-232 [2-5](#)
- EIA/TIA-530 [2-5](#)
- electrical safety guidelines [3-2](#)
- electromagnetic interference
  - See EMI
- electrostatic discharge
  - See ESD
- EMI [2-4, 2-6](#)
- ESD [3-3](#)

**F**

- Fast Ethernet cables, distance limitations [2-4](#)
- Fast Ethernet hub [3-5](#)
- Fast Ethernet port, connecting [3-23](#)
- figures
  - 19-Inch Rack Installation—front panel forward [3-7](#)
  - 19-Inch Rack Installation—rear panel forward [3-7](#)
  - Analog Voice Connection [3-30](#)
  - Attaching the Chassis to the 19-Inch Rack—Rear Panel Forward [3-9](#)
  - Attaching the Wall-Mount Brackets [3-10](#)
  - Cisco IAD2430-24FXS Chassis [1-3](#)
  - Cisco IAD2431-16FXS Chassis [1-4, 1-5, 1-6](#)
  - Cisco IAD2431-1T1E1 Chassis [1-5](#)
  - Cisco IAD2431-8FXS Chassis [1-4](#)
  - Cisco IAD2432-24FXS Chassis [1-5, 1-6](#)
  - Crimping the Ground Lug onto the Ground Wire [3-16](#)
  - Digital Voice Connection [3-31](#)
  - Grounding Lug Fastened to Terminals [3-16](#)
  - Installation Checklist [3-4](#)
  - Serial Port Connection [3-28](#)
  - T1 Port to Network Connection [3-29](#)
  - T1 WAN Interface with Analog FXS and FXO User Interfaces [1-14](#)
  - T1 WAN Interface with Analog FXS User Interfaces [1-13, 1-14](#)
  - T1 WAN Interface with T1 Interface to PBX [1-14](#)
  - Telco 19-Inch Rack Installation—Rear Panel Forward [3-8](#)
  - Wall-Mounting the Chassis [3-11](#)

**G**

- ground loops, EMI effects of [2-6](#)

**I**

- installation
  - checklist [3-4](#)

- rack-mounting [3-6](#)
  - tools, parts, and equipment required [3-4](#)
- installation checklist [3-4](#)
- interface options [1-2](#)
- IOS
  - See Cisco IOS software

**L**

- lightning, EMI effects [2-6](#)
- log, record keeping [3-3](#)

**M**

- malfunctions, how to diagnose [4-9](#)
- modem [3-5](#)
- modem connections [3-32](#)
- mounting methods [2-1](#)

**O**

- operating system [1-10](#)

**P**

- packing list [3-5](#)
- PC connections [3-32](#)
- power connection, AC [3-21](#)
- power cord, description [2-2](#)
- power requirements [2-3, 3-21](#)
- power supply voltages [2-2](#)
- problems, diagnosing and correcting [4-9](#)

**R**

- rack mounting the chassis [3-8](#)
- racks [2-2, 3-9](#)
- radio-frequency interference

See EMI

record keeping [3-4](#)

[3-3](#)

related documentation [iii-xvi](#)

remote PC, connecting [3-32](#)

---

## S

safety [3-2, 3-3](#)

serial port connection [3-28](#)

serial ports [2-4, 3-27](#)

Simple Network-enabled Auto-Provision [1-10](#)

SNAP

See Simple Network-enabled Auto-Provision

software, terminal emulation [3-22](#)

software, Cisco IOS [1-10](#)

speed and distance limitations [2-5](#)

static electricity prevention [3-3](#)

synchronous serial port connections [3-27](#)

---

## T

T1/E1 digital voice port [3-30](#)

T1/E1 trunk port [3-28](#)

T1 port to network connection [3-29](#)

T1 WAN interface with analog FXS and FXO user interfaces [1-14](#)

T1 WAN interface with analog FXS user interfaces [1-13](#)

T1 WAN interface with analog FXS user interfaces (figure) [1-14](#)

T1 WAN port distance limitations [2-4](#)

tables

Cable Use Reference Table [3-31](#)

Digital Voice Port Speed and Distance Limitations [2-6](#)

EIA/TIA-232 Speed and Distance Limitations [2-4](#)

EIA/TIA-449, V.35, and X.21 Speed and Distance Limitations [2-5](#)

EIA/TIA-530 Speed and Distance Limitations [2-5](#)

T1 WAN Port Distance Limitations [2-4](#)

Troubleshooting the Cisco IAD [4-10](#)

Telco 19-Inch rack installation—rear panel forward [3-8](#)

telco rack [3-7](#)

Telnet [1-10](#)

terminal emulation software [3-22, 3-32](#)

tools required for installation [3-4](#)

troubleshooting the Cisco IAD [4-10](#)

---

## U

uninterruptible power supply [3-33, 3-34](#)

---

## V

V.35

distance limitations [2-5](#)

ventilation recommendations [2-2](#)

voltage selection, AC [2-2](#)

---

## W

wall-mounting the chassis [3-9, 3-11](#)

warnings

product disposal [1-3](#)

requirement to read installation instruction [2-3](#)

SELV-to-TNV connection hazard [3-28](#)

WAN port hazardous voltages [3-29](#)

working during lightning activity [3-18](#)

warnings, safety [iii-viii](#)

---

## X

X.21

distance limitations [2-5](#)

