

Cable & Harness Test Systems



Product Catalog

A detailed look at product specifications, solutions, and capabilities of Cirris.



Why Cirris?

At Cirris, we believe that a degree in electrical engineering (EE) shouldn't be required in order for someone to begin testing cables and harnesses. Cirris testers are easy to use for all levels of experience. If you prefer to simply plug in cables and push a button, Cirris has a tester for that. If you need to construct a complex test program for a massive harness containing dozens of connectors and thousands of wires, Cirris has a tester for that. Our range of testers, complete with software, adapters, and other accessories mean we have the tools for most testing conditions. Even if we don't have exactly what you need, we work with you to find the right solution.

Our customer service team can guide you through crucial testing decisions. Your dedicated Cirris Representative will help you choose the best tester for your needs. We may recommend a benchtop tester such as one of the 4200 Series or an Easy-Touch® Pro. For more complex assemblies, you may consider a Cirris Harness tester such as an 8100 or CH2. Your Cirris Representative will make sure you have all the necessary testing accessories such as expansion boxes, tilt stands, and adaptors.

If you need further assistance, Cirris Technical Support is standing by to ensure all your questions are answered. Our team of testing experts can walk you through just about any scenario you may encounter. We will listen to your problems and recommend solutions—be it modifying the test program or adjusting the test station setup. The customer service team at Cirris combined with our superior test instruments create an unbeatable testing experience.

Cirris has over 35 years designing and producing the highest quality testing tools. We listen to the needs of our customers and design equipment that accurately tests cables and harnesses and delivers a straightforward testing process.



How to Use this Product Catalog

This guide provides an in-depth, product-centered view of all testers and accessories Cirris has to offer. To make this guide as intuitive as possible, the information is presented in a sequential format.

- 1. Choose a Tester** - Selecting a tester may be based on the number of test points and the voltage needed. Many customers may already know the test specifications needed as they may be clearly defined. Select a tester that meets your specifications. If you are still unsure which tester is right for you, visit cirris.com or speak to one of our representatives.
- 2. Choose Interfacing** - We find the more difficult part of the purchasing process is choosing a way to connect to the device that you want to test to your tester. Not every cable is built with standard connectors that attach directly to the tester. Select products to connect or adapt the device you want to test to your tester.
- 3. Choose Software & Accessories** - Along with the necessary testers and adapters, you might consider extra equipment to include in your test station setup. Select software and accessories for your test process. Tilt stands, Smart-Lights®, and other accessories will help you manage your testing environment.

In order to make finding the right tools easier, we have included some brief materials in this book to educate you, as well as referenced more in-depth online resources that we encourage you to use as you get deeper into this book.



Table of Contents

Cirris In Your Assembly Process	1	Step 3: Choose Software & Accessories	36
Step 1: Choose A Tester	2	Easy-Wire® Software	37
Things To Consider When Choosing A Tester	3	CH2 Advanced Instructions	38
Product Comparison	4	Scripting	39
4200 Cable Tester	6	Cirris Server Software	40
4250 High Voltage Cable Tester	7	Cirris Hub	40
Easy-Touch® Pro High Voltage Cable Tester	12	Accessories	41
8100 Harness Tester	16	Additional Information	42
CH2 High Voltage Harness Tester	20	Contact Us	43
Step 2: Choose Interfacing	26		
Options For Your Interface Cables	27		
Option 1: Build Your Own Interface Cables	28		
Cirris Adapter System	28		
Off-the-Shelf Items From Cirris	31		
Transition Options	32		
Smart-Lights®	33		
Option 2: Custom Interfaces	34		

A few definitions

Cable Tester

The automated equipment that verifies the quality of the Device Under Test. Sometimes also called analyzer, electrical tester, harness tester, continuity tester or hipot tester depending of the capabilities of the unit.

Device Under Test (DUT)

The cable, harness or electrical assembly (product) being tested.



As shown in graphic.

Test Points

The positions in the connectors on the front of the tester that provide access to the unit's measurement functions. Typically, every termination in the DUT is connected to a separate test point. Each continuity test requires two test points – a From point and a To point.

Interface Cables

The assemblies that connect, or adapt, the tester to the DUT. Sometimes also called test cables, test fixtures or cable interface.



As shown in graphic.

Connectors

The devices that connect interface cables to the tester and to the DUT. Mating pairs include one male (plug) and one female (receptacle). Sometimes more narrowly described as product mating or tester mating connectors.



As shown in graphic.

Cable or Harness?

While we make a distinction between the two, there is no clear dividing line between cables and harnesses.

Generally cables have fewer wires than harnesses, and are less complex than harnesses. Cables may also include passive components like resistors, capacitors and diodes but harnesses may also include devices, such as relays, that require extended testing capabilities.

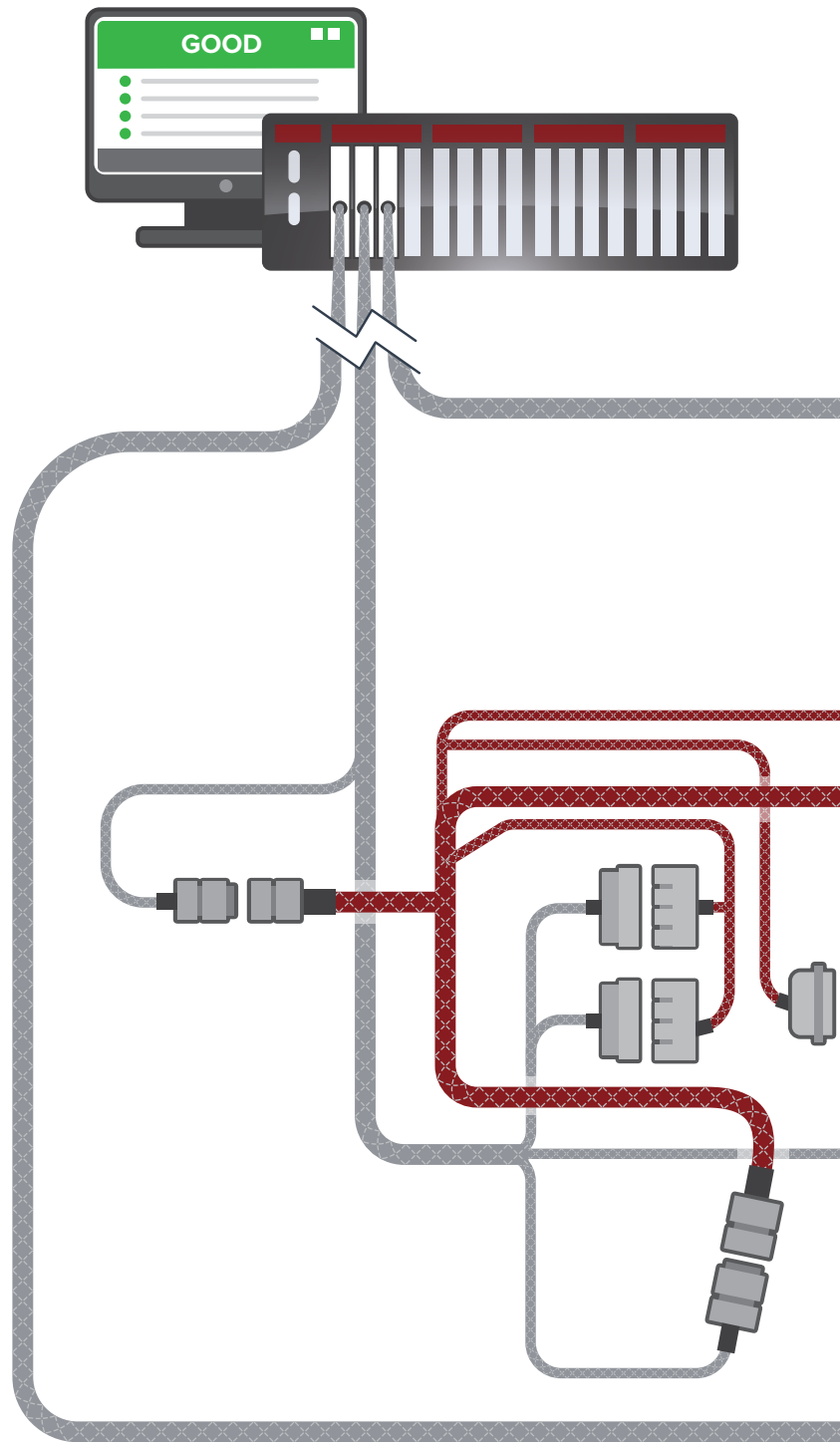

Cirris in Your Assembly Process

Testing should not be the final step in the assembly process. Moving testing upstream into the manufacturing process saves time, reduces waste and rework, and improves quality.

Cirris has tools to ensure you wire every connector in your assembly correctly. We identify errors and help you correct them immediately. Our testers will then guide you and ensure the rest of your assembly is wired correctly with no errors. After you have at least two completed connectors, you can test for continuity, shorts, and opens while continuing to finish the rest of the assembly.

Once the final assembly is complete, some users perform a final test on the device using high voltage to ensure the quality and reliability of the electrical properties of the assembly.

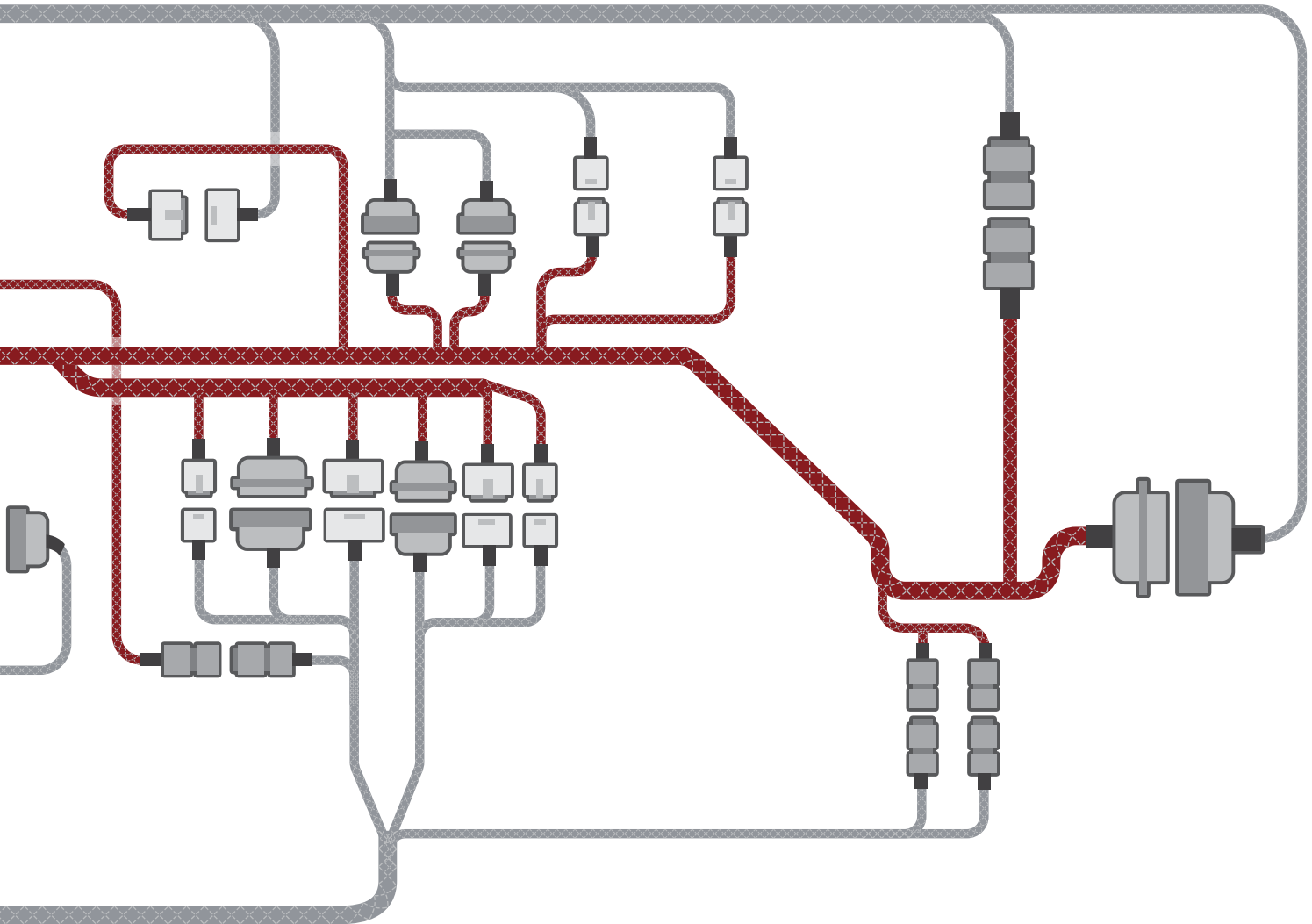



Step 1 Choose a Tester

Things to consider when choosing a tester.

Choosing a tester can appear confusing at first, but answers to the questions below will drive the decision-making process and help narrow the choices to the best fit. More information on all these topics can be found at cirris.com.

- How many test points does the application require? Cable testers can expand up to 1024 test points while harness testers can provide many thousands.
- Is high voltage testing required? If so, is there a specification that requires a set test voltage?
- Does a high mix of products and their relative simplicity make the interchangeable adapters and the ease of set up provided by cable testers a primary benefit?
- Does the lower price and their smaller form factor make it possible to locate multiple cable testers throughout the factory instead of relying solely on a single, centralized harness tester?
- Would the manufacturing process benefit from test-while-you-build, guided assembly instructions and graphics?
- Are data retention, reporting and test program revision tracking valuable capabilities in your business or are they required in the industries you serve?
- Does the DUT include switches, relays or other devices that add complexity to the testing process?

Cirris testers are categorized into two types.



4200 Cable Tester

Cable Testers

Cable testers, also called benchtop systems or small point count systems, are fast and easy to use. Their self-contained design means they do not need to be operated by an independent PC. Cirris benchtop cable testers scan the device you are testing faster than most other systems on the market. Cable testers can test up to 1024 test points and most Cirris models can apply high voltages up to 2000 VDC / 1000 VAC.



8100 Harness Tester with expansion units

Harness Testers

Harness testers, or large point count systems, provide maximum operator control, historical tracking and reporting capabilities, and can expand to tens of thousands of points. The tester's points can be distributed around the device you want to test. This flexibility means harness testers can be mounted into standard equipment racks or rolling cart system. These systems can have higher voltages, power external devices, and integrate third party meters and instruments. A Windows PC with Cirris Easy-Wire® Software is required to run these testers.

Product Comparison

Key features of our cable and harness testers. Detailed product overviews can be found on the following pages and online at cirris.com.



	4200	4250
Number of Test Points	128 to 1,024	128 to 1,024
Max Points Per Net	Unlimited	100
Low Voltage Measurement		
Continuity, Resistance	Yes	Yes
Max Low Voltage	4 V	4 V
Low Voltage Insulation Resistance (IR)	0.1 Ω to 5 M Ω	0.1 Ω to 5 M Ω
Passive Components (Resistors, Capacitors, Diodes)	Yes	Yes
Active Components (Relays, Lights)	No	No
4-wire Kelvin	Yes	Yes
Twisted Pair	No	Yes
High Voltage Measurement		
Dielectric Withstand (DW) Voltage	NA	1500 VDC 2000 VDC*/ 1000 VAC*
Dielectric Withstand Current	NA	0.1 mA to 1.5 mA
Insulation Resistance (IR)	NA	5 M Ω to 1000 M Ω
Interface	7" Touch Screen	7" Touch Screen
Communications		
Fieldbus - PLC Communication	Optional [‡]	Optional [‡]
Digital I/O	4 In, 6 Out	4 In, 6 Out
Serial & USB	Yes	Yes
Label & Report Printing	Yes	Yes
Cable interface Options		
Cirris Adapter System	Yes	Yes
Smart-Lights [®]	No	No
Software		
User Interface	Cirris OS	Cirris OS
Easy-Wire [®]	Optional	Optional
Scripting	Yes*	Yes*
Network Communications	Ethernet, WiFi	Ethernet, WiFi
Connector Graphics & Guide LEDs	No	No
CE Certified	Yes	Yes

* Optional

** Through PC Connection

Harness Testers



Easy-Touch® Pro

8100

CH2

128 to 1,024	256 - 100,000	160 - 100,000
512	Unlimited	Unlimited
Yes	Yes	Yes
4 V	6 V .25 V to 6 V*	2.5 V 0.25 V to 10 V*
0.1 Ω to 5 MΩ	0.1 Ω to 3 MΩ	0.1 Ω to 1 MΩ
Yes	Yes	Yes
No	No	Yes*
Yes	Yes	Yes
Yes	No	Yes
1500 VDC 2000 VDC*/ 1000 VAC*	NA	1500 VDC / 1070 VAC
0.1 mA to 1.5 mA	NA	10 μA to 2.5 mA
5 MΩ to 1000 MΩ	NA	5 MΩ to 1000 MΩ
10.4" Touch Screen	PC	PC
Optional‡	Optional‡	Optional‡
4 In, 6 Out*	20 In/Out, 8 Out*	10 In, 10 Out*
Yes**	Yes**	Yes**
Yes	Yes	Yes
Yes	No	No
No	Yes	Yes
Easy-Wire	Easy-Wire	Easy-Wire
Standard	Standard	Standard
Yes*	Yes*	Yes*
Ethernet	PC-based	PC-based
No	Yes	Yes
Yes	Yes	Yes

‡ EtherNet/IP EtherCAT PROFIBUS PROFINET Modbus



test points standalone

4200 Cable Tester

Designed for ease-of-use, the Cirris® 4200 benchtop cable tester makes low voltage testing quick and easy. Compatible with the Cirris Adapter System, test hundreds of cables of all variety. The 4200 easily integrates into your operations and ensures your cables are free of opens, shorts, miswires, and other errors. The 4200 is a go-to tester when throughput and efficiency are of the utmost importance.

Product Features

- **Thorough Testing** – Test for continuity, isolation, opens, and miswires. Analyze components such as resistors, diodes, capacitors, and perform 4-wire Kelvin resistance measurements.
- **Expandable** – Up to 1024 points in 128-point increments.
- **Fast Testing** – Innovative technology and efficient algorithms reduce time spent on testing.
- **Easy to Learn** – No advanced skills or training necessary to begin testing.
- **Compact** – Small, lightweight, and self-contained for easy mobility around the production floor.
- **Built-in Networking** – Easily share test programs and printers among multiple units.
- **Test Program Customization** – Customize test setup, labels, and reports.
- **Multiple Language Options** – Interface translated into several languages to avoid mistakes caused by language barriers. (More languages to come.)
- **Transition from 1100** – Use test programs and reports already set up for the 1100R+ on the 4200.
- **Durable** – Test thousands of cables without fear of equipment failure.
- **Optional PC Control** – Connect to a PC and expand capability with Cirris Easy-Wire® Software.
- **Printing** – Local and network printing capabilities for printing reports. Zebra printer attaches to integrated serial port on tester for printing labels.
- **Error Location** – Detects error location (which end) for shorts.
- **Digital I/O** – Automate your test process with lights, switches, and safety devices.
- **Cirris Adapter System** – Compatible with Cirris interchangeable test adapters that provide inexpensive interchangeable cable interface.
- **Optional Features** – Also compatible with Easy-Wire/PC-control, scripting, and data collection.
- **Full-color Touch Screen** – View instructions and test results on 7" display.

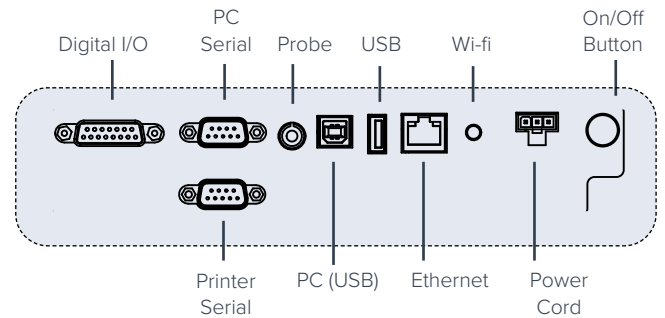
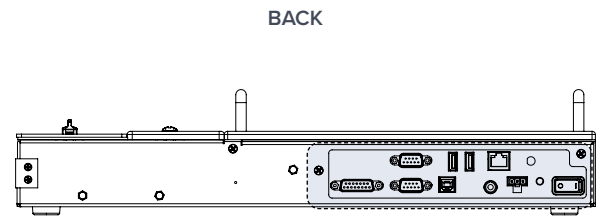
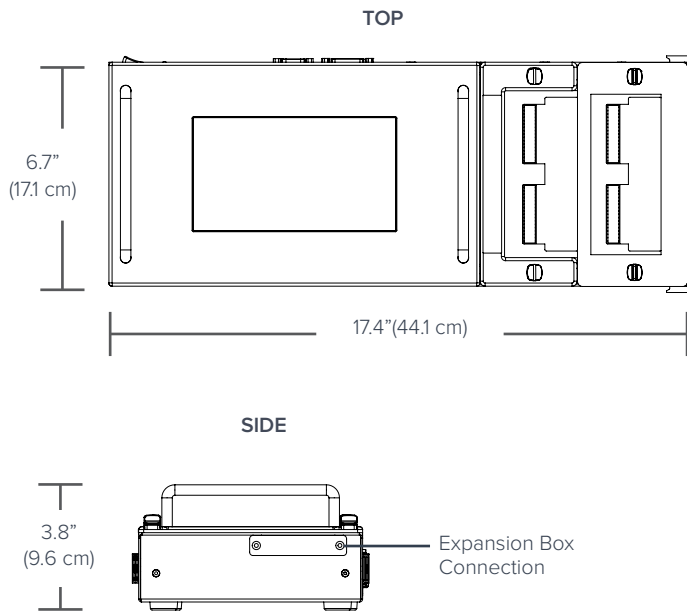

4200 Specifications

Test Points

128 points; expandable to 1024 points in 128-point increments

Low Voltage Test

■ 2 Wire

Voltage: 4 V max

Current: 3 μ A to 6 mA

Resistance: 0.1 Ω to 100 k Ω \pm 1% \pm 0.1 Ω , 100 k Ω to 5 M Ω \pm 10%

■ 4 Wire

Voltage: 4 V max

Current: 1 mA to 1 A

Resistance: 0.005 Ω to 10 Ω \pm 2% \pm 0.005 Ω

Component Tests

Diodes: Silicon, LEDs, zeners with breakdown > 4 V

Resistors: 0.1 Ω to 100 k Ω \pm 1% \pm 0.1 Ω , 100 k Ω to 5 M Ω \pm 10%

Capacitors: 5 nF to 100 μ F \pm 10% \pm 0.02 nF

Max Points Per Net

Unlimited

Digital Input/Output

4 Inputs* / 6 Outputs, 24 V Open collector, +10 V and +5 V each current limited to 100 mA

*2 of the inputs available via scripting or Easy-Wire software.

Test Point Interface

Cirris Adapter System

User Interface

Display: 7" color graphic display with capacitive touch screen (800 X 480 pixel resolution).

Localization: English, German, Spanish with ability to translate to other languages as needed.

Memory: Internal memory for test program storage (8GB or more).

File transfer: Transfer test programs either by connecting directly to a PC or using a USB flash drive.

Printing: Local label printing via serial ports. Network printing via optional Cirris Hub™ software.

Optional PC control: Additional advanced features via Easy-Wire® software.

Power

115 / 230V 50/60 Hz

Size

Main Unit: 17.4" x 6.7" x 3.8" (44.1 cm x 17.1 cm x 9.6 cm)

Add-on Box: 6.3" x 6.7" x 2.5" (15.9 cm x 17.1 cm x 6.4 cm)

Weight

Main Unit: 7.1 lb (3.3 kg)

Add-on Box: 2.3 lb (1.1 kg)



4250 High Voltage Cable Tester



test points



high voltage*



standalone

You want a benchtop cable tester that can do it all – look for wiring errors, test components, check for continuity, and analyze insulation resistance. The Cirris® 4250 high voltage cable tester will meet all your production needs. The full-color capacitive touch screen with an intuitive interface was designed with security and ease of use in mind. The latest tester from Cirris will complete your cable testing process.

Product Features

- **High Voltage** – Test with voltages of up to 2000 VDC or 1000 VAC (1500 VDC standard).
- **Thorough Testing** – Test for continuity, isolation, opens, and miswires. Analyze components such as resistors, diodes, capacitors, and perform Kelvin 4-wire resistance measurements.
- **Expandable** – Up to 1024 points in 128-point increments.
- **Fast Testing** – Innovative technology and efficient algorithms reduce time spent on testing.
- **Easy to Learn** – No advanced skills or training necessary to begin testing.
- **Compact** – Small, lightweight, and self-contained for easy mobility around the production floor.
- **Built-in Networking** – Easily share test programs and printers among multiple units.
- **Test Program Customization** – Customize test setup, labels, and reports.
- **Multiple Language Options** – Interface translated into several languages to avoid mistakes caused by language barriers. (More languages to come.)
- **Transition from 1100** – Use test programs and reports already set up for the 1100H+ on the 4250.
- **Durable** – Test thousands of cables without fear of equipment failure.
- **Optional PC Control** – Connect to a PC and expand capability with Cirris Easy-Wire® Software.
- **Printing** – Local and network printing capabilities for printing reports. Zebra printer attaches to integrated serial port on tester for printing labels.
- **Error Location** – Detects error location (which end) for opens and shorts.
- **Digital I/O** – Automate your test process with lights, switches, and safety devices.
- **Cirris Adapter System** – Compatible with Cirris interchangeable test adapters that provide inexpensive interchangeable .
- **Optional Features** – Also compatible with Easy-Wire/PC-control, scripting, and data collection.
- **Full-color touch screen** – View instructions and test results on 7” display

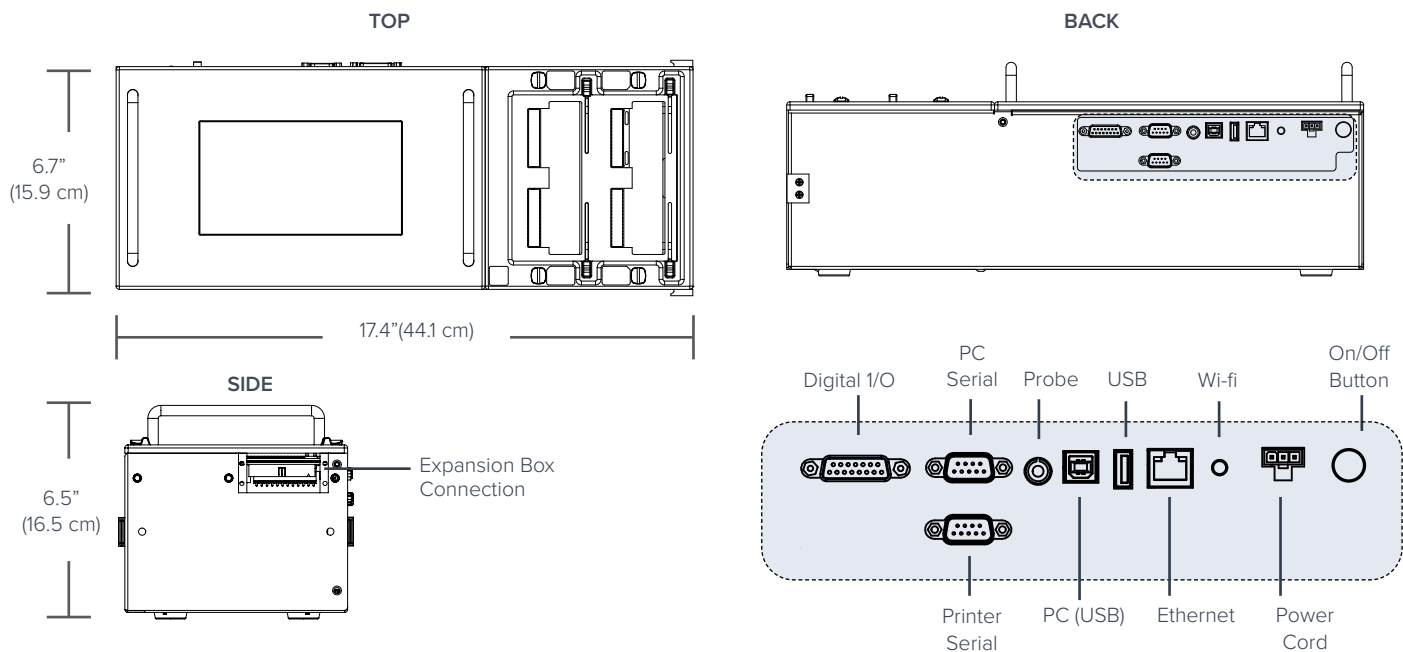

4250 Specifications

Test Points

128 points; expandable to 1024 points in 128-point increments (64 point configuration available)

Low Voltage Test

■ 2 Wire

Voltage: 4 V max

Current: 3 μ A to 6 mA

Resistance: 0.1 Ω to 100 k Ω \pm 1% \pm 0.1 Ω , 100 k Ω to 5 M Ω \pm 10%

■ 4 Wire

Voltage: 4 V max

Current: 1 mA to 1 A

Resistance: 0.001 Ω to 10 Ω \pm 2% \pm 0.001 Ω

Component Tests

Diodes: Silicon, LEDs, zeners with breakdown > 4 V

Resistors: 0.1 Ω to 100 k Ω \pm 1% \pm 0.1 Ω , 100 k Ω to 5 M Ω \pm 10%

Capacitors: 5 nF to 100 μ F \pm 10% \pm 0.02 nF

Twisted Pairs: Verify proper pairing in twisted pair cables

High Voltage Test

■ Insulation Resistance Test

Voltage: 100 to 1500 VDC \pm 5% (2000 VDC optional), 50 to 100 VDC \pm 5V

Resistance: 5 M Ω to 1000 M Ω \pm 10%

■ Dielectric Withstand Test

Voltage: 100 to 1500 VDC \pm 5% (2000 VDC optional), 50 to 1000 VAC optional), 50 to 100 VDC \pm 5V

Current Limit: 0.1 mA to 1.5 mA

Max Capacitance Per Net: 150 nF @ 300 VDC, 90 nF @ 500 VDC, 45 nF @ 1000 VDC, 30 nF @ 1500 VDC, 9.5 nF @ 1000 VAC

HV Energy Limit: 35 mJ

HV Charge Limit: 45 μ C

Max Points Per Net

100

Digital Input/Output

4 Inputs* / 6 Outputs, 24 V Open collector, +10 V and +5 V each current limited to 100 mA

*2 of the inputs available via scripting or Easy-Wire software

Test Point Interface

Cirris Adapter System

User Interface

Display: 7" color graphic display with capacitive touch screen (800 X 480 pixel resolution).

Localization: English, German, Spanish with ability to translate to other languages as needed.

Memory: Internal memory for test program storage (8GB or more).

File transfer: Transfer test programs either by connecting directly to a PC or using a USB flash drive.

Printing: Local label printing via serial ports. Network printing via optional Cirris Hub™ software.

Optional PC control: Additional advanced features via Easy-Wire® software.

Power

105 -135 V, 60 Hz, 210 -260 V, 50 Hz

Size

Main Unit: 17.4" x 6.7" x 6.5" (44.1 cm x 17.1 cm x 16.5 cm)

Add-on Box: 6.3" x 6.7" x 5.3" (15.9 cm x 17.1 cm 13.3 cm)

Weight

Main Unit: 11.4 lb (5.2 kg)

Add-on Box: 5 lb (2.3 kg)

4200 Part Numbers

Part Number	Description
C4200-LV	4200 Tester with 128 points
C4200-ELV	4200 128-point Expansion Scanner

4200 Options

SPC-4200-CIR	Data Collection for 4200
SPT-4200-CIR	Scripting option for 4200
PCC-4200-CIR	PC-Control Option for 4200
PCHK-42	Performance Check Kit for 4200

4250 Part Numbers

C4250-1500	4250 1500VDC Tester with 128 points
C4250-1564	4250 1500VDC Tester with 64 points
C4250-2000	4250 2000VDC Tester with 128 points
C4250-E15	4250 1500VDC 128-point Expansion Scanner
C4250-E20	4250 2000VDC 128-point Expansion Scanner
CBL-1024	Internal cable required for 4250 with 1024 pts

4250 Options

AC1K-4250-CIR	AC Option for 4250 (1000VAC)
SPC-4250-CIR	Data Collection Option for 4250
SCPT-4250-CIR	Scripting Option for 4250
PCC-4250-CIR	PC-Control Option for 4250
PCHK-42	4250 Performance Check Kit

Getting the most out of your 4200 Series Cable Tester

- Cirris 4200 Series testers utilize Cirris interchangeable adapters, which allows users to select their preferred interface connectors for each application. Learn about the Cirris Adapter System and see a list of popular adapters on page 30.
- Learn how to add more test points to your cable tester using expansion scanners on page 24.

Cirris offers additional accessories that help improve ergonomics, organization, and testing efficiency.



4200 Cable Tester



4200 expansion scanner



4250 High Voltage Cable Tester



4250 expansion scanner

Common Accessories



PRNT-KIT

Label printer starter kit. Includes Zebra GC420t label printer, serial cable, ribbon, and one roll 3"x1" of labels.



BCS-LASER

Laser bar code scanner. Load test programs, scan lot IDs, and capture serial numbers.



SER2-USB
Smart serial to USB cable for local printer.

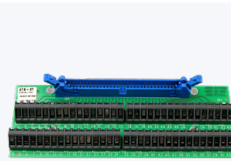

ETB-ST
Screw terminal transition boards transition from ribbon cable to more robust cable interface wire.



ATLT-AJ
Adjustable tilt stand for Easy-Touch Pro and 4200 Series testers.

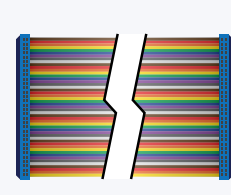

AC42-64
Ribbon cables are high quality cables for your test setup in lengths of 2-8 feet and 64 positions.



HHED-64
HHED-64 adapter for Cirris cable testers. More adapter-types are available.

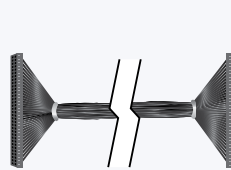

AD00-64
Discrete Cable has a 64 position crimp discrete connector for 22-26 AWG wire.

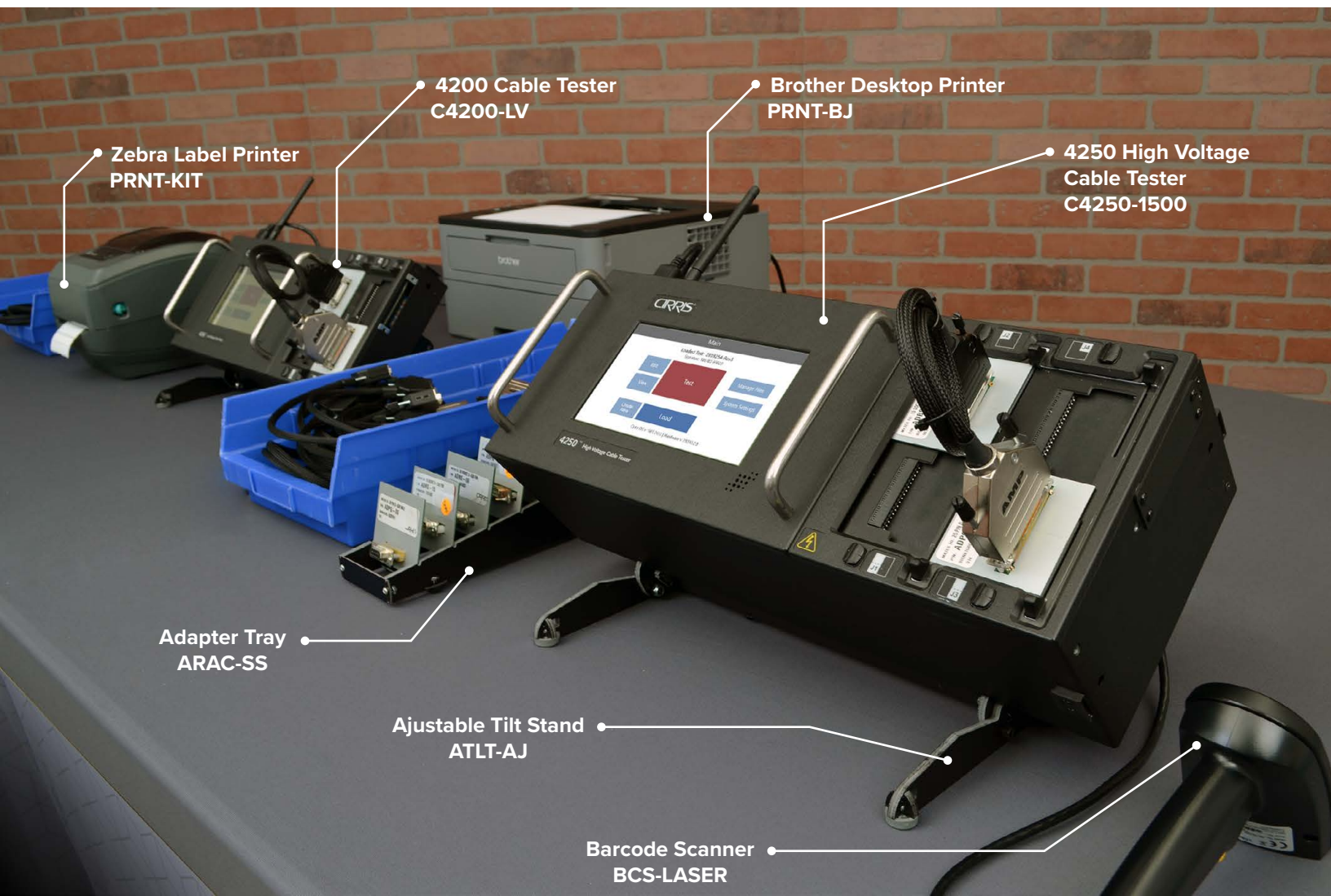

Zebra Label Printer PRNT-KIT

4200 Cable Tester C4200-LV

Brother Desktop Printer PRNT-BJ

4250 High Voltage Cable Tester C4250-1500

Adapter Tray ARAC-SS

Ajustable Tilt Stand ATLT-AJ

Barcode Scanner BCS-LASER



test points high voltage

1024 PT



standalone pc control

Easy-Touch[®] Pro High Voltage Cable Tester

The Easy-Touch Pro is a powerful standalone high voltage cable tester. The all-in-one unit contains a built-in Windows[®] PC running Cirris Easy-Wire[®] Software, the most powerful cable testing software on the market today.

The Easy-Touch Pro can easily integrate into your manufacturing environment for consistent and accurate testing of thousands of cables. The tester's mix of functionality and flexibility will meet your production needs.

Product Features

- **Thorough Testing** – Test for continuity, isolation, resistors, diodes (with programmable forward & reverse pass/fail voltage thresholds), capacitors, split twisted pairs, and perform 4-wire resistance measurements.
- **High Voltage** – Perform high voltage dielectric withstand (DW) and insulation resistance (IR) testing up to 2000 VDC or 1000 VAC (1500 VDC standard).
- **Error Location** – Detects error location (which end) for opens and shorts.
- **Expandable for Large Assemblies** – Test up to 1024 test points (128 points per scanner box).
- **Built in PC** – Integrated Windows 10 PC and 10.4" full-color, capacitive touch-screen display.
- **Windows Networking** – Share test programs, printers, and files through connecting to a windows network.
- **Powerful Reporting** – Test reports can be customized to include information such as low voltage measured values and high voltage IR measurements. Reports can be automatically exported and printed.
- **Self-contained** – Independent system able to move around the production floor to different test stations.
- **Straightforward Organization** – Serial numbers and lot numbers can be captured and stored with test results.
- **Store Results** – Test results are stored in a database and can be searched and viewed from within the Easy-Wire. Search for results using variables such as test date, test program name, test station name, serial number, and lot number.
- **Optional Server Software** – Cirris Server Software allows multiple testers to connect to a single networked database. Load programs and save results on a network.
- **Cirris Adapter System** – Compatible with Cirris interchangeable test adapters that provide inexpensive interchangeable interfacing.
- **Optional Features** – Options include AC DW testing, scripting, digital I/O and server software.

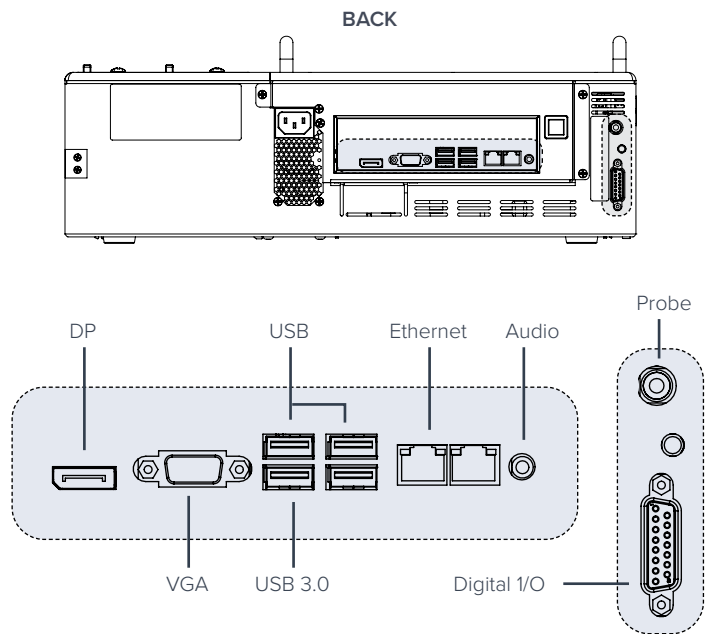
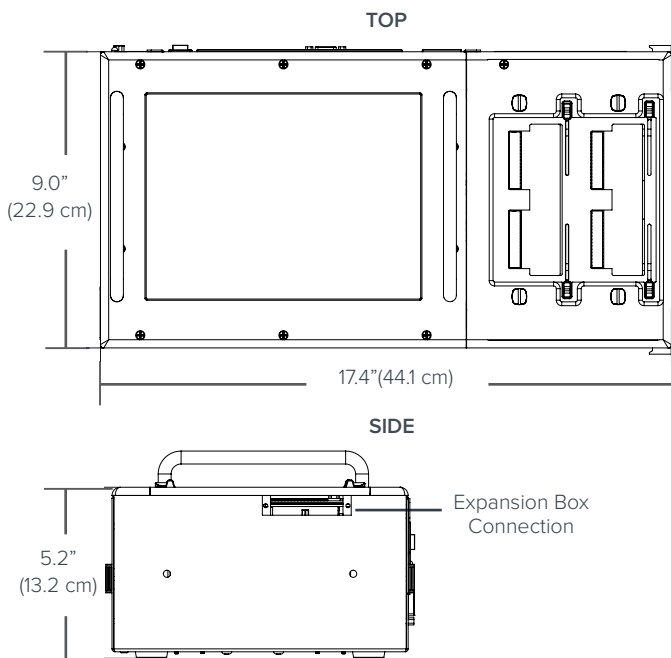

Easy-Touch Pro Specifications

Test Points

128 points; expandable to 1,024 points in 128-point increments (64 point configuration available)

Low Voltage Test

■ 2 Wire

Voltage: 4 V max

Current: 3 μ A to 6 mA

Resistance: 0.1 Ω to 100 k Ω \pm 1% \pm 0.1 Ω , 100 k Ω to 5 M Ω \pm 10%

■ 4 Wire

Voltage: 4 V max

Current: 1 mA to 1 A

Resistance: 0.001 Ω to 10 Ω \pm 2% \pm 0.001 Ω

Component Tests

Diodes: Silicon, LEDs, zeners with breakdown > 4 V

Resistors: 0.1 Ω to 100 k Ω \pm 1% \pm 0.1 Ω , 100 k Ω to 5 M Ω \pm 10%

Capacitors: 5 nF to 100 μ F \pm 10% \pm 0.02 nF

Twisted Pairs: Verify proper pairing in twisted pair cables

High Voltage Test

■ Insulation Resistance Test

Voltage: 100 to 1500 VDC \pm 5% (2000 VDC optional), 50 to 100 VDC \pm 5V

Resistance: 5 M Ω to 1000 M Ω \pm 10%

■ Dielectric Withstand Test

DC Voltage: 100 to 1500 VDC \pm 5% (2000 VDC optional), 50 to 100 VDC \pm 5V

AC Voltage (optional): 100 to 1000 VAC \pm 5%, 50 to 100 VAC \pm 5V

Current Limit: 0.1 mA to 1.5 mA \pm 5%

Max Capacitance Per Net: 150 nF @ 300 VDC, 90 nF @ 500 VDC, 45 nF @ 1000 VDC, 30 nF @ 1500 VDC, 9.5 nF @ 1000 VAC

HV Energy Limit: 35 mJ

HV Charge Limit: 45 μ C

Max Points Per Net

512

Digital Input/Output

4 Inputs / 6 Outputs, 24 V Open collector, +10 V and +5 V each current limited to 100 mA

Test Point Interface

Cirris Adapter System

User Interface

Built-in PC with Windows 10[®]

Display: 10.4" Full-Color Graphic Touch Screen display

Power

115 / 230 V 50/60 Hz

Size

Main unit: 17.4" x 9.0" x 5.2" (44.1 cm x 22.9 cm x 13.2 cm)

Add-on box: 6.3" x 9.0" x 5.2" (15.9 cm x 22.9 cm x 13.2 cm)

Weight

Main unit: 18 lbs (8.2 kg)

Add-on box: 6.5 lbs (2.9kg)

Part Numbers

Part Number	Description
C150-ETP	Easy-Touch Pro 1500VDC Tester with 128 points
C1ETP-64	Easy-Touch Pro 1500VDC Tester with 64 points
C200-ETP	Easy-Touch Pro 2000VDC Tester with 128 points
C2ETP-64	Easy-Touch Pro 2000VDC Tester with 64 points
C150-ETPA	Easy-Touch Pro 1500VDC 128-pt Expansion Scanner
C200-ETPA	Easy-Touch Pro 2000VDC 128-pt Expansion Scanner
CBL-1024	Internal cable required for Easy-Touch with 1024 pts

Easy-Touch Pro Options

AC1K-ET-CIR	AC Option for Easy-Touch (1000VAC)
SCPT-ET-CIR	Scripting Option for Easy-Touch
SIO-EW-CIR	Digital I/O and Windows Messaging for Easy-Wire
LAN-ET	Server Software for Easy-Touch (up to 5 testers)
PCHK-3	Easy-Touch Performance Check Kit



C15L-ETP Easy Touch Pro Low Voltage System with 128 points



C15L-ETPA Easy-Touch Pro Low Voltage 128-pt Expansion Scanner

Getting the most out of your Easy-Touch Pro Cable Tester

- The Easy-Touch Pro utilizes Cirris interchangeable adapters, which allows users to select their preferred interface connectors for each application. Learn about the Cirris adapter system and see a list of popular adapters on page 30.
- Learn how to add more test points to your cable tester using expansion scanners on page 24.
- Cirris offers additional accessories that help improve ergonomics, organization, and testing efficiency.

Common Accessories



ATLT-AJ

Adjustable tilt stand for Easy-Touch Pro and 4200 Series testers.

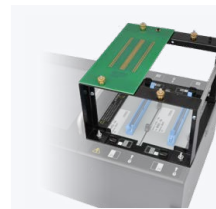

ACIR-1+

Frame mount for securing non-standard connectors to the cable tester.



BCS-LASER

Laser bar code scanner. Load test programs, scan lot IDs, and capture serial numbers.

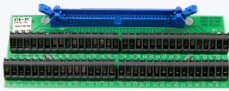

ETB-ST

Screw terminal transition boards transition from ribbon cable to more robust cable interface wire.



ATLT-AJ

Adjustable tilt stand for Easy-Touch Pro and 4200 Series testers.



AC42-64

Ribbon cables are high quality cables for your test setup in lengths of 2-8 feet and 64 positions.



HHED-64

HHED-64 adapter for Cirris cable testers. More adapter-types are available.



AD20-64

Discrete Cable has a 64 position crimp discrete connector for 22-26 AWG wire.

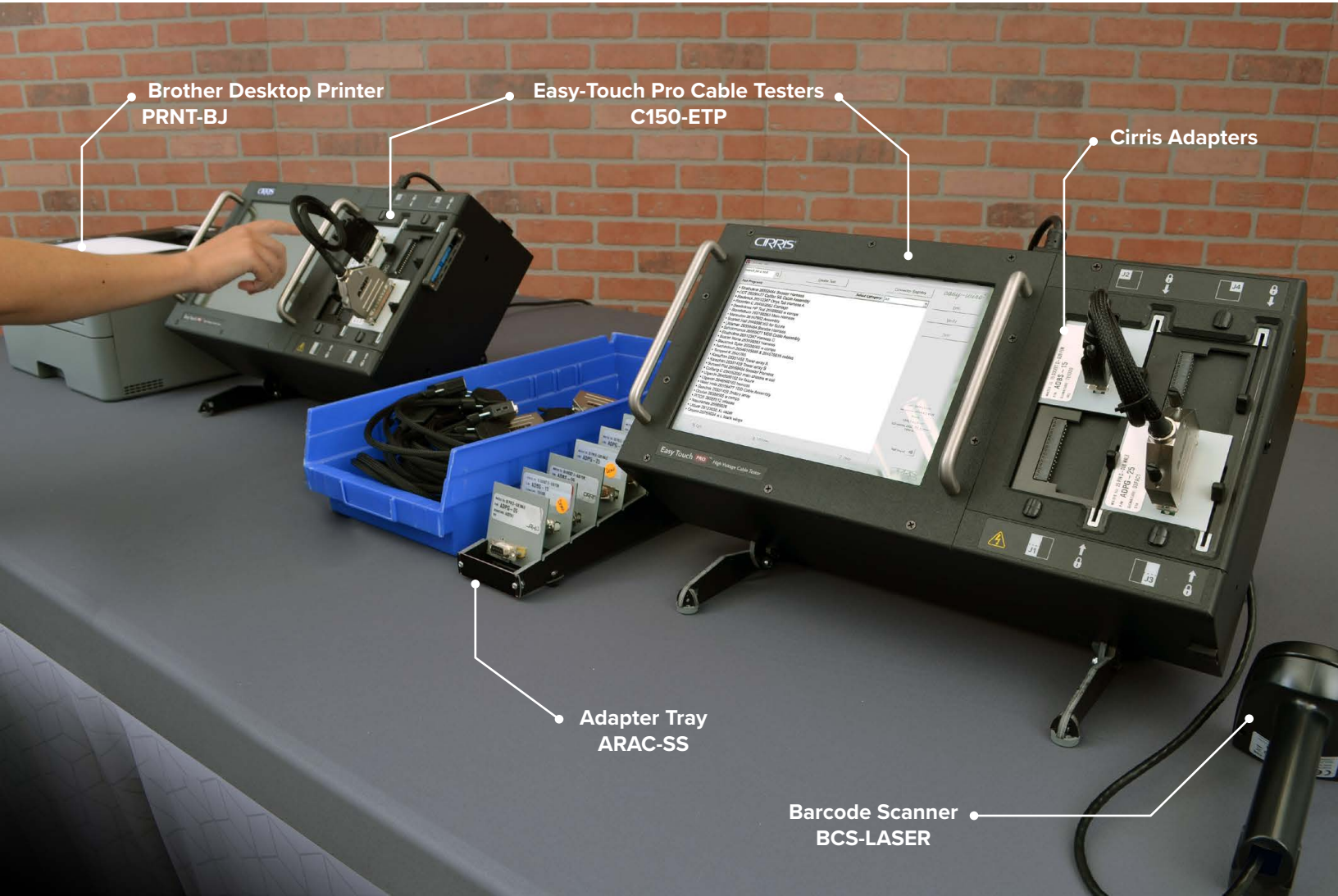



8100 Harness Tester



100K
PT

test
points



pc
control



guided
assembly

The 8100 is the next generation of Cirris low voltage harness tester. The tester is driven by the powerful, Easy-Wire® software, which provides maximum test flexibility. The test system allows operators to view connector images with target pin locations during the assembly process or rework. The 8100 has a robust design to meet the rigors of the production environment. Its compact size means it is non-intrusive at the workstation, can be mounted on the back of a harness board, or can be distributed with other 8100 units around the device to be tested.

Product Features

- **Expandable** – Scale from 256 to 100,000 test points.
- **CR Compatible** – Use legacy CR test programs, and use most 8100 test programs on CR test systems.
- **Smart or Traditional Interfacing** – Use with either Cirris Smart-Lights® or traditional interfacing.
- **Easy-Wire® Software** – Powerful software provides efficient test set-up and retrieval, operator access based on login, flexible test operation and reporting, and a test record archive.
- **Operator Guidance** – Graphic representations and operator prompts simplifies the build process and troubleshooting.
- **Passive Components** – Flexibly test assemblies with passive components such as resistors, diodes, capacitors.
- **Sensitive Measurements** – Use Cirris Advance Instructions to make custom electrical measurements.
- **Windows PC Based** – Provides easy integration with bar code scanners, local and shared printers. Optionally, accommodates a PC network so multiple testers can use the same test programs, connector definitions, user login, and report formats.
- **Portability Option** – Power for base unit is sourced from PC/USB connection allowing for mobility using laptop battery power if needed.
- **Durable** – With new rugged design, the 8100 withstands the rigors of the production environment.
- **Every Base an Expansion** – Base units can be used individually or flexibly combined to make a larger system. An expansion unit can be upgraded to a base unit.
- **4-Wire Kelvin** – When needed, make higher accuracy resistance measurements.
- **Digital I/O** – This option allows easy integration with external controls and equipment.

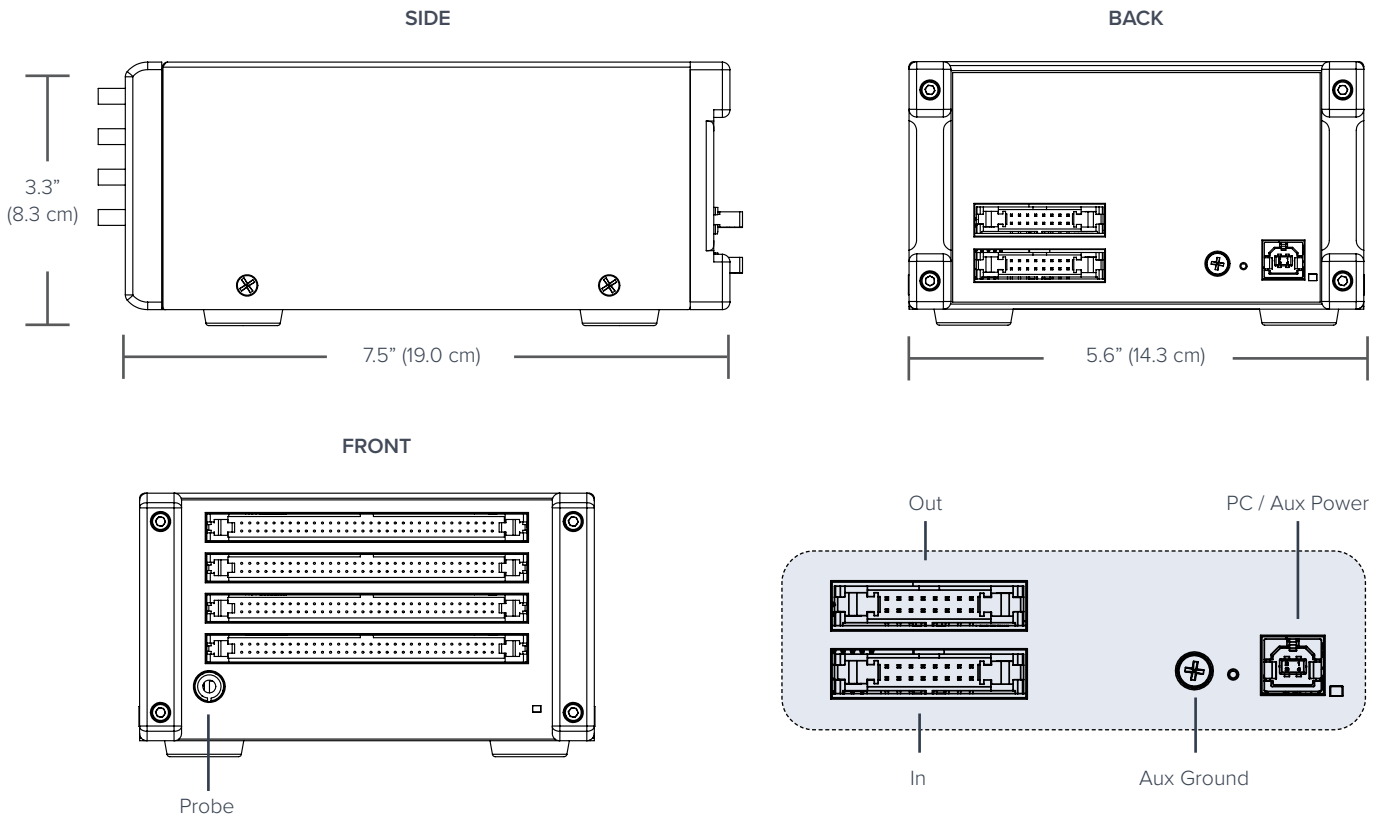

8100 Specifications

Test Points

Up to 256 test points per base or expansion unit. Expandable up to 100,000 max test points. Expansion units may be distributed up to 200" (60 m) from base

Low Voltage Test

■ 2 Wire

Voltage: 6 VDC max

Current: 0.1 μ A to 10 mA

Wire Resistance: 0.1 Ω to 100 Ω \pm 2% \pm 0.1 Ω

Insulation Resistance Max: 3 M Ω \pm 2% \pm 0.1 Ω

■ 4 Wire

Voltage: 6 VDC max

Current: 0.1 μ A to 10 mA

Wire Resistance: .005 Ω to 100 Ω \pm 2% \pm 0.005 Ω

Component Tests

Diodes: 0 to 6 VDC

Resistors: 0.1 Ω to 3 M Ω \pm 2% \pm 0.1 Ω

Capacitors: 100 pF to 1000 μ F \pm 10% \pm 50 pF

Digital Input/Output (Optional)

8 outputs and 20 inputs/outputs; IO card requires one test-point card position, leaving 192 tester points.

Test Point Interface

64 pos. shrouded .1" latching male header

User Interface

■ PC Requirements

Test Station Minimum Requirements: Windows® 10 Pro or Windows® 11 Pro, 2.0 GHz processor speed, 15 GB hard drive space, 4 GB RAM, 256 MB video memory, 1024 x 768 display resolution, sound, USB 2.0 or 3.0 port.

Optional Network Database Server Requirements: Same as "Test Station", however, no sound or USB ports required. Windows 10 Pro®, Windows 11 Pro®, Windows Server 2012®, Windows Server 2016®, Windows Server 2019®.

Power

Powered from PC USB connection; Large systems may require auxiliary power from USB hub or wall transformer.

Size

3.3" H x 5.6" W x 7.5" L (8.3 cm x 14.3 cm x 7.5 cm)

Weight

3.2 lbs (1.5 kg)

Part Numbers

Part Number	Description
CC81-BU	8100 Base Unit with Easy-Wire Software (256 points)
CC81-EX	8100 Expansion Unit (256 points)

8100 Options

SCPT-EW-CUS	Scripting Option for Easy-Wire CR
PCHK-81	8100 Performance Check Kit

8100 Base Unit
256 test points



8100 Expansion Unit
256 additional
test points

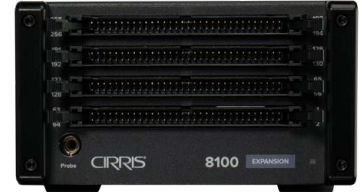

Getting the most out of your 8100 Harness Tester

- Connect your device-under-test to the 8100 with interface cables. You can create interface cables on your own with parts provided by Cirris, or we can custom build interfacing for you. Learn more on page 28.
- Learn how expansion units add more test points to your harness tester on page 24.
- Cirris offers additional accessories to improve your testing experience.

Common Accessories

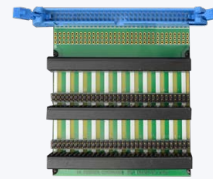

ETB-HS

Header strip transition board allows you to plug in quick-setup Smart-Light interface cables without wasting test points.



EHS-CL

Header strip mating connector clip easily connect to header strip transition boards.



ETB-ST

Screw terminal transition boards transition from ribbon cable to more robust cable interface wire.



ETB-SLT

Screwless terminal transition boards transition from ribbon cable to more robust cable interface wire.

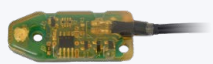

SMRT-05

Smart-Lights attach to an interface connector which can be plugged into any test point and instantly recognized by the tester.



AD20-64

Discrete Cable has a 64 position crimp discrete connector for 22-26 AWG wire.

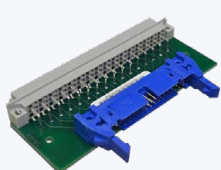

ACR-CH2

8100 to CH2 converter converts the 8100 interface to a CH2 interface when used with a ribbon Y-Cable.



PRNT-KIT

Label printer starter kit. Includes Zebra GC420t label printer, serial cable, ribbon, and one roll 3"x1" of labels.



AC42-64

Ribbon cables are high quality cables for your test setup in lengths of 2-8 feet and 64 positions.



BCS-LASER

Laser bar code scanner. Load test programs, scan lot IDs, and capture serial numbers.

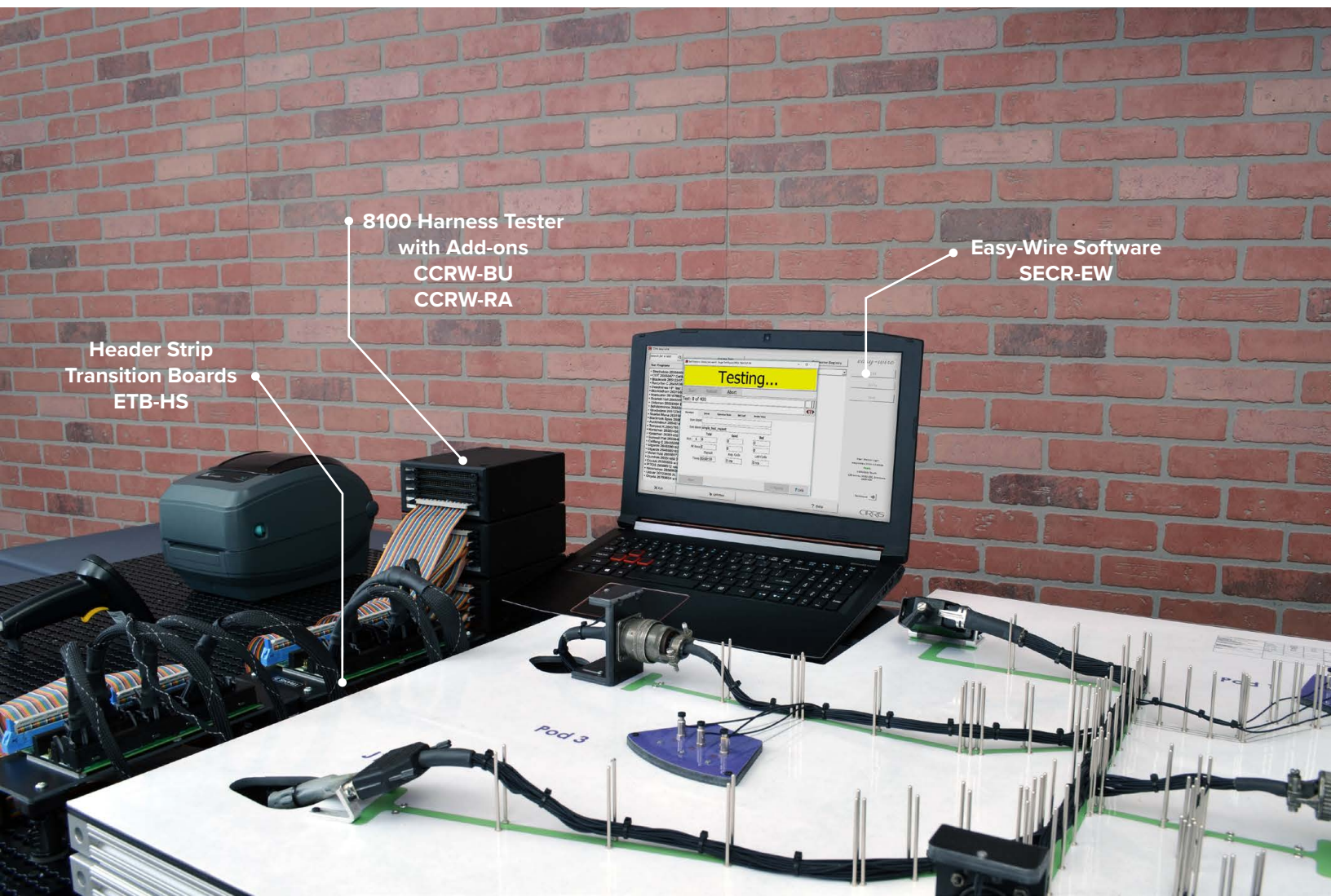

Header Strip
Transition Boards
ETB-HS

8100 Harness Tester
with Add-ons
CCRW-BU
CCRW-RA

Easy-Wire Software
SECR-EW

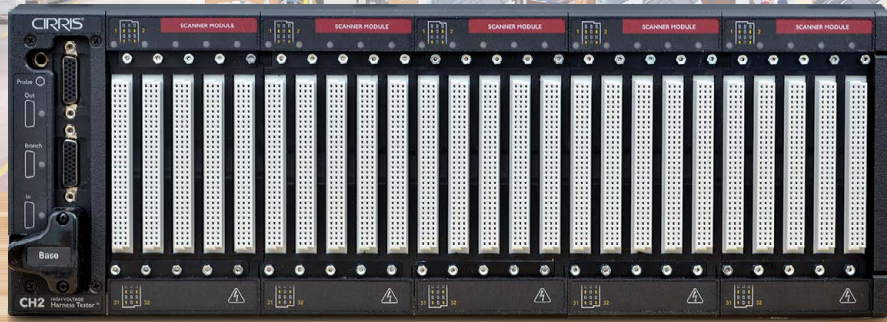

CH2 High Voltage Harness Tester

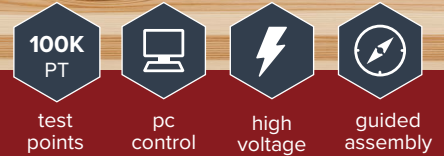

As test standards become more stringent, particularly in the realm of high voltage testing, you are tasked with ensuring the functionality and quality of increasingly complex assemblies. The CH2 is a versatile harness tester that offers the highest levels of test control. Its compact and capable design sets it apart from the competition in the marketplace. This capable tester can integrate with auxiliary test equipment, or with the Cirris Energization box for testing active components such as relays and sensors.

Product Features

- **Capable Hipot Testing** – Up to 1500 VDC and 1070 VAC.
- **Expandable for Large Assemblies** – Up to 100,000 points in 160-point increments.
- **Compact** – High test point density in an industry leading light and small package.
- **Low Voltage Test** – Automatic fast low voltage pretest finds errors before high voltage testing.
- **Passive Components** – Test resistors, capacitors, diodes, and switches.
- **Active Components** – Integrates with the Cirris CH2 Energization Box to test relays, sensors, and other active components.
- **4-Wire Kelvin** – Supports highly accurate 4-wire Kelvin resistance measurements.
- **Advanced Measurements** – Supports sensitive measurements with advanced measurement controls and the integration of external precision meters.
- **Operator Friendly** – On-screen connector images, cable interface LEDs, and audible prompts guide operators and alert them of errors.
- **Flexible Test Setup** – Supports both traditional cable interface and modular Cirris Smart-Lights® cable interface for quick test setup.
- **Effective Reporting** – Test reports can be readily customized for organization and understanding.
- **Test Records** – Access and print previous test results from a test archive.
- **Secure** – Restrict software access based on operator logins.
- **Digital I/O Option** – Integrate fixture clamps, sensors, and more with built-in I/O.
- **Network Capable** – Share test programs, test records, and fixture information throughout your plant. Print to network printers.
- **PC Based** – Provides Easy-Wire software control. Supports barcode scanners and Windows local and network printers as needed.
- **Test Standards** – Meets the requirements of the following test standards: IPC/WHMA-A-620, MIL-STD-202G, MIL-HDBK-83575, MIL-STD-1344A(5), and MIL-C-45224D.

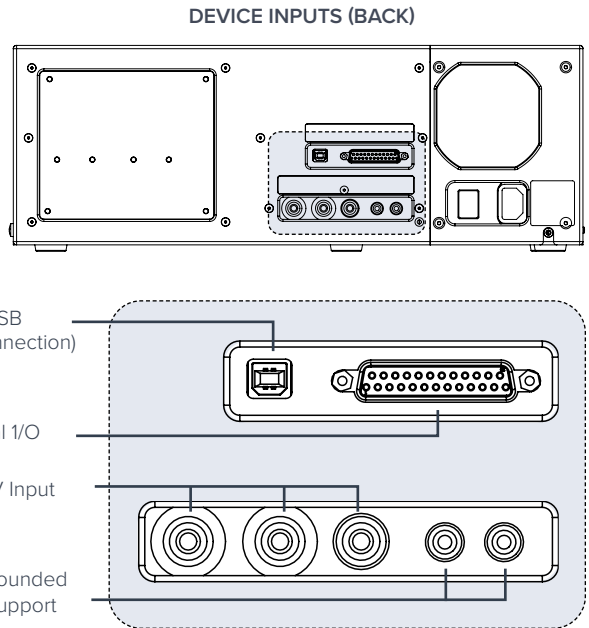
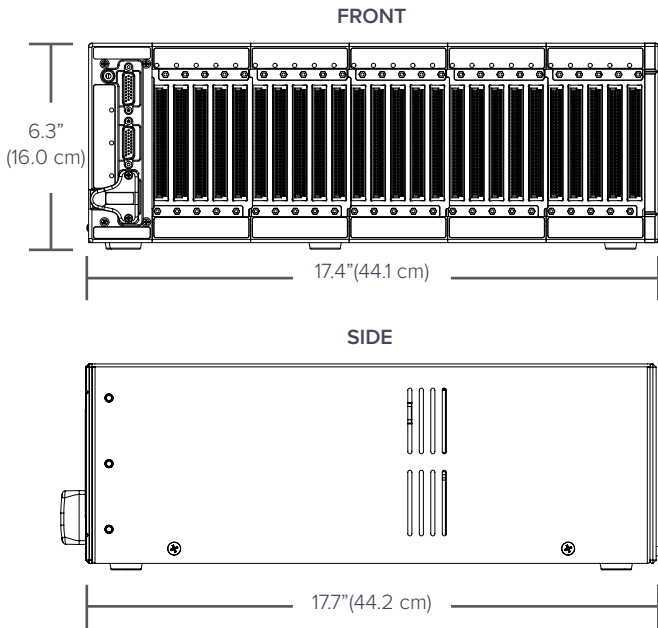

CH2 Specifications

Test Points

160 to 800 points; expandable to 100,000 points in 160-point increments. (Max distance from base unit: 200 ft.)

Low Voltage Test

■ 2 Wire

Voltage: Standard 2.5 V max, Optional 100 mV to 10 V

Current: 1 μ A, 10 μ A, 100 μ A, 1 mA, 10 mA \pm 2%

Resistance: 0.1 Ω to 1M Ω \pm 2% \pm 0.1 Ω

■ 4 Wire

Voltage: Standard 2.5 V max

Current: 2 μ A, 20 μ A, 200 μ A, 2 mA, 20 mA, 200 mA, 2 A \pm 2%

Resistance: 0.001 Ω to 100 Ω \pm 2% \pm 0.001 Ω

Components Test

Diodes: 0 to 2.5 V

Resistors: 0.1 Ω to 1M Ω \pm 2%

Capacitors: 10 pF to 5000 μ F \pm 10% \pm 50 pF

Twisted Pairs: Verify proper pairing in twisted pair cables

High Voltage Test

■ Insulation Resistance Test

Voltage: 100 to 1500 VDC \pm 5%, 10 to 100 VDC \pm 5V

Resistance: 5 M Ω to 1000 M Ω \pm 10%, Optional 50 G Ω with external meter

■ Dielectric Withstand Test

DC Voltage: 100 to 1500 VDC \pm 5%, 10 to 100 V \pm 5 V

AC Voltage: 100 to 1070 VAC \pm 5%, 10 to 100 V \pm 5 V

Current Limit: (DC) 10 μ A to 2.5 mA, (AC) 10 μ A to 2.5 mA (RMS)

Max Capacitance / Net: 30 nF @ 1500 VDC, 9.5 nF @ 1000 VAC

HV Energy Limit: 35 mJ

HV Charge Limit: 45 μ C

Max Points Per Net

Unlimited

Digital Input/Output

10 Inputs / 10 Outputs, 30 V Open collector, +12 V and +5 V each current limited to 140 mA

Test Point Interface

96 pos. Female VME Eurocard connector-32 pos. loaded

User Interface

■ PC Requirements

Test Station: 2.0 GHz min. processor speed, Windows 10 Pro[®] or Windows 10 Pro[®], 15 GB hard drive space, 4 GB RAM, 256 MB min. video memory, 1024 x 768 min display resolution, sound (for audible feedback), USB 2.0 or 3.0 port

Optional Network Database Server: As above except no sound or USB ports required. Windows 10 Pro[®], Windows 11 Pro[®], Windows Server 2012[®], Windows Server 2016[®], Windows Server 2019[®].

Power

115 / 230 V 50/60 Hz

Size

17.4" x 6.3" x 17.4" (44.1 cm x 16.0 cm x 44.2 cm)
(base or expansion unit)

Weight

42 lbs (19kg) (fully loaded unit)

Expansion Options

Energization Unit: Powers relays, lamps, etc. for advanced testing

Isolated Power: Allows testing of devices connected to earth ground

Part Numbers

Part Number	Description
CCH2-BU	CH2 Base Unit with Easy-Wire s/w (holds up to 5 scanners)
CCH2-SC	CH2 Expansion Scanner Chassis (holds up to 5 scanners)
CCH2-HA	CH2 160-Point Test-Point Scanner

CH2 Options

SIO-EW-CIR	Digital I/O and Windows Messaging for Easy-Wire
SCPT-EW-CUS	Scripting Option for Easy-Wire
LAN-EW	Cirris Server Software for Easy-Wire (up to 5 testers)
SCH2-EW	Easy-Wire CH2 Software Upgrade for Existing System
PCHK-C2	CH2 Performance Check Kit

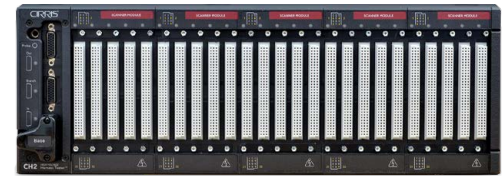

CH2 Base Unit



CH2 Expansion Scanner Chassis



CH2 160-Point Test-Point Scanner

Getting the most out of your CH2 Harness Tester

- Connect your device-under-test to the CH2 with interface cables. You can create interface cables on your own with parts provided by Cirris, or we can custom build interfacing for you. Learn more on page 28.
- Learn how expansion boxes add more test points to your harness tester on page 24.
- Cirris offers additional accessories that improve the ease of use and quality of life for your testing experience. Page 40.

Common Accessories



ADCS-C2

Connector Saver allow you to quickly connect interface cables to the tester without wearing the tester's connector interface.



ACH2-CR

CH2-8100 Converter changes two CH2 interface connectors to the 8100 interface connector.



ACCL-05

Hood Clips hold up to five VME connectors together and keeps them aligned so they can be plugged as one unit to the CH2 tester.



AC61-KF

CH2 Interface Cable is a 6-foot, 32-conductor mating cable connects to the CH2. All wire ends are labeled. Assembled using MIL-W-16878/5 Type EE 22 AWG for HV cable interface.



ETB-HS

Header strip transition board allows you to plug in quick-setup Smart-Light interface cables without wasting test points. Can provide a common interface between the 8100 and CH2 testers.



SMRT-05

Smart-Lights attach to an interface connector which can be plugged into any test point and instantly recognized by the tester.

External Energization Units

Cirris offers External Energization Units for CH2 tester. An Energization unit (E-Box) is a separate chassis that can be loaded with up to 800 energization points. The energization points are not test points but instead are used to energize lamps, LEDs, relays, or other devices in the DUT under the control of Easy-Wire® Software. Cirris sells 5, 12, 15, 24, 28, or 48-volt supplies for use with the Energization Unit. With optional software, the E-Unit can be used with a Keysight 3645 programmable power supply. The E-Unit can source up to 2 Amps and 60 volts.

Part Numbers

Part Number	Description
CCH2-ES	CH2 Energization Unit (Includes 160 E-Points)
CCH2-EM	CH2 160-point Energization Module
ZPWR-05	E-Power Supply 5V
ZPWR-12	E-Power Supply 12V
ZPWR-15	E-Power Supply 15V
ZPWR-24	E-Power Supply 24V
ZPWR-28	E-Power Supply 28V
ZPWR-48	E-Power Supply 48V

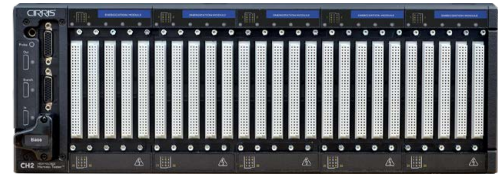

CH2 Energization Unit

TESTERS

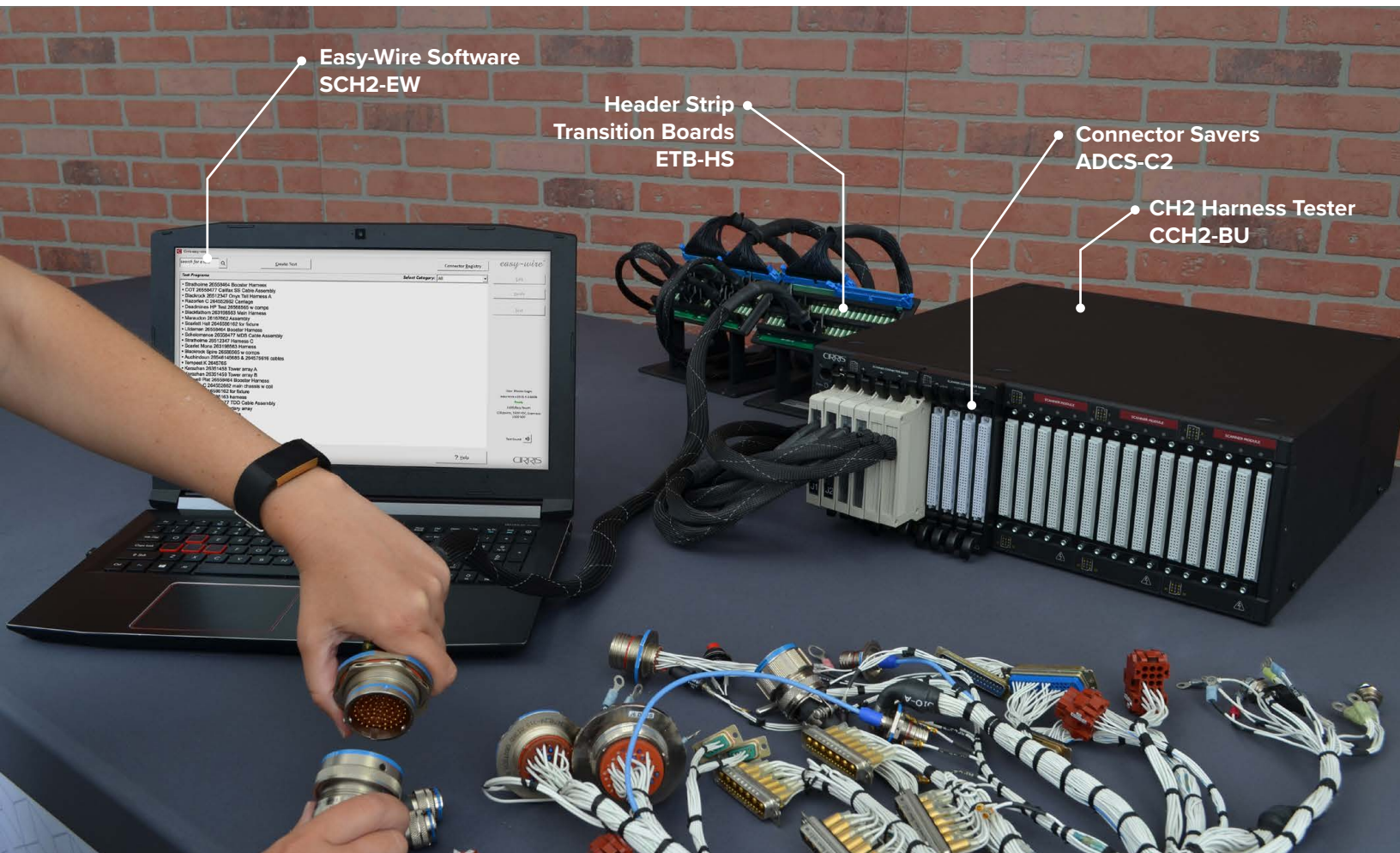

Easy-Wire Software
SCH2-EW

Header Strip
Transition Boards
ETB-HS

Connector Savers
ADCS-C2

CH2 Harness Tester
CCH2-BU

Adding More Test Points

Cable Testers

Cable testers come standard with 128 test points. Expansion boxes are easily purchased and attached to provide more test points—up to 1,024 points total. Expansion boxes can be used with base units of the same family for even greater flexibility and costs savings.

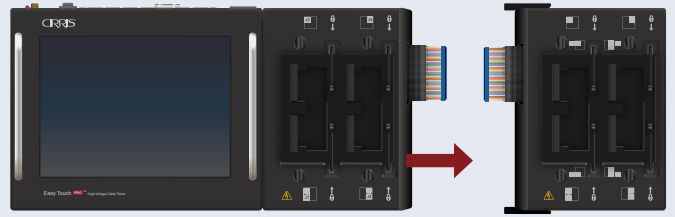

connecting an expansion box to an Easy-Touch® Pro tester

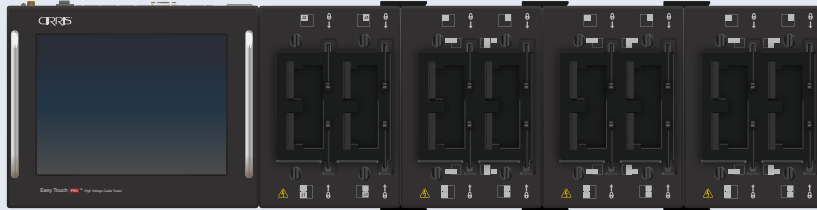

Easy-Touch Pro cable tester with multiple expansion boxes attached.

Harness Testers

Cirris testers can add more test points at the time of purchase or as needed later. The CH2 expands first by the number of test point cards in a chassis, then by adding another chassis with more cards. Add up to 100,000 test points in various increments depending on the Cirris tester.



CH2 unit with a single scanner card set of 160 test points

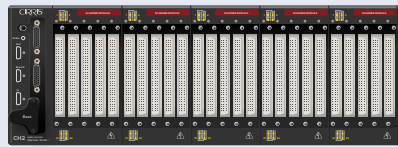

CH2 unit with a full scanner card set of 800 test points

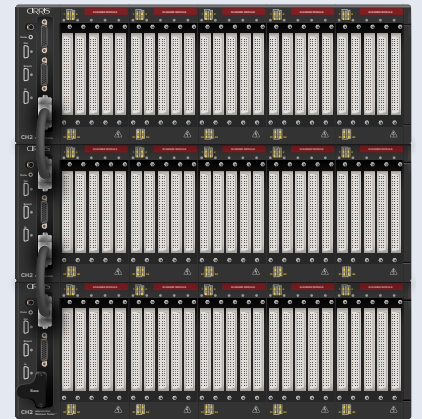

CH2 system expanded to 2,400 test points

Cirris 8100 low voltage testers are divided into base units and expansion boxes (add-ons). Each unit contains 256 test points. Base units can function alone. Expansion boxes add more test points. Test up to 100,000 test points with a maximized 8100 system.



8100 system with 768 test points



8100 system with 5,120 test points

Distributing Test Points

The modular design of the 8100 and CH2 systems allows test point enclosures to be distributed around larger assemblies eliminating the need for long, unwieldy interface cables. Using shorter cables improves organization and safety, reduces costs and decreases the contribution of cable interface to resistance measurements.

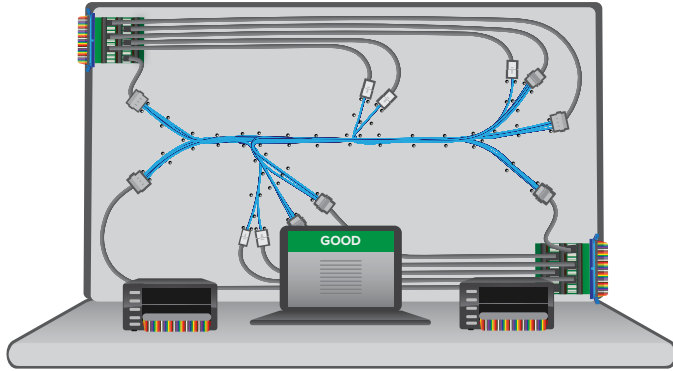

Small, 256-point 8100 expansion units can be placed around the DUT, where needed, to easily access product connectors and other terminations. A simple daisy-chain communications cable connects the units.

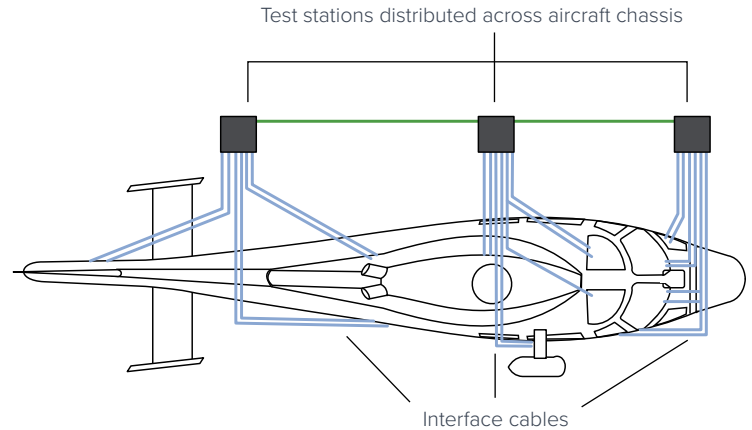

The CH2's relatively light and compact design allows expansion enclosures to be positioned as needed. Each enclosure can be populated with 160 to 800 test points and the chassis is designed to be stackable. A robust communication cable interconnects distributed units, which can be connected in either a daisy-chain or branched topology.

Guided Assembly

Moving testing upstream in the manufacturing process can significantly reduce the cost of nonconformance. When producing complex assemblies, or those prone to manufacturing defects, the ultimate implementation of this approach is test-while-building, guided assembly.

In guided assembly mode, the tester presents operators with textual, graphical and audible instructions for each step in the assembly process. Fixture LEDs can be also associated with instructions to provide further guidance on harness boards or parts bins. Each connection is tested as it's made giving immediate feedback and allowing operators to correct defects, often before the connection is completed. The result is zero-defects production and the near elimination of rework costs associated with wiring errors.

First-End Pinning

When populating first-end connectors it's sometimes required that marked or bar-coded wires be inserted in specified positions. The 8100 can verify if wires are properly located. When using the random order process, operators enter the wire's label manually or by scanning a barcode to bring the tester to the associated instruction. Capacitance measurements allow the tester to provide immediate feedback to the operator.

Assembly and Testing

Both the 8100 and CH2 support guided assembly which can be performed in either a random or predetermined sequence. Operators touch the conductor of any wire with the probe or while wearing a wrist strap to bring the tester to the associated instruction in random mode, or to identify the wire needed for the next step in sequential mode. Immediate feedback is provided to operators and full electrical testing is performed as the assembly is completed.

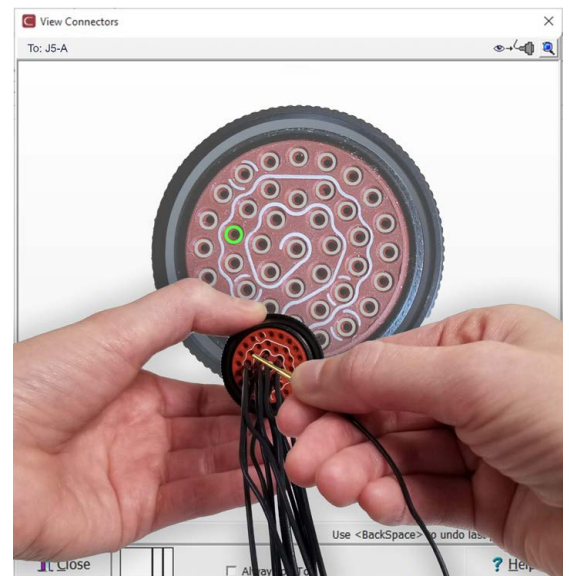

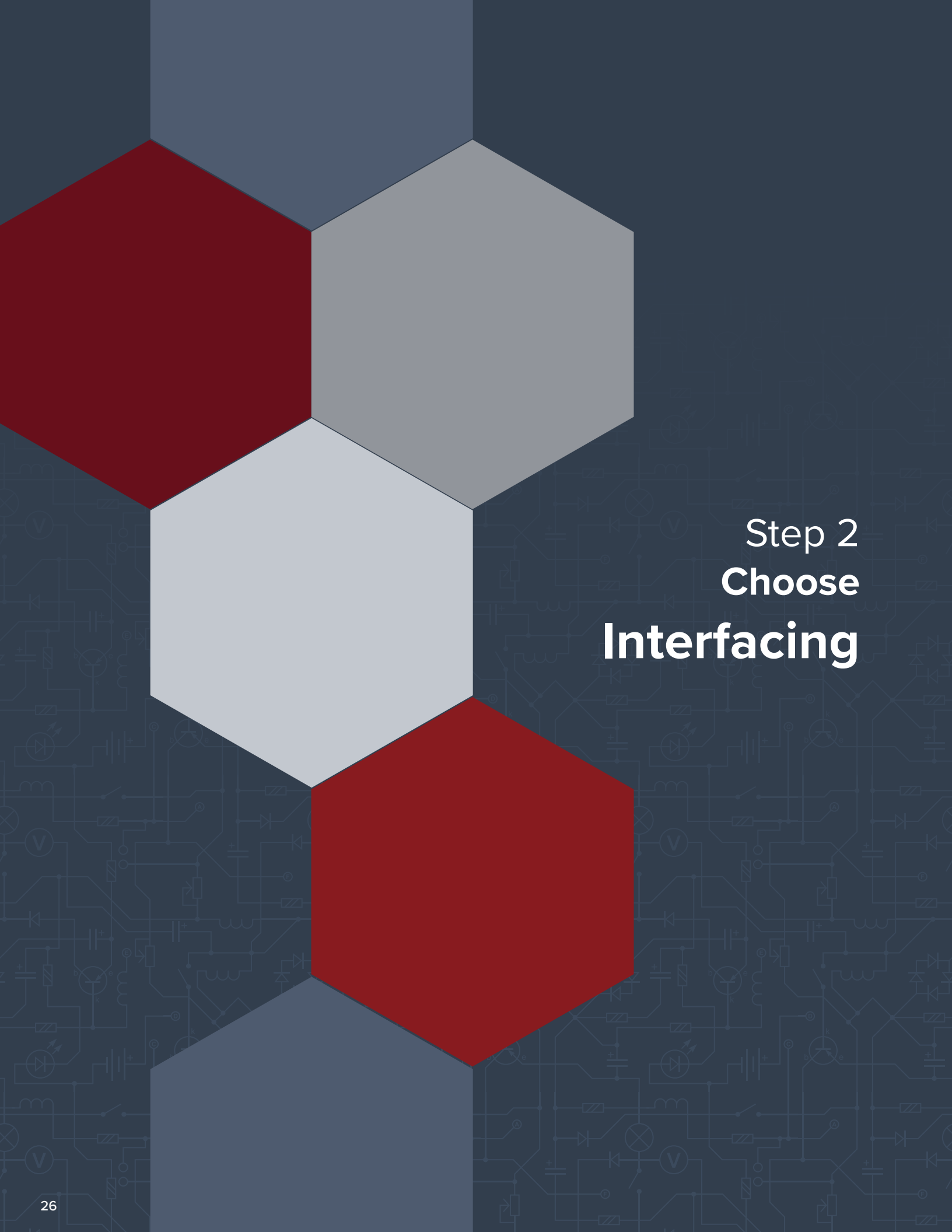

Step 2
Choose
Interfacing

Options for your interface cables

Cable interfacing connects the tester to the device-to-be-tested. Cable interfacing is a critical piece of your testing setup. Your cable interface may be used to test hundreds of cables, or you may build cable interfacing for a one-time job using specialized materials.

If you are new to testing, consult a Cirris representative about your cable interfacing options. We can help you decide the best path for future applications. For example, we can recommend or provide materials to assist you in building your own interface cabling, or Cirris can build cable interfacing for you. You will be using this setup for many years to come. It is important to get this piece right.

When planning your cable interface setup, there are generally two options to choose from:

- **Build your own interface cables**
- **Custom interface designed and built by Cirris**

As you decide which cable interface option is right for your test setup, consider your company's current resources, future growth strategies, and budget. Select the best plan that will meet long term needs.

If you already have an existing cable interface setup, we can modify one of our Cirris testers to use the same type of interface cabling that you currently use. This eliminates building all-new cable interfacing and being trained on a new test setup process.

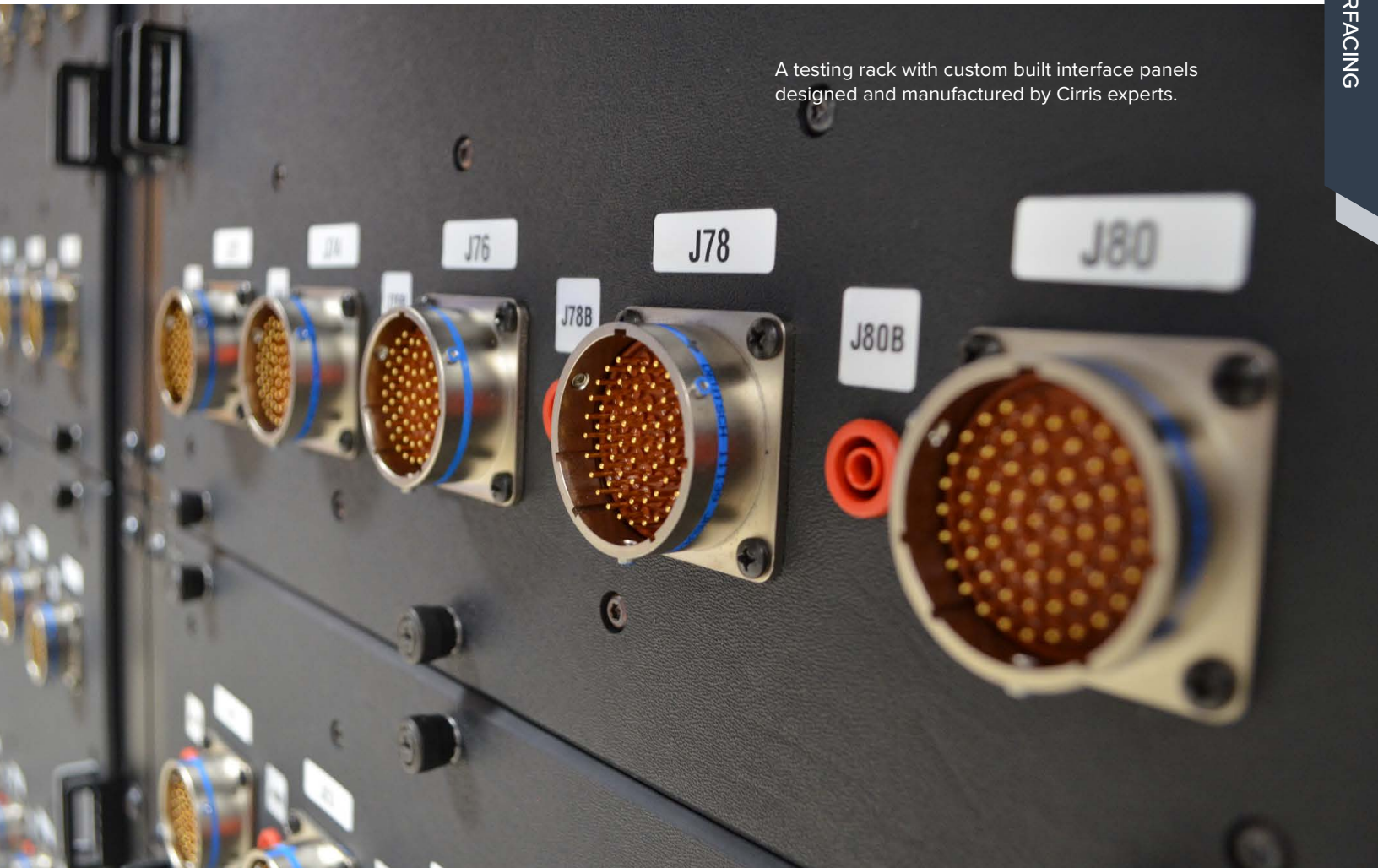

A testing rack with custom built interface panels designed and manufactured by Cirris experts.

Option 1: Build your own interface cables

This option opens infinite interfacing possibilities but requires organization to manage it. When building your own cable interface, you must determine which mating connectors will attach to your device, the wire type to connect to the contacts, and how to terminate the assembly with a connector that will attach to your tester. Choose materials that are easy to get a hold of, cost effective, and easily maintained.

Cirris Adapter System (for Cable Testers)

Often operations call for the ability to test a variety of cables that each have different connectors. The Cirris Adapter System allows you to quickly and easily change between different connector types. This provides better throughput on your production line as you can quickly change to your desired connector and start your next test.

Cirris adapters are compatible with all Cirris benchtop testers, including the Easy-Touch® Pro, 4250, 4200, and older benchtop units. At least one adapter is required to make bench-top testers functional. These adapters are designed for quick and easy interchangeability and determine the default test point labeling used by the tester.

High Voltage Adapters

High Voltage adapters are required in order to perform Hipot testing above 1000 VDC or 700 VAC. Not all adapters are available in a high voltage version. See the following pages for availability.

Grounded Adapters

Grounded adapters include a test point connected to the metal connector shell. This makes it possible to perform continuity testing to the shell and isolation from the shell. The test point connected to the shell is treated just like any other test point for the purpose of testing.

Replaceable Adapters

Many adapters are offered with replaceable connectors. These adapters have mating connectors that are plugged into sockets on the board and held in place with screws. This system makes it easy to replace worn connectors rather than purchasing an entirely new adapter.

Custom Adapters

If you don't see the test adapters you require among Cirris's standard adapters, we can custom build an adapter to fit your specific cable interface setup. Contact your Cirris representative or send an email to info@cirris.com to request pricing on custom adapters.



Cable tester with single high adapter attached

Adapter Sizes

Each Cirris benchtop tester and add-on scanner has 128 test points divided into four right-angle receptacle connectors. Each connector provides a maximum of 32 test points. Cirris manufactures adapters in three different sizes that plug into these receptacles.

■ **Single-high** adapters have one set of right-angle pins and plug into one receptacle on a tester or add-on scanner.

■ **Double-high** adapters have two sets of right-angle pins and plug into two vertically adjacent receptacles on a tester or add-on scanner.

■ **Quad-high** adapters have four sets of right-angle pins and plug into all four of the receptacles on a tester or add-on scanner. Quad-high adapters are not compatible with the 1000M, 2000, 5000A, or the original 1000H testers.

Single-high

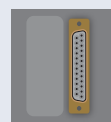

Double-high

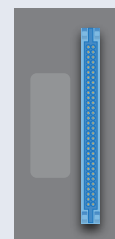

Quad-high

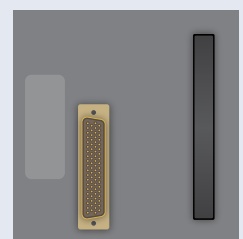

The following list of adapter options shows the connector interface on the adapter. The connectors are mounted on a Single, Double, or Quad-high adapter depending on the size of the connector (see facing page). To choose the correct adapter, consider the connector type your DUT will interface with, any high voltage or grounding needs, and number of test points needed.



0.8mm D-Shell Female

68-position	A8MM
-------------	------



Coaxial BNC Female

2-position (3 per adapter)	HBNC-02
----------------------------	---------

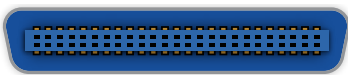

0.085" (2.16mm) Ribbon Male

Pins	High Voltage	High Voltage Grounded
50	HBRF-50	HRFG-50
64	HBRF-64	

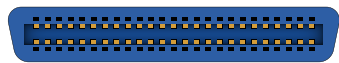

0.085" (2.16mm) Ribbon Female

Pos.	High Voltage	High Voltage Grounded	Replaceable
50	HBRM-50	HRMG-50	
64	HBRM-64		RBRM-64



0.050" (1.27mm) SCSI Female

20-position	AD5P-20
26-position	AD5P-26
40-position	AD5P-40
50-position	AD5P-50
68-position	AD5P-68



0.050" (1.27mm) SCSI Male

68-pin	AD5S-68
--------	---------



D-Sub Female

Pos.	High Voltage	High Voltage Grounded	Replaceable
9	HDBP-09	HDPG-09	RDBP-09
15	HDBP-15	HDPG-15	RDBP-15
25	HDBP-25	HDPG-25	RDBP-25
37	HDBP-37	HDPG-37	
50	HDBP-50	HDPG-50	RDBP-50

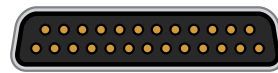

D-Sub Male

Pins	High Voltage	High Voltage Grounded	Replaceable	Replaceable Grounded
9	HDBS-09	HDSG-09	RDBS-09	RDSG-09
15	HDBS-15	HDSG-15	RDBS-15	RDSG-15
25	HDBS-25	HDSG-25	RDBS-25	RDSG-25
37	HDBS-37	HDSG-37	RDBS-37	RDSG-37
50	HDBS-50	HDSG-50	RDBS-50	RDSG-50



Terminal Strip for Discrete Wire - 20-position

Spring Terminal (16-24 AWG)	ADIS-2L
Screw Terminal (12-28 AWG)	ADIS-2S



2.0mm Milli-Grid Connector Shrouded Male

40-pin	A2MM-40
44-pin	A2MM-44
50-pin	A2MM-50

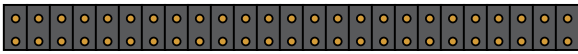

2.0mm Milli-Grid Connector Unshrouded Male

60-pin	AH2M-60
64-pin	AH2M-SD
100-pin	AH2M-QH

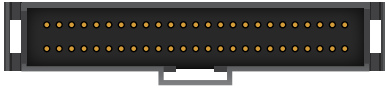

0.050" x 0.100" (1.27mm x 2.54mm) Dual Row Male

30-pin	AH50-30
40-pin	AH50-40
50-pin	AH50-50
60-pin	AH50-60
80-pin	AH50-80



0.1" x 0.1" (2.54mm x 2.54mm) Dual Row Eject Latch Header Female

Positions.	High Voltage	Replaceable
10	HHED-10	RHED-10
14	HHED-14	
16	HHED-16	
20	HHED-20	
24	HHED-24	
26	HHED-26	
30	HHED-30	
34	HHED-34	
40	HHED-40	RHED-40
44	HHED-44	
50	HHED-50	RHED-50
60	HHED-60	
64	HHED-64	RHED-64
64	HHR2-64 (2x 32-pos connectors)	



0.1" x 0.1" (2.54mm x 2.54mm) Dual Row Unshrouded Male

26-pin	High Voltage	HHED-SS
64-pin	High Voltage	HHED-SD



0.1" x 0.1" (2.54mm x 2.54mm) Dual Row Header Female

10-pin	High Voltage	HHEF-10
20-pin	High Voltage	HHEF-20
26-pin	High Voltage	HHEF-26
40-pin	High Voltage	HHEF-40



High Density D-Sub Female

Pos.	Standard	High Voltage	High Voltage Grounded	Replaceable	Replaceable Grounded
15		HMDP-15	HMPG-15		RMPG-15
26		HMDP-26	HMPG-26		
44		HMDP-44	HMPG-44		
62		HMDP-62	HMPG-62	RMDP-62	
78	AMDP-78				

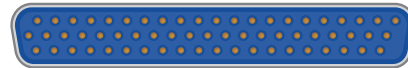

High Density D-Sub Male

Pins	Standard	High Voltage	High Voltage Grounded	Replaceable	Replaceable Grounded
15		HMDS-15	HMSG-15		RMSG-15
26		HMDS-26	HMSG-26		RMSG-26
44		HMDS-44	HMSG-44		
62		HMDS-62	HMSG-62	RMDS-62	
78	AMDS-78				



Modular Phone Connector Jack Female

Pos.	Standard	Grounded	Replaceable
6	AMJ6-06		
8	AMJ8-08	AMJG-08	RCMJ-08
4, 6, 8	AMJK-SP		



0.045" (1.143mm) Sq. Post on 0.156" (3.96mm) Spacing Single Row Unshrouded Male

1-24 pin	High Voltage	HSIL-SD
1-12 pin	High Voltage	HSIL-SS



**.025" (0.635mm) Sq. Post on 0.1" (2.54mm) Spacing
Single Row Unshrouded Male**

1-30 pin ■■ High Voltage	HHDS-SD
1-14 pin ■■ High Voltage	HHDS-SS



USB Connectors

Type A ■■	AUSB-4A
Type B ■■	AUSB-4B
Mini ■■	AUSB-MB

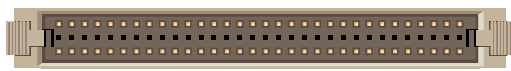

Eurocard (DIN/VME) Connector Male

64-pin ■■ High Voltage	HVM2-64
------------------------	---------



0.2" (5.08mm) VME Female 2000V (2 x 32-pin connectors)

64-position ■■ High Voltage	H2KM-64
-----------------------------	---------

Non-standard Adapters



Frame Mount Stand & Boards

Frame Mount Stands utilize customizable adapters for mounting connectors and cable interface that can't be accommodated with standard adapters.

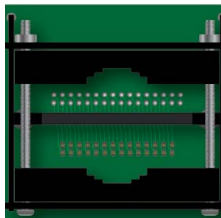

Clamp Adapters ■■ ■■

Clamp adapters provide an easy way to mount your mating connectors onto standard plug-in adapter cards even if they don't have mounting flanges or mounting tabs. The connector's contacts are individually wired to the pc board and the connector is clamped into position. When the connector becomes worn, just desolder it and install a new one.

Off-the-Shelf Items From Cirris

Cirris manufactures quality ready-made cable interface parts that attach to our testers. All you need to do is terminate the second end for the mating connectors on your device. Some of the parts Cirris produces include mating adapters, cables, transition boards, and other cable interface pieces. These items are not available on the open market. They are specific connectivity solutions made for Cirris testers.

Specialty Adapters & Converters



6' 32-conductor mating cable for CH2
AC61-KF

6' 32-conductor mating cable with
connectors on both ends
AC62-KF



Cable Saver for AC61-KF
ACCH-SV



Mating connector for CH+/CH2, solder
with hood
ACCH-CH

Mating connector for CH+/CH2, solder
without hood
ACCH-CO

Dust Cover for ACCH Connectors
ACCL-05

CH hood clips / mass connect
(kit of 5)
ACCL-05



Mating connector for CH+/CH2, crimp
with hood
ACCH-DH

Mating connector for CH+/CH2, crimp
without hood
ACCH-DO

Smart-Lights

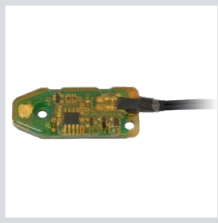

Smart-Light Intelligent Adapter
Set of 5
SMRT-05

Ribbon Cable

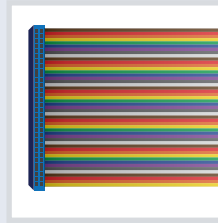

Ribbon cable with 64 female connector on one end 2' - 8'
AC20-64, AC40-64, AC60-64, AC80-64

Ribbon cable with 64 female connector on both ends 2' - 8'
AC22-64, AC42-64, AC62-64, AC82-64

64 position ribbon connector
AC00-64

Ribbon cable with 34 female connector on one end 2' - 8'
AC20-34, AC40-34, AC60-34, AC80-34

Ribbon cable with 34 female connector on both ends 2' - 8'
AC22-34, AC42-34, AC62-34, AC82-34

34 position ribbon connector
AC00-34

Discrete Cable

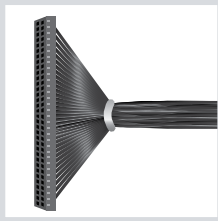

Discrete cable with 64 female connector on one end 2' - 8'
AD20-64, AD40-64, AD60-64, AD80-64

Discrete cable with 64 female connector on both ends 2' - 8'
AD22-64, AD42-64, AD62-64, AD82-64

64 position crimp discrete connector for 22-26 AWG wire
AD00-64

Transition Boards

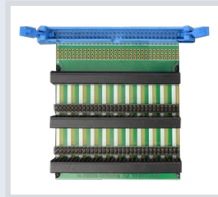

Header Strip Transition Board
Set of 2 (for Harness Testers)
ETB-HS

Header Strip Mating Connector Clip
Set of 5
EHS-CL



Screwless Terminal Transition Board, 64 points (16-28 AWG)
ETB-SLT



Screw Terminal Transition Board
64 points (12-28 AWG)
ETB-ST

Transition Options

Transition boards provide an alternative interface cable setup, so users are not always plugging directly into the tester. In most cases, worn out interface cables are easier to replace than worn out connectors on a tester. Typically customers mount the transition boards to their fixtures (like a harness board).

When testing at low voltage, or even at lower high voltages, ribbon cable is often used to connect the tester to the transition board. More robust cable interface wire with mating connector contacts crimped or soldered to it connect from the transition board to the device-under-test. This method provides flexibility in test setup and a saves time when changing adapter cables for a new test.

All Cirris transition boards and the converters are rated up to 1500 VDC and 1000 VAC. Cirris offers the three transition boards shown above.

Note: Transition card and converter voltages are generally rated 1500 VDC/1000 VAC. However, their effective use with ribbon cables, IDC connectors, and other non-high voltage cabling limit the voltage rating. These limitations make transition boards an attractive option for low or lower voltage testing.

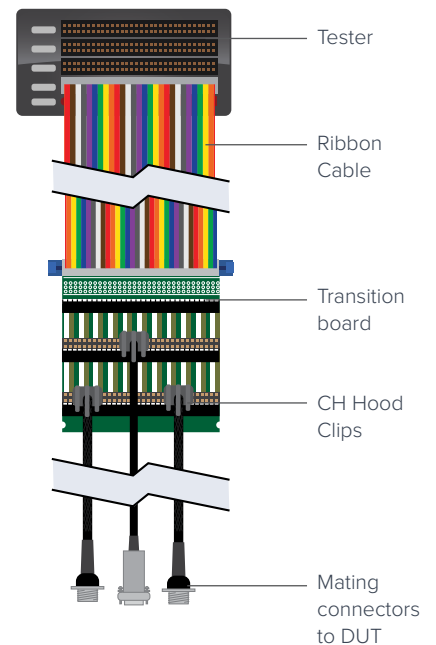

Smart-Lights®

Cirris Smart-Lights are a cable interface accessory designed to make test setup quick and easy. Once mounted to an interface connector, the Smart-Light device has a memory chip that can identify, map, and save test point configurations.

To program a Smart-Light, simply attach the device to an interface cable and plug the cable into the tester. Cirris Easy-Wire® Software will recognize the Smart-Light devices and map the points automatically no matter where they're connected to the tester, eliminating errors during test setup.

One of the most valuable features of Smart-Lights is the ability to quickly plug them in anywhere and not waste test points. While Smart-Light devices work well with any adapter-to-tester connector interface, Cirris Header Strips have become a popular interface tool that allows you to plug adapters of any size right next to each other.

Not only are Smart-Lights good for set up, but they have built-in features that help during build and test as well. Smart-Lights have a bright bi-color LED that guides the operator when building or troubleshooting a harness. During test setup, the light will flash green, signaling that it is ready to be used with the loaded test program. If an error occurs during testing, the Smart-Light will glow red to draw the operator's attention to the problem area. Once an error is resolved, the Smart-Light will flash green once more.

Smart-Lights are compatible with Cirris 8100, CH2, and CR testers.



A Smart-Light mounted to a connector

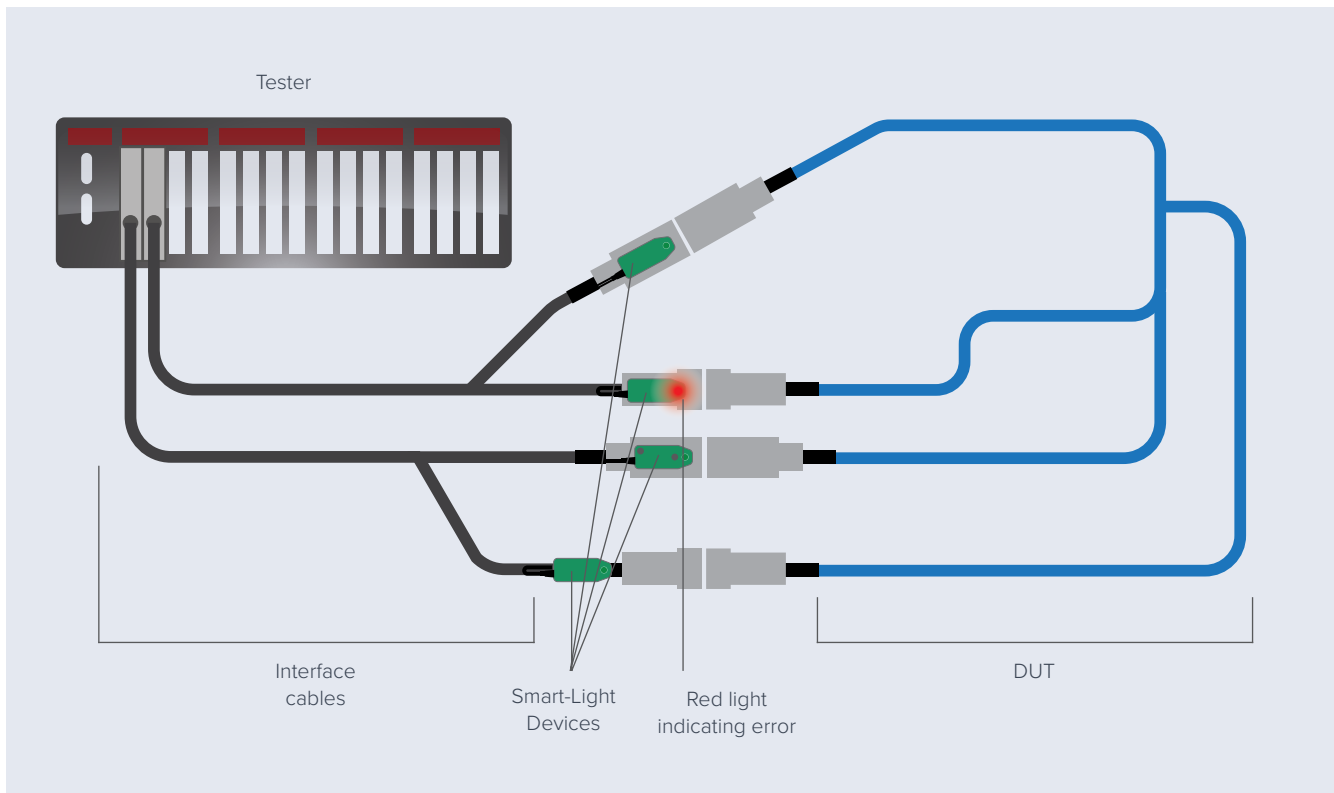

Option 2: Custom Interfaces Designed And Built By Cirris

The Cirris Test Applications Group (TAG) can build ready-to-go interface and testing solutions for your device. TAG can design the setup, acquire the necessary materials including the mating connectors, and build the system to your specifications. This option saves your company time and labor. Hiring TAG to build your interface setup guarantees quality results.

- Test Boards
- Harness Boards
- Interface Panels
- Cables
- Rack Systems
- Carts



Interface Panels:

A company transitioning from another test company to Cirris equipment may have tens of thousands of dollars' worth of cables that are still good. Cirris can create a custom interface that mounts to the front of a Cirris tester and uses their current connectors instead of buying new ones.

For companies wanting a different amount of connections rather than the 25 VME connectors on the CH2 or the four 64-pin Headers on the CR, Cirris can design an interface that uses the company's preferred connectors and pin outs.



Cables:

Cirris can build and test the interface cables needed to test your DUT. If you have a device that you would like to test, but you don't have the resources or time to manufacture interface cables that connect the device to the Cirris tester, Cirris can provide these cables.



Test Boards:

Test boards are used to test postproduction cables. The boards contain all the mating connectors needed to test that cables are correct before being entered into the final assembly.



Rack Systems:

Rack systems are used for large point count systems or systems that need to be moved around a facility to multiple test locations. These systems can contain multiple meters, custom interfacing, laptops, etc.



Harness Boards:

Harness Boards are used to build and test complete harnesses. A Cirris tester uses guided assembly to help build the harness. A final test is then performed before the harness is removed from the board.



Carts:

Carts are like rack systems in that they are mobile systems. Unlike rack systems, carts can be used as workstations. The tester is built in and wired to mechanical cable interface specific to what they are building.



Step 3
**Choose
Software &
Accessories**

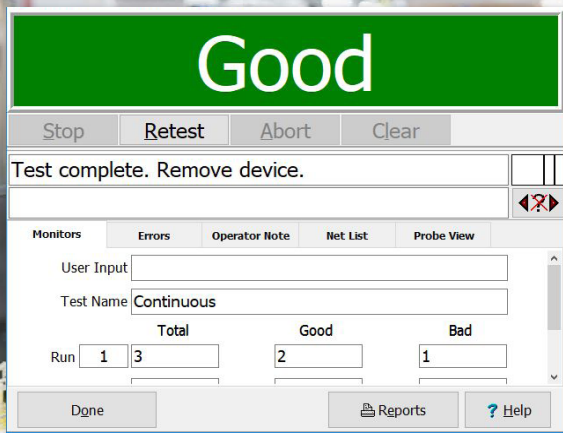

Easy-Wire® Software

Cirris Easy-Wire Software lets you take control of testing. From building test programs and testing cables to reporting results, Easy-Wire makes every step of the process simple. Create test programs, choose a test method, and customize reports through an easy-to-navigate graphic interface.

Product Features

- **Simplified Programming** – Easy-Wire Software guides users through the test program development process. Instructions can be generated by “learning” a sample product, entering the data manually, or importing information from an external wirelist.
- **Data Collection** – Easy-Wire Software captures and retains pass/fail results, test time and date, serial numbers, lot numbers, and measured values in a searchable database.
- **Custom Reporting** – Reports are readily customized to include information important to your company.
- **Test Point Labeling** – A straightforward labeling system associates test points with product labels. This provides an organized and consistent process by allowing programming and test messages to use product terminology for point descriptions.
- **Security** – Profiles and passwords can be created for each user or category of users to limit access to specified functions.
- **Test Program Revision History** – Current test program revisions along with their “last modified” dates are displayed in the software’s Main Menu. A record of successive revision levels and the comments associated with each change is retained in the database. Different versions of test programs can be compared to identify differences.
- **Organization** – Test programs can be grouped by category to simplify access for testing and editing.
- **Programmable Prompts** – Operator instructions such as documents, graphics, and video files can be programmed to open automatically in their native application, providing operator guidance during a test.
- **Flexibility** – Pass/fail thresholds are programmable. With hipot capable testers, alternate test voltages and test parameters can be specified on a net-by-net basis.
- **Switches** – Create test programs that test assemblies with switches. Test changed states associated with different switch positions.
- **Nets** – Test programs can be viewed by nets for a clearer overview of the test program. Easily identify nets that are connected by components.
- **Zero Defect Guided Assembly Aid** – Easy-Wire transforms Cirris Testers into a step-by-step guided assembly tool. Random or sequential build modes guide the operator through the assembly process using graphic instructions and audible queues. Each connection is tested as it’s completed.

Advanced Instructions

Advanced Instructions provide you with more flexibility and control over Cirris harness testers than the standard test instructions included with the Easy-Wire® Software. You have full control of the voltage and current used in a test. Custom instructions also have all the benefits of the standard Easy-Wire commands such as measured values, custom reporting, import/export, and Easy-Wire editor and test interfaces.

Common applications include:

- Perform 2-wire resistance measurements using a specified current and compliance voltage.
- Perform 4-wire resistance measurements using a specified current and compliance voltage.
- Test the resistance of probed points.
- Test the 4-wire resistance of probed points.
- Functionally test optocouplers or fiber optic links using a photo diode as the light source and a light sensitive transistor as the test device.
- Measure zener diodes and LEDs up to 10 volts.
- Limit test stimulus voltage to 250 millivolts and stimulus power to 1 milliwatt for testing sensitive active components.

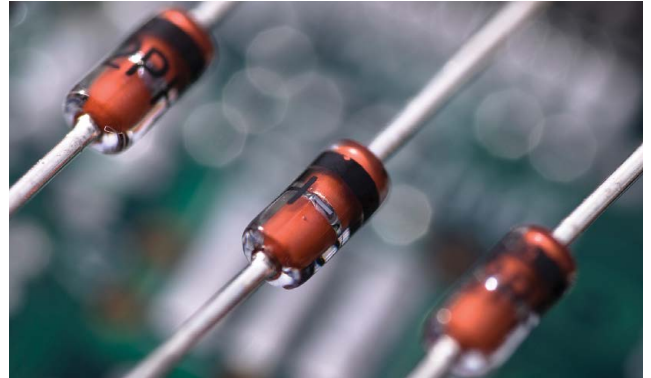

Measure zener diodes with the advanced control provided by custom instructions

Additionally, custom instructions allow you to integrate external instruments with the CH2's relay matrix to measure complex components in your test and provide greater accuracy. The CH2 can control the Keithley 2400 Series Source meters, Keysight 34401 and 34410 digital multimeters, Keysight E4980AL LCR meter, and a Keysight 3645 programmable power supply.



Keithley 2400 SMU

Common applications include:

- Perform extended range high voltage insulation resistance (IR) measurements up to 50 gigaohms; higher IR measurements are possible.
- Perform high accuracy inductance measurements.
- Perform high accuracy capacitance measurements.
- Perform high accuracy 2-wire and 4-wire resistance measurements
- Perform high accuracy voltage and current measurements.
- Test leakage current in diodes, transistors, MOSFETs, and integrated circuits with applied voltage up to 1100 volts.
- Test transzorbors, zener diodes, and gas discharge tubes.

Custom Instruction

Custom Instruction Category
Cirris CH2

Custom Instruction Name
Compliance Limited 2W Resistance

Source Point

Connector: J1 Pin: 3

Sink Point

Connector: J3 Pin: 8

Between Points

Allow Resistances > Wire Instruction Resistance

Allow Shorts (All Resistances)

Edit Parameters

Try It Status Measured:

OK Cancel Help

Measure 2W Resistance

Source Compliance Voltage: 2.500

Units: m Volts Volts

Source Current: 10.000

Units: p Amps n Amps u Amps m Amps Amps

Dwell Time: 0

Units: m Sec Sec

Enable: Enable

Measurement Low Limit: 0

Units: m Ohms Ohms k Ohms M Ohms G Ohms

Enable: Enable

Measurement Low Limit: 10.000

Units: m Ohms Ohms k Ohms M Ohms G Ohms

OK Cancel

Scripting

When you need flexibility and control beyond what your Cirris tester can provide with its standard interface, scripting provides a solution. Cirris can write custom scripts for your application or provide the resources to write your own scripts. Cirris tester scripts are written in the powerful Lua programming language.

The following are some examples where you might require scripting:

- Testing multiple parts simultaneously while presenting pass/fail results for each part.
- Adding a test condition for an operator to verify the correct color of a bi-color LED and recording this verification on the test report.
- Controlling test behavior through digital I/O beyond the tester's innate capability.
- Making highly customized reports or cable tags.
- Comparing separate measurements to determine pass/fail results.

Cirris testers provide scripting flexibility by accepting three types of scripts.

- **Report Scripts** – At the end of a test, Cirris testers output reports and labels. Report scripts add increased functionality and customization to your test reports and labels.
- **Event Scripts** – Though you may not be aware of them, there are many “events” throughout the testing process. For example, one event takes place when the tester completes the low voltage test. Other events occur when the tester signifies either a pass or fail. A single event script can be triggered upon a test event.
- **Component Scripts** – Cirris testers use test instructions to track the electrical connections or electrical components that are tested. Component scripts can be inserted anywhere in the list of test instructions. A component script will act like a test instruction, determining if a test will pass or fail. Values gathered by component scripts can be reported on test reports.

```
cmpMinResis = {}
cmpMinResis.description = "Minimum Resistance"
cmpMinResis.params = {
    {"From Point", "point", 1},
    {"To Point.. ", "point", 1},
    {"Minimum Resistance Ohms.....",
     "number", 10}
}

function cmpMinResis.test(pt1, pt2, fRes)
    local fMeasRes =
    GetResistanceMeasurement(pt1,pt2)
    if iWithinTolerance(fMeasRes, fRes) ~= nil then
        return fMeasRes -- Passed
    else -- Failed
        return fMeasRes, "Resistance is low: "
        .. format("%g", fMeasRes)
    end
end

function iWithinTolerance(fTestVal, fMasterVal)
    local iRet = 1 -- assume pass condition
    if fTestVal > fMasterVal then
        iRet = nil -- resistance is too low
    end
    return iRet
end
```

In this example, a simple script allows the test to measure a specified resistance across two test points and rejects if the measured resistance is less than the specified value.

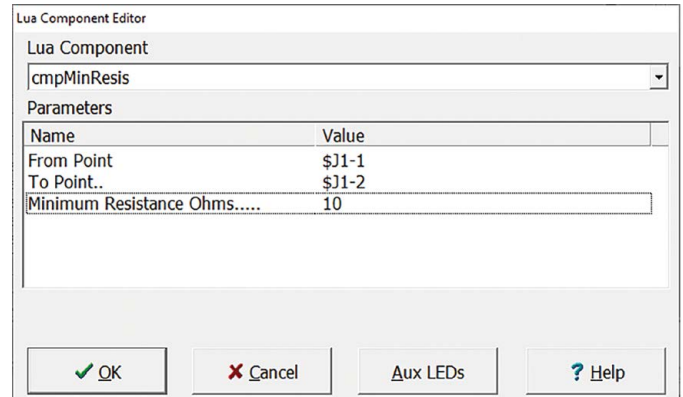

The Easy-Wire interface allows you to easily change the values passed to your script.

Cirris Server Software

Cirris Server Software links all Cirris testers running Easy-Wire Software onto the same network. This means Cirris testers can share test programs within their tester families. For example, all 8100 test stations can share the same 8100 test programs.

With testers networked together, test engineers can set up test programs at their desk, then walk to the production floor to run them. In addition, fixture definitions—consisting of connector names, connector images, pin outs, and Smart-Light registrations—are all saved in one place. Use cable interfacing anywhere in your facility without duplicating setup.

Back up all your test data in one central storage space. With your test records in one place, you can search and print reports from any networked test station.

Though a wired network connection is more robust, Cirris Server Software can securely transfer data between the network server and satellite Easy-Wire stations.

Having your Cirris testers on a network saves you from copying information from one tester to the other.

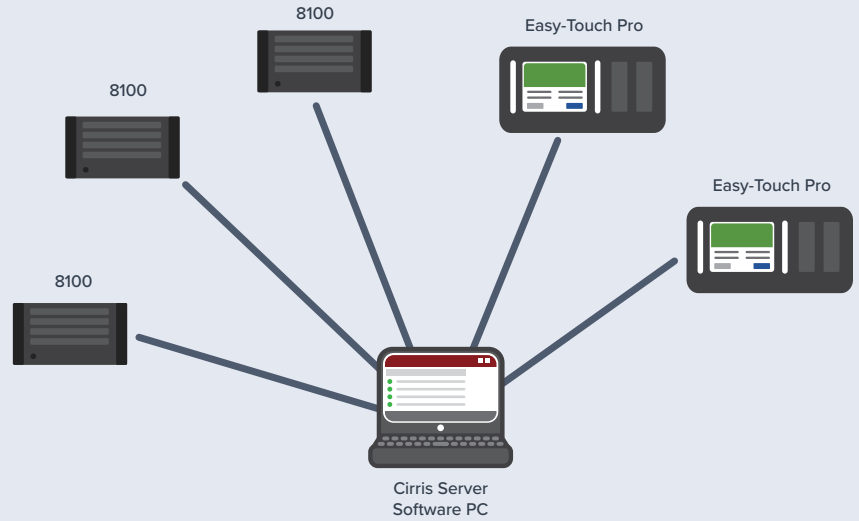

Cirris Hub™

Use Cirris Hub Software to easily monitor and track your production floor testers. With this easy-to-use tool, you can safeguard that the right test programs are used by storing them on your desired network drive and managing them through the Hub. Having the capability to edit and save the test programs over the Hub ensures that the latest test programs are always used. With Hub software, testers can even access test programs in a different state or country.

Hub Software has a main dashboard to view all your networked testers at once. Track which testers are online and offline, monitor your testers' calibration dates, view which firmware is installed, and find hardware revisions and tester serial numbers.

Efficiently manage your plant floor printers with the Hub. Print test reports to your desired printer or take it one step further and save them to PDF. Store your test programs for future use, for sharing with your customers electronically, or to meet your quality certifications.

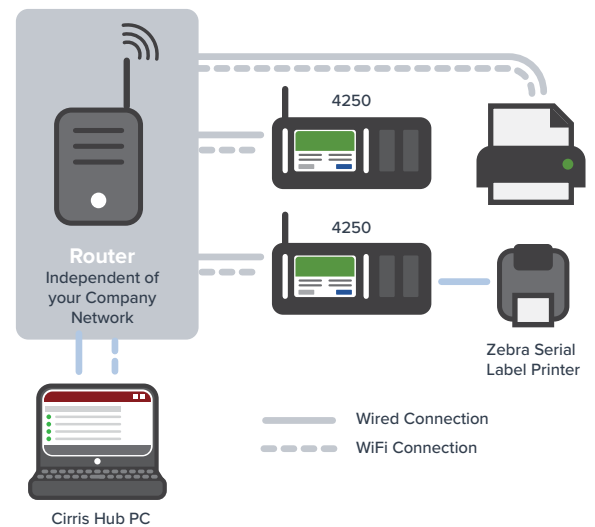

Accessories

Printers



**Brother HL-L6200DW
PRNT-BJ**

Local printing for 4200 Series cable testers. Requires SER2-USB cable.



**Label Printer Starter Kit
PRNT-KIT**

Serial based and compatible to connect directly to a 4200 Series tester.

Includes: Zebra GC420t Printer, cable, ribbon, one label roll.



**USB Laser Bar Code Scanner
BCS-LASER**

Entry level barcode scanner compatible with 4200 Series and PC based testers.



**Smart Serial to USB Cable
SER2-USB**

For 4200 Series local printer

**Parallel to USB Adapter
PRNT-AD**

Allows 1100 Series testers to print to HP M402N Laser Printer (PRNT-BJ)

Power Cords



**Replacement power supply for
4200 & 4250
RPWR-42**

**Replacement power supply for
Easy-Touch® Pro and CH2
RPWR-10**

Additional Cables



**USB Type A to USB Type B Cable
3' long
PC-USB**

**Ethernet Cable 7' long
PC-CAT5e**

Alarm Boxes



**Alarm box with push-button reset for
4200 series testers
ALRM-1H, ALRM-1R**

Probes

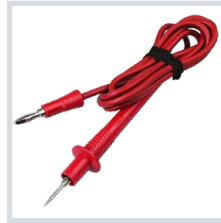

**Banana Jack Probe (set of two)
APRB-BJ**

Compatible with most Cirris testers.

**Wrist strap for 8100 (banana jack)
AWRS-BJ**

Adapter Accessories



**Adapter Trays for storing
Cirris adapters
ARAC-SS, ARAC-SD**

Which-Ender



**Identifies which end of an assembly has
an open
CP-1**

Tilt Stands



**Cable Tester Tilt Stand - Easy-Touch,
4200/4250, 1100R+/H+
ATLT-AJ (adjustable), ATLT-NA (standard)**

Additional Information

Calibration

Each new Cirris tester includes a certificate of calibration valid for one year. In addition to the certificate, the calibration verification date can be found on a sticker applied to the back panel of the tester and if using the Cirris Hub, the date is available on the Testers Page. Cirris recommends the calibration be verified annually at a minimum.

The calibration verification can be performed using an optional performance check kit following a fully documented process. Each kit is designed for a specific tester type and includes a series of standards, the values of which are certified and traceable to NIST (the United States National Institute of Standards and Technology). The certificate of calibration included with a performance check kit is valid for two years.

Testers can also be returned to Cirris for calibration verification. The service includes a certificate of calibration valid for one year and an updated sticker applied to the unit.

No adjustments are made to the testers during the calibration verification process. If a unit fails the verification, it will require service to address the underlying hardware issue.

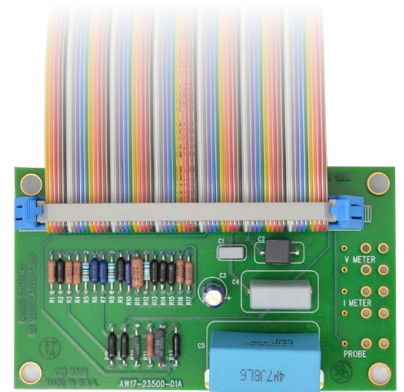

Performance Check Kit



Warranty

Cirris warrants its testers to be free of defects in materials and workmanship for a period of one (1) year from the date of delivery to you. In the event a defect develops due to normal use during the warranty period, Cirris will repair or replace the analyzer with a new or reconditioned unit of equal value.

If a tester failure results from accident, abuse, or misapplication, Cirris Inc. shall have no responsibility to replace the analyzer or refund the purchase price.

Cirris warrants repaired testers for 90 days, if the same part fails before 90 days has passed, Cirris will replace the part at no charge. Labor and Shipping charges may still apply.



How Can We Help You?

At Cirris, we specialize in solving cable testing problems quickly and cost-effectively. With a track record of assisting thousands of customers globally, we are experienced in handling testing challenges of all levels of complexity. Give us the opportunity to help you by visiting www.cirris.com.

Contact Us

For questions about our products or services, please contact your sales representative or Cirris distributor. Visit cirris.com/contact.

Cirris, Inc.

 (+1) 801-973-4600

 info@cirris.com

 cirris.com

 401 North 5600 West
Salt Lake City, UT 84116

CIRRIS[®]
A KOMAX COMPANY