

BK PRECISION®

Model: 2540B, 2542B

Digital Storage Oscilloscopes

USER MANUAL

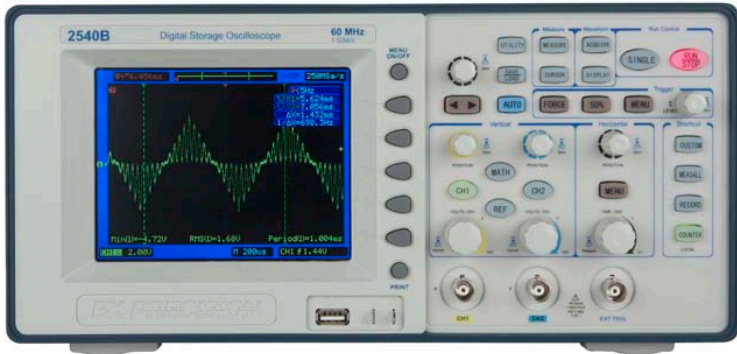

Safety Summary

The following safety precautions apply to both operating and maintenance personnel and must be observed during all phases of operation, service, and repair of this instrument. Before applying power, follow the installation instructions and become familiar with the operating instructions for this instrument.

If this device is damaged or something is missing, contact the place of purchase immediately.

This manual contains information and warnings that must be followed to ensure safe operation as well as to maintain the oscilloscope in a safe condition.

GROUND THE INSTRUMENT

To minimize shock hazard, the instrument chassis and cabinet must be connected to an electrical ground. This instrument is grounded through the ground conductor of the supplied, three-conductor ac power cable. The power cable must be plugged into an approved three-conductor electrical outlet. Do not alter the ground connection. Without the protective ground connection, all accessible conductive parts (including control knobs) can render an electric shock. The power jack and mating plug of the power cable must meet IEC safety standards.

DO NOT OPERATE IN AN EXPLOSIVE ATMOSPHERE

Do not operate the instrument in the presence of flammable gases or fumes. Operation of any electrical instrument in such an environment constitutes a definite safety hazard.

KEEP AWAY FROM LIVE CIRCUITS

Instrument covers must not be removed by operating personnel. Component replacement and internal adjustments must be made by qualified maintenance personnel. Disconnect the power cord before removing the instrument covers and replacing components. Under certain conditions, even with the power cable removed, dangerous voltages may exist. To avoid injuries, always disconnect power and discharge circuits before touching them.

DO NOT SERVICE OR ADJUST ALONE

Do not attempt any internal service or adjustment unless another person, capable of rendering first aid and resuscitation, is present.

DO NOT SUBSTITUTE PARTS OR MODIFY THE INSTRUMENT

Do not install substitute parts or perform any unauthorized modifications to this instrument. Return the instrument to B&K Precision for service and repair to ensure that safety features are maintained.

WARNINGS AND CAUTIONS

WARNING and ***CAUTION*** statements, such as the following examples, denote a hazard and appear throughout this manual. Follow all instructions contained in these statements.

A ***WARNING*** statement calls attention to an operating procedure, practice, or condition, which, if not followed correctly, could result in injury or death to personnel.

A **CAUTION** statement calls attention to an operating procedure, practice, or condition, which, if not followed correctly, could result in damage to or destruction of part or all of the product.

CAUTION: *Before connecting the line cord to the AC mains, check the rear panel AC line voltage indicator. Applying a line voltage other than the indicated acceptable voltage can destroy the instrument.*

CAUTION: *This product uses components which can be damaged by electro-static discharge (ESD). To avoid damage, be sure to follow proper procedures for handling, storing and transporting parts and subassemblies which contain ESD-sensitive components.*

Compliance Statements

Disposal of Old Electrical & Electronic Equipment (Applicable in the European

Union and other European countries with separate collection systems)

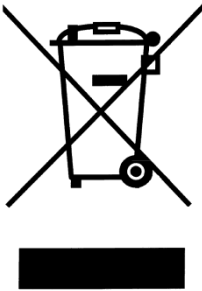

This product is subject to Directive 2002/96/EC of the European

Parliament and the Council of the European Union on waste

electrical and electronic equipment (WEEE) , and in jurisdictions

adopting that Directive, is marked as being put on the market after August 13, 2005, and should not be disposed of as unsorted

municipal waste. Please utilize your local WEEE collection facilities in the disposition of this product and otherwise observe all applicable requirements.

Safety Symbols



Chassis (or earth) ground symbol.



This symbol on an instrument indicates caution. For details, the user should refer to the operating instructions in the manual.



Electrical Shock hazard.



On (Power). This is the In position of the power switch when instrument is ON.



Off (Power). This is the Out position of the power switch when instrument is OFF.



This symbol is a power switch located at the top of the oscilloscope. Pressing this button toggles the oscilloscope's state between power on and power off mode.

CAT I (400V) IEC Measurement Category I.
Inputs may be connected to mains (up to 400 VAC) under Category I overvoltage conditions.

Environmental Conditions

| | |
|-----------------------|--------------------|
| Operating Environment | 0 °C to 40 °C |
| Storage Humidity | 0 – 80% R.H. |
| Storage Environment | -20 °C to +50 °C |
| Pollution degree | Pollution degree 2 |

Notations

TEXT – Denotes buttons on the oscilloscope.

Text – Denotes softkeys from the menu system, selectable by pressing corresponding menu softkey buttons.

Table of Contents

| | |
|------------------------------------------------|-----------|
| 1 GETTING STARTED | 13 |
| 1.1 Introduction | 14 |
| 1.2 Package Contents | 15 |
| 1.3 Input Power Requirements | 15 |
| 1.4 Panel and Screen Display | 16 |
| <i>Front Panel Display</i> | 16 |
| <i>Back Panel Display</i> | 18 |
| <i>LCD Main Screen Display</i> | 19 |
| 1.5 Quick Check | 21 |
| <i>Power On Check</i> | 21 |
| <i>Basic Check</i> | 22 |
| 1.6 Probe Safety | 24 |
| 1.7 Probe Attenuation | 25 |
| 1.8 Probe Compensation | 25 |
| 2 BASIC OPERATION | 27 |
| 2.1 Using Quick Help | 28 |
| 2.2 Using Autoset | 29 |
| 2.3 Vertical Controls | 31 |
| <i>Vertical Position Knob (CH1, CH2)</i> | 31 |
| <i>Vertical Scale Control (CH1, CH2)</i> | 32 |
| Channel Keys CH1 , CH2 | 33 |
| <i>CH1, CH2 Menu</i> | 33 |
| <i>MATH Functions</i> | 45 |
| <i>REF Function</i> | 51 |

| | | |
|----------|------------------------------------------|-----------|
| 2.4 | Horizontal Controls | 54 |
| | <i>Horizontal Position Control</i> | 55 |
| | <i>Horizontal Scale Control</i> | 55 |
| | <i>Main - Horizontal Mode</i> | 57 |
| | <i>Delayed - Horizontal Mode</i> | 59 |
| | <i>X-Y Horizontal Mode</i> | 61 |
| | <i>Roll - Horizontal Mode</i> | 63 |
| 2.5 | Trigger Controls | 65 |
| 2.6 | RUN Controls | 79 |
| 3 | MENU OPERATION | 80 |
| 3.1 | UTILITY Menu | 81 |
| | <i>I/O Setup</i> | 86 |
| | <i>System Setup</i> | 94 |
| | <i>Service</i> | 99 |
| | <i>Pass/Fail</i> | 101 |
| 3.2 | MEASURE Menu | 105 |
| | <i>Voltage Measurements</i> | 107 |
| | <i>Time Measurements</i> | 111 |
| 3.3 | ACQUIRE Menu | 120 |
| | <i>Record Waveform</i> | 125 |
| | <i>Playback Record</i> | 126 |
| | <i>Save/Recall the Record</i> | 128 |
| | <i>Exit Record Function</i> | 129 |
| 3.4 | SAVE/LOAD Menu | 130 |
| | <i>Internal Storage</i> | 131 |

| | | |
|----------|----------------------------------------------|------------|
| | <i>External Storage</i> | 133 |
| | <i>Firmware Update</i> | 139 |
| 3.5 | CURSOR Menu | 140 |
| | <i>Manual Mode</i> | 141 |
| | <i>Track Mode</i> | 143 |
| | <i>AUTO Mode</i> | 145 |
| 3.6 | DISPLAY Menu | 146 |
| 4 | SHORTCUT MENU | 149 |
| 4.1 | Shortcut Controls | 150 |
| | <i>CUSTOM Button</i> | 150 |
| | <i>MEASALL Button</i> | 152 |
| | <i>RECORD Button</i> | 153 |
| | <i>COUNTER/LOCAL Button</i> | 153 |
| 5 | QUICK START GUIDE | 155 |
| 5.1 | Make Simple Measurements | 156 |
| 5.2 | Capture Single Shot Signal | 158 |
| 5.3 | Reduce Random Noise on a Signal | 160 |
| 5.4 | Triggering a Video Signal | 162 |
| 5.5 | PASS/FAIL Measurement | 164 |
| 5.6 | Using Waveform Recorder | 166 |
| 5.7 | Making Cursor Measurements | 170 |
| 6 | REMOTE CONTROL | 177 |
| 6.1 | Comsoft Software | 178 |
| 6.2 | Web Browser GUI | 178 |
| 7 | TROUBLESHOOT GUIDE | 179 |
| 7.1 | System Message | 180 |

| | | |
|----------|------------------------------------------------------------|------------|
| 7.2 | General Problems..... | 184 |
| 8 | SPECIFICATIONS..... | 187 |
| 8.1 | Digital Storage Oscilloscope Specifications .. | 188 |
| 8.2 | General Specifications | 195 |
| 8.3 | Certification..... | 196 |
| | Appendix A: Performance Verification Procedure..... | 197 |
| | DC Gain Accuracy..... | 198 |
| | Bandwidth | 200 |
| | Trigger Sensitivity..... | 201 |
| | Time Scale Accuracy..... | 202 |
| | Appendix B: Disabling Auto Function | 203 |

1 GETTING STARTED

- Introduction
- Package Contents
- Input Power Requirements
- Panel and Screen Display
- Quick Check
- Probe Safety
- Probe Attenuation
- Probe Compensation

1.1 Introduction

The 2540B and 2542B are part of a series of portable digital storage oscilloscopes (DSOs) that offer up to 100 MHz bandwidth with a 1 GSa/s sample rate.

Features

- 60/100 MHz bandwidth (2540B/2542B)
- 1 GSa/s sample rate
- Bright 5.6" TFT color display
- Deep waveform memory up to 2.4 Mpts (accessible via remote interface)
- Shortcut keys for quick access of frequently used functions
- Versatile triggering capabilities including pulse width, line-selectable video, slope, and alternating trigger
- 24 automatic measurements
- Digital filter with adjustable limits, pass/fail testing, and waveform recorder mode
- Ten different language user interfaces
- For educators – ability to disable the Auto Set button
- LAN and USB host connectivity for remote PC control through Comsoft PC software
- USB device port for convenient storing and recalling of waveform data, setups, and screenshots on a USB flash drive

Getting Started

1.2 Package Contents

The digital storage oscilloscopes are shipped with the following contents:

- 2540B/2542B Digital Storage Oscilloscope
- User Manual
- Certificate of calibration
- USB (Type A to B) communication cable
- AC Power Cord
- Two 150 MHz 1x/10x passive oscilloscope probes

Please locate each item from the original packaging and contact B&K Precision immediately if something is missing.

1.3 Input Power Requirements

The 2540B, and 2542B DSOs do not require a line fuse when different voltage lines are used for powering the instrument.

The power input requirements are:

| |
|---------------------------------------------------------------------------------------------------------------------|
| Input Voltage Range: ~99 V to 242 VAC Input Frequency: 47 Hz to 440 Hz Rating: 50VA Max. |
|---------------------------------------------------------------------------------------------------------------------|

Getting Started



Before connecting the instrument from an AC outlet, please verify that the above power input requirements are met. Connecting incorrect AC power input to the instrument is dangerous and may damage the instrument, voiding its warranty.

1.4 Panel and Screen Display

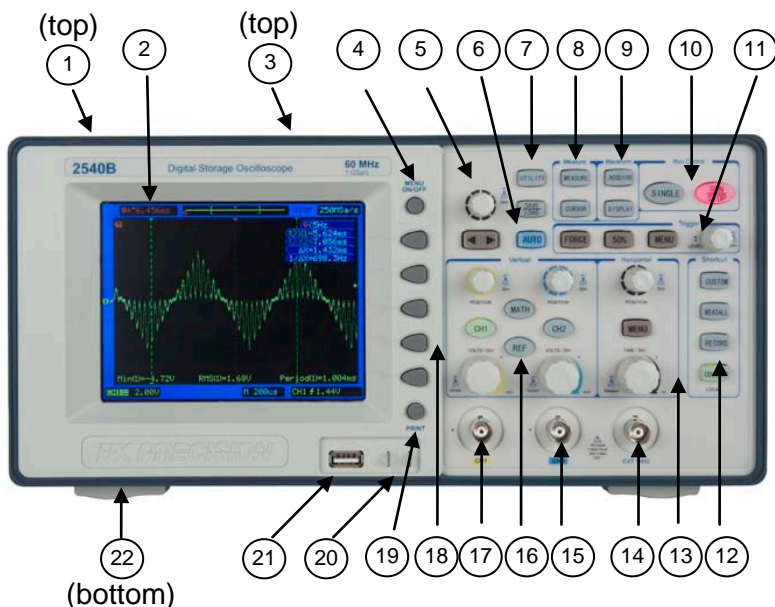
Front Panel Display



Getting Started

1. Power ON/OFF button  (*top panel*)
2. LCD display screen
3. Carrying handle (*top panel*)
4. Menu ON/OFF button
5. Adjustment knob 
6. AUTO SET button
7. UTILITY & SAVE/LOAD menu buttons
8. MEASURE & CURSOR menu buttons
9. ACQUIRE & DISPLAY menu buttons
10. RUN control (SINGLE & RUN/STOP) buttons
11. TRIGGER controls
12. Shortcut buttons & Local key (Alternate function of COUNTER button; used to set unit to local mode when in remote mode)
13. HORIZONTAL controls
14. EXT TRIG BNC terminal
15. Channel 2 BNC input
16. VERTICAL controls
17. Channel 1 BNC input
18. FUNCTION buttons (for soft panel menu)
19. PRINT button
20. Probe compensation terminal
21. USB device port (supports most USB flash drives)
22. Tilt feet (*bottom*)

Getting Started

Back Panel Display

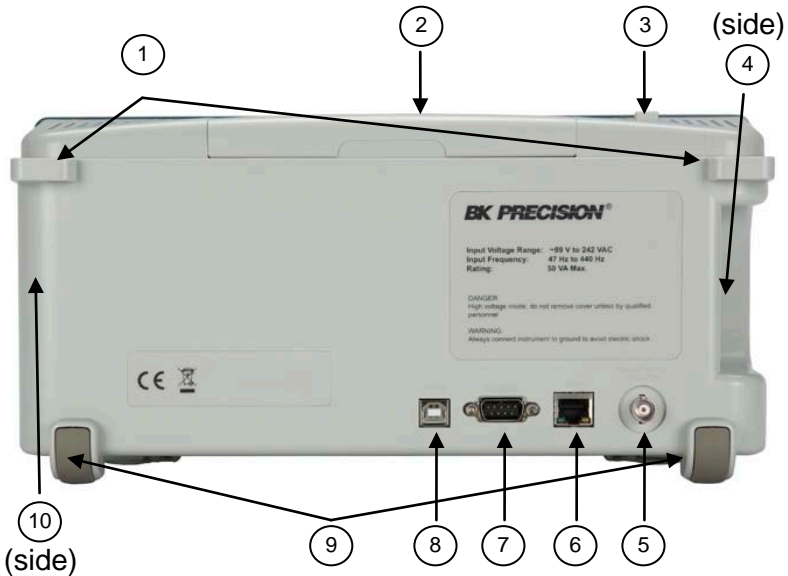

1. Security loops
2. Carrying handle
3. Power ON/OFF button
4. AC line input (*side panel*)
5. Pass/Fail output (*isolated*)
6. LAN interface port
7. RS232 serial interface port
8. USB host interface port
9. Rear rubber feet
10. Ventilation fan (*side panel*)

Getting Started

LCD Main Screen Display

The oscilloscope display contains channel acquisitions, setup information, measurement results, and soft keys for setting up various parameters.

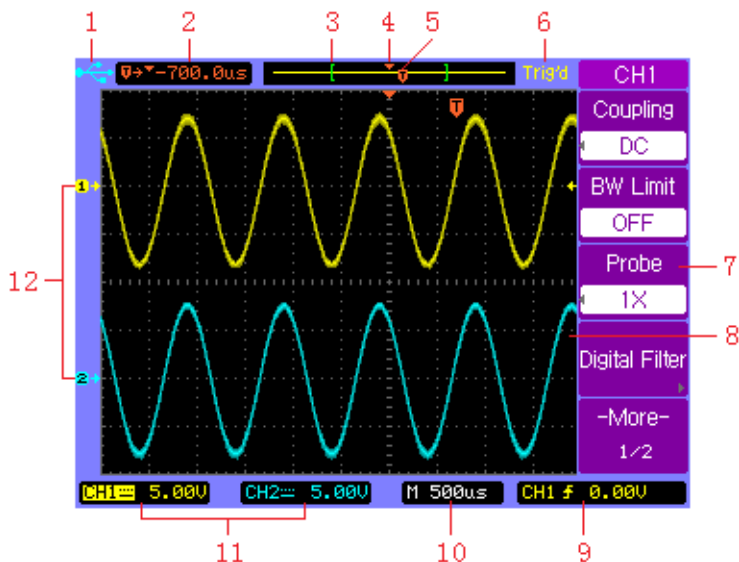

1. The USB icon appears when a USB drive is inserted into the front USB device port and ready to be used. When instrument is in remote mode, it will display “Rmt” indicator instead.
2. Readout showing the trigger position relative to the horizontal center of the screen.

Getting Started

3. The square brackets show the location of current display window within the whole captured waveform. The captured waveform color corresponds with the active waveform color (CH1: yellow; CH2: cyan).
4. Horizontal center position icon shows the horizontal center location within the captured waveform.
5. Trigger position icon shows the trigger location within the record waveform.
6. Acquisition status:
 - AUTO – “Auto” mode.
 - STOP – Stop acquiring waveform data.
 - WAIT – Waiting to be triggered.
 - Trig’d – DSO has seen a trigger and is acquiring post-trigger data.
 - Trig? – Looking for trigger
 - ROLL – When horizontal mode is set to “Roll”
7. Soft key menu which allows you to set up additional parameters from front-panel soft keys.
8. The display area contains the waveform acquisitions, channel identifiers, trigger and ground level indicators. Each channel’s information appears in their respective color.
9. Trigger readout shows trigger information such as trigger source, trigger type as well as trigger level.

Getting Started

10. Horizontal readout shows the Main or Delayed time base.
11. Channel readouts show the scale factor, coupling, bandwidth limit, digital filter, and invert status.
12. Waveform baseline icons show the zero-volt level of the waveforms. The icon colors correspond to the waveform colors.

1.5 Quick Check

Upon receiving the instrument, inspect for any noticeable physical damages or unresponsive panel buttons. If there are any problems, please contact B&K Precision immediately.

Power On Check

Connect the AC Power Cord to the power input socket on the side of the DSO. Press down the power switch button at the top of the DSO to the ON position (). Verify that the instrument turns on and the LCD screen goes into an initial boot screen.

Getting Started

Press any key for the screen to load into the main screen showing the graticule. Contact B&K Precision if the DSO fails to load the main screen.

Basic Check

Please follow the steps below when checking the oscilloscope's functionality.

1. Power on the oscilloscope.

Press **SAVE/LOAD** and Select **Factory** to set DSO to factory settings. The probe default attenuation is 1X.

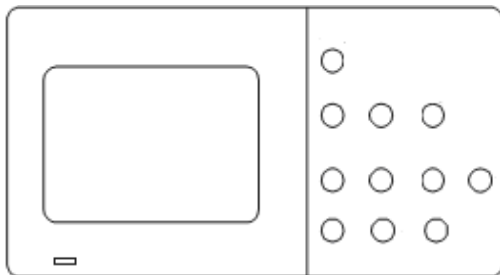

2. Set the switch to 1X on the probe and connect the probe to channel 1 on the oscilloscope. To do this, align the slot in the probe connector with the key on the CH 1 BNC, push to connect, and twist to the right to lock the probe in place. Connect the probe tip and reference lead to the probe compensation terminal.

Getting Started

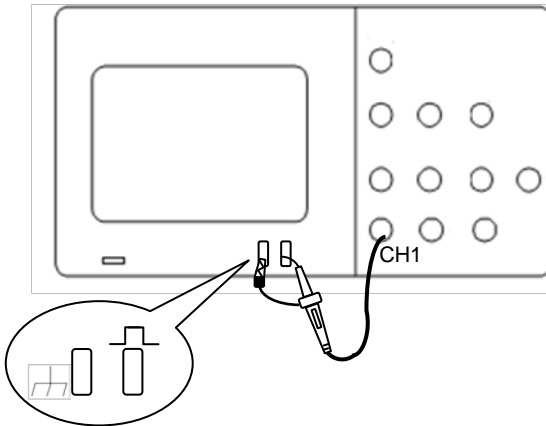

3. Press **AUTO** to show the 1 kHz frequency square wave in a few seconds.

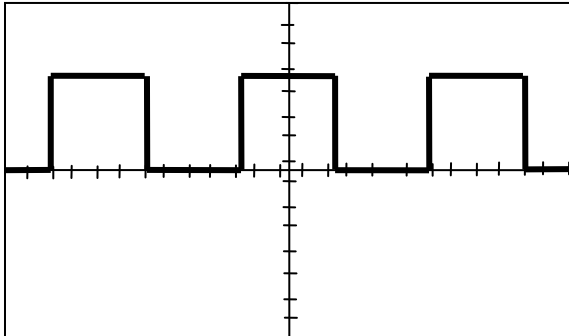

4. Press **CH1** two times to cancel the channel 1, Press **CH2** to change screen into channel 2, reset the channel 2 and repeat step 2 and step 3 for CH2.

1.6 Probe Safety

A guard around the probe body provides a finger barrier for protection from electric shock.

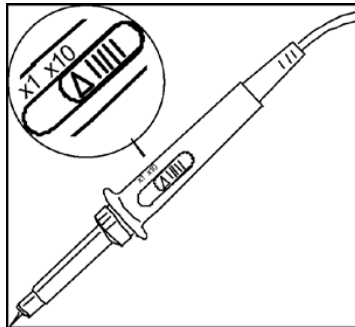

Connect the probe to the oscilloscope and connect the ground terminal to ground before you take any measurements.

Note: *To avoid electric shock when using the probe, keep fingers behind the guard on the probe body.*

Note: *To avoid electric shock while using the probe, do not touch metallic portions of the probe head while it is connected to a voltage source. Connect the probe to the oscilloscope and connect the ground terminal to ground before you take any measurements.*

1.7 Probe Attenuation

Probes are available with various attenuation factors which affect the vertical scale of the signal.

You can push a vertical menu button (such as the **CH 1** button), and select the **Probe** option that matches the attenuation factor of your probe.

Note: *The default setting for the Probe option is 1X.*

Be sure that the attenuation switch on the probe matches the **Probe** option in the oscilloscope. The included probes can switch between 1X and 10X.

Note: *When the attenuation switch is set to 1X, the probe limits the bandwidth of the oscilloscope to 10 MHz (according to Probe spec). To use the full bandwidth of the oscilloscope, be sure to set the switch to 10X.*



1.8 Probe Compensation

Perform this adjustment to match your probe to the input channel. This should be done whenever you attach a passive

Getting Started

probe for the first time to any input channel. A poorly compensated probe can introduce measurement errors.

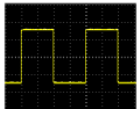
1. Set both the probe and the oscilloscope attenuation factor to X10 respectively.
2. Connect the oscilloscope probe to channel 1. Attach the probe tip and reference lead to the probe compensation terminal and to the chassis ground terminal, then press **AUTO** key.
3. Use a nonmetallic tool to adjust the trimmer capacitor on the probe for the flattest pulse possible (see “Correct compensation” image below). The trimmer capacitor is located either on the probe BNC connector or above the probe attenuation switch.

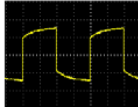
| | |
|-----------------------------|-------------------------------------------------------------------------------------|
| Correct compensation |  |
| Over compensated |  |
| Under compensated |  |

4. Connect probes to channel 2. Repeat the above steps. This matches each probe to each channel.

2 BASIC OPERATION

- Using Quick Help
- Using Auto Set
- Vertical Controls
- Horizontal Controls
- Trigger Controls
- Run Control

Basic Operation

2.1 Using Quick Help

The digital storage oscilloscope has a quick help system that provides a description of functionality for each front panel keys and soft panel keys.

Press and hold down the key or the softkey that you want to see help description for. The help information will display and remain at the center of the screen as shown below until another key is pressed or a knob is turned.

Note: *Quick help is not available for CUSTOM shortcut key. Refer to “CUSTOM Button” section for details on its usage.*



Basic Operation

If there are more than one page of help information, press the key  to browse the previous or next pages.

2.2 Using Autoset

The 2540B/2542B oscilloscopes provide an Autoset function which sets the vertical, horizontal, and trigger controls automatically for optimal display of the signal(s) connected at either or both CH1 and CH2.

Autoset function detects, turns on, and scales any channel with a repetitive waveform if it meets the following requirements:

- Frequency of at least 50Hz
- Duty cycle greater than 0.5%
- Amplitude of at least 10 mVp-p

Note: Any channels that do not meet these requirements are turned off.

When you are using more than one channel, the Autoset function sets the vertical controls for each channel and uses CH1 to set the horizontal and trigger controls.

To configure the oscilloscope quickly and automatically to see connected signals, press the  key. The oscilloscope will take a few seconds to automatically set

Basic Operation

various parameters. If signal is found, it will beep once and open the **AUTO** menu before displaying the signal. If there are no signals, no beep will occur and a display message will read “No signal is found”.

To configure the oscilloscope to display multiple cycles, press **Multi-Cycle** softkey in the **AUTO** menu.

To configure the oscilloscope to display a single cycle, press **Single Cycle** softkey in the **AUTO** menu.

To undo the effects of Autoset, press the **Undo Autoset** softkey in the **AUTO** menu before pressing any other key. This is useful when you have unintentionally pressed the **AUTO** key or do not like the settings Autoset has selected and want to return to your previous settings.

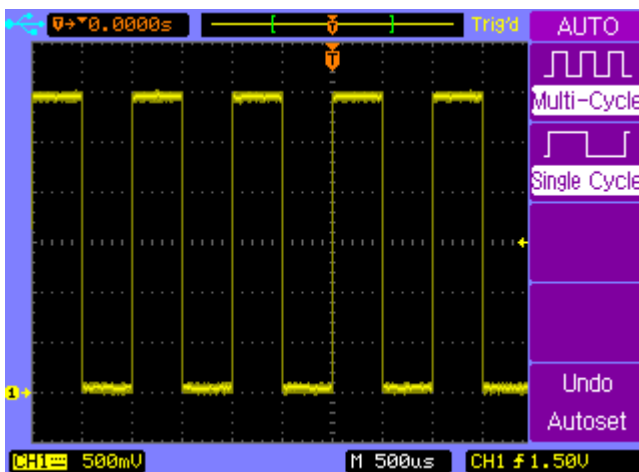

Basic Operation

Note: *Auto set function can be disabled. See “Appendix B: Disabling Auto Function” for details*

2.3 Vertical Controls

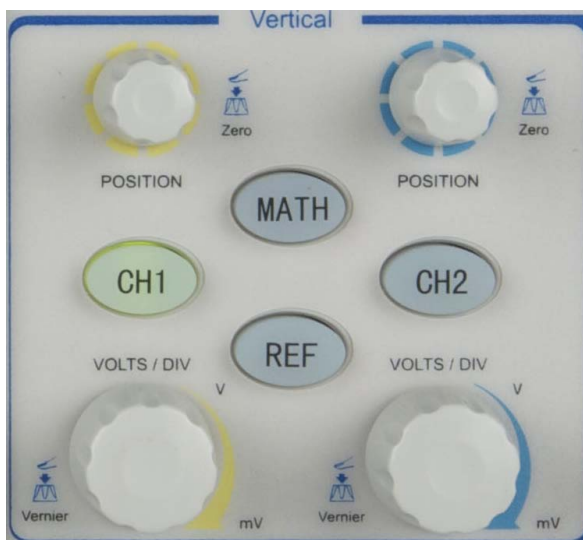

Vertical controls

Vertical Position Knob (CH1, CH2)

Turn the small vertical position knob above the channel key to move the channel's waveform and its ground level icon (\ominus) up or down on the display. The voltage value momentarily displayed (shown below) in the bottom left corner of the display represents the voltage difference between the vertical center of the display and the ground level (\ominus).

Basic Operation

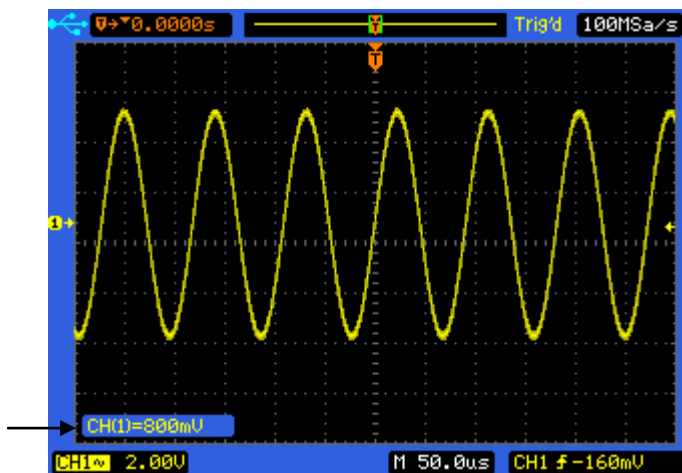

Press the vertical position knob to bring the channel's waveform and its ground level icon (↔) directly back to the vertical center of the display.

Vertical Scale Control (CH1, CH2)

Turn the large vertical scale knob below the channel key to set the scale factor for the channel. The vertical scale knob changes the channel scale in a 1-2-5 step sequence. The channel scale factor value is displayed in the bottom left portion of the display.

Press the vertical scale knob to toggle between Fine and Coarse control. When fine is selected, you can change the channel's vertical sensitivity in smaller resolution. When

Basic Operation

coarse is selected, the vertical scale knob changes the channel scale in a 1-2-5 step sequence.

Channel Keys **CH1**, **CH2**

Press the channel key from the front panel to display the channel's menu and turn the display of the channel on or off. The channel is displayed when the key is illuminated.

The channel menu of a channel must be displayed first before you can turn off the channel. For example, suppose CH1 and CH2 are both displayed and the **CH2** menu is also displayed. In order to turn **CH1** off, you should press the **CH1** key first to show **CH1** menu on the display, then press **CH1** key again to turn off **CH1**.

CH1, CH2 Menu

Press the channel key **CH2** to display the channel's menu and turn on the channel display.

Channel Coupling

Press the channel key **CH2**, then press the **Coupling** softkey to select AC coupling mode.

AC coupling places a high pass filter in series with the input signal that blocks the DC component of the input signal. AC coupling is useful for viewing waveforms with large DC offsets.

Basic Operation

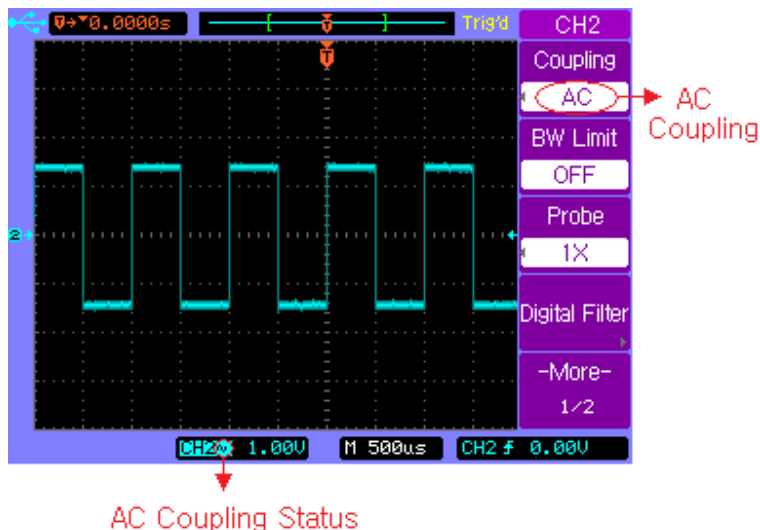

AC Coupling

Press the channel key **CH2**, then press the **Coupling** softkey again to select DC coupling mode.

DC coupling passes both AC and DC components of the input signal. DC coupling is useful for viewing low frequency waveforms that do not have large DC offsets.

Basic Operation

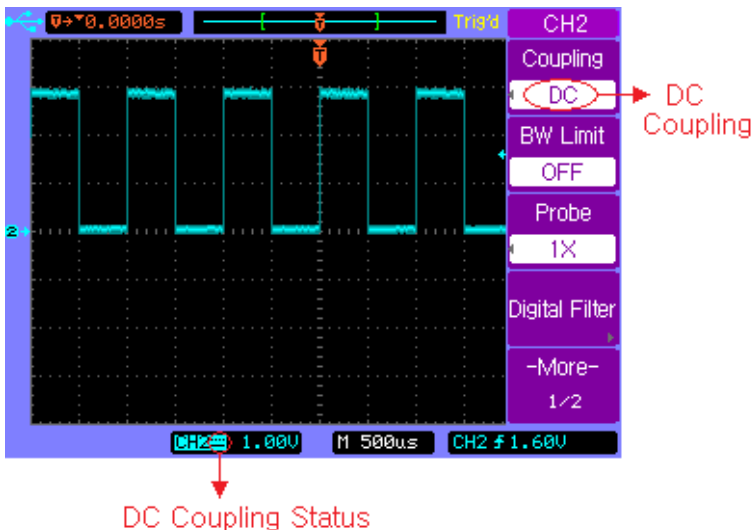

DC Coupling

Press the channel key **CH2**, then press the **Coupling** softkey until GND coupling is selected.

GND mode blocks both AC and DC components of the input signal and connect the input to the ground level.

Basic Operation

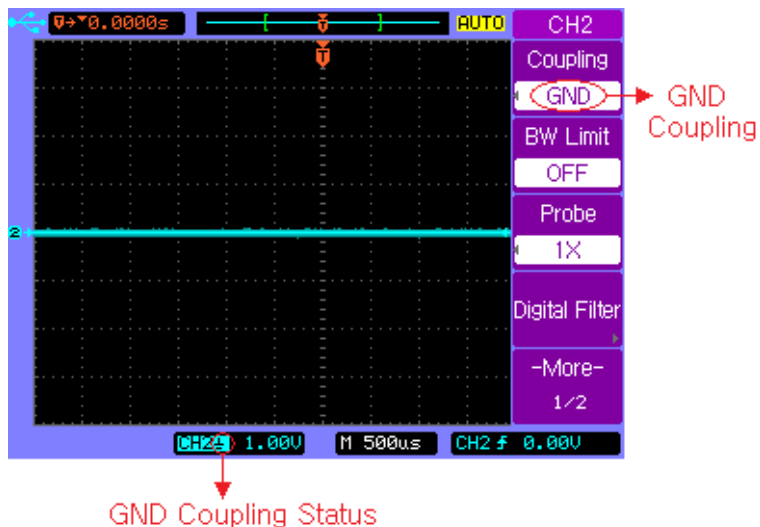

GND Coupling

BW Limit

Press the channel key **CH2**, then press the **BW Limit** softkey to turn the bandwidth limit on or off for the selected channel 2. When it is off, it passes both the high and low frequency components.

Basic Operation

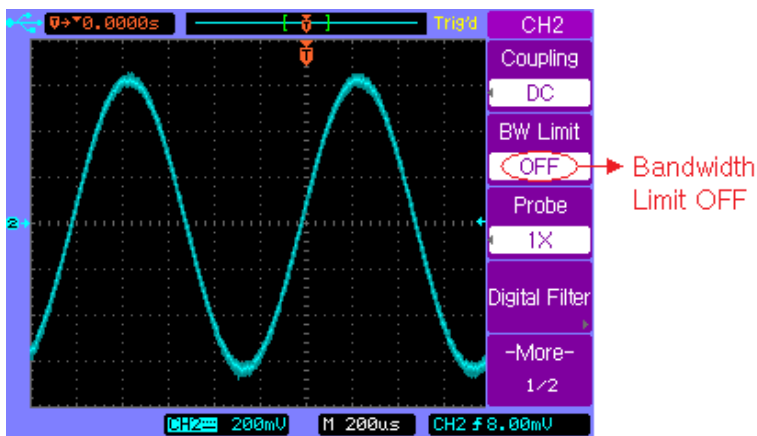

BW Limit off

When it is on, the maximum bandwidth for the channel is approximately 20 MHz. For waveforms with frequencies below this, turning bandwidth limit on removes unwanted high frequency noise from the waveform.

Basic Operation

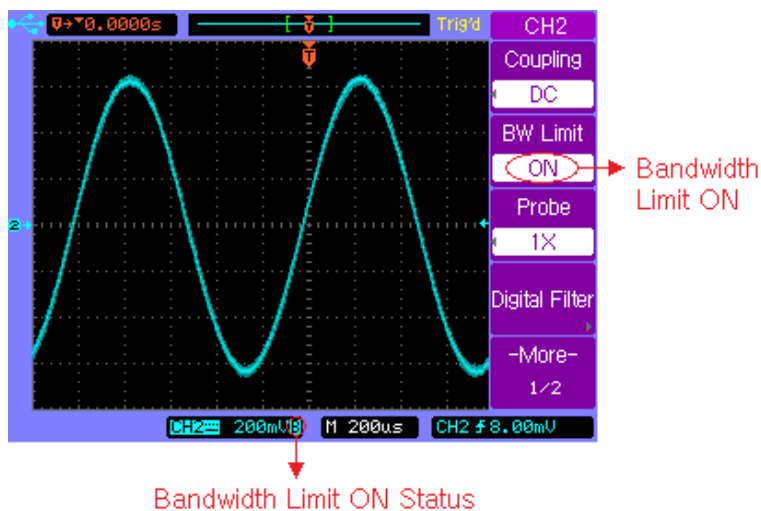

BW Limit on

Basic Operation

Probe Attenuation Setting

Probes are available with various attenuation factors which affect the vertical scale of the signal. You can manually select the factor that matches the attenuation of your probe.

For example, to match a probe set to 10X connected to CH2, press the channel key **CH2**, and then press the **Probe** softkey and select 10X.

Press the **Probe** softkey again and select 1X when a probe with 1:1 attenuation factor is connected to CH2.

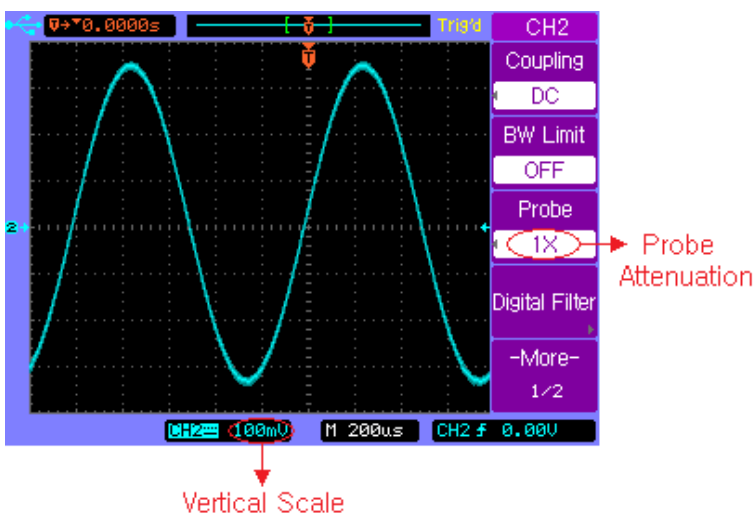





Set Probe Attenuation Factor to 1X

Basic Operation

Digital Filter

Each channel has built-in digital filters that can be applied to the connected signal.

Press the channel key **CH1**, then press the **Digital Filter** softkey to display the **FILTER-CH1** menu. Four kinds of filter types are available:

1.  Low pass filter
2.  High pass filter
3.  Band pass filter
4.  Band block filter

Press the **Upper Limit** or **Lower Limit** softkey and then adjust the Entry knob  to set the high and/or low frequency range for the filter.

Basic Operation

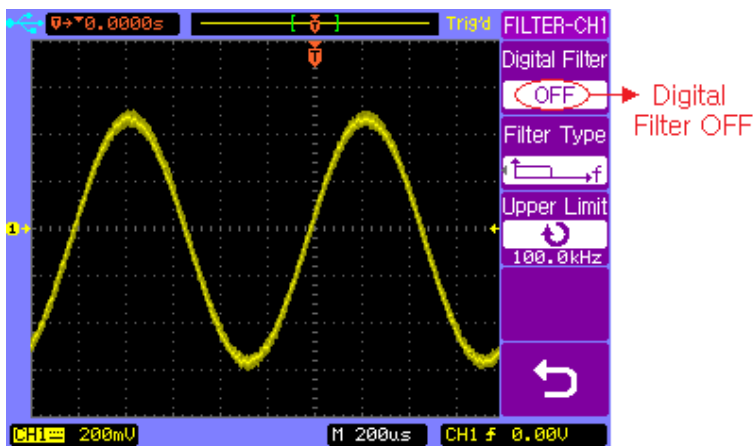

Digital Filter is off

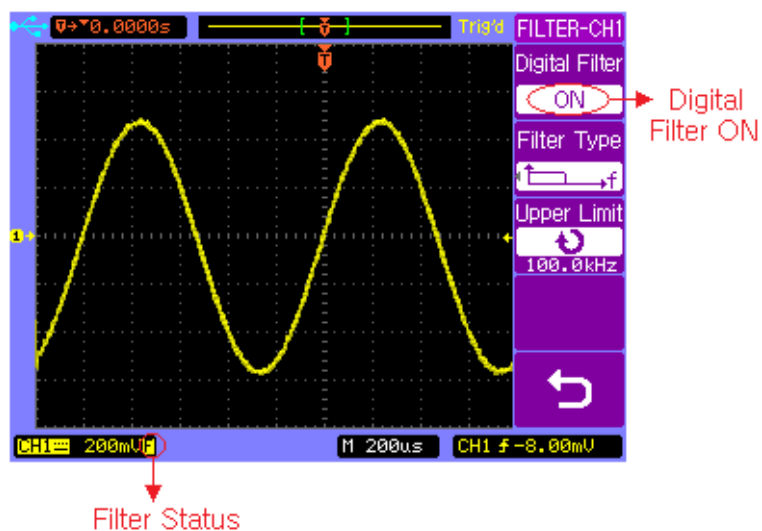

Digital Filter is on

Basic Operation

Vertical Scale

Turn the large vertical scale knob below the channel key to set the scale factor for the channel. The channel scale factor value is displayed in the bottom left portion of the display.

Press **CH2** → **More 1/2** → **Volts Scale** to select **Coarse** or **Fine** adjustment. You can also press the large vertical scale knob to toggle between **Fine** and **Coarse**. When Coarse is selected, the vertical scale knob changes the channel scale in a 1-2-5 step sequence. When Fine is selected, the vertical scale knob changes the channel scale in a smaller resolution.

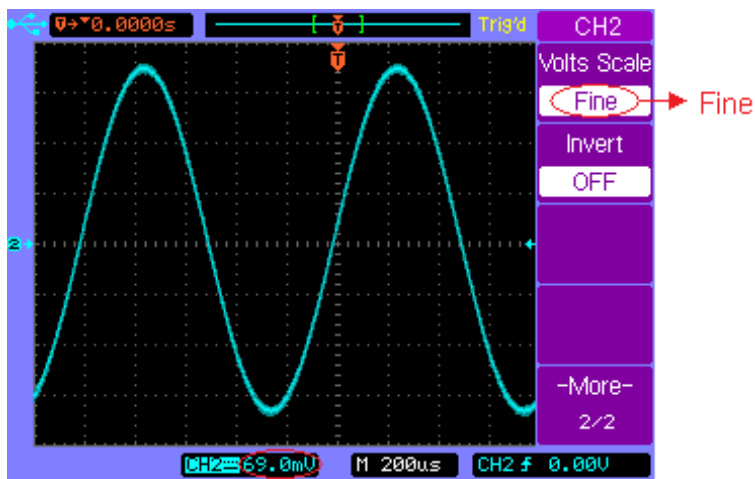

Fine Vertical Scale

Basic Operation

Vertical Invert

Press **CH2** → **More 1/2** → **Invert** to set Invert on or off. When Invert is turned on, the voltage values of the displayed waveform are inverted. Invert affects how a channel is displayed, but does not affect triggering. If the oscilloscope is set to trigger on a rising edge, it remains set to trigger on the same edge after the channel is inverted.

Inverting a channel will also change the result of any math function selected in the **MATH** menu or any measurement.

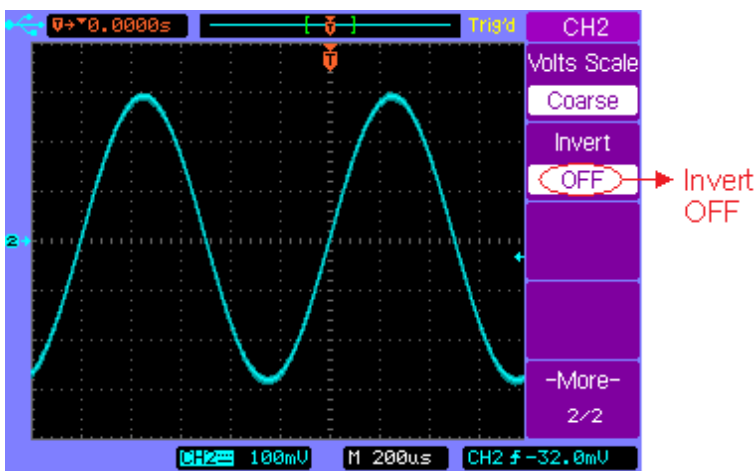

Vertical Invert off

Basic Operation

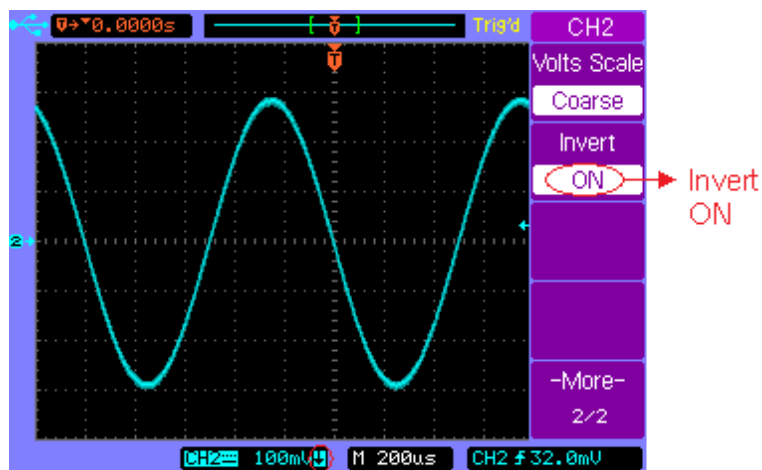

Inversion Status

Vertical Invert on

Basic Operation

MATH Functions







Dual Waveform Calculation

Press **MATH** channel key to turn on the **MATH** menu, page 1/2.

| | | | |
|----------------------------------------------------------------------------------------------------------------------------------------------------------------------------------------------------------------------------------------------------------------------------------------------------------------------------------------------------------------------------------------------------------------------------------------------------------------------------------------------------------------------------------------------------------------------------------------------------------------------------------------------------------------------------------------------------------------------------------------------------------------------------------------------------------------------------------------------------------------------------------------------------------------|-----------------|-----------------|------------------------|
| <div style="background-color: #800080; color: white; padding: 2px;">MATH</div> <div style="background-color: #800080; color: white; padding: 2px;">Operate</div> <div style="background-color: #800080; color: white; padding: 2px;">A+B</div> <div style="background-color: #800080; color: white; padding: 2px;">Source A</div> <div style="background-color: #800080; color: white; padding: 2px;">CH1</div> <div style="background-color: #800080; color: white; padding: 2px;">Source B</div> <div style="background-color: #800080; color: white; padding: 2px;">CH2</div> <div style="background-color: #800080; color: white; padding: 2px;">Invert</div> <div style="background-color: #800080; color: white; padding: 2px;">OFF</div> <div style="background-color: #800080; color: white; padding: 2px;">-More-</div> <div style="background-color: #800080; color: white; padding: 2px;">1/2</div> | Softkey | Options | Description |
| | Operate | A+B | Add A and B |
| | | A-B | Subtract B from A |
| | | A X B | Multiply A by B |
| | | FFT | Access FFT menu |
| | Source A | CH1 | Select CH1 as Source A |
| | | CH2 | Select CH2 as Source A |
| | Source B | CH1 | Select CH1 as Source B |
| | | CH2 | Select CH2 as Source B |
| | Invert | ON | Math invert ON |
| OFF | | Math invert OFF | |
| More 1/2 | ---- | Select page 2/2 | |

Basic Operation

Press softkey **More 1/2** to display **MATH** menu page 2/2.

| MATH | Softkey | Options | Description |
|-----------------------------------------------------------------------------------|-----------------------------------------------------------------------------------|-----------------------------------------------------------------------------------|-----------------------------------------------|
| Operate | Operate | A+B | Add A and B |
| A+B | | A-B | Subtract B from A |
|  | | A X B | Multiply A by B |
|  | | FFT | Access FFT menu |
| Display Mode |  |  | Vertical scale control |
| Full Screen |  |  | Vertical position control |
| -More- 2/2 | Display Mode | Split Screen | Split the display into Main and Math sections |
| | | Full Screen | Display Math waveform in full screen |
| | More 2/2 | ---- | Select page 1/2 |

Basic Operation

Example:

Select the A+B math function, then select CH1 as the Source A, and select CH2 as the Source B. The resulting math waveform will look like below:

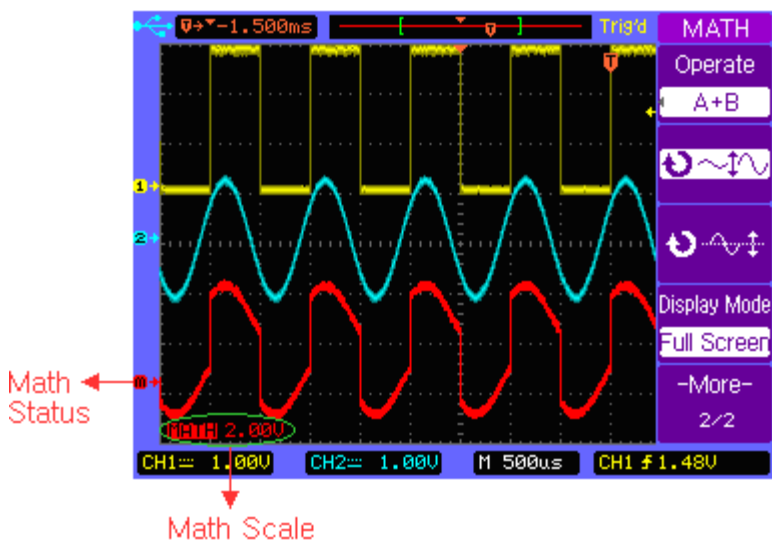

Math A+B

Basic Operation

FFT Spectrum Analysis





You can use the FFT function to measure harmonic components and distortion in systems, to characterize noise in DC power supplies, and to analyze vibration.

Press **MATH** channel key to turn on the **MATH** menu page 1/2, and then press **Operate** softkey to select FFT. The **FFT** menu page 1/2 will be displayed.

| | Softkey | Options | Description |
|-----------------|----------------|---------------------------|------------------------|
| | Operate | A+B | Add A and B |
| | | A-B | Subtract B from A |
| | | A X B | Multiply A by B |
| | | FFT | Access FFT menu |
| | Source | CH1 | Select CH1 for FFT |
| | | CH2 | Select CH2 for FFT |
| | Window | Rectangular | Use Rectangular window |
| | | Hanning | Use Hanning window |
| | | Hamming | Use Hamming window |
| | | Blackman | Use Blackman window |
| Flattop | | Use Flattop window | |
| Scale | dBV RMS | Vertical scale in dBV RMS | |
| | V RMS | Vertical scale in V RMS | |
| More 1/2 | ---- | Select page 2/2 | |

Basic Operation

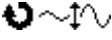
Press softkey **More 1/2** to display **FFT** menu page 2/2.

| FFT | Softkey | Options | Description |
|-----------------------------------------------------------------------------------|---------------------|-----------------------------------------------------------------------------------|-----------------------------------------------|
| Operate | Operate | A+B | Add A and B |
| FFT | | A-B | Subtract B from A |
|  | | A X B | Multiply A by B |
|  | | FFT | Access FFT menu |
| Display Mode | Display Mode |  | Vertical scale control |
| Full Screen | |  | Vertical position control |
| -More- 2/2 | | Split Screen | Split the display into Main and Math sections |
| | | Full Screen | Display Math waveform in full screen |
| | More 2/2 | ---- | Select page 1/2 |

Basic Operation

Example:

Select CH1 as the **Source** for FFT, select Rectangular **Window**, set **Scale** to dBV RMS, and then the FFT waveform will look like below. You can also measure the amplitude and frequency of the corresponding point with the manual cursors (See “CURSOR Menu”).

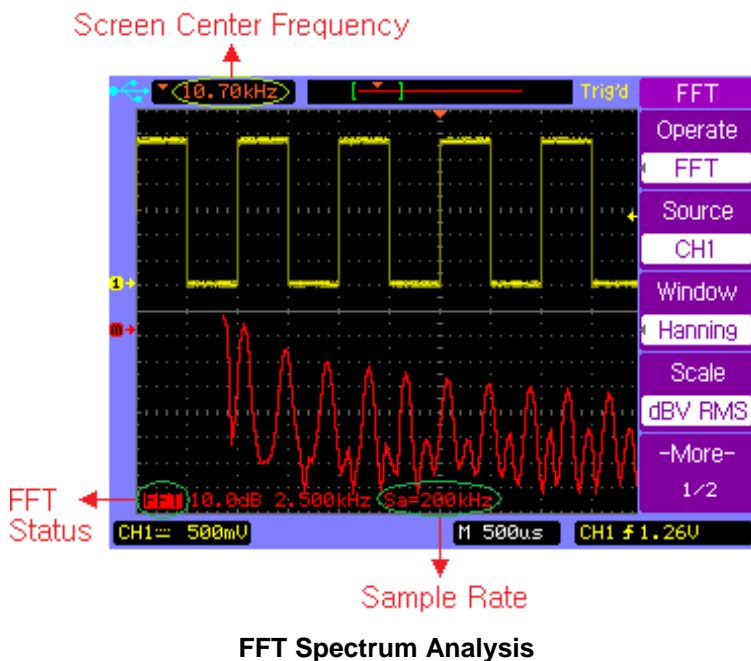





Basic Operation

REF Function

The REF function allows users to store and recall a waveform as a reference. This is useful for comparing and analyzing signals from different systems.

Press **REF** channel key to turn on the **REF** menu, page 1/2.

| | Softkey | Options | Description |
|-----------------------------------------------------------------------------------|-----------------------------------------------------------------------------------|-----------------------------------------------------------------------------------|-------------------------------|
|  | Source | CH1 | Save CH1 as reference |
| | | CH2 | Save CH2 as reference |
| |  |  | REF vertical scale control |
| |  |  | REF vertical position control |
| | Volts Scale | Coarse | Coarse vertical scaling |
| | Scale | Fine | Fine vertical scaling |
| | More 1/2 | ---- | Select page 2/2 |

Basic Operation



Press softkey **More 1/2** to display **REF** menu, page 2/2.

| | | | |
|------------------|-------------------------|----------------|------------------------------------------------------------|
| REF | Softkey | Options | Description |
| Invert | Invert | ON | REF invert ON |
| OFF | | OFF | REF invert OFF |
| Internal Storage | Internal Storage | INTERNAL menu | Save the reference waveform to the internal memory |
| External Storage | External Storage | EXTERNAL menu | Save the reference waveform to the USB mass storage device |
| -More- 2/2 | More 2/2 | ---- | Select page 1/2 |

Press **REF** channel key to turn on the **REF** menu page 1/2, press softkey **More 1/2** to display **REF** menu page 2/2. Load the latest saved reference waveform from the internal memory by selecting **Internal Storage** or locate and load reference waveform file from the external memory by selecting **External Storage**.

You can use the horizontal position and scale control knob to change the time base of the reference waveform.

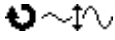
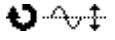
Basic Operation

Press  or  softkey and turn the Entry knob  to change the vertical scale or position of the reference waveform.

Press **REF** → **Internal Storage** → **Save** to save the waveform of the Source channel as the reference waveform to the internal memory.

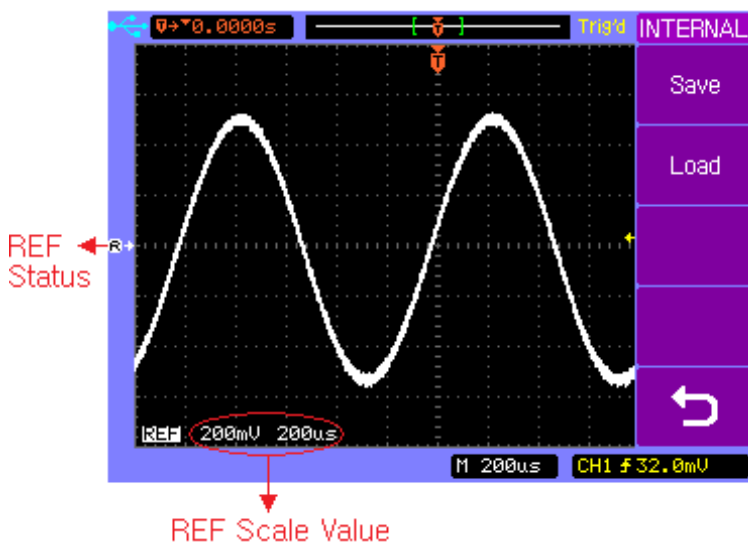

Save a Reference waveform

Note: *The reference waveform function is unavailable when X-Y mode is selected.*

Basic Operation

2.4 Horizontal Controls

Use the horizontal controls to adjust the time base, adjust the trigger location, and to examine waveform details more closely.





Horizontal Controls



Basic Operation

Horizontal Position Control

When the oscilloscope is running, this control lets you set the acquisition window relative to the trigger point. When the oscilloscope is stopped, you can turn this knob to pan through the data horizontally. This lets you see the captured waveform before the trigger or after the trigger.

The trigger position is marked with the indicator “” at the top of the graticule and also in the waveform record data icon at the top of the screen.

The small inverted triangle () is the time reference indicator. When you change the horizontal scale, the waveforms contract or expand about this point.

Press the horizontal position control knob key to set the time delay to zero, and the trigger position indicator () will move right below the time reference indicator()

Note: The horizontal position control is unavailable when X-Y horizontal mode is selected.

Horizontal Scale Control

Use the horizontal scale control to adjust the time base. The scale expands or contracts around the center of the screen. The horizontal scale factor can be set in a 1-2-5 sequence.

Basic Operation

Press the horizontal scale control knob to toggle between Main and Delayed horizontal display mode.

Horizontal **MENU** key

Press the horizontal **MENU** key to display the **HORIZONTAL** menu. This menu lets you select the horizontal mode: **Main**, **Delayed**, **Roll**, or **X-Y**.

Press the horizontal **MENU** key to display the **HORIZONTAL** menu page 1/2.

| HORIZONTAL | Softkey | Options | Description |
|---------------|-----------------------|---------|---------------------|
| Main ✓ | Main | √ | Main mode is ON |
| | | ---- | Main mode is OFF |
| Delayed | Delayed | √ | Delayed mode is ON |
| | | ---- | Delayed mode is OFF |
| X-Y | X-Y | √ | X-Y mode is ON |
| | | ---- | X-Y mode is OFF |
| Roll | Roll | √ | Roll mode is ON |
| | | ---- | Roll mode is OFF |
| -More- 1/2 | -More- 1/2 | ---- | Select page 2/2 |

Basic Operation

Press softkey **More 1/2** to display the **HORIZONTAL** menu page 2/2.

| HORIZONTAL | Softkey | Options | Description |
|-------------|--------------------|---------|------------------------------|
| Trig-Offset | Trig-Offset | ---- | Reset the delay time to zero |
| Reset | Reset | ---- | |
| -More- | -More- | ---- | Select page 1/2 |
| 2/2 | 2/2 | ---- | |
| -More- | | | |
| 2/2 | | | |

Main - Horizontal Mode

Main horizontal mode is the normal viewing mode for the oscilloscope. When the oscilloscope is stopped, you can use the horizontal controls to pan and zoom the waveform. When the oscilloscope is running in Main mode, use the horizontal scale knob to change horizontal scale factor and use the horizontal position knob to set the delay time. The time base (second/division) value is displayed at the bottom of the screen.

Press the horizontal **MENU** key and then press the **Main** softkey to select the main horizontal mode.

Basic Operation

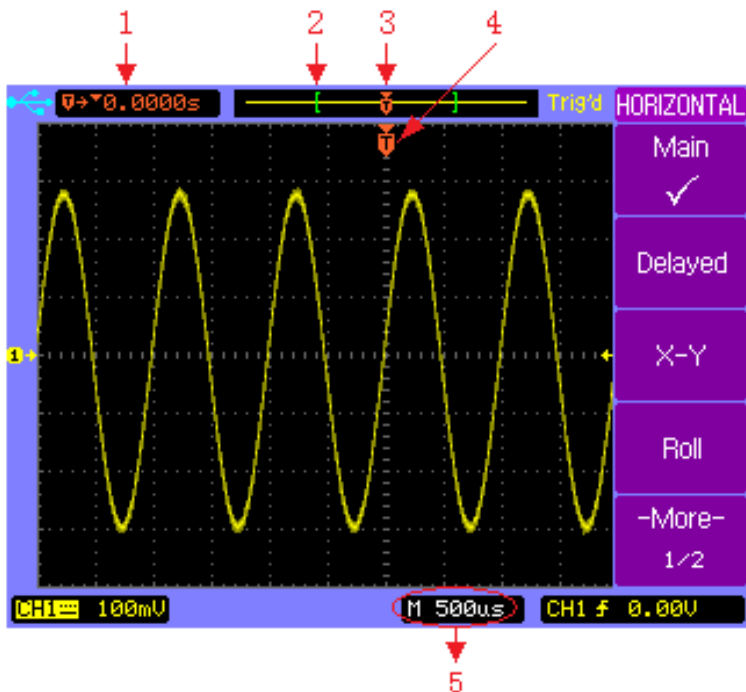

Main Horizontal Mode

1. Readout shows the delay time or the trigger location within the record data relative to the time reference point (∇).
2. The square brackets show the location of current display window within the record data.
3. Trigger position within the record data.
4. Trigger position on the current waveform display window.
5. Main time base.

Basic Operation

Delayed - Horizontal Mode

Delayed horizontal mode is an expanded version of main mode. When Delayed mode is selected, the display divides in half. The top half of the display shows the normal waveform and bottom half displays the delayed waveform.

Delayed waveform is a magnified portion of the normal waveform. You can use delayed waveform to locate and horizontally expand part of the normal waveform for a more detailed analysis of signals.

The area of the normal display that is expanded is marked on each end with a vertical shaded area. The unshaded area shows what portion of the normal waveform is expanded in the lower half.

To change the time base for the delayed window, turn the horizontal scale knob. As you turn the knob, the time base for the delayed window is displayed just above the main time base.

To change the time base for the normal window, press the **Main** softkey, then turn the horizontal scale control knob.

Connect a triangle signal source to CH1, press the horizontal **MENU** key and then press the **Delayed** softkey to enter the Delayed mode. You can also press the horizontal scale

Basic Operation

control knob key to toggle between Main and Delayed mode directly.

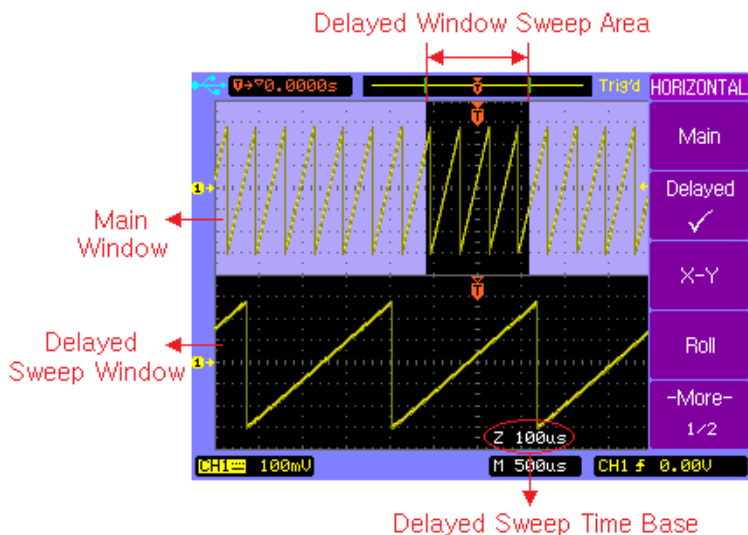

Delayed Horizontal Mode

Basic Operation

X-Y *Horizontal Mode*

X-Y mode changes the display from a volts-versus-time display to a volts-versus-volts display. The time base is turned off. CH1 amplitude is plotted on the X axis and CH2 amplitude is plotted on the Y axis.

You can use X-Y mode to compare frequency and phase relationships between two signals. X-Y mode can also be used with transducers to display strain versus displacement, flow versus pressure, voltage versus current, or voltage versus frequency.

In order to get a better view of the waveform, proper vertical scale should be selected before selecting the X-Y mode.

Use X-Y mode to compare two signals with the same frequency and different phase. Connect the two signal to CH1 and CH2 respectively. Press horizontal **MENU** key and then **X-Y** softkey to select X-Y mode.

Basic Operation

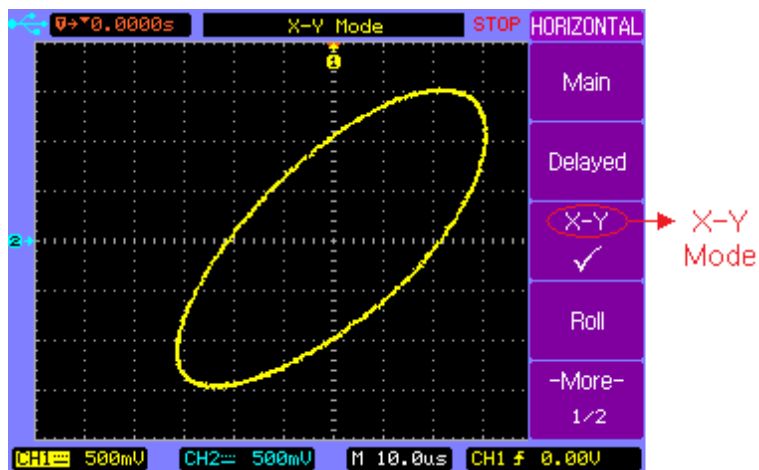

X-Y Horizontal Mode

Basic Operation

Roll - Horizontal Mode

Roll mode causes the waveform to move slowly across the screen from right to left.

Note: *It only operates on time base settings of 500 ms/div or slower. If the current time base setting is faster than the 500 ms/div limit, it will be set to 500 ms/div when Roll mode is selected.*

In Roll mode there is no trigger. The fixed reference point on the screen is the right edge of the screen and refers to the current moment in time. Events that have occurred are scrolled to the left of the reference point. Since there is no trigger, no pre-trigger information is available.

If you would like to pause the display after a full screen of acquisition in Roll mode, press the **SINGLE** key. To clear the display and restart another full screen acquisition in Roll mode, press the **SINGLE** key again.

Press the horizontal **MENU** key and then press the **Roll** softkey to select the Roll mode. The waveform will move slowly across the screen from right to left.

The fastest time base is 500 ms in roll mode.

Basic Operation

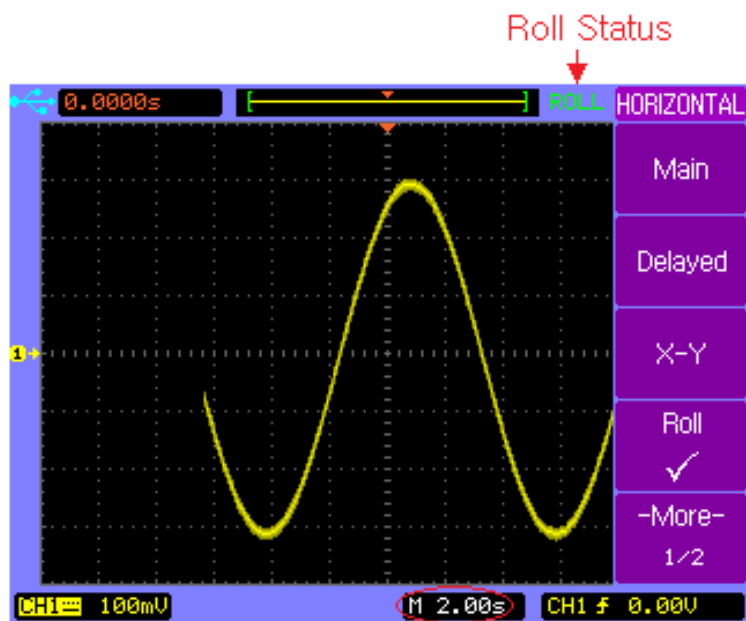

Horizontal Time Base

Roll Horizontal Mode

2.5 Trigger Controls

The trigger controls determine when the oscilloscope starts to acquire and display the waveform. When a trigger is found, the oscilloscope will acquire sufficient data to display the waveform.

Note: Trigger controls are functional when the oscilloscope works under Main or Delayed horizontal mode.



Trigger Controls

Basic Operation

Trigger Control **MENU** key

Press the trigger control **MENU** key to show the **TRIGGER** menu and then press the **Type** softkey to select Edge, Pulse or Video.

Set to 50% key

Press the **50%** key to set the trigger level to the 50% amplitude level of the trigger source waveform.

Force Trigger key

Press the **FORCE** key to force an immediate trigger event, even in the absence of a signal. This function is useful in following situations:

If you do not see a waveform on the screen when using Normal trigger mode, press the **FORCE** key to acquire the signal baseline to verify that it is on the screen.

After you press the **SINGLE** key to set up for a single shot acquisition, you can press the **FORCE** key to test and verify the control settings.

Trigger Level Control

Use the trigger level control knob to adjust the trigger level. When you change the trigger level, a horizontal red line temporarily appears to show you the level position on screen.

Basic Operation

After the line disappears, the trigger level is marked with a small left arrow.

Auto and Normal Trigger Modes

Press the trigger **MENU** key to display the **TRIGGER** menu and press the **Mode** softkey to select Auto or Normal trigger mode.

Auto mode

Use the auto trigger mode for signals other than low-repetitive-rate signals and for unknown signal levels. To display a DC signal, you must use Auto trigger mode since there is no edge to trigger on.

When you press **RUN/STOP** key to start acquiring, the oscilloscope first fill the pre-trigger buffer. It starts to search for a trigger after the pre-trigger buffer is filled, and continues to flow data through this buffer while it searches for the trigger. While searching for the trigger, the oscilloscope overflows the pre-trigger buffer; the first data put into the buffer is the first pushed out. When a trigger is found, the pre-trigger buffer will contain the events that occurred just before the trigger. If no trigger is found, the oscilloscope generates a trigger and displays the data as though a trigger had occurred. In this case, the background of the Auto indicator at the top of the

Basic Operation

display will flash, indicating that the oscilloscope is force triggered.

When you press the **SINGLE** key, the oscilloscope will fill the pre-trigger buffer, and continue to flow data through the pre-trigger buffer until the Auto trigger overrides the search and forces a trigger. At the end of the trace, the oscilloscope will stop and display the results.

Normal mode

Use Normal trigger mode for low repetitive-rate signals or when Auto trigger is not required.

In Normal mode the oscilloscope must fill the pre-trigger buffer with data before it will begin searching for a trigger event. While searching for the trigger, the oscilloscope overflows the pre-trigger buffer; the first data put into the buffer is the first pushed out.

When the trigger event is found, the oscilloscope will fill the post-trigger buffer and display the results. If the acquisition was initiated by **RUN/STOP**, the process repeats. If the acquisition was initiated by **SINGLE**, then the acquisition stops.

In either Auto or Normal mode, the trigger may be missed if the oscilloscope's pre-trigger buffer is not full yet.

Basic Operation

Holdoff Function

Holdoff sets the amount of time that the oscilloscope will wait before re-initializing the trigger circuit. You can use the holdoff function to stabilize the display of complex waveforms.

With the holdoff function, you can synchronize triggers. The oscilloscope will trigger on one edge of the waveform, and ignore further edges until the holdoff time is up. The oscilloscope will then re-initialize the trigger circuit to wait for the next edge trigger. This allows the oscilloscope to trigger on a repeating pattern in a waveform.

Turn the Entry knob  to increase or decrease the trigger hold off time shown in the **Holdoff** softkey.

To get a stable trigger on the pulse burst shown on the screen, set the holdoff time to be slightly less than the period of the pulse burst.

Basic Operation

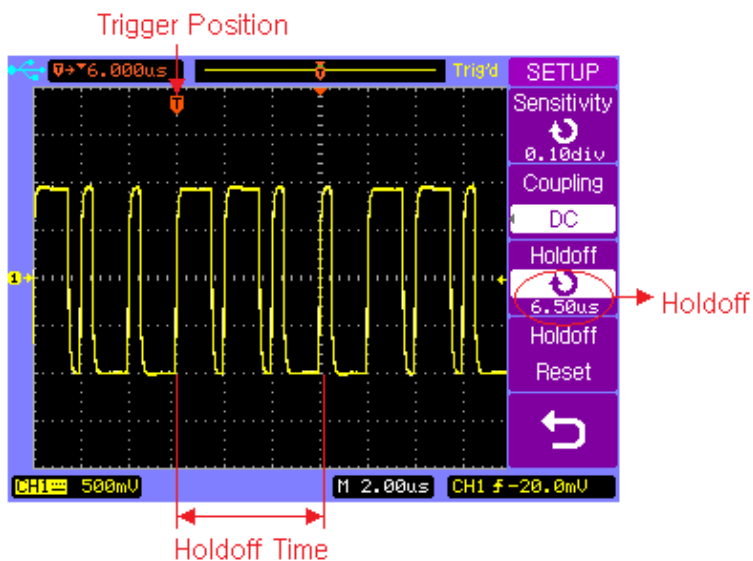



Basic Operation

Edge Trigger

Use the Edge triggering to trigger on the rising or falling edge of the input signal at the trigger threshold.

Press trigger control **MENU** key to display the **TRIGGER** menu, then press **Type** softkey to select Edge trigger.

Basic Operation









| | | | |
|-----------------------------------------------------------------------------------|-----------------------------------------------------------------------------------|-----------------------------------------------------------------------------------|------------------------------------|
| TRIGGER | Softkey | Options | Description |
| Type | Type | Video | Video triggering |
| Edge | | Edge | Edge triggering |
| Source | | Pulse | Pulse width triggering |
| CH1 | Source | CH1 | Trigger on CH1 |
| Slope | | CH2 | Trigger on CH2 |
|  | | EXT | Trigger on EXT |
| Mode | | EXT/5 | Trigger on EXT/5 |
| Auto | | AC Line | Trigger on AC line signal |
| Trigger Setup | | Alternating | Trigger on CH1 and CH2 alternately |
| Slope |  | Rising edge of a signal | |
| | |  | Falling edge of a signal |
| Mode | Auto | Trigger even without a valid event | |
| | Normal | Trigger only on a valid event | |
| Trigger Setup | ---- | Select trigger SETUP menu. | |

Basic Operation

Pulse Width Trigger

Pulse width triggering sets the oscilloscope to trigger on a positive or negative pulse of a specified width from 20 ns to 10 s.

Press trigger control **MENU** key to display the **TRIGGER** menu page 1/2, then press **Type** softkey to select Pulse trigger.

| | | | |
|--------------------------------------------------------------------------------------------------------------|-------------------------------------------------------------------------------------|-----------------------|-------------------------|
| TRIGGER | Softkey | Options | Description |
| Type | Type | Video | Video triggering |
| Pulse | | Edge | Edge triggering |
| Source | | Pulse | Pulse width triggering |
| CH1 | Source | CH1 | Trigger on CH1 |
| Pulse Mode | | CH2 | Trigger on CH2 |
|  | | EXT | Trigger on EXT |
| Pulse Setup | | EXT/5 | Trigger on EXT/5 |
|  1.00us -More- 1/2 | | Alternating | CH1 and CH2 alternately |
| Pulse Mode |  | Positive greater than | |
| |  | Positive equal | |
| |  | Positive within | |
| |  | Positive less than | |
| |  | Negative greater than | |
| |  | Negative equal | |
| |  | Negative within | |

Basic Operation

| | | |
|--------------------|------|---------------------|
| | ⏪ | Negative less than |
| Pulse Setup | ↻ | Set the pulse width |
| More 1/2 | ---- | Select page 2/2 |

Press trigger control **MENU** key to display the **TRIGGER** menu, press **Type** softkey to select Pulse trigger and then press the **More 1/2** softkey to display **TRIGGER** menu page 2/2.



| TRIGGER | Softkey | Options | Description |
|---------------|----------------------|---------|------------------------------------|
| Type | Type | Video | Video triggering |
| Pulse | | Edge | Edge triggering |
| Mode | | Pulse | Pulse width triggering |
| Auto | Mode | Auto | Trigger even without a valid event |
| Trigger Setup | | Normal | Trigger only on a valid event |
| -More- 2/2 | Trigger Setup | ---- | Select trigger SETUP menu |
| | More 2/2 | ---- | Select page 1/2 |

Basic Operation

Video Trigger

Choose video triggering to trigger on the odd fields, even fields, or on all the lines of a NTSC or PAL/SECAM video signal.

Press trigger control **MENU** key to display the **TRIGGER** menu, then press **Type** softkey to select Video trigger.

| | | | |
|-----------------------------------------------------------------------------------|-----------------|-------------------------------------------------------------------------------------|------------------------------------|
| TRIGGER | Softkey | Options | Description |
| Type | Type | Video | Video triggering |
| Video | | Edge | Edge triggering |
| Source | | Pulse | Pulse width triggering |
| CH1 | Source | CH1 | Trigger on CH1 |
| Polarity | | CH2 | Trigger on CH2 |
|  | | EXT | Trigger on EXT |
| Sync | | EXT/5 | Trigger on EXT/5 |
| Line # No. 6 | | Alternating | Trigger on CH1 and CH2 alternately |
| -More- | Polarity |  | Positive polarity |
| 1/2 | |  | Negative polarity |
| | Sync | Odd Field | Trigger on odd fields |
| | | Even Field | Trigger on even fields |
| | | All Lines | Trigger on all lines |
| | | Line # | Trigger on specific line |
| | More 1/2 | ---- | Select page 2/2 |

Basic Operation

Press softkey **More 1/2** to display the **TRIGGER** menu page 2/2.

| | | | |
|---------------|----------------------|----------------|------------------------------------|
| TRIGGER | Softkey | Options | Description |
| Type | Type | Video | Video triggering |
| Video | | Edge | Edge triggering |
| Standard | | Pulse | Pulse width triggering |
| NTSC | Standard | NTSC | Trigger on NTSC signal |
| Mode | | PAL/SECAM | Trigger on PAL or SECAM signal |
| Auto | Mode | Normal | Trigger only on a valid event |
| Trigger Setup | | Auto | Trigger even without a valid event |
| -More- 2/2 | Trigger Setup | ---- | Select trigger SETUP menu |
| | More 2/2 | ---- | Select page 1/2 |

Basic Operation

Press softkey **Trigger Setup** from the **TRIGGER** menu page 2/2 to display the trigger **SETUP** menu.

| SETUP | Softkey | Options | Description |
|------------------------|--------------------------|-----------|----------------------------------------------------------|
| Sensitivity 0.10div | Sensitivity | ↻ | Set the trigger sensitivity by turning the entry knob |
| Coupling DC | Coupling | AC | AC coupling |
| Holdoff 100ns | | DC | DC coupling |
| Holdoff Reset | | LF Reject | Reject low frequencies |
| ↶ | | HF Reject | Reject high frequencies |
| ↶ | Holdoff | ↻ | Set up the holdoff time between two consecutive triggers |
| ↶ | Holdoff Reset | ---- | Reset the holdoff time to default value 100 ns |
| ↶ | ↶ | ---- | Return to the TRIGGER menu |

Note: *There will be no coupling menu item when video trigger mode is selected in the trigger SETUP menu.*

Basic Operation

The following figures show the video waveforms triggered on odd fields and on a specific line 6.

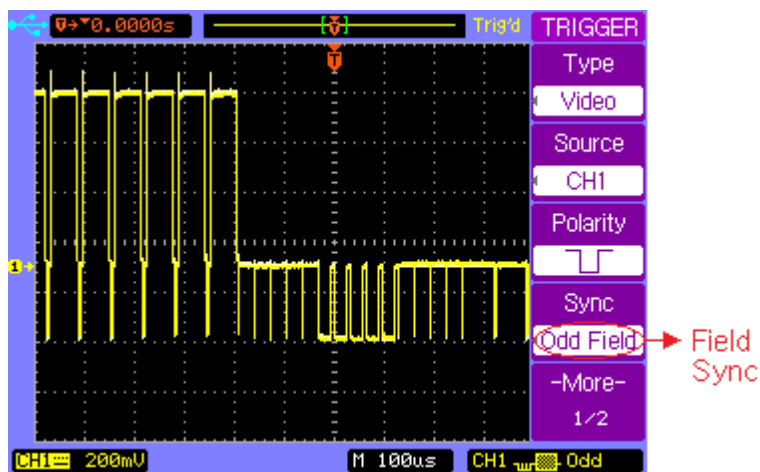

Trigger on odd fields

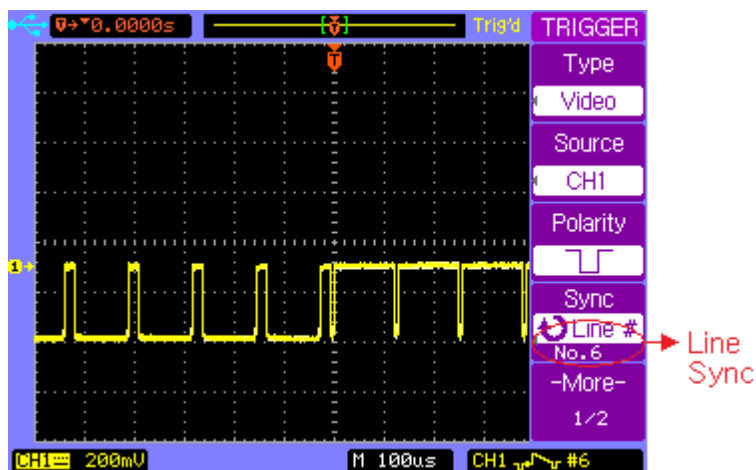

Trigger on specific line 6

2.6 RUN Controls

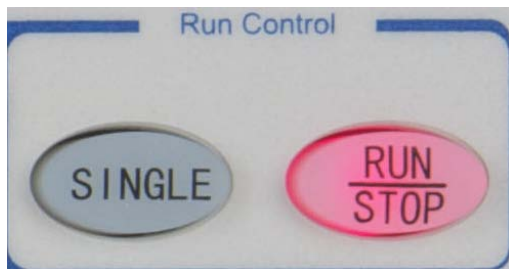

Run controls

Press the **SINGLE** key to execute a single-shot acquisition. The key will illuminate in orange until the oscilloscope is triggered.

Press the **RUN/STOP** key to make the oscilloscope start looking for a trigger. The **RUN/STOP** key will illuminate in green. When the trigger mode is set to Normal mode, the display will not update until a trigger is found. If the trigger mode is set to Auto mode, the oscilloscope looks for a trigger, and if no trigger is found, it will be triggered automatically and the waveform of input signals will be shown immediately.

Press the **RUN/STOP** key again to stop acquiring data and the **RUN/STOP** key will illuminate in red. Now you can pan across and zoom in on the acquired waveform.

3 MENU OPERATION

- Utility Menu
- Measure Menu
- Acquire Menu
- Save/Load Menu
- Cursor Menu
- Display Menu

Menu Operation

3.1 UTILITY Menu

Press the **UTILITY** menu key to show the **UTILITY** menu.

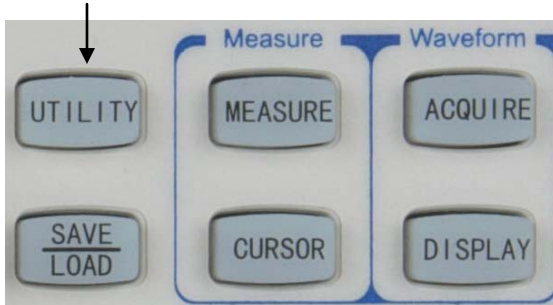

UTILITY Menu key

Menu Operation

Press the **UTILITY** key to display the **UTILITY** menu page 1/2.

| UTILITY | Softkey | Options | Description |
|--------------|---------------------|-----------|------------------------------|
| I/O Setup | I/O Setup | ---- | Select I/O SETUP menu |
| Print Setup | Print Setup | ---- | Select PRINT menu |
| System Setup | System Setup | ---- | Select SYSTEM menu |
| Language | Language | 简体中文 | Simplified Chinese |
| English | | 繁體中文 | Traditional Chinese |
| -More- | | English | English language |
| 1/2 | | 한국의 | Korean language |
| | | 日本語 | Japanese language |
| | | Русский | Russian language |
| | | Français | French language |
| | | Español | Spanish language |
| | | Polski | Persian language |
| | | Português | Portuguese language |
| | More 1/2 | ---- | Select menu page 2/2 |

Menu Operation

Press the **More 1/2** softkey to display the **UTILITY** menu page 2/2.

| UTILITY | Softkey | Options | Description |
|---------------|------------------|-----------------|--------------------------------------|
| Service | Service | ---- | Select Service menu |
| Pass/Fail | Pass/Fail | ---- | Select PASS/FAIL menu |
| Self-Cal | Self-Cal | RUN/STOP | Start self-calibration |
| Fast-Cal | | AUTO | Exit self-calibration |
| Fast-Cal | Fast-Cal | ON | Fast calibrate the vertical position |
| OFF | | OFF | Turn off fast calibration |
| -More- 2/2 | More 2/2 | ---- | Select menu page 1/2 |

Self-Calibration

If you want to maximize measurement accuracy, you can perform a self-calibration.

Self-calibration uses the internally generated signals to optimize circuits that affect channel scale, offset and trigger parameters for all the divisions over the full range. Disconnect all inputs and allow the oscilloscope to warm up at least 30 minutes before performing self-calibration.

Menu Operation

Press **UTILITY** → **Self-Cal** to display the self-calibration page. Press **AUTO** key to exit the Self-Calibration, or press **RUN** key to start the self-calibration.

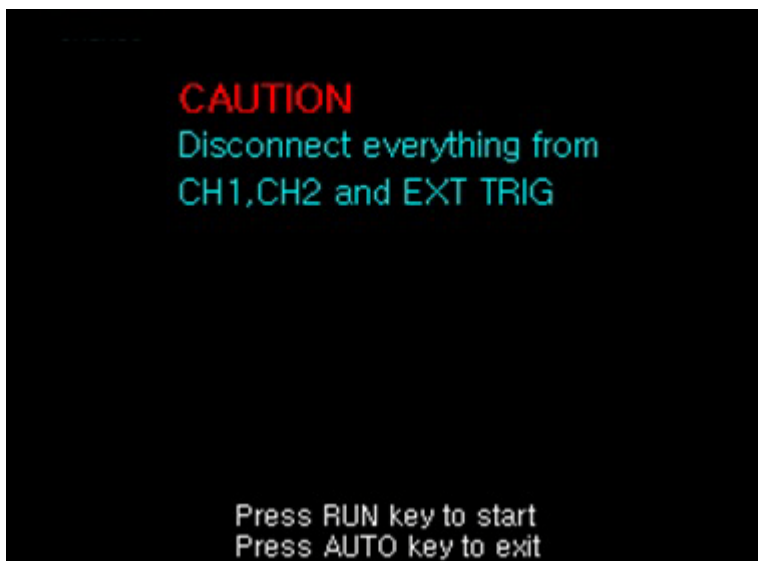

Self Calibration

Note: Warm up the oscilloscope at least 30 minutes before performing self-calibration. Do not have anything connected to any of the inputs. Doing so will create errors and instrument may fail to calibrate properly.

Menu Operation

Fast-Calibration

Fast calibration is ideally used to calibrate the instrument to remedy the effects of temperature drift causing an offset drift. It calibrates the center position of each Volt/Div setting, but not for the full range. This is different compare to self-calibration, in which the channel scale, offset, and trigger are calibrated.

Menu Operation

I/O Setup

Press **UTILITY** → **I/O Setup** to display the **I/O SETUP** menu.

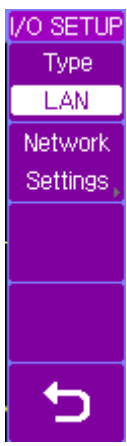

| Softkey | Options | Description |
|-------------------------|------------|-----------------------------------------------------|
| Type | USB Device | Select USB interface |
| | RS232C | Select RS232C interface |
| | LAN | Select LAN interface |
| Baud Rate | ↻ | Available baud rate: 2400, 4800, 9600, 19200, 38400 |
| Network Settings | ---- | Select LAN menu |
| ↶ | ---- | Return to the UTILITY menu |

Menu Operation

Press **Network Settings** softkey to display the **LAN** menu.

| LAN | Softkey | Options | Description |
|------|-------------|---------|----------------------------------------------------------------------------------------------------|
| DHCP | DHCP | ON | IP address together with subnet mask and gateway address will be set by DHCP server automatically. |
| OFF | | OFF | You have to set IP address, subnet mask and gateway address manually. |
| ↑ ↓ | ↑ ↓ | ---- | Move the cursor position vertically (available when DHCP is OFF). |
| ↔ | ↔ | ---- | Move the cursor position horizontally (available when DHCP is OFF). |
| OK | OK | ---- | Confirm and apply the current settings. |
| ↶ | ↶ | ---- | Return to the I/O SETUP menu |

Menu Operation

Follow the following steps to manually configure the LAN interface:

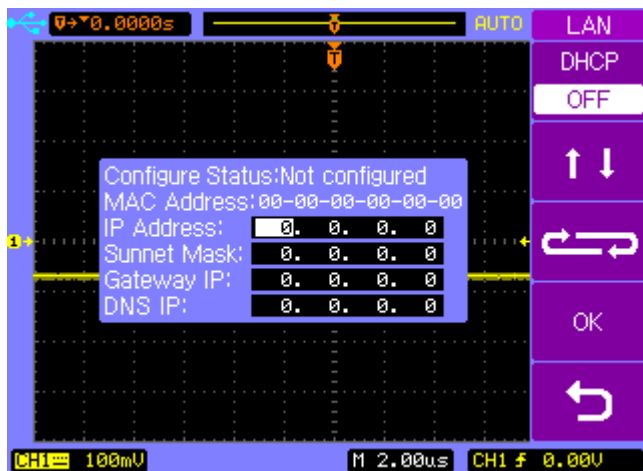

- **Set the IP Address.** Contact your network administrator for the IP address to use. All IP addresses take the dot-notation form “nnn.nnn.nnn.nnn” where “nnn” in each case is a byte value in the range 0 through 255. Move the cursor to the IP address position and change the IP address using the entry knob.
- **Set the Subnet Mask.** The subnet mask is required if your network has been divided into subnets. Move the cursor to the subnet mask position and enter the subnet mask in the IP address format using the entry knob.
- **Set the Gateway IP.** The gateway address is the address of a gateway which is a device that connects two

Menu Operation

networks. Move the cursor to the Gateway IP position and enter the gateway address in the IP address format using the entry knob.

- **Set the DNS IP.** DNS is an internet service that translates domain names into IP addresses. Move the cursor to the DNS IP position and enter the address of the DNS server in the IP address format using the entry knob.



Note: *If you are manually entering the LAN settings, you may need to restart the oscilloscope for settings to apply. If you are using DHCP, first turn on DHCP, then select OK and wait a few seconds until the Configure Status shows "DHCP". Otherwise, it may not be able to detect the correct DHCP settings from the connected network.*

Note: *The instrument does not support socket or telnet connection. When interfacing over LAN, if settings were changed or refreshed (from selecting OK from softpanel menu), the instrument may need to be rebooted first before it can be connected for remote control.*

Menu Operation

Print Setup

Press **UTILITY** → **Print Setup** to display the **PRINT** menu.

| PRINT | Softkey | Options | Description |
|-----------------------------------------------------------------------------------|-----------------------------------------------------------------------------------|----------------|----------------------------|
| Print to File | Print to | File | Print to file |
| File Type BMP(24Bit) | File Type | BMP(8Bit) | 8-Bit BMP file format |
| | | BMP(24Bit) | 24 Bit BMP file format |
| | | CSV | CSV file format |
| Screen Normal | Screen | Normal | Normal BMP picture |
| | | Inverted | Inverted color BMP picture |
|  |  | ---- | Return to the UTILITY menu |

Print To

The **Print To** softkey option configures what file type to store when the **PRINT** key is pressed.

Note: *The file can only be stored through an external USB storage device connected to the front USB device port.*

To store a file to external USB drive, do the following:

1. Connect a USB flash drive to the USB device connector on the front panel.

Menu Operation

2. Press **File Type** softkey to select the file format you want.
3. Press the **PRINT** key to save the file to the USB drive. If BMP is selected, it will take a screen capture of the display and store it as a .BMP file. If CSV is selected, it will store the CSV data that represents the waveform on the display.

Note: *The BMP options will print out everything that is as shown when **PRINT** key is pressed, including the opened softkey menu. To get a screen capture without an opened softkey menu, please use the **MENU ON/OFF** key to turn off the menu on the display before printing to a file.*

File Type

BMP(8 bit) – Stores in .BMP file format with 8 bit color resolution.

Note: *Some software or image viewer may not be able to view this file format.*

BMP(24 bit) – Stores in .BMP file format with 24 bit color resolution.

Menu Operation

CSV – Stores the waveform data captured on the frame of the screen into CSV file format. Depending on the timebase, the maximum number of points that can be stored into CSV is 1200 pts.

Note: *Deep memory data cannot be stored into a .CSV file to a USB flash drive. It can only be obtained by remote control over USB, RS232, or LAN interface located in the rear panel of the instrument.*

Screen

Normal – Prints the screen with normal colors.

Inverted – Prints the screen with inverted colors.

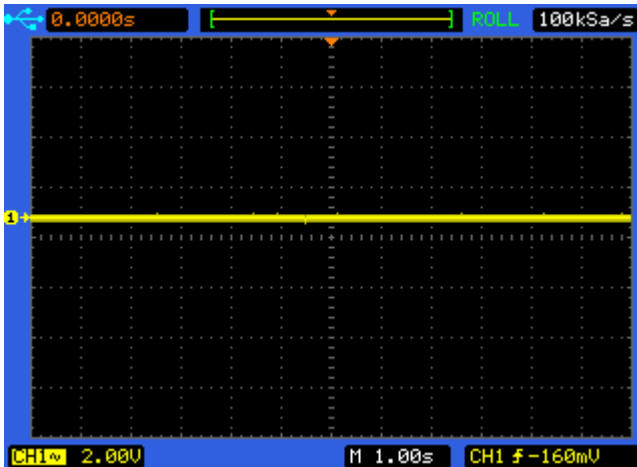

Menu Operation

Normal

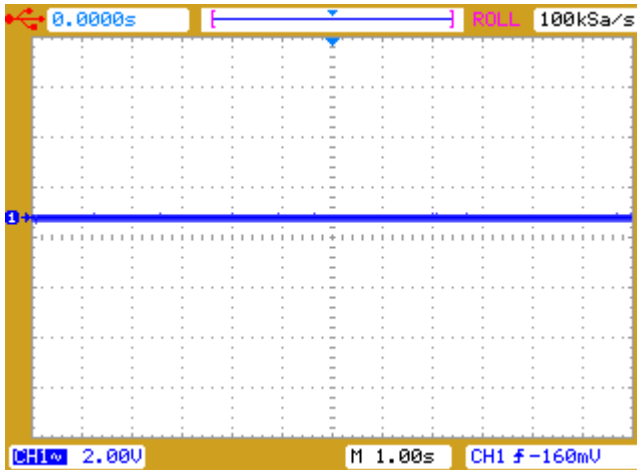







Inverted

Menu Operation

System Setup

Press **UTILITY** → **System Setup** to display the **SYSTEM** menu page 1/2.



| SYSTEM | Softkey | Options | Description |
|-----------------------------------------------------------------------------------|-----------------|-----------------------------------------------------------------------------------|-----------------------|
| Key Sound | Key |  | Key press sound on |
|  | Sound |  | Key press sound off |
| Alarm Sound | Alarm |  | Alarm sound on |
|  | Sound |  | Alarm sound off |
| Counter | Counter | ON | Frequency counter on |
| OFF | | OFF | Frequency counter off |
| -More- | More 1/2 | ---- | Select menu page 2/2 |
| 1/2 | | | |

Frequency Counter

Select the **Counter** softkey to toggle between enabling and disabling frequency counter shown on screen.

Menu Operation

Press the **More 1/2** softkey to display the **SYSTEM** menu page 2/2.

|  | Softkey | Options | Description |
|-----------------------------------------------------------------------------------|-----------------------------------------------------------------------------------|----------------------|---------------------------------------------------------------------|
| | Key Lock | ON | Key Lock function on |
| | | OFF | Key Lock function off, a password is required when Password is ON |
| | Password | ON | Password protection on |
| | | OFF | Password protection off, a password is required when Password is ON |
| | Change Password | | The old password is required to change the password |
| |  | ---- | Return to the UTILITY menu |
| More 2/2 | ---- | Select menu page 1/2 | |

Note: The default password is “111111”

Menu Operation

Key Lock

Press **UTILITY** → **System Setup** → **Key Lock** to lock the front panel operation, all the keys and controls. When key lock is on, all keys are disabled except **MENU ON/OFF** key and the five softkeys. When front panel is locked a red lock icon is displayed at the top-left corner of the screen. Correct password is required to unlock the front panel operation when Password is ON as shown below. The default password is “111111”.

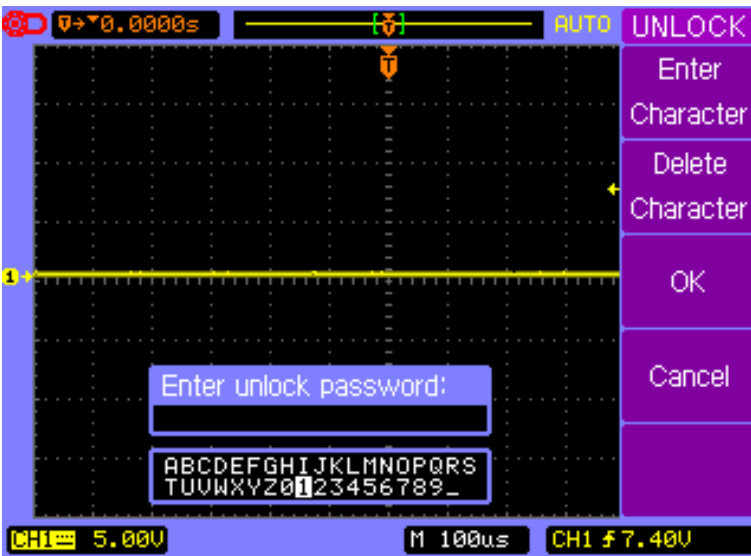

Menu Operation

Password Protection

Press **Password** softkey from the **SYSTEM** menu 2/2 to turn off the Password protection function, correct password is required as shown below.

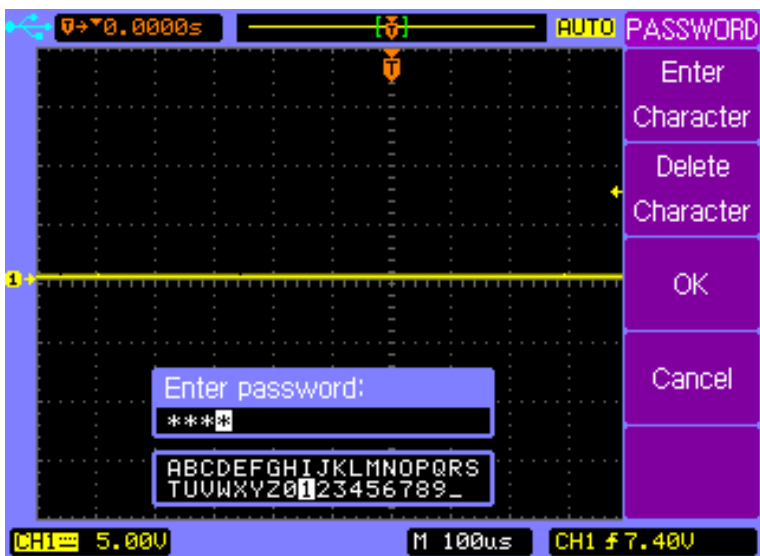

Menu Operation

Change Password

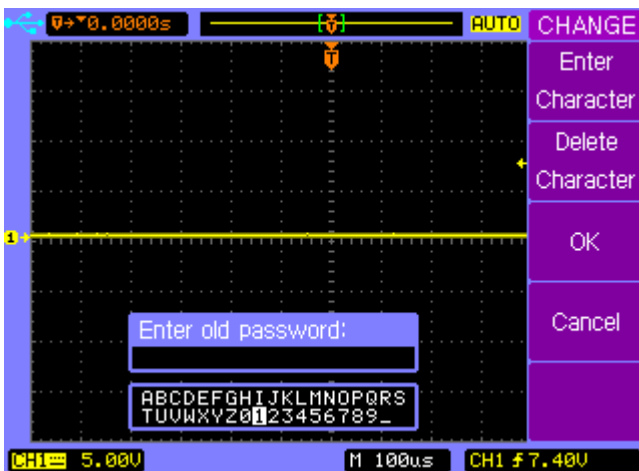

Press **Change Password** softkey from the **SYSTEM** menu page 2/2 to display the **CHANGE** menu. The old password is required before entering and confirming the new password as shown below.



Menu Operation

Service

Press **UTILITY** → **Service** to display the **Service** menu.

| SERVICE | Softkey | Options | Description |
|-----------------------------------------------------------------------------------|-----------------------------------------------------------------------------------|----------------|---------------------------------------------------------------------------------------|
| System Info | System Information | ---- | Display system information: Model, Serial number, Software version, Installed modules |
| Screen Test | Screen Test | ---- | Test the LCD screen |
| Key Test | Key Test | ---- | Check the key and control operation |
|  |  | ---- | Return to the UTILITY menu |

Menu Operation

System Information

Press **UTILITY** → **Service** to display the **Service** menu, and then press the **System Info** softkey to display the system informations, such as Model, Serial number, Power up times, Software version and a list of installed modules.

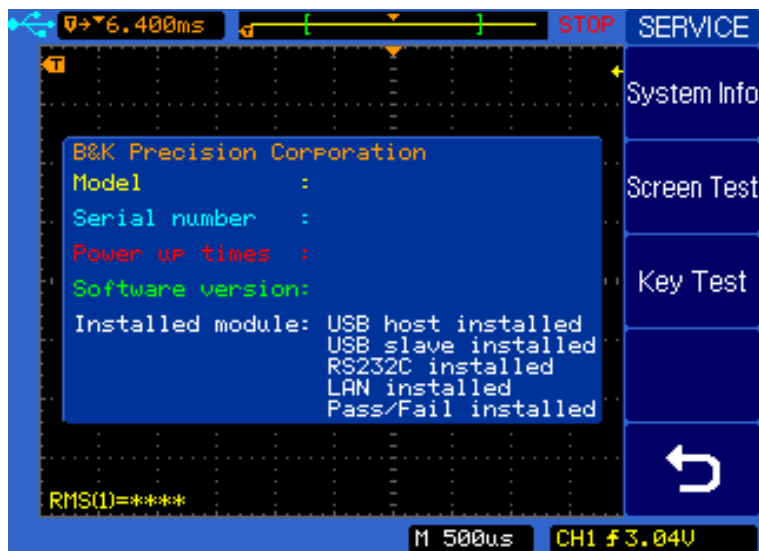

System Information

Menu Operation

Pass/Fail

The oscilloscope first measures the input source signal and compares it with Pass/Fail settings, and then outputs the Pass/Fail result.

Press **UTILITY** → **Pass/Fail** to display the **PASS/FAIL** menu 1/2.

| | Softkey | Options | Description |
|--------------------------------------------------------------------------------------------|--------------------|----------------|------------------------|
| PASS/FAIL Enable Test OFF Source CH1 Operate Setup Mask -More- 1/2 | Enable Test | ON | Pass/Fail function on |
| | | OFF | Pass/Fail function off |
| | Source | CH1 | Source signal CH1 |
| | | CH2 | Source signal CH2 |
| | Operate | ▶ | Start Pass/Fail test |
| | | ■ | Stop Pass/Fail test |
| | Setup Mask | ---- | Set up the regulations |
| | More 1/2 | ---- | Display the menu 2/2 |

Menu Operation

Press **More 1/2** to display the **PASS/FAIL** menu 2/2.





| PASS/FAIL | Softkey | Options | Description |
|-----------------------|-----------------------|---------|------------------------------------|
| Msg Display | Msg Display | ON | Pass/Fail count message on |
| Output | | OFF | Pass/Fail count message off |
| Fail | Output | PASS | Output on Pass waveforms |
| Stop on Output | | PASS+ | Output and alarm on Pass waveforms |
| OFF | | FAIL | Output on Fail waveforms |
| | | FAIL+ | Output and alarm on Fail waveforms |
| -More- 2/2 | Stop on Output | ON | Stop sampling on output |
| | | OFF | Continue sampling on output |
| | | ---- | Return to the UTILITY menu |
| | More 2/2 | ---- | Display the menu page 1/2 |

Note: *Pass/Fail function is not available when X-Y mode is selected.*

Menu Operation

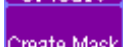

Setup Mask

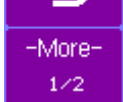
Press **UTILITY** → **Pass/Fail** → **Setup Mask** to display the **MASK** menu 1/2.

| | Softkey | Options | Description |
|-----------------------------------------------------------------------------------|--------------------|---------|-------------------------------------|
|  | X Mask | ↻ | Set horizontal tolerance |
|  | Y Mask | ↻ | Set vertical tolerance |
|  | Create Mask | ---- | Create the PASS/FAIL tolerance mask |
|  | ↶ | ---- | Return to the PASS/FAIL menu |
|  | More 1/2 | ---- | Display the menu 2/2 |

Menu Operation

Press **More 1/2** to display the **MASK** menu 2/2.

| | | | |
|-----------------------------------------------------------------------------------|-----------------------------------------------------------------------------------|----------------|------------------------------------------------------------------------|
| MASK | Softkey | Options | Description |
| Internal Storage | Internal Storage | ---- | Store the PASS/FAIL tolerance mask to internal memory |
| External Storage | External Storage | ---- | Store the PASS/FAIL tolerance mask to external USB mass storage device |
|  |  | ---- | Return to the PASS/FAIL menu |
| -More- 2/2 | More 2/2 | ---- | Display the menu page 1/2 |

3.2 MEASURE Menu

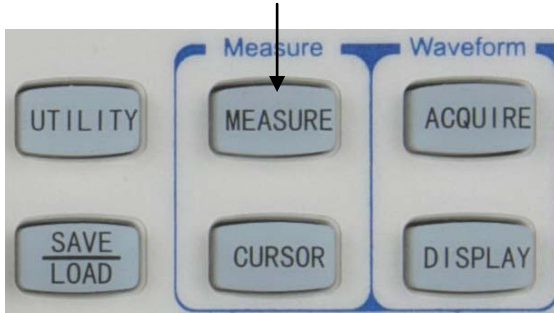

MEASURE Menu key

Menu Operation

Press **MEASURE** menu key to display the **MEASURE** menu.

| |
|-------------|
| MEASURE |
| Source |
| CH1 |
| Voltage |
| Time |
| Clear |
| Measure All |
| OFF |

| Softkey | Options | Description |
|--------------------|---------|-------------------------------------------|
| Source | CH1 | Measure CH1 |
| | CH2 | Measure CH2 |
| Voltage | ---- | Select the Voltage measurement menu |
| Time | ---- | Select the Time measurement menu |
| Clear | ---- | Turn off the current measurement readouts |
| Measure All | ON | Display all measurements |
| | OFF | Close all measurements |



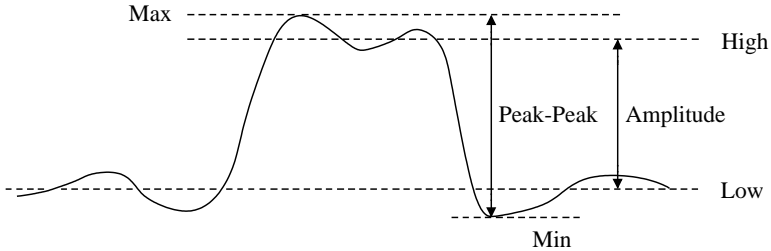

Menu Operation

Voltage Measurements



Voltage parameter definitions

Press **MEASURE** → **Voltage** to display the **VOLTAGE** menu page 1/4.

| VOLTAGE | Softkey | Options | Description |
|------------------------------------------------------------------------------------------------|------------------|---------|--------------------------------------------------------------------------|
|  Peak-Peak | Peak-Peak | ---- | The Peak-Peak value is the difference between maximum and minimum values |
|  Amplitude | Amplitude | ---- | The Amplitude value is the difference between High and Low values |
|  Max | Max | ---- | Max is the highest value in the waveform display |
|  Min | Min | ---- | Min is the lowest value in the waveform display |
| -More- 1/4 | More 1/4 | ---- | Display menu page 2/4 |

Menu Operation

Press **More 1/4** softkey to display the **VOLTAGE** menu page 2/4.



| Softkey | Options | Description |
|-----------------|---------|---------------------------------------------------------------------------------------------------|
| High | ---- | High value is the mode (most common value) of the upper part of the waveform |
| Low | ---- | Low value is the mode (most common value) of the lower part of the waveform |
| Average | ---- | Average value is the sum of the samples divided by the number of samples over the entire waveform |
| RMS | ---- | RMS value is the true Root Mean Square voltage over the entire waveform |
| More 2/4 | ---- | Display menu page 3/4 |

Menu Operation

Press **More 2/4** softkey to display the **VOLTAGE** menu page 3/4.



| Softkey | Options | Description |
|------------------|---------|-----------------------------------------------------------------------------------------------------------|
| Cycle Avg | ---- | Cycle Avg value is the sum of the samples divided by the number of samples over one period |
| Cycle RMS | ---- | Cycle RMS value is the true Root Mean Square voltage over one period |
| Overshoot | ---- | Overshoot value is distortion that follows a major edge transition expressed as a percentage of amplitude |
| Preshoot | ---- | Preshoot value is distortion that precedes a major edge transition expressed as a percentage of amplitude |
| More 3/4 | ---- | Display menu page 4/4 |

Menu Operation

$$\text{Rising Edge Overshoot} = \frac{\text{Max} - \text{High}}{\text{Amplitude}} \times 100$$

$$\text{Falling Edge Overshoot} = \frac{\text{Low} - \text{Min}}{\text{Amplitude}} \times 100$$

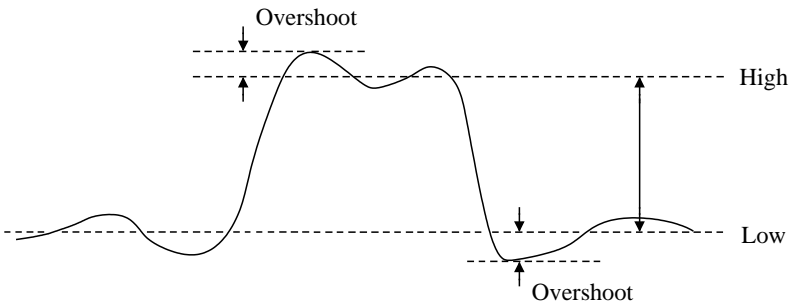

$$\text{Rising Edge Preshoot} = \frac{\text{Low} - \text{Min}}{\text{Amplitude}} \times 100$$

$$\text{Falling Edge Preshoot} = \frac{\text{Max} - \text{High}}{\text{Amplitude}} \times 100$$

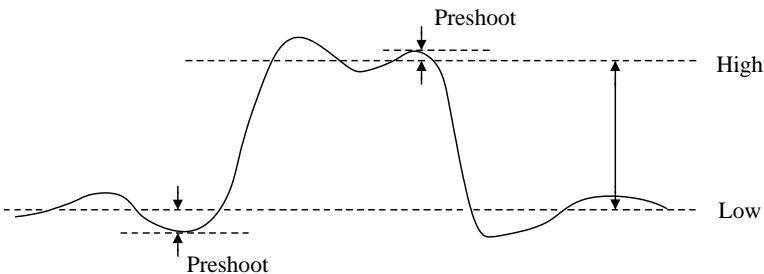

Menu Operation

Press **More 3/4** softkey to display the **VOLTAGE** menu page 4/4.

| VOLTAGE | Softkey | Options | Description |
|---------|-----------------------------------------------------------------------------------|---------|-----------------------------------|
| |  | ---- | Return to the MEASURE menu |
| | More 4/4 | ---- | Display menu page 1/4 |



Time Measurements

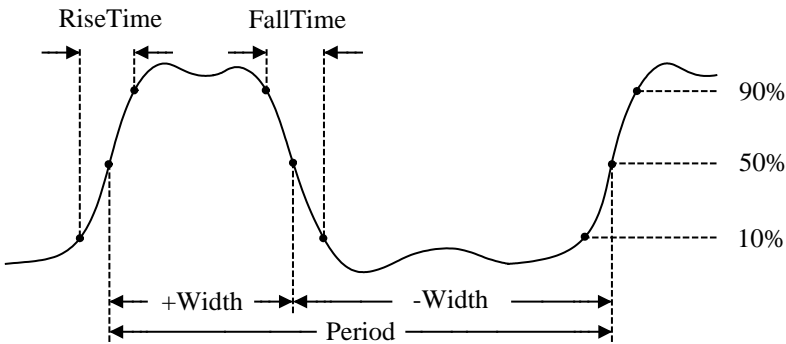

Time parameter definitions

Menu Operation





Press **MEASURE** → **Time** to display the **TIME** menu page 1/5.



| Softkey | Options | Description |
|------------------|---------|------------------------------------------------------------------------------------------------------------|
| Frequency | ---- | Frequency is defined as 1/period of the first cycle |
| Period | ---- | Period is the time period of the first complete waveform cycle |
| Rise Time | ---- | Rise Time is the time that the first positive-leading edge takes to rise from 10% to 90% of its amplitude |
| Fall Time | ---- | Fall Time is the time that the first negative-trailing edge takes to fall from 90% to 10% of its amplitude |
| More 1/5 | ---- | Display menu page 2/5 |





Menu Operation

Press **More 1/5** softkey to display the **TIME** menu page 2/5.

| TIME | Softkey | Options | Description |
|----------------------------------------------------------------------------------------------|-----------------|---------|-------------------------------------------------------------------------------------------------|
|  + Width | +Width | ---- | Positive Width is the time between the 50% amplitude points of the first positive pulse |
|  - Width | -Width | ---- | Negative Width is the time between the 50% amplitude points of the first negative pulse |
|  + Duty | +Duty | ---- | Positive Duty is the ratio of the first positive width to its period, expressed as a percentage |
|  - Duty | -Duty | ---- | Negative Duty is the ratio of the first negative width to its period, expressed as a percentage |
| -More- 2/5 | More 2/5 | ---- | Display menu page 3/5 |

Menu Operation

Press **More 2/5** softkey to display the **TIME** menu page 3/5.

| TIME | Softkey | Options | Description |
|--------------------------------------------------------------------------------------------------|--------------------|---------|---------------------------------------------------------------------------------------------------------------------------------|
|  Delay 1f+2f | Delay 1f+2f | ---- | The time between the 50% amplitude points of the first positive-leading edge of each channel |
|  Delay 1r+2r | Delay 1r+2r | ---- | The time between the 50% amplitude points of the first negative-trailing edge of each channel |
|  Delay 1f+2f | Delay 1f+2f | ---- | The time between the first positive-leading edge of CH1 and the first negative-trailing edge of CH2 at each 50% amplitude point |
|  Delay 1r+2r | Delay 1r+2r | ---- | The time between the first negative-trailing edge of CH1 and the first positive-leading edge of CH2 at each 50% amplitude point |
| -More- 3/5 | More 3/5 | ---- | Display menu page 4/5 |



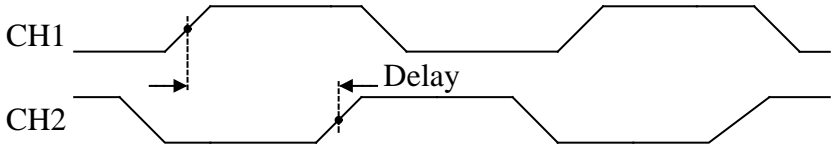

Menu Operation



Delay $t + 2\frac{1}{f}$ definition

Menu Operation

Press **More 3/5** softkey to display the **TIME** menu page 4/5.

| TIME | Softkey | Options | Description |
|-----------------------------------------------------------------------------------------------|---------------------|---------|-------------------------------------------------------------------------------------------------------------------------------------------------------------|
|  Phase1→2 | Phase 1→2 | ---- | Phase 1→2 is the ratio of Delay 1→2 to the period of CH1, expressed in degrees |
|  Phase2→1 | Phase 2→1 | ---- | Phase 2→1 is the ratio of Delay 2→1 to the period of CH2, expressed in degrees |
|  X at Max | X at Max | ---- | X at Max is the X axis value (refer to Trigger point) at the first displayed occurrence of the waveform Maximum, starting from the left side of the display |
|  X at Min | X at Min | ---- | X at Min is the X axis value (refer to Trigger point) at the first displayed occurrence of the waveform Minimum, starting from the left side of the display |
| -More- 4/5 | More 4/5 | ---- | Display menu page 5/5 |

Menu Operation

$$\text{Phase 1} \rightarrow 2 = \frac{\text{CH2 50\% Time} - \text{CH1 50\% Time}}{\text{CH1 Period}} \times 360$$

$$\text{Phase 2} \rightarrow 1 = \frac{\text{CH1 50\% Time} - \text{CH2 50\% Time}}{\text{CH2 Period}} \times 360$$

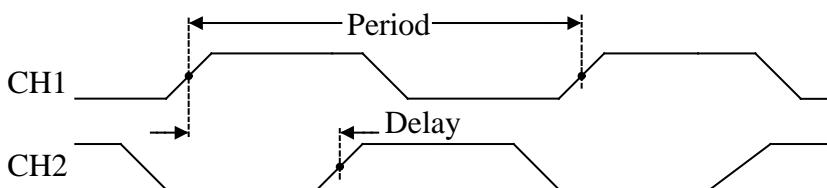

Phase 1 → 2 definition

Press **More 4/5** softkey to display the **TIME** menu page 5/5.

| TIME | Softkey | Options | Description |
|---------------|-----------------|---------|-----------------------------------|
| | | ---- | Return to the MEASURE menu |
| | More 5/5 | ---- | Display menu page 1/5 |
| | | | |
| -More- 5/5 | | | |

Menu Operation

Automatic Measurement Procedure

Measure All:

Press **MEASURE** → **Measure All** to turn on all Auto Measurements. Up to 20 kinds of measurements of current channel are displayed on the center of the screen.

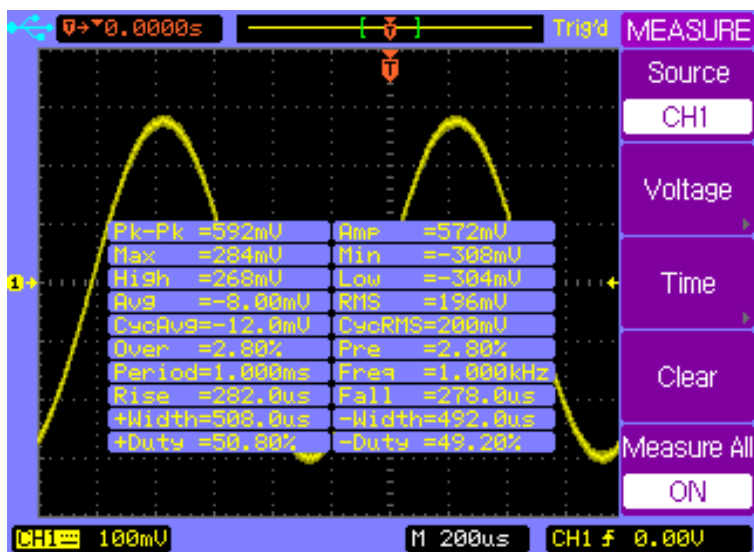

Press **Measure All** again to turn off all Auto Measurements.

Display Measurements:

Press **MEASURE** → **Voltage** to display the **VOLTAGE** menu or press **MEASURE** → **Time** to display the **TIME** menu.

Menu Operation

Press softkey of voltage or time parameters you want to measure.

The selected parameter will be displayed on the bottom of the display.

Press **Clear** softkey to clear all displayed measurement parameter(s).

Note: Up to three parameters can be displayed simultaneously at the bottom of the display. Press the parameter softkey to add a new parameter when three parameters are already displayed. The first parameter will be pushed out of the display window and the new parameter will be displayed on the bottom right of the display screen.

Note: "**" will be displayed when a parameter can not be measured correctly.***

Menu Operation

3.3 ACQUIRE Menu

Press the **ACQUIRE** menu key to show the **ACQUIRE** menu.



ACQUIRE Menu key

Press **Mode** softkey to select **Normal** mode.

| ACQUIRE | Softkey | Options | Description |
|------------|-----------------|-------------|-------------------------|
| Mode | Mode | Normal | Normal acquisition |
| Normal | | Average | Average acquisition |
| | | Peak Detect | Peak detect acquisition |
| Sampling | Sampling | Equivalent | Equivalent sampling |
| Equivalent | | Real Time | Real time sampling |
| Record | Record | ---- | Select Record menu |

Normal acquisition mode yields the best display for most waveforms.

Menu Operation

Average mode lets you average multiple triggers to reduce noise and increase resolution.

Peak Detect mode should be used to display narrow pulses that occur infrequently. It's useful when looking for very narrow pulses at very slow time base.

Equivalent sampling mode is useful for displaying high frequency repetitive signals.

Real Time sampling mode is useful to capture the single-shot signals.

Menu Operation

Press **Mode** softkey to select **Average** mode.

| | | | | | | | |
|-----------------|----------------|------------------------------------------------------------------|----------|----|----------|------------|--------|
| ACQUIRE | Mode | Average | Averages | 16 | Sampling | Equivalent | Record |
| Mode | Normal | Normal acquisition | | | | | |
| Mode | Average | Average acquisition | | | | | |
| Mode | Peak Detect | Peak detect acquisition | | | | | |
| Averages | ↻ | Set the average number to 2, 4, 8, 16, 32, 64, 128, or 256 | | | | | |
| Sampling | Equivalent | Equivalent sampling | | | | | |
| Sampling | Real Time | Real time sampling | | | | | |
| Record | ---- | Select Record menu | | | | | |

Press **Mode** softkey to select **Peak Detect** mode.

| | | | | | |
|-----------------|----------------|----------------------------|----------|------------|--------|
| ACQUIRE | Mode | Peak Detect | Sampling | Equivalent | Record |
| Mode | Normal | Normal acquisition | | | |
| Mode | Average | Average acquisition | | | |
| Mode | Peak Detect | Peak detect acquisition | | | |
| Sampling | Equivalent | Equivalent sampling | | | |
| Sampling | Real Time | Real time sampling | | | |
| Record | ---- | Select Record menu | | | |

Menu Operation

Connect a sine wave signal to the CH1 channel, press **ACQUIRE** → **Mode** to select Average mode. Turn the Entry knob ↻ to set the number of averages to 16. The following two figures show the difference between Normal acquisition and Average acquisition.

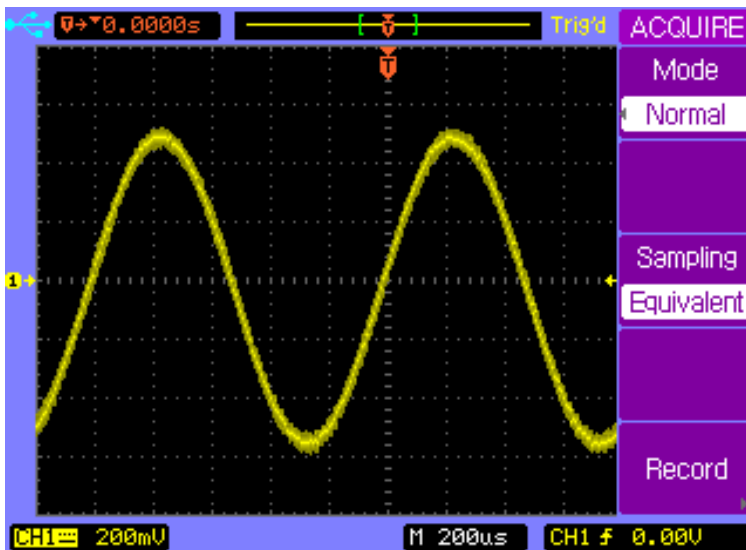

Random noise on the displayed waveform

Menu Operation

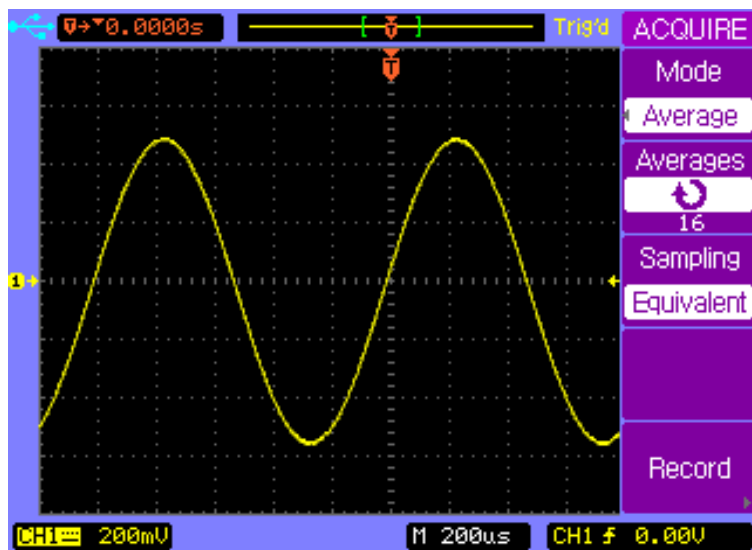

16 Averages used to reduce random noise

Menu Operation

Record Waveform

Press **ACQUIRE** → **Record** to show the **RECORD** menu.



| Softkey | Options | Description |
|------------------|---------------|-------------------------------------------------|
| Mode | OFF | Turn off record function |
| | Record | Record the waveform |
| | Play Back | Playback recorded waveform |
| | Save /Recall | Save to/Recall from internal or external memory |
| Source | CH1 | Record CH1 channel |
| | CH2 | Record CH2 channel |
| | Pass/Fail Out | Record Pass/Fail output waveform |
| Interval | ↻ | Set the time interval |
| End Frame | ↻ | Maximum record frame |
| Operate | ● | Record |
| | ■ | Stop |

Menu Operation

Playback Record

Press **ACQUIRE** → **Record** to show the **RECORD** menu.

Press **Mode** softkey to select Playback function.

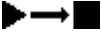
| | | | |
|---------------|--------------------------|-----------------------------------------------------------------------------------|----------------------------------------------------|
| RECORD | Softkey | Options | Description |
| Mode | Mode | Record | Record the waveform |
| Play back | | Play Back | Playback the record |
| Operate | | Save /Recall | Save/Recall from internal or external memory |
| Play Mode | | OFF | Exit Record function |
| Current Frame | | ▶ | Play |
| 34 | Operate | ■ | Stop |
| -More- 1/2 | Play Mode |  | Loop play |
| | Current Frame |  | Single play |
| | More 1/2 | ↻ | Select a specific frame |
| | | ---- | Select menu page 2/2 |

Menu Operation

Press **ACQUIRE** → **Record** to show the **RECORD** menu.
 Press **Mode** softkey to select Play Back function. Press **More 1/2** softkey to show **RECORD** menu page 2/2.

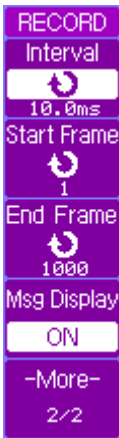

| Softkey | Options | Description |
|--------------------|---------|---------------------------------|
| Interval | ↻ | Interval between two frames |
| Start Frame | ↻ | Set the start frame to playback |
| End Frame | ↻ | Set the end frame to playback |
| Msg Display | ON | Record message on |
| | OFF | Record message off |
| More 2/2 | ---- | Select menu page 1/2 |

Note: *The interval time must be greater than 1 ms + signal period + sampling interval time + frame storage time .*



Note: *Frame length is the waveform storage depth. Maximum of 1000 frames of waveform can be stored.*

Menu Operation

Save/Recall the Record

Press **ACQUIRE** → **Record** to show the **RECORD** menu.



Press **Mode** softkey to select **Save/Recall** function.

| | | | |
|-------------------------------------------------------------------------------------------|-----------------------------|-----------------|----------------------------------------------------|
| RECORD | Softkey | Options | Description |
| Mode | Mode | Record | Record the waveform |
| Save/Recall | | Play back | Playback the record |
| Start Frame | | Save /Recall | Save/Recall from internal or external memory |
|  1 | | OFF | Exit Record function |
| End Frame | Start Frame | ↻ | Set the start frame to save |
|  1000 | End Frame | ↻ | Set the end frame to save |
| Internal Storage | Internal Storage | ---- | Save/Recall from internal memory |
| External Storage | External Storage | ---- | Save/Recall from external memory |

Menu Operation

Exit Record Function

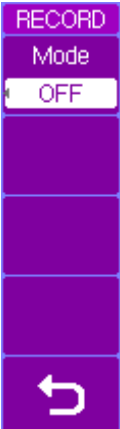
Press **Mode** softkey to select **OFF** option and return to the **ACQUIRE** menu.

| | Softkey | Options | Description |
|-----------------------------------------------------------------------------------|-----------------------------------------------------------------------------------|----------------|----------------------------------------------|
|  | Mode | Record | Record the waveform |
| | | Play back | Play back the record |
| | | Save /Recall | Save/Recall from internal or external memory |
| | | OFF | Exit Record function |
|  |  | ---- | Return to ACQUIRE menu |

Menu Operation

3.4 SAVE/LOAD Menu



SAVE/LOAD MENU key

Press **SAVE/LOAD** key to display the **SAVE/LOAD** menu.

| SAVE/LOAD | Softkey | Options | Description |
|------------------|-------------------------|---------|---------------------------------------------------------|
| Internal Storage | Internal Storage | ---- | Display the INTERNAL menu |
| External Storage | External Storage | ---- | Display the EXTERNAL menu |
| | Factory | ---- | Set the instrument to the factory default configuration |
| Factory | | | |

Menu Operation

Internal Storage

Saving/Loading Trace

Press **SAVE/LOAD** → **Internal Storage** → **Storage type** to display the **INTERNAL** menu and select Trace storage type.

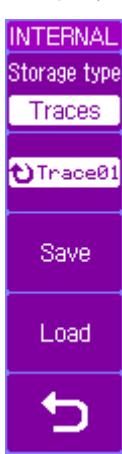
|  | Softkey | Options | Description |
|-----------------------------------------------------------------------------------|---------------------|---------|---------------------------------------------|
| | Storage type | Traces | Trace file format |
| | | Setups | Setup file format |
| | Tracexx | ↻ | Select a trace file from Trace01 to Trace10 |
| | Save | ---- | Save the display to current trace file |
| | Load | ---- | Load the current trace file |
| | ↶ | ---- | Return to the SAVE/LOAD menu |

Note: *A trace is similar to a reference waveform, except it only stores/recalls a trace of exactly what's shown within the display frame only and not any other part of the record data. It cannot be adjusted with horizontal or vertical controls. To clear the trace on display, use the **Clear***

Menu Operation

Persistence softkey under the **DISPLAY** menu.
See “**DISPLAY Menu**” for details.

Saving/Loading Setups

Press **SAVE/LOAD** → **Internal Storage** → **Storage type** to display the **INTERNAL** menu and select Setups storage type.





| Softkey | Options | Description |
|---------------------|---------|----------------------------------------------------------|
| Storage type | Traces | Trace file format |
| | Setups | Setup file format |
| Setupxx | ↻ | Select a setup file from Setup01 to Setup10 |
| Save | ---- | Save the current configuration to the current setup file |
| Load | ---- | Load from the current setup file |
| ↻ | ---- | Return to the SAVE/LOAD menu |

Note: Each setup stores all the horizontal, vertical, and trigger control settings. This includes and not limited to horizontal timebase, horizontal position, vertical scale, vertical position, and trigger position.

Menu Operation

External Storage



Press **SAVE/LOAD** → **External Storage** to display the **EXTERNAL** menu.

| EXTERNAL | Softkey | Options | Description |
|-----------------------------------------------------------------------------------|-----------------------------------------------------------------------------------|---------|----------------------------------------------------|
| New | New | ---- | Create a new file or folder in the external memory |
| Rename | Rename | ---- | Rename the current file or folder |
| Load | Load | ---- | Load the current file |
| Delete | Delete | ---- | Delete the current file or folder |
|  |  | ---- | Return to the SAVE/LOAD menu |

Note: The External Storage menu and operations will not be available unless an external USB flash drive is connected and installed.



Menu Operation

Press **SAVE/LOAD** → **External Storage** → **New** to display the **New** menu.

| | Softkey | Options | Description |
|-----------------------------------------------------------------------------------|-----------------------------------------------------------------------------------|---------|-------------------------------------|
| New | New File | ---- | Display the New File menu |
| New File | New Folder | ---- | Display the New Folder menu. |
| New Folder |  | ---- | Return to the EXTERNAL menu |
| | | | |
| | | | |
|  | | | |

Menu Operation



Press **SAVE/LOAD** → **External Storage** → **New** → **New File** to display the **New File** menu.

| New File | Softkey | Options | Description |
|-----------------------------------------------------------------------------------|-----------------------------------------------------------------------------------|----------------|--------------------------------------------------------------------|
| Save as | Save as | Setups | Save as setup files |
| Setups | | Traces | Save as trace files |
| Enter Character | | Waveforms | Save as waveform files |
| Delete Character | | BMP(8bit) | Save as 8-bit BMP files |
| Save | | BMP(24bit) | Save as 24-bit BMP files |
|  | Enter Character | ---- | Enter the selected character and go to the next character position |
| | Delete Character | ---- | Delete the selected character |
| | Save | ---- | Save the new file |
| |  | ---- | Return to New menu |

Note: Maximum length of a file name is 8 characters. Press **Enter Character** to select a character position in the file name. Turn the entry knob to select a character. Press **Delete Character** to delete the current selected character. Press **Enter Character** to enter the selected character and go to the next character position.



Menu Operation

Press **SAVE/LOAD** → **External Storage** → **New** → **New Folder** to display the **New Folder** menu.

| New Folder | Softkey | Options | Description |
|-----------------------------------------------------------------------------------|-----------------------------------------------------------------------------------|---------|--------------------------------------------------------------------|
| Enter Character | Enter Character | ---- | Enter the selected character and go to the next character position |
| Delete Character | Delete Character | ---- | Delete the selected character |
| Save | Save | ---- | Save the new folder |
|  |  | ---- | Return to the New menu |



Menu Operation

Press **SAVE/LOAD** → **External Storage** → **Rename** to display the **Rename** menu.

| Rename | Softkey | Options | Description |
|-----------------------------------------------------------------------------------|-----------------------------------------------------------------------------------|---------|--------------------------------------------------------------------|
| Enter Character | Enter Character | ---- | Enter the selected character and go to the next character position |
| Delete Character | Delete Character | ---- | Delete the selected character |
| OK | OK | ---- | Rename the selected file or folder |
|  |  | ---- | Return to the EXTERNAL menu |

Menu Operation

Press **SAVE/LOAD** → **External Storage** → **Delete** to display the **Delete** menu.

| | Softkey | Options | Description |
|-----------------------------------------------------------------------------------|-----------------------------------------------------------------------------------|---------|-----------------------------------------------|
| Delete | OK | ---- | Confirm to delete the selected file or folder |
| OK | Cancel | ---- | Cancel the delete operation |
| Cancel |  | ---- | Return to the EXTERNAL menu |
|  | | | |

Menu Operation

Firmware Update

1. Press **SAVE/LOAD** → **External Storage** to display the **EXTERNAL** menu.
2. Turn the entry knob to select the correct update file (*.UPT).
3. Press **Load** softkey to start the update operation. A Loading followed by an updating progress bar will be displayed to indicate update status.
4. When finished, a message “**Restart to complete updating**” will be displayed to remind you to restart the instrument.

If the software update failed, repeat the above procedures to update again.

Note: *The default file extension of the update file is “.upt”. Select the correct update file according to the model of the oscilloscope. Error message “Incompatible file” will be displayed if the model does not match.*

Note: *The power supply of the oscilloscope must not be turned off during the updating process. If this happens, the update will fail and the instrument may fail to operate. In this case, you will have to return the instrument to factory for service.*

3.5 CURSOR Menu

You can measure waveform data using cursors. Cursors are horizontal and vertical markers that indicate X-axis values (usually time) and Y-axis (usually voltage) on a selected waveform source. The position of the cursors can be moved by turning the entry knob ↻.

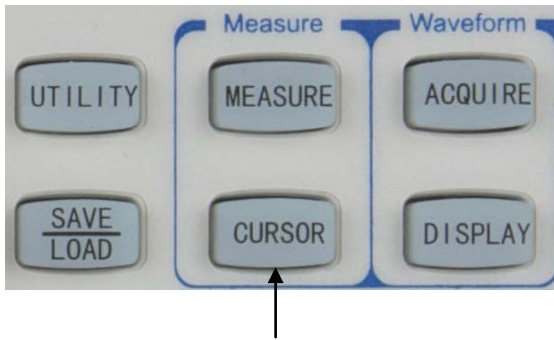

Cursor Menu key

The oscilloscope provides three kinds of cursor measurement modes: **Manual**, **Auto** and **Track**.



Menu Operation

Manual Mode

Voltage Cursor Measurement

In the manual mode, you can move the cursors to measure the voltage or time on the select source waveform.

Press **CURSOR** → **Mode** to display the **CURSOR** menu and select the **Manual** mode. Press the **Type** softkey to select **Voltage** measurement.

|  | Softkey | Options | Description |
|------------------------------------------------------------------------------------|----------------------------|-------------------------------------------------------------------------------------|----------------------------------------------------------------------------------------------------------------------------------------------------------------------|
| Mode | Mode | Manual | Manual cursor measurement |
| | | Auto | Auto cursor measurement |
| | | Track | Track cursor measurement |
| Source | Source | CH1 | Measure CH1 |
| | | CH2 | Measure CH2 |
| | | MATH | Measure MATH |
| Type | Type | Voltage | Measure voltage value |
| | | Time | Measure time value |
| Y1-- Y2-- | Y1-- Y2-- |  | Press this softkey to select Y1, Y2, or both Y1 and Y2 cursors for adjustment. Current voltage values for Y1 and Y2 are displayed in the softkey or on the top right |

Menu Operation

| | | |
|------------------------------|------|---------------------------------------------------------|
| | | corner when menu is off |
| ΔY | ---- | Displays the difference value between Y1 and Y2 cursors |

Time Cursor Measurement

Press **CURSOR** → **Mode** to display the **CURSOR** menu and select the **Manual** mode. Press the **Type** softkey to select **Time** measurement.

| CURSOR | Softkey | Options | Description |
|------------------------------------------------------|---------------|--------------------|--------------------------------------------------------------------------------------------------------------------------------------------------|
| Mode | Mode | Manual | Manual cursor measurement |
| Manual | | Auto | Auto cursor measurement |
| Source | | Track | Track cursor measurement |
| CH1 | Source | CH1 | Measure CH1 |
| Type | | CH2 | Measure CH1 |
| Time | | MATH | Measure MATH |
| X1 -- -6.000u.s X2 -- 6.000u.s | Type | Voltage | Measure voltage value |
| ΔX 12.00u.s 1/2 ΔX 83.33kHz | | Time | Measure time value |
| \curvearrowright X1-- \curvearrowright X2-- | | \curvearrowright | Press this softkey to select X1, X2, or both X1 and X2 cursors for adjustment. Current time values for X1 and X2 are displayed in the softkey |

Menu Operation

| | | |
|----------------------------|------|----------------------------------------------------------------------------------------------------------------------|
| | | or on the top right corner when menu is off. |
| ΔX $1/\Delta X$ | ---- | ΔX is the time difference value between X1 and X2 cursors $1/\Delta X$ is the frequency between X1 and X2 |

Track Mode

Two cross hair cursors are displayed on the screen in the track mode. The cross hair cursors track the waveform automatically. You can move the cross hair cursors horizontally by turning the entry knob . The X,Y values of each cross hair cursor are displayed in the softkey area, or on the top right corner of the display when menu is off.

Menu Operation

Press **CURSOR** → **Mode** to display the **CURSOR** menu and select the **Track** mode.

| CURSOR | Softkey | Options | Description |
|-------------------|-----------------|---------|-----------------------------------------------------------------------------------------------------------------------------------------------------------------------------------|
| Mode | Mode | Manual | Manual cursor measurement |
| Track | | Auto | Auto cursor measurement |
| Cursor A | | Track | Track cursor measurement |
| Cursor B | Cursor A | CH1 | Track CH1 with Cursor A |
| CH1 | | CH2 | Track CH2 with Cursor A |
| None | | None | Turn off Cursor A |
| Ax -- -6.000uε | Cursor B | CH1 | Track CH1 with Cursor B |
| Ay -- -80.0mV | | CH2 | Track CH2 with Cursor B |
| By -- ***** | | None | Turn off Cursor B |
| Ax -- Ay -- | | ↻ | Press this softkey to select Cursor A for adjustment. Current tracked X, Y axis point values of Cursor A are displayed in the softkey or on the top right corner when menu is off |
| Bx -- By -- | | ↻ | Press this softkey to select Cursor B for adjustment. Current tracked X, Y axis point values of Cursor B are displayed in the softkey or on the top right corner when menu is off |

Menu Operation

AUTO Mode

The Auto mode cursors are displayed only when auto measurement function is enabled. The oscilloscope displays the auto cursors corresponding to the latest auto measurement parameter. No Auto cursors will be displayed when no auto measurement parameter is selected.

3.6 DISPLAY Menu



Display Menu key









Menu Operation

Press **DISPLAY** menu key to display the **DISPLAY** menu page 1/2.

| | Softkey | Options | Description |
|-----------------|--------------------------|-----------------------|--------------------------------------------------------------------------------|
| | Type | Vector | Vector mode fills the space between adjacent sample points in the waveform |
| | | Dots | Dot mode only displays the sample points |
| | Persist | ON | The scope updates the waveform without erasing the previous sample points |
| | | OFF | Turn off the persistence function |
| | Clear Persistence | ---- | Press to erase the previous sample points as well as the loaded trace waveform |
| | Intensity | ↻ | Adjust the display intensity of waveforms |
| More 1/2 | ---- | Display menu page 2/2 | |

Menu Operation

Press **More 1/2** softkey to display the **DISPLAY** menu page 2/2.

| DISPLAY | Softkey | Options | Description |
|---------------------------------------------------------------------------------------------------|---------------------|-----------------------------------------------------------------------------------|------------------------------------|
| Grid  | Grid |  | Display both grids and axes |
| Brightness 50% | |  | Turn off the axes |
| Color Setup 1 | |  | Turn off the grids |
| Menu Display  | |  | Turn off both grids and axes |
| -More- 2/2 | Brightness |  | Adjust the brightness of the grids |
| | Color Setup | ---- | Select Color scheme |
| | Menu Display |  | Adjust the menu display time |
| | More 2/2 | ---- | Display menu page 1/2 |

4 SHORTCUT MENU

- CUSTOM Button
- MEASALL Button
- RECORD Button
- COUNTER Button

4.1 Shortcut Controls



These four shortcut keys provide alternate quick access to some most frequently used functions or menus.

CUSTOM Button

The Custom button allows the user to assign a shortcut from a list of menu categories as its function upon pressing it.

The button serves two functions: To assign shortcut and to be used as a shortcut key.

Before it can be used as a shortcut, the user must first enable and setup a shortcut for it from within the custom button menu.

Shortcut Menu

Custom Button Menu

To enter the custom button menu, press and hold down the Custom key for two seconds or until the custom menu shown below displays on screen:

| CUSTOM | Softkey | Options | Description |
|-----------|----------|---------|-------------------------------------------------------------------|
| Enable | Enable | ON | Enable custom shortcut key |
| ON | | OFF | Disable custom shortcut key |
| Shortcut | Shortcut | --- | Assign shortcut to a selected sub-menu category using the ↻ knob. |
| Pass/Fail | | | |

Shortcut

The available sub-menu categories that can be assigned as a shortcut are listed as follows:

- Service Menu
- I/O Setup
- Print Setup
- System Setup
- FFT
- Trigset Menu
- Clear Measurement (Clears any measurement that are currently displayed at the bottom of the grid)
- Full/Split Screen (for **Math** function only)

Shortcut Menu

Using Custom Button

After a shortcut has been assigned and the custom function has been enabled, users may now press the **CUSTOM** key (do not hold down the key, otherwise the DSO will go back into the Custom menu) at any time to go to the assigned shortcut.

MEASALL Button

The **MEASALL** button is a shortcut key to toggle the display of the all measurement window. When pushed, it will show all measurements like the screen below:

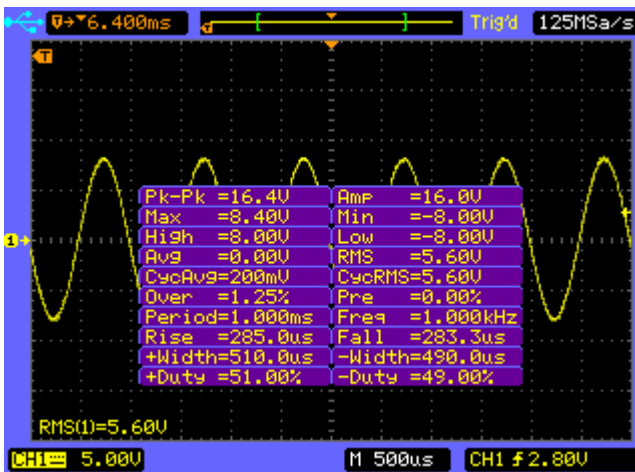

Shortcut Menu

RECORD Button

The **RECORD** button is a shortcut key that directly enters into the Record sub-menu, allowing users to quickly adjust settings and begin a signal recording to capture and analyze data.

COUNTER/LOCAL Button

The **COUNTER** button serve two purpose. When not in remote mode, it functions as a shortcut key to turn on/off the hardware frequency counter display. When in remote mode, it will work as a secondary function (**LOCAL**), which sets the oscilloscope back to LOCAL mode whenever the oscilloscope is in remote mode (**RMT**). Setting the oscilloscope to local mode will unlock all front panel keys, allowing users to resume front panel operation.

5 QUICK START GUIDE

- Application Examples
 - Making Simple Measurements
 - Capture Single Shot Signal
 - Reducing Random Noise on a Signal
 - Triggering a Video Signal
 - Pass/Fail Measurement
 - Using Waveform Recorder
 - Making Cursor Measurements

5.1 Make Simple Measurements

This section provides instructions for measuring the amplitude and frequency of an unknown signal on CH1.

Perform the following steps to quickly display the signal.

- Connect the channel 1 probe to the unknown signal.
- Press the **AUTO** key.

The oscilloscope automatically sets vertical, horizontal, and trigger controls. You can adjust any of these controls manually if you need to optimize the display of the waveform.

When you are using both CH1 and CH2 channels, the Autoset function sets the vertical controls for each channel and uses the CH1 channel to set the horizontal and trigger controls.

The oscilloscope can take automatic measurements of the displayed signals. Perform the following steps to measure signal amplitude and frequency.



- Press the **MEASURE** key to display the **MEASURE** menu.
- Press the **Voltage** softkey to display the **VOLTAGE** menu.

Quick Start Guide

- Press the **Amplitude** softkey to measure the Amplitude. The amplitude value will be displayed at the bottom of the screen.
- Press **MEASURE** key again to display the **MEASURE** menu.
- Press **Time** softkey to display the **TIME** menu.
- Press the **Frequency** softkey to measure the frequency. The frequency value will be displayed at the bottom of the screen to the right of the voltage value.

5.2 Capture Single Shot Signal

Digital Storage Oscilloscope can easily be used to capture a single-shot or unrepeatable signal. Perform the following steps to capture a single-shot signal.

- Connect the channel 1 probe to the unknown signal.
- Press the trigger **MENU** key to display the **TRIGGER** menu.
- Press the **Source** softkey to select CH1.
- Press the **Mode** softkey to select the Auto trigger mode.
- Adjust the vertical and horizontal controls to observe the the signal roughly. And find out the right Trigger Type and Trigger mode.
- Press the **Type** softkey from the **TRIGGER** menu page to select Pulse trigger type.
- Press **More 1/2** sofkey to display the **TRIGGER** menu page 2/2.
- Press **Mode** softkey to select Normal Trigger mode.
- Press **More 2/2** sofkey to display the **TRIGGER** menu page 1/2.
- Press **Pulse Mode** softkey to select  (positive less than).
- Rotate the entry knob () to set up the pulse width.

Quick Start Guide

- Press the **SINGLE** key to start the acquisition system and search for the trigger condition. The **SINGLE** key will be illuminated in orange.
- When trigger condition is met, the captured waveform will be displayed, the **SINGLE** key will no longer be lit, and the **RUN/STOP** key will illuminate in red.

5.3 Reduce Random Noise on a Signal

If the test signal is noisy, you can set up the oscilloscope to reduce the noise on the displayed waveform. First, you stabilize the displayed waveform by removing the noise from the trigger path. Second, you reduce the noise on the displayed waveform.

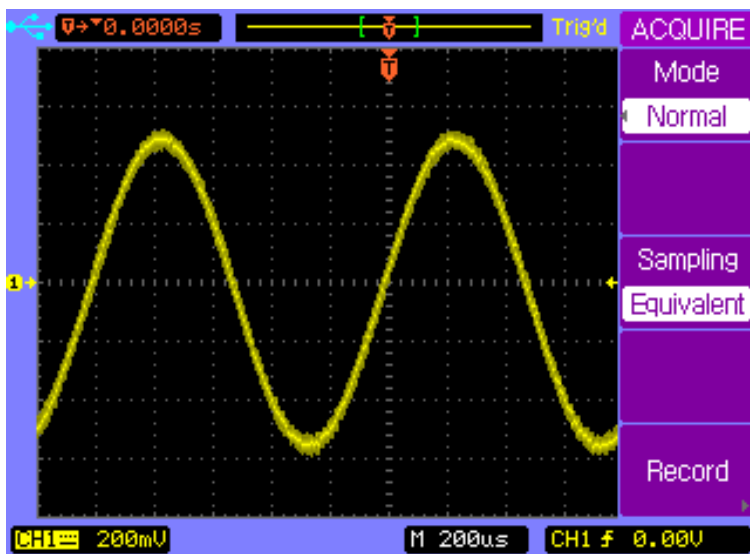

- Connect a signal to the oscilloscope. Press **AUTO** key to display the signal quickly.
- Press the Trigger **MENU** key to display the **TRIGGER** menu.

Quick Start Guide

- Press **Type** softkey to select **Edge** trigger type.
- Press **Trigger Setup** softkey to display the trigger **SETUP** menu
- Press **Coupling** softkey to select **HF Reject** or **LF Reject** coupling mode to reduce the noise from the trigger channel.
- Press the **ACQUIRE** key to display the **ACQUIRE** menu.
- Press the **Mode** softkey to select **Average** mode.
- Rotate the entry knob (↻) to set the number of averages that best eliminates the noise from the displayed waveform.

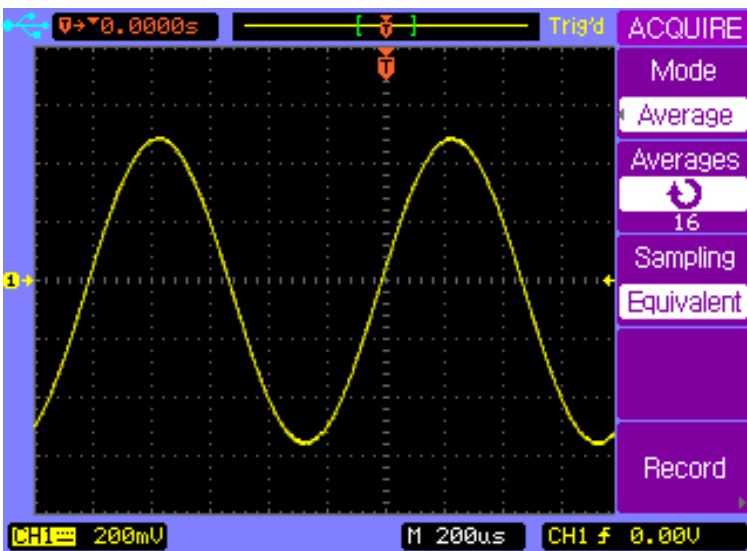

5.4 Triggering a Video Signal

Video trigger can be used to capture the standard video signals. The trigger circuit detects the vertical and horizontal interval of the waveform and produces triggers based on the Video trigger setting you have selected.

Trigger on Odd or Even Fields of the Video Signal

- Press the Trigger **MENU** key to display the **TRIGGER** menu.
- Press the **Type** softkey to select the **Video** trigger mode.
- Press **Source** softkey to select **CH1**.
- Press **Polarity** softkey to select negative polarity \sqcup .
- Press **Sync** softkey to select **Odd Field** or **Even Field**.

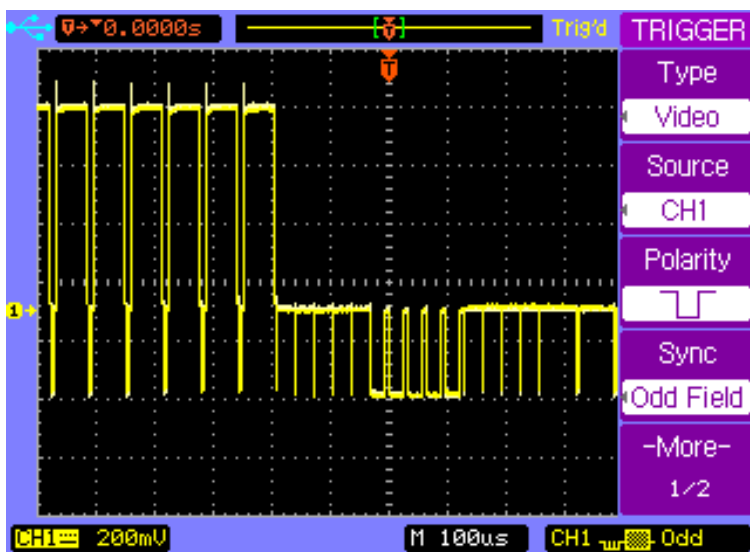

Quick Start Guide

Trigger on a Specific Line or All Lines of the Video Signal

- Press the Trigger **MENU** key to display the **TRIGGER** menu.
- Press the **Type** softkey to select the **Video** trigger mode.
- Press **Source** softkey to select **CH1**.
- Press **Polarity** softkey to select negative polarity \sqcup .
- Press **Sync** softkey to select **Line #** or **All Lines**.

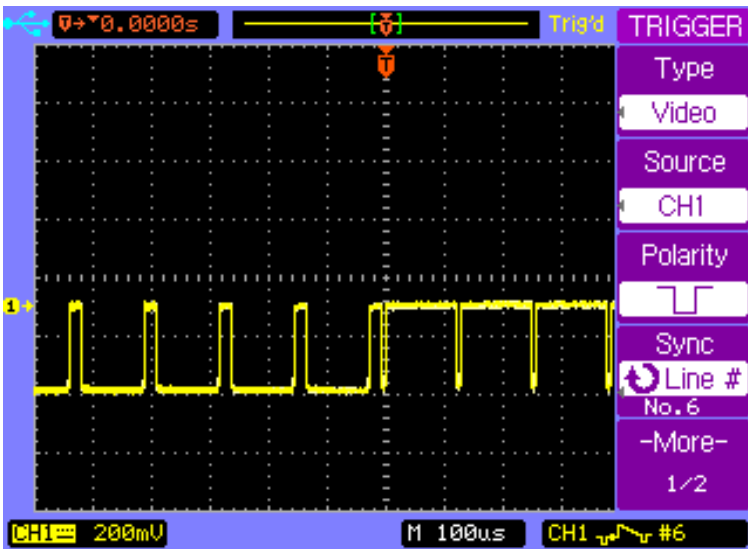

5.5 PASS/FAIL Measurement

The oscilloscope measures and compares the input signal with predefined Pass/Fail thresholds. If the input signal is within the thresholds, PASS signal will be outputted. If the input signal exceeds the thresholds, FAIL signal will be outputted.

Perform the following steps to make a PASS/FAIL measurement.

- Press **UTILITY** key to display the **UTILITY** menu page 1/2.
- Press **More 1/2** softkey to display the **UTILITY** menu page 2/2.
- Press **Pass/Fail** softkey to display the **PASS/FAIL** menu.
- Press **Enable Test** softkey to turn on the **PASS/FAIL** measurement.
- Press **Setup Mask** softkey to display the **MASK** menu.
- Press **X Mask** softkey and then rotate the entry knob to setup the horizontal threshold.
- Press **Y Mask** softkey and then rotate the entry knob to setup the vertical threshold.
- Press **Creat Mask** softkey to update the thresholds.
- Press **↶** softkey to return to the **PASS/FAIL** menu.

Quick Start Guide

- Press **More 1/2** softkey to display the **PASS/FAIL** menu page 2/2.
- Press **Msg Display** softkey to display the Pass/Fail measurement results on the top left corner of the screen.
- Press the **Output** softkey to set how to output the measurement results.
- Press **More 2/2** to display the **PASS/FAIL** menu page 1/2.
- Press the **Operate** softkey to start PASS/FAIL measurement.

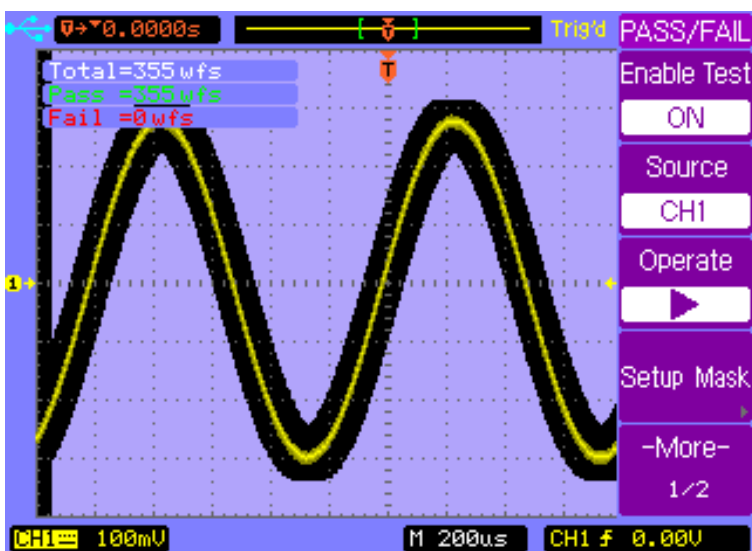

5.6 Using Waveform Recorder

Waveform recorder lets you record waveforms, playback waveforms and save the waveforms.



Perform the following steps to record waveforms.

- Press the **ACQUIRE** key to display the **ACQUIRE** menu.
- Press the **RECORD** softkey to display the **RECORD** menu.
- Press the **Mode** softkey to select **Record** mode.
- Press the **Source** softkey to select the source channel **CH1**.
- Press the **Operate** key to start recording, and the total recorded frame count will be displayed on the top left screen. Press the **Operate** key again to stop recording.

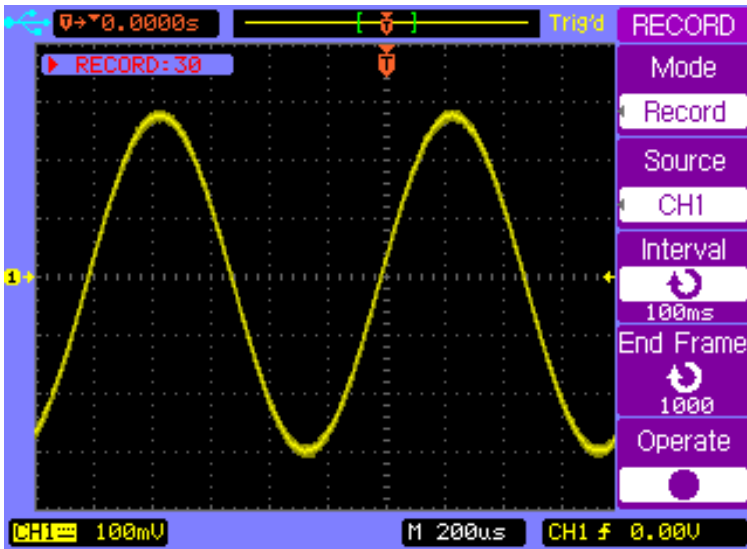
Quick Start Guide



Perform the following steps to playback the waveforms.

- Press the **ACQUIRE** key to display the **ACQUIRE** menu.
- Press the **RECORD** softkey to display the **RECORD** menu.
- Press the **Mode** softkey to select **Play back** mode.
- Press **Play Mode** softkey to select  or  mode.
- Press the **More 1/2** softkey to display the **RECORD** menu page 2/2.
- Press **Start Frame** softkey and turn the entry knob to set the start frame.
- Press **End Frame** softkey and turn the entry knob to set the end frame.

Quick Start Guide

- Press **Interval** softkey and turn the entry knob to set the interval time.
- Press the **More 2/2** softkey to display the **RECORD** menu page 1/2.
- Press **Operate** softkey to playback the waveform.

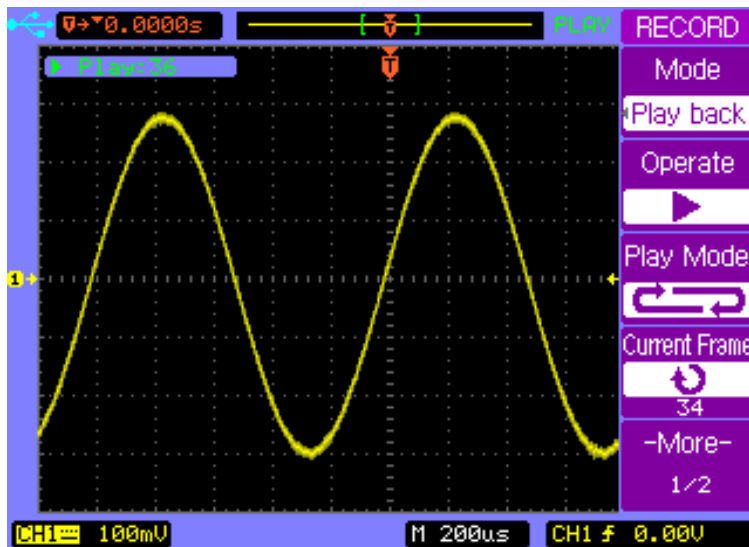

Quick Start Guide

Perform the following steps to save the waveform recorded.



- Press the **ACQUIRE** key to display the **ACQUIRE** menu.
- Press the **RECORD** softkey to display the **RECORD** menu page 1/2.
- Press the **Mode** softkey to select **Save/Recall** mode.
- Press **Start Frame** softkey and turn the entry knob to set the start frame.
- Press **End Frame** softkey and turn the entry knob to set the end frame.
- Press the **Internal Storage** softkey to Save or Load the recorded waveform from the internal memory.

5.7 Making Cursor Measurements

You can use the cursors to quickly make time and voltage measurements on a waveform. You can use the cursors to measure the amplitude and frequency of a FFT waveform. You can also use the cursors to measure the phase difference between two signals with the same frequency when X-Y horizontal mode is selected.

Measure the time and voltage on normal waveform

Perform the following steps to take time and frequency measurements.

- Press the **CURSOR** key to display the **CURSOR** menu.
- Press **Mode** softkey to select the **Manual** mode.
- Press **Type** softkey to select the **Time** type.
- Press **X1--/X2** softkey or press the entry knob to select X1 cursor.
- Rotate the entry knob  to move the X1 cursor.
- Press **X1--/X2** softkey or press the entry knob to select X2 cursor.
- Rotate the entry knob  to move the X2 cursor.
- ΔX and $1/\Delta X$ are displayed in the softkey area. ΔX is the time difference between X1 and X2; $1/\Delta X$ is the frequency between X1 and X2.

Quick Start Guide

Perform the following steps to take voltage measurement.

- Press the **CURSOR** key to display the **CURSOR** menu.
- Press **Mode** softkey to select the **Manual** mode.
- Press **Type** softkey to select the **Voltage** type.
- Press **↶Y1--/↷Y2**—softkey or press the entry knob to select Y1 cursor.
- Rotate the entry knob ↶ to move the Y1 cursor.
- Press **↶Y1--/↷Y2**—softkey or press the entry knob to select Y2 cursor.
- Rotate the entry knob ↷ to move the Y2 cursor.
- ΔY displayed in the softkey area is the voltage difference between Y1 and Y2.

Quick Start Guide

Measure the frequency and amplitude on FFT waveform

Perform the following steps to take frequency measurement.

- Press the **MATH** key to display the **Math** menu.
- Press the **Operate** softkey to select **FFT** and display the **FFT** menu.
- Press the **CURSOR** key to display the **CUROSR** menu.
- Press **Mode** softkey to select the **Manual** mode.
- Press **Source** softkey to select **FFT**.
- Press **Type** softkey to select the **Time** type.
- Press **↶X1--/↷X2** softkey or press the entry knob to select X1 cursor.
- Rotate the entry knob ↶ to move the X1 cursor.
- Press **↶X1--/↷X2** softkey or press the entry knob to select X2 cursor.
- Rotate the entry knob ↷ to move the X2 cursor.
- ΔX displayed in the softkey area is the frequency difference between X1 and X2. $1/\Delta X$ is the time difference between X1 and X2.

Perform the following steps to take voltage measurement.



- Press the **MATH** key to display the **Math** menu.
- Press the **Operate** softkey to select **FFT** and display the **FFT** menu.
- Press the **CURSOR** key to display the **CUROSR** menu.
- Press **Mode** softkey to select the **Manual** mode.

Quick Start Guide

- Press **Source** softkey to select **FFT**.
- Press **Type** softkey to select the **Voltage** type.
- Press **↶Y1--/↷Y2**—softkey or press the entry knob to select Y1 cursor.
- Rotate the entry knob ↶ to move the Y1 cursor.
- Press **↶Y1--/↷Y2**—softkey or press the entry knob to select Y2 cursor.
- Rotate the entry knob ↷ to move the Y2 cursor.
- ΔY displayed in the softkey area is the voltage difference between Y1 and Y2.

Quick Start Guide

Measure the phase difference between two signals of the same frequency under X-Y display mode.

- Connect a sine wave signal to CH1 and a sine wave signal of the same frequency but out of phase to CH2.
- Press horizontal **MENU** key to display the **Horizontal** menu.
- Press **X-Y** softkey to select **X-Y** display mode
- Center the signal on the display with the vertical control knob of each channel.
- Use the vertical scale control knob of each channel to expand the signal for convenient view.
- Press the **CURSOR** key to display the **CURSOR** menu.
- Press **Mode** softkey to select the **Manual** mode.
- Press **Source** softkey to select **CH2**.
- Press **Type** softkey to select the **Voltage** type.
- Press **Y1-/Y2—** softkey or press the entry knob to select Y1 cursor.
- Rotate the entry knob  to move the Y1 cursor to the top of the signal.
- Press **Y1-/Y2—** softkey or press the entry knob to select Y2 cursor.
- Rotate the entry knob  to move the Y2 cursor to the bottom of the signal.
- ΔY displayed in the softkey area is the voltage difference D (or 2B) between Y1 and Y2.

Quick Start Guide

- Press Y1--/Y2 —softkey or press the entry knob to select Y1 cursor.
- Rotate the entry knob \curvearrowright to move the Y1 cursor to the upper intersection of the signal and Y axis.
- Press Y1--/Y2 —softkey or press the entry knob to select Y2 cursor.
- Rotate the entry knob \curvearrowright to move the Y2 cursor to the lower intersection of the signal and Y axis.
- ΔY displayed in the softkey area is the voltage difference C (or 2A) between Y1 and Y2.
- Calculate the phase difference using the formula below.

$$\theta = \pm \arcsin \frac{C}{D} \quad \text{or} \quad \theta = \arcsin \frac{A}{B}$$

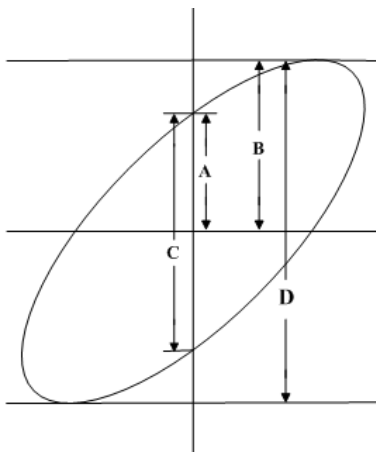

6 REMOTE CONTROL

- Comsoft Software
- Web Browser GUI (Graphic user Interface)

6.1 Comsoft Software

The 2540B and 2542B comes with Comsoft application software which provides most of the controls of the oscilloscope's display, measurements, waveform data, and front panel emulation control through the USB device port in the rear panel.

The software is free and can be downloaded at www.bkprecision.com

6.2 Web Browser GUI

The DSO has a build-in web browser interface that can be used for some basic LAN configurations and quick screenshot capture via LAN interface at the rear panel.

To access, simply set the DSO to LAN interface and configure all the necessary settings (see "I/O Setup" section). Noting the IP address configured on the oscilloscope, enter it at the address bar of a Java enabled web browser for access.

7 TROUBLESHOOT GUIDE

- System Messages
- General Problems

7.1 System Message

Function is not available: The control knob, key, or softkey is not available under a specific operating condition. This message will be displayed when you try to operate these knob, key, or softkey.

The control is at its limit: This message will be displayed when the maximum or minimum value has reached from turning the Entry knob, Vertical Control knobs, Horizontal Control knobs, or Trigger Level knob.

Total is at its maximum: This message will be displayed when the maximum value of Total count for PASS/FAIL has reached.

Record is completed: This message will be displayed when the number of waveforms (set in the **End Frame** softkey) have been recorded or when you press the **Operate** softkey to stop the record process manually.

No external memory: This message will be displayed when you try to save a file to an external mass storage device which has not been installed.

Save error: This message will be displayed when you fail to save a file to the internal or external memory.

Troubleshoot Guide

Empty storage memory: This message will be displayed when you try to load a file which does not exist from the internal memory.

Unrecognized file: This message will be displayed when you try to load a file which can not be recognized by the oscilloscope from the external memory.

Update failed: This message will be displayed when firmware update has failed.

No record data: This message will be displayed when you try to save or playback a record without recorded data.

Record is aborted: This message will be displayed when **Operate** softkey is pressed to stop record process without any waveform data recorded.

Factory setup is recalled: This message will be displayed when the default factory configuration is recalled.

No signal is found: This message will be displayed when you press the **AUTO** key without any signal connected to each channel.

Invalid data: This message will be displayed when you try to save a *.CSV , *.TRC or *.WFM file without any valid waveform data.

Troubleshoot Guide

Load finished: This message will be displayed when a file has been successfully loaded from the internal or external memory.

Save finished: This message will be displayed when a file has been successfully saved to the internal or external memory.

Incompatible file: This message will be displayed when the update firmware file does not match with the model type.

Load error: This message will be displayed when you fail to load a file from the internal or external memory.

Restart to complete updating: This message is to inform the user to restart the oscilloscope after a firmware update to finish the process.

USB device is installed: This message will be displayed when a USB device is connected and recognized by the oscilloscope.

USB device is removed: This message will be displayed when a USB device is removed from the oscilloscope.

USB error: This message will be displayed when the USB control circuit is not working normally.

Troubleshoot Guide

No help file: This message will be displayed when no help file is loaded or the loaded help file is corrupted.

Digital filter is closed: This message will be displayed when digital filter is closed automatically.

7.2 General Problems

If there is no display on the screen:

- Check that the power cord is connected to the oscilloscope and to a live power source.
- Check that the power switch is on.

If there is no waveform displayed:

- Check that the oscilloscope probe is securely inserted into the connector assembly and that the probe clips make good contact with the probe lead wires.
- Check that the probe clips are securely connected to points in the circuit under test and that the ground is connected.
- Check that the circuit under test is powered on.
- Press the **AUTO** key again.

If the waveform display is not stable:

- Check that the trigger source channel is actually the channel to which the trigger signal is connected.
- Check that the proper trigger type is selected. Video type is only used to trigger a Video signal. Proper trigger type is essential to acquire a stable display.
- Try to use the HF Reject or LF Reject to reduce the noise of the trigger signal.

Troubleshoot Guide

If the amplitude is not identical with the actual voltage

- Check that the attenuation factor of the probe is identical with the attenuation factor set in the channel menu.

If instrument is not connected over LAN

- Try using DHCP if not already.
- Reboot the instrument, then try again.

How do I extract the deep memory from the DSO?

- This can only be extracted using provided PC software. It cannot be exported directly to a connected front USB flash drive.

8 SPECIFICATIONS

- Digital Storage Oscilloscope Specifications
- General Specifications

Specifications

8.1 Digital Storage Oscilloscope

Specifications

All characteristics are typical performance values and are not warranted. Characteristics are valid after a 30 minute warm-up time and within $\pm 5^{\circ}\text{C}$ of last "Self-Cal" temperature.

Vertical system

| | |
|------------------------------------------------------|------------------------------------------------------------------------------------------------------|
| Scope channels | 2 channels plus external trigger input. |
| Bandwidth | 60 MHz: 2540B |
| | 100 MHz: 2542B |
| Calculated rise time ($=0.35/\text{bandwidth}$) | < 5.83 ns: 2540B |
| | < 3.50 ns: 2542B |
| Coupling | AC, DC and GND |
| BW Limit | 20 MHz selectable |
| DC Vertical Gain Accuracy | 2 mV/div, 5 mV/div: $\pm 4\%$ |
| | 10 mV/div to 5 V/div: $\pm 3\%$ |
| DC Measurement | 2 mV/div to 5 mV/div: $\pm(4\% \times \text{reading} + 0.1 \times \text{V/div} + 0.5 \text{ mV})$ |
| | 10 mV/div to 5 V/div: $\pm(3\% \times \text{reading} + 0.1 \times \text{V/div} + 1.0 \text{ mV})$ |
| Position range | ± 8 divisions away from the center of the screen |
| Attenuation factor | X1, X10, X100, X1000 |

Specifications

| | |
|-----------------------------------|-----------------------------------------------------------------|
| Channel common mode rejection | 100:1 at 60 Hz 20:1 at 10 MHz ^[1] |
| Lower frequency limit, AC coupled | ≤ 5 Hz at BNC ≤ 1 Hz when using a 10X passive probe |
| Channel to channel crosstalk | ≥ 100:1 at 1 MHz ≥ 100:1 at 10 MHz ^[1] |
| Input Impedance | 1 MΩ 18 pF |
| Maximun input | 400 V _{pk} @ 1 MΩ |
| Differential delay | ±150 ps when vertical scale and coupling settings are identical |

^[1] Bandwidth reduced to 6 MHz with a 1X probe.

Horizontal system

| | |
|---------------------------------|------------------------------------------------------------------------------------|
| Time base range (1-2-5 step) | 2 ns/div to 50 s/div |
| Modes | Main, Delayed, Roll and X-Y |
| Time base accuracy | ± 0.01 % |
| Input of X-Y mode | Channel 1 is the horizontal X-axis input Channel 2 is the vertical Y-axis input |
| Bandwidth of X-Y mode | 60 MHz: 2540B 100 MHz: 2542B |
| Phase error of X-Y mode | ± 3° |

Specifications

Measurements

| | |
|---------------------|---------------------------------------------------------------------------------------------------|
| Voltage measurement | Max, Min, VPP, High, Low, Amplitude, Average, RMS, Overshoot, Preshoot, Cycle average, Cycle RMS |
| Time measurement | Frequency, Period, Rise time, Fall time, +Width, -Width, +Duty, -Duty, Delay, Phase, X@MAX, X@MIN |
| Math | A+B, A-B, AxB, FFT (1024 points) |
| Cursors | Manual, Auto, and Track |
| Counter | Built-in 5-digit frequency counter. Count up to the oscilloscope's maximum bandwidth. |

Specifications

Trigger system

| | |
|--------------------------|----------------------------------------------------------------------------------------|
| Source | CH1, CH2, EXT, EXT/5, AC Line, Alternating. |
| Modes | Auto, Normal, Single |
| Coupling | DC, AC, LF-Reject, HF-Reject |
| Type | Edge, Pulse, Video |
| Trigger level range | Internal: ± 8 divisions from screen center EXT: ± 1.6 V EXT/5: ± 8 V |
| Trigger sensitivity | 0.1 div to 1.0 div user adjustable |
| EXT input impedance | 1 M Ω 18 pF |
| EXT maximum input | 400 V _{pk} @ 1 M Ω |
| Video Standard | Supports NTSC, PAL, and SECAM broadcast systems for any field or any line |
| Holdoff Range | 100 ns to 1.5 s |
| Trigger Level Accuracy | Internal: ± 0.3 div x Volts/div |
| SET LEVEL TO 50% | Operates with input signal \geq 50 Hz. |
| Pulse Width Trigger mode | Trigger when Less than, Greater than, Equal, Positive pulse , Negative pulse |
| Pulse Width Range | 20 ns to 10 s |

Specifications

Storage and I/O

| | |
|------------------------------|------------------------------------------------------------------------------------------------|
| Internal memory | 10 setups and trace files can be saved and recalled internally. |
| External storage file format | Setup file(*.STP), Waveform file(*.WFM), Trace file(*.TRC), BMP file(*.BMP), **CSV file(*.CSV) |
| Standard ports | USB host USB device RS232C PASS/FAIL OUT LAN |

**Maximum data points that can be stored into a .CSV file on an external USB storage device is 1200 points.

Specifications

Acquisition system

| | |
|--------------------------------------------|-----------------------------------------------------------------------------------------------------------------------------------------------------------------------------------------------------------------------------------------------------|
| Max real time sample rate | 2540B, 2542B: 1 GSa/s |
| Max equivalent sample rate | 2540B, 2542B: 50 GSa/s |
| Max Memory Depth (Based on Sample rate) | 1 GSa/s: 16 kpts 500 MSa/s: 8 kpts (dual channel) 500 MSa/s: *2.4 Mpts (single channel) \leq 250 MSa/s: *1.2 Mpts (single and dual channel operation) |
| Vertical resolution | 8 bits |
| Sample mode | Normal, Average, Peak Detect |
| Autoset | Finds and displays all active channels, sets edge trigger mode on channel 1, set vertical sensitivity on scope channels and time base to display one or five periods. Requires minimum voltage >10 mVpp, 0.5% duty and minimum frequency >50 Hz. |

*Maximum total number of points can only be extracted via remote control using the USB, RS232C, or LAN interface.

Specifications

Display system

| | |
|---------------|-------------------------------------------------------------------------------------------------------------------------------------------------------------------------------------------------|
| Display | 5.6-inch TFT LCD display. |
| Resolution | 234 vertical by 320 horizontal pixels |
| Colour | 24 bit true color |
| Brightness | Adjustable |
| Language | Simplified Chinese, Traditional Chinese, English, Korean, Japanese, Russian, French, Spanish, Persian, Portuguese |
| Display area | Menu ON: 8 vertical by 10 horizontal divisions or 200 vertical by 250 horizontal pixels Menu OFF: 8 vertical by 12 horizontal divisions or 200 vertical by 300 horizontal pixels |
| Display mode | Vector, Dots |
| Interpolation | Sinx/x, Linear |
| Persistence | OFF, Infinite persistence |

Specifications

8.2 General Specifications

Power and environmental requirements

| | |
|---------------------------|----------------------------------------------------------------------------------------------------------------|
| Line voltage Range | 99 V to 242 VAC |
| Line frequency | 47 Hz to 440 Hz |
| Power consumption | Less than 50 VA |
| Operating temperature | 0°C to 40°C |
| Non-operating temperature | -20°C to 55°C |
| Humidity | Maximum relative humidity 80% for temperatures up to 31°C decreasing linearly to 50% relative humidity at 40°C |
| Operating altitude | ≤ 3000 m |
| Non-operating altitude | ≤ 15000 m |

Physical size and Weight

| | |
|-------------------|----------------------|
| Instrument height | 156.5 mm |
| Instrument width | 320 mm |
| Instrument depth | 123 mm |
| Net weight | Approximately 2.8 kg |

Calibration interval

| | |
|----------------------------------|----------|
| Recommended calibration interval | One year |
|----------------------------------|----------|

8.3 Certification

CE Compliant

CE Declaration of Conformity

The oscilloscope meets the requirements of 2006/95/EC Low Voltage Directive and 2004/108/EC Electromagnet Compatibility Directive and

Low Voltage Directive

- EN 61010-1:2001

EMC Directive

- EN 61326-1: 2006
- EN 61000-3-2: 2006
- EN 61000-3-3: 1995+A1: 2001+A2: 2005
Electrical equipment for measurement,
control, and laboratory use.

Appendix A: Performance Verification Procedure

- DC Gain Accuracy
- Bandwidth
- Trigger Sensitivity
- Time Scale Accuracy

Performance Verification Procedure

The only parameter that can be user calibrated is the DC gain accuracy. If any of the other parameters, bandwidth, trigger sensitivity, or time scale accuracy do not meet published specifications, the unit must be returned to B&K Precision for repair.

The oscilloscope under test must be warmed up for at least 30 minutes prior to the start of any performance test.

DC Gain Accuracy

Equipment needed: Fluke calibrator (preferred) or DC power supply, DMM, splitter, 2 BNC cables

1. Disconnect all cables from the oscilloscope channel inputs.
2. Press the **Acquire** front panel key.
3. In **Acquire** menu, press the **Mode** soft key until **Averages** appears.
4. Turn the entry knob  until "256" appears.
5. In **Acquire** menu, press **Sampling** soft key and set to "Real Time".
6. Set CH1 probe attenuation to 1X in CH1 menu.
7. Press **Measure** button and select **Voltage**, then go to page 2/4 and select **Average**.

Performance Verification Procedure

8. Connect calibrator to oscilloscope. If preferred calibrator is not available, connect alternative equipment as follows:

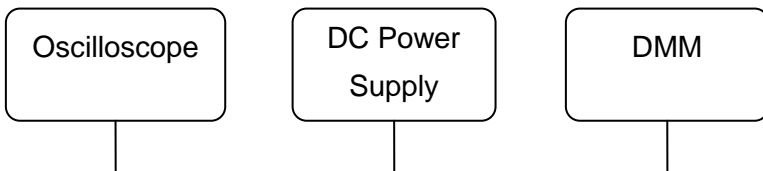

9. Apply a reference signal. The output level of the DC positive/negative of calibrator output should be equal to 3 times the volts/div setting of oscilloscope. For example, to test 10 mV/div in CH1, the output of the calibrator should be set to +30 mV/-30 mV.
10. Compare the reading of the Vavg value at the bottom of the screen (real time reading of the input signal) to the amplitude of your reference signal.
11. The DC gain should always be $\leq 4\%$ for 2 to 5 mV/div and $\leq 3\%$ for 10 mV to 5 V/div.

$$DC\ Gain = \frac{\Delta V_{out}}{\Delta V_{in}} = \frac{V_{oscilloscope+} - V_{oscilloscope-}}{V_{DMM+} - V_{DMM-}}$$

In above example, the difference between positive and negative input value is 60 mV.

12. Select the next volts/div setting.
13. Repeat the above steps for channel 2.

Performance Verification Procedure

Bandwidth

Equipment needed: Fluke calibrator (preferred) or signal generator

1. Connect your calibrator's output to CH1 of the oscilloscope by 50ohm feed thru connector.

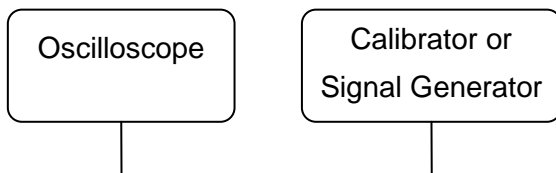

2. Set CH1 input attenuation to 5 mV/div, DC coupling, and horizontal scan to 500 ns/div.
3. Turn on output of the calibrator for a 1 MHz sine wave.
4. Change the output level of calibrator until waveform height is 6 divisions and reading is 30 mVp-p.
5. Record these values as a reference value.
6. Slowly increase frequency output of calibrator up to rated bandwidth of the oscilloscope.
7. Observe waveform and reading on screen. The size of the waveform should always be ≥ 4.2 divisions, and reading should always be ≥ 21.2 mV.
8. Repeat the above steps for CH2.

Performance Verification Procedure

Trigger Sensitivity

Equipment needed: Fluke calibrator (preferred) or signal generator

1. Connect your calibrator's output to CH1 of the oscilloscope by 50ohm feed thru connector.

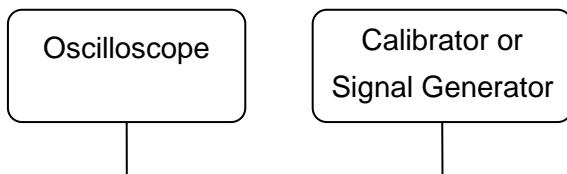

2. Set input attenuation of CH1 to 10 mV/div.
3. Turn on output of the calibrator for a 10 MHz sine wave.
4. Change output level until waveform reaches 1 division on the screen. The waveform should be stable and clear.
5. Set calibrator to rated bandwidth frequency of the oscilloscope.
6. Change output level of calibrator to the specified vertical division, 1.5 div from 10 MHz to full bandwidth. The waveform should be stable and clear.
7. Repeat the above steps for CH2.

Performance Verification Procedure

Time Scale Accuracy

Equipment needed: Fluke calibrator (preferred) or signal generator

1. Connect your calibrator's output to CH1 of the oscilloscope by 50ohm feed thru connector. If recommended calibrator is not available, connect alternative equipment as follows:

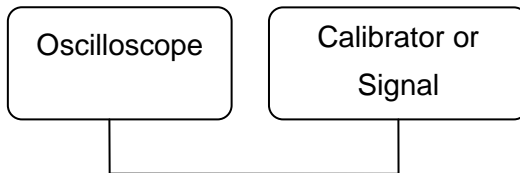

2. On the oscilloscope, the time base is switched to the sweep speed under test.
3. Set up a 10 MHz sine wave output from calibrator.
4. Press the **Auto** button on oscilloscope to get a stable waveform.
5. Press the **Measure** button, soft key **Time**, and then soft key **Frequency**.
6. Press the **Acquire** button and soft key **Mode** to set **Average** mode.
7. Adjust average to 8. It should read 10 MHz.
8. Switch sweep speed to 100 ms (or 200 ms) to have a stable frequency reading. This reading should be less than 1 kHz.

Appendix B: Disabling Auto Function

The oscilloscope has the ability to disable the Auto button that would automatically setup the scope to display a signal, circumventing the need to know how to set up scope parameters. This feature could be used by educators as a teaching tool for basic oscilloscope operation.

To receive information on how to disable this Auto button function, please contact B&K Precision at

http://www.bkprecision.com/contact_us .

Index

- AC coupling, 33
- Acquisition status, 20
- attenuation, 25
- Autoset, 29
- Band block filter, 40
- bandwidth limit, 36
- Cursors, 140
- DC coupling, 34
- Delayed, 59
- Edge Trigger**, 71
- even fields, 75
- FFT, 48
- filters, 40
- Force Trigger**, 66
- Frequency Counter, 94
- fuse, 15
- GND coupling, 35
- Holdoff, 69
- Invert, 43
- Key Lock, 96
- Key Test**, 99
- Main mode, 57
- Mask, 103
- odd fields, 75
- Overshoot**, 109
- Pass/Fail, 101
- Peak-Peak**, 107
- Persist**, 147
- Playback, 126
- Preshoot**, 109
- Pulse Width Trigger**, 73
- quick help, 28
- Record Waveform, 125
- REF**, 52
- Roll mode, 63
- Screen Test**, 99
- Self-calibration, 83
- Trace, 131
- trigger level, 66
- Trigger Modes**, 67
- vertical position knob, 31
- vertical scale, 32
- Video Trigger**, 75
- X-Y, 61

SERVICE INFORMATION

Warranty Service: Please go the support and service section on our website www.bkprecision.com to obtain a RMA #. Return the product in the original packaging with proof of purchase to the address below. Clearly state on the RMA the performance problem and return any leads, probes, connectors and accessories that you are using with the device.

Non-Warranty Service: Please go the support and service section on our website www.bkprecision.com to obtain a RMA #. Return the product in the original packaging to the address below. Clearly state on the RMA the performance problem and return any leads, probes, connectors and accessories that you are using with the device. Customers not on an open account must include payment in the form of a money order or credit card. For the most current repair charges please refer to the service and support section on our website.

Return all merchandise to B&K Precision Corp. with pre-paid shipping. The flat-rate repair charge for Non-Warranty Service does not include return shipping. Return shipping to locations in North America is included for Warranty Service. For overnight shipments and non-North American shipping fees please contact B&K Precision Corp.

B&K Precision Corp.
22820 Savi Ranch Parkway
Yorba Linda, CA 92887
www.bkprecision.com
714-921-9095

Include with the returned instrument your complete return shipping address, contact name, phone number and description of problem.

LIMITED THREE-YEAR WARRANTY

B&K Precision Corp. warrants to the original purchaser that its products and the component parts thereof, will be free from defects in workmanship and materials for a period of **three years** from date of purchase. B&K Precision Corp. will, without charge, repair or replace, at its option, defective product or component parts. Returned product must be accompanied by proof of the purchase date in the form of a sales receipt.

To obtain warranty coverage in the U.S.A., this product must be registered by completing a warranty registration form on our website www.bkprecision.com within fifteen (15) days of purchase.

Exclusions: This warranty does not apply in the event of misuse or abuse of the product or as a result of unauthorized alterations or repairs. The warranty is void if the serial number is altered, defaced or removed.

B&K Precision Corp. shall not be liable for any consequential damages, including without limitation damages resulting from loss of use. Some states do not allow limitations of incidental or consequential damages. So the above limitation or exclusion may not apply to you. This warranty gives you specific rights and you may have other rights, which vary from state-to-state.

B&K Precision Corp., 22820 Savi Ranch Parkway, Yorba Linda, CA 92887
www.bkprecision.com 714-921-9095

BK PRECISION[®]

22820 Savi Ranch Parkway

Yorba Linda, CA 92887

www.bkprecision.com

© 2011 B&K Precision Corp.

Printed in China

v020212